

**Certified Storm Water Operator
and
Soil Erosion and Sedimentation Control
Inspector/Comprehensive Training Manual**

**Department of Environmental Quality
State of Michigan**

Certified Storm Water Operator and Soil Erosion and Sedimentation Control Inspector/Comprehensive Training Manual

2010 Edition

**Written By:
Matt Johnstone
Jerrod Sanders
Sarah VanDelfzijl
Dick Mikula**

The authors wish to extend a special thank you to Ms. Nichole Churches and Ms. Deana Mercs for their countless hours devoted to preparing this manual.

The Michigan Department of Environmental (MDEQ) will not discriminate against any individual or group on the basis of race, sex, religion, age, national origin, color, marital status, disability, or political beliefs. Questions or concerns should be directed to the MDEQ Office of Personnel Services, PO Box 30473, Lansing, MI 48909.

TABLE OF CONTENTS

Unit One: Storm Water Runoff, Soil Erosion and Sedimentation: Processes and Impacts

Introduction.....	1-1
Hydrologic Cycle	1-1
Soil Erosion	1-2
Major Categories of Erosion	1-3
Geologic, Accelerated, Wind and Water	1-3
Overland Erosion (sheet, rill, and gully)	1-4
Physical Factors Affecting Erosion	1-6
Climate	1-6
Vegetative Cover	1-6
Soils.....	1-7
Slope	1-8
The Sedimentation Process	1-8
Impacts of Runoff, Erosion, and Sedimentation	1-9
Principles and Strategies.....	1-13
Summary	1-14
Unit One Review.....	1-15
Answers to Unit One Review.....	1-17

Unit Two: Controlling Runoff, Erosion, and Sedimentation on Construction Sites

Introduction.....	2-1
Best Management Practices for Construction Sites.....	2-1
Scheduling	2-2
Vegetation.....	2-3
Surface Roughening	2-4
Diversions and Channels.....	2-5
Grade Stabilization Structures	2-7
Check Dams	2-8
Channel and Slope Stabilization	2-11
Windbreaks.....	2-13
Watering	2-14
Silt Fence.....	2-15
Dewatering.....	2-16
Access (and Exit) Roads	2-16
Sedimentation Basins	2-18

Storm Water Basins	2-21
Catch Basins.....	2-22
Oil and Grit Separators	2-22
Storm Drain Inlet Protection.....	2-22
Equipment Maintenance and Storage Area	2-24
Pesticides and Fertilizers.....	2-25
Subsurface Drains	2-25
Summary	2-26
Unit Two Review.....	2-27
Answers to Unit Two Review	2-29

Unit Three: Vegetative Stabilization

Introduction.....	3-1
Native and Introduces (Non-Native) Species.....	3-1
Site Assessment.....	3-2
Climate	3-2
Soil Conditions.....	3-2
Slope	3-5
Site Use and Maintenance.....	3-5
Critical, Non-Critical, and Sensitive Areas	3-6
Site Preparation.....	3-7
Slope Preparation	3-7
Topsoil	3-7
Seedbed Preparation.....	3-8
Establishing Vegetation	3-9
Seeding	3-9
Sod	3-12
Sprigging	3-13
Trees and Shrubs	3-13
Live Stakes and Fascines.....	3-14
Mulching	3-14
Monitoring Established Vegetation	3-17
Vegetation Specification Tables	3-19
Unit Three Review	3-28
Answers to Unit Three Review	3-30

Unit Four: Plan Development, Information Sources, Plan Review, and Inspections

Introduction..... 4-1

SESC Plan Requirements 4-2

Information Sources 4-2

 U.S. Geological Survey Topographic Maps 4-2

 Topographic Surveys 4-6

 County Soil surveys 4-9

 Aerial Photography 4-10

Field Evaluations 4-11

 On-Site Field Visits 4-11

 Techniques and Tools for Field Review 4-11

 Other Field Observation Techniques 4-12

 Identification of Sensitive, Critical Erosion, and Other Areas 4-12

Developing the SESC Plan..... 4-13

Plan Review 4-16

Inspections 4-17

Other Considerations..... 4-18

Summary 4-19

Unit Four Review 4-21

Answers to Unit Four Review 4-23

Construction and SESC Measure Installation Schedule (small) ...Appendix 4A-1

Construction and SESC Measure Installation Schedule (large)....Appendix 4B-1

Unit Five: Laws, Rules, and Inspections Pertinent to CSWO/SESC Inspectors

Federal Laws 5-1

State Laws..... 5-1

 Part 91 5-1

 Part 91 Agencies 5-2

 Part 91 Inspections, Inspection Frequency, and Documentation..... 5-3

 Part 91 Inspector Responsibilities 5-4

 Part 31 5-5

 Permit-by-Rule Promulgated Under Part 31 5-5

 Permit-by-Rule Requirements 5-6

 Certified Storm Water Operator 5-8

 Permit-by-Rule Inspections, Inspection Frequency, and Documentation 5-8

 Permit-by Rule Reporting 5-9

 Site Stabilization and Site Termination 5-10

Unit Five Review	5-11
Answers to Unit Five Review	5-15
Site Inspection Report	Appendix 5A
Notice of Coverage	Appendix 5B
Notice of Coverage Renewal	Appendix 5C
Notice of Termination	Appendix 5D

Unit Six: Requirements For Administering and Enforcing Part 91 Programs

Summary of Law and Program Responsibilities	6-1
Enforcing Agencies (EAs).....	6-1
Key SESC Permitting and EA Facts	6-2
Permittee	6-2
Activities Requiring Permits	6-2
Permit Exemptions.....	6-2
Documents.....	6-3
Minimum SESC Plan Requirements	6-3
Other Earth Change Requirements	6-4
Inspections.....	6-4
Compliance and Enforcement Options	6-4
Other EA Requirements.....	6-4
MDNR Responsibilities	6-4
Authorized Public Agencies	6-5
Key APA Facts	6-6
Part 91 Statute	Appendix 6A-1
Unit Six Part 91 Statute Review	Appendix 6A-19
Answers to Unit Six Part 91 Statute Review	Appendix 6A-21
Administrative Rules for Part 91	Appendix 6B-1
Unit Six Administrative Rules for Part 91 Review	Appendix 6B-9
Answers to Unit Six Administrative Rules for Part 91 Review.....	Appendix 6B-11

Unit Seven: Soils, Erosion, and Runoff

Introduction.....	7-1
Soil Texture	7-1
Erodibility And Erosion	7-3
Sedimentation And Sediment Control.....	7-4
Runoff.....	7-4
Runoff Charactwerization	7-4
Runoff Volume and discharge Rate.....	7-6
Soil Hydrologic Group.....	7-6
Surface Characteristics	7-6

Rainfall Duration and Frequency	7-9
Estimating Runoff Volume and Peak Discharge.....	7-11
Runoff Problem #1: Undeveloped Site.....	7-15
Runoff Problem #2: Site under Construction.....	7-16
Runoff Problem #3: Developed Site.....	7-18
Application of Runoff Calculations	7-19
Summary	7-20
Appendix 7A	7A-1
Appendix 7B: Hydrologic Soil Groups for Michigan Soils	Appendix 7B-1
Appendix 7C: Practice Problems	Appendix 7C-1
Practice Problems A, B, and C.....	Appendix 7C-1
Answers to Practice Problems A, B and C.....	Appendix 7C-4

Unit Eight: SESC Plan Review/Document Exercises

Introduction.....	8-1
Plan Review Exercise.....	8-1
Plan Development Exercises.....	8-3
Answers to Practice Problem A	8-7
Answers to Practice Problem B	8-8
Appendix 8A: Soil Erodibility “K _w ” Values for Michigan Soils	Appendix 8A-1

Appendix 1: SESC Best Management Practices Guidance Sheets

Introduction.....	Appendix 1-1
Silt Fence	Appendix 1-3
Turbidity Curtain	Appendix 1-7
Storm Sewer Inlet Protection.....	Appendix 1-12
Access Road	Appendix 1-18
Check Dam.....	Appendix 1-24
Riprap-Stabilized Outlet.....	Appendix 1-30
Rolled Erosion Control Products	Appendix 1-41
Diversions.....	Appendix 1-49
Sediment Basin	Appendix 1-54
Mulching	Appendix 1-65
Hydroseeding	Appendix 1-69
Dust Control	Appendix 1-73
Polyacrylamide (PAM)	Appendix 1-78

Manual Purpose, Training Requirements, and Definitions

Purpose

The information in this training manual provides the information necessary for individuals to complete the training requirements set forth in Part 31, Water Resources Protection and Part 91, Soil Erosion and Sedimentation Control (SESC), of the Natural Resources and Environmental Protection Act, 1994 PA 451 as amended, to become a Certified Storm Water Operator (CSWO), an SESC Inspector, or responsible for administering and enforcing a County or Municipal Enforcing Agency or Authorized Public Agency.

Training Requirements

Certified Storm Water Operator (CSWO) Training:

Individuals who are required to conduct weekly site inspections (and inspections within 24 hours of a rain or snowmelt event) as a certified storm water operator pursuant to Part 31 (Permit-by-Rule) must study **Units 1-5** and pass the CSWO/SESC Inspector exam. **Note:** Unit 5 references information in Unit 6; however, it is not necessary to review Unit 6 to pass the CSWO exam.

Comprehensive Soil Erosion and Sedimentation Control (SESC) Training:

Individuals who are responsible for administering and enforcing Part 91 must study the entire manual including Appendix 1 (SESC Best Management Practices (BMPs) Guidance Sheets) and pass the SESC exam. **Note:** For exam purposes, you will not be expected to complete the engineering calculations associated with the BMPs in Appendix 1, but you must know the general information regarding where and how to install the BMPs. As an example, you will not be expected to calculate the riprap size or apron size of a Riprap-Stabilized Outlet; however, you will be expected to know things such as the stabilized outlets are used to control erosion in concentrated flow areas by reducing velocity and that the outlet apron shall be straight with no bends, that a filter blanket needs to be placed between the riprap and underlying soil, etc.

Exception for SESC Inspectors: Individuals who only have site inspection responsibilities for Part 91 may conduct those inspections by studying **Units 1-5 of this manual** and passing the CSWO/SESC Inspector exam. **Note:** Unit 5 references information in Unit 6. Although it would be beneficial, and encouraged, to review Unit 6 to gain further knowledge on Part 91, it is not necessary to review Unit 6 to pass the CSWO/SESC inspector exam.

When determining whether you or a member of your staff should complete the Comprehensive SESC training or the new CSWO/SESC Inspector training, please be aware that the duties of an SESC inspector are very limited. An SESC inspector is limited to ensuring that SESC measures are implemented and maintained per the SESC plan, specifications, and SESC procedures (if applicable), and that the prescribed measures are effective in minimizing soil erosion and preventing off-site sedimentation. The SESC inspector may order the contractor or owner to install or maintain any control measures that were identified on the approved SESC plan and/or procedures. However, if the prescribed SESC measures are not effective, the SESC inspector cannot order or suggest alternative measures that are not indicated on the plan; he/she must seek assistance from the person responsible for developing

or approving the plan or someone that has completed the Comprehensive SESC training. You should discuss with your supervisor if you should take the SESC Inspector or the Comprehensive SESC exam.

Definitions

Following are definitions and acronyms of some basic or important terms used throughout the training manual. Additional definitions or acronyms are defined in the various Units.

BMP: Best Management Practices, a term applied to structural, vegetative, or managerial practices used to protect or improve surface waters, ground waters, or adjacent property.

DEQ: Michigan Department of Environmental Quality

Earth Change: A human-made change in the natural cover or topography of land, such as grading, cut and fill activities, the placement of soil storage piles, or any other activity that may result in or contribute to soil erosion or off-site sedimentation.

Runoff: Water that does not infiltrate into the ground, but flows over the surface of land that is usually dry. Runoff is produced directly by rainfall or snowmelt events, or indirectly by discharges of captured rainfall from control structures.

Sediment: Solid mineral or organic particulate matter that has been removed from its site of origin by the action of water, wind, or gravity. When sediment comes to rest away from its site of origin, the result is sedimentation.

Sedimentation: The process whereby the detached particles generated by erosion are deposited elsewhere on the land or in our lakes, streams, and wetlands (Figure 1-14). Together, runoff, erosion, and sedimentation result in soil being detached, carried away, and eventually deposited elsewhere (Figure 1-15).

SESC (Soil Erosion and Sediment Control): Any particular practice or BMP used to control, minimize, or eliminate soil erosion or sedimentation, or a general term applied to all aspects of controlling erosion and sediment.

Soil Erosion: The process by which the land surface is worn away by the action of wind, water, ice, or gravity. In simple terms, it is the process where soil particles are dislodged or detached and put in motion.

Stabilization: The establishment of vegetation or the proper placement, grading, or covering of soil to ensure its resistance to soil erosion, sliding, or other earth movement

Waters of the State: Part 31 and Part 91 have different definitions for “waters of the state”. Part 31 includes “...ground waters, lakes, rivers, and streams and all other watercourses and waters within the jurisdiction of the state and also the Great Lakes bordering the state”. Part 91 includes “... the Great Lakes and their connecting waters, inland lakes and streams, and [regulated] wetlands ...”

Unit One

STORM WATER RUNOFF, SOIL EROSION, AND SEDIMENTATION: PROCESSES AND IMPACTS

Introduction

The effective implementation, maintenance, and monitoring of storm water runoff, soil erosion, and sedimentation control measures requires a working understanding of the basic relationships among rainfall, runoff, soils, and topography. Unless planned for and controlled, runoff will generally increase – also increasing the potential for erosion and sedimentation - during construction and after an area is developed.

Just as understanding the physical influences on runoff, erosion, and sedimentation improves the ability to effectively manage construction sites and other earth change activities, appreciating the environmental, economic, and quality of life impacts of those processes is necessary to develop the commitment to implement sound management practices.

Runoff, erosion, and sedimentation are separate, but inter-related processes. Each, if uncontrolled, cause different types of environmental or structural damage and each requires different control measures to minimize their impacts.

The Hydrologic Cycle

Water is continuously exchanged between the earth and atmosphere as depicted in the Hydrologic Cycle below (Figure 1-1). During and after a precipitation event, a portion of the water evaporates and returns directly to the atmosphere, a portion flows over the earth's surface as runoff, and a portion infiltrates into the soil. Once in the soil, the water may be taken up by plant roots and returned to the atmosphere by transpiration, become part of our drinking water supply, or seep into streams, lakes, or oceans. The amount of water cycling through a particular location is beyond our control, but human activity can significantly influence the fate and impact of that water.

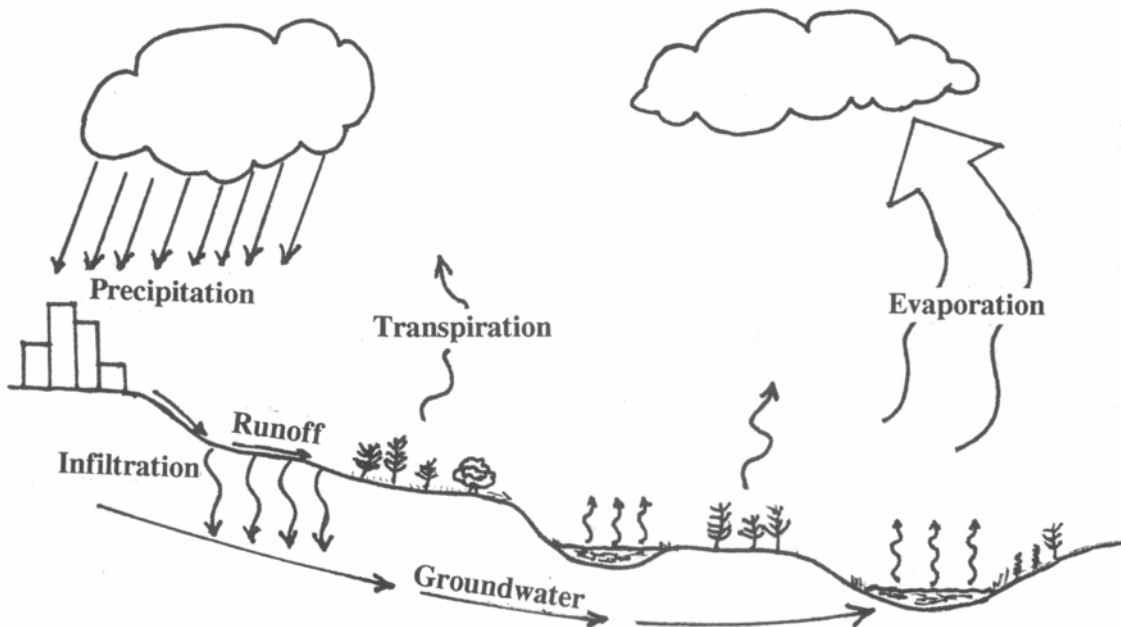

Figure 1.1 Hydrologic Cycle

At an undisturbed or well-vegetated site, the majority of rainfall either evaporates or infiltrates into the ground. Activities such as construction, agriculture, logging, or mining that remove vegetation or disturb the land surface often reduce infiltration and increase runoff. This excess runoff can create erosion and carry sediments or other pollutants into lakes, streams, wetlands, or on to adjacent properties. In addition, constructing buildings, pouring concrete, applying pavement, and compacting the soil increases the impervious area, further reducing infiltration and increasing storm water runoff rates and volumes.

Principle objectives of a properly managed construction site are to maximize infiltration, minimize runoff, and to ensure that storm water discharge during and after construction are equivalent in quantity and quality to predevelopment conditions. In other words, human disruption of the hydrologic cycle should be compensated for by implementing and maintaining effective storm water runoff, erosion, and sediment controls.

Soil Erosion

Farming, construction, logging, and mining upset the balance that has developed among rainfall, storm water runoff, and the environment. Although all the sources mentioned above increase the potential for erosion and sediment, the focus of this training is on construction.

Erosion is often increased during and after construction for two major reasons. The first is the removal of protective natural vegetation. The second is the placement of

impermeable surfaces like paving and rooftops on or over the soil, preventing water infiltration and increasing storm water runoff. These two factors increase the likelihood that soil will be exposed to the erosive forces of water and wind.

Major Categories of Erosion

Soil erosion can be categorized in several ways; understanding the different categories of erosion is essential to implementing effective SESC.

Geologic erosion or natural erosion is the action of the wind, water, ice, and gravity in wearing away rock to form soil and to move existing soil downslope. Except for some stream and shore erosion, it is a relatively slow, continuous process that often goes unnoticed. Geologic erosion is reported to account for about 30 percent of all sediment in the United States each year.

Accelerated erosion is a speeding up of erosion due to human activity. Whenever we increase runoff, destroy the natural vegetation, or alter the contour of the ground without providing some sort of surface protection, we greatly increase the rate of erosion. This type of erosion is reported to account for about 70 percent of all sediment generated in this country each year. Accelerated erosion can be minimized through careful planning and by implementing appropriate control measures.

Wind erosion is common on agricultural lands and large construction sites. Soil that is stock piled and left unprotected is especially vulnerable to wind erosion. In some areas, more soil is lost from wind erosion than from water erosion. The Natural Resources Conservation Service (NRCS) estimated that wind erosion is responsible for 42 percent of the erosion damage occurring in Michigan annually. The amount of soil lost from wind erosion may not be obvious because the soil particles disperse over a large area where they are not visible. In urbanized areas, the most damaging aspect of wind erosion is dust. It can create traffic hazards, increase cleaning costs, abrade plant tissue, blight the appearance of structures and other surfaces, or create a health hazard. The problem of windborne dust is often made worse by vehicles driving through construction sites. This can be minimized by applying soil tackifiers and making sure that scraper or articulated truck haul roads are kept wet or have Calcium Chloride or other dust suppressants applied on a regular basis. This is imperative for sites with predominantly clay soils.

The effects of **water erosion** are usually more visible than wind erosion. One can readily see gullies, turbid or muddy water, and sediment build-up. Storm water runoff can cause stream channel erosion, **overland erosion**, or both. Channel erosion occurs both in intermittent and permanent waterways and streams. Three causes of channel erosion are increased storm water runoff, removal of natural vegetation along the waterway, and channel alterations resulting from construction activities. Channel erosion includes both stream bank and stream bed erosion.

Overland erosion occurs on bare slopes as a result of rain splash and storm water runoff. The predominate type of erosion and source of sediment from construction sites is overland erosion. Overland erosion is generally separated into three categories: **sheet erosion, rill erosion, and gully erosion.**

Sheet erosion is the removal of a uniform layer of soil from the land surface as a result of rain splash and storm water runoff. Erosion from rain splash occurs as a result of the impact of raindrops on an unprotected surface. The splash dislodges soil particles, making them more susceptible to movement by overland water flow. The loosened particles that are not washed away can form a muddy slick that clogs pores in the ground surface. The sealed surface further reduces infiltration and increases storm water runoff. The magnitude of soil loss resulting from rain splash can best be seen on a gravelly or stony soil (Figure 1-2).



Figure 1-2

As storm water runoff water moves down a slope, it increases in velocity and increases the potential for erosion. The volume of sediment also increases because the transported particles scour and dislodge more soil particles.

Rill erosion is another form of overland erosion. Evidence of rill erosion is the development of small grooves spaced fairly uniformly along the slope. It is caused when storm water runoff is heavy and water concentrates in rivulets (Figure 1-3). Individual rills range in depth and width up to several inches and reflect a tremendous loss of soil.



Figure 1-3

Gully erosion will develop if rilling is not corrected immediately. The depth of erosion defines the difference between rills and gullies. Although there are no formal definitions for rills and gullies, it is commonly accepted that rills can be easily obliterated by normal grading practices, whereas gullies cannot (Figure 1-4).



Figure 1-4

Gullies may form by means other than unchecked rill erosion. Gullies can form wherever the topography or paved surfaces concentrate water into an area that cannot handle the flow. Proper planning and construction practices prevent this from happening.

Gullying and rilling are more obvious than sheet erosion, but the less obvious sheet erosion often results in a greater loss of soil than either gullying or rilling. In an uncontrolled situation, sheet, rill, and gully erosion may all occur on a single site, resulting in massive soil losses and creating a situation that is very difficult to bring back under control.

Physical Factors Affecting Soil Erosion

Following is an overview of the principal physical factors affecting soil erosion:

Climate

Rainfall amount, intensity, and frequency strongly influence runoff and erosion. Rainfall amount is usually measured in inches. Rainfall intensity is the rate at which the rain falls and is measured in inches of water falling in an hour of time. The infiltration rate is the rate that water is absorbed into the soil and is also measured in inches per hour. When rainfall exceeds the infiltration rate, storm water runoff occurs. The frequency of rainfall is the number of separate rainfall events occurring during a specific period of time, such as a week or month. During periods of frequent rainfall a greater percentage of the rainfall will become storm water runoff because of high soil moisture or saturated soil conditions.

Temperature is another climatic factor influencing erosion. While frozen soil is highly resistant to erosion, rapid thawing of the soil surface brought on by warm rains can lead to serious erosion. Temperature also influences the type of precipitation. Falling snow does not cause erosion, but heavy snowmelts in the spring can cause considerable storm water runoff and erosion. In Northern areas where spring melt occurs attention should be focused in the preceding fall to ensure all controls are in place and ready to handle the particular problems associated with spring runoff. Soils thaw from the top down and if frost is in the ground this results in increased runoff quantities from saturated surface soils because infiltration cannot occur

Vegetative Cover

Vegetation is probably the most important physical factor influencing soil erosion. A good cover of vegetation shields the soil from the impact of raindrops. Roots and rhizomes bind the soil particles together creating soil structure, making the soil more resistant to storm water runoff. Soils with good structure also create pathways for infiltration between aggregated soil particles and along roots. A vegetative cover provides organic matter, slows storm water runoff, and filters sediment. Organic matter protects the soil by shielding it from the impact of falling rain and by soaking up rainfall that would otherwise become storm water runoff. Organic matter also provides essential nutrients for plant growth. More complete coverage of vegetation is found in Unit 3.

The condition of the vegetative cover determines if erosion will be stopped or only slightly decreased. A dense, robust cover of vegetation is one of the best protections against soil erosion.

Soils

The physical characteristics of soil have a bearing on erodibility, deposition rates (sedimentation), and vegetative cover. Soil properties influencing erodibility include **texture**, **structure**, **cohesion**, and **natural drainage class**.

Texture refers to the size or combination of sizes of the individual soil particles. Three broad soil size classifications, ranging from small to large, are clay, silt, and sand (Figure 1-5). Soils having a large amount of silt-sized particles are most susceptible to erosion from both wind and water. Soils with clay or sand-sized particles are less prone to erosion. Clays can become highly erodible if allowed to dry out.

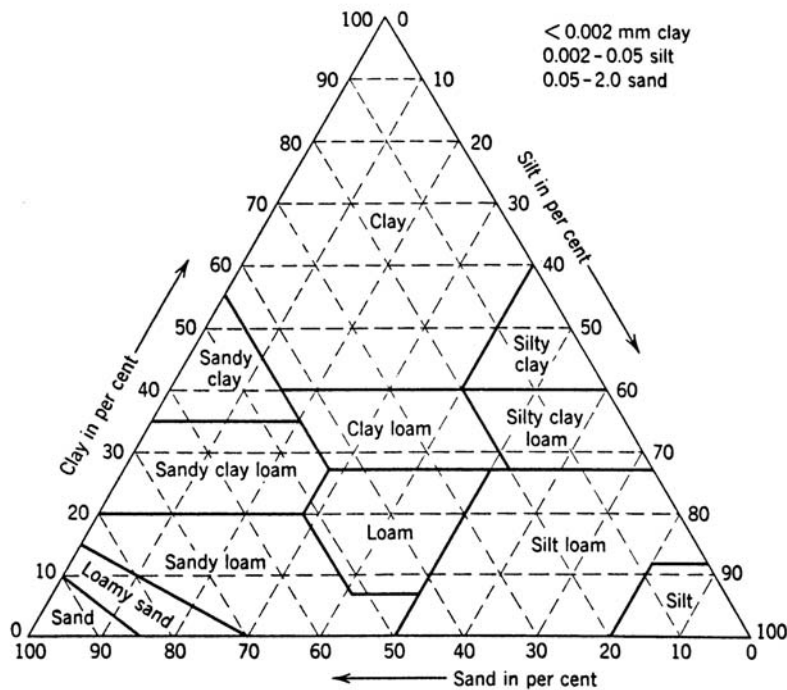

Figure 1-5 Textural Triangle

Structure refers to the degree to which individual soil particles adhere to each other, forming larger clumps and pore spaces. Structure influences the ability of the soil to absorb and infiltrate water and the physical resistance of the soil to erosion. Organic matter influences the structure of most soils. In clay soils, it loosens the structure and allows more water to infiltrate. In silty soils or granular sands, organic matter tends to bind the soil into clumps that are more resistant to erosion. Soils with organic matter absorb and store more water than soils without organic matter.

Cohesion refers to the binding force between soil particles. When moist, the individual soil particles in a cohesive soil cling together to form a doughy consistency. Clay soils are very cohesive, silts less so, and sands display little or no cohesiveness. The cohesiveness of some clay soils makes them highly resistant to erosion if their moisture content is maintained, but the same qualities that resist erosion also greatly reduce infiltration and increase runoff.

The **natural drainage class** of a soil is influenced by soil texture but is primarily a result of the depth to the water table. Soils with a high water table have less storage capacity for rainfall and may experience more runoff and erosion after becoming saturated. Natural drainage class is covered more completely in second phase of the SESC training.

Slope

The last physical factor we will discuss is slope. Slope steepness, length, and roughness affect erodibility. Generally, long, steep, smooth slopes have the greatest potential for erosion. The erosion potential is greatest at the base of the slope, where storm water runoff velocity is the greatest and storm water runoff concentrates. To avoid this problem, long slopes are often "*broken up*" by diversions, terracing, or surface roughening so they function as a series of short slopes rather than one long slope. These structures and techniques function to intercept storm water runoff and thereby reduce the flow and velocity of water over the lower portion of the slope.

Steepness of slope is expressed in several ways. The most common are as a ratio of the difference in the vertical and horizontal distance or as a percentage. For example, a slope with a 100-foot horizontal change for every 10 feet of vertical distance would be called a 10 to 1 or a 10 percent slope.

Although we have little control over soil features and other natural factors, we do have control over how we develop a site and what measures we use to prevent or minimize erosion. After every effort has been made to prevent erosion, efforts should then be directed to controlling sediment.

The Sedimentation Process

As previously explained, sedimentation is the process whereby soil particles eroded by wind or water settle out or are deposited. Deposition of sediment occurs when the wind or water slows enough to allow the different sized particles to settle out.

As is the case with erosion, the sedimentation process is strongly influenced by certain physical factors. The interaction of these factors determines how sediment is transported and deposited.

The velocity and turbulence of storm water runoff are key factors in determining the fate of sediment. The greater the velocity and turbulence of flow, the greater is the amount

of sediment transported in suspension in the water or carried along the stream bottom as bedload. The lower the velocity and turbulence of flow, the greater the amount of sediment deposited.

The size, shape, and density of the transported particles also influence the rate at which they settle out. Clay particles are the smallest and have the greatest surface area to volume ratio; this makes them remain in suspension in very low water velocities or with very little turbulence. It is also very difficult or impossible to capture suspended clay particles by filtration or settling. Sand, the largest and heaviest soil particles, require more energy to keep in suspension and are the first to settle out and the easiest to capture by filtration. Silts are intermediate in size and weight between sand and clay. The finest silts can be nearly as difficult as clay to filter or take out of suspension.

It may be useful or necessary to estimate potential loss of soil. Estimates are necessary, for example, when determining maintenance schedules for removing sediment from sedimentation basins or for prioritizing sites for periodic inspections. The NRCS has equations for estimating soil loss from both wind and water erosion; the equation for water erosion is discussed in Unit 8.

Impacts of Runoff, Erosion, and Sedimentation

Over the past several decades, construction activities have increased, creating the potential for serious erosion and sedimentation problems and their associated impacts to the environment. Damage from uncontrolled storm water runoff, erosion, and sedimentation affects many aspects of the environment and, ultimately, nearly every citizen. Listed below are some specific impacts:

Loss of fertile topsoil (Figure 1-6)

Topsoil is an extremely valuable and underappreciated component of the environment. In our climate, it takes thousands of years for a few inches of topsoil to develop, but only a matter of hours or days for uncontrolled erosion to transport topsoil off-site. Topsoil contains organic matter, nutrients, and soil organisms that are beneficial for plant growth. Topsoil that is transported off-site and deposited elsewhere as sediment – often in a place where it is undesirable – is usually not recoverable. In addition, replacing topsoil is expensive, sometimes prohibitively so. It is imperative that existing topsoils be stripped and stockpiled on site for reuse in areas that need to be revegetated. Without a good topsoil base, revegetation is hard to establish and maintain.



Figure 1-6

Structural damage (Figure 1-7)

In addition to removing valuable topsoil, erosion can remove subsoil or fill material that is necessary to maintain the stability or strength of structures: paved roads can be undermined, building foundations can be exposed and weakened, and culverts and bridges can lose their stabilizing approaches and embankments.



Figure 1-7

Deposition

It is estimated that from all sources, over 4.5 billion tons of sediment pollute the rivers of this country each year. This is the equivalent to a volume the size of 25,000 football fields, 100 feet high (Figure 1-8), or nearly one cubic mile of sediment. It costs many dollars per cubic yard to remove sediment from waterways. It is estimated that **tens of billions of dollars per year are spent in the United States to correct the effects of erosion and sediment.**

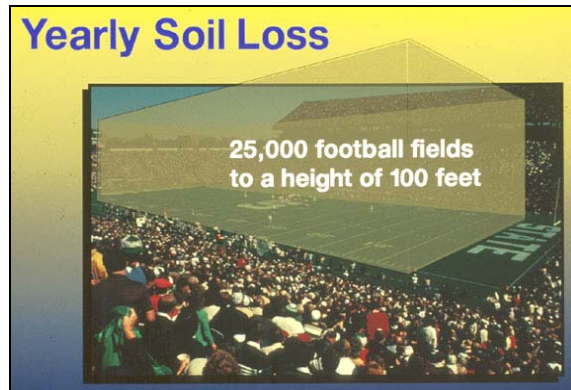

Figure 1-8

Source: John Warbach, Planning and Zoning Center, Inc.

Sediment deposition may result in any of the following:

- Reduction of fish spawning areas
- Less desirable fish communities
- Reduction of aquatic insect communities
- Impaired or destroyed wetland and terrestrial habitats
- Increased flooding due to reduced channel or storm drain capacity
- Increased costs to keep harbors and marinas navigable
- Reduced recreational opportunities

Sediment settles out in areas of relatively low slope or in the deepest or slowest moving areas of a waterbody. The deposition of sediment in a stream or lake can fill in the spawning or wintering habitat of fish. Sediment can also fill the voids created by rocks, gravel, and woody debris, which provide cover for young fish and habitat for aquatic insects on which many fish feed.

Sedimentation also affects the physical dimensions of a stream, or its morphology. The increased sediment load causes the stream to become wider and shallower, increasing streambank erosion, which further increases sediment loads. The surface area exposed to the air and sunlight also increases, temperature extremes in the stream. These temperature extremes may drive away more desirable fish species or otherwise disrupt the aquatic ecosystem, particularly in cold water trout streams.

Wetlands are extremely diverse and productive ecosystems. They provide natural flood control, filters for pollutants and naturally occurring sediments, and important habitat for wildlife, including many threatened and endangered species. Wetlands are not capable, however, of handling large concentrations or volumes of sediment produced by accelerated erosion. In order to maintain their valuable environmental functions, wetlands must be protected from sediment generated from construction site storm water runoff and erosion.

Turbidity

Turbidity is cloudiness caused by the suspension of fine soil particles in the water column (Figure 1-9). A brief episode of turbidity may be aesthetically displeasing but have little environmental impact, but persistent turbidity can significantly affect aquatic ecosystems. The suspended particles can adhere to gill structures of fish and aquatic insects inhibiting the transfer of oxygen; turbidity can impact microscopic plants and animals and interfere with photosynthesis in aquatic plants, having profound consequences for the entire aquatic ecosystem; turbidity can be detrimental to both sight feeding organisms and their prey.



Figure 1-9

Pollutant Loading

In addition to the direct impacts of transported sediment, runoff and eroded sediments can carry other pollutants, such as fertilizers, pesticides, or heavy metals into lakes, streams, or wetlands. The nutrients found in fertilizers, particularly nitrogen and phosphorous, can stimulate the growth of aquatic plants and algae, causing impediments to recreation, algae blooms, odor problems, or fish kills. Pesticides, heavy metals, oils and greases, or other hazardous materials may have significant short or long term impacts on the aquatic environment or public health.

The impacts of erosion and sedimentation are not limited to their direct effects on the environment. The economic cost of sediment removal has already been mentioned, but significant economic impacts result from the effect of erosion and sedimentation on recreation and quality of life. Boating and fishing are extremely important to the economy of Michigan and waterfront property values are strongly correlated to water quality.

Principles and Strategies

The goal of runoff, erosion, and sediment control is to protect land and water resources by eliminating or minimizing runoff, erosion, and off-site sedimentation, using the best practical combination of procedures, practices, and people. These principles and strategies include:

1. **Protect land and water resources.** Responsible people seek to be stewards of all our natural resources, including land and water. A balance must be met between resource protection and the other activities of the construction project.
2. **Minimizing erosion and off-site sedimentation.** During construction activities, everything practical should be done to prevent the erosion of soil from the site and its deposition off-site and into lakes, stream, and wetlands and on to adjacent properties.
3. **Using the best practical combination of procedures, practices, and people.** To control erosion and sediment we need workable laws, regulations, and procedures; up-to-date practices and techniques; and responsible people working together.

The effective control of runoff, erosion, and sedimentation requires the application of the following five principles of erosion and sediment control:

1. To the extent possible, plan the development to fit the topography, soils, and natural vegetation at a site. Attempts should be made in the design stage of a project to identify and preserve those areas that augment infiltration such as wetlands and woodlots. When structures and grading are designed to fit the site, less soil is exposed to erosive forces. The result can be reduced runoff rates, limited environmental damage, and savings in project costs.
2. Expose the smallest practical area of soil for the shortest possible time by scheduling and staging project activities. Stabilize soil surfaces exposed during the first phase of the project before beginning construction on the next phase. Daily seeding and mulching with permanent or temporary seeding mixtures is recommended.
3. Apply soil erosion prevention practices as a first line of defense against on-site damage. Use practices that minimize erosion on a site to prevent sediment from being produced and the need for costly controls to trap and control sediment.
4. Apply sediment control practices as a perimeter protection to prevent sediment from leaving the site. Use practices that control sediment once it is produced, and prevent it from getting off-site.

5. Implement a thorough inspection, maintenance, and follow-up program. Erosion and sedimentation cannot be effectively controlled without a thorough, periodic check of the site and continued maintenance of the control measures. An example of applying this principle would be a routine end-of-day check to be sure all control practices are working properly.

Summary

In summary, erosion and sedimentation includes the entire process whereby soil particles are detached from the ground surface, carried away, and eventually deposited. Erosion is the process by which the land surface is worn away by the action of wind, water, ice, or gravity. In simple terms, it is the process where soil particles are dislodged or detached and put in motion by the forces of wind and water.

An effective runoff, soil erosion, and sedimentation control plan addresses both erosion prevention and sediment control. Remember that it is much more effective to prevent erosion than to control or remove the sediment generated from erosion.

Specific methods of controlling runoff, erosion and sedimentation will be presented in Unit 2.

UNIT ONE REVIEW

1. Erosion is the process where soil particles are _____ or _____ and put in motion.
2. Sedimentation is the process whereby detached particles are _____ elsewhere.

3. Sediment is solid _____ or _____ particulate matter that has been removed from its site of origin by _____, _____, or _____ and deposited elsewhere.
4. Accelerated erosion is a speeding up of erosion due to _____ activity.
5. Major erosive forces are water and _____.
6. In some areas, more soil is lost from _____ erosion than from water erosion.
7. The effects of _____ erosion are usually more visible than _____ erosion.
8. The three categories of overland erosion are:

9. _____ erosion is the removal of a uniform layer of soil from rainsplash and storm water runoff.
10. The _____ of erosion defines the difference between rills and gullies.
11. The physical factors affecting erosion are:

12. Erosion and sedimentation may cause:
 Loss of _____
 _____ damage to roads, buildings or bridges.
 _____, resulting in reduction of fish _____, reduced
 _____ or _____ capacity, and _____ costs to maintain
 navigation,

 _____ loading
13. The climatic factors that strongly influence erosion and runoff are _____ amount, _____, and _____.
14. Soil properties influencing erodibility include:

15. Texture refers to the _____ or _____ of _____ of soil particles in a soil.

16. Structure refers to the degree to which individual soil particles _____ to each other.
17. Slope _____, _____, and _____ affect erodibility.
18. Sediment deposition occurs when soil-laden wind or water _____ enough to allow the soil particles to settle out.
19. The _____, _____, and _____ of the transported particles influence the rate at which they settle out.
20. Smaller, lighter particles such as _____ - _____ particles are easily transported and are _____ to settle out.
21. The five principles of erosion and sedimentation control are:
- _____ the development to fit the natural site conditions
 - Expose the _____ practical area for the _____ possible time
 - Apply _____ prevention practices as first line of defense
 - Apply _____ control practices to prevent off-site sedimentation
 - Implement a thorough _____, _____, and _____ program
22. The most effective way to prevent erosion is keep the soil covered with _____.
23. It is much more effective to prevent _____ than to control the _____ generated from erosion.

ANSWERS TO UNIT ONE REVIEW

1. Erosion is the process where soil particles are **dislodged** or **detached** and put in motion.
2. Sedimentation is the process whereby detached particles are **deposited** elsewhere.
3. Sediment is solid **mineral** or **organic** particulate matter that has been removed from its site of origin by **wind**, **water**, or **gravity** and deposited elsewhere.
4. Accelerated erosion is a speeding up of erosion due to **human** activity.
5. Major erosive forces are water and **wind**.
6. In some areas, more soil is lost from **wind** erosion than from water erosion.
7. The effects of **water** erosion are usually more visible than **wind** erosion.
8. The three categories of overland erosion are:
 - Sheet**
 - Rill**
 - Gully**
9. **Sheet** erosion is the removal of a uniform layer of soil from rainsplash and storm water runoff.
10. The **depth** of erosion defines the difference between rills and gullies.
11. The physical factors affecting erosion are:
 - Climate**
 - Vegetative cover**
 - Soils**
 - Slope**
12. Erosion and sedimentation may cause:
 - Loss of **fertile topsoil**
 - Structural** damage to roads, buildings or bridges.
 - Deposition**, resulting in reduction of fish **spawning areas**, reduced **channel** or **storm drain** capacity, and **increased** costs to maintain navigation
 - Turbidity**
 - Pollutant** loading
13. The climatic factors that strongly influence erosion and runoff are **rainfall** amount, **frequency**, and **intensity**.

14. Soil properties influencing erodibility include:
 - Texture**
 - Structure**
 - Cohesion**
 - Natural drainage class**
15. Texture refers to the **size** or **combination** of **sizes** of soil particles in a soil.
16. Structure refers to the degree to which individual soil particles **adhere** to each other.
17. Slope **length**, **steepness**, and **roughness** affect erodibility.
18. Sediment deposition occurs when soil-laden wind or water **slows** enough to allow the soil particles to settle out.
19. The **size**, **shape**, and **density** of the transported particles influence the rate at which they settle out.
20. Smaller, lighter particles such as **clay-sized** particles are easily transported and are **slow/difficult** to settle out.
21. The five principles of erosion and sedimentation control are:
 - a. **Plan** the development to fit the natural site conditions
 - b. Expose the **minimum** practical area for the **shortest** possible time
 - c. Apply **erosion control** prevention practices as first line of defense
 - d. Apply **sediment** control practices to prevent off-site sedimentation
 - e. Implement a thorough **inspection, maintenance,** and **follow-up** program
22. The most effective way to prevent erosion is keep the soil covered with **vegetation**.
23. It is much more effective to prevent **erosion** than to control the **sediment** generated from erosion.

Unit Two

CONTROLLING RUNOFF, EROSION, AND SEDIMENTATION ON CONSTRUCTION SITES

Introduction

This unit will present methods to control, minimize, or prevent runoff, soil erosion, and sedimentation on construction sites. The processes of runoff and soil erosion are so closely associated that methods to control either will usually result in the control of both runoff and soil erosion. Many runoff and erosion controls also control sedimentation, however, the opposite is almost never true: sediment controls rarely reduce runoff or erosion.

Wind can also be a major erosive force and it must be considered when developing and managing control measures. Silty, fine sandy, and organic soils tend to be the most susceptible to wind erosion. Soil may start moving, or eroding, when wind speed exceeds 13 miles per hour measured at one foot off the ground.

Best Management Practices for Construction Sites

To prevent soil erosion and subsequent sedimentation, BMPs need to be properly installed and maintained. BMPs are vegetative, structural, or managerial practices used to protect soil and water resources as well as adjacent properties. No single BMP can solve all the problems on a site, and not every site is going to use the same BMPs. The specific conditions of a site will dictate which BMPs are appropriate and used in an integrated system to protect water quality. It is recommended that a person who has been trained in SESC develop the SESC plan and select the appropriate BMPs for the site prior to beginning the project. Part 91 requires that the plan be reviewed and approved by someone with SESC training.

Detailed information for commonly used BMPs can be found in the Department of Management and Budget's *Soil Erosion and Sedimentation Control Guidebook*, Natural Resources Conservation Service's (NRCS) *Standards and Specifications*, the Michigan Department of Transportation's *Soil Erosion and Sedimentation Control Manual*, and the Michigan Department of Environmental Quality (MDEQ) *Guidebook of Best Management Practices for Michigan Watersheds*.

In the following descriptions, the appropriate use for each BMP is indicated with an abbreviation for runoff (**R**), erosion (**E**), or sedimentation (**S**) control, or for housekeeping or miscellaneous (**H**) controls. In the following paragraphs, BMPs that are used primarily for runoff and erosion control are considered first; sediment control and housekeeping BMPs follow. Each BMP described below also contains an "inspector's note", which indicates items that inspectors should monitor and document on inspection reports. At the very least, inspection reports should include descriptions of any failed BMPs or maintenance requirements, as well as

documentation that required repairs or maintenance have been adequately completed.

When developing a runoff and SESC strategy, remember that runoff and soil erosion control is more effective and cost efficient than sediment control. Sediment control, although often a necessary component of an effective SESC strategy, should always be considered as a second line of defense to support runoff and erosion controls. Fine sediment particles – silts and clays – are difficult or impossible to capture by standard sediment control techniques. It is particularly important to emphasize runoff and erosion control on sites that contain fine textured soils.

Scheduling (R, E, S, H)

Before any construction begins or any earth change is undertaken, all aspects of the project should be incorporated into a schedule. Scheduling is a planning process that provides a basis for implementing all BMPs in a timely and logical fashion as construction progresses. It may be necessary to implement BMPs sequentially instead of all at one time (Figure 2-1).

Staging of construction is part of scheduling. Staging is sometimes called phasing. With staging, grading in a limited area is completed and stabilized before proceeding with additional grading or earth change activities (Figure 2-2). Staging allows you to take advantage of the existing vegetation on the site. Plan the stages or phases of development so that only areas which are actively under construction have bare soil. All other areas should have a good cover of vegetation or mulch.

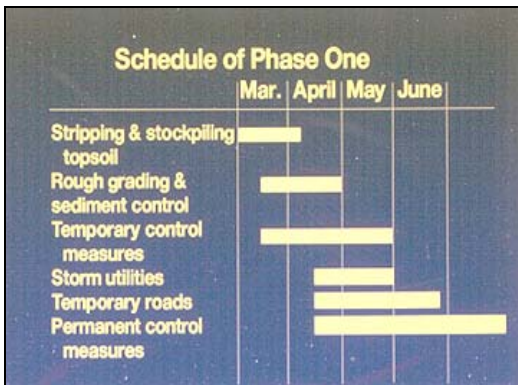

Figure 2-1

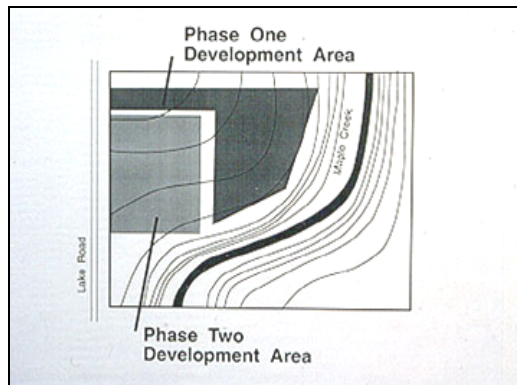

Figure 2-2

Source: John Warbach, Planning and Zoning Center, Inc.

Inspector’s note: Do the activities on the ground correspond with the sequence described in the schedule? Is phasing proceeding only as each phase is stabilized or otherwise made secure?

Vegetation (R, E, S)

The most effective way to control runoff and erosion, and one of the most effective means of controlling sediment, is to keep the soil covered with vegetation, which:

- Shields soil from the impact of raindrops, the force of the wind, and the energy of runoff
- Creates structure in the soil with its roots and rhizomes, which both resists the erosive forces of runoff and increases soil permeability and infiltration
- Provides a continuing supply of organic matter, which improves fertility and infiltration
- Slows runoff to non-erosive velocities
- Filters sediment

As is the case with rainfall-induced erosion, the best way to protect against wind erosion is to keep the area covered with vegetation or with securely anchored mulch. Also, in areas subjected to strong winds, such as along the Great Lake shorelines, soil should never be placed in piles and left unvegetated or otherwise unprotected.

To the extent possible, preserve existing vegetated areas; this eliminates the effort and expense of reestablishing vegetation. Vegetation above a graded area will slow the runoff, reducing its potential to erode bare soils; vegetation below the graded area slows runoff and will filter some of the sediment before the runoff leaves the site (Figure 2-3).

Seed and mulch all areas that have no vegetative cover as soon as possible, but no more than five days after achieving final grade. If it is not feasible to permanently seed, establish a quick-growing temporary grass cover or install appropriate temporary BMPs. Mulch should always be placed on bare soil to protect it from rain or wind, whether or not it has been seeded.



Figure 2-3

Inspector's note: Ensure that seeded areas are germinating. Is irrigation necessary? Are mulch or mulch blankets providing adequate cover to protect the soil and seed and are they in place and adequately anchored? Look for damage to vegetation from erosion or sediment deposition or from mechanical damage from vehicles, foot traffic, or livestock. If the vegetation is separated from the construction area by barriers or silt fence, ensure that they are in good condition. In general, be sure that the vegetation is performing its intended function.

The foregoing paragraphs provide only a brief overview of vegetation from the perspective of conducting routine inspections. Unit 3 provides a more thorough treatment of vegetative practices, including information on site analysis and preparation, seed specifications, follow-up maintenance, and treatments other than seeding. The emphasis of Unit 2 is runoff and erosion control.

Appendix 3A “Filter Strips” details the use of vegetation as a sediment control. Although the document is primarily for use in agriculture, forestry, and wildlife habitat protection, the principles and specifications are relevant and appropriate to isolate earth changes from sensitive areas.

Surface Roughening (R, E, S)

The rate of runoff can be reduced by surface roughening. It is an easy and economical method that simply creates an uneven or bumpy condition on the soil surface. Horizontal grooves tend to spread runoff over the slope, slowing it down and allowing more of it to infiltrate into the soil (Figure 2-4).

Scarification is one way to roughen the soil surface. It can be easily accomplished with a drag, cultivator, or by driving a dozer or other tracked vehicle perpendicular to the slope (Figure 2-5). Roughening also produces a soil surface more suitable for the growth of vegetation because it will hold the seed and retain moisture.



Figure 2-4



Figure 2-5

Inspector’s note: At the initial inspection, ensure that the grooves created by the roughening is perpendicular to the direction of flow and that the entire sloped surface has been treated. If a roughened surface is the final grade, seed and mulch or other non-erodible surface should be installed within five days. Ensure that rilling or gullying has not broken through the roughened surface; it may be necessary to supplement the roughening with other BMPs.

Rock, Stone, and Riprap

Several of the BMPs described in this training make use of rock or stone. Assemblages of rock or stone to create a functional structure are often referred to as “riprap”, particularly when associated with water. A few general comments about the use of riprap is in order.

It is important to remember that no matter what riprap is used for, proper rock size and thickness must be based on the application and the maximum expected water velocity or wave energy. In most situations, geotextile should be placed between the riprap and the soil. Occasionally, it is desirable to allow vegetation to grow through the riprap, in which case either nothing or biodegradable erosion control mat can be used in lieu of geotextile.

Rock that is too large may allow sediment transport between the rocks or may allow runoff to pass through at erosive velocities. If rock is too small, the energy of moving water may move the rock and destroy the structure. To keep the interstices of riprap structures free of sediment, bare soil upslope of riprap should be stabilized with sod or seed and mulch or the riprap otherwise protected by means of temporary sediment controls. To avoid slumping, riprap should not be used on slopes steeper than 2:1. If placing riprap requires the reconfiguration of banks, slopes, or channels, filter fabric and riprap should be placed immediately after grading. The geotextile and riprap should be "keyed-in" at the top and bottom of slope. If riprap is used as an energy dissipator at the discharge of a concentrated flow, it should be designed to reduce the anticipated flow to non-erosive velocities. The riprap should be installed before any concentrated discharge occurs.

Diversions and Channels (R, E, S)

Diversions are specialized channels and many of the same considerations apply for both design and inspections. Diversions always capture runoff, but depending on their location, diversions can provide erosion control, sediment control, or both. Diversions upslope of a construction site intercept runoff that would otherwise flow across an exposed slope and cause erosion (Figure 2-6). Diversions below a construction site intercept sediment laden runoff and route it to an area where the sediment can be contained.

A diversion is generally constructed as a channel with a ridge on the lower side. Often the excavated material from the channel is used to construct the ridge. The channel and ridge can be bare compacted soil or vegetated. When the anticipated runoff velocities exceed 1.5 to 2.0 feet per second, diversions should be vegetated. Reinforcing measures, such as erosion control blankets, turf reinforcement mats, or check dams may be necessary while establishing vegetation in the channel or on the ridge.

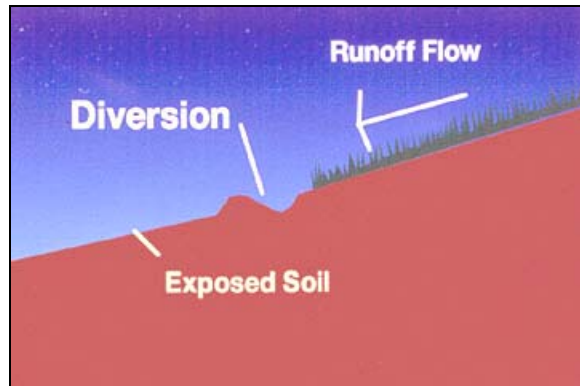

Figure 2-6

Source: John Warbach, Planning and Zoning Center, Inc.

All diversions should be constructed in accordance with NRCS specifications to ensure adequate flow capacity and to keep velocities within acceptable ranges. Specifications for permanent diversions are more rigorous than for temporary ones. The slope of the channel should be sufficient to generate an adequate runoff velocity to create good positive drainage. Care must be taken not to exceed velocities that will erode the diversion channel (Figure 2-7).

Care must be exercised when using diversions above steep slopes; a slide could occur (Figure 2-8). The major cause of sliding is the saturation of the soil by water concentrated behind and within the diversion structure. Soil saturation can be prevented by increasing the channel grade or lining the diversion channel with impervious materials such as concrete or asphalt.



Figure 2-7



Figure 2-8

Overland flow that is captured in a diversion and concentrated must be disposed of without causing erosion or depositing sediment where it is undesirable. This can be done by diverting the flow onto vegetation, into a basin or grade stabilization structure, or by minimizing flow velocities within the channel or at the discharge point with energy dissipaters (Figure 2-9).

The easiest way to dispose of diverted water is directly onto well-established vegetation. Vegetation has limits, however, and will erode if runoff velocities

become too high or are subjected to continuous runoff for extended periods of time. Newly planted grass cannot withstand concentrated flows (Figure 2-10). It may be necessary to temporarily divert the runoff until the seeded areas become permanently stabilized.



Figure 2-9



Figure 2-10

Inspector's note: Examine the diversion or channel bottom for erosion, ponding, or sediment deposits. If mulch blankets, turf reinforcement mats, or check dams are installed, ensure that they are secure and functioning properly. Ensure that runoff is being captured by the diversion and not flowing around or overtopping it. The discharge from the diversion should not be creating erosion and any sediment carried by the discharge should be properly contained. For interceptor dikes, ensure that the diverted runoff is not creating erosion and be sure that the dikes have not been damaged by vehicle traffic.

Grade Stabilization Structures (R, E)

Grade stabilization structures are used to carry runoff from one level to another (Figure 2-11). All grade stabilization structures must be designed to carry the anticipated runoff from the site and constructed in such a manner to prevent "piping." Piping occurs when water erodes small channels under or along the side of the water conveyance structure (Figure 2-12). The potential for piping can be minimized by using flared metal inlets and compacting the soil around the inlet section.



Figure 2-11



Figure 2-12

Downdrains are one type of grade stabilization structure commonly used on construction sites. There are several types of downdrains:

- A pipe downdrain consists of a metal inlet and a rigid or collapsible drain tube made of metal or heavy-duty fabric (Figure 2-13).
- A chute or flume is a flat or round bottomed ditch usually lined with concrete or asphalt. Undercutting or flow around the side can be a problem unless a good bond is maintained between the diversion and the flume inlet (Figure 2-14).



Figure 2-13



Figure 2-14

No matter what grade stabilization structure is used, care must be taken to prevent scouring or erosion at the outlet. Scouring can be prevented by using one or more of the following: place large rocks on geotextile material downstream of the outlet, use flared end sections, or place large rocks or concrete blocks in the flume channel. If possible, run the structure beyond the bottom of the slope, or at least to an area of lesser grade; this will reduce discharge energy and make the job of energy dissipation easier.

Inspector's note: Ensure that the structure is capturing the runoff from the area it was intended to serve. Is water flowing down slope other than through the structure? Examine the inlet and outlet of the structure for piping and erosion. If erosion has occurred, ensure that the structure has not been undermined or otherwise damaged. If the structure is a rock lined chute, ensure that the rock is not migrating downslope and that the underlying geotextile is not damaged or shifted out of place.

Check Dams (R, E, S)

The primary purpose of check dams is to reduce water flow in ditches, diversions, or other areas of concentrated flows to non-erosive velocities. In some situations it is impossible to establish or maintain vegetation in areas of concentrated flow without installing check dams or other structural BMPs. Check dams can also function as sediment controls if runoff is slowed sufficiently to allow large-sized particles to settle out of the water and be deposited upstream of the check dam. The deposition

of sediment can be increased by excavating sumps upstream of the check dams (Figure 2-15).



Figure 2-15

Check dams are generally constructed of rock. Silt fence or sandbags should never be used as check dams. When constructing check dams, place the rock in the ditch and up the sides to a level above that of the anticipated flow (be sure to consider the highest annual flow for the site). The middle of the dam should be nine inches lower than the outer edges (Figure 2-16). This allows water to flow over the depression in the center of the check dam, as opposed to around the sides where it could erode the banks.

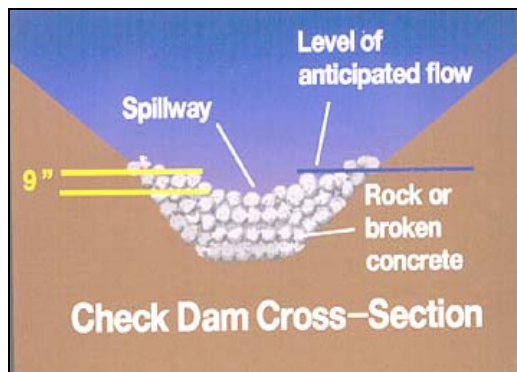

Figure 2-16

Source: John Warbach, Planning and Zoning Center, Inc.

Check dams are usually placed in a series (Figure 2-17). They should be located or spaced so that the toe of the upstream check dam is at the same elevation as the lowest point of the top of the downstream check dam (Figure 2-18). Therefore, the steeper the slope, the closer the check dams should be.



Figure 2-17

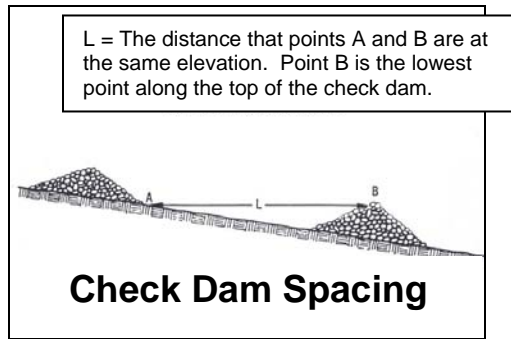

Figure 2-18

Riprap should be placed immediately below the check dam to help dissipate the energy of water flowing over the dam. Stone size should be increased with increased slope and velocity. The stone should be big enough to stay in place during anticipated high velocities. When larger sizes of stone are used, place smaller stones immediately upstream of the check dam to filter sediment.

The size of stone used, as well as base preparation, must adhere to strict engineering standards or failure of the structure can occur.

Temporary check dams made of a plastic grid are also available (Figure 5-19). Advantages of temporary check dams are that they are reusable and can be removed when vegetation is well established. Permanent rock check dams often create traffic hazards, interfere with mowing or other maintenance, may be aesthetically undesirable, and rock is difficult to handle. Instead of using permanent rock check dams, consider a vegetated channel lined with turf reinforcement mat with temporary check dams.



Figure 2-19

Inspector's note: Ensure that the check dam has not been damaged by vehicle traffic, vandalism, or excessive flows. Examine the channel bottom and ends of the check dams for erosion. Accumulated sediment on the upslope side of the check dam (or in the sump) should not exceed 40-50% of original volume. If temporary check dams are used, be sure they are properly secured to the substrate, are not damaged, and are not obstructed by debris. When the channel is well stabilized, schedule temporary check dams for removal.

Channel and Slope Stabilization (R, E)

Check dams alone are not always capable of reducing water velocities to levels that will prevent erosion; additional measures may be necessary to stabilize the channel bottom. Anticipated velocities, and to a lesser extent, aesthetics, will dictate which stabilization measures to use. For example, unvegetated bare channels can generally only sustain velocities up to 1.5 to 2 feet per second without eroding (Figure 2-20). Established grassed lined channels can accommodate velocities up to approximately 4 to 5 feet per second (Figure 2-21). Until grass is established, runoff may have to be diverted away from the exposed area to protect the seedlings and the channel itself from erosion. Under extreme conditions, channel velocities can reach 15 feet per second, and extreme measures will be needed for stabilization.



Figure 2-20



Figure 2-21

Another option is to line the channels with erosion control blankets or turf reinforcement mats (Figure 2-22). Blankets and mats are manufactured by several companies, each of which has specific applications. Primary differences between blankets and mats are in the materials that are used and how they are constructed (Figure 2-23). Some are designed for low velocity situations while others are capable of accommodating higher velocities.



Figure 2-22

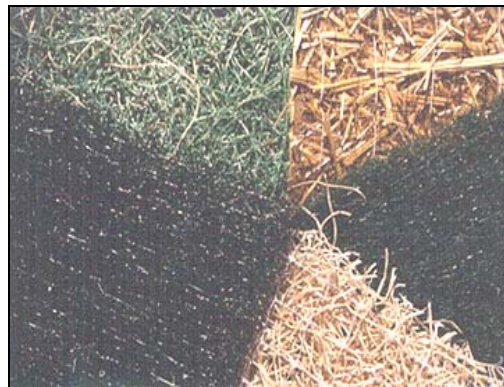

Figure 2-23

In the past, extremely high velocities in channels precluded the use of vegetation or blankets for stabilization and it was necessary to line the whole channel with riprap, rock gabions, or concrete (Figure 2-24). Although “hard” channel lining is still a viable option, turf reinforcement mats (TRMs) have been developed that are capable of withstanding channel velocities as high as 25 feet per second. TRMs are often more economical and less labor intensive than rock and concrete linings.



Figure 2-24

Another product available from the erosion control industry that can provide good protection from high runoff velocities is cellular confinement systems (Figure 2-25). The cells can be filled with topsoil and seeded to improve their appearance or filled with gravel to enhance stream habitats (Figure 2-26).



Figure 2-25



Figure 2-26

Although much of this discussion has focused on channels, many of the products discussed are also very effective in protecting slopes. For example, erosion control blankets and cellular confinement systems are routinely used on steep, difficult to stabilize, slopes (Figure 2-27).



Figure 2-27

Contractors often believe that some of the erosion prevention products are unnecessary and expensive. However, if the contractor has to return to the site several times to re-grade and reseed, these products are very cost-effective. Additionally, it is often much cheaper to minimize erosion than to construct sedimentation basins to trap the sediment. If the resultant damage to the environment is included, the overall cost of stabilization becomes negligible.

Inspector's note: Examine the channel bottom and side slopes for erosion. If mats are in use, ensure that they have not slumped or shifted, remain well secured, and are in good contact with the substrate. Ensure cellular confinement or interlocking block systems, and any fill material used in them, are staying in place. Be sure that vegetation is establishing adequately. The outlet of the channel should not be causing erosion or discharging sediment.

Windbreaks (E, S)

Leave trees or other tall vegetation along the perimeter and intermittently across the site to serve as wind barriers (Figure 2-28). When trees or vegetation must be removed, snow fence can be used to form mini wind barriers. The snow fence must be placed perpendicular to the prevailing wind direction or perpendicular to the long dimension of the exposed soils at evenly spaced intervals across the site. Most barriers will protect the soil downwind for a distance of about 10 times the height of the barrier. Therefore, place rows of snow fence about every 40 to 50 feet (Figure 2-29). Although the primary purpose of fencing or other barriers is to reduce the erosive velocity of wind, they also create barriers to stop wind-born soil and keep wind-generated sediment on site.



Figure 2-28

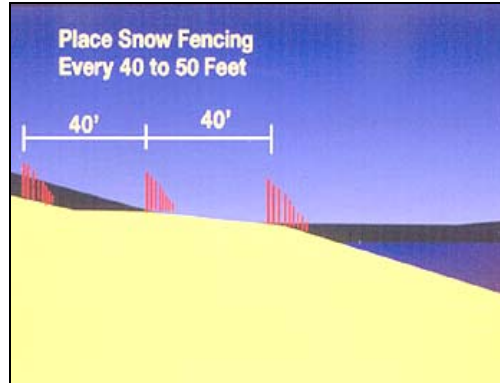

Figure 29

Source: John Warbach, Planning and Zoning Center, Inc.

Inspector's note: If established vegetative windbreaks are used, ensure that they are adequate to the task and do not need to be supplemented with structural controls. If vegetation is used as a surface covering, be sure it is in good condition. Snow fence should be upright, in undamaged condition, oriented appropriately to the wind, and properly spaced. Note the amount of accumulated sediments and recommend clean-out if necessary.

Watering (E)

Another temporary measure for controlling wind erosion is to keep the bare soil moist by watering. A readily accessible water source is required. Water should be applied to the site whenever moderate to high winds are anticipated. Haul roads may have to be watered continuously (Figure 2-30).



Figure 2-30

Chemical binders can be added to water before it is sprayed on to the soil surface. The chemicals penetrate into the soil and bond the individual soil particles, making them resistant to the forces of wind and water. One class of chemicals that are commonly used are polyacrilamides, or PAMs. A more complete discussion of PAMs is found in Appendix 2A. Be aware that the surface application of certain chemicals may be regulated or even prohibited, depending on location and proximity to waters of the state.

Inspector's note: Monitor soil moisture and dust potential and recommend application as appropriate. If watering has occurred, ensure that excess water has not created unintended runoff, erosion, or sedimentation problems. If PAMs or other binders have been applied, ensure that the binding qualities of the chemicals remain functional.

Silt Fence (S)

Silt (or filter) fence is one of the most commonly used BMPs; unfortunately, it is also commonly misused and neglected. Silt fence is intended to remove sediments entrained in runoff by slowing runoff, causing sediments to drop out of suspension, and by acting as a filter as water passes through it. Silt fence should only be used to filter sheet flow, never for concentrated or channelized flow. Silt fence must be placed along a horizontal contour, perpendicular to the direction of sheet flow. The fencing should be **trenched in to a depth of 6 inches and backfilled** with the stakes on the down gradient side of the fence (Figure 2-31). The fabric should be taut so it does not “wave” in the wind. If more than one course of fence must be joined end to end, the ends should be wrapped so there is no gap between courses. If possible, locate the silt fence away from the toe of the slope to enhance ponding and settling (Figure 2-32).



Figure 2-31

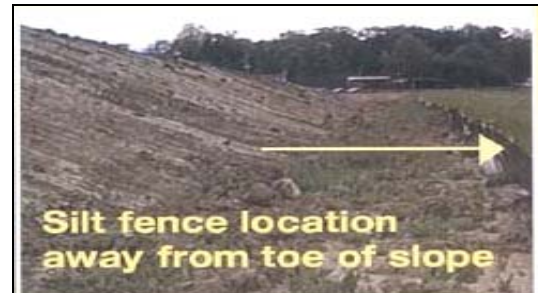

Figure 2-32

When sediment accumulates to 1/3 to 1/2 the height of the fence, the sediment must be removed. Filter fence that has been damaged by excessive sediment loading, vehicle traffic, or general wear and tear, must be repaired or replaced to restore its full function (Figure 2-33).



Figure 2-33

Straw bales are not an acceptable substitute for filter fence. Straw bales are impervious to runoff and act as dams, not as filters, particularly after they become wet. Runoff ponded behind the bales will eventually cause a breach, allowing an escape of both runoff and sediment.

Inspector's note: A large construction site may have several hundreds yards of filter fence; it is important when doing inspections to accurately record the location of any problems. Ensure that sediment accumulations are not excessive, that fabric and stakes are in good shape, and that the fence remains properly trenched in. If the filter fence is properly located along a contour, all runoff should be passing through the fabric as sheet flow. Runoff should not be concentrated by the fence nor should it be flowing around or between the ends of the fence. On long or steep slopes, determine if additional courses of fence are necessary to properly control sediment.

Dewatering (S)

Dewatering is the removal of groundwater, surface water, or storm water from a site to allow construction to be done “in the dry.” The water that is removed from such an area must be discharged to a stabilized area at a non-erosive velocity. If the water is laden with sediment, measures must be taken to remove the sediment prior to its reaching a waterbody or storm sewer inlet. Sediment laden water may be pumped through geotextile filter bags, into sediment basins, or through filter berms constructed of small stone. If the suspended sediments are clays or fine silts, it may be necessary to introduce PAMs into the discharge water to facilitate filtration or settling.

Inspector's note: If the pump does not have a continuous live watch, ensure that it is running properly and oil and gas are at acceptable levels. Examine the suction inlet to ensure it is properly submerged and not sucking air or clogged. Be sure the discharge is not causing erosion or carrying sediments to waters of the state or adjacent properties. If dewatering to a filter bag, sediment basin, or other structural containment system, ensure that the discharge hose remains in place and that no sediments are leaving the containment system.

Access (and Exit) Roads (S)

Sediment is often carried out of construction sites in the tires of vehicles. (Figure 2-34). Sediment tracked on to roads can create a serious traffic hazard or may discharge to waters of the state, either directly or by way of storm sewers (Figure 2-35).



Figure 2-34



Figure 2-35

Tracking can be minimized by restricting vehicular traffic to designated areas. Vehicle routing should be determined and access roads installed prior to the commencement of earth change activities. At all designated exit areas, nonwoven geotextile fabric should be placed on the soil surface and covered with a bed of 4-8 inch diameter crushed rock or stone at least 50 feet in length (Figure 2-36). In addition to eliminating off-site sedimentation at construction exits, limiting access into and within a construction site is also essential when attempting to stabilize the area.

Construction exit roads provide an area that allows soil from vehicles and equipment to fall off tires prior to being tracked onto the primary road; thus, to be effective, egress from the site must be limited to the exit road. Exit roads need to be maintained periodically. This can be done by adding new layers of stone as the old layers become compacted. Ruts in the road, water pooling in the road, and an incomplete or absent stone layer are signs that the access road requires maintenance.

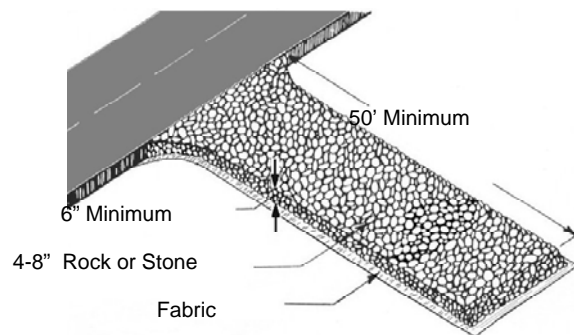

Figure 2-36

Periodic street sweeping in the vicinity of the exit roads may be necessary even with the use of rock exit roads. Sediment that collects on the shoulder of the roads or the curb systems from the sweeping activities must be removed. If a large amount of sediment must be removed, or if sweeping the sediments is likely to create excessive dust, use another means of removal or dampen the sediments prior to sweeping. If tracking of sediment cannot be controlled with rock access roads or sweeping, wheel wash systems may have to be installed. These systems are used

to spray the sediment off the wheels and under carriage of vehicles before they exit the site.

Inspector's note: Check the road(s) for sediment and, if present, schedule sweeping or other means of removal and determine the cause of the BMP failure. Ensure that the road(s) does not contain ruts or sediment loading, that the geotextile is not ripped, shifted, or subsiding, and determine if additional rock should be applied. Look for evidence that vehicles are entering and leaving the site at unauthorized locations; if they are, have traffic barriers installed.

Sedimentation Basins (S)

Sedimentation basins are commonly used on construction sites to trap sand and large silt sized sediment carried by storm water runoff. Sedimentation basins can have a variety of designs and shapes (Figures 2-37 and 2-38). They are generally created by excavating a depression in the ground, by constructing a barrier or berm to impede water flow, or by a combination of both a depression and a barrier. A general overview of basin design is presented here; a more thorough treatment is found in Unit 9.



Figure 2-37



Figure 2-38

For effective sediment control, basins should be at least four times as long as wide with the inlet and outlet at opposite ends. If this is not possible due to site constraints, baffles or convolutions should be placed within the basin to increase the water travel distance (Figure 2-39).

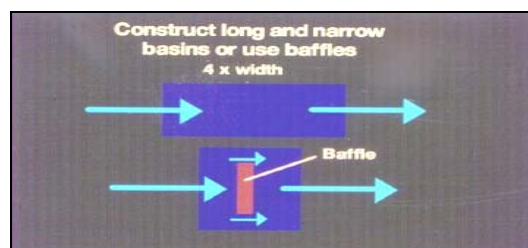

Figure 2-39

Source: John Warbach, Planning and Zoning Center, Inc.

The amount of sediment removed from the storm water runoff is dependent upon water velocity, how long the water remains in the basin, and the size and density of the sediment particles. The slower the water flows through the basin and the longer it remains in the basin, the greater quantity of sediment that will be deposited. The heavier

the soil particle, the quicker it will settle out. Sand tends to settle out rapidly in basins, silt settles more slowly, and clay (and finest silt particles) may never settle out. In general, basins are not effective in removing clay and fine silt, but see the discussion on polyacrilimides (PAMs) in Appendix 2A. Precise engineering is required when constructing basins to accommodate large flows. The engineer must determine the appropriate volume of the basin, as well as how to discharge the water from the basin. Basin volume depends on such factors as anticipated storm events, the size of the drainage area, and the type of soils in the drainage area.

Water can be discharged from a sedimentation basin in a number of ways. The most common way is through a vertical riser pipe connected to a horizontal discharge tube. Collected storm water runoff will leave the basin only when water levels rise above the top of the riser pipe. The water near the surface in the basin generally contains less sediment than the water near the bottom of the basin. Therefore, it is preferable to drain the basin from the surface through a riser pipe rather than through a discharge pipe located at the bottom of basin (Figure 2-40).



Figure 2-40

After a storm has passed, it is often advantageous to lower the water in the basin below the top of the riser pipe to create storage volume to accommodate the next storm. This can easily be accomplished by using a perforated riser pipe instead of a pipe with solid walls (Figure 2-41). The holes will allow the water to slowly exit the basin, lowering the depth of the water to that of the bottom holes. To minimize the loss of sediment passing through the holes, the riser pipe should be wrapped with wire mesh and surrounded with pea stone (Figure 2-42).



Figure 2-41

Figure 2-42

In addition to the principal outlet, emergency spillways are often required to protect the basin when storm water runoff from storm events exceeds the design capacity of the basin (Figure 2-43). The amount of freeboard between the crest of the emergency spillway and the top of the dam should be indicated by the engineer.

No matter which type of outlet structure is used, care must be given to insure that the receiving area can accommodate the discharge without scouring. Generally, energy dissipaters will have to be constructed at the basin outlet (Figure 2-44).

The foregoing discussion refers to basins with outlet structures designed to release water at a controlled rate through a structure; these are referred to as detention basins. Basins that do not have an outlet structure (other than an emergency overflow) and are designed to release water only through infiltration and evaporation are referred to as retention basins. Retention basins should only be considered in locations with very permeable soils and where the sediment inputs contain no fine soil particles. Permeable soils are necessary for adequate infiltration (occasionally referred to as “vertical drainage”). If runoff entering the basin contains fine soil particles, the fine particles will seal the basin, reduce or eliminate permeability, and cause failure of the basin.

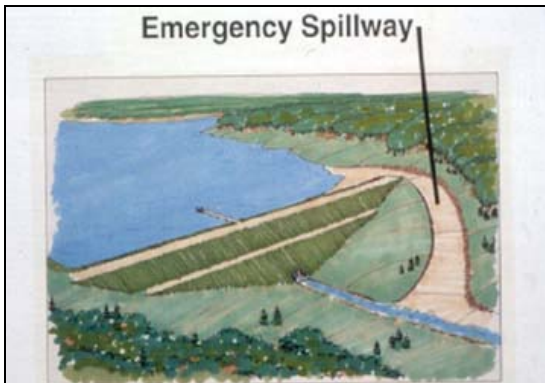

Figure 2-43



Figure 2-44

Periodic cleaning is essential if a basin is to remain functional. Sediment is generally removed with an excavator or front-end loader, so the basin must be accessible. All basins should be cleaned when 40 to 50 percent filled (Figure 2-45). Care must be taken to isolate the excavated portion of the basin from the basin outlet to reduce pollution downstream. This is usually done by diverting the incoming water or removing the sediment when the basin is dry.

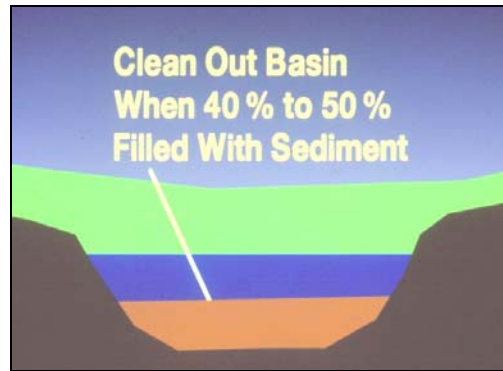

Figure 2-45

Inspector's note: Examine the basin outlet and ensure that water leaving the basin is not carrying sediments and that no erosion is occurring at the point of discharge. If sediments are leaving the basin, attempt to determine why: are fine materials not settling, does the basin need to be cleaned, is the outlet structure damaged or of improper design? Ensure that the outlet structure is not clogged or obstructed with debris. If a large storm event occurs, examine the emergency overflow for erosion or other damage and ensure that water is not leaving the basin other than through the outlet and overflow. Ensure that any earthwork done to create the basin is in a stable condition and is not contributing sediments into or outside the basin. If a retention basin, ensure that permeability is being maintained and that water is not ponding for excessive periods of time. If permeability has been sealed, attempt to determine the cause: is it fine particles or compaction from vehicle traffic? If permeability is lost, the basin may need to be converted to a detention basin with an outlet structure.

Runoff Storage

Runoff storage practices are BMPs that store storm water runoff to protect the receiving waters from high or frequent fluctuations in flow, and in some situations, allow time for treatment to occur. Runoff storage BMPs are normally not designed for sediment control, but are designed for use after a site has been stabilized.

Storm Water Basins (R)

Storm water basins are designed to withhold water and release it over a given period of time. The basin can be either a detention or retention basin as previously described. Although some sediments, nutrients, or pollutants may be removed from runoff while it is in a storm water basin, they are not designed to remove large amounts of sediment from construction sites. Storm water from construction activities should not be directed to these basins without pretreatment. In other words, control erosion and remove the sediment first.

If a sediment basin is being converted into a storm water basin, the sediment which has accumulated needs to be removed for the basin to function as a long-term storm water control.

Inspector's note: In addition to performing inspections as described above for sediment basins, ensure that the stormwater basin is draining adequately to its design level and that the inputs to the basin are not carrying large amounts of sediment.

Catch Basins (S, H)

Catch basins are inlets to storm sewers that contain a sump to capture coarse solids. They are installed primarily to prevent blockages in the sewer system. Although catch basins can capture some coarse sediments, they should never be used as a primary sediment control. Storm sewers often discharge directly to surface waters; other BMPs should be installed to prevent sediment from getting into the catch basins. Catch basins need to be cleaned periodically to remain functional.

Inspector's note: Check sump for accumulated trash and sediment; schedule a cleanout if necessary.

Oil and Grit Separators (S, H)

Oil and grit separators are usually multi-chambered devices that retain runoff to allow heavy material to settle to the bottom of the first chamber, and then skim floating material off the top in the second chamber. They are generally used for small drainage areas.

Catch basin and oil/grit separators should never be used as a BMP to control construction site runoff. However, roads and the storm sewer system are often installed as the first step in the development of the site. When construction is occurring in an area with a functioning storm sewer system, the inlets to catch basins and oil/grit separators must be adequately protected.

Inspector's note: Perform periodic inspections on the interior of the separator to ensure it is not becoming overloaded with oil or debris. Perform frequent, regular inspections at the discharge point of the separator (if accessible); look for sheens, staining, stressed or dead vegetation, or a lack of vegetation.

Storm Drain Inlet Protection (S)

Storm sewers often discharge directly to waters of the state with little or no prior treatment of the storm water. To prevent clogging of storm sewers and to protect our lakes, streams, and wetlands, all storm drain inlets must be protected from sediment inputs during construction.

Storm drain inlets can be protected in several ways. If it is not critical to drain water from the site, the inlet can be sealed with an impervious material until the site is stabilized. In most situations, water must be removed from the site so the drain must remain functional. Simple structural ways to protect inlets include:

- Silt sacks or other comparable products are structures made of filter fabric that are designed to be inserted below the grate of a storm sewer inlet. They allow water to pass through while containing sediment and usually have loops to facilitate removal and clean out.

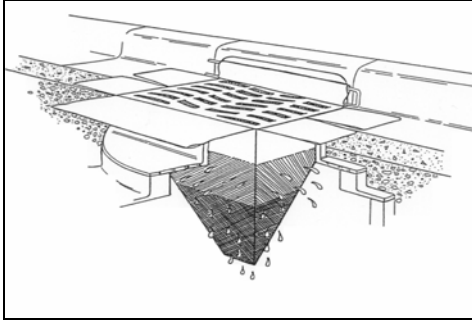

Figure 2-46



Figure 2-47

- Wrap the grate of the basin with geotextile materials (Figure 2-48). The geotextile fabric should be placed on top, not under the grate. This technique should never be used on flat or low-profile grates – they will quickly become clogged and cease to function. If the storm grate is flat, products are available that create a temporary raised structure to support filter fabric.
- Install silt fence around the perimeter of the drain inlet (Figure 2-49).



Figure 2-48

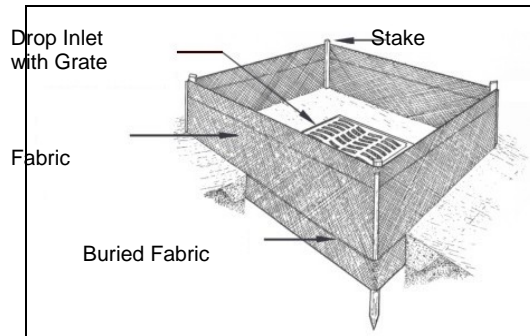

Figure 2-49

Source: Price and Company

- Place a filter made of coarse gravel or pea stone in front of or around the drain inlet. The gravel provides a certain amount of filtering action, and is highly resistant to erosion. Standard concrete building blocks or wire mesh are placed on the inside of the gravel filter to keep stones from being washed into the storm drain inlet (Figure 2-50). The configuration of the filter will depend upon the type of inlet being protected.

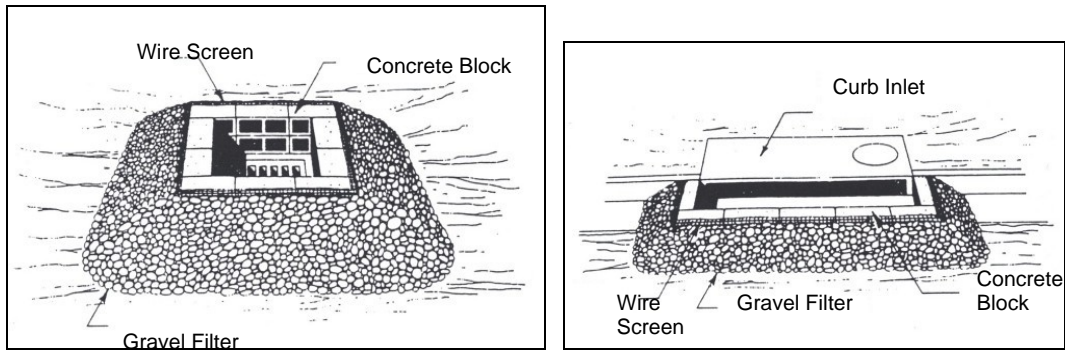

Figure 2-50

Inspector's note: Check for clogging of fabric or screens, overtopping, and structural integrity; in particular, ensure the structures are protected from, and not damaged by, vehicles. If sediment accumulations are sufficient to impede function, schedule sediment removal.

Equipment Maintenance and Storage Area (H)

To protect tree roots, and ultimately the health of the tree, vehicles or other equipment stored outdoors should not be left within the drip line of trees. The drip line is the outer most horizontal extent of the foliage of a tree. Vehicles and equipment storage should be at least 100 feet away from surface waters of the state. Runoff from the storage area must be directed to drain away from surface waters, storm sewers, or adjacent properties.

Vehicles and equipment should be washed in areas that do not drain to surface waters, storm sewers, or adjacent properties. Wash areas can be constructed of two to three inch stone at least six inches thick. Isolate wash areas with berms or diversions to prevent runoff from leaving the area. Additional stone may be needed during the construction phase to maintain the integrity of the wash area.

Inspector's note: Ensure that equipment and vehicles are not leaking oil or other fluids. Ideally, all maintenance will be done on impervious areas, or on pads designed to contain any pollutants that may spill. Impervious pads are particularly important on sandy and other coarse soils where spilled materials can easily leach into the groundwater. Also make sure that empty containers, scrap wood, metal, and all other wastes are disposed of in a well-managed rubbish container. Waste materials are **NOT** to be buried or burned on site.

Pesticides and Fertilizers

Pesticides, fertilizers, and other potentially hazardous materials should be kept in locked storage. Ideally, secondary containment will be provided for all such materials. The containment structure should be designed to hold 150 percent of the volume of the substances. For construction sites where potentially hazardous materials are used or stored, a spill response plan should be developed. A spill response plan should include the steps that will be taken to contain and clean up any spilled pesticides or fertilizers.

Small quantities of spilled liquid fertilizers can be cleaned up by applying kitty litter or sawdust, then sweeping it in newspaper, and disposing of it in the trash. Small quantities of powdered fertilizers should be swept up and disposed of in the trash. Never wash fertilizer spills down floor drains or driveways, which will likely either go to storm sewers (and consequently into water of the state) or could leach into the groundwater.

For large spills, or spills of hazardous materials, contact the Pollution Emergency Alert System, or PEAS line. The toll-free number (1-800-292-4706) is in service 24 hours a day for reporting spills.

Two important things to remember about pesticide and fertilizer management are:

- ✓ Never apply pesticides and fertilizers directly into or immediately adjacent to streams, rivers, lakes, or wetlands.
- ✓ Mix, apply, store and dispose of pesticides, fertilizers, and their containers in strict accordance with the manufacturer's instructions.

Subsurface Drains

Subsurface drains include tiles, pipes, or tubing installed below the ground to intercept, collect or convey drainage water. They are designed to remove excess water from the soil.

Inspector's note: Look for ponding in the area meant to be drained, which would indicate a system blockage. Also look for signs of erosion around outlets and check the outlet for blockages by roots or debris.

SUMMARY

We have completed our discussion of methods for controlling runoff, erosion, and sediment. Some of the more commonly used BMPs are discussed, but the discussion is not all-inclusive. SESC is an evolving technology, and one should remain aware that the introduction of new products and techniques can change the nature of “best management”.

To be effective, all BMPs must be regularly inspected and maintained. Damaged control structures must be immediately repaired or replaced. In addition to examining the condition and effectiveness of existing BMPs, a proper SESC inspection will examine the entire construction site to ensure that BMPs have been implemented in all areas that they are necessary. Sediment should be removed when it accumulates behind check dams, in diversions, or behind other sediment control structures.

The effectiveness of all BMPs is dependent on the magnitude of storm water runoff, size and weight of the particles being eroded, and routine maintenance of the structures. If the control measures are performing adequately, sediment will accumulate. If this sediment is not periodically removed, the structures will eventually become ineffective. Periodic maintenance of the control measures is necessary for effective sediment control.

In summary, remember that:

- Water and wind are the major causes of erosion and sedimentation
- Erosion and sedimentation will occur on most construction sites unless measures are taken during the planning and early development stages to control runoff
- The most effective and least expensive method to control runoff, erosion and sedimentation is to keep the soil covered with vegetation. Bare soil on a site can be minimized by:
 - ✓ Staging construction
 - ✓ Preserving existing vegetation
 - ✓ Covering all disturbed areas with temporary seeding and mulch
 - ✓ Establishing permanent seeding as soon as possible
- Structural practices are used when vegetative practices are not sufficient or practical to do the job.
- Sediment control should not be used as a substitute for erosion control, but rather in conjunction with it.
- It is generally more effective to minimize erosion than it is to control sediment.

In this manual and the BMP Guidebook, some of the most common BMPs and SESC measures are described. However, there are many other possibilities available. Make note of the use of different BMPs and document any successes or failures. This information may be useful for future reference: if a BMP or SESC measure works -- use it.

UNIT TWO REVIEW

1. When developing a runoff and SESC strategy, remember that _____ and _____ control is more effective and cost efficient than _____ control.
2. Without proper planning, construction generally results in an _____ in runoff.
3. _____ controls rarely reduce _____ or _____.
4. Fine sediment particles, such as _____ and _____, are difficult or impossible to capture with standard _____ control techniques. It is particularly important to emphasize _____ and _____ control on sites with fine textured soils.
5. List five construction practices that minimize runoff and control erosion:
6. List five sediment control practices:
7. _____, sometimes called _____ is part of scheduling. This is where grading and stabilization are finished in one area before proceeding to the next area.
8. The slope of a diversion channel must be adequate to provide good positive _____ but not so great as to create water velocities that will _____ the diversion channel.
9. Overland flow that is diverted must be disposed of without causing _____ or _____ where it is undesirable.
10. Runoff may be disposed of onto _____ – _____ vegetation.
11. _____ structures are used to carry runoff from one level to another.
12. _____ occurs when water erodes small channels under or along the side of a water conveyance structure.
13. _____ are often used in roadside ditches to reduce the velocity of water.
14. The center of the check dam should always be _____ than the outside edges to prevent scouring around the structure.
15. The size of the stone used in check dams should be _____ as slope and/or velocity increases.

16. When anticipated channel velocities are too great to establish grass, the channel can be lined with erosion control _____ or _____ mats.
17. Sediment basins should be at least _____ times as long as wide. If this is not possible, _____ or _____ should be placed in the basin to increase the water's travel distance.
18. _____ tends to settle rapidly in a sediment basin, but _____ and _____ sized particles may never settle out.
19. Some methods used to control wind erosion include:
placing _____ perpendicular to the prevailing wind direction
keeping the soil _____
spraying _____ binders on the soil surface
20. To be effective, all BMPs must be periodically _____, _____, and/or replaced when necessary.

ANSWERS TO UNIT TWO REVIEW

1. When developing a runoff and SESC strategy, remember that **runoff** and **soil erosion** control is more effective and cost efficient than **sediment** control.
2. Without proper planning, construction generally results in an **increase** in runoff.
3. **Sediment** controls rarely reduce **runoff** or **erosion**.
4. Fine sediment particles, such as **silts** and **clays**, are difficult or impossible to capture with standard **sediment** control techniques. It is particularly important to emphasize **runoff** and **erosion** control on sites with fine textured soils.
5. List five construction practices that minimize runoff and control erosion:
6. List five sediment control practices:
7. **Staging**, sometimes called **phasing** is part of scheduling. This is where grading and stabilization are finished in one area before proceeding to the next area.
8. The slope of a diversion channel must be adequate to provide good positive **drainage** but not so great as to create water velocities that will **erode** the diversion channel.
9. Overland flow that is diverted must be disposed of without causing **erosion** or **depositing sediment** where it is undesirable.
10. Runoff may be disposed of onto **well – established** vegetation.
11. **Grade stabilization** structures are used to carry runoff from one level to another.
12. **Piping** occurs when water erodes small channels under or along the side of a water conveyance structure.
13. **Check dams** are often used in roadside ditches to reduce the velocity of water.
14. The center of the check dam should always be **9 inches lower** than the outside edges to prevent scouring around the structure.
15. The size of the stone used in check dams should be **increased** as slope and/or velocity increases.

16. When anticipated channel velocities are too great to establish grass, the channel can be lined with erosion control **blankets/mats** or **turf reinforcement** mats.
17. Sediment basins should be at least **four** times as long as wide. If this is not possible, **baffles** or **convolutions** should be placed in the basin to increase the water's travel distance.
18. **Sand** tends to settle rapidly in a sediment basin, but **clay** and **silt** sized particles may never settle out.
19. Some methods used to control wind erosion include:
 - placing **snow fence** perpendicular to the prevailing wind direction
 - keeping the soil **moist**
 - spraying **chemical** binders on the soil surface
20. To be effective, all BMPs must be periodically **inspected, maintained,** and/or replaced when necessary.

Polyacrylamide (PAM)

PAM is effective in controlling erosion as well as off-site sedimentation. When placed on bare soil, PAMs bind fine soil particles (especially clays) together and also create larger aggregate particles. In addition to increasing resistance to erosion by binding the particles, aggregation increases infiltration, which reduces runoff and on-site erosion. PAMs can be applied in powder or liquid form on rough graded areas, spoil piles, or final graded areas in conjunction with other soil stabilization materials such as seed, mulch, or mulch blankets.

PAMs can also be used as a water treatment additive and placed directly in the water to remove suspended sediment. It can be sprayed or injected into the water or can be in the form of a solid block which is lowered into moving water such as the inlet to a sediment basin. PAMs are very effective in settling out the clay particles that normally will not settle out in a sedimentation basin.

PAMs come in various formulations with varying characteristics and thus are soil specific in regards to effectiveness. One must match the particular PAM with the type of soil on site and/or the sediment in the water. PAMs can be anionic (negative charged), cationic (positive charged), or neutrally charged. The positively charged PAMs are very toxic to aquatic organisms and should never be used in or near water; only the anionic form (negatively charged) of PAMs should be used.

If the PAM will be placed directly into the water as a water treatment additive, **approval must be obtained** from the DEQ – Water Bureau **prior** to its use. Please note that if PAMs are applied on a ditch or stream bank or in an area where it ultimately reaches the water, the person applying the PAM is liable for any aquatic damages.

Prior to applying Polyacrylamide products, review and follow the Technical Guidance for the Use of Polyacrylamide Products for Soil erosion and Sedimentation Control (SESC), <https://www.michigan.gov/-/media/Project/Websites/egle/Documents/Programs/WRD/Storm-Water-SESC/polyacrylamide-products-technical-guidance.pdf>, to ensure that the proper regulatory approvals are obtained prior to use.

Unit Three

VEGETATIVE STABILIZATION

Introduction

In most situations, vegetation is the most effective and economical means of stabilizing the site of an earth change and controlling wind or water erosion. In addition, vegetation is an effective means of preventing sediment transport and off-site sedimentation. This unit will explain how to successfully re-establish vegetation that has been removed during construction. While some vegetative cover must be removed during the construction process, remember that the best way to prevent erosion is to remove the very minimum amount of vegetation necessary, and to re-establish it as soon as possible.

The most effective vegetative erosion and sediment control is usually achieved with grass and the most commonly used means of reestablishing grass is with seeding. Grass has many fine fibrous roots that bind the soil together. The blades of grass have a higher stem density than other vegetation, creating a greater resistance to runoff and a fine “filter” to filter suspended sediment. The emphasis of this unit is, therefore, the proper selection and application of grass seed. Very steep slopes or areas exposed to high traffic or concentrated runoff may not be suitable for vegetative erosion control and may require structural treatments.

Native and Introduced (Non-Native) Species

Until recently, little consideration had been given to the natural distribution of species selected for revegetation; the only selection criterion was whether or not the species would function for its intended purpose. Over the past several years, the problems associated with the use and spread of non-native or introduced species and the benefits of planting native species have received much attention.

Many introduced species previously recommended for forage or erosion control have proved to be less beneficial for their intended purpose than native species and in some cases have become **invasive** or noxious, outgrowing and eventually displacing valuable native species. Native species are adapted to the local climate and soil, and have coevolved with other species to provide an important function in the ecosystem. If properly selected for site conditions, native species can dramatically reduce fertilizer, lime, and maintenance requirements. When revegetating natural areas, undertaking environmental restoration, or working in areas where introduced species may spread into adjacent natural areas, native seed should be used.

A result of the historic promotion of introduced species is that they are now economical to purchase and readily available. Conversely, native species are usually expensive and available from a limited number of suppliers. The increased awareness of the benefits of planting native species is beginning to reduce their price and increase availability.

Carefully selected introduced species can be planted in most SESC applications without threatening natural habitats. In addition to their inexpensive price and availability, in many – if not most – construction situations, introduced species are preferred because of their rapid growth rate and establishment; it may take several years for a stand of native grasses to mature to a condition that effectively reduces erosion or sedimentation. (See “Cool and Warm Season Grasses” on page 3-19.) Consequently, this unit deals primarily with the use of introduced species and provides limited information on native species. Selection criteria are included for a few of the most available native species.

Species that are widely recognized as invasive or noxious are not identified or recommended in this unit. Species that have been identified as potentially invasive in some situations are flagged in the tables with bold face type. These species can be used in most applications without the potential for environmental damage, but may not be appropriate in some situations. Be aware that as the science of ecology advances, species once considered harmless may be reclassified as noxious or invasive, or vice versa.

Site Assessment

The physical characteristics that will exist on a site following final grade should be assessed in the planning stage, long before it comes time to spend time and money on revegetation. The type of vegetation and means of vegetative establishment are based on such factors as available sunlight, slope, adjacent topography, local climate and microclimate, proximity to sensitive areas or natural plant communities, and soil characteristics such as natural drainage class, texture, fertility, and pH.

Climate

In addition to regional climatic conditions such as temperature and rainfall, the microclimate in the immediate area, which is affected by exposure to wind, shade, or sunlight, must be assessed. On dry sites, it is often more difficult to establish plants on slopes exposed to wind or that face south or west. Conversely, dense shade presents a challenge to establishing vegetation.

Soil Conditions

Consideration must be given to on-site soil conditions such as **fertility, pH, and moisture**. When soils are not suitable for vigorous plant growth, soil additives must be used to alter soil characteristics. A note of caution: it is important to remember that subsoils are usually lower in fertility and often more acidic than topsoil. It is, therefore, extremely important to save and reuse the topsoil when attempting to re-establish vegetation.

Soil Fertility

Fertility refers to the availability of plant nutrients in the soil. Fertile soils contain sufficient nutrients for successful plant growth. Infertile soil can be

improved by adding fertilizers. Fertilizers contain various proportions of the essential plant nutrients: nitrogen, which is labeled N on a fertilizer bag; phosphorus, labeled P; and potassium, labeled K. A fertilizer labeled “12-12-12” is a “well balanced” fertilizer. The number refers to the percentage of each primary nutrient (Figure 3-1). Fertilizer recommendations are usually given in weight of application per unit area (e.g., pounds per acre). To determine the amount of each primary nutrient by weight, multiply the total bag weight by the percent indicated. In a 50-pound bag of 12-12-12, there would be 6 pounds of each nutrient (50 pounds x 0.12 = 6 pounds).

FERTILIZER	
12 - 12 - 12	
GUARANTEED ANALYSIS	
Total Nitrogen (N)	12.00%
Avail. Phos. Acid (P ₂ O ₅)	12.00%
Soluable Potash (K ₂ O)	12.00%

Figure 3-1

Soil pH

The pH scale has a value range of 0-14; with a value of 7 considered neutral, values less than 7 acidic, (Figure 3-2), and values greater than 7 alkaline. The pH scale is logarithmic which means there is a 10-fold difference between each number on the pH scale. A soil with a pH of 5 is ten times more acidic than a soil with a pH of 6. Most plants grow best in circumneutral pH, about 6.5-7.5.

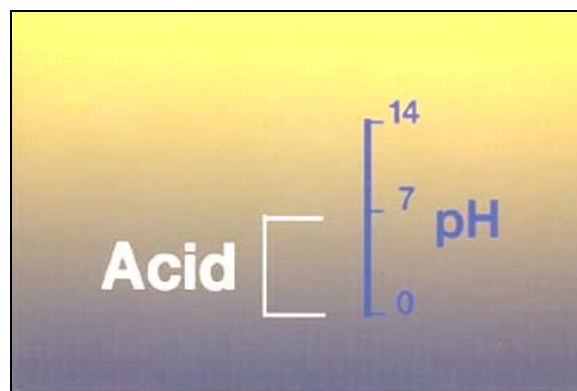

Figure 3-2

Source: John Warbach, Planning and Zoning Center, Inc

Soil pH can be adjusted by adding lime or sulfur. In Michigan, acidic soils are relatively common and it may be necessary to add lime to reduce acidity (increase alkalinity) to improve plant growth. Crushed limestone is generally used for lowering soil acidity rather than the application of pure lime. When

the acidity is lowered, the pH number actually increases. For example, a soil with a pH value of 6.5 is less acidic than a soil with a pH of 5.5 or 6.

Alkaline or basic soils have a pH of greater than 7. Although not often necessary in Michigan, the pH of alkaline or basic soils can be lowered (made more acidic) by adding sulfur or a sulfur compound to the soil.

Before adding soil amendments to adjust pH or increase fertility, soil testing is strongly recommended. Soil pH should be 6.5 to 7.0 if legumes are seeded and no lower than 5.5 if sowing only grass seed. Fertilizer should be avoided or used judiciously, in areas adjacent to lakes or streams because it may stimulate the growth of aquatic plants and algae. If fertilizer must be used near water, consider using a fertilizer with low levels of phosphorous. If soil testing is not performed, a standard application rate on low fertility sites not located near water is 150 pounds of 12-12-12, or equivalent fertilizer per acre. Properly selected native vegetation should not require fertilization; the establishment of fast growing introduced or other unwanted species may be promoted at the expense of the native seeding.

Soil Moisture

The water available to plants is determined by the moisture holding capacity of the soil and by the depth to the water table. Droughty soils – for example, sands with more than a few feet to the water table – are unable to maintain an adequate supply of water to sustain plant growth throughout the year. Wet soils, such as clays, silts, mucks, or even sands with a high water table, may retain too much water for growth of many plant species.

Soil with at least 25 to 35 percent silt and clay-sized particles generally will not be droughty in normal weather. The problem of droughty soil can be partially corrected by mixing silt and clay soil or organic material into the upper 3-4 inches of droughty soil and by selecting drought-resistant plant material.

The opposite of droughty soils are wet soils. Soils may stay saturated for prolonged periods of time due to high clay content, poor drainage, a high water table, or groundwater discharge (seepage). The problem of wet soil can be corrected by using plant materials tolerant of wet conditions, adding sand, or installing artificial surface or subsurface drainage (**Note:** drainage of wet areas may be regulated by law and require a permit).

Slope

When slopes are steeper than two to one (horizontal to vertical), structural controls or vegetation reinforced with structural treatments will be much more effective than vegetation alone (Figure 3-3). On slopes less than 2 to 1, vegetation can generally be used. However, establishing vegetation on slopes close to 2 to 1 may require special attention and careful management.



Figure 3-3

Site Use and Maintenance

Site use is important in selecting vegetation. This refers to whether plants will be subjected to foot and vehicular traffic, salt, or other chemicals.

Site maintenance will also influence the type of plant materials being used. Some sites are easy to maintain, such as those that are relatively flat. Grass cannot be safely mowed on slopes greater than 3 to 1. Other sites are nearly impossible to maintain because of difficult access or physical barriers. Grasses, legumes, or shrubs that do not require mowing should be selected for steep or inaccessible areas (Figure 3-4).



Figure 3-4

Critical, Non-Critical, and Sensitive Areas

Before starting any earth change, critical, non-critical, and sensitive areas should be identified on the site. A **critical area** is difficult to stabilize with vegetation once it is graded and the existing vegetation removed (Figure 3-5). Typical critical areas are characterized by highly erodible, infertile, or droughty soils, concentrated flow, heavy traffic, or long or steep slopes. Whenever possible, leave critical areas undisturbed.



Figure 3-5

Sensitive areas are located near lakes, streams, wetlands, adjacent properties, or other landscape features that are sensitive and vulnerable to damage by sediment (Figure 3-6). As with critical areas, make all reasonable efforts to leave sensitive areas undisturbed and, if possible, isolate from earth change activity with a well designed vegetative sediment filter (or filter strip). A dense cover of grass makes the best vegetative sediment filter; Appendix 3A provides more information on filter strips. If sensitive areas must be disturbed, isolate and stabilize them quickly after disturbance. In addition, many sensitive areas are protected by local, state, or federal law and cannot be disturbed without the appropriate permit.

A **non-critical area** is an area remote or well isolated from sensitive areas and on which a good cover of vegetation can be established and maintained without difficulty.



Figure 3-6

Site Preparation

Proper site preparation is essential to provide good contact between the soil and the seed, thereby assuring acceptable levels of germination. Site preparation includes the following activities:

Slope Preparation. Grade the site to a workable slope (remember, structural treatments are necessary for slopes steeper than 2H:1V, and maintenance becomes difficult or impossible on slopes steeper than 3H:1V). The toe of the slope must be protected from undercutting or slippage, and areas of concentrated flow must be

eliminated or armored prior to seeding. In some cases, temporary or permanent diversions or grade stabilization structures (downdrains) should be installed and functioning prior to seeding. If internal water movement may cause seeps or soil slippage, install subsurface drainage.

Topsoiling. Before seeding and mulching, topsoiling may be necessary. Topsoiling involves placing 3 to 4 inches of good quality topsoil, free of large clods and stones, on the final graded subsoil surface before preparing a seedbed (Figure 3-7). Native topsoil should be stockpiled and reapplied whenever possible (Figure 3-8). If necessary, import topsoil to achieve the required depth.



Figure 3-7



Figure 3-8

Topsoil slippage becomes a possibility when topsoiling steep slopes (Figure 3-9). There are three factors that can contribute to this problem.

The first is high moisture content. Because it contains organic material, topsoil is able to absorb and retain a large amount of water. By absorbing the water, the weight of the topsoil increases, and at the same time it becomes more fluid. When possible, divert water away from the slope until vegetation is established.

The second is slope steepness. The steeper the slope, the easier it is for a heavy, wet topsoil to slip down the slope (Figure 3-10).



Figure 3-9



Figure 3-10

The third is poor bonding, or a lack of a good bond between the topsoil and the underlying subsoil. To prevent slippage, the underlying soil must be roughened to a

depth of at least two inches before applying the topsoil (Figure 3-11). After the topsoil is spread, it should be compacted.

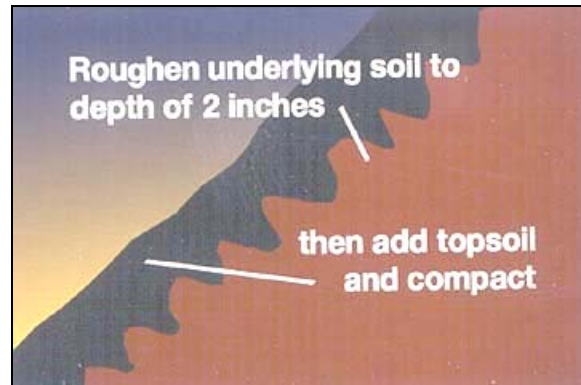

Figure 3-11

Source: John Warbach, Planning and Zoning Center, Inc.

Seedbed Preparation. During recommended seeding periods (Tables 1 and 2), seedbed preparation shall immediately follow construction activities. If seeding is delayed due to the season or other factors, then temporary erosion control measures such as anchored mulch or erosion control blankets shall be installed and maintained until seedbed preparation and seeding can commence.

If the topsoil was removed during construction, the first step in seedbed preparation is spreading 3-4 inches of topsoil and then, if deemed necessary, apply lime and fertilizer on the soil. The application rate should be determined by the soil testing.

Next, till to a depth of at least three inches with a disc or rototiller. Tilling should not be so deep that infertile subsoil is brought to the surface or that a roughened bonding surface is destroyed. Tilling mixes the lime and fertilizer into the soil, allows more air and moisture to penetrate the root zone, and breaks up clods of soil. Tilling should always be performed along the contour of the ground surface, not up and down the slope.

Establishing Vegetation

Seeding

The most common method of establishing vegetation is by means of seeding. The following sections describe some important considerations in the use of seed.

Seed Selection. Use seed with acceptable purity and germination tests that are viable for the planned seeding date. Seed that has become wet or moldy is unacceptable. For most erosion control applications, readily available and economical seed mixtures are suitable; these mixtures are usually composed of introduced species. Use introduced seed mixtures only in places where they will not spread into an adjacent natural area. Invasive or noxious species should never be used.

Seed Mixtures and Rates - Recommended seeding rates should be written into contract specifications or the erosion and sedimentation control plan. Be advised that for any given species, recommended seeding rates from different reference sources may vary widely. Table 4 provides a list of introduced species and the minimum seeding rates for developing custom seed mixtures. Those rates, adapted from the Natural Resources Conservation Service (NRCS), are considerably lower than the rates recommended by MDOT in Table 8.

Seed mixtures that are suitable for most situations are readily available, off the shelf. A good, adaptable, and available mixture is composed of approximately 20-50% each of Kentucky bluegrass, creeping red fescue, and perennial rye. That mixture can be adjusted or supplemented as follows, depending on site conditions:

- If droughty, reduce or eliminate Kentucky bluegrass, increase red fescue and perennial rye, or in extremely dry conditions, add hard or sheep fescue.
- If soil is reasonably fertile and a more aesthetic appearance is desired, increase Kentucky bluegrass and decrease or eliminate perennial rye.
- If shady, increase the red fescue component and use one of the shade tolerant red fescue varieties, such as Chewings or Pennlawn.

Seed Mixtures - Native Species. Refer to Table 6 for example native seed mixtures. Seeding rates for native seed is given in pounds of pure live seed (PLS). This rate can be significantly different than the actual weight of bulk seed. The formula for converting PLS requirements to the required weight of bulk seed is found in the key to the tables on page 3-19.

Seeding Methods

Most grasses and legumes are established by seeding. Seeding is usually done after the lime and fertilizer have been worked into the soil. Seed should be applied as soon as possible, and no longer than five days after final grade has been established. One rainfall can destroy a prepared seedbed that is not mulched.

Herbicides should not be used for one year prior to or after seeding. If herbicides have been used more recently, ensure they are not persistent and will not damage the seeding. Most herbicides intended for use on broad-leaved weeds will also kill legumes.

Distribute seed evenly on a prepared seedbed. Consider making two passes at a lower seeding rate to ensure even coverage. Seed may be applied by hand (Fig. 3-12), mechanical spreader, seed drill, or by hydroseeding. In no case should seed be planted more than 1/4 inch deep. If the site is accessible, the ground should be lightly rolled after seeding to ensure good

seed and soil contact. Inaccessible areas can be limed, fertilized, and seeded with a hand spreader or hydroseeder.



Figure 3-12

Many different combinations of mulch, tackifier, fertilizer, and seed can be applied with a hydroseeder; refer to manufacturer's instructions and available technical literature for advice.

Seeding Dates. The date of seeding is critically important in determining if a seeding will succeed or fail. Tables 1 and 2 provide the dates for seeding permanent vegetation for a normal season. The seasonal window for successful seeding will vary from year to year based on moisture and temperature conditions. A successful seeding is more likely to result by planting in the middle of the suggested spring and fall seeding dates. If a project is completed outside the recommended dates for permanent seeding, the following options are available:

- a) **Dormant Seeding.** When a project is completed after the fall permanent seeding date, a dormant seeding of introduced species may be applied for germination the following spring. The seeding must occur late enough to ensure that the seeds do not germinate in the fall, but before the ground freezes or is snow covered. Dormant seeding requires the use of anchored mulch or erosion control blankets to provide the necessary erosion protection during the winter and early spring until the seeds germinate and vegetation is established. Dormant seeding has a higher risk of failure and when successful often has a reduced germination rate. A seeding of a temporary crop with a follow-up planting of a permanent seed mixture the following spring is another option for late season situations.
- b) **Frost Seeding.** Introduced permanent species may be seeded after thaw in early spring on seed beds which were prepared the previous fall or had a fall-planted temporary cover crop other than winter wheat or cereal rye (these two species persist over winter and must be destroyed to provide suitable conditions for a successful permanent seeding).

- c) **Structural Controls.** If construction occurs too late in the year, one may have to rely on anchored mulch, erosion control blankets, and other temporary measures to protect the soil until the next growing season.

Temporary Cover Crop. Permanent vegetative stabilization is required when it is necessary to stabilize an area for more than one year so only perennial plants can be used.

Temporary vegetative stabilization is the use of fast growing plant materials to stabilize a site for a short time period (one year or less) or to provide stabilization outside the recommended planting season for permanent vegetation. These plants may be either annual or perennial plants. Temporary stabilization is used on soil storage or spoil piles and required when grading would otherwise leave an area without vegetative cover. See Table 3 for date and species selection for temporary vegetative cover. Temporary cover may have to be destroyed to eliminate competition and provide an acceptable seedbed prior to applying a permanent seeding.

Companion Crops. A fast growing annual crop is often included with permanent seed mixtures to provide rapid cover for more immediate erosion control and legumes are often added to provide available soil nitrogen.

- a) **For Introduced Mixtures.** Small grain such as oats, barley, winter wheat, cereal rye (*Secale cereale*), or spring wheat may be seeded at 1.5 bushels/acre with a spring or fall permanent seeding. The use of small grains may present some problems for the permanent vegetation: cereal rye may inhibit the germination of other seeds, and any robust, rapidly growing annual may outcompete the slower growing perennial crop for light, nutrients, and water. The small grain companion crops must be mowed prior to seed production to eliminate competition and reseeding, and to allow adequate light penetration for the permanent crop. Mowing should be at a height of 8-10 inches to prevent damage to the permanent crop. A better option, if the season is appropriate, is to add 5-10 lbs/acre of annual ryegrass (*Lolium multiflorum*) to the perennial mixture.
- b) **For Native Mixtures.** As a companion crop for native seeding, use Canada wild rye at 1-2 lbs/acre, annual ryegrass at 5-10 lbs/acre, or (in spring only) oats at 1/2 bushel/acre.
- c) **Legumes.** Legumes are members of the pea family and have the capability of fixing atmospheric nitrogen into the soil for use by plants. It is often beneficial to include legumes in a seeding mix on low fertility sites. Legumes are slow to establish and usually should not be used as a pure stand for erosion control. They are also less resistant to damage from foot and vehicle traffic than most grasses. If legumes are included in a seeding mixture, they may need to be inoculated with

nitrogen fixing organisms. Follow manufacturer's instructions for both the seed and the inoculant.

Vegetative Treatments Other Than Seeding

Sod. On areas that require immediate vegetation or a high quality turf, sod may be considered as an alternative to seeding. Sod is expensive and prone to failure if irrigation is not available. If irrigation is available, sod may be laid from early May to mid-October. If sod must be used without irrigation, do not lay sod between early June and mid-September. Prepare the site as for seed application. Install the sod with staggered joints, with seams closely abutted but not overlapping, and stake sod in place if installed on a slope greater than 3H:1V or if in an area of concentrated runoff (Figure 3-13). The edge of sod at the top of a slope must be turned in to direct runoff over the sod rather than between the sod and substrate. Lightly roll or tamp sod to ensure good contact with the underlying soil.



Figure 3-13

Sprigging. On sand dunes or other areas of shifting or blowing sand, American beach grass (*Ammophila breviligulata*) is usually the best vegetative treatment for control of erosion. Beach grass is a native species that is established by sprigging - the planting of sprouted plants in the treated area (Figure 3-14). Plant beach grass during the cool portions of the growing season (spring or fall). The plants should be placed on a 12" x 12" grid (43,000 clumps/acre) for windy areas or a 24" x 24" grid (11,000 clumps/acre) for more protected areas. On steep or otherwise difficult sites, beach grass can be planted through erosion control blankets. When planting beach grass, place 2-3 plants in each hole and bury them deep enough to cover the roots and base of the stem. After beach grass is well established and sand movement is reduced or eliminated, other vegetation can be established if desired.



Figure 3-14

Trees and Shrubs. Although grasses, with or without legumes, are the best means to control erosion on most sites, occasionally a special situation arises that requires tall or deep-rooted vegetation or that has special aesthetic requirements. Trees are often used as windbreaks to control wind erosion and the deep roots of woody vegetation may provide soil stability in areas prone to slumping (Fig. 3-15). Table 7 provides information on other plants that may be used in erosion control.



Figure 3-15

Live Stakes and Fascines. Live willow branches, driven into the soil as stakes or bound together in bundles (fascines) and partially buried will sprout and provide rapid shrub establishment. Live willow stakes are most often used to stabilize stream banks. Fascines are used for stream bank stabilization or installed along the contour of slopes for slope stabilization. For live stakes or fascines to be successful, the soil must be moist or even saturated. For details of installation, refer to the substantial technical literature available for these and other “bioengineering” techniques.

Mulching Without Seeding. In situations where final grade is achieved with native organic soils (muck) and the site has low erosion potential, consider applying a clean mulch and allowing the native seed bank to germinate. This option should not be exercised if the organic soils had previously supported invasive species such as purple loosestrife, common reed (*Phragmites*), or reed canary grass.

Mulching

Mulching is essential when establishing grass or legumes from seed. Mulching involves placing material over the seed to protect the soil from erosion and to provide a proper environment for the germination and growth of vegetation. Mulch insulates the soil from intense heat and cold, and conserves moisture by limiting evaporation (Figures 3-16 and 17).



Figure 3-16



Figure 3-17

Immediately following seeding, evenly distribute a mulch of clean dry straw at the rate of 2 tons/acre or 2-3 bales (100 lbs.)/1000 square feet. Ensure that the mulch is derived from a crop that does not contain invasive or noxious species. Hay may contain seeds of undesirable species, and should not be used in most situations. For native plantings, only the cleanest straw mulch should be applied. Mulch can be applied by hand or with a mulch blower (Figure 3-18).



Figure 3-18

On slopes, windy sites, or areas adjacent to roads, mulch must be anchored using netting, a tackifier, or mulch-anchoring disk. On steep slopes or in areas of concentrated flow, erosion control blankets or turf reinforcement mats may be required to properly secure the seeding (Figure 3-19). The blankets are generally made from straw, coconut fiber, excelsior, or a combination of straw and coconut fiber, and reinforced with netting (Figure 3-20). Refer to manufacturer specifications for the proper application of erosion control blankets. Netting and erosion control

blankets must be secured with special staples or stakes (Figure 3-21), and care must be taken to ensure that there is good contact between the blanket and soil. When selecting erosion control blankets, consider using biodegradable blankets and stakes wherever their application is appropriate. Permanent netting, blankets, and stakes often create hazards for wildlife and interfere with mowing operations.



Figure 3-19



Figure 3-20



Figure 3-21

Tackifiers or chemical binders are mixed with water and sprayed on the straw (Figure 3-22). Upon curing, the chemical binds the straw fibers together.



Figure 3-22

A mulch crimper is occasionally used to anchor straw on accessible areas. It consists of a gang of notched coulters, resembling a disc used for tilling. When pulled over the mulch, the revolving discs punch some of the straw into the soil (Figure 3-23).

A hydro-mulcher is often used to apply mulch. The mulch material, made of paper or a blend of wood and paper, is mixed with water to form a slurry and is then sprayed onto the area (Figure 3-24). Often, seed, fertilizer, and a tackifier is mixed with the slurry and applied with the mulch.



Figure 3-23



Figure 3-24

Monitoring Established Vegetation

Protection

All seeding must be protected from foot and vehicle traffic, concentrated runoff, animal grazing, or other potentially damaging uses during establishment. Use diversions, grade stabilization structures (downdrains), curbing, check dams, or other devices to reroute concentrated flow and install signage or barriers to route foot or vehicle traffic away from the establishing seeding.

Maintenance

Successful vegetative stabilization requires maintenance. There are two types of maintenance: follow-up and periodic. Follow-up maintenance is required when the initial seeding, sodding, or other vegetative practices do not achieve the desired degree of stabilization. Once vegetation is established, a long-term inspection routine should be established. Periodic maintenance is undertaken as necessary to maintain a complete and robust vegetative cover.

Inspect the site regularly to ensure that germination is adequate, coverage is complete, and erosion has not damaged the substrate, seed, or mulch. Materials planted in the spring should be inspected during the summer or early fall so that corrective action can be taken during the fall planting season. Areas planted in the fall should be inspected early in the spring so that maintenance can be performed during the spring planting season.

If the vegetative cover did not develop properly, re-evaluate the site to assess why the original seeding failed. Failure could be caused by selecting the wrong type of vegetation, pH problems, inadequate (or excessive) fertilization, lack of moisture, washouts due to storms, or seeding at the wrong time of the year. Reseed and mulch areas that did not germinate.

Plantings of introduced species should be mowed periodically to a height of 6-12 inches to promote dense growth and limit the establishment of undesirable species and woody vegetation. Native plantings may require a different maintenance regimen; contact your local NRCS or other authority for advice. Noxious or invasive species should be removed by spot treatment or hand pulling as soon as they are discovered to prevent their establishment.

Vegetation Specification Tables

Key for Information in the Tables

Abbreviations:

Soil Drainage Class Suitability (Tables 4 & 7): **WD** = Well Drained; **MWD** = Moderately Well Drained; **SPD** = Somewhat Poorly Drained; **PD** = Poorly Drained; **VPD** = Very Poorly Drained

Suitable Uses (Table 4): **A** = sites maintained as a lawn or for aesthetic purposes; **C/F** = cut and fill, slopes, ditch banks; **WW** = areas subject to occasional storm water flow (not permanent or frequent inundation), such as grassed waterways, ditch bottoms, or diversions

Species shown in **bold face** may be invasive and should not be planted where they can escape into sensitive natural areas.

Pure Live Seed vs. Bulk Seed

Seeding rates for native species are usually given in pounds of "pure live seed" (PLS), which can be significantly different than the actual weight of bulk seed. Use the following formula to derive the required weight of bulk seed from the PLS rate. Germination, hard seed (a characteristic of legume seeds), and purity percentages are found on the information label attached to all commercially purchased seed.

$$\text{Pounds (lbs) of Bulk Seed} = \frac{\text{lbs PLS}}{(\text{purity} * + \text{hard seed} *) (\text{germination} *)}$$

*express % purity, hard seed, and germination in hundredths; i.e. 97% = 0.97

For example, a seed label indicates a germination rate of 80%, 10% hard seed content, and a purity of 78%. If the PLS seeding rate is 25 pounds per acre, the bulk seeding rate is computed as follows:

$$\text{lbs of bulk seed} = \frac{25}{(0.78 + 0.10) (0.80)} = \frac{25}{0.704}$$

$$\text{lbs of bulk seed} = 35.5$$

Cool and Warm Season Grasses

Nearly all commonly available introduced or non-native grasses, including all the grass species listed in Table 4, are cool season grasses. These are grasses that put on most of their growth, are greenest, and germinate best in the cooler portions of the growing season; their favored season of growth is reflected in the dates in Table 1. Cool season grasses often go dormant during hot summer weather, putting on no growth, and even turning brown to the point of looking dead. Hot weather is not favorable to the germination of cool season grasses, and if they do germinate, the seedlings are prone to failure, particularly if not regularly watered. Cool season grasses tend to have shallower roots than warm season grasses.

Many of the native grasses are warm season species, which tend to germinate and grow best in the heat of the summer. Warm season grasses are often deep-rooted and slow to establish. Deep-rootedness has advantages for erosion and sediment control and for drought tolerance, but slow establishment – it may take several seasons to get a good cover of native warm season grasses – may be unacceptable for SESC purposes.

Mixing warm and cool season species together may seem a means of taking advantage of the best properties of each type of grass, but that is a strategy that rarely works. Either the cool season or warm season species (usually the rapidly establishing cool species) will out-compete the other, and eventually dominate the site.

Table 1. Preferred Seeding Dates for Permanent Introduced Grasses and Legumes

Zone	Spring Seeding Dates		Fall Seeding Dates
Lower Peninsula south of U.S. 10	April 1 - May 20	See note below regarding summer seeding	August 10 - October 1
North of U.S. 10 and Upper Peninsula	May 1 - June 10		August 1 - September 20

Summer seeding is more reliable if irrigation is available. If a project is completed in the summer and irrigation is not available, it is usually not feasible or advisable to delay seeding. Ensure that summer seeding is accompanied by an adequate thickness of properly anchored mulch. Even with the greatest care, follow-up maintenance of summer seeding is more likely than for spring or fall seeding.

Table 2. Preferred Seeding Dates for Native Grasses

Zone	Spring Seeding Dates	Fall Seeding Dates
Lower Peninsula south of U.S. 10	Thaw - June 30	November 1 - freeze/snow
North of U.S. 10 and Upper Peninsula	Thaw - July 15	October 15 - freeze/snow

The spring seeding dates are preferred for maximum germination. Seed planted in summer may not develop adequately to survive winter. Fall seeding mimics natural systems and is essentially a dormant seeding.

Table 3. Preferred Seeding Dates and Rates for Temporary Cover Crops

Common Name	Seeding Rates		Seeding Dates		
	rate/acre	rate/1000sq.ft.	Lower Peninsula south of U.S. 10	Lower Peninsula north of U.S. 10	Upper Peninsula
Oats	3 bushels	2 pounds	4/1 to 9/15	4/15 to 8/1	5/1 to 8/1
Barley	3 bushels	2 pounds	4/1 to 9/15	4/15 to 8/1	5/1 to 8/1
Annual Ryegrass	50 pounds	1.5 pounds	4/1 to 9/15	4/15 to 8/1	5/1 to 8/1
Winter Wheat	2 bushels	1.5 pounds	9/20 to 10/15	9/10 to 10/10	9/1 to 10/1
Cereal Rye	2 bushels	1.5 pounds	8/1 to 10/15	8/1 to 10/10	8/1 to 10/1

Temporary cover crops must usually be destroyed to properly prepare the seed bed and to eliminate competition for the permanent seed.

Table 4. Minimum Seeding Rates for Introduced Species

Common Name	Scientific Name	Plant Type	Seeding Rate lbs/acre	Drainage Class Suitability	Suitable Uses	Notes
Hard fescue, sheep fescue	<i>Festuca spp.</i>	grass	40	WD, MWD	C/F	1
Creeping red fescue	<i>Festuca rubra</i>	grass	40	WD, MWD, SPD	A, C/F	2
Chewings red fescue	<i>Festuca rubra var. falax</i>	grass	40	WD, MWD, SPD	A, C/F	2
Smooth brome grass	<i>Bromus inermis</i>	grass	40	WD, MWD, SPD	C/F, WW	3
Perennial ryegrass	<i>Lolium perrene</i>	grass	25	WD, MWD, SPD	A, C/F, WW	4
Kentucky blue grass	<i>Poa pratensis</i>	grass	30	MWD	A, C/F	2
Orchard grass	<i>Dactylis glomerata</i>	grass	10	MWD, SPD	C/F, WW	3

Timothy	<i>Phleum pratense</i>	grass	10	MWD,SPD,PD	C/F, WW	3
Redtop	<i>Agrostis alba</i>	grass	8	SPD,PD,VPD	C/F, WW	5
Creeping bentgrass	<i>Agrostis stolonifera</i>	grass	8	SPD,PD,VPD	A	6
Alkali (Fults salt) grass	<i>Puccinellia distans</i>	grass	20	SPD,PD,VPD	C/F, WW	7
Alfalfa	<i>Medicago sativa</i>	legume	15	WD, MWD	C/F	
Red clover	<i>Trifolium pratense</i>	legume	15	WD, MWD, SPD	C/F	
White clover	<i>Trifolium repens</i>	legume	15	WD, MWD, SPD	C/F	
Birdfoot trefoil	<i>Lotus corniculata</i>	legume	15	SPD,PD,VPD	C/F, WW	
Alsike clover	<i>Trifolium hybridum</i>	legume	15	SPD,PD,VPD	C/F	

Notes

To provide quick cover, up to 5-10 pounds per acre of annual ryegrass (*Lolium multiflorum*) can be added to any mixture

- 1 - Drought tolerant species with reduced mowing requirements. Sheep and hard fescue have similar qualities and have been considered varieties of a single species.
- 2 - Species with shade tolerance. "Chewings" red fescue is most shade tolerant; Kentucky bluegrass is moderately shade tolerant.
- 3 - Not tolerant of heavy traffic or close mowing; best in low or no maintenance areas
- 4 - Perennial ryegrass should comprise no more than 50% of any mixture (approx. 12 lbs/acre) and no more than 20% if used in an aesthetic setting
- 5- Poor wear tolerance and poor turf quality; use for low or no maintenance wet sites
- 6 - Aggressive in mixtures and disease prone; tolerant of wet sites; produces "putting green" turf with high maintenance
- 7- Very high salt tolerance; use 10-25% in a seed mix; low wear tolerance; often short-lived

Refer to Table 5 for instructions to create a custom seed mixture.

Table 5. Creating a Custom Seed Mixture

The mixture must contain at least 50% grass seed. Select species based on the natural drainage class of the site. Multiply the pure stand seeding rate of each species by the percentage of the mixture composed of the respective species. Below is an example of a mixture of grasses and a legume selected for a well drained site.

Species	Pure Stand Rate lbs/acre		Percent in Seed Mixture	Rate per Species in Mixture lbs/acre
Creeping red fescue	40	X	40%	16
Kentucky bluegrass	30	X	30%	9
Perennial ryegrass	25	X	20%	5
White clover	15	X	10%	1.5

Total lbs/acre = 31.5

Table 6. Seed Selection Guide for Some Commonly Available Native Grasses

Common Name	Scientific Name	Seeding Rate lbs/acre	Drainage Class Suitability	Notes
American beachgrass	<i>Ammophila breviligulata</i>		Dunes, WD sands	1
"Tioga" deertongue	<i>Panicum clandestinum</i>	15	WD, MWD	2,3
Little bluestem	<i>Schizachyrium scoparius</i>	12	WD, MWD	2
Big bluestem	<i>Andropogon gerardii</i>	15	WD, MWD, SPD	2
Switch grass	<i>Panicum virgatum</i>	10	WD, MWD, SPD	2
Indian grass	<i>Sorghastrum nutans</i>	10	WD, MWD, SPD	2

Notes

- 1 - Beachgrass is planted vegetatively; see text.
- 2 - Warm season grasses.
- 3 - Suitable for sand and gravel pit and mine reclamation; tolerant of low pH.

A great variety of native species are available; consult suppliers for cultural information.

Table 7. Selected Trees and Shrubs for Erosion Control

Common Name	Scientific Name	Drainage Class Suitability	Notes
Evergreen Trees			
Jack pine	<i>Pinus banksiana</i>	WD, MWD, SPD	
Red pine	<i>Pinus resinosa</i>	WD, MWD	
White pine	<i>Pinus strobus</i>	MWD, SPD	
Norway spruce	<i>Picea abies</i>	WD, MWD	1
Deciduous Trees			
Quaking aspen	<i>Populus tremuloides</i>	WD, MWD, SPD	
Bigtooth aspen	<i>Populus grandidentata</i>	WD, MWD	
Hybrid poplar	<i>Populus spp.</i>	WD, MWD, SPD	1
Red maple	<i>Acer rubrum</i>	ADAPTABLE	
Silver maple	<i>Acer saccharinum</i>	MWD, SPD, PD	
Hawthorn	<i>Crataegus spp.</i>	varies by species	3
Black willow	<i>Salix nigra</i>	SPD, PD, VPD	
With the exception of hawthorn, the trees listed above are fast growing and selected for their potential use in windbreaks.			
Shrubs			
Northern bayberry	<i>Myrica pensylvanica</i>	WD, MWD	1,2
Fragrant sumac	<i>Rhus aromatica</i>	WD, MWD	2
Staghorn sumac	<i>Rhus typhina</i>	WD, MWD	
Gray dogwood	<i>Cornus foemina (racemosa)</i>	WD, MWD, SPD	
Red-osier dogwood	<i>Cornus stolonifera</i>	SPD, PD, VPD	
Cranberry-bush viburnum	<i>Viburnum opulus (trilobum)</i>	SPD, PD, VPD	
Shrub willows	<i>Salix spp.</i>	SPD, PD, VPD	
Blackberry/raspberry	<i>Rubus spp.</i>	varies by species	3
The shrubs listed above are selected for vigorous and extensive root growth. Willows are particularly useful for streambank stabilization; they will sprout from cuttings or branch bundles if moisture is adequate			
Notes -			
1 - These species are not native to Michigan (bayberry is native, but very rare).			
2 - These species may not be cold hardy in the Northern Lower or Upper Peninsula.			
3 - Thorny species useful for excluding humans where foot traffic may create erosion sites.			

Table 8. MDOT Seed Mixtures and Rates from 2003 Standards and Specifications for Construction, Tables 816-1 & 917-1

Species	Purity Min. %	Germination %	MDOT SEED MIXTURE (see explanation at bottom of chart)								
			TDS	THV	TUF	TGM	THM	CR	TSM 6-24	TSM 24+	ES
			Mixture Proportions in percent by weight and (pounds/acre) ^(a)								
Kentucky Blue Grass	98	85	5 (10)	15 (35)	10 (20)	10 (20)	30 (65)				
Perennial Ryegrass	96	85	25 (55)	30 (65)	20 (45)	20 (45)	20 (45)		50 (50)	50 (100)	11
Hard Fescue	97	85	25 (55)		20 (45)	30 (65)					
Creeping Red Fescue	97	85	45 (100)	45 (100)	40 (90)	40 (90)	50 (110)				
Fults Salt Grass	98	85		10 (20)	10 (20)						
Cereal Rye	85	85						100 (70)			
Spring Oats	85	85						50 (50)	50 (100)		
Timothy	(b)	(b)									24
Little Blue Stem	(b)	(b)									3
Switchgrass	(b)	(b)									4
Indiangrass	(b)	(b)									3
Big Blue Stem	(b)	(b)									9
Total pounds per acre			220	220	220	220	220	70	100	200	54
Soil Type			Dry sandy to sandy loam	Heavy	All	Medium to heavy	Loamy to heavy	All	All	All	All
General Location			Rural or urban	Rural	Urban	All	Residential and business turf	All	All	All	Upland areas
Salt Tolerance			medium	high	high	low	medium	N/A	N/A	N/A	N/A

(a) (pounds/acre) for the following mixtures are rounded to the nearest 5 pounds

TDS = Turf Dry Sandy
THV = Turf Heavy Soil
TUF = Turf Urban Freeway
TGM = Turf Medium to Heavy Soil

THM = Turf Loamy to Heavy
CR = Cereal Rye, less than 6 months
TSM 6-24 = Temporary Seeding, 6-24 months
TSM 24+ = Temporary Seeding, 24+ months

(b) Environmental Seeding (ES) mixture application rate is shown in pounds of pure live seed (PLS) per acre
PLS = (purity + hard seed) x germination x pounds of bulk seed; express % purity, hard seed, and germination in hundredths;
for example, if 100 lbs. bulk seed with purity =85%, hard seed=10%, germ=85%, then PLS =(0.85+0.10) x 0.75 x 100 = 71.25 lbs.

UNIT THREE REVIEW

1. The best way to prevent erosion is to remove the minimum amount of _____ and re-establish it as soon as possible.
2. A critical area is _____ to stabilize with vegetation. Whenever possible, critical areas should not be _____.
3. A non-critical area is an area on which vegetation can be established without _____.
4. Sensitive areas are those areas next to _____, _____, _____, _____, or other landscape features vulnerable to damage by sediment.
5. Permanent vegetative stabilization is required when it is necessary to stabilize an area for more than _____.
6. Legumes furnish _____ to the soil, an important plant nutrient.
7. When assessing a site prior to selecting plant materials, consideration should be given to:
 - a. _____
 - b. _____
 - c. _____
 - d. site _____ and _____
8. Consideration should be given to on-site soil conditions such as:
 - a. _____
 - b. _____
 - c. soil _____ content
9. A 50 pound bag of 20-10-5 contains _____ pounds of phosphorous.
10. Topsoil should be _____ at the beginning of grading operations for later use.
11. When slopes are steeper than _____:_____ (horizontal/vertical), structures may be more effective to control erosion than vegetation.
12. It is necessary to add _____ to lower acidity (increase the pH).
13. Soil pH should be no lower than _____ for most grasses and no lower than _____ for legumes.
14. The amount of lime and/or fertilizer required for good vegetative growth can be determined through _____.

15. Three factors that contribute to soil slippage are:
 - a. high _____
 - b. slope _____
 - c. poor _____

16. Droughty soil can be corrected by:
 - a. selecting _____ resistant plants
 - b. _____ silt and clay soil or _____ matter with the droughty soil

17. The problem of wet soil can be handled by:
 - a. selecting plants _____ to wet conditions
 - b. installing artificial _____ or subsurface _____

18. Four methods for establishing vegetation are:
 - a. _____
 - b. _____
 - c. _____
 - d. _____

19. Sprigging involves planting _____ plants in the treated area.

20. Sod must be closely _____ together and _____ in place on steep slopes or in areas of concentrated flow.

21. Immediately following seeding, a mulch of _____ should be applied at _____ tons/acre.

22. _____ insulates the soil from intense heat and cold, and conserves _____.

23. On steep slopes or areas of concentrated flow, _____ or _____ may be required to properly secure the seeding.

24. The two types of maintenance required for vegetation stabilization are: _____ and _____.

25. Areas planted in the fall should be inspected in the _____.

ANSWERS TO UNIT THREE REVIEW

1. The best way to prevent erosion is to remove the minimum amount of **vegetation** and re-establish it as soon as possible.
2. A critical area is **difficult** to stabilize with vegetation. Whenever possible, critical areas should not be **disturbed**.
3. A non-critical area is an area on which vegetation can be established without **difficulty**.
4. Sensitive areas are those areas next to **lakes, streams, wetlands, adjacent properties**, or other landscape features that are vulnerable to damage by sediment.
5. Permanent vegetative stabilization is required when it is necessary to stabilize an area for more than **one year**.
6. Legumes furnish **nitrogen** to the soil, an important plant nutrient.
7. When assessing a site prior to selecting plant materials, consideration should be given to:
 - a. **climate**
 - b. **soil**
 - c. **slopes**
 - d. site **use** and **maintenance**
8. Consideration should be given to on-site soil conditions such as:
 - a. **fertility**
 - b. **acidity**
 - c. soil **moisture** content
9. A 50 pound bag of 20-10-5 contains **five** pounds phosphorous.
10. Topsoil should be **saved** at the beginning of grading operations for later use.
11. When slopes are steeper than **2:1** (horizontal/vertical), structures may be more effective to control erosion than vegetation.
12. It is necessary to add **lime** to lower acidity (increase the pH).
13. Soil pH should be no lower than **5.5** for most grasses and no lower than **6.5** for legumes.
14. The amount of lime and/or fertilizer required for good vegetative growth can be determined through **soil testing**.

15. Three factors that contribute to soil slippage are:
 - a. high **moisture content**
 - b. slope **steepness**
 - c. poor **bonding**

16. Droughty soil can be corrected by:
 - a. selecting **drought** resistant plants
 - b. **mix** silt and clay soil or **organic** matter with the droughty soil

17. The problem of wet soil can be handled by:
 - a. selecting plants **tolerant** to wet conditions
 - b. installing artificial **surface** or subsurface **drainage**

18. Four methods for establishing vegetation are:
 - a. **seeding**
 - b. **sprigging**
 - c. **sodding**
 - d. **planting a shrub or tree, live staking or fascines, mulching without seeding**

19. Sprigging involves planting **sprouted** plants in the treated area.

20. Sod must be closely **butted** together and **staked** in place on steep slopes or in areas of concentrated flow.

21. Immediately following seeding, a mulch of clean straw should be applied at **two** tons/acre.

22. **Mulch** insulates the soil from intense heat and cold, and conserves **moisture**.

23. On steep slopes or areas of concentrated flow, **mulch blankets** or **turf reinforcement mats** may be required to properly secure the seeding.

24. The two types of maintenance required for vegetation stabilization are: **follow-up** and **periodic**.

25. Areas planted in the fall should be inspected in the spring.

FILTER STRIP (ACRE) CODE 393A

DEFINITION

A strip of grass or other permanent vegetation used to reduce sediment, organics, nutrients, pesticides, and other contaminants.

PURPOSES

1. To remove sediment from runoff from cropland, grazing land, and disturbed areas.
2. To remove sediment in runoff from forestland.
3. To remove nitrogen, phosphorus, pesticides, and pathogens runoff from cropland, grazing land, and urban areas.
4. To remove sediment, organic material, and other pollutants from polluted water as part of an animal waste utilization plan.
5. To remove sediment from runoff and redirect flow toward a riparian forest buffer.
6. To provide wildlife habitat. **CONDITIONS**

WHERE PRACTICE APPLIES This practice

applies:

1. On cropland at the lower edge of a field or above conservation practices
2. On fields upgrade of intermittent or perennial streams, ponds, lakes, or sinkholes.
3. In areas requiring pollutant entrapment as part of an animal waste utilization plan.
4. When sediment entrapment is required on forestland.
5. As a riparian forest buffer component.

6. Where there is minimal concern for movement of leachate from the filter toward shallow ground water.

CRITERIA

General To All Purposes

Filter strips will be placed only in areas receiving overland laminar (sheet) flow.

The filter strip will be designed to encourage sheet flow and infiltration of run-on water. A method of spreading the effluent across the width of the filter strip will be established, if needed.

Infiltration will be promoted within all filter strip areas unless an immediate ground water concern is evident. Infiltration mechanisms such as detention basins, vegetative barriers, or stone and organic filled trenches can be placed within the filter area perpendicular to the flow gradient. If ground water contamination is a concern, contact the appropriate NRCS technical specialist for design guidance.

Adequate soil drainage, both surface and subsurface, is a necessary component to assure proper functioning of the soil biology and vegetation in the filter strip.

The flow length through the filter strip will be based on the slope, size, and land use of the contributing area; soil and average slope of the filter area; pollutants contained in the runoff, and presence of sensitive land features down gradient from the filter area.

Pollutant entrapment in filter strips is highly dependent on the conditions, particularly infiltration potential, in the filter area. Flow lengths given in the following tables for specific pollutants have been adjusted for the predominant hydrologic soil group in the filter area.

Landform of the filter area must allow equipment operation for mowing and harvesting the vegetation.

Comply with local, state, and federal regulations. Sections 401 and 404 of the Clean Water Act may apply to filter strips adjacent to water bodies. Local permits and regulation may supersede criteria in this standard.

Pesticide applications on or near filter strips must comply with label restrictions concerning buffer areas and setbacks.

Contaminant source control shall be considered for all purposes of a filter strip. Reducing the total volume and the concentrations of contaminants in the run-on will increase effectiveness of the filter strip.

Filter strips are part of a resource management system for the land being managed. Other conservation practices and management techniques to treat the resources of concern that must be in place before the filter strip can effectively reduce the pollutants in the runoff. These will include erosion control, nutrient and pest management, waste utilization and crop rotations.

VEGETATION CRITERIA

General For All Purposes

Filter strips will be established to suitable grasses and Forbs that are adapted to the soil and climate conditions.

Plants selected for filter strips should be actively growing during the expected run-on period.

Plant species must be selected according to the type and quantity of pollutant contained in the run-on and to the growth condition during the time of the year that the pollutant can be expected to move as overland flow.

Plant species should be selected that have stiff, upright growth characteristics for flow retardance and pollutant filtering. Plants must remain upright during flow events and be able to withstand sediment accumulation.

Vegetation will be mowed in the filter strip area. Mowing height criteria is given in Table 1 (see page 5).

Vigorous vegetation growth must be achieved under normal management situations.

The selected plant species must be compatible with other objectives of the landowner.

Vegetation in filter strip area will consist of a single species of grass or comprised of a mixture of grasses, legumes, or other Forbs.

Established grass vegetation must attain a minimum stem density per square foot. Legume and other forb density must also attain a minimum stem density per

square foot. Stem density criteria for specific species is given in Table 1 (see page 5).

The recommended vegetation will be selected from Table 1, Planting Table for Grasses and Legumes (see page 5).

Vegetation establishment procedures, seeding, liming and fertilizing, will comply with practice standard for Critical Area Planting (342).

Shape and prepare a firm seedbed in a manner consistent with environmental concerns and proper functioning of the filter strip. If necessary, shape the site so conventional equipment can be used for preparing the seedbed, seeding, fertilizing, maintenance and harvesting.

CRITERIA FOR FILTER STRIPS TO REMOVE SEDIMENT FROM RUNOFF

Filter strips in cropland, grazing land, or disturbed areas will have a minimum length of flow as given in Table 2 (see page 6).

CRITERIA FOR FILTER STRIPS ON FORESTLAND

A forestland filter strip is part of a forestry operation to reduce delivery of sediment and related pollutants from forest harvest trails and landings toward water bodies. The minimum length of flow through undisturbed forest floor is given in Table 3 (see page 7).

Longer flow lengths should be used to accommodate high velocity runoff, large contributing areas, and partially concentrated flow situations.

If seeded, the recommended species and mixtures, seeding rate, and stem density will be the same as Table 1 (see page 5).

For filter strips that will be maintained in trees or shrubs refer to practice standard Riparian Forest Buffer (393) for design and maintenance guidance.

CRITERIA FOR VEGETATED (EITHER GRASS, LEGUME, OR FORB) FILTER STRIP COMPONENT (ZONE 3) OF A RIPARIAN FOREST BUFFER

Zone 3 will begin at the outer edge of Zone 2 and extend up gradient a minimum of 20 feet. Additional length may be necessary to accommodate land shaping and harvesting equipment.

Zone 3 is composed of grass, legumes, or forb or combinations of the three vegetation types.

Concentrated flow in Zone 3 will be transformed to sheet flow entering Zone 2 by use of mechanisms such as land shaping, vegetative barriers, or constructed water spreaders.

Zone 3 component of a riparian forest buffer will have the minimum length criteria given in Table 4 (see page 7).

CRITERIA FOR FILTER STRIPS TO REMOVE NITROGEN AND PESTICIDES FROM RUNOFF WATER

For filter strips with the purpose of removing nitrogen and pesticides contained in runoff water the following criteria will apply.

Filter strips or areas down gradient from animal waste spreading or crop fields with pesticide and fertilizer treatment where nitrogen and pesticides in runoff are a concern will have a minimum flow length as shown in Table 5 (see page 7).

Vegetation species will be selected that have high nutrient uptake and biomass production to remove the maximum amount of nitrogen in the harvested material. If legumes are selected as a part of the vegetation mixture, they will be restricted to only deep rooted (greater than 3 feet) species.

Vegetation selected for pesticide removal must have tolerance to the pesticide or be able to quickly recover from effects of the pesticide being entrapped in the filter strip.

CRITERIA FOR FILTER STRIPS TO REMOVE PHOSPHORUS FROM RUNOFF WATER

The filter strip will be designed and constructed to promote infiltration of the run-on water into the soil

profile. Infiltration basins, filled trenches or vegetative barriers will be part of the design. Vegetation species will be selected that have high maximum amount of phosphorus in the harvested material.

Vegetation will be mowed and harvested in the filter strip area. Mowing height criteria is given in Table 1 (see page 6).

Filter strips or areas down gradient from animal waste spreading or crop fields with fertilizer treatment where phosphorus in runoff is a concern will have a minimum flow length as shown in Table 6 (see page 8).

CRITERIA FOR FILTER STRIPS TO REMOVE PATHOGENS (BACTERIA AND VIRUS) FROM RUNOFF WATER

Using filter strips and areas as sole treatment for pathogen removal may not reduce the pathogen counts to levels meeting water quality standards. Other management practices may need implementation.

The filter strip will be designed and constructed to promote infiltration of the run-on water into the soil profile. Infiltration basins, filled trenches and vegetative barriers will be part of the filter strip design.

Vegetation will be mowed and harvested in the filter strip area. Mowing height criteria is given in Table 1 (see page 5).

Filter strips or areas down gradient from animal waste spreading, pasture, or other organic waste material treatment where pathogens are a concern will have minimum flow lengths as shown in Table 7 (see page 8).

CRITERIA FOR WILDLIFE HABITAT

Select vegetation species that are compatible to desired wildlife species (see Wildlife Upland Habitat Management Standard 645)

If wildlife habitat is a secondary purpose, don't compromise function or design of the primary purpose.

Multiple drill widths of various grass/forb species are desirable for habitat diversity and cover. For

example, a strip planted to orchardgrass, switchgrass, and garrison creeping foxtail.

CONSIDERATIONS

General For All Purposes

1. Consider the effects of seasonal weather variations such as frozen soils, snow cover, and varying ranges of soil moisture on the efficiency of the filter strip.
2. Consider the effects of vegetation on water use and retention with the soil profile.
3. Maintain a balance for the removal or accumulation of nutrients within the soil-plant system of the filter area.
4. Observe the effect on the visual quality onsite and down gradient from the vegetated filter strip.
5. Be sure the selection and management of the vegetation is consistent with the essential purpose of the vegetated filter strip.
6. Filter strip slopes between 2 and 6 percent are most effective. Steeper slopes require a greater area and length of flow. Shallow slopes cause ponding.
7. The filter should be maintained at the minimum flow length stated in the criteria. The length may be extended if changes occur in the contributing area of the watershed that would increase the amount of runoff or pollutants toward the filter strip.
8. Filter lengths (and widths) should be adjusted to accommodate harvest and maintenance equipment.
9. Provisions for preventing continuous or daily discharge to the vegetated filter strip should be made unless an adequate area for infiltration and soil storage of all applied effluent is provided. Temporary storage or alternate areas for application of the effluent should be considered.
10. For filter areas maintained in trees and shrubs refer to Practice Standard Riparian Forest Buffer (392).

PLANS AND SPECIFICATIONS

A plan and specifications are to be prepared for each specific field site where a filter strip will be implemented based on this standard. A plan includes information about the location, construction sequence,

vegetation establishment, and management requirements. Specifications include size and slope of the filter area; amount and species of vegetation material to be used; as well as the operation and maintenance required assuring that the practice achieves its intended purpose.

OPERATION AND MAINTENANCE

A narrative will be prepared in the plan that will state the required operation and maintenance of the filter strip.

1. Concentrated flow within the filter strip area will be minimized. If concentrated flow occurs, repair and reconstruction will be made immediately to reestablish laminar (sheet) flow. Remove settled solids as much as practicable prior to directing flow to the filter strip.
2. Vegetation in the filter strip will be maintained in a vigorous growing condition. Supplemental application of nutrients will be applied if required by a soil test recommendation or other monitoring procedures. Establish fertilizer needs by soil test results. Apply N fertilizer after vegetation is established. Fertilize by observation and soil test when needed.
3. The filter strip area will be maintained in the vegetative species that supports the design criteria. Periodic removal or control of undesirable species will be performed by methods that do not hamper the overall performance of the filter strip.
4. The filter strip area shall be inspected on a seasonal basis and following major storm and runoff events. Any damages or sediment accumulation that would adversely impair the function of the filter must be corrected immediately.
5. Periodic tillage and reestablishment of some or all of the filter strip vegetation will be required as needed to remove accumulated sediment. An accumulation of sediment greater than 6 inches or any sediment accumulation that prevents the filter strip from performing as intended. This would be a criterion for removal and/or reestablishment of the affected filter strip area.
6. Vegetative plant density as required by the design criteria shall be maintained. It may require overseeding or other management methods such as clipping and harvesting to promote an adequate density of plant stems.

7. Nutrients that accumulate in the stems and leaves of the plant will be harvested and removed from the site. Periodic foliage harvest or intensive grazing as part of a planned prescribed haying and grazing system may accomplish this.

8. Grazing shall not be permitted in the filter strip unless a planned grazing system is being implemented. see (Prescribed Grazing Standard 528A) Grazing will be permitted under planned grazing system only when soil moisture conditions support animal traffic. Otherwise, livestock will be excluded by whatever means. Limit cattle access and control grazing.

9. Vegetation harvest must be performed on a regular

basin to stimulate growth, maintain an upright growth habit, plus provide for removal of nutrients that are contained in the plant tissue.

10. The filter strip area and management will need to be adjusted if management changes occur in the contributing area.

11. Do not use filter strips as a travel way, cropland head land or lane for livestock or farm equipment.

REVIEW AND UPDATE OF THIS STANDARD

Conservation practice standards are reviewed periodically and updated if needed. To obtain the current version of this standard, contact the Natural Resources Conservation Service.

TABLE 1

Planting table for grasses and legumes. Recommended species of grasses, legumes, and other Forbes (Select one of the species or seeding mixes below)

Species or Seeding Mixture	Cool/Warm Season	Seeding Rate (LB /Acre)	Established Density (Stems Per Ft ²)	Minimum Mowing Height (In.)	Sediment Trapping	Nutrient Trapping	Wildlife Value
Smooth Bromegrass	Cool	15-30	50	4	Y		
Garrison Creeping Foxtail	Cool	6-10	70	4		Y	
Orchardgrass	Cool	10-15	70	4	Y	Y	Y
Reed Canarygrass	Cool	10	50	4	Y	Y	
Tall Fescue**	Cool	15-25	60	4	Y		
Tall wheatgrass***	Cool	8-12		6	Y		Y
<i>Prairie grasses</i>							
Intermediate Wheatgrass	Cool	8-12	60	4	Y		Y
Big Bluestem	Warm	10-20*	40-50	12		Y	Y
Eastern Gamagrass	Warm	8*	40	12	Y	Y	Y
Indiangrass	Warm	10-15*	40-50	12		Y	Y
Switchgrass	Warm	5-10*	50	12	Y		Y

*Pounds of PLS- Pure Live Seed

**Do not include tall fescue if area is planned for grazing or forage.

***Do not include tall wheatgrass with filter strips for forestland applications

**Planting table for grasses and legumes. Recommended species of grasses, legumes, and other Forbs
(Continued)**

Species or Seeding Mixtures	Cool/Warm Season	Seeding Rate (LB /Acre)	Established Density (Stems Per Ft ²)	Minimum Mowing Height (In.)	Sediment Trapping	Nutrient Trapping	Wildlife Value
Timothy Alfalfa	Cool;	5-10 6-10	60	4	Y	Y	Y
Bromegrass Alfalfa	Cool	6-12 6-10	60	4	Y	Y	Y
Orchardgrass Alfalfa	Cool	2-5 6-10	60	4	Y	Y	Y
Others			50	4			

TABLE 2

Filter Strip Length To Remove Sediment From Runof

Land Slope Percent of Contributing Area (%) Above Filter Strip	Length of Flow (Feet) Hydrologic Soil Group of Filter Area			
	A	B	C	D
0-1	20	20	22	24
1-3	20	25	28	30
3-5	24	30	33	36
5-8	28	35	40	42
8-12	32	40	44	48
12 - 15	40	50	55	60
15 - 20	48	60	66	72
> 20	*	*	*	*

*For slopes that exceed 20% consult NRCS technical specialist for design guidance.

TABLE 3

Filter Strip Length through Undisturbed Forest Floor Forestland

Land Slope Percent of Contributing Area (%) Above Filter Strip	Length of Flow (Feet)
0 - 3	25
3 - 5	35
5 - 8	45
8 - 12	55
12 - 18	65
18 - 30	80
40 - 50	90
50 - 60	120
60 - 70	150
> 70	*

*For slopes that exceed 70% consult NRCS technical specialist for design guidance.

TABLE 4

Filter Width for Zone 3 Vegetation in A Riparian Forest Bufer

Land Slope Percent of Contributing Area (%) Above Filter Strip	Length of Flow (Feet)
0 - 8	20
9 - 15	30
> 15	40

TABLE 5

Filter Length for Areas Subject To Run-on of Nitrogen and Pesticides.

Land Slope Percent of Contributing Area (%) Above Filter Strip	Length of Flow (Feet)			
	Hydrologic Soil Group of Filter Area			
	A	B	C	D
0 - 1	24	30	33	36
1 - 3	32	40	44	48
3 - 5	40	50	55	60
5 - 8	48	60	66	72
8 - 12	56	70	77	84
12 - 15	72	90	100	108
> 15	*	*	*	*

*For field slopes > 15% consult NRCS technical specialist.

TABLE 6

Filter Length for Areas Subject to Run-on of Phosphorus.

Land Slope Percent of Contributing Area (%) Above Filter Strip	Length of Flow (Feet) Hydrologic Soil Group of Filter Area			
	A	B	C	D
0 - 1	24	30	33	36
1 - 3	40	50	55	60
3 - 5	56	70	77	84
5 - 8	72	90	100	108
8 - 12	96	120	132	144
12 - 15	120	150	165	180
> 15	*	*	*	*

*For field slopes > 15% consult NRCS technical specialist.

TABLE 7

Filter Length for Areas Subject to Run-on of Pathogens (bacteria and virus).

Land Slope Percent of Contributing Area (%) Above Filter Strip	Length of Flow (Feet) Hydrologic Soil Group of Filter Area			
	A	B	C	D
0 - 1	20	25	28	30
1 - 3	24	30	33	36
3 - 5	32	40	44	48
5 - 8	48	60	66	72
8 - 12	100	125	137	150
12 - 15	144	180	198	216
> 15	*	*	*	*

*For field slopes > 15% consult NRCS technical specialist.

Unit Four

PLAN DEVELOPMENT, INFORMATION SOURCES, PLAN REVIEW, AND INSPECTIONS

Introduction

Erosion and sedimentation control is more than just installing a silt fence (Figure 4-1). Soil erosion prevention and sedimentation control requires thoughtful planning to be effective. One must consider what the existing conditions are for the site, where the proposed work is to be done, what the surrounding site conditions are that may impact the project site, and anticipate what will happen during and after construction. This methodical planning should result in an effective soil erosion and sedimentation control (SESC) plan.



Figure 4-1

A SESC permit and plan is required, at a minimum, for all earth changes that disturb one or more acres or that are located within 500 feet of the water's edge of a lake or stream (Figure 4-2). The plan must include all strategies and control measures that will be used to minimize on-site erosion and prevent off-site sedimentation during and after construction (Figure 4-3).



Figure 4-2

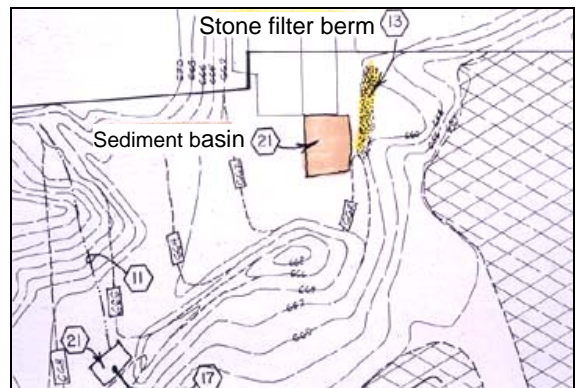

Figure 4-3

Source: John Warbach, Planning and Zoning Center, Inc.

It is the responsibility of the permit applicant or Authorized Public Agency to develop (or hire someone to develop) a site-specific SESC plan. It is the responsibility of the SESC Agency to review the plan submitted by the applicant.

This unit will take you through the steps for developing an effective SESC plan and will identify where to obtain information to assist you in developing that plan.

SESC Plan Requirements

Pursuant to Rule 1703 promulgated under Part 91, all SESC plans must contain, at a minimum, the following information:

1. Map (plan) with a scaled drawing of not more than 200 feet to the inch (or as required by the county or municipal enforcing agency) that includes:
 - a. A site location sketch;
 - b. The proximity of the proposed earth change to lakes and streams;
 - c. Predominant land features; and
 - d. Contour intervals or slope description.
2. A soils survey or written description of the soils of the anticipated exposed land area.
3. Details of the proposed earth change, including:
 - a. A description and the location of the physical limits of each proposed earth change;
 - b. A description and the location of all existing and proposed on-site drainage and dewatering facilities;
 - c. The timing and sequence of each proposed earth change;
 - d. The location and description for installing and removing all proposed temporary SESC measures;
 - e. A description and the location of all proposed permanent SESC measures;
 - f. A program proposal for the continued maintenance of all permanent SESC measures, including the person responsible for the maintenance.
4. Any other information required by the Part 91 agency that has jurisdiction over the project.

Much of the information required for developing an effective SESC plan can be obtained by visiting the site and by utilizing one or more of the following readily available information sources:

Information Sources

1. U.S. Geological Survey (USGS) Topographic Maps

The USGS maps, also known as quadrangle maps or topographic (topo) maps, are prepared by the USGS of the Department of the Interior. The maps are noted for their precision and accuracy, and present a wide variety of information showing both natural and human-made features. They display buildings, roads, ground surface elevations, lakes, streams, vegetative cover, slope features, and drainage patterns.

Availability

The USGS maps for Michigan may be purchased from the Michigan United Conservation Clubs in Lansing, Michigan Department of Natural Resources (MDNR) at <https://www.michigan.gov/dtmb/services/maps>, USGS at <http://www.usgs.gov/pubprod>, and at some local retail stores. The USGS provides a list, by state, of all businesses that sell USGS maps on their website. These maps can also be accessed on the Internet at <https://www.topozone.com/>.

USGS maps are available in many scales, such as: 1:250,000, 1:100,000, 1:62,500, 1:25,000, and 1:24,000. The scale represents a ratio of units on the map to units on the land surface. For example, a scale of 1:24,000 means that one inch on the map represents 24,000 inches (2,000 feet) along the land surface. Think of the ratio as a fraction: the smaller the second number or denominator (e.g., 24,000), the larger the fraction or scale of the map. Large scale maps (e.g. 1/24,000) show a smaller area and thus more detail than small scale maps (e.g. 1/250,000).

The 1:24,000 scale maps are available for all or most of Michigan and are the most detailed maps available from the USGS. One inch on the map equals 2000 feet. These maps are also referred to as 7.5 minute maps because they show an area that spans 7.5 minutes of latitude and 7.5 minutes of longitude. Because the lines that represent longitude are not parallel, the areas covered by the USGS maps are somewhat variable. In Michigan, the area covered by one 7.5 minute map ranges from 49.8 to 55.75 square miles; the average area is 53.3 square miles.

The 1:25,000 maps are very similar to the 1:24,000 scale maps but they are in metric units. On these maps one inch equals approximately 2,083 feet.

A useful conversion factor to remember when using ratio scales is that one-mile equals 63,360 inches. Using this conversion factor and the following calculations, a distance of 2.25 inches on a 1:24,000 scale map would equal 0.85 miles of land surface.

$$\begin{aligned} 2.25 \text{ inches} \times 24,000 \text{ inches/inch} &= 54,000 \text{ inches} \\ 54,000 \text{ inches (of land surface)} \text{ divided by } 63,360 \text{ inches/mile} &= 0.85 \text{ miles} \end{aligned}$$

One word of caution, when using ratio scales, such as 1:24,000, or other types of proportional scales, such as fractional (1/24,000) or narrative (e.g., one inch equals one mile), the scales become meaningless if the maps are reduced or enlarged in size. In contrast, graphic map scales, such as bar scales that resemble a segment of a ruler, remain valid when the maps are enlarged or reduced in size.

Interpretation

Because of the large number of symbols used on the USGS maps, it is not practical to print all of the symbols on each map. Therefore, the USGS has printed a separate brochure which describes the USGS map symbols. The brochure is available upon request when ordering USGS maps as well as on the USGS website.

The key to effectively using the USGS maps lies in understanding the contour lines depicted on the map. **Contour lines** connect points of equal surface elevation. When looked at as a whole, the contour lines provide a graphic representation of the terrain. The **contour interval** is the vertical distance between adjacent contour lines and is indicated on the margin of each map. Typical contour intervals are 10 or 20 feet; thus the vertical distance between the lines would be 10 and 20 feet respectively. Contour lines are important because they allow the user to determine the steepness and variability of slopes, site drainage patterns, and watershed boundaries.

Watershed Boundary Delineation

A watershed is defined as the area of land that drains to a given point. Precipitation falling within the watershed will evaporate, infiltrate into the soil, or run off. An accurate determination of the watershed boundary is necessary to estimate the amount of water flowing onto the site assessing potential impacts due to land use changes, and to evaluate pre-development and post-development runoff volumes.

Topographic maps are used to define the watershed boundary. Contour lines on the map indicate physical features such as hills, valleys, and ridges. Watercourses are shown in blue on USGS maps. The first step in defining the watershed boundary is to locate the point of interest (**design point**) and identify the streams, valleys, and hills, which slope toward that point. Water will flow downhill, perpendicular to the contour lines. The next step is to delineate the contributing drainage area by identifying the high elevation points with a line that starts and ends at the design point (Figure 4.4). If the line is drawn correctly, all precipitation falling within the boundary line will flow past the design point. Precipitation falling outside the boundary line will flow to another area.

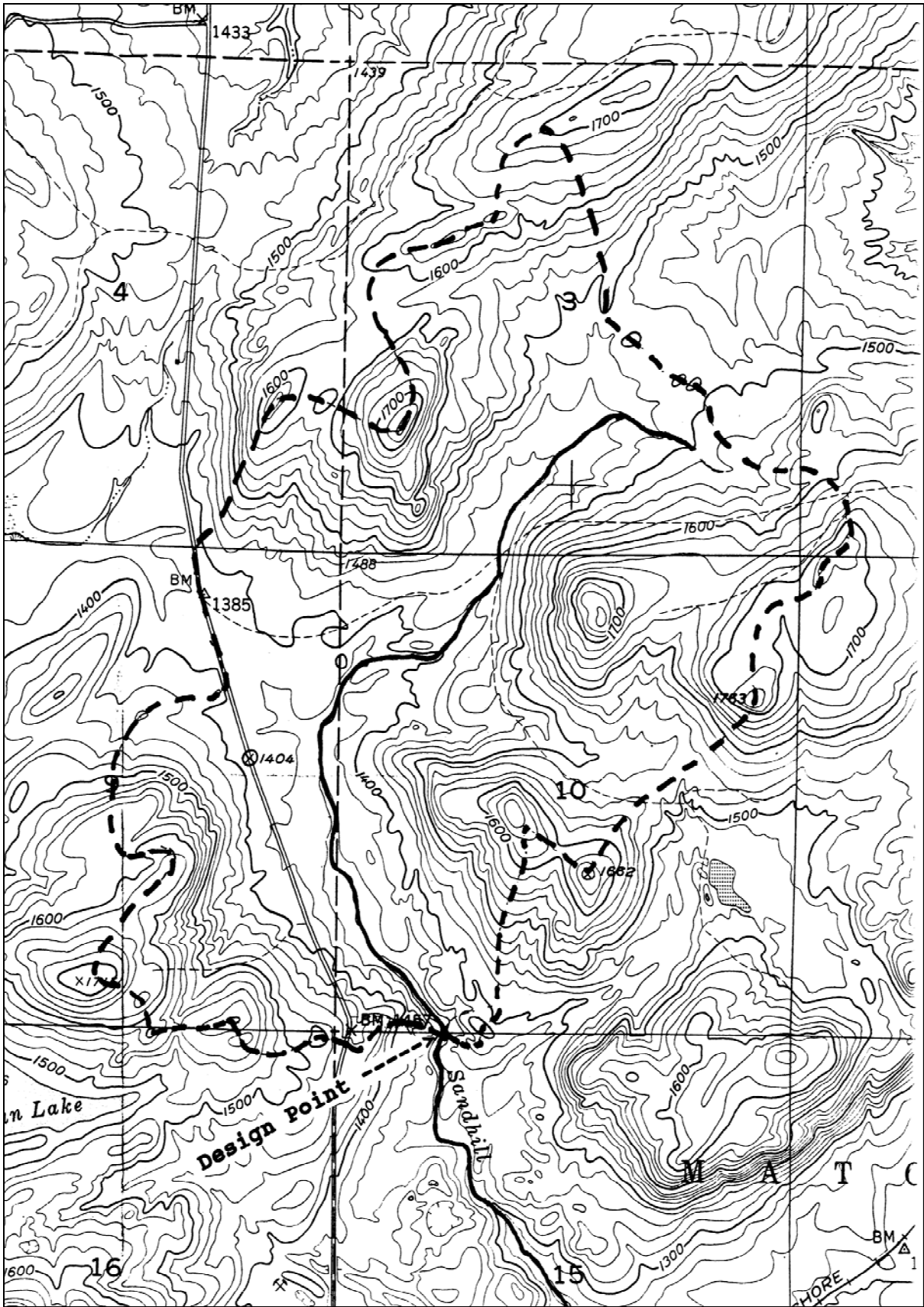

Figure 4-4: Watershed Boundary for the Upper Portion of Sandhill Creek

Limitations

- Check the date of map preparation, which is printed in the bottom right corner of most USGS maps. The date of preparation is important because the information concerning human-made features may be outdated in areas where considerable development has occurred. New roads or highways may modify the natural drainage patterns of an area and urban development may alter the flow characteristics of existing streams.
- The USGS topographic maps normally do not provide sufficient detail required for developing soil erosion and sedimentation control plans for specific sites. These maps, however, may be the only information available for planning long, corridor-type projects such as pipelines.
- The USGS topographic 1:24,000 scale maps for Michigan have contour intervals of 5 or 10 feet. Slopes significant enough to require soil erosion and sedimentation control measures may not always show up on a USGS topographic map; therefore, more detailed topographic surveys may be required.

2. Topographic Surveys

Topographic surveys provide very detailed information concerning the terrain of a specific area. These maps are generally prepared by a surveying or engineering firm. Aerial photographs or field surveys provide the basic data from which topographic maps are prepared. A topographic survey provides very detailed data about drainage patterns and slopes. Contour intervals on topographic surveys are generally 1-2 feet.

Availability

Unlike the USGS topographic maps that cover the entire state, topographic surveys are generally unavailable. Availability is limited to the sites for which the maps have been specifically prepared. In some instances, the following sources may have surveys available for adjacent areas:

- Local, state, and governmental agencies such as planning departments, road commissions, drain commissioners, and municipal engineering departments. For example, Oakland and Wayne counties have maps with 2-foot contours available for their respective counties.
- Private utility companies.
- Professional land surveyors or aerial surveying firms.

Scales

Topographic surveys are prepared at a scale comparable to the final scale of site plan drawings. Typically, they are drawn at scales between 1-inch equals 20 feet (1:240) to 1-inch equals 200 feet (1:2400).

Limitations

- Availability is limited.
- Topographic surveys generally identify only on-site information.
- Aerial photographs from which topographic maps are drawn can only be taken at certain times of the year, when the trees are free of foliage and the land surface is not covered by snow.

Slope Profiles

A **slope profile** is a side view of a selected land feature drawn to scale from contour line information (Figure 4-5). The profile will help visualize slope steepness and assist in selecting the most appropriate soil erosion and sedimentation control measures.

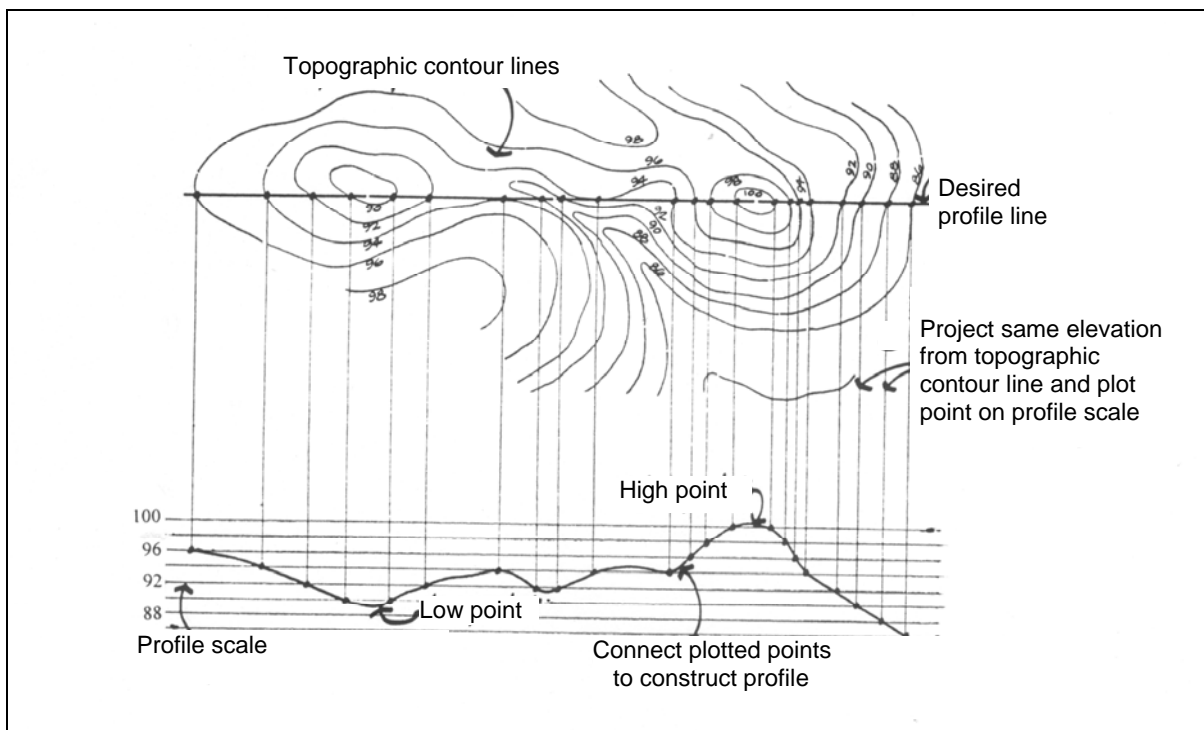

Figure 4-5: Slope Profile

Slope

The three common methods to express slope are as a ratio, a percent, or in degrees (Figure 4-6):

1. Ratio is an expression of a constant change between vertical and horizontal distances. Ratios are often used to describe relatively short and steep slopes such as cut and fill embankments. When using ratios, it is essential to know which number represents the vertical change and which number represents the horizontal change. For example, engineers usually express change in horizontal distance to a one-foot change in vertical distance; thus a 1 on 3 slope indicates that for every one-foot change in the vertical distance, there is a three-foot change in the horizontal distance. In contrast, the Natural Resources Conservation Service (NRCS) expresses change in vertical distance for a specified change in horizontal distance. Thus, the NRCS would express the above 1 on 3 slope as a "3 on 1" or "3:1" slope. To avoid confusion, the ratio should indicate the horizontal (h) and vertical (v) components; for example, 3h:1v or 3:1 (h/v).
2. Percent of slope is generally used to describe the steepness of constant, gradual slopes, and grades such as those found on road profiles and lawn areas. The percent of slope is determined by dividing the change in elevation by horizontal ground distance and multiplying by 100.
3. Degree of slope is an expression of angular measurement equal to the central angle of the circumference of a circle. Each degree represents 1/360 of the circumference of the circle.

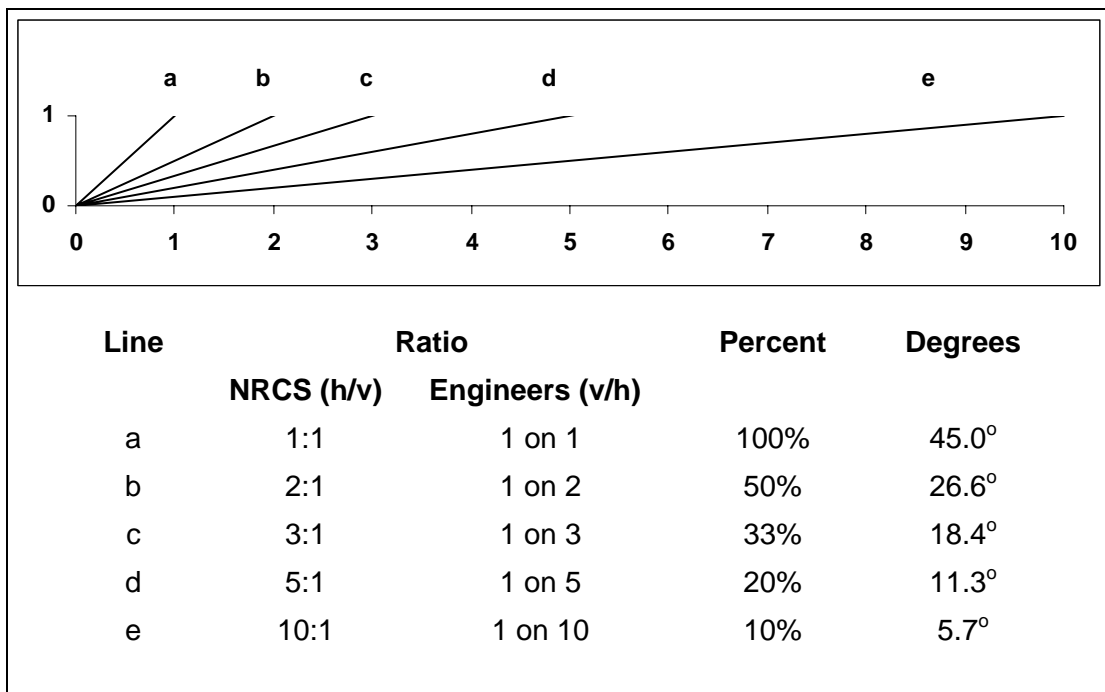

Figure 4-6

3. County Soil Surveys

Application to Soil Erosion and Sedimentation Control Planning

Soil surveys have three important components: soil maps, soil descriptions, and soil interpretations. Soil maps are superimposed on black and white aerial photographs. The maps are drawn by soil scientists and indicate the location of all the various soils found within the county. The delineated boundary for each soil type is called a soil map unit. Within the mapping units are symbols that identify the soil and the slope within the delineated area. Soil type is indexed either by an upper case and lower case letter or a number (Figure 4-7). Slope steepness is indicated by a capital letter that follows the soil index symbol. The symbols are defined within the soil survey. The soil maps also show drainage patterns.

Soil descriptions provide detailed information about the physical characteristics and make-up of each soil type found in the survey. Soil interpretations provide information that can be applied to the management of soil under different uses. Since soils vary so widely in their limitations and suitability for different uses, data contained in a soil survey are very useful when developing an effective SESC plan. For example, soil surveys describe the erodibility of each soil, general characteristics, and the cohesiveness of soil particles. These properties vary from one type of soil to another and within the different layers of the same soil profile. *Therefore, erosion potentials may be different in the same area, depending upon the depth of proposed grading or excavations.*

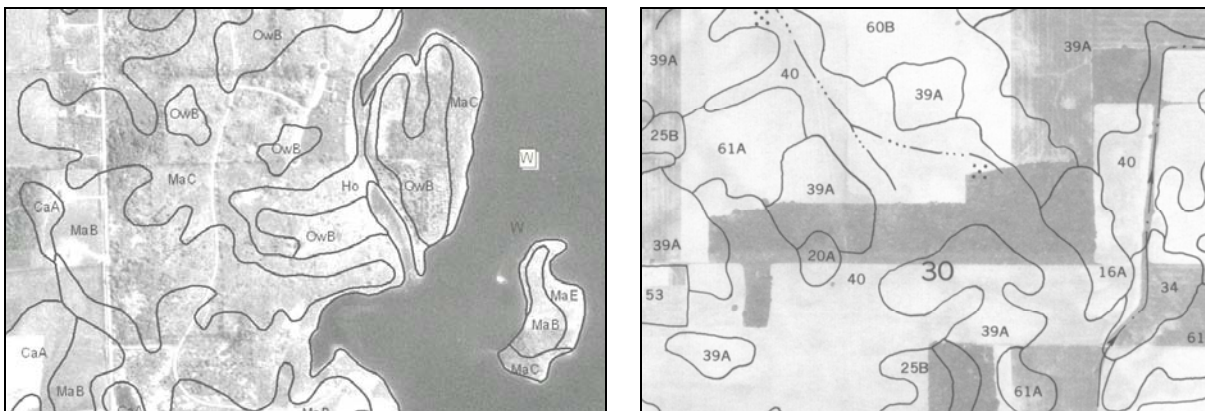

Figure 4-7: Typical Soil Surveys

Scales

Modern soil survey maps are generally prepared at a scale of 1:15,840, which translates to one-inch equals 1320 feet. This scale is considerably smaller than the scale at which site plans are prepared, but large enough to provide some meaningful information relevant to specific sites.

Availability

Modern soil surveys have been completed and are available for the 83 Michigan counties. In some counties, the soil surveys are available as a paper copy and for other counties they are on CDs. A complete listing of soils surveys can be found at <https://www.nrcs.usda.gov/conservation-basics/natural-resource-concerns/soil/soil-surveys-by-state>. You may also contact the local conservation district office for availability of soil surveys or soils information. A directory of conservation districts can be found at <https://www.macd.org/find-your-district>.

Effort is now underway to make the information available in digital form as well as in published form. To learn more about on-line soil maps visit the U.S. Department of Agriculture website at <https://www.nrcs.usda.gov/conservation-basics/natural-resource-concerns/soil>, look under “Programs and Services” then click on “Soil Surveys.”

Limitations

- Check the date of the survey preparation. Recent surveys contain considerably more information about construction and urban development than do older surveys. Older surveys have interpretations that apply, primarily to agricultural land use.
- The names and descriptions of soil series may vary from one county survey to another due to the age of the survey and the different levels of sophistication used in conducting the surveys. For instance, although a Miami soil type is the same wherever it is located, descriptions from a survey prepared 25 years ago may not have as much information as a recent, more detailed description. Since evaluation techniques have improved, the specific identification of soil series has become more precise.
- Caution should be exercised in transferring data from soil maps to larger scaled site plans. Small pockets or inclusions of differing soils within an area of one predominant soil series are not identified on soil maps. Application of soil survey data to very small sites may be misleading, since there is no way of knowing where such inclusions may be located. To resolve doubt, the applicant should furnish data from soil borings for questionable areas.

4. Aerial Photography

Aerial photographs are available for the entire state. The resolution, scale, and time of year that the photographs are taken vary depending on the needs of the agency taking the photographs. The MDNR has black and white photographs of the entire state which were taken during the summers of 1997, 1998, and 1999. Photographs can be purchased at the MDNR at <http://gis-midnr.opendata.arcgis.com/> or by calling 517-373-9123.

The Natural Resources Conservation Service’s Farm Service Agency (FSA) generally takes countywide aerial photographs annually during late spring or early

summer. More information regarding the FSA's photographs can be obtained by calling the local FSA office or the local conservation district office. Other possible sources of aerial photographs are local planning departments and private aerial survey companies.

Field Evaluations

A vast amount of valuable information can be assembled in the office for a particular site by analyzing aerial photographs, soil surveys, site-specific topographic maps, and USGS topographic maps. However, due to the varying age, scale, and availability of the maps and photographs, additional data is generally needed and existing information requires field verification. On-site field visits are required (or strongly encouraged) prior to or during the SESC plan development phase and also during the plan review phase.

1. On-Site Field Visits

On-site field visits are essential to verify the information gathered and to obtain information not available through map or photo interpretation. The plan developer or reviewer will be able to get a much better "feel" for the site and obtain detailed information on specific aspects needed for the SESC plan.

2. Techniques and Tools for Field Review

The ability to make basic field calculations will make any time spent during a site visit more valuable for the plan developer, as well as the plan reviewer, and could eliminate the necessity for additional site visits. Before leaving for a field inspection you should have all available information for the sites you intend to visit, develop your own average pace length, and gather a few simple and inexpensive tools that are necessary to adequately review most field situations.

Range Finder: Hand held range finders are very accurate and many of them will allow you to determine the slope as well as true horizontal distances.

Pacing: For measuring long distances, pacing is more effective than repeatedly setting the field tape. Pacing provides a reasonably accurate means of measuring distance. Although the exact distance covered by an individual in a given step may vary, each person should determine their own average pace length prior to going to the field, and use that length as a means of measuring approximate distances. The key to relatively accurate pacing is the proper use of a natural stride.

Hand Level: A sighting device with a level allows the user to pinpoint a specific elevation. This tool will provide a more accurate measurement of the slopes than those perceived by "eyeball" estimates, which often tend to be inaccurate.

Tape Measure: A tape of 100 or 200 feet in length, on a retractable reel, provides a precise measurement of distance. It is also useful to carry a small stake or pin that can be placed in the ground to secure one end of the tape while measuring.

Small Soil Auger or Shovel: A tool of this nature provides a means for examining subsoil characteristics.

3. Other Field Observation Techniques

Soil: Pick up some of the site's soil; is it sandy, silty, clayey, or loamy? Is the soil moist? How long has it been since it rained? Is it light or dark in color? Is all the soil on the site similar, or does it vary from one area to another?

Vegetation: Look around the site. What type of vegetation presently exists? Does the vegetation vary from one part of the site to another? Are there areas without vegetative cover?

Topography: Identify the general terrain features of the site. Which direction will the runoff flow? Where are the discharge points for storm water from the site? How steep are the steepest slopes? Using the tools described above, make the necessary calculations and write them down. Are there long uninterrupted slopes? Which portions of the site will be altered by construction activity? Identify active or obvious erosion areas such as slopes with rills or gullies, or slopes without vegetation.

4. Identification of Sensitive, Critical Erosion, and Other Areas

Identify sensitive areas such as lakes, streams, and wetlands that require special protection. It is violation of Parts 31 and 91 if sediment is discharged to the waters of the state or onto adjacent properties.

Identify critical erosion areas that are more susceptible to erosion or will be difficult to stabilize. Examples of critical erosion areas are:

1. Areas with steep slopes; the potential for erosion increases as the slope increases:

0-6 percent	low erosion hazard
7-12 percent	moderate erosion hazard
over 12 percent	high erosion hazard.

2. Areas with long slopes; erosion potential increases as the slope length increases. Slope lengths can be "shortened" by constructing terraces, benches, or diversions to break up the slope.
3. Areas with concentrated flows.
4. Areas with silty soils.

In addition to the above, other problematic areas or site conditions should be identified such as sandy or clay soils that may make establishing vegetation a real challenge. Also, sites with clay soils will generate much more runoff if not properly planned for and once in suspension, clay particles will not settle out in "typical" basins used on construction sites.

Developing a SESC Plan

After conducting the on-site field investigation and reviewing all possible information sources, it is time to develop the SESC plan. Rule 1703 promulgated under Part 91 serves as our guide to develop and effective SESC plan.

1. Site location map, legal description of property, and scaled map showing property boundaries (Figure 4-8).

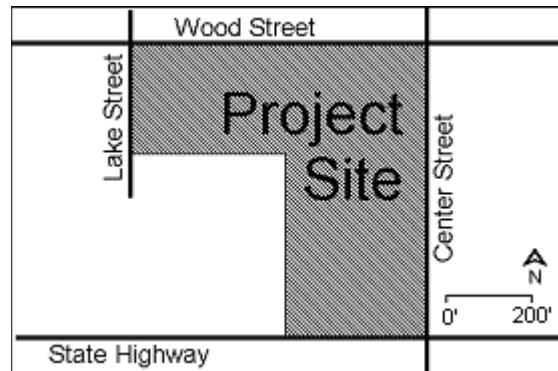

Figure 4-8: Location Map

2. The proximity of the earth change to lakes, streams, wetlands and other predominant land features (Figure 4-9).

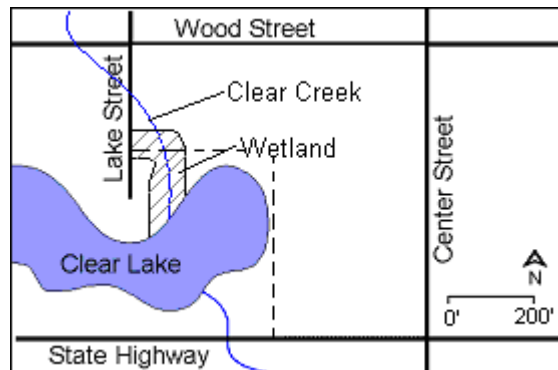

Figure 4-9

3. Description of on-site soils (Figure 4-10).

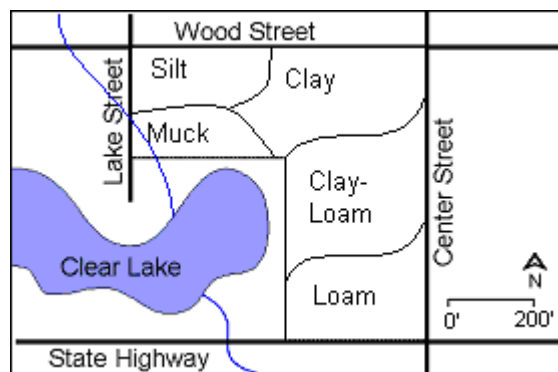

Figure 4-10

4. Existing and proposed elevations or slope description (Figures 4-11A and 4-11B).

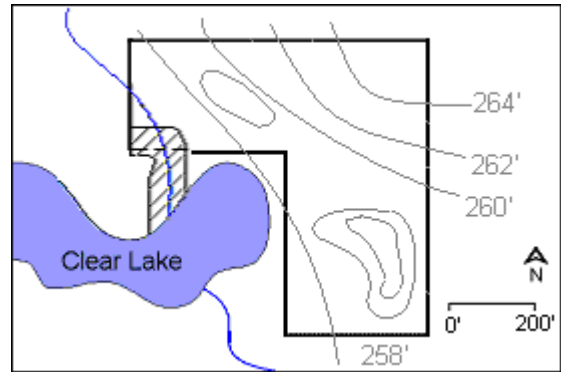
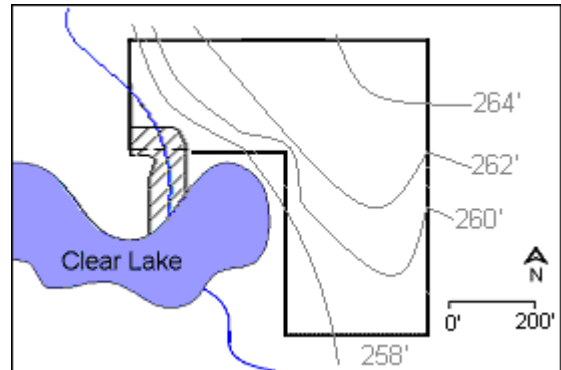

Figure 4-11A (existing)



Figures 4-11B (proposed)

5. Physical limits of the earth change (Figure 4-12).

6. A description of existing and proposed drainage and dewatering facilities.

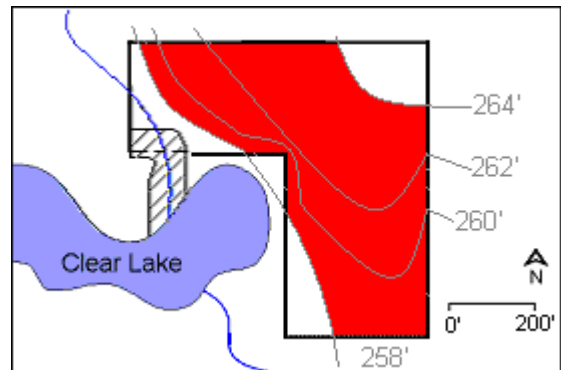

Figure 5-12

7. Timing and sequencing of earth change activities and implementation of SESC measures. (Figure 4-13; also see Appendix 4A or 4B.)

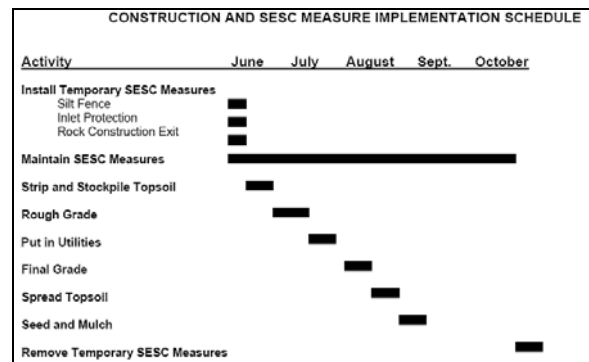

Figure 5-13

8. Description and location of all proposed temporary (Figure 4-14) and permanent SESC control measures.

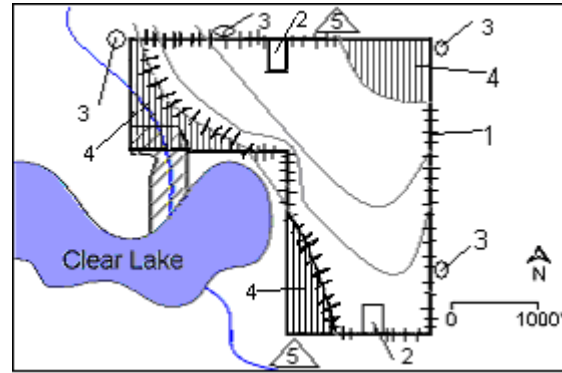

Figure 5-14

9. Proposal for continued maintenance of all permanent SESC measures.

SESC KEY		
Number	Control	Symbol
1	Silt Fence	+++++
2	Rock Construction Exit	□
3	Inlet Protection	○
4	Retain Existing Vegetation	
5	Daily Street Sweeping	△

(Key for Figure 4-14)

The location of all control measures should be identified on the SESC plan. If the material list specifies 200 feet of silt fence, the placement of the silt fence should be delineated on the plans. Similarly, if check dams are required in a roadside ditch, the relative locations of those check dams should be identified on the plan. Each control measure should be labeled on the plan, i.e., silt fence, check dam, etc. or identified by a symbol or code number such as found in the MDTMB's "SESC Keying System" (Figure 4-15) or the MDOT's "Applicable SESC Measures" (Figure 4-16). Both documents assign a number and symbol to each SESC measure. The SESC plan must indicate which of the keying systems is being used.

Department of Management and Budget		
S51	SILT FENCE	
S52	CATCH BASIN SEDIMENT GUARD	
S53	STABILIZED CONSTRUCTION ACCESS	

Figure 4-15

Department of Transportation		
36	CONSTRUCTION DAM	Used to create a dry or slack water area for construction. Protects the stream from raw erodible areas. Can be created out of any non-erodible materials such as SAND AND STONE BAGS (KEY 24), a gravel dike with clay core or plastic liner, steel plates or plywood.
37	CHECK DAM	Can be constructed across ditches or any area of concentrated flow. Protects vegetation in early stages of growth. A Check Dam is intended to reduce water velocities and capture sediment. A Check Dam is not a filtering device.

Figure 4-16

Another option is for the plan developer to create his or her own legend, such as the one depicted in Figure 4-14 above, using symbols or numbers to depict various control measures. If this option is used, the plan developer must also include details on how to install or maintain the specified SESC measures (Figure 4-17). If the the MDMB or MDOT manuals are used, installation details are provided for each of the suggested control measures.

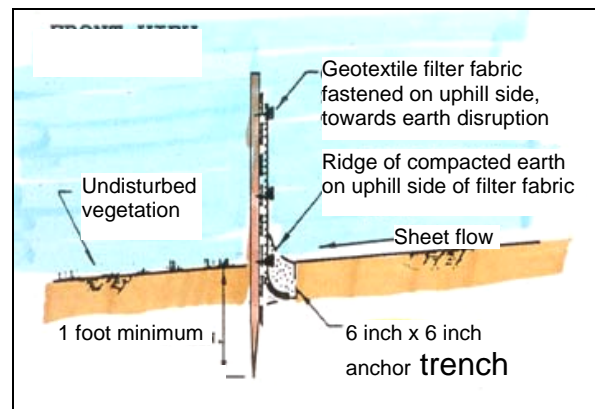

Figure 4-17

Plan Review

Various individuals are directly or indirectly responsible for reviewing SESC plans and should make use of any and all available information from the various resources discussed above. Those individuals that have some role in reviewing plans include:

1. The person developing the plan is responsible for ensuring that the plan complies with the requirements of Part 91, i.e., it contains information required in Rule 1703, accurately depicts site conditions, and the prescribed control measures will effectively control erosion and off-site sedimentation.
2. The person (or persons) employed by the county or municipal enforcing agency or Authorized Public Agency who has completed the Comprehensive SESC training (not just the Inspector training) is responsible for reviewing and approving the submitted SESC plans in detail to ensure that the plans contain all the information required in Rule 1703 and that the prescribed control measures will effectively control erosion and off-site sedimentation. The person responsible for reviewing and approving the plans should utilize all available resources such as topographic maps, soils maps, and BMP manuals or standards and specifications to assess the accuracy of the submitted plans in regards to site conditions and prescribed control measures. In most, if not all instances, the site conditions presented on the SESC plans should be verified by visiting the site. If on-site conditions depicted on the SESC plan do not correlate with conditions indicated in the various reference sources or found on site by the plan reviewer, the plan should be returned to the plan developer for revision. The same is true in regards to the prescribed SESC measures, if the control measures will not effectively control erosion or off-site sedimentation, the plans should be returned for revision.

Inspections

Each project must be inspected (and the inspections documented) by a person or persons trained under Parts 31 and 91 for ensuring that control measures are installed and maintained per the approved plan. (See Unit 5 for more information on Part 31 and 91 inspections). The inspector must have a working knowledge of current soil erosion and sedimentation control techniques, SESC plan requirements, permit conditions, and know when control measures are not effective

A pre-construction meeting between the inspector, permittee, contractor, project engineer, and the SESC Agent can eliminate many potential problems. The meeting provides an opportunity for all involved parties to discuss what is expected and to clarify items that are unclear or missing in the plan.

During construction, temporary SESC measures must be maintained daily. If a silt fence has been damaged or has failed, it must be repaired or replaced immediately (Figure 4-18). When sedimentation traps become filled with sediment, they must be cleaned out (Figure 4-19).



Figure 4-18



Figure 4-19

In addition to the inspections performed weekly and after every storm event by the permittee (certified storm water operator) the SESC Inspector (employed by the Part 91 agency) must regularly inspect the site to ensure that it is complying with the SESC plan, and permit conditions or approved SESC procedures and that all activities conform to the approved plan and the objectives of Part 91. The SESC Inspector can objectively evaluate the total performance of the soil erosion and sedimentation control efforts on the site.

Inspections by the SESC Inspector should be both scheduled and unscheduled. If time allows, inspections should be performed weekly. If it is not feasible to conduct weekly inspections, inspections should be done prior to or upon commencement of the earth change to ensure that temporary SESC controls are in place and

during dry periods, and must be planned for accordingly. In contrast, more emphasis must be placed on preventing wind erosion during the dry season.

- Be certain that adequate soil erosion and sedimentation control measures are installed and maintained for all earth change areas. The controls must minimize on-site erosion, off-site sedimentation, and reduce all runoff leaving the site to non-erosive velocities.
- Temporary control measures should be installed and functional prior to starting the earth change. Permanent measures should be installed as early as possible in the construction schedule but always within 5 days after reaching final grade. . This involves stabilizing "small" areas as they are completed, instead of waiting until all construction is completed before installing permanent controls.

Summary

No single source of information is likely to contain all the data needed to develop or evaluate a proposed soil erosion and sedimentation control plan. Information from several sources such as the USGS topographic maps, site-specific topographic maps, county soil surveys, and aerial photographs must be examined and verified through site inspection. Site inspections will help the plan developer and the reviewer get a "feel" for the site and can be used as a opportunity to identify potential problem areas and choose specific control measures.

Effective administration of the county or local program is critical for controlling soil erosion and off-site sedimentation resulting from earth change activities. It documents the basic process by which soil erosion and sedimentation control is addressed in a logical and systematic sequence. The SESC Agent's responsibility is to assure consistent program administration and compliance with Part 91. A clear understanding of these roles and responsibilities is necessary in developing a successful permit issuance system.

The permit issued by the SESC Agent to the permittee is a legal document which authorizes an earth change, provided that the soil erosion and sedimentation control plan is followed. In the end, the burden for protecting the environment and the control of soil erosion and sedimentation is placed on the permittee.

In summary it is important to remember that effective erosion and sedimentation control begins with a carefully developed soil erosion and sedimentation control plan. An effective plan results from a thorough site planning process. The first two steps of site planning are the:

- Inventory
- Analysis

The inventory includes mapping soils, topography, vegetation, and drainage information. Analysis is the interpretation of how that information will influence soil erosion and sedimentation control.

Key people responsible for preventing erosion and off-site sedimentation are:

- Planner or designer who develops the site plan and the soil erosion and sedimentation control plan (Figure 4-22)



Figure 4-22

- Contractor's foreman, inspector, or project engineer who is responsible for installing and maintaining all control measures (Figure 4-23)



Figure 4-23

- Soil erosion agency personnel who inspect the site to ensure that control measures are adequate and are being maintained (Figure 4-24)



Figure 4-24

UNIT FOUR REVIEW

1. Soil erosion prevention and sedimentation control requires thoughtful _____ to be effective.
2. A SESC permit and plan is required, at a minimum for all earth changes that disturb _____ or more acres or that are located within _____ feet of the water's edge of a _____ or _____.
3. It is the responsibility of the permit applicant to develop (or hire someone to develop) a _____ - _____ SESC plan.
4. SESC plans must contain specific information. In regards to SESC measures, the _____ and description for installing and removing all proposed temporary SESC measures must be included as well as the _____ and location of all proposed permanent SESC measures must be shown on the plan.
5. USGS maps are also known as _____ maps or _____ maps.
6. _____ lines connect points of equal surface elevations.
7. The contour _____ is the vertical distance between adjacent contour lines on the map.
8. A _____ is defined as the area of land that drains to a given point.
9. The three common ways to express slope on a plan or map are as a _____, a _____ or in _____.
10. _____ provides a reasonably accurate means of measuring distance.
11. Sensitive areas include such things as _____, _____ and _____ that require special protection.
12. Critical erosion areas are areas that are more _____ to erosion or will be _____ to stabilize.
13. Each project must be _____ (and the inspections _____) by a person trained under Part 31 and 91.
14. A _____ - _____ meeting between the inspector, permittee, contractor, project engineer, and the SESC agent can eliminate many potential problems.
15. During construction, temporary SESC measures must be _____ daily.

16. Inspections by the SESC inspector should be both _____ and _____.
17. If the project is not completed and permanently stabilized before fall, ensure that _____ measures are in place and _____ throughout the winter.
18. SESC controls must minimize on-site _____, off-site _____, and reduce all _____ leaving the site to ____-_____ velocities.
19. Temporary control measures should be _____ and _____ prior to starting the earth change.
20. Permanent control measures should be installed as early as _____ in the construction schedule and always with ____ days after reaching final grade.

ANSWERS TO UNIT FOUR REVIEW

1. Soil erosion prevention and sedimentation control requires thoughtful **planning** to be effective.
2. A SESC permit and plan is required, at a minimum for all earth changes that disturb **one** or more acres or that are located within **500** feet of the water's edge of a **lake** or **stream**.
3. It is the responsibility of the permit applicant to develop (or hire someone to develop) a **site-specific** SESC plan.
4. SESC plans must contain specific information. In regards to SESC measures, the **location** and description for installing and removing all proposed temporary SESC measures must be included as well as the **description** and location of all proposed permanent SESC measures must be shown on the plan.
5. USGS maps are also known as **quadrangle** maps or **topographic** maps.
6. **Contour** lines connect points of equal surface elevations.
7. The contour **interval** is the vertical distance between adjacent contour lines on the map.
8. A **watershed** is defined as the area of land that drains to a given point.
9. The three common ways to express slope on a plan or map are as a **ratio**, a **percent**, or in **degrees**.
10. **Pacing** provides a reasonably accurate means of measuring distance.
11. Sensitive areas include such things as **lakes**, **streams**, and **wetlands** that require special protection.
12. Critical erosion areas are areas that are more **susceptible** to erosion or will be **difficult** to stabilize.
13. Each project must be **inspected** (and the inspections **documented**) by a person trained under Part 31 and 91.
14. A **pre-construction** meeting between the inspector, permittee, contractor, project engineer, and the SESC agent can eliminate many potential problems.
15. During construction, temporary SESC measures must be **maintained** daily.

16. Inspections by the SESC inspector should be both **scheduled** and **unscheduled**.
17. If the project is not completed and permanently stabilized before fall, ensure that **temporary** measures are in place and **inspected** throughout the winter.
18. SESC controls must minimize on-site **erosion**, off-site **sedimentation**, and reduce all **runoff** leaving the site to **non-erosive** velocities.
19. Temporary control measures should be **installed** and **functional** prior to starting the earth change.
20. Permanent control measures should be installed as early as **possible** in the construction schedule and always with **5** days after reaching final grade.

CONSTRUCTION AND SESC MEASURE INSTALLATION SCHEDULE FOR SMALL PROJECTS

Beginning Date: _____ Ending Date: _____

Activity

Week 1 Week 2 Week 3 Week 4 Week 5 Week 6 Week 7 Week 8

Identify Earth Change Limits.....

Protect Buffer Areas

Install Temporary SESC Measures such as:

a. Perimeter Silt Fence

b. Inlet Protection

c. _____

Strip and Protect Topsoil

Rough Grade

Excavate and Construct Footings.....

Construct Superstructure.....

Final Grade

Spread Topsoil, Seed and Mulch or Sod

Install Permanent SESC Measures, such as:

a. _____

b. _____

Remove Temporary SESC Measures

(After site is stabilized)

(Connect dots to show time line)

CONSTRUCTION AND SESC MEASURE INSTALLATION SCHEDULE FOR LARGE PROJECTS

<u>Activity</u>	<u>Jan</u>	<u>Feb</u>	<u>Mar</u>	<u>Apr</u>	<u>May</u>	<u>Jun</u>	<u>Jul</u>	<u>Aug</u>	<u>Sep</u>	<u>Oct</u>	<u>Nov</u>	<u>Dec</u>
Conduct Pre-Construction Meeting.....												
Establish Contract Limits												
Identify and Protect Critical Areas and Filter Strips.....												
Install Temporary SESC Measures such as:												
a. Diversions (stabilize before use)												
b. Sediment Basins (stabilize before use).....												
c. Perimeter silt fence.....												
d. Inlet Protection												
e. _____												
Inspect and Maintain all SESC Measures.....												
Strip and Protect Topsoil (stage activity).....												
Rough Grade (stage activity)												
Construct Aggregate Access Road(s).....												
Street Sweeping.....												
Excavate and Construct Footings/Basement.....												
Temporary Seed & Mulch/Erosion Control Blankets (ECBs)												
Install Utilities												
Final Grade (stage activity)												
Spread Topsoil and Immediately Seed & Mulch or Sod..... (Use ECBs, netting, etc. per plan)												
Install Permanent SESC Measures such as:												
a. _____												
b. _____												
c. _____												
Construct Superstructure												
Parking Lot Surfacing.....												
Remove Temporary SESC Measures..... (After site is stabilized)												

(Connect dots to show time line)

Unit Five

LAWS, RULES, and INSPECTIONS PERTINENT TO CSW/SESC INSPECTORS

Federal Laws

The Federal Clean Water Act (CWA) prohibits the discharge of any pollutant to navigable waters from a point source unless the discharge is authorized by a National Pollutant Discharge Elimination System (NPDES) permit. Furthermore, the 1987 amendments to the CWA recognized that storm water runoff was a significant source of water pollution. Thus, in the 1987 CWA amendments, Congress directed the United States Environmental Protection Agency (EPA) to develop regulations requiring permits for storm water discharges.

In 1990, in response to the 1987 CWA amendments, the EPA published its final rules for the NPDES Permit Program governing storm water. The program was to be implemented in two phases; the first phase, implemented in 1992, addressed sources of storm water runoff from designated groups, including construction activities disturbing five or more acres of land that have a direct discharge to waters of the state. In March, 2003, the Phase II NPDES Storm Water Program took effect, which lowered the size of regulated construction activities from five acres to one acre.

Administration of the NPDES Storm Water Program in Michigan was delegated to the Michigan Department of Environmental Quality (MDEQ).

State Laws

In 1994, the state legislature codified all state environmental laws into one, all inclusive statute known as the Natural Resources and Environmental Protection Act, 1994 PA 451, as amended (NREPA). The MDEQ utilizes two parts of the NREPA to comply with the requirements of the federal construction storm water program; they are Parts 91 and 31 and the rules promulgated under those parts.

1. Part 91, Soil Erosion and Sedimentation Control (SESC), of the NREPA (Appendices 6A and 6B).

Part 91 regulates soil erosion and off-site sedimentation from earth change activities. The primary goal of Part 91 is to protect adjacent properties and the waters of the state (lakes, streams, and wetlands regulated by Part 303, Wetlands Protection, of the NREPA) from sediment generated from unchecked erosion. Part 91 permits are generally required for any earth change that disturbs one or more acres of land or that is within 500 feet of the water's edge of a lake or stream. Permits must be issued to the landowner or easement holder.

Some earth change activities are exempt under Part 91 and do not require SESC permits. The exempted activities include, but not limited to, plowing and tilling for crop production, gas and oil exploration and development activities, earth changes that are stabilized within 24 hours of the initial earth disturbance, and some logging and mining

activities. Access roads to and from logging and mining sites; ancillary activities associated with logging and mining; and the removal of sand, gravel, clay, peat, or topsoil; are not included in the logging and mining exemptions and require SESC permits. Specific exemptions are identified in Sections 9115 and 9115a of Part 91 and in Rule 323.1705. Regardless if a permit is required or not, exempted activities are not exempt from enforcement actions authorized under Part 91 if the exempted activities result in a violation of Part 91.

Part 91 Agencies

The following agencies have responsibility for administering and enforcing Part 91 throughout the state:

1. Counties are required by statute to administer and enforce Part 91. The County Board of Commissioners of each county must designate an agency, referred to as a County Enforcing Agency (**CEA**), to be responsible for administering and enforcing Part 91 within the county. The county can administer its Part 91 SESC Program via a resolution or a SESC ordinance; both must be approved by the MDEQ. If the county opts to administer its SESC Program by resolution, the county cannot require anything other than what is authorized in Part 91 and the Rules; whereas, if the county adopts a SESC ordinance, the program can be more restrictive than what is authorized by Part 91 and the Rules. The CEA is responsible to review SESC applications and plans, issue permits, inspect the permitted sites, and take any necessary compliance and enforcement actions to ensure that the sites remain in compliance with Part 91 and the Rules.
2. A municipality (defined as a city, village, charter township, and general law townships in counties with a population of 200,000 or more) may elect to administer and enforce its own SESC Program. In order for the municipality to administer its own program, the municipality must adopt a SESC ordinance and designate an agency, referred to as a Municipal Enforcing Agency (**MEA**), to administer and enforce Part 91 within the municipality. Upon approval of the ordinance by the MDEQ and designation as an MEA, the CEA no longer has authority to administer and enforce Part 91 within the municipality. The MEA assumes the same responsibilities that the CEA previously had in regards to plan review, permit issuance, inspections, and compliance and enforcement actions.
3. State, county, and municipal agencies that undertake earth change activities may apply to the MDEQ for designation as an Authorized Public Agency (**APA**). To be designated an APA, the agency must submit SESC procedures to the MDEQ that detail how it will minimize erosion and off-site sedimentation while undertaking earth change activities. Upon approval of the SESC procedures by the MDEQ and designation as an APA, the agency no longer has to apply to the CEA or MEA for SESC permits. It is the responsibility of the APA to develop SESC plans, implement the plans, conduct inspections, and take any necessary compliance and enforcement actions to ensure all sites are in compliance with Part 91 and the approved SESC procedures. The CEAs and MEAs have no oversight responsibility for APA projects; it is the responsibility of

the MDEQ to ensure that the APAs comply with Part 91 and their approved SESC procedures.

Part 91 Inspections, Inspection Frequency, and Documentation

Regardless if a project is permitted by a CEA or MEA or undertaken by an APA, the person conducting the inspections on behalf of the Part 91 agency must complete the SESC training required in Section 9123 of Part 91. Inspectors can be agency employees or contract employees. The inspector must be familiar with the project site, the SESC plan requirements, installation and maintenance details for the required SESC measures, and the requirements of Part 91, the Rules, and applicable SESC ordinance or APA SESC procedures.

The Part 91 inspector must regularly inspect (based on criteria and schedule determined by the Part 91 agency) the entire project site to determine if the SESC measures are properly installed and maintained in accordance with the SESC plan and if the SESC measures are effective in minimizing erosion and off-site sedimentation. Inspections should be conducted, at a minimum, just before or after earth work begins to ensure that temporary SESC measures are in place and functioning, routinely throughout the project during major changes in work activity, after major rainfall or snowmelt events, and prior to closing out the permit (or APA project) to ensure that the site is stabilized and completed in accordance with the SESC plan and permit conditions. It is recommended that the CEA or MEA inspect the proposed project site prior to issuing the permit; however, that inspection should be conducted by the agency person responsible for developing or approving the SESC plan and issuing the SESC permit.

All observations (good or bad) made during the inspections and any necessary corrective actions and timeframes to make those corrections, must be documented on an inspection report form such as the one provided in Appendix 5B. A copy of the inspection report should be given to the on-site person responsible for the project or mailed to the permittee.

In addition to verifying that prescribed SESC measures are properly installed and maintained, the inspector should continuously be looking for potential problems that may occur on the site during the next strong wind, rainfall, or snowmelt event. It is much more effective to prevent a sediment discharge from happening than fixing the problem after it occurs and damage is done. In other words, the inspector should be **proactive** and anticipate problems, not wait and react to problems after they occur. If corrective actions are necessary that require revisions to the approved plan or permit conditions, a copy of the inspection report must also be forwarded to the Part 91 agency staff person responsible for approving/developing the original SESC plan and/or issuing the SESC permit. Once the appropriate revisions are identified and/or made, the agency staff person shall forward copies of the revised plan and/or permit to the permittee and to the inspector.

If corrective actions are required, the Part 91 inspector must conduct timely follow-up inspections which coincide with the timeframes set forth in the inspection reports to ensure compliance with the requested corrective actions. "Timely" is a relative term and can range anywhere from immediately for discharges to the waters of the state, to 24 hours for "minor" maintenance issues to up to five days for corrections requiring major plan revisions and/or significant adjustments to existing SESC measures. The potential for resource damage would also influence the amount of time allowed to make the necessary corrective actions. Any time there is a discharge or a potential discharge of sediment to the waters of the state, corrective actions and follow-up inspections should be done immediately to within 24 hours of discovery. Rule 1709(4) requires that SESC measures be maintained on a daily basis. Therefore, the timeframe required for complying with general maintenance items or other minor adjustments should be no more than 24 hours; by the end of the work day is preferable. For other more substantial corrective actions, the maximum allowable time by law to comply is 5 days after notification (Section 9118 of Part 91). If corrective actions are not completed within the specified timeframes, the inspector should proceed in accordance with the Part 91 agency's compliance and enforcement procedures or guidelines.

Note: *Just because the inspector gives the permittee a specified time to correct a problem, the permittee is still liable for any sediment discharge and damage that may occur during that time.*

Part 91 Inspector Responsibilities

Regardless if the project is permitted by a CEA or MEA or undertaken by an APA, it is the responsibility of the Part 91 inspector to ensure that the permittee (or APA) complies with Part 91, the Rules, applicable SESC ordinance or SESC procedures, approved plans, and permit conditions. Part 91 inspectors are responsible for ensuring or verifying that:

- 1) Earth changes observed (when traveling to perform inspections) that require SESC permits, have SESC permits.
- 2) SESC permits are posted on site and the approved SESC plans are available on site.
- 3) Inspections (and follow-up inspections) are done in a manner and frequency to assure minimization of erosion and off-site sedimentation. This requires inspecting the entire permitted site, not just those areas that are easily accessible.
- 4) Inspections are properly documented.
- 5) SESC measures are properly installed and maintained per standard details or plan specifications and are effective. In addition, the inspector must be **proactive** and anticipate or assess potential problems that may occur as the site or weather conditions change instead of reacting to problems as they arise.

Note: *If being proactive requires that additional controls, not specified on the original plan, be installed on the site, the inspector must seek assistance from the person responsible for approving the plan if the inspector has only completed the Inspector Training and not the complete SESC training.*

- 6) Sediment caused by accelerated erosion does not leave the project site or discharge to waters of the state located within or off the site.
- 7) Water discharged from the site is at nonerosive velocities.
- 8) Temporary SESC measures are installed before or upon (not after) the commencement of the earth change activity.
- 9) Temporary SESC measures are maintained on a daily basis.
- 10) Permanent SESC measures are installed on all slopes, channels, ditches, or any disturbed land within 5 calendar days after final grading or the final earth change has been completed.
- 11) Projects (permitted or APA) are not closed out until the site is stabilized and the temporary SESC measures are removed. Stabilization is defined in the Rule 1701 as *the establishment of vegetation or proper placement, grading, or covering of soil to ensure its resistance to soil erosion, sliding, or other movement.*
- 12) Compliance and enforcement actions are taken in accordance with the Part 91 agency's compliance and enforcement procedures or guidelines, Part 91, and the Rules.

Any violation of Part 91, the Rules, applicable SESC ordinance, approved SESC procedures, approved SESC plans or SESC permit conditions subjects the permittee or APA to fines and penalties of up to \$25,000 per day of violation. In addition, lack of adequate inspections or compliance and enforcement actions can result in CEAs being placed on probation and MEAs and APAs having their Part 91 agency designation revoked.

2. Part 31, Water Resources Protection, of the NREPA

The primary goal of Part 31 is to protect and conserve the waters of the state. This includes the prohibition of pollution of the waters of the state and any obstruction or occupation of floodways. The Part 31 definition of waters of the state is much broader than the Part 91 definition; it includes all surface water and groundwater in the state, regardless of size.

Permit-by-Rule Promulgated Under Part 31 (Appendix 5A)

In response to the federal storm water regulations, the MDEQ developed administrative rules (Permit-by-Rule) under the authority of Part 31 to permit storm water discharges from construction activities. Storm water permits are required for any construction activity that disturbs one or more acres of land and has a point source discharge to the surface waters of the state. A point source discharge is defined as a “*discharge that is released to the waters of the state by a discernable, confined, and discrete conveyance, including any of the following from which wastewater is or may be discharged: a pipe, a ditch, a channel, a conduit...*” Point source discharge also includes any runoff as a result of grading, regardless if it is sheet flow or concentrated flow.

Permit-by-Rule makes full use of Part 91 and avoids a double permitting situation. Prior to receiving authorization to discharge storm water, the applicant must first obtain coverage under Part 91 by securing: 1) an SESC permit from the appropriate CEA or MEA; 2) being designated an APA and having a site specific SESC plan for the project; or 3) securing permits under Part 615, Supervisor of Wells or Part 631, Reclamation of Mining Lands, of the NREPA. Under Permit-by-Rule, the permittee must be the landowner or easement holder.

Permit-by-Rule provides automatic storm water permit coverage for construction sites that disturb 1-5 acres with a point source discharge to the surface waters of the state, as long as the landowner has coverage under Part 91. No storm water application or permit fee is required for the 1-5 five acre sites; however, the permittee must comply with the requirements of Permit-by-Rule. Storm water coverage begins immediately upon obtaining the Part 91 coverage.

Owners of projects that disturb 5 acres or more of land that have a point source discharge to surface waters of the state must submit a Notice of Coverage (NOC) to the WB to receive coverage under Permit-by-Rule (Appendix 5C). In addition to the NOC, the landowner must also include a copy of the SESC permit (if not an APA), the SESC plan, a site location map, and appropriate application fee (\$400 in 2008). Coverage begins immediately upon the MDEQ receiving a complete NOC, application fee, and other required documentation. Similar to the owners of the 1-5 acre sites, the permittee must comply with the requirements of Permit-by-Rule.

Permit-by-Rule Requirements

All permittees authorized to discharge storm water under Permit-by-Rule shall comply with the following:

- 1) Not directly or indirectly discharge any substance into the waters of the state in violation of Act 451(NREPA), Part 31 or the rules promulgated there under, such as Section 3109, which includes substances that are or may become injurious to any of the following:
 - a) To the public health, safety, or welfare.

- b) To domestic, commercial, industrial, agricultural, recreational, or other uses that are being made or may be made of such waters.
 - c) To the value or utility of riparian lands.
 - d) To livestock, wild animals, birds, fish, aquatic life, or plants, or to the growth, propagation, or the growth or propagation thereof be prevented or injuriously affected; or whereby the value of fish and game is or may be destroyed or impaired.
- 2) Be in compliance with the SESC permit for the site or, if the construction activity is carried out by an APA, the approved control plan, including the selected control measures that are applicable to the site.
 - 3) Properly maintain and operate the SESC measures.
 - 4) Have the SESC measures under the specific supervision and control of a storm water operator who has been certified by the MDEQ as properly qualified to operate the SESC measures.
 - 5) Cause the construction site to be inspected by a certified storm water operator once per week and within 24 hours after precipitation events that result in a discharge from the site, and ensure that any needed corrective actions are carried out. A log of the inspections and corrective actions shall be maintained on file by the permittee for review and shall be retained for a period of three years from the date of the inspection or corrective action.
 - 6) Be in accordance with the requirements for on-land facilities as set forth in spillage of oil and pollution materials, being Part 5 of these rules, the permittee provide facilities and comply with reporting procedures for containment of any accidental losses of oil or other pollution materials.
 - 7) Dispose of solids, sediment, filter backwash, or other wastes that are removed from or results from the treatment of control of storm water in compliance with applicable state laws and regulations, and in a manner that prevents any waste from entering surface waters of the state.
 - 8) Allow the MDEQ to enter upon the site at any reasonable time before the expiration of the authorization to discharge as set forth in Subrule (5) of this rule, upon presentation of credentials and other documents as may be required by law, for the purpose of inspecting conditions relating to the pollution of any waters or determining compliance with the provisions of this rule.
 - 9) Upon request, make available for public inspection or provide to the MDEQ all reports or logs prepared pursuant to the provisions of this rule.
 - 10) File a revised NOC before any expansion of the construction activity or change in the SESC measures that require a change in the SESC permit. **Note:** *The*

NOC automatically expires when the SESC permit expires so if the SESC permit will expire before the site is stabilized, both the SESC permit and NOC must be extended before they expire or the permittee will have to reapply for a new NOC. Extension or modification of the NOC must be done using the “Notice of Coverage Renewal” form (Appendix 5D).

Any violation of the terms and conditions of Permit-by-Rule is a violation of Section 3115 of Part 31 and subjects the permittee to fines and penalties of up to \$25,000 per day of violation.

Certified Storm Water Operator

A certified storm water operator can be any person who has a training certificate issued by the MDEQ pursuant to the provisions of Section 3110 of Part 31. Typically, the certified storm water operator is a staff person of the APA, a consultant, or the permittee. The primary difference between the Part 91 inspector and the certified storm water operator is that the Part 91 inspector is employed (staff or contract employee) by the Part 91 agency to oversee permitted (or APA) projects to ensure they are in compliance with Part 91; whereas, the certified storm water operator is the permittee, or employed by the permittee, to assist the permittee in complying with the requirements of Permit-by-Rule.

Although the permittee is ultimately responsible for complying with the requirements of Permit-by-Rule, the permittee relies on the certified storm water operator for assistance in meeting some or all of the Permit-by-Rule requirements. Prior to conducting the inspections, the certified storm water operator should meet with the permittee so they have a clear understanding of which of the above Permit-by-Rule requirements he/she is responsible for and who is responsible for the other requirements. Some certified storm water operators may be responsible for ensuring compliance with all 10 items; whereas, others may only be responsible for Items 2-5. There should also be a clear understanding regarding what authority the certified storm water operator has, or does not have, when it is necessary to take preventive or corrective actions to ensure compliance with Permit-by-Rule. Some certified storm water operators may be given complete authority to do whatever is necessary to ensure compliance with Permit-by-Rule; whereas, others may only have authority to inspect and report findings to the permittee or some other specified individual.

Permit by Rule Inspections, Inspection Frequency, and Documentation

Certified storm water operators are required to inspect all construction sites once per week and within 24 hours of a precipitation event that results in a discharge from the site. These inspections are conducted to ensure that SESC measures are properly installed and maintained and appropriate for the site conditions. When conducting the inspections, the entire site must be inspected, not just at the locations of the prescribed SESC measures. It is the duty of the certified storm water operator to keep the permittee informed of problems, potential problems, and necessary corrective actions.

An important part of the certified storm water operator's responsibility is to know how to properly install and maintain the SESC measures identified on the plans. All construction plans should identify the location of all prescribed SESC measures. One method of denoting the SESC measures is to write the names of each control on the plan where they are to be located; another more common method is to use a number, symbol, or other unique descriptor that represents a specific SESC measure. It is also equally important that the certified storm water operator know the sequence of when each control measure should be installed and removed. Being familiar with the construction plans, the requirements of Permit-by-Rule and expectations of the permittee will make the certified storm water operator's job easier and more effective.

The certified storm water operator must complete an inspection report or keep a written log of all inspections. The inspection report or log must contain information regarding the conditions of the control measures and any corrective actions that need to be taken. The inspection log should be kept on the construction site at all times and must be available for public inspection. The inspection log shall be maintained on file by the construction permittee for a minimum of three years.

In conjunction with the inspection log, it is recommended that the certified storm water operator use a sketch or a reduced photocopy of the site plan showing the location and type of control measures. Problems observed at these locations, or at other locations on the construction site, should be highlighted and any corrective measures undertaken should be drawn in and noted in detail on the front side of the form.

The "observations" in the site log should include as much detail as possible about the control measures, even if they are working properly. This is important because they could be working one week and fail the next. Also include observations of areas other than where control measures are installed. Any problems on the site must be documented. Refer to the site plan or sketch as much as possible to make sure it is clear where the problems are. The more detail the better.

The "Corrective Action Taken/Needed" should include anything that is needed to repair or improve the prescribed control measures. This can include regular maintenance activities, additional measures installed (after conferring with the person responsible for developing/approving the plan), or emergency situations. (For example: there may have been a control that failed the week before that has since been repaired. These repairs should be noted). This section is also the place to put any suggestions for improvements, or for correcting a bad soil erosion situation. It is not required by the MDEQ that a certified storm water operator make suggestions, but the permittee may expect such help.

Permit by Rule Reporting

The certified storm water operator is responsible to communicate to the permittee what corrections need to be made. To ensure the site remains in compliance with the permit, the reporting of all problem areas for the entire site is necessary.

This communication is often accomplished through the written inspection log. This log may be the only contact between the certified storm water operator and the permittee. Since the permittee is the person responsible for the site, they must be kept well informed. When conducting site inspections, it is very important to keep detailed records.

The certified storm water operator is required to conduct site inspections, keep a written log of the inspections, and record corrective actions that need to be performed by the permittee. They are not responsible for designing, installing, or maintaining the controls. It is the responsibility of the permittee to keep the site in compliance with the permit. However, the permittee may turn to the certified storm water operator for help. In addition, there may be instances where the permittee may delegate authority to others on site in order to make the project run more efficiently. Thus, the details of each permittee/certified storm water operator relationship will need to be worked out by the individuals involved. As the expectations may change from job to job, it is important to discuss them at the onset of each project.

Controls can be structural, vegetative, and managerial tools used to prevent or control storm water and subsequent erosion and sedimentation. There may be times when problems occur at locations other than those specified on the SESC plan. In these instances, the permittee will need to revise the SESC plan to install additional control measures. A good certified storm water operator will become familiar with the installation and maintenance requirements of commonly used controls in order to identify potential problems on site. Improper installation and poor of maintenance are the major reasons for why SESC measures fail.

Site Stabilization and Site Termination

It is the responsibility of the permittee to ensure that the required inspections and documentation are continued until the site is stabilized and the authorization to discharge storm water is terminated. A site is considered to be stabilized only after:

1. Permanent control structures have been installed (Part 91 requires that permanent controls be installed within 5 days of completing final grade);
2. Good growth of vegetation or other permanent controls have been established
3. Maintenance for permanent controls have been arranged;
4. Temporary SESC controls or BMPs have been removed

For sites disturbing 1-5 acres, Permit-by-Rule coverage (*or the authorization to discharge storm water*) terminates when the Part 91 inspector determines the site is stabilized and closes out the permit or when the SESC permit expires. For APA projects with no permits, it is when the Part 91 inspector (*or certified storm water operator*) determines that the site is stabilized or five years from the start of the project, whichever is sooner. The certified storm water operator must continue conducting inspections until the site is stabilized.

For sites disturbing 5 or more acres, Permit-by-Rule coverage (*or authorization to discharge storm water*) terminates when the permittee (including APA projects) sends a

Notice of Termination (Appendix 5E) to the MDEQ or when the SESC permit expires or five years from the start of the project, whichever is sooner. The certified storm water operator must continue conducting inspections until the NOC is terminated. **Note:** If coverage is terminated before the site is stabilized, the owner will be violation of Part 31 for discharging without a permit. In addition, the owner will have to reapply for coverage which means submitting a new NOC, application fee, and other pertinent documents.

Unit Five Review

1. The Federal _____ (CWA) prohibits the discharge of any pollutant (*including storm water*) to navigable waters from point source discharges unless the discharge is authorized by a National Pollutant Discharge Elimination System (NPDES) permit.
2. In 1994, the state legislature codified all state environmental laws into one, all inclusive statute known as the _____, 1994 PA 451, as amended (NREPA).
3. The primary goal of Part 91 (of the NREPA) is to protect _____ properties and the _____ of the state from _____ generated from unchecked erosion.
4. Part 91 permits are generally required for any earth change that disturbs _____ or more acres of land or that is within _____ feet of the water's edge of a lake or stream.
5. SESC permits must be issued to the _____ or _____ holder.
6. The three types of agencies responsible for administering and enforcing Part 91 are _____, _____, and _____.
7. The _____ and _____ issue SESC permits whereas the _____ undertake earth change activities in accordance with procedures submitted to the MDEQ.
8. The Part 91 inspector must regularly _____ the project site to determine if the SESC measures are properly _____ and _____ in accordance with the SESC plan and if the SESC measures are _____ in minimizing erosion and off-site sedimentation.
9. Part 91 inspectors are responsible for ensuring or verifying that:
 - a) SESC permits are _____ on site.
 - b) Inspections are done in a manner and _____ to assure minimization of _____ and off-site _____.
 - c) Inspections are properly _____.

- d) SESC measures are properly installed and maintained per standard details or plan _____ and are _____. In addition, the inspector must be _____ and anticipate or assess potential problems that may occur.
 - e) Sediment caused by accelerated erosion does not _____ the project site.
 - f) Water discharged from the site is at _____ velocities.
 - g) Temporary SESC measures are installed _____ or upon _____ of the earth change activity.
 - h) Temporary SESC measures are maintained on a _____ basis.
 - i) Permanent SESC measures are installed on all slopes, channels, ditches, or any disturbed land within _____ calendar days after final grading.
 - j) Projects are not closed out until the site is _____ and the temporary SESC measures are _____.
 - k) Compliance and enforcement actions are taken in accordance with Part 91 agency's _____ and _____ procedures or guidelines, Part 91 and the Rules.
10. Any violation of Part 91, the Rules, applicable SESC ordinance approved SESC procedures, approved SESC plans or SESC permit conditions subjects the permittee or _____ to fines and penalties up to _____ per day of violation.
11. In addition to the fines and penalties, lack of adequate inspections or compliance and enforcement actions can result in CEAS being placed on _____ and MEAs and APAs having their Part 91 agency designation _____.
12. The primary goal of Part 31 is to _____ and _____ the waters of the state.
13. In response to the _____ storm water requirements, the MDEQ developed administrative rules (Permit-by-Rule) under the authority of Part 91 to permit storm water _____ from construction activities.
14. Storm water permits are required for any construction activity that disturbs _____ or more acres of land and has a _____ discharge to the surface waters of the state.
15. In addition to including a discernable, confined and discrete conveyance, point source discharge includes any runoff as a result of _____, regardless if it is sheet flow or concentrated flow.
16. Permit-by-Rule provides _____ storm water permit coverage for construction sites that disturb _____ - _____ acres with a point source discharge to the surface waters of the state as long as the landowner has coverage under Part 91. However, the permittee must comply with the requirements of Permit-by-Rule.
17. Owners of projects that disturb _____ acres or more of land that have a point source discharge to surface waters of the state must submit a _____ (_____) [along with other required documents and fees] to the MDEQ to receive

coverage under Permit-by-Rule. The permittee must also comply with the requirements of Permit-by-Rule.

18. All permittees authorized to discharge storm water under Permit-by-Rule shall comply with the following: (**Note:** *Although it is ultimately the permittee's responsibility to comply with all of the following, the certified storm water operator is responsible for only those requirements that are specifically assigned to him/her by the permittee which may include as few as two to all of the responsibilities.*)

- a) Not directly or indirectly _____ any _____ into waters of the state in violation of the NREPA, Part 31 or the rules promulgated there under which includes substances that are or _____ become injurious to specified uses.
- b) Be in compliance with the _____ or, if the construction activity is carried out by an APA, the _____ control plan, including the selected control measures that are applicable to the site.
- c) Properly _____ and _____ SESC measures.
- d) Have the SESC measures under the specific supervision and control of a _____ who has been certified by the MDEQ.
- e) Cause the construction site to be inspected by a certified storm water operator _____ per week and within _____ hours after precipitation events that result in a discharge from the site and ensure that needed _____ are carried out.
- f) Ensure that a log of the _____ and corrective actions shall maintained on file by the permittee for review and shall be retained for a period of _____ years from the date of inspection or corrective action..
- g) Be in accordance with the requirements for on-land facilities as set forth in spillage of _____ and _____ materials, being Part 5 of the NREPA rules.
- h) Dispose of solids, _____, filter backwash, or other _____ that are removed from or results from the treatment of control of storm water in compliance with applicable state laws and regulations.
- i) Allow the MDEQ to enter upon the site at any _____ time.....
- j) Upon request, make available for _____ inspection or provide to the MDEQ all _____ or _____ prepared pursuant to the provisions of this rule.
- k) File a _____ NOC before any expansion of the construction activity or _____ in the SESC measures that require a change in the SESC permit.

19. Any violation of the terms and conditions of Permit-by-Rule subjects the permittee to fines and penalties of up to _____ per day of violation.

20. A certified storm water operator can be _____ person who has a _____ issued by the MDEQ pursuant to the provisions of Part 31.

21. The Part 91 inspector is employed by the Part 91 agency to oversee _____ (or APA) projects to ensure they are in compliance with Part 91; whereas, the certified storm water operator is the _____, or employed by the _____, to assist the permittee in complying with the requirements of Permit-by-Rule.

22. A site is considered stabilized only after:

- a) _____ control structures have been _____;
- b) Good growth of _____ or other permanent controls have been established;
- c) _____ for permanent controls have been arranged;
- d) _____ SESC measures or BMPs have been removed.

23. For sites disturbing 5 or more acres, Permit-by-Rule terminates when the permittee sends a _____ of _____ to the MDEQ or when the SESC permit _____ or _____ years from the start of the project, whichever is sooner.

Answers to Unit Five Review

1. The Federal **Clean Water Act** (CWA) prohibits the discharge of any pollutant (*including storm water*) to navigable waters from point source discharges unless the discharge is authorized by a National Pollutant Discharge Elimination System (NPDES) permit.
2. In 1994, the state legislature codified all state environmental laws into one, all inclusive statute known as the **Natural Resources and Environmental Protection Act**, 1994 PA 451, as amended (NREPA).
3. The primary goal of Part 91 (of the NREPA) is to protect **adjacent** properties and the **waters** of the state from **sediment** generated from unchecked erosion.
4. Part 91 permits are generally required for any earth change that disturbs **one** or more acres of land or that is within **500** feet of the water's edge of a lake or stream.
5. SESC permits must be issued to the **landowner** or **easement** holder.
6. The three types of agencies responsible for administering and enforcing Part 91 are **CEAs**, **MEAs**, and **APAs**.
7. The **CEAs** and **MEAs** issue SESC permits whereas the **APAs** undertake earth change activities in accordance with procedures submitted to the MDEQ.
8. The Part 91 inspector must regularly **inspect** the project site to determine if the SESC measures are properly **installed** and **maintained** in accordance with the SESC plan and if the SESC measures are **effective** in minimizing erosion and off-site sedimentation.
9. Part 91 inspectors are responsible for ensuring or verifying that:
 - a. SESC permits are **posted** on site.
 - b. Inspections are done in a manner and **frequency** to assure minimization of **erosion** and off-site **sedimentation**.
 - c. Inspections are properly **documented**.
 - d. SESC measures are properly installed and maintained per standard details or plan **specifications** and are **effective**. In addition, the inspector must be **proactive** and anticipate or assess potential problems that may occur.
 - e. Sediment caused by accelerated erosion does not **leave** the project site.
 - f. Water discharged from the site is at **nonerosive** velocities.
 - g. Temporary SESC measures are installed **before** or upon **commencement** of the earth change activity.

- h. Temporary SESC measures are maintained on a **daily** basis.
 - i. Permanent SESC measures are installed on all slopes, channels, ditches, or any disturbed land within **5** calendar days after final grading.
 - j. Projects are not closed out until the site is **stabilized** and the temporary SESC measures are **removed**.
 - k. Compliance and enforcement actions are taken in accordance with Part 91 agency's **compliance** and **enforcement** procedures or guidelines, Part 91, and the Rules.
10. Any violation of Part 91, the Rules, applicable SESC ordinance approved SESC procedures, approved SESC plans or SESC permit conditions subjects the permittee or **APA** to fines and penalties up to **\$25,000** per day of violation.
 11. In addition to the fines and penalties, lack of adequate inspections or compliance and enforcement actions can result in CEAS being placed on **probation** and MEAs and APAs having their Part 91 agency designation **revoked**.
 12. The primary goal of Part 31 is to **protect** and **conserve** the waters of the state.
 13. In response to the **federal** storm water requirements, the MDEQ developed administrative rules (Permit-by-Rule) under the authority of Part 91 to permit storm water **discharges** from construction activities.
 14. Storm water permits are required for any construction activity that disturbs **one** or more acres of land and has a **point source** discharge to the surface waters of the state.
 15. In addition to including a discernable, confined and discrete conveyance, point source discharge includes any runoff as a result of **grading**, regardless if it is sheet flow or concentrated flow.
 16. Permit-by-Rule provides **automatic** storm water permit coverage for construction sites that disturb **1- 5** acres with a point source discharge to the surface waters of the state as long as the landowner has coverage under Part 91. However, the permittee must comply with the requirements of Permit-by-Rule.
 17. Owners of projects that disturb **5** acres or more of land that have a point source discharge to surface waters of the state must submit a **Notice of Coverage (NOC)** *[along with other required documents and fees]* to the MDEQ to receive coverage under Permit-by-Rule. The permittee must also comply with the requirements of Permit-by-Rule.
 18. All permittees authorized to discharge storm water under Permit-by-Rule shall comply with the following: (**Note:** *Although it is ultimately the permittee's responsibility to comply with all of the following, the certified storm water operator is responsible for only those requirements that are specifically assigned to*

him/her by the permittee which may include as few as two to all of the responsibilities.)

- a. Not directly or indirectly **discharge** any **substance** into waters of the state in violation of the NREPA, Part 31 or the rules promulgated there under which includes substances that are or **may** become injurious to specified uses.
 - b. Be in compliance with the **SESC plan** or, if the construction activity is carried out by an APA, **the approved** control plan, including the selected control measures that are applicable to the site.
 - c. Properly **maintain** and **operate** SESC measures.
 - d. Have the SESC measures under the specific supervision and control of a **storm water operator** who has been certified by the MDEQ.
 - e. Cause the construction site to be inspected by a certified storm water operator **once** per week and within **24** hours after precipitation events that result in a discharge from the site and ensure that needed **corrective actions** are carried out.
 - f. Ensure that a log of the **inspections** and corrective actions shall maintained on file by the permittee for review and shall be retained for a period of **three** years from the date of the inspection or corrective action.
 - g. Be in accordance with the requirements for on-land facilities as set forth in spillage of **oil** and **pollution** materials, being Part 5 of the NREPA rules.
 - h. Dispose of solids, **sediment**, filter backwash, or other **wastes** that are removed from or results from the treatment of control of storm water in compliance with applicable state laws and regulations.
 - i. Allow the MDEQ to enter upon the site at any **reasonable** time.....
 - j. Upon request, make available for **public** inspection or provide to the MDEQ all **reports** or **logs** prepared pursuant to the provisions of this rule.
 - k. File a revised NOC before any expansion of the construction activity or **change** in the SESC measures that require a change in the SESC permit.
19. Any violation of the terms and conditions of Permit-by-Rule subjects the permittee to fines and penalties of up to **\$25,000** per day of violation.
20. A certified storm water operator can be **any** person who has a **training certificate** issued by the MDEQ pursuant to the provisions of Part 31.
21. The Part 91 inspector is employed by the Part 91 agency to oversee **permitted** (or APA) projects to ensure they are in compliance with Part 91; whereas, the certified storm water operator is the **permittee**, or employed by the permittee, to assist the permittee in complying with the requirements of Permit-by-Rule.

22. A site is considered stabilized only after:
- a. **Permanent** control structures have been **installed**;
 - b. Good growth of **vegetation** or other permanent controls have been established;
 - c. **Maintenance** for permanent controls have been arranged;
 - d. **Temporary** SESC measures or BMPs have been removed.
23. For sites disturbing **5 or more acres**, **Permit-by-Rule terminates when the permittee sends a Notice of Termination** to the MDEQ or when the SESC permit **expires** or **5** years from the start of the project, whichever is sooner.

MICHIGAN'S PERMIT-BY-RULE FOR CONSTRUCTION ACTIVITIES

R 323.2190 National permit for storm water discharge from construction activity.

Rule 2190. (1) Unless the Department has required an individual national permit pursuant to the provisions of subrule (3) or (4) of this rule, a point source discharge of storm water from a construction activity will be deemed to have a national permit authorizing the discharge if the criteria of subdivisions (a) and (b) of this subrule is met. Exception: after March 10, 2003, small construction activities, meaning 1 to 5 acres of disturbed soil as defined in R 323.2102(h)(ii) or (iii), are automatically deemed to have a national permit authorizing discharge of storm water in accordance with this rule and are not required to meet the filing requirements of subdivision(a) or (b) of this subrule, subrule (2)(j) of this rule, and subrule(5)(b) of this rule. The construction permittee shall do both of the following:

(a) File with the Department, on a form approved by the Department, notice of coverage pursuant to the provisions of this rule before the initiation of construction activity. The notice of coverage shall include all of the following:

(i) A copy of the individual soil erosion and sedimentation control permit for the site as issued to the construction permittee; or if the construction activity is to be carried out by an authorized public agency, certification by the authorized public agency that an approved control plan exists; or, for

Part 615 or Part 631 permits, a copy of the permit, along with any forms or diagrams pertaining to soil erosion and sedimentation control that were part of the permit application.

(ii) Acknowledgement by the construction permittee that any discharge that is made pursuant to the provisions of this rule shall be in compliance with Part 31 of the Act and the rules promulgated thereunder.

(iii) A location map and a description of the nature of the construction activity.

(iv) The location of the proposed discharge and identification of the receiving water.

(v) The total area of the site and the area of the site that is expected to undergo construction activity during the life of the project.

(vi) Name and certification number of a certified storm water operator responsible for inspection of the construction activity in accordance with subrule (2)(e) of this rule.

(b) Provide a valid signature of the construction permittee or authorized representative on the notice of coverage. If the construction permittee is a partnership, association, corporation, industry, municipality, state agency, or interstate body, the valid signatory for the notice of coverage shall be determined in accordance with R 323.2114.

(2) A construction permittee that has authorization to discharge under a national permit pursuant to subrule (1) of this rule shall comply with all of the following provisions:

(a) Not directly or indirectly discharge wastes such as discarded building materials, concrete truck washout, chemicals, lubricants, fuels, litter, sanitary waste, or any other substance at the construction site into the waters of the state in violation of Part 31 of the Act or rules promulgated thereunder.

(b) Be in compliance with a soil erosion and sedimentation control permit for the site or, if the construction activity is carried out by an authorized public agency, the

approved control plan, including the selected control measures that are applicable to the site.

(c) Properly maintain and operate the soil erosion control measures.

(d) Have the soil erosion control measures under the specific supervision and control of a storm water operator who has been certified by the Department as properly qualified to operate the soil erosion control measures. The certification shall be done in accordance with the requirements of R 323.1251 et seq.

(e) Cause the construction activity to be inspected by a certified storm water operator once per week, and within 24 hours after every precipitation event that results in a discharge from the site, and ensure that any needed corrective actions are carried out. A log of the inspections and corrective actions shall be maintained on file by the construction permittee for review and shall be retained by the construction permittee for a period of 3 years from the date of the inspection or corrective action.

(f) In accordance with the requirements for on-land facilities as set forth in spillage of oil and polluting materials, being Part 5 of these rules, provide facilities and comply with reporting procedures for containment of any accidental losses of oil or other polluting materials.

(g) Dispose of solids, sediment, filter backwash, or other waste that is removed from or results from the treatment or control of storm water in compliance with applicable state laws and regulations and in a manner that prevents any waste from entering waters of the state.

(h) Allow the Department to enter upon the site at any reasonable time before the expiration of the authorization to discharge as set forth in subrule (5) of this rule, upon presentation of credentials and other documents as may be required by law, for the purpose of inspecting conditions relating to the pollution of any waters or determining compliance with the provisions of this rule.

(i) Upon request, make available for public inspection or provide to the Department all reports or logs prepared pursuant to the provisions of this rule.

(j) File a revised notice of coverage in compliance with the provisions of subrule (1) of this rule before any expansion of the construction activity or change in the soil erosion control measures that requires a change in the soil erosion and sedimentation control permit.

(3) The Department may require that discharges from a construction activity be authorized by an individual national permit if it has been determined by the Department that unlawful pollution cannot be adequately guarded against, and there is or may be water quality degradation that will violate the commission act unless requirements in addition to those in the soil erosion and sedimentation control permit are imposed. A determination by the Department for an individual national permit or other additional control constitutes grounds for revocation of the authorization to discharge pursuant to the provisions of this rule.

(4) The Department may require that discharges from a construction activity be authorized by an individual national permit if it has been determined by the Department that the responsible Part 91 permitting entity or authorized public agency is not carrying out a program that is adequate to ensure that the requirements of Part 91 of the Act are complied with.

(5) The authorization to discharge pursuant to the provisions of this rule expires as follows:

(a) When the soil erosion and sedimentation control permit expires, or is revoked or terminated by the Part 91 permitting entity in accordance with the provisions of Part 91 of the Act and 1969 PA 306, MCL 24.201 et seq., or when the authorized public agency determines that the project has been completed by the stabilization of earth change activity.

(b) Five years from the date of the notice that is filed pursuant to the provisions of subrule (1)(a) of this rule, if the authorization to discharge has not previously expired pursuant to subdivision (a) of this subrule. This authorization may be extended by filing a new notice in compliance with the provisions of subrule (1)(a) of this rule. The construction permittee shall file a notice of termination with the Department, on a form approved by the Department, when authorization to discharge expires as set forth in accordance with subdivision (a) of this subrule. The notice of termination shall include the name and address of the construction permittee, the location of the construction site, and the mailing address, if available, and certification that stabilization of earth change activity has been completed or, if the certification cannot be made, the reason why the authorization to discharge has expired.

(6) The Department may revoke authorization to discharge pursuant to the provisions of this rule if an individual national permit is required pursuant to the provisions of subrule (3) of this rule or in compliance with R 323.2159.

(7) Nothing in this rule shall be construed to preclude the institution of any legal action or relieve the construction permittee from any responsibilities, liabilities, or penalties to which the construction permittee may be subject pursuant to Part 31 of the Act or rules promulgated thereunder.

(8) The provisions of this rule are severable, and if any provision of this rule or the application of any provisions of this rule to any circumstances is held invalid, the application of the provisions of this rule to other circumstances and the remainder of this rule shall not be affected by the invalidity.

(9) The construction permittee shall take all reasonable steps to minimize any adverse impact to the surface or groundwaters of the state that result from noncompliance with any of the conditions specified in this rule.

(10) If, for any reason, the construction permittee does not comply with, or will be unable to comply with, any of the conditions that are specified in this rule, the construction permittee shall provide the Department with the following information, in writing, within 5 days of becoming aware of the noncompliance or inability to comply:

(a) A description of the noncompliance and its cause.

(b) The period of noncompliance, including exact dates and times, or, if the noncompliance is not corrected, the anticipated time that the noncompliance is expected to continue and the steps taken to reduce, eliminate, and prevent recurrence of the noncompliance.

(11) The provisions of this rule do not convey any property rights in either real or personal property, or any exclusive privileges, authorize any pollution, impairment, or destruction of the natural resources of the state, or the violation of any federal, state, or local laws or regulations, or obviate the necessity of obtaining permits or approvals from other units of government as may be required by law.

(12) The provisions of this rule do not exempt the construction permittee from giving notice to public utilities and complying with each of the requirements of 1974 PA 53, MCL 460.701 et seq.

(13) This rule shall not provide authorization to discharge storm water from construction activity which is mixed with non-storm water, or which is subject to an existing national permit or general permit.

DEFINITIONS AS USED IN THE PERMIT-BY-RULE

“Act” means 1994 PA 451, MCL 324.3101 et seq., and the rules promulgated under the Act.

“Applicant” means a person who applies to the Department for a state or national permit to discharge waste or wastewaters into the waters of the state by an NPDES application form or a state permit application form.

“Application” means either the uniform national NPDES application form, including subsequent additions, revisions, or modifications thereof, promulgated by the administrator of EPA and adopted for use by the Department or a state permit application form for applying for a permit.

“Approved control plan” means the plan which is prepared by an authorized public agency, which is approved by the Department pursuant to the provisions of section 9110 of Part 91 of the Act, and which contains the soil erosion and sedimentation control procedures that govern all construction activities normally undertaken by the authorized public agency.

“Authorized public agency” means a state, local, or county agency that is designated pursuant to the provisions of section 9110 of Part 91 of the Act to implement soil erosion and sedimentation control requirements with regard to construction activities undertaken by the agency.

“Authorized representative” means a person who has written authorization from the construction permittee to sign the notice of coverage in the name of the construction permittee.

“Certified storm water operator” means an individual who has been certified by the Department pursuant to the provisions of section 3110 of Part 31 of the Act as properly qualified to operate treatment or control facilities for storm water discharges.

“Construction activity” means a man-made earth change or disturbance in the existing cover or topography of land for which a national permit is required pursuant to the provisions of 40 C.F.R. §122.26(a) (2000) and which is any of the following:

- (i) Five acres or more in size and defined as a construction activity pursuant to the provisions of 40 C.F.R. §122.26(b)(14)(x) (2000).
- (ii) One acre or more in size and defined as a small construction activity pursuant to the provisions

of 40 C.F.R. §122.26(b)(15) (2000).

- (iii) Less than 1 acre of total land area that is part of a larger common plan of development or sale if the larger common plan will ultimately disturb 1 acre or more.

The term includes clearing, grading, and excavating activities. The term does not include the practices of clearing, plowing, and tilling soil and harvesting for the purpose of crop production.

“Construction permittee” means a person who is deemed to have a national permit pursuant to the provisions of R 323.2190 and who owns or holds a recorded easement on the property where a construction activity is located, is constructing in a public right-of-way in accordance with the provisions of sections 13, 14, 15, and 16 of 1925 PA 368, MCL 247.183, 247.184, 247.185, and 247.186 , or is the authorized public agency if a construction activity is carried out by the authorized public agency.

“Department” means the director of the Department of Environmental Quality or his or her designee to whom the director delegates a power or duty by written instrument.

“Discharge” means any direct or indirect discharge of any waste, waste effluent, wastewater, pollutant, or any combination thereof into any of the waters of the state or upon the ground.

“Discharger” means any person who discharges, directly or indirectly, any substance defined by section 3109 of Part 31 of the Act, any treated or untreated waste, waste effluent, wastewater, or pollutant; or cooling waters into any of the waters of the state or upon the ground.

“EPA” means the United States Environmental Protection Agency.

“General permit” means a national permit issued authorizing a category of similar discharges.

“National permit” means an NPDES permit, or equivalent document or requirements, issued by the Department to a discharger pursuant to sections 3106 and 3112 of Part 31 of the Act for discharges into surface waters.

“NPDES” means the national pollutant discharge elimination system established by the Federal Act.

“NPDES form” means any issued permit and any uniform national form which is used by the Department, which is developed for use in the NPDES, and which is prescribed in regulations promulgated by the administrator of EPA, including an NPDES application and a reporting form.

“Part 91 permitting entity” means an agency that is designated by a county board of commissioners pursuant to the provisions of section 9105 of Part 91 of the Act; an agency that is designated by a city, village, or township in accordance with the provisions of section 9106 of Part 91 of the Act; or the Department if the construction activity is under the jurisdiction of 2 or more municipal or county enforcing agencies; or

the Department for soil erosion and sedimentation activities under Part 615 or Part 631 pursuant to the provisions of section 9115 of Part 91 of the Act.

“Person” means an individual, partnership, association, corporation, industry, or public body.

“Point source discharge” means a discharge that is released to the waters of the state by a discernible, confined, and discrete conveyance, including any of the following from which wastewater is or may be discharged:

- (i) A pipe.
- (ii) A ditch.
- (iii) A channel.
- (iv) A tunnel.
- (v) A conduit.
- (vi) A well.
- (vii) A discrete fissure.
- (viii) A container.
- (ix) A concentrated animal feeding operation.
- (x) A vessel or other floating craft.

The term does not include a legally established county or intercounty drain, except for a county or intercounty drain that has a POTW designated as part of the drain or a discharge otherwise required to be authorized by a national permit.

“Site” means the area where a construction activity is physically located or conducted, including adjacent land that is used in connection with the construction activity.

“Soil erosion and sedimentation control permit” means a permit that is issued pursuant to the provisions of Part 91 of the Act by a part 91 permitting entity.

“Soil erosion control measures” means the measures or procedures to prevent or reduce the pollution of waters of the state that are required in the soil erosion and sedimentation control permit for the site or the selected control measures from the approved control plan that are applicable to the site.

“Stabilization of earth change activity” means the proper placement, grading, or covering of soil or rock at a construction activity to ensure subsequent resistance to soil erosion, sliding, or other earth movement.

“Storm water” means storm water runoff, snow melt runoff, and surface runoff and drainage.

OTHER RULES REFERENCED IN THE PERMIT-BY-RULE

R 323.2114 Permit applications and other NPDES forms; valid signatories.

Rule 2114. A state or national permit application form or any other NPDES form submitted to the Department pursuant to these rules shall be signed as follows:

(a) For a corporation, by a principal executive officer of at least the level of vice president, or his or her designated representative, if the representative is responsible for the overall operation of the facility from which the discharge described in the permit application or other NPDES form originates.

(b) For a partnership, by a general partner.

(c) For a sole proprietorship, by the proprietor.

(d) For a municipal, state, or other public facility, by either a principal executive officer, the mayor, village president, city, or village manager, or other duly authorized employee.

R 323.2159 State and national permits; modification or revocation by the Department.

Rule 2159. (1) The Department may modify any term or condition, including a schedule of compliance, of a permit, or may revoke a permit upon its finding of any of the following:

(a) There is a change in any condition that requires a temporary or permanent reduction or elimination of a permitted discharge or constituent thereof.

(b) The administrator of EPA issues a regulation prescribing a restriction or prohibition of a waste or wastewater constituent which is not covered by the terms and conditions of a permit, or the regulation is more stringent than any limitation imposed on a wastewater constituent in a permit.

(c) A modification of the terms and conditions of a permit or a time schedule thereon is necessary because of an act of God or other conditions beyond the control of the permittee.

(d) In the case of discharges from publicly owned treatment works, federal treatment works grant funds are not available or are not sufficient to allow construction of the treatment works in a time schedule set forth in the permit.

(e) There is a violation of any term or condition of the permit.

(f) The permittee has obtained a permit by misrepresentation or has failed to disclose all relevant facts to the commission.

(g) A toxic effluent standard or prohibition, including any schedule of compliance specified therein, is established pursuant to section 307(a) of the Federal Act for a toxic waste or wastewater constituent which is present in the permittee's discharge and the standard or prohibition is more stringent than any limitation upon the waste or wastewater constituent in the permit.

(h) The POTW receives wastewater from a nondomestic source and the development of a pretreatment program is necessary to control the introduction of regulated pollutants.

(i) When a request for removal credits is approved in accordance with R 323.2313(a).

(2) The Department shall notify the regional administrator of any change in status or condition of a permit and he or she shall have an opportunity to object thereto, in writing, within 45 days before the effective date of the modification. If the regional administrator objects in writing, then the objection shall be resolved before the modification is approved by the Department, unless the right to object is waived, in writing, by the regional administrator.

(3) A permittee who is affected by a modification of a permit by the Department shall be notified not less than 90 days before the effective date of the modification and, upon petition therefore, shall have a hearing thereon pursuant to section 3112 of Part 31 of the Act.

(4) If the Department modifies an effluent limitation or a schedule of compliance in a permit, notice of the modification shall be mailed to all persons on the Department mailing list for public notices and fact sheets as prescribed by R 323.2124, and any interested person may comment thereon within 30 days following the date of notification.

SOIL EROSION & SEDIMENTATION CONTROL/CONSTRUCTION STORM WATER INSPECTION LOG

Project Name or Description: _____ NPDES Number (if applicable): _____ Page ____ of ____

Date: _____ Time: _____ Reason for Inspection: Weekly Inspection Inspection **within 24 hrs. of Storm Water Runoff**

Current extent of the project work: _____

SESC measures installed since the last inspection and their location: _____

Are SESC measures installed according to the SESC Plan? **Y** **N** Are there other potential areas of concern? **Y** **N**
If **NO**, identify measures, locations, and actions needed below.

Are the SESC measures: Properly installed? **Y** **N** Maintained? **Y** **N** Appropriate for site conditions? **Y** **N**
Failed? **Y** **N**
If **NO**, identify measure locations and actions needed below.

Are additional SESC measures recommended? **Y** **N** Are there other concerns or improvements noted for the site? **Y** **N**
If **YES**, identify locations and recommendations below.

Corrective Actions Taken/Needed **to repair or improve the prescribed control measures:**

Certified Operator Signature: _____ **Operator Number:** _____

Print Name: _____

The details included in this report were provided to: _____ **Date:** _____ **By method of delivery:** _____

FOR DEQ USE ONLY		
NPDES Number		
Receipt No.:		
Permit ID:		

NOTICE OF COVERAGE

FOR NATIONAL POLLUTANT DISCHARGE ELIMINATION SYSTEM (NPDES) STORM WATER DISCHARGES FROM CONSTRUCTION ACTIVITY

By Authority of R 323.2190 promulgated under Part 31 of Act 451, Public Acts of 1994, as amended
Failure to comply with the terms and provisions of R 323.2190 may result in fines up to \$25,000
per day and the possibility of imprisonment.

Filing of this Notice of Coverage (NOC) with the Michigan Department of Environmental Quality (MDEQ) is required before initiation of construction activities **that disturb 5 acres or more of land or is part of a larger common plan of development or sale** that requires a national permit pursuant to the provisions of 40 CFR Section 122.26(a). This constitutes notice that the construction permittee is authorized under R 323.2190 to discharge storm water associated with the construction activities. The construction permittee must be the land owner or the recorded easement holder of the property where the construction activity is located.

INSTRUCTIONS AND FEE INFORMATION: Soil Erosion and Sedimentation Control (SESC) coverage is required under Part 91, SESC, of Act 451 before submitting this NOC. The construction permittee will be deemed to have an NPDES permit for storm water discharges from a construction site when the MDEQ receives the completed NOC, **a copy of the appropriate SESC permit, a copy of the approved SESC Plan, a site map and the \$400 fee.** These must be received before construction begins. **This authorization to discharge construction storm water will expire** on the same day as the SESC permit originally submitted to the MDEQ with this package. The expiration date will be specified in the NOC acknowledgement letter provided by the MDEQ (please make sure you receive the NOC acknowledgement letter). NOC Authorization to discharge storm water may be extended (up to five years after original issuance date) by submitting a NOC Renewal form and a copy of the revised or extended SESC permit to the MDEQ **prior** to the NOC expiration. If the SESC permit number changes, expires, is revoked or terminated, prior to the complete stabilization of the site, a **new** administratively complete NOC and all the requirements, including the fee must be submitted to obtain storm water authorization.

PERMIT BY RULE REQUIREMENTS: The permittee must abide by the requirements of R 323.2190 which states in part: **(a)** Not directly or indirectly discharge waste materials into the waters of the state in violation of Part 31, Water Resources Protection, of the Act or rules promulgated there under; **(b)** Be in compliance with a soil erosion and sedimentation control permit for the site; **(c)** Properly maintain and operate the soil erosion control measures; **(d)** Have the soil erosion control measures under the specific supervision and control of a storm water operator who has been certified by the Department; **(e)** Cause the construction activity to be inspected by a certified storm water operator once per week, and within 24 hours after every precipitation event that results in a discharge from the site. Refer to R 323.2190 for the complete listing of requirements at: (The link provided was broken and has been removed)

CONSTRUCTION PERMITTEE INFORMATION (Landowner, Easement Holder, or Authorized Public Agency)					
LANDOWNER/PERMITTEE			AGENT FOR LANDOWNER (OPTIONAL)		
CONTACT PERSON (FIRST AND LAST NAME)			CONTACT PERSON (FIRST AND LAST NAME)		
E-MAIL ADDRESS (OPTIONAL FOR FASTER SERVICE)			E-MAIL ADDRESS		
MAILING ADDRESS			MAILING ADDRESS		
STREET			STREET		
CITY	STATE	ZIP	CITY	STATE	ZIP
STORM WATER CERTIFIED OPERATOR (CONSTRUCTION ONLY)			For Cashier's Office Only: 37000-40512-9091-481001-01		
CERTIFIED OPERATOR					
CERTIFICATION NUMBER					

SITE DESCRIPTION				
TOTAL ACRES OF SITE	ACRES OF DISTURBANCE	RECEIVING WATERS		
PROJECT INFORMATION				
PROJECT NAME		COUNTY	TOWNSHIP	
STREET		$\frac{1}{4}$	$\frac{1}{4}$	SECTION
CITY	STATE	ZIP	TOWN (T)	RANGE (R)
PART 91 SESC PERMITTING ENTITY INFORMATION				
NAME OF PART 91 SESC PERMITTING ENTITY OR APA AGENCY				
E-MAIL ADDRESS (OPTIONAL FOR FASTER SERVICE)			PHONE NUMBER	
ADDRESS			SESC PERMIT NUMBER OR APA STATUS	
CITY	STATE	ZIP	ISSUE DATE	

CERTIFICATION - Michigan regulations require this form be signed as follows:

Corporation: a principal executive officer of at least the level of vice president, or his designated representative, if the representative is responsible for the overall operation of the facility from which the discharge described in this form originates.

Partnership: a general partner.

Sole Proprietorship: the proprietor.

Municipal, State, or other public facility: either a principal executive officer, the mayor, village president, city or village manager, or other duly authorized employee.

I certify that I have read R 323.2190 and that all provisions of R 323.2190 will be complied with and that all information contained in this NOC is, to the best of my knowledge and belief, true, accurate and complete. I acknowledge that any discharge that is authorized by this NOC shall be in compliance with Act 451, Part 31, and the rules promulgated thereunder. I am aware that there are significant penalties for submitting false information, including the possibility of fines and imprisonment. I certify under penalty of law that I possess full authority on behalf of the legal landowner/permittee to sign and submit this NOC.

SIGNATURE (ORIGINAL SIGNATURE REQUIRED) X	DATE	TELEPHONE
PRINTED NAME	TITLE	

MAKE CHECK OR MONEY ORDER IN THE AMOUNT OF \$400 PAYABLE TO: STATE OF MICHIGAN

MAIL COMPLETED APPLICATION, LOCATION MAP, SESC PERMIT AND PLAN, ALONG WITH THE **\$400** FEE TO:

MICHIGAN DEPARTMENT OF ENVIRONMENTAL QUALITY
CASHIERS OFFICE - WB-SW1
P O BOX 30657
LANSING, MI 48909-8157

ADDRESS FOR OVERNIGHT MAILING:

MICHIGAN DEPARTMENT OF ENVIRONMENTAL QUALITY
CASHIERS OFFICE - WB-SW1
525 WEST ALLEGAN 5TH FLOOR SOUTH TOWER
LANSING, MI 48913

IF YOU HAVE ANY QUESTIONS ABOUT THE PREPARATION OF THIS FORM OR DON'T RECEIVE ACKNOWLEDGEMENT WITHIN 30 DAYS OF SUBMITTAL, CALL 586-753-3718 OR E-MAIL: PetroskiC@michigan.gov.



OFFICIAL USE ONLY
PERMIT ID
NPDES NUMBER

NOTICE OF COVERAGE RENEWAL

FOR NATIONAL POLLUTANT DISCHARGE ELIMINATION SYSTEM (NPDES)
STORM WATER DISCHARGES FROM CONSTRUCTION ACTIVITY

By Authority of R 323.2190 of Act 451, Public Acts of 1994, as amended
Failure to comply with the terms and provisions of R 323.2190 may result in fines up to \$25,000
per day and the possibility of imprisonment.

Filing of this Notice of Coverage Renewal with the Michigan Department of Environmental Quality (MDEQ) is required **prior** to any ownership change or revision of the permitted construction activity, change in the Soil Erosion and Sedimentation Control (SESC) plan, or expiration of the SESC permit. Authorization to discharge storm water may be extended (up to five years after original issuance date) by submitting a revised or extended SESC permit to the MDEQ **prior** to the NOC expiration. If the SESC permit number changes, expires, is revoked or terminated, prior to the complete stabilization of the site, a **new** administratively complete NOC and all the requirements, including the fee must be submitted to obtain storm water authorization.

CONSTRUCTION PERMITTEE INFORMATION (Landowner or easement holder)			
LANDOWNER		CONTACT PERSON (FIRST AND LAST NAME)	
STREET		E-MAIL ADDRESS (OPTIONAL FOR FASTER SERVICE)	
CITY	STATE	ZIP	CURRENT NPDES NUMBER (REQUIRED)
PROJECT INFORMATION			
PROJECT NAME		STREET	
COUNTY	ACRES OF SITE	ACRES OF DISTURBANCE	
STORM WATER CERTIFIED OPERATOR		CERTIFICATION NUMBER	
SESC PERMITTING ENTITY (PART 91)			

I certify that all provisions of R 323.2190 pursuant to Act 451, Part 31, of 1994, as amended, have been complied with and that all information submitted under the Rule and contained in this Notice of Coverage Renewal is, to the best of my knowledge and belief, true, accurate and complete. I acknowledge that any discharge that is made pursuant to Rule 323.2190 shall be in compliance with Act 451, Part 31, and the rules promulgated thereunder. I am aware that there are significant penalties for submitting false information, including the possibility of fines and imprisonment. I certify under penalty of law that I possess full authority on behalf of the legal landowner/permittee to sign and submit this Notice of Coverage.

SIGNATURE (ORIGINAL SIGNATURE REQUIRED) X	DATE	TELEPHONE
PRINTED NAME	TITLE	

MAKE SURE TO INCLUDE A COPY OF THE UPDATED SESC PERMIT AND PLAN (*plans only required if revised). TO AVOID LAPSE IN COVERAGE, PLEASE SUBMIT 30 DAYS PRIOR TO NPDES EXPIRATION DATE.

MAIL OR E-MAIL COMPLETED FORM TO:

E-mail: PetroskiC@michigan.gov

MICHIGAN DEPARTMENT OF ENVIRONMENTAL QUALITY
Water Resources Division
525 WEST ALLEGAN
PO BOX 30458
LANSING, MI 48909

IF YOU HAVE ANY QUESTIONS ABOUT THE PREPARATION OF THIS FORM, CALL 586-753-3718.



MICHIGAN DEPARTMENT OF ENVIRONMENTAL QUALITY
 WATER RESOURCES DIVISION
NOTICE OF TERMINATION
 FOR NATIONAL POLLUTANT DISCHARGE ELIMINATION SYSTEM (NPDES)
 Storm Water Discharges from Construction Activities
By Authority of R 323.2190 of Act 451, PA 1994, as amended

PERMIT INFORMATION		NPDES PERMIT NUMBER:
REASON FOR TERMINATION: (check all that apply) list month, day and year for all dates <input type="checkbox"/> The Soil Erosion and Sediment Control (Act 451, Part 91) permit will expire on: <input type="checkbox"/> The Soil Erosion and Sediment Control (Act 451, Part 91) permit was revoked/terminated on: <input type="checkbox"/> The project was completed by stabilization of the earth change activities on: <input type="checkbox"/> Other: Explain:		
CONSTRUCTION PERMITTEE INFORMATION		
NAME		
MAILING ADDRESS		
STREET		
CITY	STATE	ZIP CODE
CONSTRUCTION SITE INFORMATION		
PROJECT NAME		
MAILING ADDRESS		
STREET		
CITY	STATE	ZIP CODE
DESCRIPTION		

CERTIFICATION

Michigan regulations require this form be signed as follows:

Corporation: a principal executive officer of at least the level of vice president, or his designated representative, if the representative is responsible for the overall operation of the facility from which the discharge described in this form originates.

Partnership: a general partner.

Sole Proprietorship: the proprietor.

Municipal, State, or other public facility: either a principal executive officer, the mayor, village president, city or village manager, or other duly authorized employee.

I certify that all information submitted in this Notice of Termination is, to the best of my knowledge and belief, true, accurate, and complete, and that all storm water discharges associated with construction activities from the site identified above that were authorized by R 323.2190 have been eliminated because of the reason(s) indicated above. I understand, by submitting this Notice of Termination, I am no longer authorized to discharge storm water associated with construction activities at this site and that discharging pollutants in storm water associated with construction activities without authorization is unlawful. I also understand that submittal of this Notice of Termination does not release the permittee from liability for any prior violations of R 323.2190.

SIGNATURE (ORIGINAL SIGNATURE REQUIRED)	DATE	TELEPHONE
PRINTED NAME	TITLE	

PLEASE MAIL OR EMAIL THE COMPLETED FORM TO THE APPROPRIATE DISTRICT OFFICE USING THE FOLLOWING LINK: *(The link provided was broken and has been removed)* AND CLICK ON WRD DISTRICT OFFICES OR CONTACT YOUR LOCAL COMPLIANCE PERSON AT: <https://www.michigan.gov/-/media/Project/Websites/egle/Documents/Programs/WRD/About-Us/Staff-SESC.pdf>

Unit Six

REQUIREMENTS FOR ADMINISTERING AND ENFORCING PART 91 PROGRAMS

Summary of Law and Program Responsibilities

Part 91 and the Rules promulgated there under (hereafter referred to as Part 91) regulate earth change activities. Each change is defined as human-made changes in the natural cover or topography of land, including cut and fill activities, which may result in or contribute to soil erosion or sedimentation of the waters of the state. Earth change does not include the practice of plowing and tilling soil for the purpose of crop production.

The primary intent of Part 91 is to protect the waters of the state and adjacent properties by minimizing erosion and controlling off-site sedimentation which result from earth changes.

The following material is intended to provide a synopsis of Part 91 for the reader. ***It does not encompass all requirements of Part 91, nor is it intended to increase or diminish the requirements set forth in the statute and administrative rules.*** You are expected to read and understand all requirements of Part 91 (Appendix 6A and 6B).

Enforcing Agencies (EAs)

Part 91 is a state law that delegates the responsibility for implementation to counties. Each county board must designate a County Enforcing Agency (CEA) to enforce the statute within its boundaries. The responsibility for oversight of all earth changes in the county falls to the CEA with two exceptions: (1) The CEA is not responsible for earth changes within the boundaries of a city, village, or township that has elected to pass a SESC ordinance and has been designated a Municipal Enforcing Agency (MEA) (2) The CEA or MEA is not responsible for earth changes undertaken by Authorized Public Agencies (APAs) within its boundaries.

The county can implement a Part 91 CEA program through either a resolution or an ordinance passed by the county board of commissioners. MEAs must pass an ordinance in order to have an approved program. Regardless if the EA is administering their program under a resolution or ordinance, the resolution or ordinance must be approved by the Michigan Department of Environmental Quality (MDEQ). A resolution may not be more restrictive or less restrictive than Part 91. Essentially, under a resolution the county is accepting Part 91 as written. Should a CEA collect fines under a resolution, the funds are required to be returned to the state. Under an ordinance, any fines collected belong to the county or the municipality. There are also several other advantages to implementing the program under an ordinance. Ordinances may be more restrictive than Part 91, allowing the county to address specific challenges and limitations in Part 91. Also, ordinances can allow compliance and enforcement tools which are not available in Part 91, such as ticket writing authority for the CEA or MEA staff.

One of the primary roles of CEAs and MEAs is to issue and enforce SESC permits. However, soil erosion and sedimentation to waters of the state (lakes, streams, and wetlands) and adjacent properties from earth changes is the responsibility of the enforcing agency regardless of whether the site is under permit.

Key SESC Permitting and EA Facts

A. Permittee: [Rules 1701(1) (c) and (e); Rule 1704(1)]

Permits must be issued to the landowner. A designated agent may apply for the permit with written authorization from the landowner.

B. Activities Requiring Permits: [Rule 1704(1)]

All *earth changes* as defined in Section 9101(1)(9) that disturb

1. One acre or more, or are
2. Within 500 feet of the water's edge of a *lake* or *stream* as defined in Rule 1701(1).

Note: Ordinances can be more restrictive than Part 91 thus allowing agencies to require permits for other activities than identified above; however, agencies cannot require permits for activities that are specifically exempted in Part 91. [Sections 9105(3) and 9106(1)]

C. Permit Exemptions: (Sections 9115 and 9115a; Rule 1705)

No permits shall be required for the following:

1. Plowing and tilling for crop production or harvesting of crops.
2. Mining and logging activities and integral activities associated with logging and mining. The logging and mining exemptions do not include (i.e. permits are required for) the following:
 - a) Access roads to and from the site where active mining and logging is taking place.
 - b) Ancillary activities associated with logging and mining.
 - c) The removal of clay, gravel, sand, peat, or topsoil.
3. Earth changes associated with well locations, surface facilities, flowlines, or access roads related to oil or gas exploration and development regulated under Part 615 of the NREPA, if the application for a permit to drill and operate under Part 615 contains a SESC plan approved by the MDEQ.
4. Normal road and driveway maintenance, such as grading and leveling, that does not increase the width or length of the road or driveway and that will not contribute sediment to lakes and streams.
5. An earth change of minor nature that is stabilized within 24 hours of the initial earth disturbance that will not contribute sediment to lakes or streams.
6. The following activities undertaken by the property owner on residential property if the earth change activity does not result in or contribute to soil erosion or sedimentation of the waters of the state or a discharge of sediment off-site:
 - a) Gardening, if the natural elevation of the area is not raised.

- b) Post holes for fencing, decks, utility posts, mailboxes, or similar applications, if no additional grading or earth change occurs for the use of the post holes.
- c) Removal of tree stumps, shrub stumps, or roots resulting in an earth change not to exceed 100 square feet.

D. Documents:

- 1. SESC Application: The EA must use an application form that contains state-prescribed information [*Rule 1706(3)*; Appendix 6C].
- 2. SESC Plan: The landowner or designated agent must submitted an SESC plan along with the application containing, at a minimum, *Rule 1703* information [*Rule 1706(2)*].
- 3. SESC Permit: The EA must use a permit form that contains state-prescribed information [*Rule 1707(3)*; Appendix 6D].
- 4. SESC Inspection Report: Part 91 does not require a specific form to be used to document site inspections; however, the MDEQ recommends that the form in Appendix 6E (or something similar) be used.

E. Minimum SESC Plan Requirements: (Rule 1703):

Each permitted site must have an SESC Plan approved by the EA that contains, at a minimum, the following information:

- 1. A map or maps at a scale of not more than 200 feet to the inch.
- 2. Legal description of the property.
- 3. Site location sketch.
- 4. Proximity to lakes and streams.
- 5. Predominant land features.
- 6. Contour intervals or slope description.
- 7. Soils survey or written description of soils types.
- 8. Physical limits of earth change.
- 9. Location of existing and proposed on-site drainage and dewatering facilities.
- 10. Timing and sequence of each proposed earth change.
- 11. Location and description for installing and removing proposed temporary SESC measures.
- 12. A description and location of all proposed permanent SESC measures.
- 13. A program for the maintenance of all permanent SESC measures.

F. Other Earth Change Requirements: (Rule 1709)

1. A person shall design, construct, and complete an earth change in a manner that limits the exposed area for the shortest period of time as determined by EA.
2. A person shall remove sediment caused by accelerated soil erosion from runoff water before it leaves the site of the earth change.
3. A person shall design temporary and permanent control measures to limit the water flow to non-erosive velocities.
4. Temporary SESC measures shall be installed before or upon the commencement of the earth change and shall maintain the measures on a daily basis.
5. Permanent SESC measures shall be installed within 5 calendar days after final grading.

G. Inspections:

The EA must conduct adequate inspections to assure minimization of soil erosion and off-site sedimentation [Sections 9105(6)(c) and 9106(3)(c)]. In most instances, this would include the following inspection frequency:

1. Prior to permit issuance
2. Immediately before or after work begins to ensure temporary SESC measures are in place and functioning.
3. Periodically during active construction – Prioritize inspections to take into account major rain or snowmelt events, major changes in construction activities, and on risk of property and water quality damage from permitted sites.
4. Prior to closing out the permit to ensure the site complies with all plan and permit conditions and is permanently stabilized.

H. Compliance and Enforcement Options:

1. May require surety bond, cash, certified check, or irrevocable letter of credit (Section 9108).
2. Court Injunction (Section 9113).
3. Cease and Desist (Rule 1713).
4. Municipal Civil Infractions/Appearance Tickets if authorized in an ordinance [Section 9121(1)(a)].
5. Fines up to \$25,000 per day [Sections 9121(2) and (3)].
6. EA may construct, implement, and maintain SESC measures to bring a site into conformance with Part 91 and/or the local ordinance (Section 9119).
7. EA may bill the landowner for all expenses incurred in #6 above. If the landowner does not pay, the EA may place a lien on the property (Section 9120).
8. Stop work orders (if authorized in ordinance).
9. Double permit fee for starting work without permit (if authorized by ordinance or resolution).

I. Other EA Requirements:

1. The EA has 30 days to approve, disapprove, or require modification to a SESC plan or application [*Rule 1707(2)*].
2. Each individuals responsible for administering the EA's program who has decision-making authority for SESC plan development or review, inspections, permit issuance, or enforcement shall be trained by the MDEQ (*Section 91231*).

J. MDEQ Responsibilities:

1. Promulgate rules to administer Part 91 [*Sections 9104(1) and 9114*].
2. Approve resolutions and ordinances [*Sections 9105(4) and 9106(2)*].
3. Initially approve EAs [*Sections 9105(6) and 9106(3)*].
4. Periodically conduct performance reviews at least every five years and approve or disapprove the agency. The reviews evaluate all of the following: resolution/ordinance, staff training, forms (application, permit, and inspection), funding, adequacy of the inspections, adequacy of compliance and enforcement actions, and on-site conditions [*Sections 9105(6) and 9106(3); Rule 1713*].
 - a) If a CEA is not approved, the MDEQ can place the agency on probation, contract with a consultant to administer the county's SESC program, and bill the county for the cost of the contract including a 10% contract administration fee [*Sections 9106(8) and (11) and Section 9112(7)*].
 - b) If a MEA is not approved, the MDEQ can rescind the agencies designation [*Sections 9106(4) and 9112(7)*].
5. Make determinations and issue orders or stipulations of agreement [*Section 9112(7)*].
6. Inspect sites for compliance or non compliance with Part 91 and go to court to seek an injunction against a person to restrain or prevent violations of Part 91 (*Section 9113*) or other violations and penalties (*Section 9121*).
7. Develop and offer SESC training courses (*Section 9123*).
8. Determine minimum information (state-prescribed) to be included on the SESC application and permit forms [*Rules 1706(3) and 1707(3)*].

Authorized Public Agencies (APAs)

State and local units of government which commonly undertake earth changes can be designated APAs by the MDEQ after training staff and adopting SESC procedures which meet the requirements of Part 91. APAs are not required to obtain permits from enforcing agencies. Essentially, APAs are self-regulating with regard to earth changes. However, the primary objective is the same; protect waters of the state and adjacent properties from the effects of soil erosion and off-site sedimentation. Common agencies that are APAs include: Road Commissions, Drain Commissioners, Municipal Department of Public Works, the Michigan Department of Transportation, the Michigan Department of Management and Budget, and the MDEQ.

Key APA Facts

1. The agency must develop SESC Procedures, and submit them to the MDEQ for approval, detailing how the agency will address SESC on earth changes undertaken by the agency or on behalf of the agency [Section 9110(1)]. The SESC Procedures (and the APAs) must comply with all requirements of Part 91.
2. SESC plans that comply with *Rule 1703* requirements must be developed for all projects which would require a permit if the agency was not an APA; i.e. earth changes that disturb one or more acres; OR within 500 feet of the water's edge of a lake or stream. **Exception:** *For projects that are routinely undertaken by the agency, the agency may develop specific guidelines for undertaking those projects and if those guidelines are approved by the MDEQ, no SESC plans are required.*
3. APAs are exempt from obtaining permits from the EAs, but shall notify the EA of each proposed earth change [Rule 1706(4)].
4. Must perform and document inspections of earth changes [Section 9110(4)(c)].
5. Responsible for the actions of contractors and subcontractors for projects under the jurisdiction of the APA.
6. Each individual responsible for administering the APA's program who has decision-making authority for SESC plan development or review, inspections, or compliance and enforcement actions shall be trained by the MDEQ (Section 91231).

MDEQ Responsibilities:

1. Promulgate rules to administer Part 91 [Sections 9104(1) and 9114].
2. Approve SESC procedures and designate APAs [Sections 9110(2)].
3. Periodically conduct performance reviews at least every five years and approve or disapprove the agency [Section 9110(4); Rule 1713]. The reviews evaluate all of the following: SESC procedures, staff training, funding, adequacy of SESC plans, adequacy of inspections, compliance and enforcement efforts, and on-site conditions.
 - a) If the APA is not approved, the MDEQ can deny or revoke the agency's designation [Sections 9110(5) and 9112(7)].
4. Inspect sites for compliance or non-compliance with Part 91 and go to court to seek an injunction against a person to restrain or prevent violations of Part 91 (Section 9113).
5. Make determinations and issue orders or stipulations of agreement. [Section 9112(7)].
6. Pursue civil fines up to \$25,000 per day per violation for projects undertaken by APAs [Section 9121(3)].
7. Develop and offer SESC training courses (Section 9123).

Appendix 6A

**PART 91, SOIL EROSION AND SEDIMENTATION CONTROL
OF THE
NATURAL RESOURCES AND ENVIRONMENTAL PROTECTION ACT
1994 PA 451, AS AMENDED**

(Includes all amendments through 11-17-11)

324.9101 Definitions; A to W.

- Sec. 9101. (1) "Agricultural practices" means all land farming operations except the plowing or tilling of land for the purpose of crop production or the harvesting of crops.
- (2) "Authorized public agency" means a state agency or an agency of a local unit of government authorized under section 9110 to implement soil erosion and sedimentation control procedures with regard to earth changes undertaken by it.
- (3) "Conservation district" means a conservation district authorized under part 93.
- (4) "Consultant" means either of the following:
- (a) An individual who has a current certificate of training under section 9123.
 - (b) A person who employs 1 or more individuals who have current certificates of training under section 9123.
- (5) "County agency" means an officer, board, commission, department, or other entity of county government.
- (6) "County enforcing agency" means a county agency or a conservation district designated by a county board of commissioners under section 9105.
- (7) "County program" or "county's program" means a soil erosion and sedimentation control program established under section 9105.
- (8) "Department" means the department of environmental quality.
- (9) "Earth change" means a human-made change in the natural cover or topography of land, including cut and fill activities, which may result in or contribute to soil erosion or sedimentation of the waters of the state. Earth change does not include the practice of plowing and tilling soil for the purpose of crop production.
- (10) "Gardening" means activities necessary to the growing of plants for personal use, consumption, or enjoyment.
- (11) "Local ordinance" means an ordinance enacted by a local unit of government under this part providing for soil erosion and sedimentation control.
- (12) "Municipal enforcing agency" means an agency designated by a municipality under section 9106 to enforce a local ordinance.

- (13) "Municipality" means any of the following:
- (a) A city.
 - (b) A village.
 - (c) A charter township.
 - (d) A general law township that is located in a county with a population of 200,000 or more.
- (14) "Rules" means the rules promulgated pursuant to the administrative procedures act of 1969, 1969 PA 306, MCL 24.201 to 24.328.
- (15) "Seawall maintenance" means an earth change activity landward of the seawall.
- (16) "Sediment" means solid particulate matter, including both mineral and organic matter, that is in suspension in water, is being transported, or has been removed from its site of origin by the actions of wind, water, or gravity and has been deposited elsewhere.
- (17) "Soil erosion" means the wearing away of land by the action of wind, water, gravity, or a combination of wind, water, or gravity.
- (18) "State agency" means a principal state department or a state public university.
- (19) "Violation of this part" or "violates this part" means a violation of this part, the rules promulgated under this part, a permit issued under this part, or a local ordinance enacted under this part.
- (20) "Waters of the state" means the Great Lakes and their connecting waters, inland lakes and streams as defined in rules promulgated under this part, and wetlands regulated under part 303.

History: Add. 1995, Act 60, Imd. Eff. May 24, 1995 ;-- Am. 2000, Act 504, Imd. Eff. Jan. 11, 2001; -- Am. 2001, Act 227, Imd. Eff. Jan. 2, 2002 ;-- Am. 2005, Act 55, Imd. Eff. June 30, 2005

324.9102, 324.9103 Repealed. 2000, Act 504, Imd. Eff. Jan. 11, 2001.

Compiler's Notes: The repealed sections pertained to definitions and soil erosion and sedimentation control program.

324.9104 Rules; availability of information.

Sec. 9104. (1) The department, with the assistance of the department of agriculture, shall promulgate rules for a unified soil erosion and sedimentation control program, including provisions for the review and approval of site plans, land use plans, or permits relating to soil erosion control and sedimentation control. The department shall notify and make copies of proposed rules available to county enforcing agencies, municipal enforcing agencies, and authorized public agencies for review and comment before promulgation.

(2) The department shall make available to county enforcing agencies, municipal enforcing agencies, and authorized public agencies educational information on soil erosion and sedimentation control techniques and the benefits of implementing soil erosion and sedimentation control measures. County enforcing agencies and municipal enforcing agencies shall distribute this information to persons receiving permits under a county program or a local ordinance and to other interested persons.

History: Add. 1995, Act 60, Imd. Eff. May 24, 1995 ;-- Am. 2000, Act 504, Imd. Eff. Jan. 11, 2001

324.9105 Administration and enforcement of rules; resolution; ordinance; interlocal agreement; review; notice of results; informal meeting; probation; consultant; inspection fees; rescission of order, stipulation, or probation.

Sec. 9105. (1) Subject to subsection (6), a county is responsible for the administration and enforcement of this part and the rules promulgated under this part throughout the county except as follows:

- (a) Within a municipality that has assumed the responsibility for soil erosion and sedimentation control under section 9106.
- (b) With regard to earth changes of authorized public agencies.

(2) Subject to subsection (3), the county board of commissioners of each county, by resolution, shall designate a county agency, or a conservation district upon the concurrence of the conservation district, as the county enforcing agency responsible for administration and enforcement of this part and the rules promulgated under this part in the name of the county. The resolution may set forth a schedule of fees for inspections, plan reviews, and permits and may set forth other matters relating to the administration and enforcement of the county program and this part and the rules promulgated under this part.

(3) In lieu of or in addition to a resolution provided for in subsection (2), the county board of commissioners of a county may provide by ordinance for soil erosion and sedimentation control in the county. An ordinance adopted under this subsection may be more restrictive than, but shall not make lawful that which is unlawful under, this part and the rules promulgated under this part. If an ordinance adopted under this subsection is more restrictive than this part and the rules promulgated under this part, the county enforcing agency shall notify a person receiving a permit under the ordinance that the ordinance is more restrictive than this part and the rules promulgated under this part. The ordinance shall incorporate by reference the rules promulgated under this part that do not

conflict with a more restrictive ordinance and may set forth such other matters as the county board of commissioners considers necessary or desirable. The ordinance may provide penalties for a violation of the ordinance that are consistent with section 9121.

- (4) A copy of a resolution or ordinance adopted under this section and all subsequent amendments to the resolution or ordinance shall be forwarded to the department for the department's review and approval. The department shall forward a copy to the conservation district for that county for review and comment.
- (5) Two or more counties may provide for joint enforcement and administration of this part and the rules promulgated under this part by entering into an interlocal agreement pursuant to the urban cooperation act of 1967, 1967 (Ex Sess) PA 7, MCL 124.501 to 124.512.
- (6) The department shall conduct a review of a county's program every 5 years. The review shall be conducted at least 6 months before the expiration of each succeeding 5-year period. The department shall approve a county's program if all of the following conditions are met:
 - (a) The county has passed a resolution or enacted an ordinance as provided in this section.
 - (b) The individuals with decision-making authority who are responsible for administering the county program have current certificates of training under section 9123.
 - (c) The county has effectively administered and enforced the county program in the past 5 years or has implemented changes in its administration or enforcement procedures that the department determines will result in the county effectively administering and enforcing the county program. In determining whether the county has met the requirement of this subdivision, the department shall consider all of the following:
 - (i) Whether a mechanism is in place to provide funding to administer the county's program.
 - (ii) Whether the county has conducted adequate inspections to assure minimization of soil erosion and off-site sedimentation.
 - (iii) The effectiveness of the county's past compliance and enforcement efforts.
 - (iv) The adequacy and effectiveness of the applications and soil erosion and sedimentation control plans being accepted by the county.
 - (v) The adequacy and effectiveness of the permits issued by the county and the inspections being performed by the county.
 - (vi) The conditions at construction sites under the jurisdiction of the county as documented by departmental inspections.
- (7) Following a review under subsection (6), the department shall notify the county of the results of its review and whether the department proposes to approve or disapprove the county's program. Within 30 days of receipt of the notice under this subsection, a county may request and the department shall hold an informal meeting to discuss the review and the proposed action by the department.

- (8) Following the meeting under subsection (7), if requested, and consideration of the review under subsection (6), if the department does not approve a county's program, the department shall enter an order, stipulation, or consent agreement under section 9112(7) placing the county on probation. In addition, at any time that the department determines that a county that was previously approved by the department under subsection (6) is not satisfactorily administering and enforcing the county's program, the department shall enter into an order, stipulation, or consent agreement under section 9112(7) placing the county on probation. During the 6-month period after a county is placed on probation, the department shall consult with the county on how the county could change its administration of the county program in a manner that would result in its approval.
- (9) Within 6 months after a county has been placed on probation under subsection (8), the county may notify the department that it intends to hire a consultant to administer the county's program. If, within 60 days after notifying the department, the county hires a consultant that is acceptable to the department, then within 1 year after the county hires the consultant, the department shall conduct a review of the county's program to determine whether or not the county program can be approved.
- (10) If any of the following occur, the department shall hire a consultant to administer the county's program:
- (a) The county does not notify the department of its intent to hire a consultant under subsection (9).
 - (b) The county does not hire a consultant that is acceptable to the department within 60 days after notifying the department of its intent to hire a consultant under subsection (9).
 - (c) The county remains unapproved following the department's review under subsection (9).
- (11) Upon hiring a consultant under subsection (10), the department may establish a schedule of fees for inspections, review of soil erosion and sedimentation control plans, and permits for the county's program that will provide sufficient revenues to pay for the cost of the contract with the consultant, or the department may bill the county for the cost of the contract with the consultant. As used in this subsection, "cost of the contract" means the actual cost of a contract with a consultant plus the documented costs to the department in administering the contract, but not to exceed 10% of the actual cost of the contract.
- (12) At any time that a county is on probation as provided for in this section, the county may request the department to conduct a review of the county's program. If, upon such review, the county has implemented appropriate changes to the county's program, the department shall approve the county's program. If the department approves a county's program under this subsection, the department shall rescind its order, stipulation, or consent agreement that placed the county on probation.

History: Add. 1995, Act 60, Imd. Eff. May 24, 1995 ;-- Am. 2000, Act 504, Imd. Eff. Jan. 11, 2001 ;-- Am. 2005, Act 55, Imd. Eff. June 30, 2005

324.9106 Ordinances.

Sec. 9106. (1) Subject to subsection (3), a municipality by ordinance may provide for soil erosion and sedimentation control on public and private earth changes within its boundaries except that a township ordinance shall not be applicable within a village that has in effect such an ordinance. An ordinance may be more restrictive than, but shall not make lawful that which is unlawful under, this part and the rules promulgated under this part. If an ordinance adopted under this section is more restrictive than this part and the rules promulgated under this part, the municipal enforcing agency shall notify a person receiving a permit under the ordinance that the ordinance is more restrictive than this part and the rules promulgated under this part. The ordinance shall incorporate by reference the rules promulgated under this part that do not conflict with a more restrictive ordinance, shall designate a municipal enforcing agency responsible for administration and enforcement of the ordinance, and may set forth such other matters as the legislative body considers necessary or desirable. The ordinance shall be applicable and shall be enforced with regard to all private and public earth changes within the municipality except earth changes by an authorized public agency. The municipality may consult with a conservation district for assistance or advice in the preparation of the ordinance. The ordinance may provide penalties for a violation of the ordinance that are consistent with section 9121.

(2) An ordinance related to soil erosion and sedimentation control that is not approved by the department as conforming to the minimum requirements of this part and the rules promulgated under this part has no force or effect. A municipality shall submit a copy of its proposed ordinance or of a proposed amendment to its ordinance to the department for approval before adoption. The department shall forward a copy to the county enforcing agency of the county in which the municipality is located and the appropriate conservation district for review and comment. Within 90 days after the department receives an existing ordinance, proposed ordinance, or amendment, the department shall notify the clerk of the municipality of its approval or disapproval along with recommendations for revision if the ordinance, proposed ordinance, or amendment does not conform to the minimum requirements of this part or the rules promulgated under this part. If the department does not notify the clerk of the local unit within the 90-day period, the ordinance, proposed ordinance, or amendment shall be considered to have been approved by the department.

(3) A municipality shall not administer and enforce this part or the rules promulgated under this part or a local ordinance unless the department has approved the municipality. An approval under this section is valid for 5 years, after which the department shall review the municipality for reapproval. At least 6 months before the expiration of each succeeding 5-year approval period, the department shall complete a review of the municipality for reapproval. The department shall approve a municipality if all of the following conditions are met:

(a) The municipality has enacted an ordinance as provided in this section that is at least as restrictive as this part and the rules promulgated under this part.

- (b) The individuals with decision-making authority who are responsible for administering the soil erosion and sedimentation control program for the municipality have current certificates of training under section 9123.
 - (c) The municipality has submitted evidence of its ability to effectively administer and enforce a soil erosion and sedimentation control program. In determining whether the municipality has met the requirements of this subdivision, the department shall consider all of the following:
 - (i) Whether a mechanism is in place to provide funding to administer the municipality's soil erosion and sedimentation control program.
 - (ii) The adequacy of the documents proposed for use by the municipality including, but not limited to, application forms, soil erosion and sedimentation control plan requirements, permit forms, and inspection reports.
 - (iii) If the municipality has previously administered a soil erosion and sedimentation control program, whether the municipality effectively administered and enforced the program in the past or has implemented changes in its administration or enforcement procedures that the department determines will result in the municipality effectively administering and enforcing a soil erosion and sedimentation control program in compliance with this part and the rules promulgated under this part. In determining whether the municipality has met the requirement of this subparagraph, the department shall consider all of the following:
 - (A) Whether the municipality has had adequate funding to administer the municipality's soil erosion and sedimentation control program.
 - (B) Whether the municipality has conducted adequate inspections to assure minimization of soil erosion and off-site sedimentation.
 - (C) The effectiveness of the municipality's past compliance and enforcement efforts.
 - (D) The adequacy and effectiveness of the applications and soil erosion and sedimentation control plans being accepted by the municipality.
 - (E) The adequacy and effectiveness of the permits issued by the municipality and the inspections being performed by the municipality.
 - (F) The conditions at construction sites under the jurisdiction of the municipality as documented by departmental inspections.
- (4) If the department determines that a municipality is not approved under subsection (3) or that a municipality that was previously approved under subsection (3) is not satisfactorily administering and enforcing this part and the rules promulgated under this part, the department shall enter an order, stipulation, or consent agreement under section 9112(7) denying the municipality authority or revoking the municipality's authority to administer a soil erosion and sedimentation control program. Upon entry of this order, stipulation, or consent agreement, the county program for the county in which the municipality is located becomes operative within the municipality.

- (5) A municipality that elects to rescind its ordinance shall notify the department. Upon rescission of its ordinance, the county program for the county in which the municipality is located becomes operative within the municipality.
- (6) A municipality that rescinds its ordinance or is not approved by the department to administer the program shall retain jurisdiction over projects under permit at that time. The municipality shall retain jurisdiction until the projects are completed and stabilized or the county agrees to assume jurisdiction over the permitted earth changes.

History: Add. 1995, Act 60, Imd. Eff. May 24, 1995 ;-- Am. 2000, Act 504, Imd. Eff. Jan. 11, 2001 ;-- Am. 2005, Act 55, Imd. Eff. June 30, 2005

324.9107 Notice of violation.

Sec. 9107. If a local unit of government has notice that a violation of this part has occurred within the boundaries of that local unit of government, including but not limited to a violation attributable to an earth change by an authorized public agency, the local unit of government shall notify the appropriate county enforcing agency and municipal enforcing agency and the department of the violation.

History: Add. 1995, Act 60, Imd. Eff. May 24, 1995 ;-- Am. 2000, Act 504, Imd. Eff. Jan. 11, 2001

324.9108 Permit; deposit as condition for issuance.

Sec. 9108. As a condition for the issuance of a permit, the county enforcing agency or municipal enforcing agency may require the applicant to deposit with the clerk of the county or municipality in the form of cash, a certified check, or an irrevocable bank letter of credit, whichever the applicant selects, or a surety bond acceptable to the legislative body of the county or municipality or to the county enforcing agency or municipal enforcing agency, in an amount sufficient to assure the installation and completion of such protective or corrective measures as may be required by the county enforcing agency or municipal enforcing agency.

History: Add. 1995, Act 60, Imd. Eff. May 24, 1995 ;-- Am. 2000, Act 504, Imd. Eff. Jan. 11, 2001

324.9109 Agreement between public agency or county or municipal enforcing agency and conservation district; purpose; reviews and evaluations of agency's programs or procedures; agreement between person engaged in agricultural practices and conservation district; notification; enforcement.

Sec. 9109. (1) An authorized public agency, county enforcing agency, or municipal enforcing agency may enter into an agreement with a conservation district for assistance and advice in overseeing and reviewing compliance with soil erosion and sedimentation control procedures and in reviewing existing or proposed earth changes, earth change plans, or site plans with regard to technical matters pertaining to soil erosion and sedimentation control. In addition to or in the absence of such agreements, conservation districts may perform periodic reviews and evaluations of the authorized public agency's, county enforcing

agency's, or municipal enforcing agency's programs or procedures pursuant to standards and specifications developed in cooperation with the respective districts and as approved by the department. These reviews and evaluations shall be submitted to the department for appropriate action.

- (2) A person engaged in agricultural practices may enter into an agreement with the appropriate conservation district to pursue agricultural practices in accordance with and subject to this part, the rules promulgated under this part, and any applicable local ordinance. If a person enters into an agreement with a conservation district, the conservation district shall notify the county enforcing agency or municipal enforcing agency or the department in writing of the agreement. Upon entering into the agreement under this subsection, a person is not subject to permits required under this part, but is required to develop project specific soil erosion and sedimentation control plans and is subject to the remedies provided for in this part for violations of this part.

History: Add. 1995, Act 60, Imd. Eff. May 24, 1995 ;-- Am. 2000, Act 504, Imd. Eff. Jan. 11, 2001

324.9110 Designation as authorized public agency; application; submission of procedures; variance; approval.

Sec. 9110. (1) Subject to subsection (4), a state agency or an agency of a local unit of government may apply to the department for designation as an authorized public agency by submitting to the department the soil erosion and sedimentation control procedures governing all earth changes normally undertaken by the agency. If the applicant is an agency of a local unit of government, the department shall submit the procedures to the county enforcing agency and the appropriate conservation district for review. The county enforcing agency and the conservation district shall submit their comments on the procedures to the department within 60 days. If the applicant is a state agency, the department shall submit the procedures to the department of agriculture for review, and the department of agriculture shall submit its comments on the procedures to the department within 60 days.

- (2) Subject to subsection (4), if the department finds that the soil erosion and sedimentation control procedures of the state agency or the agency of the local unit of government meet the requirements of this part and rules promulgated under this part, the department shall designate the agency as an authorized public agency.
- (3) Subject to subsection (4), after approval of the procedures and designation as an authorized public agency pursuant to subsection (2), all earth changes maintained or undertaken by the authorized public agency shall be undertaken pursuant to the approved procedures. If determined necessary by the department and upon request of an authorized public agency, the department may grant a variance from the provisions of this subsection.
- (4) A state agency or an agency of a local unit of government shall not administer and enforce this part and the rules promulgated under this part as an authorized

public agency unless the department has approved the agency under this section. An approval under this section is valid for 5 years, after which the department shall review the agency for reapproval. At least 6 months before the expiration of each succeeding 5-year period, the department shall complete a review of the authorized public agency for reapproval. The department shall approve a state agency or an agency of a local unit of government if all of the following conditions are met:

- (a) The agency has adopted soil erosion and sedimentation control procedures that are at least as restrictive as this part and the rules promulgated under this part.
 - (b) The individuals with decision-making authority who are responsible for administering the soil erosion and sedimentation control procedures have current certificates of training under section 9123.
 - (c) The agency has submitted evidence of its ability to effectively administer soil erosion and sedimentation control procedures. In determining whether the agency has met the requirement of this subdivision, the department shall consider all of the following:
 - (i) Funding to administer the agency's soil erosion and sedimentation control program.
 - (ii) The agency's plans for inspections to assure minimization of soil erosion and off-site sedimentation.
 - (iii) The adequacy of the agency's soil erosion and sedimentation control procedures.
 - (iv) If the agency has previously administered soil erosion and sedimentation control procedures, the agency has effectively administered these procedures or has implemented changes in their administration that the department determines will result in the agency effectively administering the soil erosion and sedimentation control procedures. In determining whether the agency has met the requirement of this subparagraph, the department shall consider all of the following:
 - (A) Whether the agency has had adequate funding to administer the agency's soil erosion and sedimentation control program.
 - (B) Whether the agency has conducted adequate inspections to assure minimization of soil erosion and off-site sedimentation.
 - (C) The effectiveness of the agency's past compliance and enforcement efforts.
 - (D) The adequacy of the agency's soil erosion and sedimentation control plans and procedures as required by rule.
 - (E) The conditions at construction sites under the jurisdiction of the agency as documented by departmental inspections.
- (5) If the department determines that a state agency or an agency of a local unit of government is not approved under subsection (4) or that a state agency or an agency of a local unit of government that was previously approved under subsection (4) is not satisfactorily administering and enforcing this part and the rules promulgated under this part, the department shall enter an order, stipulation, or consent agreement under section 9112(7) denying or revoking the

designation of the state agency or agency of a local unit of government as an authorized public agency.

History: Add. 1995, Act 60, Imd. Eff. May 24, 1995 ;-- Am. 2000, Act 504, Imd. Eff. Jan. 11, 2001;-- Am. 2005, Act 55, Imd. Eff. June 30, 2005

324.9111 Repealed. 2000, Act 504, Imd. Eff. Jan. 11, 2001.

Compiler's Notes: The repealed section pertained to statements and certificates relating to plats.

324.9112 Earth change; permit required; effect of property transfer; violation; notice; hearing; answer; evidence; stipulation or consent order; final order of determination.

Sec. 9112. (1) A person shall not maintain or undertake an earth change governed by this part, the rules promulgated under this part, or an applicable local ordinance, except in accordance with this part and the rules promulgated under this part or with the applicable local ordinance, and except as authorized by a permit issued by the appropriate county enforcing agency or municipal enforcing agency pursuant to part 13.

- (2) The owner of property that is subject to a permit under this part is responsible for compliance with the terms of the permit that apply to that property.
- (3) Except as provided in subsection (4), if property subject to a permit under this part is transferred, both of the following are transferred with the property:
 - (a) The permit, including the permit obligations and conditions.
 - (b) Responsibility for any violations of the permit that exist on the date the property is transferred.
- (4) If property is subject to a permit under this part and a parcel of the property, but not the entire property, is transferred, both of the following are transferred with the parcel:
 - (a) The permit obligations and conditions with respect to that parcel, but not the permit itself.
 - (b) Responsibility for any violations of the permit with respect to that parcel that exist on the date the parcel is transferred.
- (5) If property subject to a permit under this part is proposed to be transferred, the transferor shall notify the transferee of the permit in writing on a form developed by the department and provided by the county enforcing agency or municipal enforcing agency. The notice shall inform the transferee of the requirements of subsection (2) and, as applicable, subsection (3) or (4). The notice shall include a copy of the permit. The transferor and transferee shall sign the notice, and the transferor shall submit the signed notice to the county enforcing agency or municipal enforcing agency before the property is transferred.

- (6) A county enforcing agency or municipal enforcing agency may charge a fee for the transfer of a permit under subsection (3) or (4). The fee shall not exceed the administrative costs of transferring the permit. Fees collected under this subsection shall only be used for the enforcement and administration of this part by the enforcing agency.
- (7) If in the opinion of the department a person, including an authorized public agency, violates this part, the rules promulgated under this part, or an applicable local ordinance, or a county enforcing agency or municipal enforcing agency fails to enforce this part, the rules promulgated under this part, or an applicable local ordinance, the department may notify the alleged offender in writing of its determination. If the department places a county on probation under section 9105, a municipality is not approved under section 9106, or a state agency or agency of a local unit of government is not approved under section 9110, or if the department determines that a municipal enforcing agency or authorized public agency is not satisfactorily administering and enforcing this part and rules promulgated under this part, the department shall notify the county, municipality, state agency, or agency of a local unit of government in writing of its determination or action. The notice shall contain, in addition to a statement of the specific violation or failure that the department believes to exist, a proposed order, stipulation for agreement, or other action that the department considers appropriate to assure timely correction of the violation or failure. The notice shall set a date for a hearing not less than 4 nor more than 8 weeks from the date of the notice of determination. Extensions of the date of the hearing may be granted by the department or on request. At the hearing, any interested party may appear, present witnesses, and submit evidence. A person who has been served with a notice of determination may file a written answer to the notice of determination before the date set for hearing or at the hearing may appear and present oral or written testimony and evidence on the charges and proposed requirements of the department to assure correction of the violation or failure. If a person served with the notice of determination agrees with the proposed requirements of the department and notifies the department of that agreement before the date set for the hearing, disposition of the case may be made with the approval of the department by stipulation or consent agreement without further hearing. The final order of determination following the hearing, or the stipulation or consent order as authorized by this section and approved by the department, is conclusive unless reviewed in accordance with the administrative procedures act of 1969, 1969 PA 306, MCL 24.201 to 24.328, in the circuit court of Ingham county, or of the county in which the violation occurred, upon petition filed within 15 days after the service upon the person of the final order of determination.

History: Add. 1995, Act 60, Imd. Eff. May 24, 1995 ;-- Am. 2000, Act 504, Imd. Eff. Jan. 11, 2001 ;-- Am. 2004, Act 325, Imd. Eff. Sept. 10, 2004 ;-- Am. 2004, Act 565, Imd. Eff. Jan. 3, 2005

324.9113 Injunction; inspection and investigation.

Sec. 9113. (1) Notwithstanding the existence or pursuit of any other remedy, the department or a county enforcing agency or municipal enforcing agency may maintain an action in its own name in a court of competent jurisdiction for an

injunction or other process against a person to restrain or prevent violations of this part.

- (2) At any reasonable time, an agent appointed by the department, a county enforcing agency, or a municipal enforcing agency may enter upon any private or public property for the purpose of inspecting and investigating conditions or practices that may be in violation of this part. However, an investigation or inspection under this subsection shall comply with the United States constitution and the state constitution of 1963.

History: Add. 1995, Act 60, Imd. Eff. May 24, 1995 ;-- Am. 2000, Act 504, Imd. Eff. Jan. 11, 2001 ;-- Am. 2005, Act 55, Imd. Eff. June 30, 2005

324.9114 Additional rules.

Sec. 9114. In order to carry out their functions under this part, the department and the department of agriculture may promulgate rules in addition to those otherwise authorized in this part.

History: Add. 1995, Act 60, Imd. Eff. May 24, 1995

324.9115 Logging, mining, or land plowing or tilling; permit exemption; “mining” defined.

Sec. 9115. (1) Subject to subsection (2), a person engaged in the logging industry, the mining industry, or the plowing or tilling of land for the purpose of crop production or the harvesting of crops is not required to obtain a permit under this part. However, all earth changes associated with the activities listed in this section shall conform to the same standards as if they required a permit under this part. The exemption from obtaining a permit under this subsection does not include either of the following:

- (a) Access roads to and from the site where active mining or logging is taking place.
 - (b) Ancillary activities associated with logging and mining.
- (2) This part does not apply to a metallic mineral mining activity that is regulated under a mining and reclamation plan or a mining, reclamation, and environmental protection plan if the plan contains soil erosion and sedimentation control provisions and is approved by the department under part 631 or 632, respectively.
 - (3) A person is not required to obtain a permit from a county enforcing agency or a municipal enforcing agency for earth changes associated with well locations, surface facilities, flowlines, or access roads relating to oil or gas exploration and development activities regulated under part 615, if the application for a permit to drill and operate under part 615 contains a soil erosion and sedimentation control plan that is approved by the department under part 615. However, those earth changes shall conform to the same standards as required for a permit under this

part. This subsection does not apply to a multisource commercial hazardous waste disposal well as defined in section 62506a.

- (4) As used in this section, "mining" does not include the removal of clay, gravel, sand, peat, or topsoil.

History: Add. 1995, Act 60, Imd. Eff. May 24, 1995;³/₄Am. 2000, Act 504, Imd. Eff. Jan. 11, 2001;³/₄Am. 2011, Act 214, Imd. Eff. Nov. 8, 2011.

324.9115a Earth change activities not requiring permit; violations.

Sec. 9115a. (1) A residential property owner who causes the following activities to be conducted on individual residential property owned and occupied by him or her is not required to obtain a permit under this part if the earth change activities do not result in or contribute to soil erosion or sedimentation of the waters of the state or a discharge of sediment off-site:

- (a) An earth change of a minor nature that is stabilized within 24 hours of the initial earth disturbance.
- (b) Gardening, if the natural elevation of the area is not raised.
- (c) Post holes for fencing, decks, utility posts, mailboxes, or similar applications, if no additional grading or earth change occurs for use of the post holes.
- (d) Removal of tree stumps, shrub stumps, or roots resulting in an earth change not to exceed 100 square feet.
- (e) All of the following activities, if soil erosion and sedimentation controls are implemented, the earth change is stabilized within 24 hours of the initial earth disturbance, and soil erosion or sedimentation to adjacent properties or the waters of the state has not or will not reasonably occur:
 - (i) Planting of trees, shrubs, or other similar plants.
 - (ii) Seeding or reseeded of lawns of less than 1 acre if the seeded area is at least 100 feet from the waters of the state.
 - (iii) Seeding or reseeded of lawns closer than 100 feet from the waters of the state if the area to be seeded or reseeded does not exceed 100 square feet.
 - (iv) The temporary stockpiling of soil, sand, or gravel not greater than a total of 10 cubic yards on the property if the stockpiling occurs at least 100 feet from the waters of the state.
 - (v) Seawall maintenance that does not exceed 100 square feet.

- (2) Exemptions provided in this section shall not be construed as exemptions from enforcement procedures under this part or the rules promulgated under this part if the exempted activities cause or result in a violation of this part or the rules promulgated under this part.

History: Add. 2005, Act 56, Imd. Eff. June 30, 2005

324.9116 Reduction of soil erosion or sedimentation by owner.

Sec. 9116. A person who owns land on which an earth change has been made that may result in or contribute to soil erosion or sedimentation of the waters of the state

shall implement and maintain soil erosion and sedimentation control measures that will effectively reduce soil erosion or sedimentation from the land on which the earth change has been made.

History: Add. 1995, Act 60, Imd. Eff. May 24, 1995

324.9117 Notice of determination.

Sec. 9117. If the county enforcing agency or municipal enforcing agency that is responsible for enforcing this part and the rules promulgated under this part determines that soil erosion or sedimentation of adjacent properties or the waters of the state has or will reasonably occur from land in violation of this part or the rules promulgated under this part or an applicable local ordinance, the county enforcing agency or municipal enforcing agency may seek to enforce a violation of this part by notifying the person who owns the land, by mail, with return receipt requested, of its determination. The notice shall contain a description of the violation and what must be done to remedy the violation and shall specify a time to comply with this part and the rules promulgated under this part or an applicable local ordinance.

History: Add. 1995, Act 60, Imd. Eff. May 24, 1995 ;-- Am. 2000, Act 504, Imd. Eff. Jan. 11, 2001

324.9118 Compliance; time.

Sec. 9118. Within 5 days after a notice of violation has been issued under section 9117, a person who owns land subject to this part and the rules promulgated under this part shall implement and maintain soil erosion and sedimentation control measures in conformance with this part, the rules promulgated under this part, or an applicable local ordinance.

History: Add. 1995, Act 60, Imd. Eff. May 24, 1995 ;-- Am. 2000, Act 504, Imd. Eff. Jan. 11, 2001

324.9119 Entry upon land; construction, implementation, and maintenance of soil erosion and sedimentation control measures; cost.

Sec. 9119. Except as otherwise provided in this section, not sooner than 5 days after notice of violation of this part has been mailed under section 9117, if the condition of the land, in the opinion of the county enforcing agency or municipal enforcing agency, may result in or contribute to soil erosion or sedimentation of adjacent properties or to the waters of the state, and if soil erosion and sedimentation control measures in conformance with this part and the rules promulgated under this part or an applicable local ordinance are not in place, the county enforcing agency or municipal enforcing agency, or a designee of either of these agencies, may enter upon the land and construct, implement, and maintain soil erosion and sedimentation control measures in conformance with this part and the rules promulgated under this part or an applicable local

ordinance. However, the enforcing agency shall not expend more than \$10,000.00 for the cost of the work, materials, labor, and administration without prior written notice in the notice provided in section 9117 for the person who owns the land that the expenditure of more than \$10,000.00 may be made. If more than \$10,000.00 is to be expended under this section, then the work shall not begin until at least 10 days after the notice of violation has been mailed.

History: Add. 1995, Act 60, Imd. Eff. May 24, 1995 ;-- Am. 2000, Act 504, Imd. Eff. Jan. 11, 2001
324.9120 Reimbursement of county or municipal enforcing agency; lien for expenses; priority; collection and treatment of lien.

Sec. 9120. (1) All expenses incurred by a county enforcing agency or a municipal enforcing agency under section 9119 to construct, implement, and maintain soil erosion and sedimentation control measures to bring land into conformance with this part and the rules promulgated under this part or an applicable local ordinance shall be reimbursed to the county enforcing agency or municipal enforcing agency by the person who owns the land.

(2) The county enforcing agency or municipal enforcing agency shall have a lien for the expenses incurred under section 9119 of bringing the land into conformance with this part and the rules promulgated under this part or an applicable local ordinance. However, with respect to single-family or multifamily residential property, the lien for such expenses shall have priority over all liens and encumbrances filed or recorded after the date of such expenditure. With respect to all other property, the lien for such expenses shall be collected and treated in the same manner as provided for property tax liens under the general property tax act, 1893 PA 206, MCL 211.1 to 211.157.

History: Add. 1995, Act 60, Imd. Eff. May 24, 1995 ;-- Am. 2000, Act 504, Imd. Eff. Jan. 11, 20

324.9121 Violations; penalties.

- Sec. 9121. (1) A person who violates this part is responsible for either of the following:
- (a) If the action is brought by a county enforcing agency or a municipal enforcing agency of a local unit of government that has enacted an ordinance under this part that provides a penalty for violations, the person is responsible for a municipal civil infraction and may be ordered to pay a civil fine of not more than \$2,500.00.
 - (b) If the action is brought by the state or a county enforcing agency of a county that has not enacted an ordinance under this part, the person is responsible for a state civil infraction and may be ordered to pay a civil fine of not more than \$2,500.00.
- (2) A person who knowingly violates this part or knowingly makes a false statement in an application for a permit or in a soil erosion and sedimentation control plan is responsible for the payment of a civil fine of not more than \$10,000.00 for each day of violation.

- (3) A person who knowingly violates this part after receiving a notice of determination under section 9112 or 9117 is responsible for the payment of a civil fine of not less than \$2,500.00 or more than \$25,000.00 for each day of violation.
- (4) Civil fines collected under subsections (2) and (3) shall be deposited as follows:
 - (a) If the state filed the action under this section, in the general fund of the state.
 - (b) If a county enforcing agency or municipal enforcing agency filed the action under this section, with the county or municipality that filed the action.
 - (c) If an action was filed jointly by the state and a county enforcing agency or municipal enforcing agency, the civil fines collected under this subsection shall be divided in proportion to each agency's involvement as mutually agreed upon by the agencies. All fines going to the department shall be deposited into the general fund of the state.
- (5) A default in the payment of a civil fine or costs ordered under this section or an installment of the fine or costs may be remedied by any means authorized under the revised judicature act of 1961, 1961 PA 236, MCL 600.101 to 600.9948.
- (6) In addition to a fine assessed under this section, a person who violates this part is liable to the state for damages for injury to, destruction of, or loss of natural resources resulting from the violation. The court may order a person who violates this part to restore the area or areas affected by the violation to their condition as existing immediately prior to the violation.
- (7) This section applies to an authorized public agency, in addition to other persons. This section does not apply to a county enforcing agency or a municipal enforcing agency with respect to its administration and enforcement of this part and rules promulgated under this part.

History: Add. 1995, Act 60, Imd. Eff. May 24, 1995 ;-- Am. 1996, Act 173, Imd. Eff. Apr. 18, 1996 ;-- Am. 2000, Act 504, Imd. Eff. Jan. 11, 2001

324.9122 Severability.

Sec. 9122. If any provision of this part is declared by a court to be invalid, the invalid provision shall not affect the remaining provisions of the part that can be given effect without the invalid provision. The validity of the part as a whole or in part shall not be affected, other than the provision invalidated.

History: Add. 1995, Act 60, Imd. Eff. May 24, 1995

324.9123 Training program; certificate; fees.

- Sec. 9123. (1) Beginning 3 years after the effective date of the 2000 amendments to this section, each individual who is responsible for administering this part and the rules promulgated under this part or a local ordinance and who has decision-making authority for soil erosion and sedimentation control plan development or review, inspections, permit issuance, or enforcement shall be trained by the department. The department shall issue a certificate of training to individuals under this section if they do both of the following:
- (a) Complete a soil erosion and sedimentation control training program sponsored by the department.
 - (b) Pass an examination on the subject matter covered in the training program under subdivision (a).
- (2) A certificate of training under subsection (1) is valid for 5 years. For recertifications, the department may offer a refresher course or other update in lieu of the requirements of subsection (1)(a) and (b).
- (3) The department may charge fees for administering the training program and the examination under this section that are not greater than the department's cost of administering the training program and the examination. All fees collected under this section shall be deposited into the soil erosion and sedimentation control training fund created in section 9123a.

History: Add. 1995, Act 60, Imd. Eff. May 24, 1995 ;-- Am. 2000, Act 504, Imd. Eff. Jan. 11, 2001

324.9123a Soil erosion and sedimentation control training fund; creation; disposition of funds; lapse; expenditures.

- Sec. 9123a. (1) The soil erosion and sedimentation control training fund is created within the state treasury.
- (2) The state treasurer may receive money or other assets from any source for deposit into the soil erosion and sedimentation control training fund. The state treasurer shall direct the investment of the soil erosion and sedimentation control training fund. The state treasurer shall credit to the soil erosion and sedimentation control training fund interest and earnings from fund investments.
 - (3) Money in the soil erosion and sedimentation control training fund at the close of the fiscal year shall remain in the fund and shall not lapse to the general fund.
 - (4) The department shall expend money from the fund, upon appropriation, only to administer the soil erosion and sedimentation control training program and examination under section 9123.

History: Add. 2000, Act 504, Imd. Eff. Jan. 11, 2001

UNIT SIX Part 91 STATUTE REVIEW

1. "Department" means the _____.
2. "Earth change" means a _____-_____ change in _____ or _____ of land, including cut and fill activities, which may result in or contribute to soil erosion or sedimentation of the waters of the state. Earth change does not include the practice of plowing and tilling soil for the purpose of crop production.
3. "Municipality" means a: _____, _____, _____ or _____ township that is located in a county with a population of _____ or more.
4. The county is responsible for administering and enforcing Part 91 throughout the county except for the following two situations:
 - a. within a _____ that has assumed _____ for soil erosion and sedimentation control (SESC) under section 9106
 - b. with regard to earth changes of _____ agencies
5. A county can administer Part 91 by _____ or by adopting an _____ by the Department. Both must be _____ and _____ by the Department.
6. An ordinance adopted by a county may be more _____ than Part 91 and the rules promulgated under Part 91.
7. After the initial review, the Department shall conduct a review of the county's program every _____ years.
8. If a county does not improve its SESC Program within six months of being placed on probation, the Department shall hire a _____.
9. A municipality can administer and enforce Part 91 by adopting an _____ that is _____ by the Department. Prior to approving the ordinance, the Department shall forward a copy of the proposed ordinance to the _____ agency and the appropriate _____ for review and _____.
10. The ordinance adopted by the municipality may be more _____ than Part 91 and the rules promulgated under Part 91.
11. A municipality shall not administer or enforce Part 91 unless the Department has _____ the municipality.
12. As a condition for the issuance of a permit, the county or municipal enforcing agency may require _____, a _____, an _____ of credit or a _____ bond in an amount sufficient to assure the installation and completion of protective or corrective measures.

13. A person engaged in agricultural practices may enter into an _____ with the appropriate _____ in lieu of obtaining a permit.
14. A state agency or an agency of a local unit of government may apply to the Department for designation as an _____ by submitting the SESC _____ governing all earth changes normally undertaken by the agency.
15. If the Department approves the program of a county enforcing agency, municipal enforcing agency, or authorized public agency, the approval is valid for ____ years.
16. The Department, a county enforcing agency, or municipal enforcing agency may go to court for an _____ or other process against a person to restrain or prevent violations of Part 91.
17. The following activities are not required to obtain a SESC permit:
 - a. a person engaged in the _____ industry, the _____ industry, or the _____ and _____ for the purpose of crop production
 - b. _____ mineral _____ regulated under Part 631 of the Natural Resources and Environmental Protection Act (NREPA)
 - c. activities related to _____ or _____ exploration or development regulated on Part 615 of the NREPA
18. Although a person engaged in the activities identified in 17a and 17c is not required to obtain a SESC permit, the activities shall conform to the _____ as if a permit was required.
19. As used in Part 91, mining does not include the removal of _____, _____, _____, _____, or _____. A SESC permit is required for these activities.
20. Within ____ days after notice of a violation, a person shall implement and maintain SESC measures in conformance with Part 91.
21. A person who violates Part 91 is responsible for a _____ or _____ civil infraction and may be ordered to pay a civil fine of not more than _____.
22. A person who knowingly violates this part is responsible for the payment of a civil fine of not more than _____ per _____ of violation. A person who knowingly violates this part after receiving a notice of determination is responsible for the payment of a civil fine of not less than _____ or more than _____ for each day of violation.
23. A certificate of training is valid for _____ years.

ANSWERS TO UNIT SIX PART 91 STATUTE REVIEW

1. "Department" means the **Department of Environmental Quality**.
2. "Earth change" means a **human-made** change in **natural cover** or **topography** of land, including cut and fill activities, which may result in or contribute to soil erosion or sedimentation of the waters of the state. Earth change does not include the practice of plowing and tilling soil for the purpose of crop production.
3. "Municipality" means a: **city, village, charter township, or general law township** that is located in a county with a population of **200,000** or more
4. The county is responsible for administering and enforcing Part 91 throughout the county except for the following two situations:
 - a. within a **municipality** that has assumed **responsibility** for soil erosion and sedimentation control (SESC) under section 9106
 - b. with regard to earth changes of **authorized public** agencies
5. A county can administer Part 91 by **resolution** or by adopting an **ordinance**. Both must be **reviewed** and **approved** by the Department.
6. An ordinance adopted by a county may be more **restrictive** than Part 91 and the rules promulgated under Part 91.
7. After the initial review, the Department shall conduct a review of the county's program every **five** years.
8. If a county does not improve its SESC Program within six months of being placed on probation, the Department shall hire a **consultant**.
9. A municipality can administer and enforce Part 91 by adopting an **ordinance** that is **approved** by the Department. Prior to approving the ordinance, the Department shall forward a copy of the proposed ordinance to the **county enforcing** agency and the appropriate **conservation district** for review and **comment**.
10. The ordinance adopted by the municipality may be more **restrictive** than Part 91 and the rules promulgated under Part 91.
11. A municipality shall not administer or enforce Part 91 unless the Department has **approved** the municipality.
12. As a condition for the issuance of a permit, the county or municipal enforcing agency may require **cash**, a **certified check**, an **irrevocable bank letter** of credit or a **surety** bond in an amount sufficient to assure the installation and completion of protective or corrective measures.

13. A person engaged in agricultural practices may enter into an **agreement** with the appropriate **conservation district** in lieu of obtaining a permit.
14. A state agency or an agency of a local unit of government may apply to the Department for designation as an **authorized public agency** by submitting the SESC **procedures** governing all earth changes normally undertaken by the agency.
15. If the Department approves the program of a county enforcing agency, municipal enforcing agency, or authorized public agency, the approval is valid for **five** years.
16. The Department, a county enforcing agency, or municipal enforcing agency may go to court for an **injunction** or other process against a person to restrain or prevent violations of Part 91.
17. The following activities are not required to obtain a SESC permit:
 - a. a person engaged in the **logging** industry, the **mining** industry, or the **plowing** and **tilling** for the purpose of crop production
 - b. **metallic** mineral **mining** regulated under Part 631 of the Natural Resources and Environmental Protection Act (NREPA)
 - c. activities related to **oil** or **gas** exploration or development regulated on Part 615 of the NREPA
18. Although a person engaged in the activities identified in 17a and 17c is not required to obtain a SESC permit, the activities shall conform to the **same standards** as if a permit was required.
19. As used in Part 91, mining does not include the removal of **clay, gravel, sand, peat, or topsoil**. A SESC permit is required for these activities.
20. Within **five** days after notice of a violation, a person shall implement and maintain SESC measures in conformance with Part 91.
21. A person who violates Part 91 is responsible for a **municipal** or **state** civil infraction and may be ordered to pay a civil fine of not more than **\$2500**.
22. A person who knowingly violates this part is responsible for the payment of a civil fine of not more than **\$10,000** per **day** of violation. A person who knowingly violates this part after receiving a notice of determination is responsible for the payment of a civil fine of not less than **\$2500** or more than **\$25,000** for each day of violation.
23. A certificate of training is valid for **five** years.

Appendix 6B

ADMINISTRATIVE RULES FOR PART 91

DEPARTMENT OF ENVIRONMENTAL QUALITY WATER BUREAU

(By authority conferred on the department of environmental quality by sections 9104 and 9114 of 1994 PA 451, MCL 324.9104 and 324.9114.)

(Includes all amendments through 10-8-07)

SOIL EROSION AND SEDIMENTATION CONTROL

R 323.1701 Definitions.

Rule 1701. (1) As used in this part:

- (a) "Accelerated soil erosion" means the increased loss of the land surface that occurs as a result of human activities.
- (b) "Acceptable erosion and sediment control program" means the activities of a county or local enforcing agency or authorized public agency that are conducted in accordance with these rules and part 91 regarding staff training, developing and reviewing plans, issuing permits, conducting inspections, and initiating compliance and enforcement actions to effectively minimize erosion and off-site sedimentation.
- (c) "Designated agent" means a person who has written authorization from the landowner to sign the application and secure a permit in the landowner's name.
- (d) "Lake" means the Great Lakes and all natural and artificial inland lakes or impounds that have definite banks, a bed, visible evidence of continued occurrence of water, and a surface area of water that is equal to, or greater than 1 acre. "Lake" does not include sediment basins and basins constructed for the sole purpose of storm water retention, cooling water, or treating polluted water.
- (e) "Landowner" means the person who owns or holds a recorded easement on the property or who is engaged in construction in a public right-of-way in accordance with sections 13, 14, 15, and 16 of Act No. 368 of the Public Acts of 1925, as amended, being §§247.183, 247.184, 247.185, and 247.186 of the Michigan Compiled Laws.
- (f) "Non-erosive velocity" means a speed of water movement that is not conducive to the development of accelerated soil erosion.
- (g) "Part 91" means Part 91 of Act No. 451 of the Public Acts of 1994, as amended, being §§324.9101 to 324.9123 of the Michigan Compiled Laws.
- (h) "Sediment basin" means a naturally occurring or constructed depression used for the sole purpose of capturing sediment during and after an earth change activity.
- (i) "Stabilization" means the establishment of vegetation or the proper placement grading or covering of soil to ensure its resistance to soil erosion, sliding, or other earth movement.

- (j) "Storm water retention basin" means an area which is constructed to capture surface water runoff and which does not discharge directly to a lake or stream through an outlet. Water leaves the basin by infiltration and evaporation.
- (k) "Stream" means a river, creek, or other surface watercourse which may or may not be serving as a drain as defined in Act No. 40 of the Public Acts of 1956, as amended, being §281.1 et seq. of the Michigan Compiled Laws, and which has definite banks, a bed, and visible evidence of the continued flow or continued occurrence of water, including the connecting waters of the Great Lakes.
- (l) "Temporary soil erosion and sedimentation control measures" means interim control measures which are installed or constructed to control soil erosion and sedimentation and which are maintained after project completion.
- (m) "Permanent soil erosion and sedimentation control measures" means those control measures which are installed or constructed to control soil erosion and sedimentation and which are maintained after project completion.

(2) The terms defined in Part 91 have the same meanings when used in these rules.

History: 1954 ACS 81, Eff. Jan. 1, 1975; 1979 AC; 1998 MR 7, Eff. July 15, 1998.

R 323.1702 Earth change requirements generally.

Rule 1702. (1) A person shall conduct an earth change in a manner that will effectively reduce accelerated soil erosion and resulting sedimentation.

- (2) A person engaged in an earth change identified in R 323.1704 shall plan, implement, and maintain acceptable soil erosion and sedimentation control measures in conformance with Part 91, which effectively reduce accelerated soil erosion and off-site sedimentation.
- (3) A person shall set forth Soil erosion and sedimentation control measures in a plan as prescribed by R 323.1703. A person shall make the plan available for inspection at all times at the site of the earth change. The department or its designated representative may require the county or local enforcing agency to file a copy of the plan with the department.
- (4) A person shall obtain a permit containing state prescribed information, as required by R 323.1707 and make the permit available for inspection at the site of the earth change.

History: 1954 ACS 81, Eff. Jan. 1, 1975; 1979 AC; 1998 MR 7, Eff. July 15, 1998.

R 323.1703 Soil erosion and sedimentation control plan requirements.

Rule 1703. A person shall prepare a soil erosion and sedimentation control plan for any earth change identified in R 323.1704. A person shall design the plan to effectively reduce accelerated soil erosion and sedimentation, and shall identify factors that may contribute to soil erosion or sedimentation or both. The plan shall include, but not be limited to, all of the following:

- (a) A map or maps at a scale of not more than 200 feet to the inch or as otherwise determined by the county or local enforcing agency. A map shall include a legal description and site location sketch that includes the proximity of any proposed earth change to lakes or streams, or both; predominant land features; and contour intervals or slope description.
- (b) A soils survey or a written description of the soil types of the exposed land area contemplated for the earth change.
- (c) Details for proposed earth changes including all of the following:
 - (i) A description and the location of the physical limits of each proposed earth change.
 - (ii) A description and the location of all existing and proposed on-site drainage and dewatering facilities.
 - (iii) The timing and sequence of each proposed earth change.
 - (iv) The location and description for installing and removing all proposed temporary soil erosion and sedimentation control measures.
 - (v) A description and location of all proposed permanent soil erosion and sediment control measures.
 - (vi) A program proposal for the continued maintenance of all permanent soil erosion and sediment control measures that remain after project completion, including the designation of the person responsible for the maintenance. Maintenance responsibilities shall become a part of any sales or exchange agreement for the land on which the permanent soil erosion control measures are located.

History: 1954 ACS 81, Eff. Jan. 1, 1975; 1979 AC; 1998 MR 7, Eff. July 15, 1998.

R 323.1704 Permit requirements.

Rule 1704. (1) A land owner or designated agent who contracts for, allows or engages in an earth change in this state shall obtain a permit from the appropriate enforcing agency before commencing an earth change which disturbs 1 or more acres of land, or which is within 500 feet of the water's edge of a lake or stream, unless exempted in R 323.1705.

- (2) An earth change activity that does not require a permit under subrule (1) of this rule is not exempt from enforcement procedures under Part 91 or these rules, if the activity exempted by subrule (1) of this rule causes or results in a violation of Part 91 or these rules.

History: 1954 ACS 81, Eff. Jan. 1, 1975; 1979 AC; 1998 MR 7, Eff. July 15, 1998.

R 323.1705 Permit exemptions and waivers.

Rule 1705. (1) A permit is not required for any of the following:

- (a) A beach nourishment project permitted under Part 325 of Act No. 451 of the Public Acts of 1994, as amended, being S324.32501 et seq. of the Michigan Compiled Laws.
 - (b) Normal road and driveway maintenance, such as grading or leveling, that does not increase the width or length of the road or driveway and that will not contribute sediment to lakes or streams.
 - (c) An earth change of a minor nature that is stabilized within 24 hours of the initial earth disturbance and that will not contribute sediment to lakes or streams.
 - (d) Installation of oil, gas, and mineral wells under permit from the supervisor of wells if the owner-operator is found by the supervisor of wells to be in compliance with the conditions of Part 91.
- (2) A county or local enforcing agency may grant a permit waiver for an earth change after receiving a signed affidavit from the landowner stating that the earth change will disturb less than 225 square feet and that the earth change will not contribute sediment to lakes or streams.
- (3) Exemptions provided in subrules (1) and (2) of this rule shall not be construed as exemptions from enforcement procedures under Part 91 or these rules, if the activities exempted by subrules (1) and (2) of this rule cause or result in a violation of Part 91 or these rules.

History: 1954 ACS 81, Eff. Jan. 1, 1975; 1979 AC; 1998 MR 7, Eff. July 15, 1998.

R 323.1706 Application for permit.

Rule 1706. (1) A landowner or designated agent shall submit an application for a permit to the appropriate enforcing agency.

- (2) A landowner or designated agent shall submit, with the application a soil erosion and sedimentation control plan and any other document that the appropriate enforcing agency may require.
- (3) The county or local enforcing agency shall provide an application requiring state prescribed information to the applicant.
- (4) An authorized public agency is exempt from obtaining a permit from a county or local enforcing agency but shall notify the county or local enforcing agency of each proposed earth change.

History: 1954 ACS 81, Eff. Jan. 1, 1975; 1979 AC; 1998 MR 7, Eff. July 15, 1998.

R 323.1707 Application review and permit procedures.

Rule 1707. (1) A person who is designated by the county or local enforcing agency who is trained in soil erosion and sedimentation control methods and techniques shall review and approve a soil erosion and sedimentation control plan.

- (2) The appropriate enforcing agency shall approve, disapprove, or require modification of an application for an earth change permit within 30 calendar days following receipt of the application. The enforcing agency shall notify an applicant of by first-class mail. If an applicant is disapproved, then the enforcing agency shall advise the applicant by certified mail of its reasons for disapproval and conditions required for approval. The enforcing agency need not notify an applicant of approval or disapproval by mail if the applicant is given written approval or disapproval of the application in person. A permit given to the applicant either in person or by first-class mail constitutes approval.
- (3) A permit that contains state prescribed information shall be used by each county or local enforcing agency and shall include any additional provisions required by the county or local enforcing agency. The permit shall be available at the site of the earth change for inspection.
- (4) Upon a determination that a permit applicant has met all of the requirements of these rules, Part 91 and the local ordinance, if applicable, the appropriate enforcing agency shall issue a permit for the proposed earth change.

Note: *On October 8, 2007, subsection (3) was rescinded and the remaining subsections were renumbered. Prior to the amendment, the Department of Environmental Quality was responsible for issuing SESC permits for projects that crossed between two or more permitting agencies; now each permitting agency is responsible for issuing a SESC permit for the portion of the project within its respective jurisdiction.*

History: 1954 ACS 81, Eff. Jan. 1, 1975; 1979 AC; 1998 MR 7, Eff. July 15, 1998; 2007 MR 19, Eff. Oct. 8, 2007.

R 323.1708 Soil erosion and sedimentation control procedures and measures generally.

Rule 1708. A person who applies for an earth change permit shall incorporate the soil erosion and sedimentation control procedures and measures prescribed by R 323.1709 and R 323.1710 into the soil erosion and sedimentation control plan and shall apply the procedures and measures to all earth changes identified in the plan, unless the person preparing the plan shows to the satisfaction of the appropriate enforcing agency that altering of the control procedures or measures, or including other control procedures or measures, will prevent accelerated soil erosion and sedimentation during the earth change.

History: 1954 ACS 81, Eff. Jan. 1, 1975; 1979 AC; 1998 MR 7, Eff. July 15, 1998.

R 323.1709 Earth change requirements: time; sediment removal; design installation, and removal of temporary or permanent control measures.

- Rule 1709. (1) A person shall design, construct, and complete an earth change in a manner that limits the exposed area of any disturbed land for the shortest possible period of time as determined by the county or local enforcing agency.
- (2) A person shall remove sediments caused by accelerated soil erosion from runoff water before it leaves the site of the earth change.
 - (3) A person shall design a temporary or permanent control measure that is designed and constructed for the conveyance of water around, through or from the earth change area to limit the water flow to a non-erosive velocity.
 - (4) A person shall install temporary soil erosion and sedimentation control measures before or upon commencement of the earth change activity and shall maintain the measures on a daily basis. A person shall remove temporary soil erosion and sedimentation control measures after permanent soil erosion measures are in place and the area is stabilized. A person shall stabilize the area with permanent soil erosion control measures under approved standards and specifications as prescribed by R 323.1710.
 - (5) A person shall complete permanent soil erosion control measures for all slopes, channels, ditches or any disturbed land area within 5 calendar days after final grading or the final earth change has been completed. If it is not possible to permanently stabilize a disturbed area after an earth change has been completed or if significant earth change activity ceases, then a person shall maintain temporary soil erosion and sedimentation control measures until permanent soil erosion control measures are in place and the area is stabilized.

History: 1954 ACS 81, Eff. Jan. 1, 1975; 1979 AC; 1998 MR 7, Eff. July 15, 1998.

R 323.1710 Standards and specifications.

Rule 1710. A person shall complete all temporary and permanent erosion and sedimentation control measures according to the approved plan or operating procedures.

- (1) A person shall install and maintain control measures in accordance with the standards and specifications of all of the following:
 - (a) The product manufacturer.
 - (b) The local conservation district.
 - (c) The department.
 - (d) The Michigan department of transportation.
 - (e) The enforcing agency, if applicable and formally adopted.
- (2) If a conflict exists between the standards and specifications, the enforcing agency or authorized public agency shall determine which specifications are appropriate for the project.

History: 1954 ACS 81, Eff. Jan. 1, 1975; 1979 AC; 1998 MR 7, Eff. July 15, 1998.

R 323.1711 Building permits.

Rule 1711. (1) A local agency or general law township that issues building permits shall notify the county or local enforcing agency immediately upon receipt of an application for a building permit that requires an earth change which disturbs 1 or more acres or which located within 500 feet of a lake or stream.

- (2) A local agency or general law township shall not issue a building permit to a person engaged in an earth change if the change requires a permit under Part 91 or these rules until the county or local enforcing agency has issued the required state prescribed permit for the earth change.

History: 1954 ACS 81, Eff. Jan. 1, 1975; 1979 AC; 1998 MR 7, Eff. July 15, 1998.

R 323.1712 Enforcement.

Rule 1712. The county or local enforcing agency may issue a cease and desist order or revoke a permit upon its finding that there is a violation of Part 91, these rules, or an approved local ordinance, or a finding that there is a violation of a permit or an approved soil erosion and sedimentation control plan.

History: 1954 ACS 81, Eff. Jan. 1, 1975; 1979 AC; 1998 MR 7, Eff. July 15, 1998.

R 323.1713 Periodic review.

Rule 1713. The department shall conduct an ongoing comprehensive review and evaluation of all soil erosion and sedimentation control programs that operate under Part 91 and these rules. The department shall notify county and local enforcing agencies and authorized public agencies as to the acceptability of their soil erosion and sedimentation control programs. The department shall make available a report of its findings of the review and evaluation of all enforcing agencies and authorized public agencies.

History: 1954 ACS 81, Eff. Jan. 1, 1975; 1979 AC; 1998 MR 7, Eff. July 15, 1998.

R 323.1714 Availability of documents.

Rule 1714. Copies of the local conservation district standards and specifications for soil erosion and sedimentation control, as referred to in R 323.1710 are available at each local conservation district office at a nominal cost. Copies of the department's standards are available from the surface water quality division's Lansing office. Department of transportation standards are available at the Lansing office for a fee. Information on other standards may be available from product manufacturers and the enforcing agencies.

History: 1954 ACS 81, Eff. Jan. 1, 1975; 1979 AC; 1998 MR 7, Eff. July 15, 1998.

UNIT SIX ADMINISTRATIVE RULES FOR PART 91 REVIEW

1. "Accelerated soil erosion" means the _____ loss of the land surface that occurs as the result of _____ activities.
2. "Lake" means the Great Lakes and all natural and _____ inland lakes and impoundments that have definite _____, a _____, visible evidence of a continued occurrence of water, and a surface area of water that is equal to, or greater than, _____ acre.
3. "Stream" means a river, creek, or other _____ which may or may not be serving as a _____ (established under 1956 PA 40, as amended), and which has definite banks, a bed, and visible evidence of the continued flow or continued _____ of water, including the connecting waters of the Great Lakes.
4. A person engaged in an earth change shall _____, _____, and _____ acceptable SESC measures in conformance with Part 91, which effectively _____ accelerated soil erosion and off-site sedimentation.
5. A person shall obtain a permit _____ commencing an earth change which disturbs _____ or more acres of land or which is within _____ feet of a _____ or _____.
6. An earth change activity that does not require a permit is not _____ from _____ procedures under Part 91.
7. An authorized public agency is _____ from obtaining a permit from the county or local enforcing agency, but shall _____ the county or local enforcing agency of each proposed earth change.
8. If an earth change crosses between two or more local (municipal) or county enforcing agencies, then _____ agency shall issue a permit for the portion of project within its jurisdiction.
9. A person shall design, construct, and complete an earth change in a manner that _____ the exposed area of any disturbed land for the _____ possible period of time as _____ by the county or local enforcing agency.
10. A person shall _____ sediment caused by accelerated soil erosion from _____ water _____ it leaves the site of the earth change.

11. A person shall design a temporary or permanent measure that is designed and constructed for the conveyance of water around, through, or from the earth change area to _____ the water flow to a _____ velocity.
12. A person shall install temporary SESC measures _____ or upon _____ of the earth change activity and shall _____ the measures on a _____ basis.
13. A person shall remove _____ SESC measures after _____ soil erosion measures are in place and the area is _____.
14. A person shall complete permanent soil erosion control measures for all slopes, ditches, or any disturbed land area within _____ calendar days after _____ grading or the final earth change has been completed.
15. A local agency or general law township _____ issue a _____ permit to a person engaged in an earth change if the change requires a permit under Part 91 or the rules until the county or local enforcing agency has issued the Part 91 permit.
16. A county or local enforcing agency may issue a _____ and _____ order or _____ a permit upon its finding that there is a violation of Part 91.

ANSWERS TO UNIT SIX ADMINISTRATIVE RULES FOR PART 91 REVIEW

1. "Accelerated soil erosion" means the **increased** loss of the land surface that occurs as the result of **human** activities.
2. "Lake" means the Great Lakes and all natural and **artificial** inland lakes and impoundments that have definite **banks**, a **bed**, visible evidence of a continued occurrence of water, and a surface area of water that is equal to, or greater than, **one** acre.
3. "Stream" means a river, creek, or other **surface watercourse** which may or may not be serving as a **drain** (established under 1956 PA 40, as amended), and which has definite banks, a bed, and visible evidence of the continued flow or continued **occurrence** of water, including the connecting waters of the Great Lakes.
4. A person engaged in an earth change shall **plan, implement, and maintain** acceptable SESC measures in conformance with Part 91, which effectively **reduce** accelerated soil erosion and off-site sedimentation.
5. A person shall obtain a permit **before** commencing an earth change which disturbs **one** or more acres of land or which is within **500** feet of a **lake** or **stream**.
6. An earth change activity that does not require a permit is not **exempt** from **enforcement** procedures under Part 91.
7. An authorized public agency is **exempt** from obtaining a permit from the county or local enforcing agency, but shall **notify** the county or local enforcing agency of each proposed earth change.
8. If an earth change crosses between two or more local (municipal) or county enforcing agencies, then **each** agency shall issue a permit for the portion of the project within its jurisdiction.
9. A person shall design, construct, and complete an earth change in a manner that **limits** the exposed area of any disturbed land for the **shortest** possible period of time as **determined** by the county or local enforcing agency.

10. A person shall **remove** sediment caused by accelerated soil erosion from **runoff** water **before** it leaves the site of the earth change.
11. A person shall design a temporary or permanent measure that is designed and constructed for the conveyance of water around, through, or from the earth change area to **limit** the water flow to a **non-erosive** velocity.
12. A person shall install temporary SESC measures **before** or upon **commencement** of the earth change activity and shall **maintain** the measures on a **daily** basis.
13. A person shall remove **temporary** SESC measures after **permanent** soil erosion measures are in place and the area is **stabilized**.
14. A person shall complete permanent soil erosion control measures for all slopes, ditches, or any disturbed land area within **five** calendar days after **final** grading or the final earth change has been completed.
15. A local agency or general law township **shall not** issue a **building** permit to a person engaged in an earth change if the change requires a permit under Part 91 or the rules until the county or local enforcing agency has issued the Part 91 permit.
16. A county or local enforcing agency may issue a **cease** and **desist** order or **revoke** a permit upon its finding that there is a violation of Part 91.

**PERMIT APPLICATION
for Part 91
SOIL EROSION AND
SEDIMENTATION CONTROL**

OFFICE USE ONLY

Permit Number
Date Issued
Expiration Date
File Number

1. APPLICANT (Please check if applicant is the landowner or designated agent*)

Name		Landowner	Designated Agent
Address			
City	State	Zip Code	Area Code/Telephone Number

2. LOCATION

Section	Town	Range	Township	City/Village	County
Subdivision	Lot No.	Tax ID Number		Street Address	

3. PROPOSED EARTH CHANGE

Project Type:	Residential Industrial	Multi-family Land Balancing	Commercial
Describe Project			Size of Earth Change (acres or square feet)
Name of and Distance to Nearest Lake, Stream, or Drain		Date Project to Start	Date Project to be Completed

4. SOIL EROSION AND SEDIMENTATION CONTROL PLAN (Refer to Rule 323.1703)

Note: ___ complete sets of plans must be attached.	Estimated Cost of Erosion and Sediment Control
	Plan Preparer's Name and Telephone Number Area Code ()

5. PARTIES RESPONSIBLE FOR EARTH CHANGE

Name of Landowner (if not provided in Box No. 1 above)		Address	
City	State	Zip	Area Code/Telephone Number
Name of Individual "On Site" Responsible for Earth Change		Company Name	
Address	City	State	Zip Code Area Code/Telephone Number

6. PERFORMANCE DEPOSIT (If required by the permitting agency)

Amount Required \$ _____	Cash	Certified Check	Irrevocable Letter of Credit	Surety Bond
Name of Surety Company				
Address	City	State	Zip Code	Area Code/Telephone No.

I (we) affirm that the above information is accurate and that I (we) will conduct the above described earth change in accordance with Part 91, Soil Erosion and Sedimentation Control, of the Natural Resources and Environmental Protection Act, 1994 PA 451, as amended, applicable local ordinances, and the documents accompanying this application.		
Landowner's Signature	Print Name	Date
Designated Agent's Signature*	Print Name	Date

* Designated agent must have a written statement from landowner authorizing him/her to secure a permit in the landowner's name

SOIL EROSION AND SEDIMENTATION CONTROL PERMIT

(Issued under the authority of Part 91, Soil Erosion and Sedimentation Control,
of the Natural Resources and Environmental Protection Act,
1994 PA 451, as amended)

Permittee: _____

Address: _____

Permit No.:	_____
Issued:	_____
Expires:	_____
Extended:	_____

On-Site Responsible Person: Name: _____

Company: _____ Telephone Number: (____)_____

Permitted Activity:

Project Location: Town _____; Range _____; Section _____

City or Township: _____

Address: _____

Permit Conditions:

1. The permitted activity shall be completed in accordance with the approved plans and specifications, and the **attached** general and specific conditions.
2. This permit does not waive the necessity for obtaining all other required federal, state, or local permits.
3. Permittee shall notify the permitting agency within one week after completing the permitted activity or one week prior to the permit expiration date, whichever comes first.

Permitting Agent

(____)_____
Telephone Number

THIS PERMIT MUST BE POSTED AT THE PROJECT SITE.

PART 91 SITE INSPECTION REPORT

Project Name		
Address	City	Township
Permit No.	Inspections No.	Date of Inspection

A. GENERAL

Is permit posted at site?	<input type="checkbox"/> Yes	<input type="checkbox"/> No
Are approved plans available?	<input type="checkbox"/> Yes	<input type="checkbox"/> No
Is sediment properly contained on project site?	<input type="checkbox"/> Yes	<input type="checkbox"/> No
Is earth change confined to areas specified on plans?	<input type="checkbox"/> Yes	<input type="checkbox"/> No
Is there a potential for sediment to leave property/site?	<input type="checkbox"/> Yes	<input type="checkbox"/> No
Is there a potential for sediment to discharge to surface waters?	<input type="checkbox"/> Yes	<input type="checkbox"/> No

B. CONTROL MEASURES

Are controls installed per plans?	<input type="checkbox"/> Yes	<input type="checkbox"/> No	Are controls adequate for this site?	<input type="checkbox"/> Yes	<input type="checkbox"/> No
Are controls properly maintained?	<input type="checkbox"/> Yes	<input type="checkbox"/> No	Are storm sewers being protected?	<input type="checkbox"/> Yes	<input type="checkbox"/> No

C. INSPECTOR'S COMMENTS

Specific on site conditions:

Weather conditions:

Photos Taken? Yes No: Samples Taken? Yes No:

Recommendations:

Corrections (if any) must be made by _____/_____/_____ (date)

Persons attending inspection:

D ACTION TAKEN

<input type="checkbox"/> Report left on-site with _____	<input type="checkbox"/> Report mailed to _____
<input type="checkbox"/> Violation notice recommended _____	<input type="checkbox"/> Copies sent to _____
Inspector's Signature	Date

SOIL EROSION & SEDIMENTATION CONTROL/CONSTRUCTION STORM WATER INSPECTION LOG

Project Name or Description: _____ NPDES Number (if applicable): _____ Page ____ of ____

Date: _____ Time: _____ Reason for Inspection: Weekly Inspection Inspection **within 24 hrs. of Storm Water Runoff**

Current extent of the project work: _____

SESC measures installed since the last inspection and their location: _____

Are SESC measures installed according to the SESC Plan? **Y** **N** Are there other potential areas of concern? **Y** **N**
If **NO**, identify measures, locations, and actions needed below.

Are the SESC measures: Properly installed? **Y** **N** Maintained? **Y** **N** Appropriate for site conditions? **Y** **N**
Failed? **Y** **N**
If **NO**, identify measure locations and actions needed below.

Are additional SESC measures recommended? **Y** **N** Are there other concerns or improvements noted for the site? **Y** **N**
If **YES**, identify locations and recommendations below.

Corrective Actions Taken/Needed **to repair or improve the prescribed control measures:**

Certified Operator Signature: _____ **Operator Number:** _____

Print Name: _____

The details included in this report were provided to: _____ **Date:** _____ **By method of delivery:** _____

Unit Seven

SOILS, EROSION, AND RUNOFF

Introduction

Selecting effective soil erosion and sedimentation control (SESC) measures requires a working understanding of how soil properties and site conditions affect the erosion, runoff, and sediment control processes.

Soil Texture

Soil texture is one of the major factors in determining erosion, runoff, and sediment control at sites undergoing an earth change. Texture refers to the size or combination of sizes of the soil particles. The three major size categories of soil, from smallest to largest, are clay, silt, and sand. Soils consisting of 100% clay, silt, or sand are rarely found in Michigan. Generally, soils consist of varying percentages of clay, silt, and sand and names such as sandy loam, silty clay, and clay loam are used to categorize soils based on the relative percentages of clay, silt, and sand (Figure 7-1).

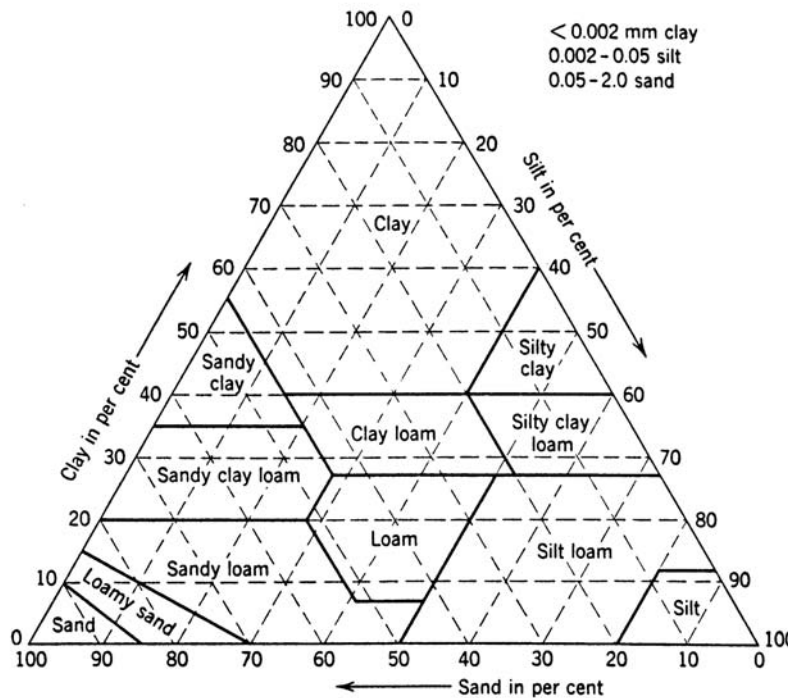

Figure 7-1: NRCS Textural Triangle

Information about the soils on a particular site can be obtained in several ways; the most common are from published soil surveys or from field inspections. Soil surveys are published on a county basis through a cooperative effort by the Natural Resources Conservation Service, the Michigan Department of Agriculture, and other federal, state, and local agencies. In addition to soil texture, information within each survey includes maps of the location of soil series within a county, a description of

the soils physiochemical properties, and an evaluation of the soil's suitability to support and sustain a variety of uses and activities.

For projects which will include cuts below the level identified in soil surveys, a more detailed soils investigation may be necessary to identify soil texture at several locations at the site. Also, projects which include fill should identify the texture of the fill to be utilized.

The texture of a soil can be determined in the field by rubbing a sample between the thumb and fingers. There are three easily distinguishable extremes: sand feels gritty, silt feels floury, and clay feels smooth. For best results in identification, perform the field test in Appendix A on both dry and moist samples. Below is a partial list of common soil textures and associated properties.

Sand is a coarse textured soil. The individual grains are readily distinguished by sight and feel. Squeezed in the hand when dry, sand falls apart as soon as the hand is opened. Squeezed when moist, sand forms a cast. The shape holds as the hand opens, but crumbles when touched.

Sandy loam texture consists primarily of sand, but contains some silt and clay. Individual sand grains are, again, distinguished by sight and feel. Squeezed in the hand when dry, sandy loam falls apart once the hand is opened. Squeezed when moist, it forms a cast and holds its shape, withstanding careful handling without crumbling.

Loam consists of a mixture of sand, silt, and clay. Squeezed in the hand when dry, it forms a cast that holds its shape and withstands careful handling without crumbling. The cast formed with moist soil can be handled freely without breaking. When rolled between the hands, loam can be pointed as fine as pencil lead, but is easily broken.

Silt loam consists of a moderate amount of sand, a small amount of clay, and a large amount of silt. Either dry or moist, casts formed by squeezing can be handled freely without breaking. When a moist ball is pressed between the thumb and finger, it displays a broken appearance. When wet silt is vibrated in the hand, a surface sheen of water appears. When rolled between the hands, silt loam forms a thick, soft, easily broken thread.

Clay loam is a fine textured soil. It breaks into clods or lumps, which harden as they dry. A ball of moist soil pressed between the thumb and finger forms a thin ribbon that breaks readily, barely sustaining its own weight. Moist casts formed by squeezing withstand considerable handling. Clay loam can be formed to a pinpoint when rolled between the hands.

Clay is a very fine textured soil. It breaks into very hard clods or lumps when dry. When wet, it is plastic and sticky. A ball of moist soil pressed between the thumb and finger produces a long ribbon. When rolled between the hands, clay forms a strong, plastic thread that can be shaped to a pinpoint. Cracking of the ground surface when it dries is a good indication of high clay content in the soil.

Once the texture of a soil has been determined, an SESC planner can make certain inferences about how that soil will affect the erosion, runoff, and sedimentation processes on the construction site.

Erodibility And Erosion

Erodibility is a measure of a soil's susceptibility to raindrop impact, runoff, and other erosive forces. Soil texture is one of the major factors which determine the erodibility of a certain soil. Factors such as cohesion, structure, and compaction can also affect erodibility, even in soils with similar textures. The NRCS has assigned all soils in Michigan an erodibility status, or K factor. Higher K factors indicate a higher erodibility. In general, silty soils tend to be highly erosive, clayey and loamy soils tend to have moderate erodibility, and sandy soils generally have low erodibility (although very fine sands can also be very erodible).

The amount of any given soil that will erode through the forces of wind and water is dependent on many factors in addition to soil erodibility. Slope steepness, slope length, soil cover, soil management practices, and the intensity of wind, rainfall, or runoff also have an impact on the total amount of erosion from a site.

Potential erosion from a site is important when prioritizing Part 91 site Inspections. The NRCS' Revised Universal Soil Loss Equation (RUSLE) is one method of estimating soil loss. An online version of RUSLE is available at <http://www.iwr.msu.edu/rusle>.

Table 7-1 provides outputs from the RUSLE equation for estimating sheet and rill erosion from a site. Take note of how changes in individual factors can change the amount of erosion that can be expected to leave a site.

Table 7-1 Outputs from the NRCS RUSLE equation

Texture	% Slope	Slope Length (ft)	Cover	County	Soil Loss (tn/ac/yr)	Soil Loss (yd³)
Silt Loam	6	300	None	Clinton	62	54
Sandy Loam	6	300	None	Clinton	35	24
Clay Loam	6	300	None	Clinton	46	45
Silt Loam	1	300	None	Clinton	8	7
Silt Loam	12	300	None	Clinton	158	138
Silt Loam	6	150	None	Clinton	41	35
Silt Loam	6	1000	None	Clinton	128	111
Silt Loam	6	300	Straw*	Clinton	7	6
Silt Loam	6	300	Dense Veg	Clinton	0.4	0.3
Silt Loam	6	300	None	Berrien	93	81
Silt Loam	6	300	None	Mackinac	52	45

***1.5 tons/acre loose straw**

Sedimentation And Sediment Control

Although preventing soil particles from eroding is always the most effective method, preventing all erosion from occurring during an earth change is generally not feasible. Therefore, sediment control measures are often necessary to prevent damage to waterways and adjacent properties.

Once soil particles have been dislodged through the erosion process, they are transported and deposited as sediment. The properties of the soil particles that are eroded have a strong impact on when and where those particles will be deposited. The most critical of these properties is once again soil texture. Therefore, the soil texture is critical information for selecting effective sediment control measures for a site.

Physical sediment control devices such as sediment basins and silt fence are most effective on sandy soils, moderately effective on loam soils, and have little effectiveness on silt and clay soils. Therefore, an SESC plan for a site with a soil that has significant amounts of silt and clay should be heavily reliant on soil erosion measures rather than sediment control. If heavy reliance on sediment control measures is unavoidable, chemical controls (such as polyacrylamides) will be necessary to assure compliance with Part 91.

Runoff

Runoff refers to the water that runs off the land as a result of melting snow or rainfall. An accurate estimation of the location, volume, and rate of runoff on a construction site during the plan development phase is critical in determining the eventual effectiveness of planned SESC measures. In general, disturbing natural vegetation and developing a site, will increase the amount of runoff from a site, thus increasing the potential for erosion. There are three important considerations when planning for runoff from construction sites:

1. Where and how will the runoff travel on the site?
2. How much water will runoff in total?
3. How much water will be moving at any one time?

Runoff Characterization

The nature and direction by which the runoff flows is a major consideration for selecting effective SESC measures. In general, there are two different types of runoff on construction sites: Sheet flow and concentrated flow.

Sheet flow is the movement of water over the land's surface at a relatively shallow and uniform depth. Almost all runoff from construction sites start as sheet flow.

Even with slight variability along slopes, sheet flows begin to accumulate, forming concentrated flow. Concentrated flow can be created by natural topography or human activities (ditches, berms, storm water systems, etc.). Concentrated flows move at a greater velocity and depth than sheet flows, thus creating greater erosive force on the substrate soil. Also, the more common and inexpensive SESC measures such as silt fence and loose mulch generally do not function properly in concentrated flows.

It is critical to identify the direction of sheet flow and location of concentrated flows on construction sites. One important consideration is identifying these patterns before, during, and after construction, as construction practices often change the direction of sheet flow and the location and number of concentrated flows.

It is necessary to have an accurate understanding of site topography to understand runoff patterns. For smaller, less complicated sites, this may be accomplished with a site visit. For larger or more complex sites, an accurate topographic map may be required in addition to a site visit. Runoff flows perpendicular to contour lines on a topographic map. In general, areas with low slopes and relatively straight and parallel contours are most likely to maintain sheet flows. Contours that are irregular in shape tend to represent areas where concentrated flows might form. Contour lines that come to an upslope point or curve generally represent concentrated flows. Figure 7-2 is a topographic map which represents likely to sheet and concentrated flows on a construction site.

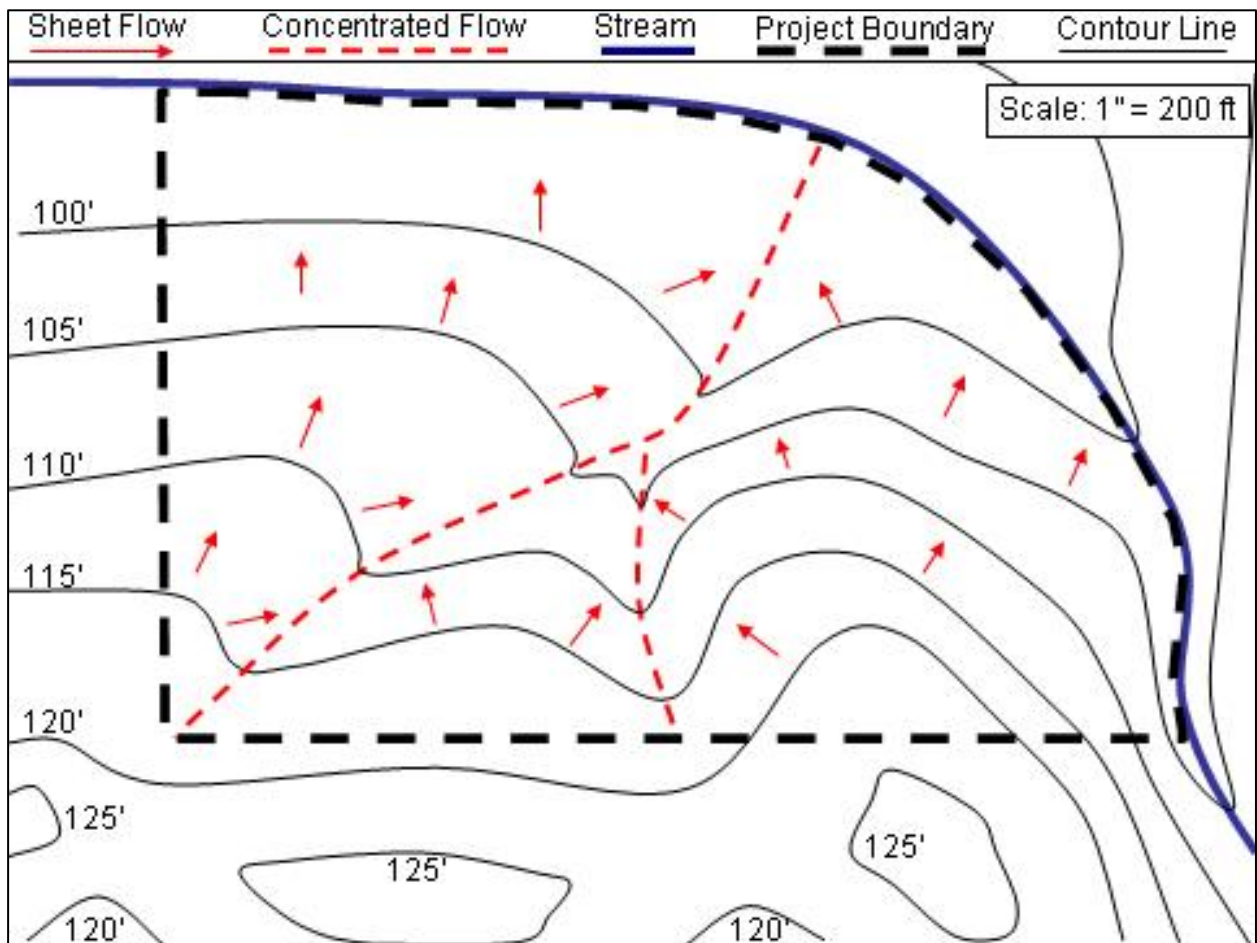

Figure 7-2: Identifying likely sheet and concentrated flow paths on a topographic map

Runoff Volume and Discharge Rate

Soil Hydrologic Group

The rate that water infiltrates into the soil and moves through the soil affects the amount and rate of runoff leaving the site. The infiltration rate is the rate at which water enters the soil at the surface and is controlled by surface conditions. The transmission rate is the rate at which the water moves through the soil and is controlled by the soil layers. In general, when the rate of infiltration and transmission through the soil is higher, the volume of runoff is lower.

As a result of low infiltration and transmission rates, fine textured soils, such as clay, produce a higher runoff volume than do coarse textured soils, such as sand. Sites having clay soils may require the construction of more elaborate drainage systems than sites having sandy soils.

Soil scientists have assigned all soils to one of four hydrologic groups based on infiltration and transmission rates (see Appendix 7B). The four hydrologic soil groups based on infiltration and transmission rates are:

1. **Group A** (low runoff potential): These soils exhibit high infiltration and transmission rates and low runoff volume. They are chiefly deep, well drained sands or gravel.
2. **Group B**: When thoroughly wet, but not saturated, these soils display moderate infiltration and transmission rates and runoff volume. They are moderately to well drained soils, generally moderate in depth, moderately fine to moderately coarse in texture, including sandy loam, loam, silt loam, and silt.
3. **Group C**: These soils have slow infiltration and transmission rates and high runoff volume when wet. They are distinguished by a layer that impedes downward movement of water and are moderately fine to finely textured. This group includes clay loam.
4. **Group D** (high runoff potential): These soils have the slowest infiltration and transmission rates and the highest runoff volume. They are chiefly clay soils with a high swelling potential or have a permanent high water table. Other characteristics may include a claypan at or near the surface and shallow soils over nearly impervious material.

The infiltration rates, transmission rates, and runoff volumes of all soils are affected by climatic conditions such as freezing. Regardless of its hydrologic soil group, all frozen soils exhibit a high runoff volume.

Surface Characteristics

The surface characteristics of a site greatly influence the volume and rate of water running off the land. Typical site development may increase the runoff volume substantially. For example, runoff will range from less than 5% or 10% of the total

rainfall on heavily vegetated areas like woodlands, to nearly 100% of the rainfall for impervious surfaces like pavement.

While there is no authority to regulate storm water volume in Part 91, some communities have elected to pass regulations that limit the volume and rate of water discharged from a site to that originally discharged from the site prior to development. Controlling the discharge prevents downstream flooding brought on by urbanization of the watershed and makes on-site management and storage of storm water runoff imperative.

Development of a site normally increases the runoff volume and rate, thus increasing the potential for erosion (Figure 7-3). Therefore, vegetative and structural erosion control measures are often required to minimize any potential adverse impacts.

Table 7-2 presents land use categories, the four hydrologic soil groups, and respective runoff curve numbers (RCN) for various land use and soil group combinations. Each curve number developed by the NRCS provides an index to the potential runoff. The higher the curve number, the higher the runoff volume. When a site has several combinations of soils and/or land uses, an average curve number must be computed for the site to represent the runoff volume from the site.



Figure 7-4

Table 7-2: Runoff Curve Numbers for Selected Site Conditions

<u>LAND USE DESCRIPTION</u>		Hydrologic Soil Group				
		<u>A</u>	<u>B</u>	<u>C</u>	<u>D</u>	
CULTIVATED LAND:	without conservation	72	81	88	91	
	with conservation	62	71	78	81	
PASTURE OR RANGE LAND:	poor condition	68	79	86	89	
	good condition	39	61	74	80	
MEADOW:	good condition	30	58	71	78	
FOREST LAND:	thin stand, poor cover	45	66	77	83	
	good cover	25	55	70	77	
OPEN SPACES, LAWNS, PARKS, GOLF COURSE						
	fair condition: grass on 50-75 % of area	49	69	79	84	
	good condition: grass on 75% of area	39	61	74	80	
COMMERCIAL AND BUSINESS AREAS: 85% imp.		89	92	94	95	
INDUSTRIAL DISTRICTS: 72% impervious		81	88	91	93	
RESIDENTIAL	<u>avg. lot size</u>					
	<u>% impervious</u>					
	1/8 acre or less	65	77	85	90	92
	1/4 acre	38	61	75	83	87
	1/3 acre	30	57	72	81	86
	1/2 acre	25	54	70	80	85
	1 acre	20	51	68	79	84
PAVED PARKING, ROOFS, DRIVEWAYS, ETC.		98	98	98	98	
STREETS AND ROADS						
	paved with curbs and storm sewers	98	98	98	98	
	gravel	76	85	89	91	
	dirt	72	82	87	89	
WATER SURFACES (LAKES, PONDS, RESERVOIRS)		100	100	100	100	
SWAMP at least 1/3 is open water		85	85	85	85	
SWAMP (VEGETATED)		78	78	78	78	
DEVELOPING URBAN AREAS						
	Newly graded areas (Pervious areas only, no vegetation)	77	86	91	94	

Rainfall Duration and Frequency

The amount of rainfall used in estimating the potential runoff volume and discharge rate from a site is dependent on the site location and rainfall duration and frequency. Figure 7-4 provides the 24-hour Michigan rainfall values (in inches) for frequencies of 2, 5, 10, and 25 years. A 5-year rainfall, for example, is a rainfall that is expected to occur on an average of once every 5 years, or has a 20% chance of occurring in any given year. Similarly, a 25-year rainfall is a rainfall that is expected to occur on an average of once every 25 years, or has a 4% chance of occurring in any given year.

It is important to remember that rainfall frequencies are based on long-term averages. In any given year, it is possible to have multiple rain events that exceed the expected frequency. For example, two or three 25-year rainfalls could occur within the same year or even within a one or two week period. On the other hand, it is possible that it may be 50-75 years before another 25-year rainfall occurs. Remember, there is a 4% chance that a 25-year rainfall will occur in any given year.

Communities that have adopted storm water ordinances generally specify the rainfall frequency to be used in designing control structures. Where storm frequencies are not specified, three factors should be considered in selecting a design rainfall frequency: length and season of the construction period, construction cost, and the consequences of failure of an erosion or storm water control structure.

The length and season of a construction period should be considered before selecting a design storm frequency. Generally, it is not necessary to use the same storm frequency for a project lasting one month compared to one lasting two years or construction during April as opposed to August.

It is also important to consider construction costs. It is impractical to always design for the most intense rainfall event that may occur, or to set criteria for an unusually conservative frequency. The amount of rainfall expected from a 100-year storm can be double that of a 2-year storm, and would require a considerable difference in the storage volume of basins and the size of the outlet and conveyance structures. It is often recommended to design temporary controls for at least a 10-year storm.

The last factor to consider in selecting a design rainfall frequency is the evaluation of the consequences of failure for each implemented control measure. For example, consider the damage a flood would cause if a storm sewer overloads, or the consequences of the washing out of a sediment basin dike.



Rainfall Frequencies, 24-hour duration (rainfall in inches)

Numbers in parenthesis indicate the percent chance of the rainfall occurring in any given year.

Zone	2-year (50%)	5-year (20%)	10-year (10%)	25-year (4%)
1	2.39	3.00	3.48	4.17
2	2.09	2.71	3.19	3.87
3	2.09	2.70	3.21	3.89
4	2.11	2.62	3.04	3.60
5	2.28	3.00	3.60	4.48
6	2.27	2.85	3.34	4.15
7	2.14	2.65	3.05	3.56
8	2.37	3.00	3.52	4.45
9	2.42	2.98	3.43	4.09
10	2.26	2.75	3.13	3.60

Figure 7-4: Climatic Zones and Corresponding Rainfall Values

Estimating Runoff Volume and Peak Discharge

The runoff volume refers to the total amount of water that runs off a site as the result of a storm. Generally, as a site becomes more impervious, the runoff volume increases.

The depth of runoff leaving the site can be estimated using Table 7-3 which converts inches of rainfall to inches of runoff based on the runoff curve number (RCN) assigned for the site (Table 7-2). The total runoff volume is calculated by multiplying the runoff depth by the site area.

Peak discharge refers to the maximum rate at which the runoff passes a given location in terms of volume and time. It is measured in cubic feet per second (cfs) and must be determined to properly size water control structures, such as diversions and spillways.

The discharge rate is greatly influenced by the slope of the land that the water passes over, the steeper the slope, the higher the discharge rate. The "effective slope" of the site is the slope of the water path or water channel. It can be calculated by dividing the elevation difference of the site by the flow length. Flow length is the water travel distance along the main stream or water path from the site outlet point to the most distant high point on the site. Topographic maps and site plans are very useful in determining elevations and flow length.

$$\text{Effective Slope (\%)} = \frac{\text{Elevation Difference}}{\text{Flow Length}} \times 100$$

Table 7-4 is a tabular summary of unit peak discharge rates based on the effective slope and flow length. These values must be multiplied by the runoff depth (in inches) and watershed area (in acres) to determine the estimated total peak discharge rate. *This procedure is an approximate way of estimating runoff rates from small areas (less than a few hundred acres) for planning and review purposes only.*

Runoff volume and peak discharge calculations must consider all the water entering and leaving the site, not just what falls directly on the site. Therefore, one must determine the entire land area (commonly called a watershed) which contributes water to a given discharge point (Figure 7-5). As depicted in Figure 7-5, the entire "upstream" area must be included in the runoff calculations for Site "A." Runoff calculations for Site "B," however, would only include the rain that falls directly on the site because there is no "upstream" contributing area.

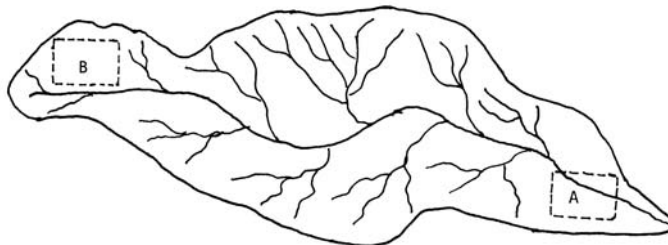

Figure 7-5: Watershed for Site A

Table 7-3: Expected Runoff Depth in Inches

Rainfall (Inches)	Curve Numbers														
	60	61	62	63	64	65	66	67	68	69	70	71	72	73	74
1.0	0.00	0.00	0.00	0.00	0.00	0.00	0.00	0.00	0.00	0.00	0.00	0.01	0.01	0.02	0.02
1.1	0.00	0.00	0.00	0.00	0.00	0.00	0.00	0.01	0.01	0.02	0.02	0.03	0.03	0.04	0.04
1.2	0.00	0.00	0.00	0.00	0.00	0.00	0.01	0.01	0.02	0.02	0.03	0.04	0.05	0.05	0.06
1.3	0.00	0.00	0.00	0.00	0.00	0.01	0.02	0.03	0.03	0.04	0.05	0.06	0.07	0.08	0.09
1.4	0.00	0.00	0.00	0.01	0.02	0.02	0.03	0.04	0.04	0.05	0.06	0.07	0.09	0.10	0.12
1.5	0.00	0.01	0.02	0.02	0.03	0.04	0.05	0.06	0.07	0.08	0.09	0.11	0.12	0.14	0.15
1.6	0.01	0.02	0.03	0.03	0.04	0.05	0.06	0.07	0.09	0.10	0.11	0.13	0.15	0.16	0.18
1.7	0.02	0.03	0.04	0.05	0.06	0.07	0.08	0.10	0.11	0.13	0.14	0.16	0.18	0.21	0.23
1.8	0.03	0.04	0.05	0.07	0.08	0.09	0.11	0.12	0.14	0.15	0.17	0.19	0.22	0.24	0.27
1.9	0.05	0.06	0.08	0.09	0.11	0.12	0.14	0.16	0.17	0.19	0.21	0.24	0.26	0.29	0.31
2.0	0.06	0.08	0.09	0.11	0.12	0.14	0.16	0.18	0.20	0.22	0.24	0.27	0.30	0.32	0.35
2.1	0.08	0.10	0.12	0.14	0.15	0.17	0.19	0.22	0.24	0.26	0.28	0.32	0.35	0.37	0.40
2.2	0.01	0.13	0.14	0.17	0.18	0.20	0.23	0.25	0.28	0.30	0.33	0.36	0.40	0.42	0.45
2.3	0.13	0.15	0.17	0.19	0.21	0.24	0.26	0.29	0.32	0.35	0.37	0.41	0.44	0.47	0.51
2.4	0.15	0.18	0.19	0.22	0.24	0.27	0.30	0.32	0.36	0.39	0.42	0.45	0.49	0.52	0.56
2.5	0.17	0.20	0.22	0.25	0.27	0.30	0.33	0.36	0.40	0.43	0.46	0.50	0.54	0.57	0.61
2.6	0.20	0.23	0.26	0.29	0.31	0.34	0.37	0.41	0.45	0.48	0.51	0.55	0.60	0.63	0.67
2.7	0.23	0.27	0.29	0.30	0.35	0.38	0.42	0.45	0.50	0.53	0.56	0.61	0.65	0.69	0.73
2.8	0.27	0.30	0.33	0.36	0.39	0.43	0.46	0.50	0.54	0.58	0.62	0.66	0.71	0.74	0.79
2.9	0.30	0.34	0.36	0.40	0.43	0.47	0.51	0.54	0.59	0.63	0.67	0.72	0.76	0.80	0.85
3.0	0.33	0.37	0.40	0.44	0.47	0.51	0.55	0.59	0.64	0.68	0.72	0.77	0.82	0.86	0.91
3.1	0.37	0.41	0.45	0.49	0.52	0.56	0.60	0.65	0.70	0.74	0.78	0.83	0.89	0.93	0.98
3.2	0.42	0.46	0.49	0.54	0.57	0.61	0.66	0.70	0.75	0.80	0.84	0.90	0.95	0.99	1.05
3.3	0.46	0.50	0.54	0.58	0.62	0.67	0.71	0.76	0.81	0.86	0.90	0.96	1.02	1.06	1.12
3.4	0.50	0.55	0.59	0.63	0.67	0.72	0.77	0.81	0.87	0.92	0.96	1.02	1.08	1.13	1.19
3.5	0.55	0.59	0.64	0.68	0.73	0.77	0.82	0.87	0.93	0.98	1.03	1.09	1.15	1.20	1.26
3.6	0.59	0.63	0.68	0.73	0.78	0.82	0.87	0.93	0.98	1.03	1.09	1.15	1.21	1.26	1.32
3.7	0.63	0.68	0.73	0.78	0.83	0.87	0.93	0.98	1.04	1.09	1.15	1.21	1.28	1.33	0.39
3.8	0.67	0.72	0.78	0.82	0.88	0.93	0.98	1.04	1.10	1.15	1.21	1.27	1.34	1.40	1.46
3.9	0.72	0.77	0.82	0.87	0.93	0.98	1.04	1.09	1.15	1.21	1.27	1.34	1.41	1.46	1.53
4.0	0.76	0.81	0.87	0.92	0.98	1.03	1.09	1.15	1.21	1.27	1.33	1.40	1.47	1.53	1.60
4.1	0.81	0.87	0.93	0.98	1.04	1.09	1.15	1.22	1.28	1.34	1.40	1.47	1.54	1.61	1.68
4.2	0.87	0.92	0.98	1.04	1.10	1.15	1.22	1.28	1.34	1.41	1.47	1.54	1.62	1.68	1.75
4.3	0.92	0.98	1.04	1.10	1.16	1.22	1.28	1.35	1.41	1.48	1.54	1.62	1.69	1.76	1.83
4.4	0.98	1.03	1.10	1.16	1.22	1.28	1.35	1.41	1.48	1.55	1.61	1.69	1.76	1.83	1.91
4.5	1.03	1.09	1.16	1.22	1.28	1.34	1.41	1.48	1.55	1.62	1.69	1.76	1.84	1.91	1.99
4.6	1.08	1.15	1.21	1.27	1.34	1.40	1.47	1.55	1.61	1.68	1.76	1.83	1.91	1.99	2.06
4.7	1.14	1.20	1.27	1.33	1.40	1.46	1.54	1.61	1.68	1.75	1.83	1.90	1.98	2.06	2.14
4.8	1.19	1.26	1.33	1.39	1.46	1.53	1.60	1.68	1.75	1.82	1.90	1.98	2.05	2.14	2.22
4.9	1.25	1.31	1.38	1.45	1.52	1.59	1.67	1.74	1.81	1.89	1.97	2.05	2.13	2.21	2.29
5.0	1.30	1.37	1.44	1.51	1.58	1.65	1.73	1.81	1.88	1.96	2.04	2.12	2.20	2.29	2.37
5.1	1.36	1.43	1.51	1.58	1.65	1.72	1.80	1.88	1.95	2.04	2.12	2.20	2.28	2.37	2.45
5.2	1.42	1.50	1.57	1.64	1.72	1.79	1.87	1.95	2.03	2.11	2.19	2.28	2.36	2.45	2.53
5.3	1.50	1.56	1.64	1.71	1.78	1.86	1.94	2.03	2.10	2.19	2.27	2.35	2.44	2.53	2.61
5.4	1.55	1.63	1.70	1.78	1.85	1.93	2.01	2.10	2.18	2.26	2.34	2.43	2.52	2.61	2.69
5.5	1.61	1.69	1.77	1.85	1.92	2.00	2.09	2.17	2.25	2.34	2.42	2.51	2.60	2.69	2.78
5.6	1.67	1.75	1.83	1.91	1.99	2.07	2.16	2.24	2.32	2.41	2.50	2.59	2.67	2.77	2.86
5.7	1.73	1.82	1.90	1.98	2.06	2.14	2.23	2.31	2.40	2.49	2.57	2.67	2.75	2.85	2.94
5.8	1.80	1.88	1.96	2.05	2.12	2.21	2.30	2.39	2.47	2.56	2.65	2.74	2.83	2.93	3.02
5.9	1.86	1.95	2.03	2.11	2.19	2.28	2.37	2.46	2.55	2.64	2.72	2.82	2.91	3.01	3.10
6.0	1.92	2.01	2.09	2.18	2.26	2.35	2.44	2.53	2.62	2.71	2.80	2.90	2.99	3.09	3.18
6.1	2.00	2.08	2.16	2.25	2.33	2.43	2.52	2.61	2.70	2.79	2.88	2.98	3.07	3.18	3.27
6.2	2.06	2.15	2.23	2.32	2.41	2.50	2.59	2.69	2.78	2.87	2.96	3.07	3.16	3.26	3.35
6.3	2.12	2.22	2.30	2.40	2.48	2.58	2.67	2.76	2.86	2.95	3.05	3.15	3.24	3.35	3.44
6.4	2.19	2.29	2.37	2.47	2.56	2.65	2.74	2.84	2.94	3.03	3.13	3.23	3.33	3.43	3.52
6.5	2.26	2.36	2.45	2.54	2.63	2.73	2.82	2.92	3.02	3.12	3.21	3.32	3.41	3.52	3.61
6.6	2.33	2.42	2.52	2.61	2.70	2.80	2.90	3.00	3.09	3.20	3.29	3.40	3.49	3.60	3.70
6.7	2.40	2.49	2.59	2.68	2.78	2.88	2.97	3.08	3.17	3.28	3.37	3.48	3.58	3.69	3.78
6.8	2.46	2.56	2.66	2.76	2.85	2.95	3.05	3.15	3.25	3.36	3.46	3.56	3.66	3.77	3.87
6.9	2.53	2.63	2.73	2.83	2.93	3.03	3.12	3.23	3.33	3.44	3.54	3.65	3.75	3.86	3.95
7.0	2.60	2.70	2.80	2.90	3.00	3.10	3.20	3.31	3.41	3.52	3.62	3.73	3.83	3.94	4.04

Table 7-3: Expected Runoff Depth in Inches (Continued)

Rainfall (Inches)	Curve Numbers															
	75	76	77	78	79	80	81	82	83	84	85	86	87	88	89	90
1.0	0.03	0.04	0.05	0.06	0.07	0.08	0.10	0.12	0.13	0.15	0.17	0.20	0.23	0.26	0.29	0.32
1.1	0.05	0.06	0.08	0.09	0.11	0.12	0.14	0.16	0.16	0.18	0.22	0.25	0.29	0.32	0.36	0.39
1.2	0.07	0.09	0.10	0.12	0.13	0.15	0.17	0.20	0.22	0.25	0.27	0.31	0.35	0.38	0.42	0.46
1.3	0.10	0.12	0.14	0.16	0.18	0.20	0.23	0.25	0.28	0.30	0.33	0.37	0.41	0.46	0.50	0.54
1.4	0.13	0.15	0.17	0.20	0.22	0.24	0.27	0.30	0.33	0.36	0.39	0.43	0.48	0.52	0.57	0.61
1.5	0.17	0.19	0.22	0.24	0.27	0.29	0.32	0.36	0.39	0.43	0.46	0.51	0.55	0.60	0.64	0.69
1.6	0.20	0.23	0.26	0.28	0.31	0.34	0.38	0.41	0.45	0.48	0.52	0.57	0.62	0.66	0.71	0.76
1.7	0.25	0.28	0.31	0.33	0.36	0.39	0.42	0.44	0.47	0.49	0.52	0.59	0.65	0.72	0.78	0.85
1.8	0.29	0.32	0.35	0.38	0.41	0.44	0.48	0.52	0.57	0.61	0.65	0.71	0.76	0.82	0.87	0.93
1.9	0.34	0.37	0.40	0.44	0.47	0.50	0.55	0.59	0.64	0.68	0.73	0.79	0.84	0.90	0.95	1.01
2.0	0.38	0.42	0.45	0.50	0.52	0.56	0.61	0.66	0.70	0.75	0.80	0.86	0.92	0.97	1.03	1.09
2.1	0.43	0.48	0.51	0.56	0.58	0.63	0.68	0.73	0.77	0.82	0.88	0.94	1.00	1.05	1.12	1.18
2.2	0.49	0.53	0.57	0.62	0.65	0.69	0.75	0.80	0.84	0.90	0.95	1.02	1.08	1.14	1.20	1.27
2.3	0.54	0.59	0.63	0.67	0.71	0.76	0.81	0.87	0.92	0.97	1.03	1.09	1.16	1.22	1.29	1.35
2.4	0.60	0.64	0.69	0.73	0.78	0.82	0.88	0.94	0.99	1.05	1.10	1.17	1.24	1.31	1.37	1.44
2.5	0.65	0.70	0.75	0.79	0.84	0.89	0.95	1.01	1.06	1.12	1.18	1.25	1.32	1.39	1.46	1.53
2.6	0.71	0.76	0.82	0.86	0.91	0.96	1.02	1.09	1.14	1.20	1.26	1.33	1.41	1.48	1.55	1.62
2.7	0.77	0.83	0.88	0.93	0.98	1.03	1.10	1.16	1.22	1.28	1.34	1.42	1.49	1.56	1.64	1.71
2.8	0.84	0.89	0.95	0.99	1.05	1.11	1.17	1.24	1.29	1.36	1.43	1.50	1.58	1.65	1.72	1.80
2.9	0.90	0.96	1.01	1.06	1.12	1.18	1.25	1.31	1.37	1.44	1.51	1.59	1.66	1.73	1.81	1.89
3.0	0.96	1.02	1.08	1.13	1.19	1.25	1.32	1.39	1.45	1.52	1.59	1.67	1.75	1.82	1.90	1.98
3.1	1.03	1.09	1.15	1.21	1.27	1.33	1.40	1.47	1.53	1.61	1.68	1.76	1.84	1.91	1.99	2.07
3.2	1.10	1.16	1.23	1.28	1.35	1.41	1.48	1.55	1.62	1.69	1.76	1.85	1.93	2.00	2.09	2.17
3.3	1.17	1.24	1.30	1.36	1.42	1.49	1.56	1.64	1.70	1.78	1.85	1.93	2.02	2.10	2.18	2.26
3.4	1.24	1.31	1.38	1.43	1.50	1.57	1.64	1.72	1.79	1.86	1.94	2.02	2.11	2.19	2.27	2.36
3.5	1.32	1.38	1.45	1.51	1.58	1.65	1.72	1.80	1.87	1.95	2.03	2.11	2.20	2.28	2.37	2.45
3.6	1.39	1.45	1.52	1.59	1.66	1.72	1.80	1.88	1.95	2.04	2.11	2.20	2.28	2.37	2.46	2.54
3.7	1.46	1.52	1.60	1.66	1.74	1.80	1.88	1.96	2.04	2.12	2.20	2.29	2.37	2.46	2.55	2.64
3.8	1.53	1.60	1.67	1.74	1.81	1.88	1.96	2.05	2.12	2.21	2.29	2.37	2.46	2.56	2.64	2.73
3.9	1.60	1.67	1.75	1.81	1.89	1.96	2.04	2.13	2.21	2.29	2.37	2.46	2.55	2.65	2.74	2.83
4.0	1.67	1.74	1.82	1.89	1.97	2.04	2.12	2.21	2.29	2.38	2.46	2.55	2.64	2.74	2.83	2.92
4.1	1.75	1.82	1.90	1.97	2.05	2.13	2.21	2.30	2.38	2.47	2.55	2.64	2.73	2.83	2.93	3.02
4.2	1.83	1.90	1.98	2.05	2.14	2.21	2.29	2.38	2.47	2.56	2.64	2.73	2.83	2.93	3.02	3.11
4.3	1.90	1.98	2.06	2.14	2.22	2.30	2.38	2.47	2.56	2.65	2.73	2.83	2.92	3.02	3.12	3.21
4.4	1.98	2.06	2.14	2.22	2.30	2.38	2.47	2.56	2.65	2.74	2.82	2.92	3.01	3.12	3.21	3.30
4.5	2.06	2.14	2.23	2.30	2.39	2.47	2.56	2.65	2.74	2.83	2.92	3.01	3.11	3.21	3.31	3.40
4.6	2.14	2.22	2.31	2.38	2.47	2.55	2.64	2.73	2.82	2.91	3.01	3.10	3.20	3.30	3.40	3.50
4.7	2.22	2.30	2.39	2.46	2.55	2.64	2.73	2.82	2.91	3.00	3.10	3.19	3.29	3.40	3.50	3.59
4.8	2.29	2.38	2.47	2.55	2.63	2.72	2.82	2.91	3.00	3.09	3.19	3.29	3.38	3.49	3.59	3.69
4.9	2.37	2.46	2.55	2.63	2.72	2.81	2.90	2.99	3.09	3.18	3.28	3.38	3.48	3.59	3.69	3.78
5.0	2.45	2.54	2.63	2.71	2.80	2.89	2.99	3.08	3.18	3.27	3.37	3.47	3.57	3.68	3.78	3.88
5.1	2.53	2.62	2.72	2.80	2.89	2.98	3.08	3.17	3.27	3.36	3.46	3.56	3.67	3.78	3.88	3.98
5.2	2.62	2.71	2.80	2.88	2.98	3.07	3.17	3.26	3.36	3.46	3.56	3.66	3.76	3.87	3.97	4.07
5.3	2.70	2.79	2.89	2.97	3.06	3.16	3.26	3.35	3.45	3.55	3.65	3.75	3.86	3.97	4.07	4.17
5.4	2.78	2.88	2.97	3.06	3.15	3.25	3.35	3.44	3.54	3.64	3.74	3.85	3.95	4.06	4.16	4.27
5.5	2.87	2.96	3.06	3.15	3.24	3.34	3.44	3.54	3.64	3.74	3.84	3.94	4.05	4.16	4.26	4.37
5.6	2.95	3.04	3.14	3.23	3.33	3.42	3.52	3.63	3.73	3.83	3.93	4.03	4.14	4.25	4.36	4.46
5.7	3.03	3.13	3.23	3.32	3.42	3.51	3.61	3.72	3.82	3.92	4.02	4.13	4.24	4.35	4.45	4.56
5.8	3.11	3.21	3.31	3.41	3.50	3.60	3.70	3.81	3.91	4.01	4.11	4.22	4.33	4.44	4.55	4.66
5.9	3.20	3.30	3.40	3.49	3.59	3.69	3.79	3.90	4.00	4.11	4.21	4.32	4.43	4.54	4.64	4.75
6.0	3.28	3.38	3.48	3.58	3.68	3.78	3.88	3.99	4.09	4.20	4.30	4.41	4.52	4.63	4.74	4.85
6.1	3.37	3.47	3.57	3.67	3.77	3.87	3.97	4.08	4.18	4.29	4.40	4.51	4.62	4.73	4.84	4.95
6.2	3.45	3.56	3.66	3.76	3.86	3.96	4.06	4.17	4.28	4.39	4.49	4.60	4.71	4.82	4.93	5.04
6.3	3.54	3.64	3.75	3.85	3.95	4.05	4.16	4.27	4.37	4.48	4.59	4.70	4.81	4.92	5.03	5.14
6.4	3.63	3.73	3.84	3.94	4.04	4.14	4.25	4.36	4.47	4.58	4.68	4.79	4.90	5.01	5.13	5.24
6.5	3.72	3.82	3.93	4.03	4.13	4.24	4.34	4.45	4.56	4.67	4.78	4.89	5.00	5.11	5.23	5.34
6.6	3.80	3.91	4.01	4.11	4.22	4.33	4.43	4.54	4.65	4.76	4.87	4.98	5.10	5.21	5.32	5.43
6.7	3.89	4.00	4.10	4.20	4.31	4.42	4.52	4.63	4.75	4.86	4.97	5.08	5.19	5.30	5.42	5.53
6.8	3.98	4.08	4.19	4.29	4.40	4.51	4.62	4.73	4.84	4.95	5.06	5.17	5.29	5.40	5.52	5.63
6.9	4.06	4.17	4.28	4.39	4.49	4.60	4.71	4.82	4.94	5.05	5.16	5.27	5.38	5.49	5.61	5.72
7.0	4.15	4.26	4.37	4.47	4.58	4.69	4.80	4.91	5.03	5.14	5.25	5.36	5.48	5.59	5.71	5.82

**TABLE 7-4: Unit Peak Discharge
cfs/acre/inch of runoff depth**

Slope percent	Flow Length (feet)													
	200	300	400	500	600	800	1000	1500	2000	2500	3000	4000	5000	6000
0.10	1.46	1.37	1.21	1.07	0.99	0.85	0.76	0.61	0.51	0.45	0.39	0.33	0.23	0.20
0.15	1.46	1.45	1.33	1.20	1.08	0.95	0.85	0.68	0.58	0.51	0.45	0.37	0.33	0.24
0.20	1.46	1.46	1.39	1.28	1.17	1.02	0.90	0.74	0.63	0.55	0.50	0.41	0.36	0.32
0.25	1.46	1.46	1.44	1.34	1.24	1.07	0.97	0.78	0.67	0.59	0.53	0.44	0.38	0.34
0.30	1.46	1.46	1.46	1.39	1.29	1.11	1.01	0.82	0.70	0.63	0.56	0.47	0.41	0.36
0.35	1.46	1.46	1.46	1.42	1.33	1.17	1.04	0.85	0.73	0.65	0.59	0.49	0.43	0.38
0.40	1.46	1.46	1.46	1.45	1.37	1.21	1.07	0.88	0.76	0.67	0.61	0.51	0.45	0.39
0.50	1.46	1.46	1.46	1.46	1.42	1.28	1.14	0.93	0.81	0.71	0.65	0.54	0.48	0.43
0.75	1.46	1.46	1.46	1.46	1.46	1.38	1.27	1.03	0.89	0.80	0.72	0.62	0.54	0.49
1.00	1.46	1.46	1.46	1.46	1.46	1.44	1.34	1.09	0.97	0.86	0.78	0.67	0.59	0.53
1.50	1.46	1.46	1.46	1.46	1.46	1.46	1.43	1.23	1.06	0.95	0.87	0.75	0.66	0.60
2.00	1.46	1.46	1.46	1.46	1.46	1.46	1.46	1.31	1.14	1.02	0.93	0.81	0.71	0.65
2.50	1.46	1.46	1.46	1.46	1.46	1.46	1.46	1.37	1.21	1.07	0.99	0.85	0.76	0.68
3.00	1.46	1.46	1.46	1.46	1.46	1.46	1.46	1.41	1.27	1.12	1.03	0.89	0.80	0.72
4.00	1.46	1.46	1.46	1.46	1.46	1.46	1.46	1.46	1.34	1.22	1.09	0.97	0.86	0.78
5.00	1.46	1.46	1.46	1.46	1.46	1.46	1.46	1.46	1.39	1.28	1.17	1.02	0.90	0.83
6.00	1.46	1.46	1.46	1.46	1.46	1.46	1.46	1.46	1.43	1.33	1.23	1.06	0.95	0.87
7.00	1.46	1.46	1.46	1.46	1.46	1.46	1.46	1.46	1.46	1.37	1.28	1.09	0.99	0.90
8.00	1.46	1.46	1.46	1.46	1.46	1.46	1.46	1.46	1.46	1.40	1.31	1.14	1.02	0.93
9.00	1.46	1.46	1.46	1.46	1.46	1.46	1.46	1.46	1.46	1.42	1.34	1.18	1.05	0.97

NOTE: The values in Table 7-4 are a function of the time it takes for runoff to travel through the watershed. This travel time becomes shorter as the flow length decreases and the slope increases. The shortest travel time for which the MDEQ computes runoff is 6 minutes, corresponding to a flow of 1.46 cfs/acre/inch of runoff. For combinations of flow length and slope that produce a travel time shorter than 6 minutes, a constant flow of 1.46 cfs/acre/inch of runoff should be used.

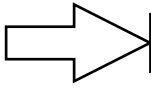

Please complete Practice Problems A and B in Appendix 7C.

Runoff Problem #1: Undeveloped Site

For the 40-acre site illustrated in Figure 7-6 (a hypothetical undeveloped site), compute the runoff volume and peak discharge for a 10-year, 24-hour rainfall. The site is located within a 120-acre watershed in Cheboygan County. Therefore, runoff calculations must be based on the total 120-acre watershed, not the 40-acre project site. The soils within the watershed are predominantly sandy loam. The project site has 8 acres under cultivation without conservation practices, 5 acres of woodland with good cover, and 27 acres of pasture in good condition. The remaining 80 acres in the watershed includes a 55-acre golf course in good condition, 15 acres of woodland with good cover, and 10 acres of pasture in good condition. The effective watershed slope averages 2% and flow length is 6000 feet.

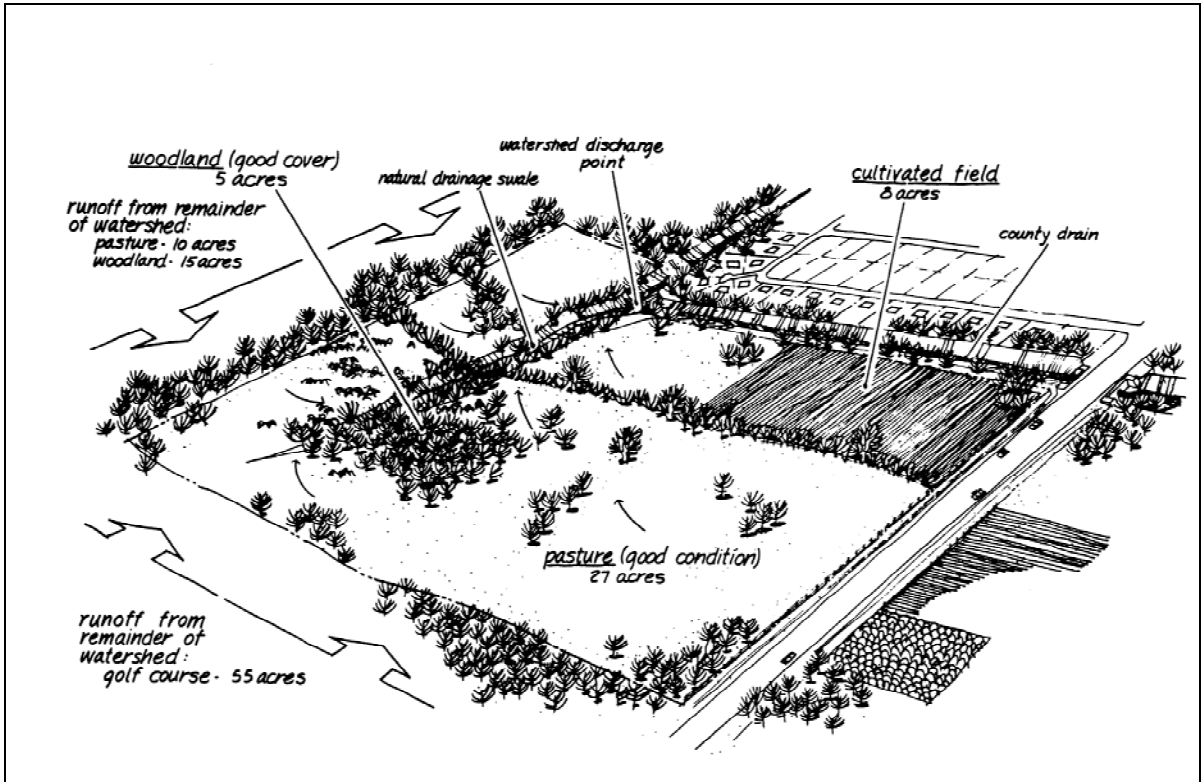

Figure 7-6: Undeveloped Agricultural Land

Step 1

Determine from Figure 7-4 that the 10-year, 24-hour rainfall in Cheboygan County is 3.04 inches (round to 3.0 inches).

Step 2

Determine from Page 7-7 that sandy loam soils are in hydrologic soil group "B."

Step 3

Compute the average runoff curve number for the watershed using Table 7-2:

<u>Land Use</u>	<u>Acres</u>		<u>RCN</u>		<u>Product</u>
Cultivated (without conservation)	8	x	81	=	648
Pasture (good condition)	37	x	61	=	2,257
Woodland (good cover)	20	x	55	=	1,100
Golf course (good condition)	<u>55</u>	x	61	=	<u>3,355</u>
	120				7,360

$$\text{Average RCN} = \frac{\text{Total Product}}{\text{Total Acres}} = \frac{7360}{120} = 61.33 \text{ (use 61).}$$

Step 4

Utilize Table 7-3 to determine runoff of 0.37 inches based on a curve number of 61 and rainfall of 3.0 inches. Total runoff from the watershed would be 156,816 cubic feet, computed as follows:

$$\begin{aligned} 0.37 \text{ inches of runoff divided by } 12 \text{ inches/foot} &= 0.03 \text{ feet} \\ 120 \text{ acres} \times 43,560 \text{ square feet/acre} &= 5,227,200 \text{ square feet} \\ 0.03 \text{ ft.} \times 5,227,200 \text{ square feet} &= 156,816 \text{ cubic feet} \end{aligned}$$

Step 5

Refer to Table 7-4 to compute peak discharge. Given that the slope is 2 percent and the watershed flow length is 6000 feet, the unit peak discharge is 0.65 cfs/acre/inch of runoff. Using the total runoff of 0.37 inches, the total peak discharge from the site (watershed) is 28.9 cfs, computed as follows:

$$0.65 \text{ cfs/acre/inch of runoff} \times 120 \text{ acres} \times 0.37 \text{ inches of runoff} = 28.9 \text{ cfs}$$

Runoff Problem #2: Site under Construction

Compute the volume and peak discharge for a 10-year, 24-hour rainfall for the same 40-acre site during the construction of a shopping center (Figure 7-7). The project site will include 10 acres of bare construction area, 9 acres of graveled parking and storage area, 9 acres of pasture in good condition, 7 acres of temporary grass cover, and 5 acres of woodland with good cover. The other 80 acres in the watershed remains the same as in Problem #1: golf course of 55 acres in good condition, 15 acres of woodland with good cover, and 10 acres of pasture in good condition. (Note: Table 7-2 does not include curve numbers for temporary cover; therefore, one must select a land use category that approximates the condition of the site. For example, if the grass is just starting to sprout, runoff characteristics may be similar to "newly developed areas." If the grass is established, "fair grass cover" or "poor pasture land" may be better choices. Use poor pasture land when working the problem.)

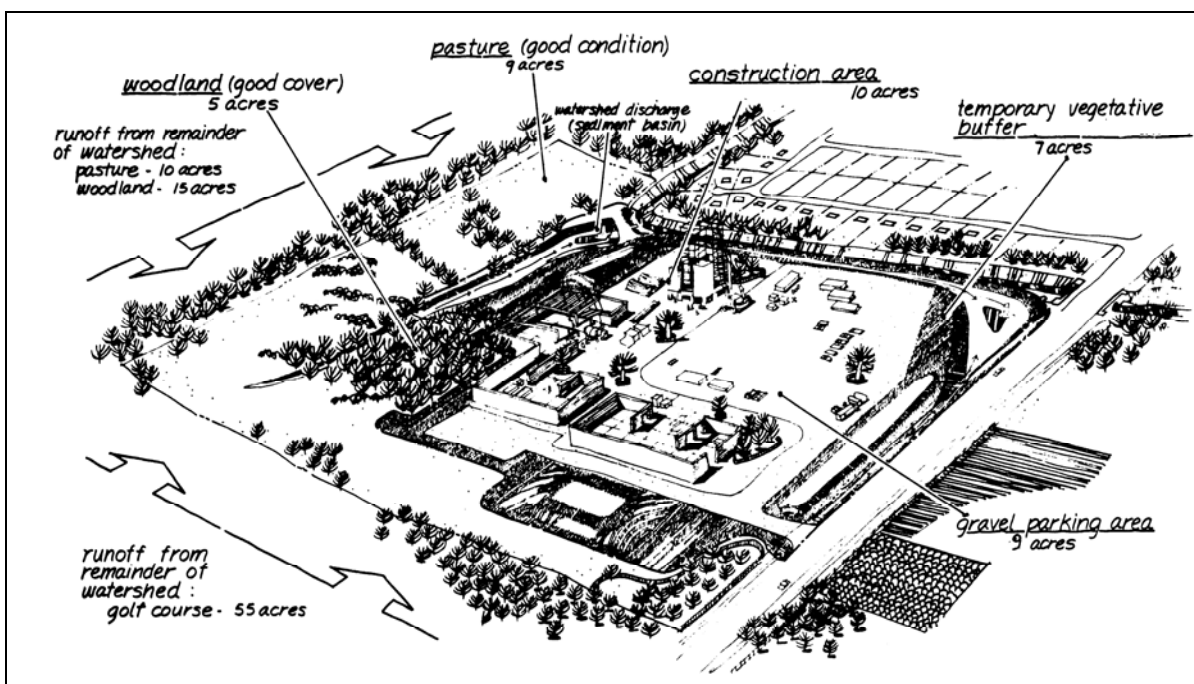

Figure 7-7: Shopping Center under Construction

Step 1

Compute the average runoff curve number for the watershed using Table 7-2 for hydrologic soil group "B," as determined in Problem 1.

<u>Land Use</u>	<u>Acres</u>		<u>RCN</u>		<u>Product</u>
Bare construction area	10	x	86	=	860
Graveled parking	9	x	85	=	765
Pasture (good condition)	19	x	61	=	1,159
Temporary grass cover	7	x	79	=	553
Woodland (good cover)	20	x	55	=	1,100
Golf course	<u>55</u>	x	61	=	<u>3,355</u>
	120				7,792

Average RCN = Total Product / Total Acres = 7792 / 120 = 64.9 (use RCN of 65)

Step 2

Utilize Table 7-3 to determine runoff of 0.51 inches based on curve number of 65 and rainfall of 3.0 inches (determined from Problem #1). Total runoff from the watershed would be 209,088 cubic feet, computed as follows:

0.51 inches of runoff divided by 12 inches/foot = 0.043 feet = 0.04 feet
 120 acres x 43,560 square feet/acre = 5,227,200 square feet
 0.04 ft. x 5,227,200 square feet = 209,088 cubic feet

Step 3

Assuming that neither the effective watershed slope nor the flow length has been modified, the unit peak discharge remains the same as determined in Problem #1 (0.65 cfs/acre/inch of runoff). Using total runoff of 0.51 inches, the peak discharge for the watershed is 39.8 cfs computed as follows:

0.65 cfs/acre/inch of runoff x 120 acres x 0.51 inches of runoff = 39.8 cfs

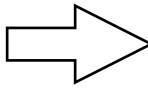

Please complete Practice Problem C in Appendix 7C.

Runoff Problem #3: Developed Site

Compute the runoff volume and peak discharge for a 10-year, 24-hour rainfall for the same 40-acre site in Runoff Problem #2 after the shopping center has been constructed (Figure 7-8). The site will include 21 acres of paved surfaces, 9 acres of meadow in good condition, 5 acres of maintained lawn, and 5 acres of woodland with good cover. The other 80 acres in the watershed remains the same as in Problem #1: a golf course of 55 acres in good condition, 15 acres of woodland with good cover, and 10 acres of pasture in good condition.

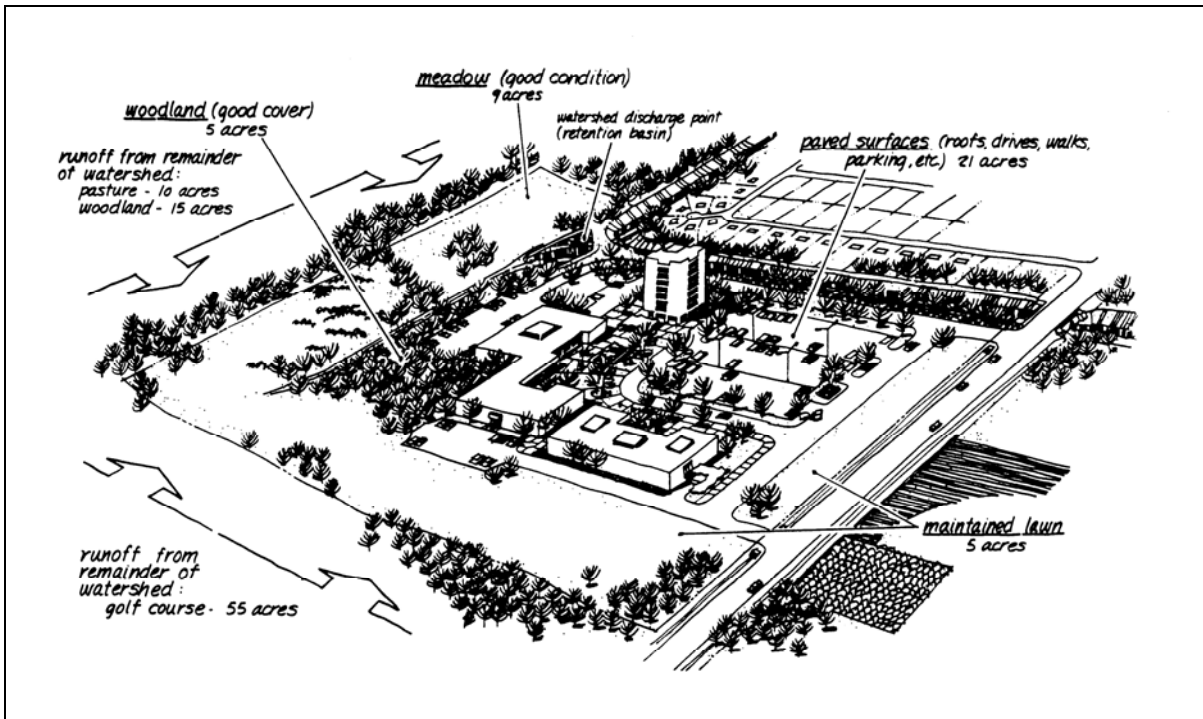

Figure 7-8: Proposed Shopping Center Development

Step 1

Compute the average runoff curve number for the watershed using values from Table 7-2 for hydrologic soil group "B" as determined in Problem #1.

<u>Land Use</u>	<u>Acres</u>		<u>RCN</u>	=	<u>Product</u>
Paved surfaces	21	x	98	=	2,058
Maintained lawn	5	x	61	=	305
Woodland (good cover)	20	x	55	=	1,100
Pasture (good condition)	10	x	61	=	610
Meadow	9	x	58	=	522
Golf course	<u>55</u>	x	61	=	<u>3,355</u>
	120				7,950

$$\text{Average RCN} = \frac{\text{Total Product}}{\text{Total Acres}} = \frac{7950}{120} = 66.25 \text{ (use 66).}$$

Step 2

Utilize Table 7-3 to determine runoff of 0.55 inches based on a curve number of 66 and rainfall of 3.0 inches (determined in Problem #1). Total runoff from the watershed would be 261,360 cubic feet, computed as follows:

$$\begin{aligned} 0.55 \text{ in. runoff divided by } 12 \text{ inches/foot} &= 0.046 \text{ feet} = 0.05 \text{ feet} \\ 120 \text{ ac.} \times 43,560 \text{ square feet/acre} &= 5,227,200 \text{ square feet} \\ 0.05 \text{ ft.} \times 5,227,200 \text{ square feet} &= 261,360 \text{ cubic feet} \end{aligned}$$

Step 3

As in the previous problem, the effective watershed slope and flow length has not changed, so the unit peak discharge remains the same (0.65 cfs/acre/inch of runoff). Using total runoff of 0.55 inches, the total peak discharge for the watershed is 42.9 cfs, computed as follows:

$$0.65 \text{ cfs/acre/inch of runoff} \times 120 \text{ acres} \times 0.55 \text{ inches of runoff} = 42.9 \text{ cfs}$$

These problems illustrate the effect that site development has on the volume and peak discharge of storm water runoff. All of the factors affecting the runoff, except storm frequency, are taken directly from tables based on knowledge of the site condition (soil type, land use, area, slope, etc.) and are, for the most part, not variable. Storm frequency, however, is variable and can greatly affect the runoff calculations.

Application of Runoff Calculations

Determining the runoff volume and discharge rate is necessary to develop a comprehensive SESC plan, both during construction and after project completion. It is necessary to know the quantity of runoff to design adequate water storage facilities, such as sediment basins and storm water retention ponds (Figure 7-9).



Figure 7-9

It is necessary to know the peak discharge of runoff at a given point to design adequate water conveyance devices, such as ditches, diversions, culverts, and outlets for sediment basins and storm water ponds. Refer to the NRCS and local conservation district standards and specifications for specific applications for the open channel type devices, such as ditches and diversions. For temporary pipes and culverts in non-critical areas, such as temporary channel crossings or the outlets of

temporary sediment basins, the manufacturers' specifications may be appropriate to use for determining the size of the pipe necessary to accommodate the calculated discharge. For critical applications, such as permanent stream crossings, permanent storm water retention basin outlets and underground storm drainage systems, the project should be thoroughly engineered and all variables considered.

Summary

The proper design and implementation of virtually all erosion and sedimentation control measures is dependent on an understanding of the erodibility and settlement rate of the different soil types found on a construction site (Table 7-5).

The ability to identify soils, in conjunction with knowledge of how soil properties influence erodibility, runoff potential, and settlement rate, will allow one to identify potential problem areas both on and off the site. Knowledge of on-site soils is essential when making decisions regarding erosion control, vegetation stabilization, runoff control structures, and the effectiveness of sedimentation basins. The effectiveness of specific erosion and sedimentation control measures varies with each general soil type.

Table 7-5. The influence of soil properties on erodibility, runoff potential, and settlement rate.

General Soil Type	Erodibility	Runoff Potential	Settlement Rate
SILTY SOILS, silt, silt loam	High	Moderate	Low
CLAYEY SOILS – clay, clay loam	Moderate	High	Low
LOAMY SOILS – loam, sandy loam	Moderate	Moderate	Moderate
SANDY SOILS – sand, loamy sand	Low	Low	High

Erodibility

Erodibility gives an indication of how easily wind or water will detach and transport soils on a site.

All soils have been assigned an erodibility status by the NRCS. Silty soils tend to be highly erosive, clayey and loamy soils tend to have moderate erodibility, and sandy soils generally have low erodibility (although very fine sands can also be very erodible).

Settlement Rate

Settlement refers to the rate at which eroded soil particles settle out of suspension after being detached by flowing water. Sandy soils have a high settlement rate. Loamy soils have a moderate settlement rate. Clay and silty soils have a low settlement rate.

Where soils have a low settlement rate it can mean that it can be extremely difficult or costly to remove these soils from runoff once they become mobile. When soils indicate a low settlement rate, plan designers should attempt to prevent the soils from becoming mobilized whenever possible.

Silty Soils

The presence of silty soils dictates that a very comprehensive soil erosion and sedimentation control plan be developed because silty soils are more susceptible to erosion and sedimentation problems than other soils. These soils are extremely erodible and must be effectively stabilized with a vegetative or mechanical (paved) cover. Large sediment collecting areas are required to allow the easily eroded soil particles a chance to settle out.

Clayey Soils

The presence of clay soils requires a comprehensive SESC plan, with particular emphasis on controlling runoff. Clay soils are only moderately erodible, but are difficult to remove from runoff water prior to leaving a site. Sediment control measures are ineffective for settling out the small clay sized particles without the addition of polymers. Vegetative stabilization is important because of the soil's moderate erodibility.

Loamy Soils

The presence of loamy soils requires a comprehensive SESC plan, with equal emphasis on all control measures. Water control devices and sediment collection areas do not have to be as large or extensive as those required for silty or clay soils.

Sandy Soils

The presence of sandy soils requires the least extensive SESC plan, since they are relatively resistant to erosion. If sand is eroded, the particles are generally not transported far because of minimal runoff potential and the rapid particle settlement rate. Water control devices seldom need to be large and sediment collection areas can be small. Particular attention must be paid to concentrated flow areas because sand soils are particularly susceptible to erosion under concentrated flow conditions. Vegetation is difficult to establish so it is often difficult to completely stabilize these soils. The lack of stabilization makes sandy soils difficult to manage since they tend to "shift" and be deposited locally, often clogging drainage ways and storm sewers. Emphasis must be given to frequent maintenance of control measures, particularly cleaning out of traps and channels.

Appendix 7A Determining Soil Texture In The Field

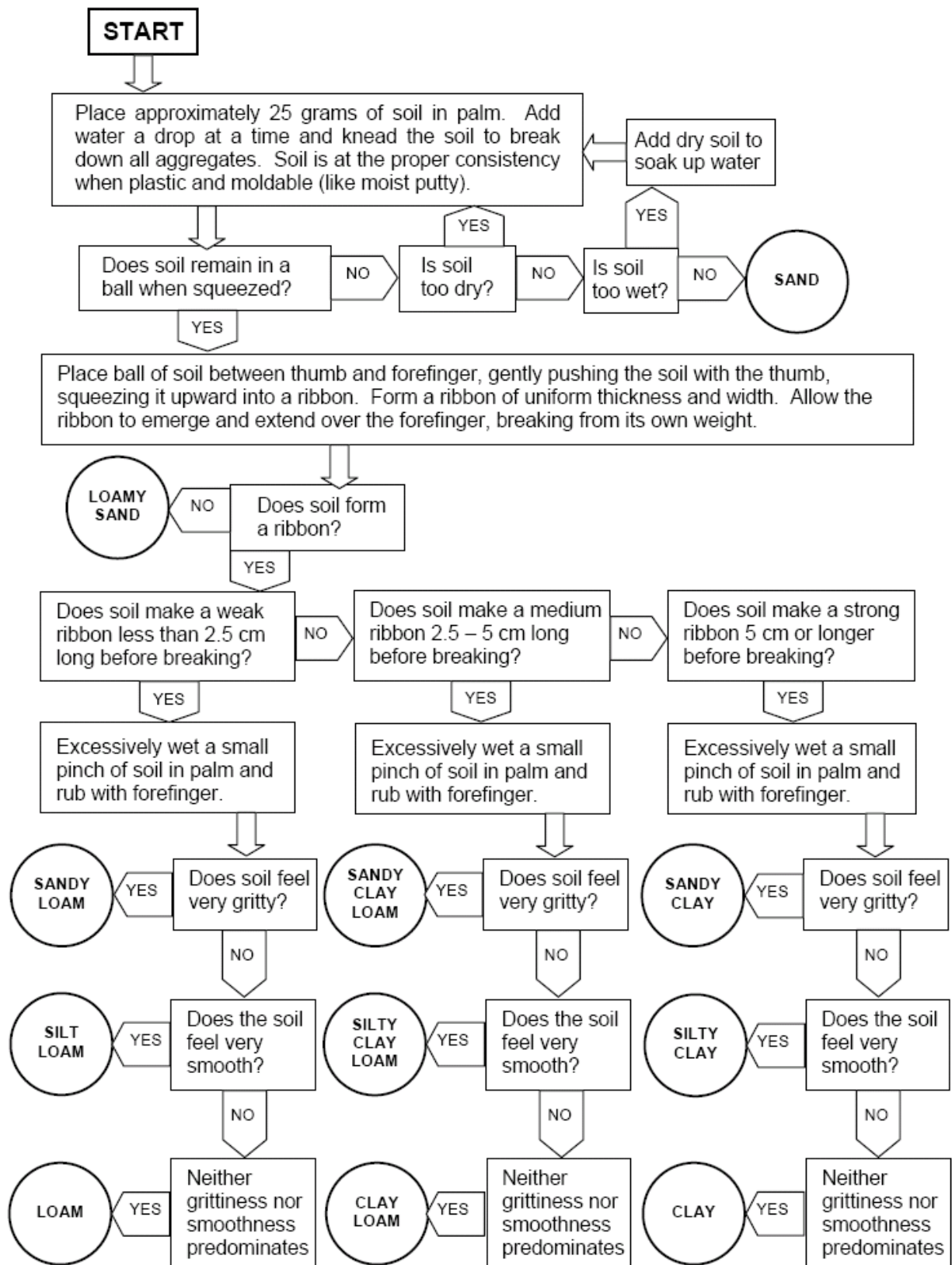

Source: Steve Thien, Kansas State University

Appendix 7B
HYDROLOGIC SOIL GROUPS FOR MICHIGAN SOILS
(July 2000)

<u>Soil series</u>	<u>Group</u>	<u>Soil series</u>	<u>Group</u>	<u>Soil series</u>	<u>Group</u>
Abbaya	B	Brassar	C	Dighton	B
Abscota	A	Breckenridge	D/B	Dixboro	B
Adrian	D/A	Brems	A	Dora	D/B
Alcona	B	Brevort	D/B	Dowagiac	B
Algansee	B	Brimley	B	Dresden	B
Allendale	B	Bronson	B	Dryburg	B
Allouez	B	Brookston	D/B	Dryden	B
Alpena	A	Bruce	D/B	Duel	A
Alstad	C	Burleigh	D/A	Dungridge	B
Amasa	B	Burt	D	East Lake	A
Angelica	D/B	Cadmus	B	Eastport	A
Arkona	B	Capac	C	Edmore	D
Arkport	B	Carbondale	D/A	Edwards	D/B
Arnheim	D	Carlisle	D/A	Eel	B
Ashkum	D/B	Caasopolis	B	Eleva	B
Assinins	B	Cathro	D/A	Elmdale	B
Aubarque	D/C	Celina	C	Elston	B
Aubbeenaubbee	B	Ceresco	B	Elvers	D/B
Au Gres	B	Champion	B	Emmet	B
Aurelius	D/B	Channahon	D	Ensign	D
Avoca	B	Channing	B	Ensley	D/B
Bach	D/B	Charity	D	Epoufette	D/B
Badaxe	B	Charlevoix	B	Epworth	A
Banat	B	Chatham	B	Ermatinger	D/B
Barry	D/B	Cheboygan	B	Esau	A
Battlefield	D/A	Chelsea	A	Escanaba	A
Beavertail	D	Chesaning	B	Essexville	D/A
Beechwood	C	Chestonia	D	Ewart	D
Belding	B	Chippeny	D	Fabius	B
Belleville	D/B	Cohoctah	D/B	Fairport	C
Benona	A	Coloma	A	Fence	B
Bergland	D	Colonville	C	Fibre	D/B
Berville	D/B	Colwood	D/B	Filion	D
Biscuit	D/B	Conover	C	Finch	C
Bixby	B	Coral	C	Fox	B
Bixler	C	Corunna	D/B	Frankenmuth	C
Blount	C	Coupee	B	Frenchette	B
Blue Lake	A	Covert	A	Freda	D
Bohemian	B	Crosier	C	Froberg	D
Bonduel	C	Croswell	A	Fulton	D
Bono	D	Cunard	B	Gaastra	C
Boots	D/A	Cushing	B	Gagetown	B
Borski	B	Dawson	D/A	Gay	D/B
Bowers	C	Deer Park	A	Genesee	B
Bowstring	D/A	Deerton	A	Gilchrist	A
Boyer	B	Deford	D/A	Gilford	D/B
Brady	B	Del Rey	C	Gladwin	A
Branch	B	Detour	B	Glawe	D/B

Two soil groups, such as D/B, indicates the undrained/drained condition.

HYDROLOGIC SOIL GROUPS FOR MICHIGAN SOILS (July 2000)

<u>Soil series</u>	<u>Group</u>	<u>Soil series</u>	<u>Group</u>	<u>Soil series</u>	<u>Group</u>
Glendora	D/A	Keowns	D/B	Miami	B
Glynwood	C	Kerston	D/A	Michigamme	C
Gogebic	B	Keweenaw	A	Millsdale	D/B
Gogomain	D/B	Kibbie	B	Milton	C
Goodman	B	Kidder	B	Minoa	C
Gorham	D/B	Kilmanagh	C	Minocqua	D/B
Grace	B	Kingsville	D/A	Minong	D
Granby	D/A	Kinross	D/A	Misery	C
Grattan	A	Kiva	A	Mitiwanga	C
Graveraet	B	Klacking	A	Moltke	B
Graycalm	A	Kokomo	D/B	Monico	C
Grayling	A	Koontz	D	Monitor	C
Greenwood	D/A	Krakov	B	Montcalm	A
Grindstone	C	Lacota	D/B	Moquah	B
Grousehaven	D	Lamson	D/B	Morley	C
Guardlake	A	Landes	B	Morocco	B
Guelph	B	Lapeer	B	Mudsock	D/B
Gutport	D	Latty	D	Munising	B
Hagensville	C	Leelanau	A	Munuscong	D/B
Halfaday	A	Lenawee	D/B	Mussey	D/B
Hatmaker	C	Leoni	B	Nadeau	B
Henrietta	D/B	Liminga	A	Nahma	D/B
Hessel	D/B	Linwood	D/A	Napoleon	D/A
Hettinger	D/C	Locke	B	Nappanee	D
Hillsdale	B	Lode	B	Nester	C
Hodenpyl	B	Londo	C	Net	C
Houghton	D/A	Longrie	B	Newaygo	B
Hoytville	D/C	Loxley	D/A	Newton	D/A
Huntington	B	Lupton	D/A	Nottawa	B
Ingalls	B	Mackinac	B	Nunica	C
Ingersoll	B	Macomb	B	Oakville	A
Ionia	B	Mancelona	A	Ockley	B
Iosco	B	Manistee	A	Oconto	B
Isabella	B	Manitowish	B	Ocqueoc	A
Ishpeming	A	Markey	D/A	Ogemaw	D/C
Ithaca	C	Marlette	B	Okee	B
Jacobsville	D	Martinsville	B	Oldman	C
Jeddo	D/C	Martisco	D/B	Olentangy	D/A
Jesso	C	Matherton	B	Omega	A
Johnswood	B	Maumee	D/A	Omena	B
Kalamazoo	B	McBride	B	Onaway	B
Kalkaska	A	Mecosta	A	Onota	B
Kallio	C	Melita	A	Ontonagon	D
Karlin	A	Menagha	A	Ormas	B
Kawbawgam	C	Menominee	A	Oshtemo	B
Kakkawlin	C	Mervin	D/A	Otisco	A
Kendallville	B	Metamora	B	Ottokee	A
Kent	D	Metea	B	Owosso	B

Two soil groups, such as D/B, indicates the undrained/drained condition.

HYDROLOGIC SOIL GROUPS FOR MICHIGAN SOILS (July 2000)

<u>Soil series</u>	<u>Group</u>	<u>Soil series</u>	<u>Group</u>	<u>Soil series</u>	<u>Group</u>
Paavola	B	Saganing	D/A	Thomas	D/B
Padus	B	Sanilac	B	Tobico	D/A
Palms	D/A	Saranac	D/C	Toledo	D
Parkhill	D/B	Sarona	B	Tonkey	D/B
Paulding	D	Satago	D	Toogood	A
Pelkie	A	Saugatuck	C	Trenary	B
Pella	D/B	Saylesville	C	Trimountain	B
Pemene	B	Sayner	A	Tula	C
Pence	B	Scalley	B	Tuscola	B
Pendleton	C	Schoolcraft	B	Tustin	B
Pequaming	A	Sebawa	D/B	Twining	C
Perrin	B	Selfridge	B	Tyre	D/A
Perrinton	C	Selkirk	C	Ubly	B
Pert	D	Seward	B	Velvet	C
Peshekee	D	Shebeon	C	Vestaburg	D/A
Petticoat	B	Shelldrake	A	Vilas	A
Pewamo	D/C	Shelter	B	Volinia	B
Pickford	D	Shiawassee	C	Wainola	B
Pinconning	D/B	Shinrock	C	Waiska	B
Pinnebog	D/A	Shoals	C	Wakefield	B
Pipestone	B	Sickles	D/B	Wallace	B
Plainfield	A	Sims	D	Walkkill	D/C
Pleine	D	Sisson	B	Warners	D/C
Ponozzo	C	Skanee	C	Wasepi	B
Posen	B	Sleeth	C	Washtenaw	D/C
Poseyville	C	Sloan	D/B	Watton	C
Potagannissing	D	Solona	C	Waucedah	D
Poy	D	Soo	D/C	Wauseon	D/B
Proctor	B	Sparta	A	Wautoma	D/B
Randolph	C	Spinks	A	Wega	B
Rapson	B	Springlake	A	Westbury	C
Remus	B	St. Clair	D	Whalan	B
Rensselaer	D/B	St. Ignace	D	Wheatley	D/A
Richter	B	Stambaugh	B	Whitaker	C
Riddles	B	Steuben	B	Whitehall	B
Rifle	D/A	Sturgeon	B	Willette	D/A
Riggsville	C	Sugar	B	Winneshiek	B
Rimer	C	Summerville	D	Winterfield	D/A
Riverdale	A	Sundell	B	Wisner	D/B
Rockbottom	B	Sunfield	B	Witbeck	D/B
Rockcut	B	Superior	D	Wixom	B
Rodman	A	Tacoosh	D/B	Wolcott	D/B
Ronan	D	Tallula	B	Woodbeck	B
Rondeau	D/A	Tamarack	B	Yalmer	B
Roscommon	D/A	Tappan	D/B	Ypsi	C
Roselms	D	Tawas	D/A	Zeba	B
Rousseau	A	Teasdale	B	Ziegenfuss	D
Rubicon	A	Tedrow	B	Zilwaukee	D
Rudyard	D	Tekenink	B	Zimmerman	A
Ruse	D	Thetford	A		

Two soil groups, such as D/B, indicates the undrained/drained condition.

**Appendix 7C
PRACTICE PROBLEMS**

Practice Problems A, B, and C

Practice Problem A: Calculating Runoff from an Undisturbed Site

Situation: A factory and parking lot is proposed to be constructed on five (5) acres near Lansing (Ingham County). Runoff from the surrounding area is diverted away from the site. Assume that all runoff originating on the site leaves at the southeast corner.

Site: Soil: Boyer Loamy Sand
Slope: 2 percent
Water Flow Length: 800 feet

Problem: Calculate the volume of runoff and the peak discharge (Q_2) generated at the outlet of the site during a 5-year, 24-hour rainfall for the present undisturbed (dense grass) condition.

Solution: **5-year rainfall** for Ingham County: _____ inches
(Figure 7-4, Page 7-10)

Hydrologic Group for Boyer Loamy Sand: _____
(Appendix 7B)

Runoff Curve Number (RCN) for site: _____
(Table 7-2, Page 7-8)

Expected Runoff from Site: _____ inches
(Based on RCN of _____ and Rainfall of _____ inches)
(Table 7-3, Page 7-12)

Volume of Runoff = Runoff Depth x Watershed Area
(To express volume in cubic feet, convert runoff and area to "feet")

_____ inches of runoff divided by 12 inches/foot = _____ feet

_____ acres x 43,560 square feet/acre = _____ square feet

_____ feet of runoff x _____ square feet = _____ cubic feet

Unit Peak Discharge: $Q_1 =$ _____ cfs/acre/inch
(Based on Slope of _____ and Flow Length of _____ feet)
(Table 7-4, Page 7-14)

Peak Discharge of Site: $Q_2 = Q_1 \times \text{area} \times \text{runoff}$

_____ cfs/acre/inch x _____ acres x _____ inches of runoff = _____ cfs

NOTE: cfs = cubic feet per second
X = means to multiply

Practice Problem B: Calculating Runoff during Construction

Situation: A factory and parking lot is proposed to be constructed on five acres near Lansing (Ingham County). Runoff from the surrounding area is diverted away from the site. Assume that all runoff originating on the site leaves at the southeast corner.

Site: Soil: Boyer Loamy Sand
Slope: 2 percent
Water Flow Length: 800 feet

Problem: Calculate the volume of runoff and the peak discharge (Q_2) generated at the outlet of the site during a 5-year, 24-hour rainfall during construction after the grass has been removed.

Solution: **5-year rainfall** for Ingham County: _____ inches
(Figure 7-4, Page 7-10)

Hydrologic Group for Boyer Loamy Sand: _____
(Appendix 7B)

Runoff Curve Number (RCN) for site _____
(Table 7-2, Page 7-8)

Expected Runoff from Site (Appendix A): _____ inches
(Based on RCN of _____ and Rainfall of _____ inches)
(Table 7-3, Page 7-12)

Volume of Runoff = Runoff Depth x Watershed Area
(To express volume in cubic feet, convert runoff and area to "feet")

_____ inches of runoff divided by 12 inches/foot = _____ feet

_____ acres x 43,560 square feet/acre = _____ square feet

_____ feet of runoff x _____ square feet = _____ cubic feet

Unit Peak Discharge: $Q_1 =$ _____ cfs/acre/inch
(Based on Slope of _____ and Flow Length of _____ feet)
(Table 7-4, Page 7-14)

Peak Discharge of Site: $Q_2 = Q_1 \times \text{area} \times \text{runoff}$

_____ cfs/acre/inch x _____ acres x _____ inches of runoff = _____ cfs

Practice Problem C: Calculating Runoff from a Developed Site

Situation: Twenty-one (21) acres within a 120-acre watershed with mixed land cover were recently developed in Cheboygan County.

Site: Soil: Rapson Loamy Sand
Slope: 2 percent
Water Flow Length: 6000 feet

Problem: Calculate the volume of runoff and the peak discharge (Q_2) generated from the above described site during a 10-year, 24-hour rainfall.

Solution: **10-year rainfall** for Cheboygan County: _____ inches
(Figure 7-4, Page 7-10)

Hydrologic Group for Rapson Loamy Sand (Appendix 7B): _____

Weighted Runoff Curve Number (RCN) for site (Table 7-2, page 7-8):

<u>Land Cover</u>	<u>Acres</u>		<u>RCN</u>		<u>Product</u>
Roofs, Driveways, Parking	21	x	_____	=	_____
Open Space (good)	5	x	_____	=	_____
Forest Land (good)	20	x	_____	=	_____
Range Land (good)	10	x	_____	=	_____
Meadow (good)	9	x	_____	=	_____
Parks (good)	55	x	_____	=	_____
Totals:			_____		_____

Weighted RCN = $\frac{\text{Total Product}}{\text{Total Acres}}$ = _____; round to _____

Expected Runoff from Site (Table 7-3, page 7-12): _____ inches
(Based on RCN of _____ and Rainfall of _____ inches)

Volume of Runoff = Runoff Depth x Watershed Area

(To express volume in cubic feet, convert runoff and area to "feet")

_____ inches of runoff divided by 12 inches/foot = _____ feet

_____ acres x 43,560 square feet/acre = _____ square feet

_____ feet of runoff x _____ square feet = _____ cubic feet

Unit Peak Discharge: Q_1 = _____ cfs/acre/inch

(Based on Slope of _____ and Flow Length of _____ feet)

(Table 7-4, page 7-14)

Peak Discharge of Site: $Q_2 = Q_1 \times \text{area} \times \text{runoff}$

_____ cfs/acre/inch x _____ acres x _____ inches of runoff = _____ cfs

Answers to Practice Problems A, B, and C

Answers to Practice Problem A

5-year rainfall for Ingham County: 2.98 inches (use 3.0 inches)

Hydrologic Group for Boyer Loamy Sand: B

Runoff Curve Number (RCN) for site): 61

Expected Runoff from Site: 0.37 inches
(Based on RCN of 61 and Rainfall of 3.0 inches)

Volume of Runoff = Runoff Depth x Watershed Area
(To express volume in cubic feet, convert runoff and area to "feet")

0.37 inches of runoff divided by 12 inches/foot = 0.03 feet

5 acres x 43,560 square feet/acre = 217,800 square feet

0.03 feet of runoff x 217,800 square feet = 6,534 cubic feet

Unit Peak Discharge: $Q_1 = 1.46$ cfs/acre/inch
(Based on Slope of 2% and Flow Length of 800 feet)

Peak Discharge of Site: $Q_2 = Q_1 \times \text{area} \times \text{runoff}$

1.46 cfs/acre/inch x 5 acres x 0.37 inches of runoff = 2.7 cfs

Answers to Practice Problem B

5-year rainfall for Ingham County: 2.98 inches (**use 3.0 inches**)

Hydrologic Group for Boyer Loamy Sand: **B**

Runoff Curve Number (RCN) for site: 86

Expected Runoff from Site: 1.67 inches
(Based on RCN of 86 and Rainfall of 3.0 inches)

Volume of Runoff = Runoff Depth x Watershed Area
(To express volume in cubic feet, convert runoff and area to "feet")

1.67 inches of runoff divided by 12 inches/foot = 0.14 feet

5 acres x 43,560 square feet/acre = 217,800 square feet

0.14 feet of runoff x 217,800 square feet = 30,492 cubic feet

Unit Peak Discharge: $Q_1 = 1.46$ cfs/acre/inch
(Based on Slope of 2% and Flow Length of 800 feet)

Peak Discharge of Site: $Q_2 = Q_1 \times \text{area} \times \text{runoff}$

1.46 cfs/acre/inch x 5 acres x 1.67 inches of runoff = 12.2 cfs

Answers to Practice Problem C

Situation: Twenty-one (21) acres within a 120-acre watershed with mixed land cover were recently developed in Cheboygan County.

Site: Soil: Rapson Loamy Sand
Slope: 2 percent
Water Flow Length: 6000 feet

Problem: Calculate the volume of runoff and the peak discharge (Q_2) generated from the above described site during a 10-year, 24-hour rainfall.

Solution: Use the **Soils and Runoff Manual**

10-year rainfall for Cheboygan County: 3.04 inches (**use 3.0 inches**)

Hydrologic Group for Rapson Loamy Sand (Appendix 7B): **B**

Weighted Runoff Curve Number (RCN) for site (Table 7-2, page 7-8):

<u>Land Cover</u>	<u>Acres</u>		<u>RCN</u>		<u>Product</u>
Roofs, Driveways, Parking	21	x	<u>98</u>	=	<u>2058</u>
Open Space (good)	5	x	<u>61</u>	=	<u>305</u>
Forest Land (good)	20	x	<u>55</u>	=	<u>1100</u>
Range Land (good)	10	x	<u>61</u>	=	<u>610</u>
Meadow (good)	9	x	<u>58</u>	=	<u>522</u>
Parks (good)	55	x	<u>61</u>	=	<u>3355</u>
Totals:	<u>120</u>				<u>7950</u>

$$\text{Weighted RCN} = \frac{\text{Total Product}}{\text{Total Acres}} = \frac{7950}{120 \text{ acres}} = \underline{66.25}; \text{ round to } \underline{66}$$

Expected Runoff from Site (Table 7-3, page 7-12): 0.55 inches
(Based on RCN of 66 and Rainfall of 3.0 inches)

Volume of Runoff = Runoff Depth x Watershed Area
(To express volume in cubic feet, convert runoff and area to "feet")

0.55 inches of runoff divided by 12 inches/foot = 0.05 feet

120 acres x 43,560 square feet/acre = 5,227,200 square feet

0.05 feet of runoff x 5,227,200 square feet = 261,360 cubic feet

Unit Peak Discharge: $Q_1 = \underline{0.65}$ cfs/acre/inch
(Based on Slope of 2% and Flow Length of 6,000 feet)

Peak Discharge of Site: $Q_2 = Q_1 \times \text{area} \times \text{runoff}$

0.65 cfs/acre/inch x 120 acres x 0.55 inches of runoff = 42.9 cfs

Unit Eight

SESC PLAN REVIEW/DOCUMENT EXERCISES

Introduction

This unit is intended to provide the reader with an introductory experience with the process of reviewing and developing Soil Erosion and Sedimentation Control (SESC) plans. It contains several exercises which require the reader to utilize information presented throughout the manual. Specifically, a competent SESC planner must be knowledgeable about the appropriate use of SESC measures. The reader should be familiar with information in Unit 2 and Appendix I before completing these exercises.

Completed examples of each of the exercises appear in the appendices after the chapter. The reader should review the examples and gain understanding about each exercise prior to moving to the next exercise. It should be noted that there are often several “appropriate” ways to solve SESC issues at construction sites, and therefore, the reader should not expect to have identical answers to the examples provided. The objective of the reader should be to understand how the information in other units of this manual relates to the planning process and how to properly utilize that information to assure that SESC issues are addressed and the plan is compliant with Part 91.

Plan Review Exercise

Sites which require an SESC permit, and many projects undertaken by APAs, are required by Rule 1703 to develop an SESC plan which contains, at a minimum, the following information:

- Map (plan) with a scaled drawing of not more than 200 feet to the inch**
- A site location sketch**
- The proximity of the proposed earth change to lakes and streams**
- Predominant land features**
- Existing and proposed contour intervals or slope description**
- A soils survey or written description of the soils of the anticipated exposed land area**
- A description and the location of the physical limits of each proposed earth change**
- A description and the location of all existing and proposed on-site drainage and dewatering facilities**
- The timing and sequence of each proposed earth change**
- The location and description for installing and removing all proposed temporary SESC measures**
- A description and the location of all proposed permanent SESC measures**
- A program proposal for the continued maintenance of all permanent SESC measures, including the person responsible for the maintenance**

Exercise 1: Figure 10-1 provides an example of an SESC plan that does not contain all elements in Rule 1703 and is inadequate in terms of SESC measures. Check the required elements you find on the previous page. Note any other inadequacies on the plan. A completed example of Exercise 1 is located in Appendix 10A.

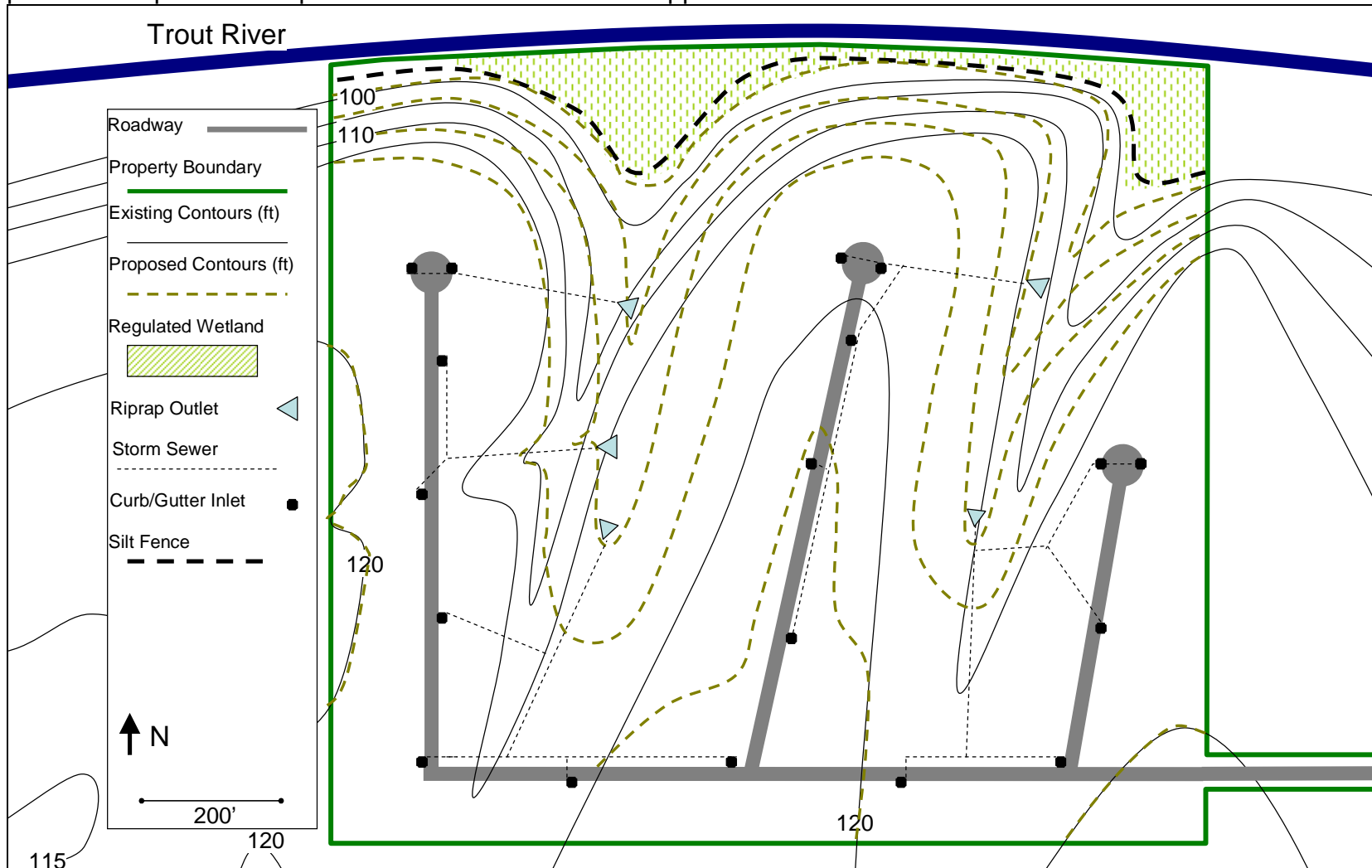

Figure 10-1: Example of Inadequate SESC Plan

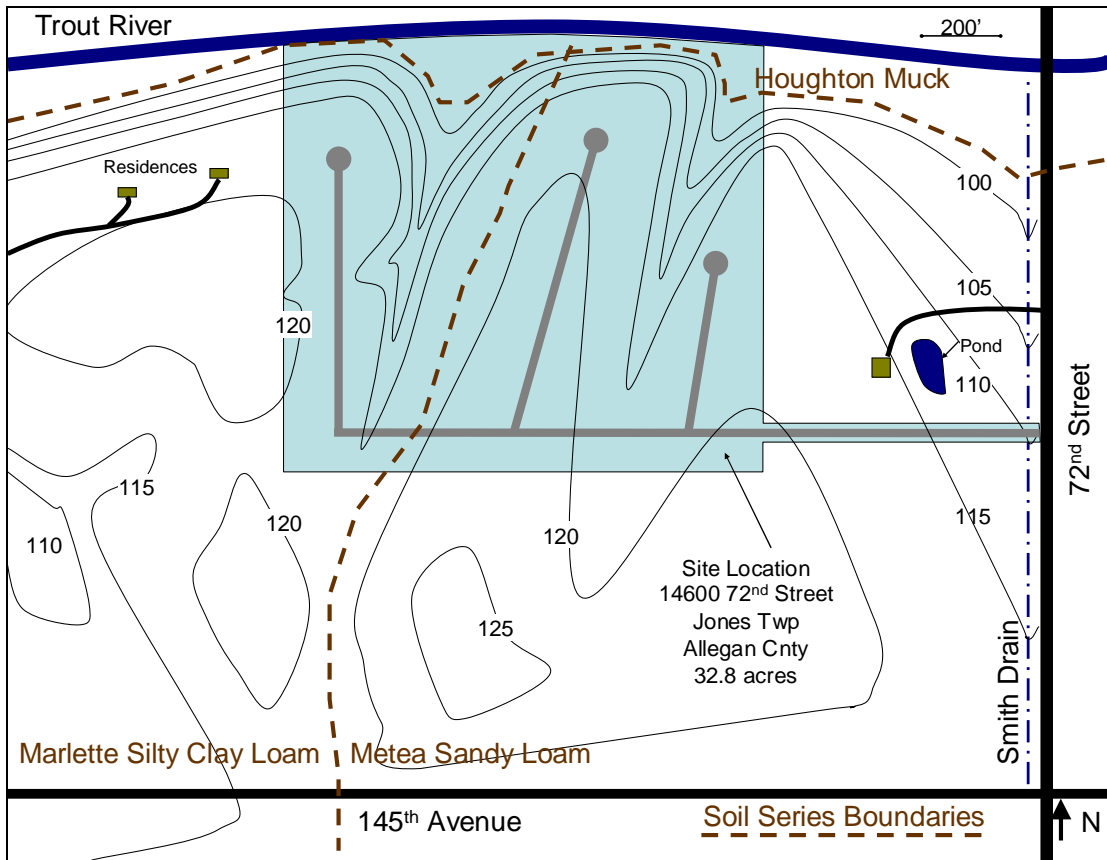

Figure 10-2: Site location sketch for proposed development

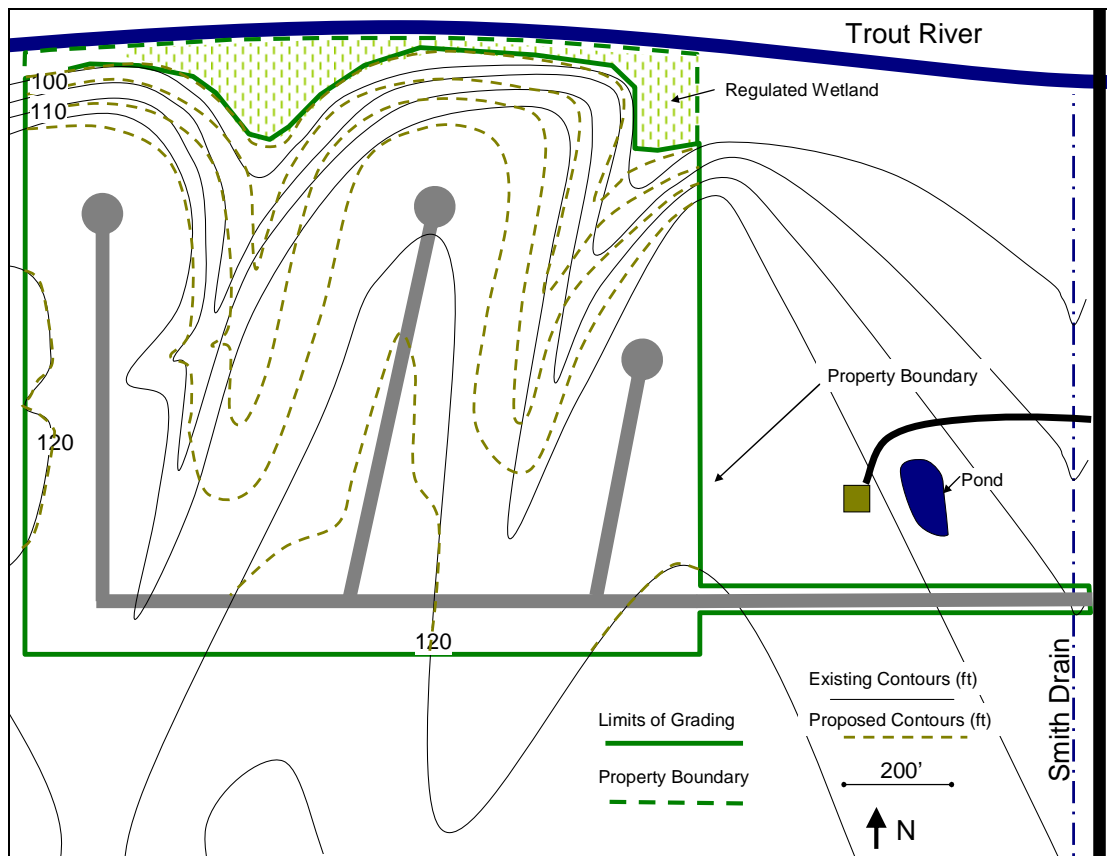

Figure 10-3: Rough grading map for proposed development

During Exercise 2, we have identified several essential pieces of information necessary to develop an effective SESC plan.

Soils Information (from NRCS soil survey):

- Houghton Muck is a poorly drained soil which reinforces the presence of regulated wetlands on the site. However, this soil is not within the area proposed to be graded.
- Marlette Silty Clay Loam is composed of at least 80% silt and clay sized particles making effective sediment control extremely difficult. The Hydrologic Soil Group is B, meaning a moderate to low runoff potential. This soil has relatively high erodibility potential. This soil will be disturbed extensively on the western portion of the site.
- Metea Sandy Loam will generally be composed of greater than 50-80% sand sized particles making sediment control devices generally effective. The Hydrologic Soil Group is B, meaning a moderate to low runoff potential. This soil has relatively low erodibility potential. This soil will be disturbed extensively on the eastern portion of the site.

Sensitive areas:

Regulated wetlands, the Trout River, and the Smith Drain are all down slope of the earth disturbance. In addition, there is a residence with a small pond near the project within the flow path of possible runoff from the site. All of these require special attention during SESC plan development.

Critical areas:

Several areas which have been identified will be difficult to stabilize once disturbed. This includes all concentrated flow areas on the site and steep slopes, with special consideration given to steeper slopes in the western portion of the site where high erodibility soils are located.

Runoff patterns:

After identifying likely sheet flow direction, concentrated flow areas, and watershed boundaries, we can select SESC measures which will effectively protect waters of the state and adjacent properties throughout the entire construction process. We are also aware that the site will receive runoff from outside properties coming from the south and west.

Other important information:

In addition to the information identified above, we also need other important pieces of information before beginning to select and place SESC measures on the site. Some of this information must be obtained from the project owner and/or designer. The questions below have hypothetical answers provided in bold, which will be the assumptions for the SESC planning exercises moving forward:

1. What is the current cover type of the project and in the contributing area? Agricultural? Forested? Grasslands? Parks? **After a site visit we have determined that the project site and surrounding area is currently forested.**

2. Are there any easements, zoning issues, or regulations affecting the site? **For the purposes of these exercises, we will assume that these issues do not exist, or have been addressed.**
3. We currently do not have enough information about what the project will look like at completion. Will the developer be building the structures (ie. condos) or will the property be subdivided and sold to individual builders and homeowners? **The developer intends to complete the road and infrastructure only and sell the lots off to individual homeowners or builders.**
4. We know nothing about the timetable for construction. Will the project be completed in phases? When will it start? When will it finish? **The developer wants to start the project in August 2011 and hopes to have the project completed by July 2012. He does not intend to stage the development. He would like to clear and grub the site in August and September; rough grade October through March (as weather allows), install roads and infrastructure in March/April/May; and final grade and stabilize in June.**
5. Is the proposed storm water system adequately designed to convey water and prevent erosion after construction? **For the purposes of these exercises, we will assume that the system is adequate.**
6. Cutting back slopes at the site will produce a significant amount of excess soil. How will this be handled? **For the purposes of these exercises, we will assume that the soil will be trucked to and utilized at a nearby project.**
7. Additional considerations. **The resident immediately east of the property is angry about the proposed development and has threatened to sue the developer if runoff from the construction site or development causes damage to his yard or trout pond.**

From the information we have gathered about the project we can also create a rough schedule of construction activities as the developer intends them to occur. An example of this appears in Figure 10-4.

Activity	2011					2012					
	Aug	Sep	Oct	Nov	Dec	Jan	Feb	Mar	Apr	May	Jun
Smith Drian Crossing	█										
Access Road	█										
Clear and Grub Veg.	█	█									
Scrape and Store Topsoil		█	█								
Rough Grade			█	█	█	█	█	█			
Install Stormwater System								█	█		
Road Construction									█	█	
Install Utilities										█	█
Smooth Grade/Topsoil											█
Seed/Stabilize											█

Figure 10-4: Example rough construction schedule for proposed project

Step Two – Identify Issues, Consider Solutions

Exercise 3: Utilizing your knowledge about the site, to create a list of SESC concerns which may occur during the construction activities listed in the schedule above. Identify some possible solutions. Pay close attention to the critical and sensitive areas on or near the site. For assistance, see a completed example list in Appendix 10C

Activity:

Concern:

Solutions:

Activity:

Concern:

Solutions:

Activity:

Concern:

Solutions:

Activity:

Concern:

Solutions:

Activity:

Concern:

Solutions:

Activity:

Concern:

Solutions:

Activity:

Concern:

Solutions:

Activity:

Concern:

Solutions:

Activity:

Concern:

Solutions:

Activity:

Concern:

Solutions:

Step Three – Select SESC Measures

During step two, we identified potential SESC issues as they applied to our specific site and construction processes. We also identified several possible solutions to these issues. When selecting which SESC measures to utilize to address a particular issue, it is important to remember that an effective SESC plan is a system of individual measures. Generally, there is more than one possible plan or system that can work for an individual site. Also, there are often trade-offs when selecting which measures to utilize. In our example site, mass grading the site starting in October may follow the owners preferred timetable and offer cost savings through an economy of scale. However, mass grading outside the growing season is likely to require much more expensive SESC measures than if the site is scheduled during the growing season and staged. Understanding these trade-offs is an important part of the SESC planning process.

Develop Scheduling and Staging

With regards to our proposed site, the two greatest concerns are the scale and timing of the mass grading at the site. Winter and early spring severe runoff events (concurrent rain and snow melt events with frozen ground) are very common in Michigan. Temporary SESC measures are generally ineffective during these events.

If possible, the plan developer and/or regulator should encourage or require the owner to delay land clearing and mass grading until the next season. At the very least, if the owner is insistent on mass grading the site outside the growing season, the plan should limit the amount of exposed soil that can be allowed at any one time and require extensive mulching. Both of which will add significant cost to the owner. We will proceed with our planned development under the assumption that the owner wishes to avoid some of these additional costs and is receptive to staging the

project, but does not want to delay work until March.

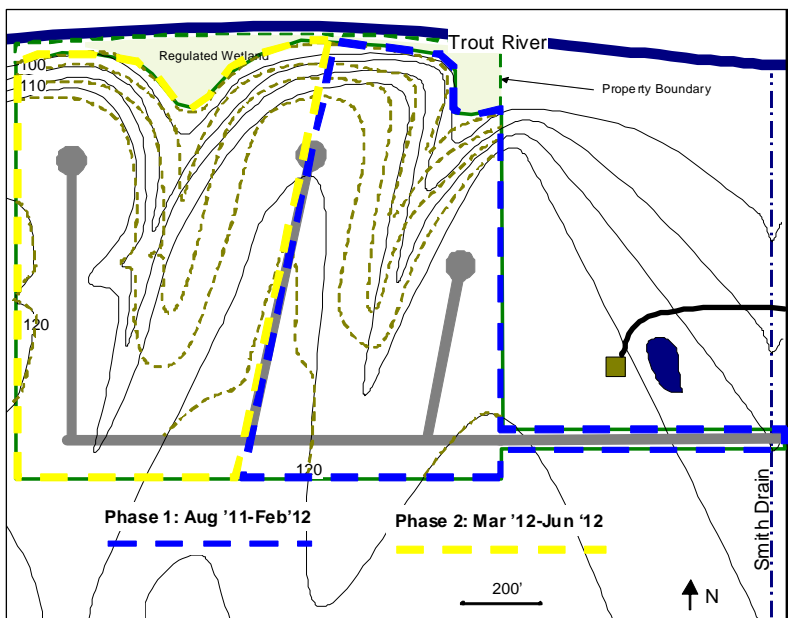

There are many possible options for staging the proposed project. The one presented in Figure 10-5 is one of those options. This proposal avoids disturbing the erodible soils on the western portion of the project and allows for completion and stabilization of eastern critical areas over winter. In addition, it can allow significant progress toward timely project completion.

Figure 10-5: Staging map for proposed project

Select and Place Temporary and Permanent Measures

Exercise 4: Using your knowledge about the site and SESC measures, select and place SESC measures for Phase I of the site on Figure 10-6. Then using the schedule on Figure 10-4 as a base, develop a construction schedule for Phase I including the installation of SESC measures. See Appendix 10D for a completed exercise and construction notes for this portion of the project.

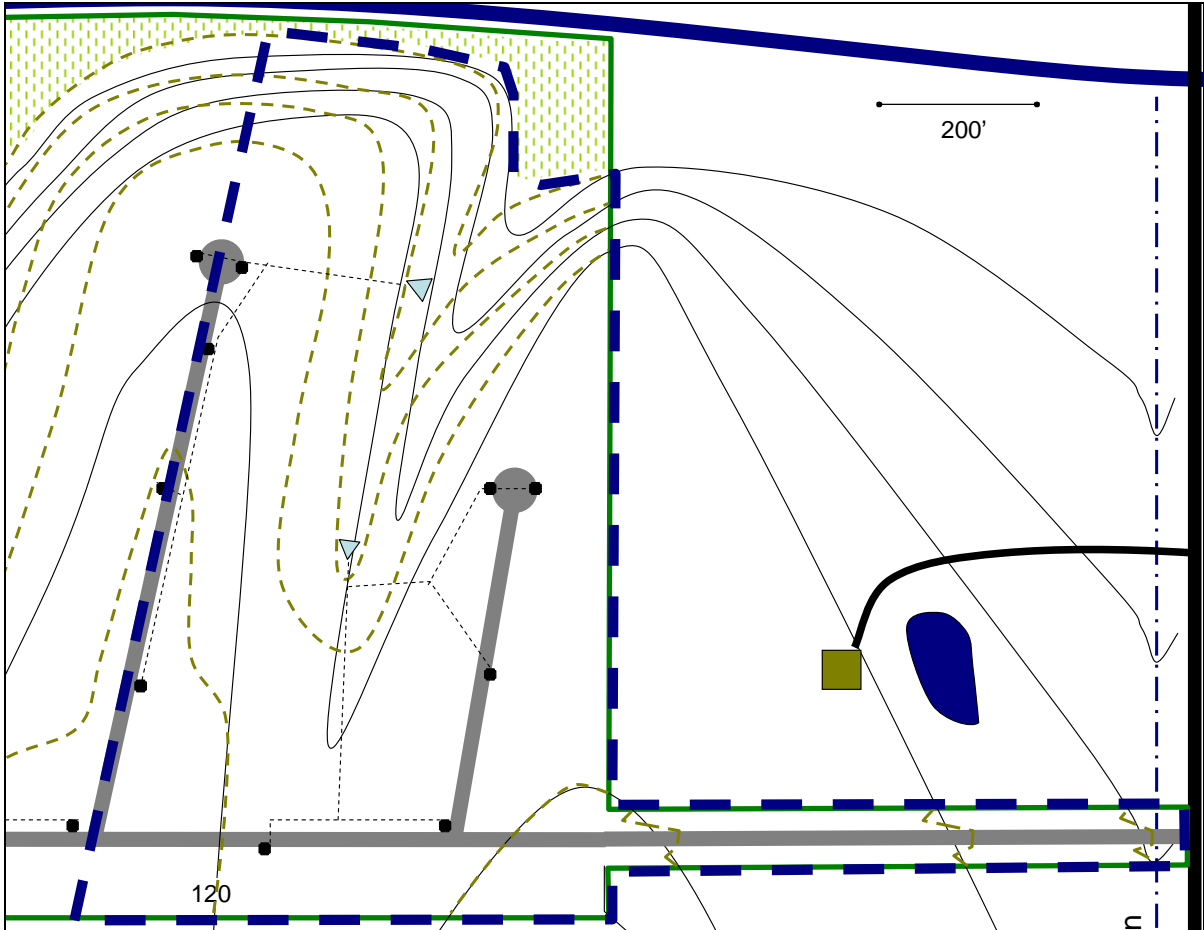

Figure 10-6: Phase 1 SESC Measure Placement Exercise

Schedule:

Step Four – Compile Information in a Completed SESC Plan

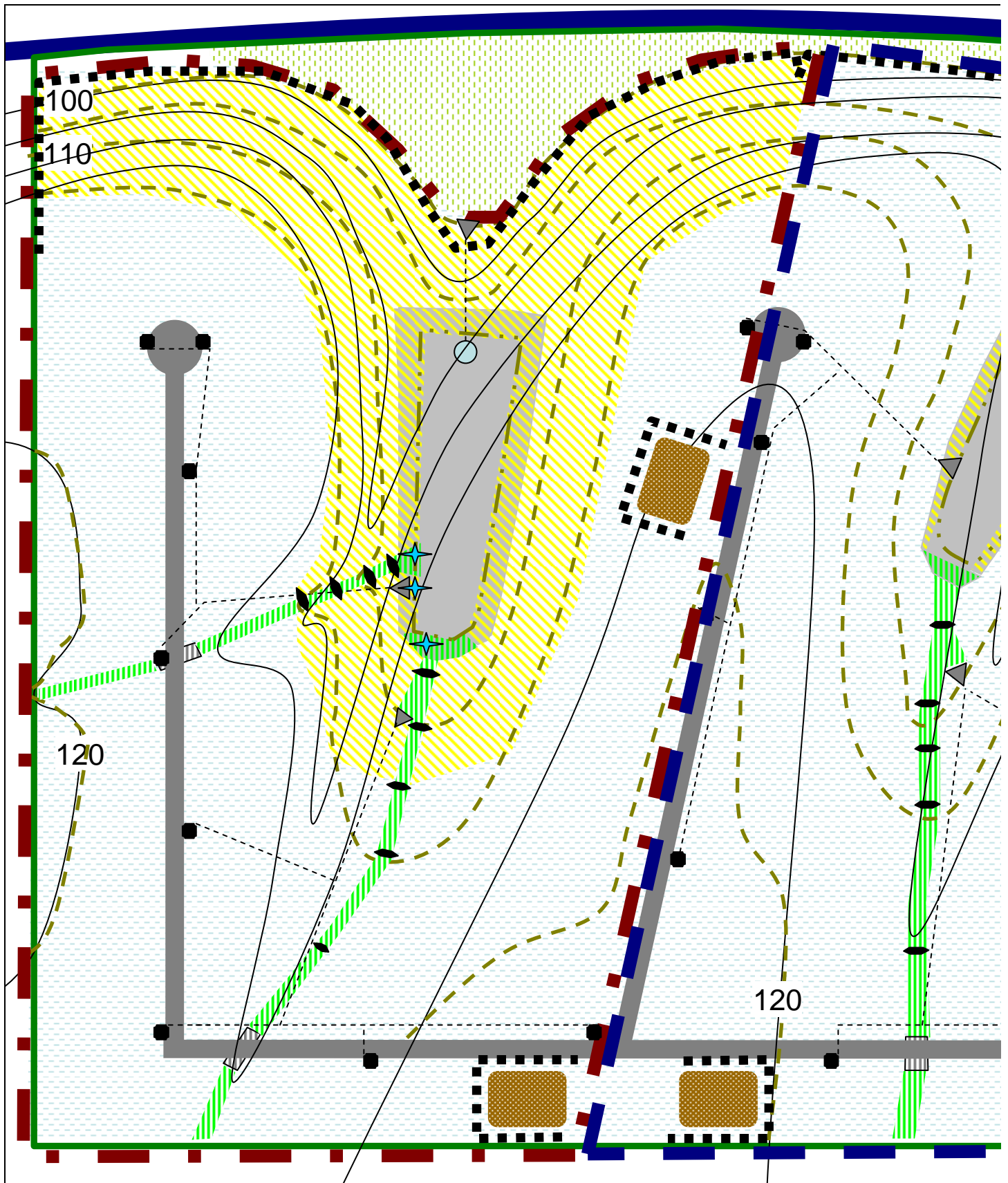
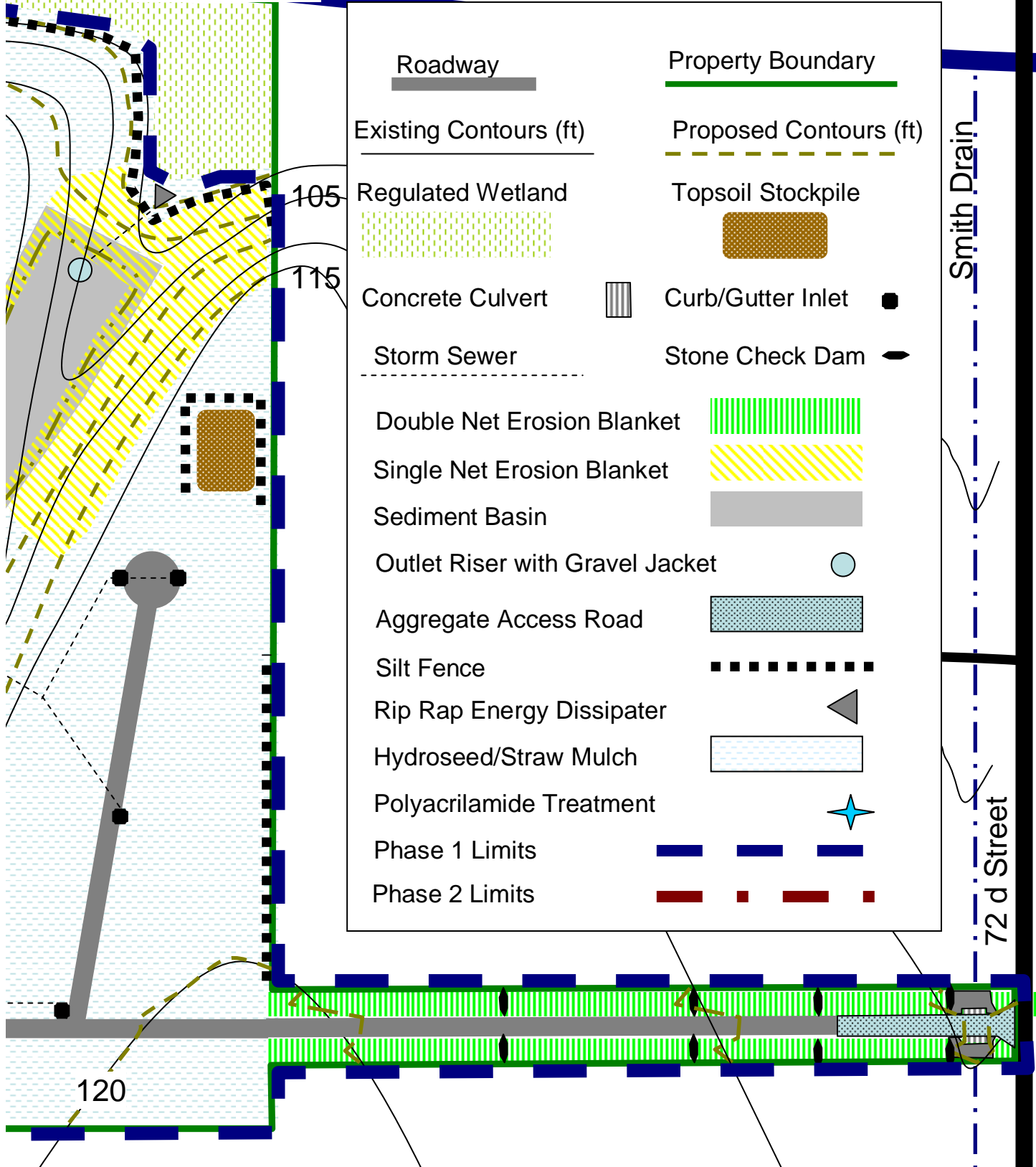

Figure 10-8 SESC Plan – SESC measures and Drainage Information 200'

Trout River



Roadway	Property Boundary
Existing Contours (ft)	Proposed Contours (ft)
Regulated Wetland	Topsoil Stockpile
Concrete Culvert	Curb/Gutter Inlet
Storm Sewer	Stone Check Dam
Double Net Erosion Blanket	
Single Net Erosion Blanket	
Sediment Basin	
Outlet Riser with Gravel Jacket	
Aggregate Access Road	
Silt Fence	
Rip Rap Energy Dissipater	
Hydroseed/Straw Mulch	
Polyacrilamide Treatment	
Phase 1 Limits	
Phase 2 Limits	

See attached construction notes, construction details, and construction schedule for more SESC information

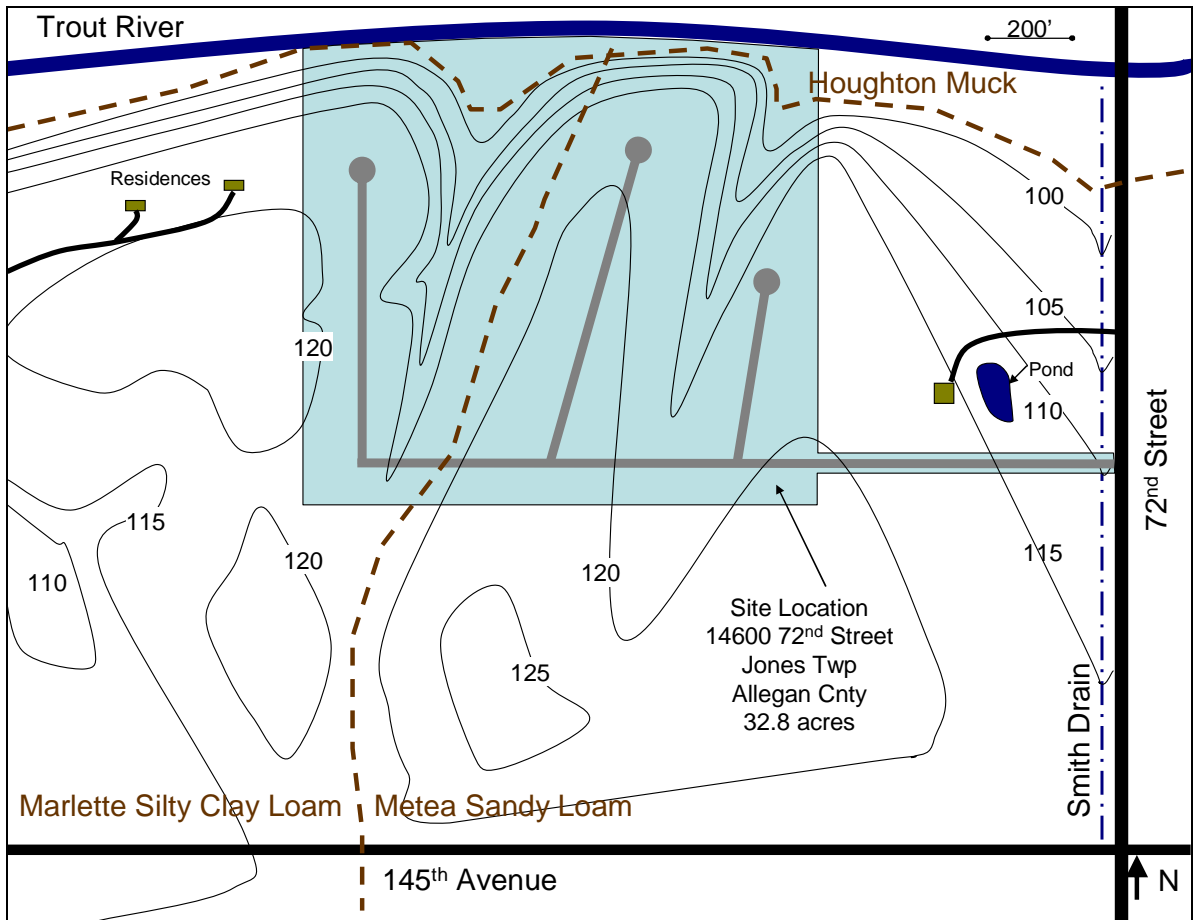

Figure 10-9: Site Location Sketch and Soils Information

Construction Schedule

Phase 1: Begin Construction Approximately August 1, 2011

Week 1: Install Smith Drain Crossing and Rip Rap Stabilization. Install Aggregate Access Road.

Week 2: Clear and grade site entrance road and roadside ditches working away from Smith Drain. Install Seed, Erosion Blankets, and Check Dams at the completion of each days work.

Weeks 3-5: Install Sediment Basin and Silt Fence. Clear and grub topsoil storage areas. Clear, grub, scrape topsoil, and grade only as necessary to facilitate installation and stabilization of these areas. Stabilize with topsoil, seed, erosion blankets and/or mulch as specified after installation.

Weeks 5-7: Clear, grub, scrape topsoil, and rough grade swales, slopes along the wetland boundary, and concentrated flow areas.

Weeks 6-8: Finish grade, replace topsoil, hydroseed, and install erosion blankets, and/or check dams on swales, slopes along wetland boundary, and concentrated flow areas. Complete installation within 5 days after area has reached final grade.

Weeks 8-10: Clear, grub, scrape topsoil, and rough grade in remaining areas in Phase 1 (upland areas near future roads).

Weeks 10-12: Finish grade, replace topsoil, and hydroseed any remaining exposed areas in Phase 1. Complete hydroseeding within 5 days after area has reached final grade. Any areas which cannot be hydroseeded by October 16 must thereafter be hydroseeded and additionally mulched at a rate of 2 tons of straw per acre.

Weeks 13+: Install road base, road surface, curb and gutter, storm water system, and utilities as weather allows. Stabilize disturbed areas with seed and 2 tons of straw per acre within 5 days of completion of each area.

Phase 2: Begin Construction Approximately March 15, 2011

Weeks 1-3: Install Sediment Basin and Silt Fence. Clear and grub topsoil storage areas. Clear, grub, scrape topsoil, and grade only as necessary to facilitate installation and stabilization of these areas. Stabilize with topsoil, seed, erosion blankets, and/or mulch as specified after installation.

Weeks 4-7: Clear, grub, scrape topsoil, and rough grade swales, slopes along the wetland boundary, and concentrated flow areas. Install polyacrylamide treatment systems at swale outlets upon earth change.

Weeks 5-8: Finish grade, replace topsoil, and install erosion blankets, and/or check dams on swales, slopes along wetland boundary, and concentrated flow areas. Complete installation within 5 days after area has reached final grade.

Weeks 9-11: Clear, grub, scrape topsoil, and rough grade in remaining areas in Phase 2 (upland areas near future roads).

Weeks 10-12: Finish grade, replace topsoil, and hydroseed any remaining exposed areas in Phase 1. Complete hydroseeding within 5 days after area has reached final grade.

Weeks 12+: Install road base, road surface, curb and gutter, storm water system, and utilities as weather allows. Install polyacrylamide treatment system, at storm water system outlets into sediment basin immediately upon completion. Stabilize disturbed areas with hydroseed and 2 tons of straw per acre within 5 days of completion of each area.

Construction Notes

General – All structures and SESC measures shall be installed and managed in accordance with manufacturer recommendations and the plan details provided. If neither is provided, the default standards from the 2003 Michigan Department of Transportation Standard Specifications for Construction shall be followed.

Limits of Earth Change – No areas outside those in Phase 1 and Phase 2 shall be cleared, grubbed, or graded at any time during the project. Phase 2 construction shall not begin until Phase 1 is fully completed.

Proposal for ongoing maintenance of permanent SESC measures – Permanent SESC measures will be monitored by the property owner until which time the property or portion of the property is sold. Failures will be corrected immediately.

Aggregate Access Road – Aggregate materials shall be added or replaced as poor space becomes filled with sediment. The aggregate may be removed or paved over when the project is complete.

Concentrated Flow Areas and Ditches – Avoid construction during rain events or when rain/snowmelt is forecasted. Scouring and bank failure shall be corrected immediately.

Sediment Basin – Shall be constructed and stabilized as early during the construction process as possible; and before any other grading on the project. The basin must be restored to full design depth once sediment accumulation exceeds 50% of the design wet depth. The sediment basin may be modified into a permanent storm water basin once all areas within the drainage area are stabilized with permanent vegetation.

Silt Fence – Shall be installed prior to any grading at the project. Silt fence installation shall not cross any concentrated flow areas. Silt fence must be maintained and/or replaced at failure or when sediment reaches 50% of the height of the fence. All silt fence shall be removed once the drainage area is stabilized with permanent vegetation.

Check Dams – Shall be installed at the frequency and location identified in the plans. Accumulated sediment behind check dams shall be removed when it reaches 50% of the height at the center of the check dam. Check dams may be removed once channelized flows are stabilized with permanent vegetation.

Erosion Blanket – Shall be placed on slopes and channels as located on the plans. Topsoil should be graded as smoothly as possible prior to placement. Installation shall be consistent with specifications provided and manufacturer's recommendations. Erosion blanket failure shall be repaired immediately.

Curb and Gutter Inlets – Curb and gutter inlets shall be protected with premanufactured inlet protection devices at all times. Inlet protection devices may be removed once all runoff contributing areas are stabilized with permanent SESC measures. All inlet protection devices shall be removed once the drainage area is permanently stabilized.

Seed/Hydroseed/Straw Mulch – All areas noted to be seeded utilizing a hydroseed mixture of 2000 lbs per acre hardwood fiber mulch with tackifier. Hydroseeding after October 16 and before April 1 shall be additionally stabilized by evenly spreading 2 tons of straw per acre that is properly anchored. All seed mixes shall be 90% or greater pure live seed. Any areas which fail to establish dense permanent stands of vegetation must be reseeded. The following seed mixes shall be used during the noted time periods:

Apr 1 – Sep 30 (200 lbs/acre)

50% Perennial Ryegrass, 30% Creeping Red Fescue, 20% Kentucky Bluegrass

Oct 1 – Freeze/Snow & Thaw – March 31 (220 lbs/acre)

50% Perennial Rye, 30% Creeping Fescue, 15% Kentucky Bluegrass, 5% Winter Wheat (Fall), Spring Wheat (Spring), or Annual Ryegrass

Seeding outside the growing season may require follow up mowing of established annual grasses to limit competition with perennial grasses.

Polyacrylamide (PAM) Treatment – Shall be accomplished with partially hydrated gel blocks of a specific PAM chemical makeup which has been tested and proven effective at flocculating on-site soils. The number and placement of PAM treatment blocks shall be determined by the engineer based on manufacturer recommendations.

Dust Control – If dry weather conditions persist such that dust is transported outside property boundaries or into the on-site wetland area to the north, any exposed soils on the site shall be wetted via water truck or irrigation equipment. Water application shall be up to, but not beyond the point that applied water begins to runoff. Water applications shall be repeated as necessary.

Construction Details

Construction details and drawings showing proper installation should be included in the SESC plan for each of the SESC measures utilized at the site. These should include material specifications and plan, profile, and cross-section drawings as applicable. See Appendix I for examples of construction details. The actual construction details provided must identify specific materials and measurables as necessary to properly construct SESC measures.

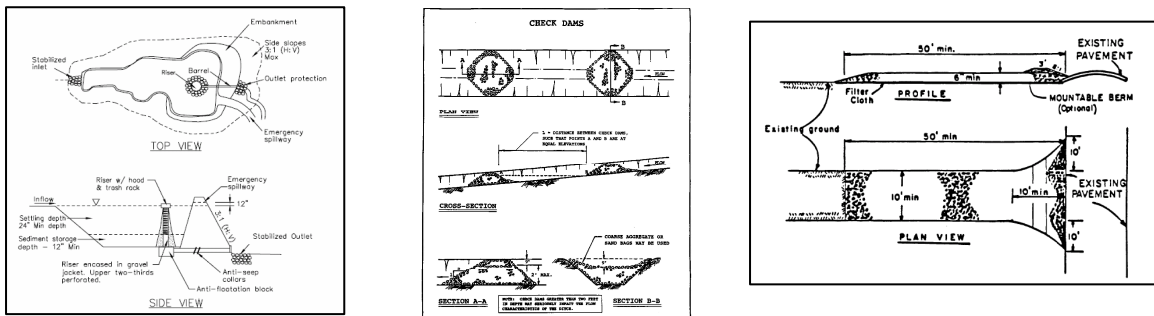

Summary

The preceding information and exercises were intended to give the reader an introductory experience with reviewing and developing SESC plans. Although there are often many ways to solve SESC issues at construction sites, it is important to recognize the capabilities and limitations of each type of SESC measure. In addition, good SESC planning requires significant knowledge about the site, the construction process, seasonal limitations, and the objectives of the owner(s).

The plan developed in this unit meets all the minimum requirements of Rule 1703. In addition, it properly utilizes specific SESC measures as part of a system. If the plan is properly implemented, inspected, and modified as necessary in the future, the example project is likely to maintain compliance with the requirements of Part 91.

Appendix 10A
Completed Example of Exercise 1

1703 Required Plan Components:

- Map (plan) with a scaled drawing of not more than 200 feet to the inch**
It appears that the plan does indeed meet this criterion. However, it appears that the site continues to the east where the apparent access road enters the site. If the earth change will continue into this area, the plan submitted would not meet this criterion. If the earth change is to extend into the access road, it would affect whether or not most of the other following criteria are met.
- A site location sketch**
No specific site location can be ascertained from the plan provided.
- The proximity of the proposed earth change to lakes and streams**
This criterion is not met because there is no clear delineation of where the earth changes will be occurring at the site.
- Predominant land features**
While this information should be confirmed with an on-site inspection, the hills slopes, swales, river, and wetlands at the site are identified.
- Existing and proposed contour intervals or slope description**
- A soils survey or written description of the soils of the anticipated exposed land area**
No soils information is provided.
- A description and the location of the physical limits of each proposed earth change**
While most of the site boundaries appear to be provided, the plan does not specifically identify the limits of the earth change. Therefore, the location and effectiveness of measures cannot be identified.
- A description and the location of all existing and proposed on-site drainage and dewatering facilities**
The plan does include storm water drainage infrastructure locations and topographic information necessary to identify surface drainage.
- The timing and sequence of each proposed earth change**
No timing and sequencing information provided. With the scale and risk associated with this project, when and how the project is undertaken could significantly change the SESC measures necessary.
- The location and description for installing and removing all proposed temporary SESC measures**
The location of on-site silt fence is provided, but description information is missing. Also, additional temporary controls may be required.
- A description and the location of all proposed permanent SESC measures**
The road bases and rip rap outlets identified are permanent erosion control measures. However, no information is provided as to what will be used (i.e. vegetation) to stabilize the other areas of the project.
- A program proposal for the continued maintenance of all permanent SESC measures, including the person responsible for the maintenance**
While meeting this component generally does not require extensive details, no information is provided.

General Comments:

1. As mentioned above, it appears that the access road portion of this project is not covered in this plan.
2. Given the slopes, concentrated flow areas, and extensive grading at this project, silt fence is likely not adequate as the only temporary SESC measure.
3. The silt fence location appears to cross two major concentrated flow areas. Silt fence is not an appropriate measure for concentrated flows.
4. Portions of the silt fence appear to be installed in regulated wetland areas. Sediment retained behind the silt fence would therefore be filling in a regulated wetland and violating Part 91.
5. The plan appears to have significantly more cut areas than fill areas. It can be expected that excess soil will have to be removed from the site, requiring significant traffic off the site. This increases the likelihood of off-site tracking with no noted control measures in place.

The example SESC plan provided above is significantly deficient in terms of required components and technical adequacy. A Part 91 agency should not approve this plan, but rather return it to the designer for significant modification.

Appendix 10B Completed Example of Exercises 2A and 2B

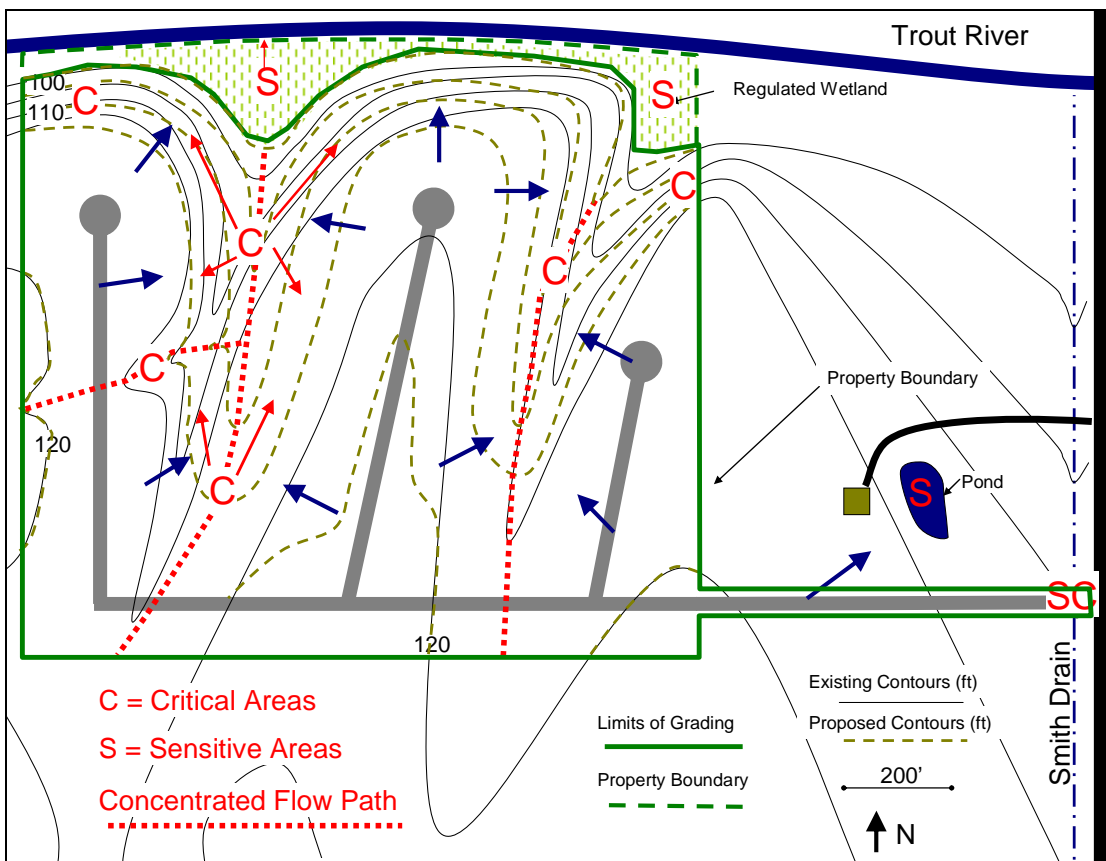
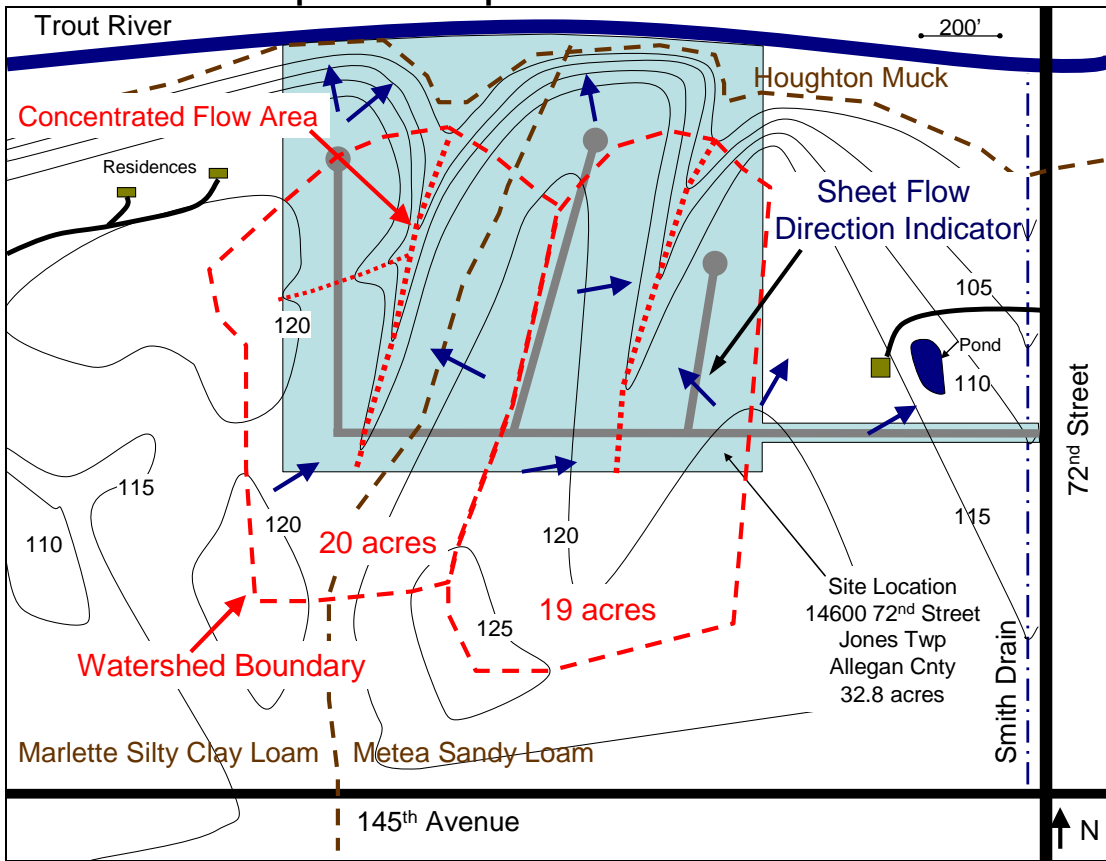

Appendix 10C Completed Example from Exercise 3

Activity: All Stages

Concern: Vehicle track-out onto 72nd Street

Solutions: Aggregate Access Road, Limit vehicle traffic

Activity: Clear and Grub through Vegetative Stabilization

Concern: Sediment control of fine particles on western portion of site

Solutions: Prioritize erosion control and stabilization, Polymer sediment controls

Activity: Clear and Grub through Vegetative Stabilization

Concern: Erosion and or sediment control in the two major swales on-site

Solutions: Prioritize stabilization, sediment basins, check dams, erosion blankets

Activity: Smith Drain Crossing

Concern: Work in and adjacent to a stream

measures, prioritize stabilization of critical areas

Activity: Scrape and Store Topsoil

Concern: Topsoil stockpile erosion and loss

Solutions: Setback from sensitive areas and concentrated flow areas, avoid areas receiving runoff, stabilize with vegetation, contain with perimeter controls

Activity: Scrape and Store Topsoil through Rough Grade

Concern: Exposed soils in winter/spring

Solutions: Scheduling/staging, stabilize with vegetation in growing season, cover crop, mulching, erosion blankets

Activity: Rough Grade

Concern: Redirecting concentrated flow areas

Solutions: Stabilize quickly, utilize turbidity curtains or coffer dams during construction, detailed design criteria

Activity: Access Road Construction

Concern: Runoff toward residence and pond

Solutions: Diversion/Ditch, vegetative buffer, perimeter controls (silt fence)

Activity: Clear and Grub Veg.

Concern: Large areas of exposed soil/Destabilizing critical areas

Solutions: Scheduling/staging, utilize wood chips and woody debris from clearing, limit scope of clearing, install temporary SESC measures.

Activity: Scrape and Store Topsoil

Concern: Large areas of exposed soil/Destabilizing critical areas

Solutions: Scheduling/staging, limit scope of clearing, temporary SESC

Solutions: Scheduling, prioritize completion and stabilization, check dams, erosion control blankets

Activity: Install Storm Water System

Concern: Control sediment inputs into storm water system and discharge into sensitive areas

Solutions: Prioritize stabilization, inlet protection, direct to treatment

Activity: Finish Grade/Topsoil

Concern: Slippage or washout of topsoil

Solutions: Subsoil/topsoil interface roughness, erosion control measures in critical areas

Activity: Seed/Stabilize

Concern: Establishment/Failure

Solutions: Seed selection, mulch, soil amendment, irrigation due to season,

**Appendix 10D
Completed Example from Exercise 4**

SESC Plan for Phase 1

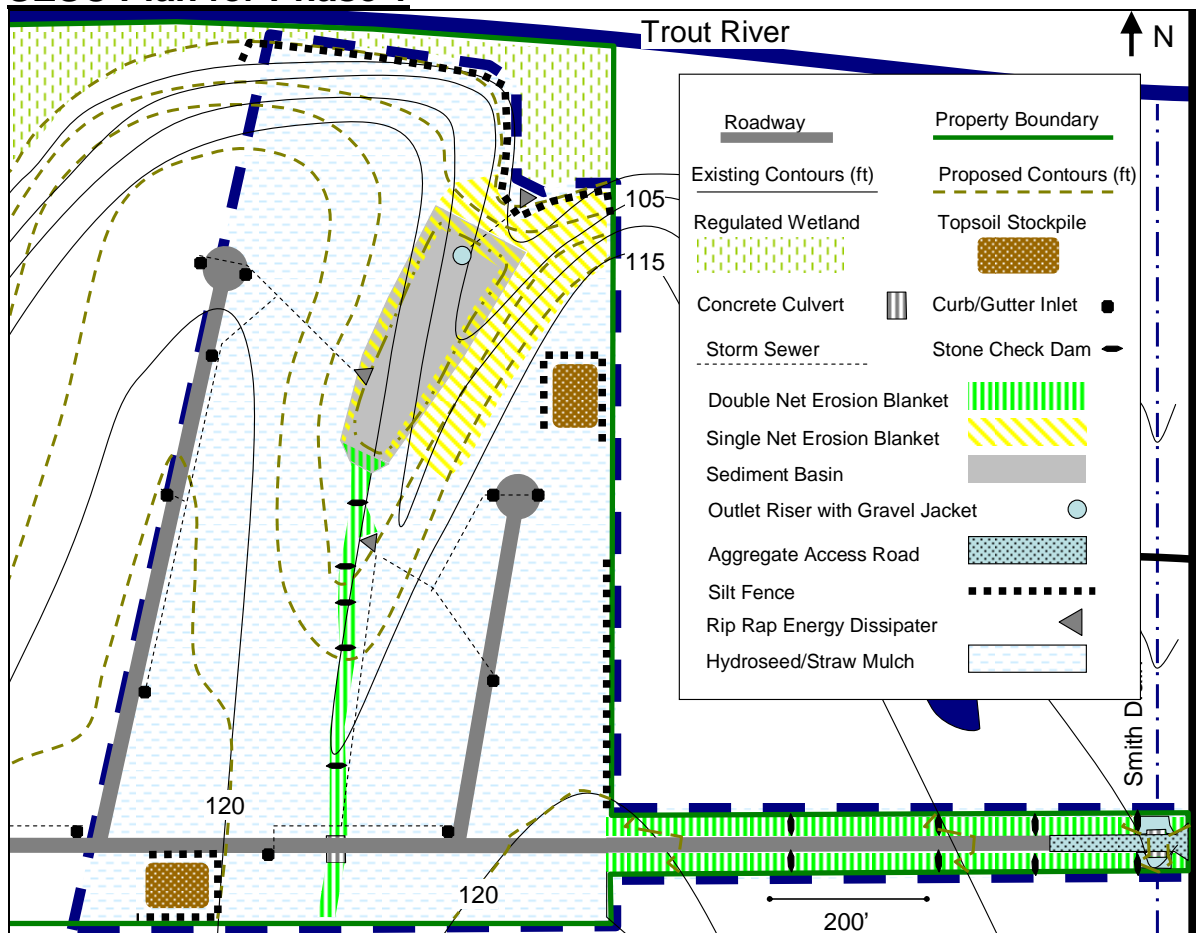

Phase 1 Example Construction Schedule

Begin Construction Approximately August 1, 2011

Week 1: Install Smith Drain Crossing Culvert, Rip Rap Stabilization, and Aggregate Access Road

Week 2: Clear and grade site entrance road and roadside ditches working away from Smith Drain. Install Seed, Erosion Blankets, and Check Dams at the completion of each days work.

Weeks 3-5: Install Sediment Basin and Silt Fence. Clear and grub topsoil storage areas. Clear, grub, scrape topsoil, and grade only as necessary facilitate installation and stabilization of these areas. Stabilize with seed and mulch as specified after installation.

Weeks 5-7: Clear, grub, scrape topsoil, and rough grade swales, slopes along the wetland boundary, and concentrated flow areas.

Weeks 6-8: Finish grade, replace topsoil, hydroseed, and install erosion blankets, and/or check dams on swales, slopes along wetland boundary, and concentrated flow areas. Complete installation within 5 days after area has reached final grade.

Weeks 8-10: Clear, grub, scrape topsoil, and rough grade in remaining areas in Phase 1 (upland areas near future roads).

Weeks 10-12: Finish grade, replace topsoil, and hydroseed any remaining exposed areas in Phase 1. Complete hydroseeding within 5 days after area has reached final grade. Any areas which cannot be hydroseeded by October 16 must thereafter be hydroseeded and additionally mulched at a rate of 2 tons of straw per acre.

Weeks 13+: Install road base, road surface, curb and gutter, storm water system, and utilities as weather allows. Stabilize disturbed areas with hydroseed and 2 tons of straw per acre within 5 days of completion of each area.

Construction Notes (*Decision making commentary in italics*):

General – All structures and SESC measures shall be installed and managed in accordance with manufacturer recommendations and the plan details provided. If neither is provided, the default standards from the 2003 Michigan Department of Transportation Standard Specifications for Construction shall be followed.

Limits of Earth Change – No areas outside those in Phase 1 and Phase 2 shall be cleared, grubbed, or graded at any time during the project. Phase 2 construction shall not begin until Phase 1 is fully completed.

Proposal for ongoing maintenance of permanent SESC measures – Permanent SESC measures will be monitored by the property owner until which time the property or portion of the property is sold. Failures will be corrected immediately.

Fulfills a Rule 1703 Plan Requirement

Concrete Culverts – Shall be installed in accordance with details and specifications provided

There are many types of culverts and channel crossing options available. As a general rule, culverts that span the entire high flow channel and allow for natural substrate are preferable environmentally. The height of installation of closed culverts is critical. They should never be placed too high (causing a spill pool and blocking fish passage) or too low (restricting high flow events).

Aggregate Access Road – Aggregate materials shall be added or replaced as poor space becomes filled with sediment. The aggregate may be removed or paved over when the project is complete.

Given the amount of expected construction traffic an aggregate access road is absolutely necessary for this project. One special concern is the Smith Drain near the site egress. Therefore, the length of the aggregate access road was increased

beyond the minimum 50' length to promote sediment removal at a greater distance from the drain.

Concentrated Flow Areas and Ditches – Avoid construction during rain events or when rain/snowmelt is forecasted. Scouring and bank failure shall be corrected immediately.

The site information included in this chapter addressed concerns related to the neighbor's house and the pond to the east of the project. Runoff from the entrance road would have travelled toward this neighbor's property. Therefore, diversions with check dams for sediment removal were provided in order to divert runoff into the Smith Drain. Check dams provide only limited sediment removal; therefore, stabilizing this area rapidly was given a high priority in scheduling.

Sediment Basin – Shall be constructed and stabilized as early during the construction process as possible; and before any other grading on the project. The basin must be restored to full design depth once sediment accumulation exceeds 50% of the design wet depth. The sediment basin may be modified into a permanent storm water basin once all areas within the drainage area are stabilized with permanent vegetation.

The on-site swales provide excellent locations for sediment basins which can treat most of the runoff from the site. Adding a sediment basin required changes to the proposed grade and relocation of the storm sewer outlets to increase flow path prior to discharge. The sandy loam soils in this area should allow for effective sediment removal by the basin. Given the design criteria for sediment basins provided in Chapter 9, the recommended basin size for the drainage area is 92'X370'x2'. This was amended slightly to fit site constraints. Please note that this drainage area includes several acres to the south of the site. The basin size could be reduced if diversion of the off-site runoff is possible.

Silt Fence – Shall be installed prior to any grading at the project. Silt fence installation shall not cross any concentrated flow areas. Silt fence must be maintained and/or replaced at failure or when sediment reaches 50% of the height of the fence. All silt fence shall be removed once the drainage area is stabilized with permanent vegetation.

The silt fence at the site is installed parallel to contour lines and curved upslope at the terminal ends to prevent runoff circumventing the fence. The drainage area contributing runoff to the silt fence does not exceed ½ acre per 100' of fence. Also, note that the silt fence is installed upslope from the sediment basin. The silt fence likely would fail in this concentrated flow area. The basin provides treatment of this water. The silt fence installed along the eastern property line of the project was included to provide treatment for runoff from the small area of disturbance which flows northeasterly along that area.

Topsoil Stockpiles

Stockpiles were placed in upland areas, with minimal runoff contributing areas upslope. Maximum feasible distance from sensitive areas should be maintained. Given the short duration of stockpiling, one pile was allowed in the northeast quadrant somewhat close to the slope and wetland, hopefully minimizing hauling distance and facilitating stabilization of nearby critical areas.

Check Dams – Shall be installed at the frequency and location identified in the plans. Accumulated sediment behind check dams shall be removed when it reaches 50% of the height at the center of the check dam. Check dams may be removed once channelized flows are stabilized with permanent vegetation. *The spacing provided on the plan assumes a 2.5' height in the center of the dam. Therefore, there are 2 check dams for every 5' contour line.*

Erosion Blanket – Shall be placed on slopes and channels as located on the plans. Topsoil should be graded as smoothly as possible prior to placement. Installation shall be consistent with specifications provided and manufacturers recommendations. Erosion blanket failure shall be repaired immediately.

Erosion blankets specifications are highly dependent on slope length, slope steepness, and velocity and depth of runoff water. Specific blankets and installation guidelines should be specified.

Curb and Gutter Inlets – Curb and gutter inlets shall be protected with premanufactured inlet protection devices at all times. Inlet protection devices may be removed once all runoff contributing areas are stabilized with permanent SESC measures. All inlet protection devices shall be removed once the drainage area is permanently stabilized.

All curb and gutter inlets flow into the sediment basin. Therefore, installation of inlet protection will probably provide little additional protection of sensitive areas. However, it will help to ensure proper function of the storm water system.

Seed/Hydroseed/Straw Mulch – All areas noted to be seeded utilizing a hydroseed mixture of 2000 lbs per acre hardwood fiber mulch with tackifier. Hydroseeding after October 16 and before April 1 shall be additionally stabilized by evenly spreading 2 tons of straw per acre that is properly anchored. All seed mixes shall be 90% or greater pure live seed. Any areas which fail to establish dense permanent stands of vegetation must be reseeded. The following seed mixes shall be used during the noted time periods:

Apr 1 – Sep 30 (200 lbs/acre)

50% Perennial Ryegrass, 30% Creeping Red Fescue, 20% Kentucky Bluegrass

Oct 1 – Freeze/Snow & Thaw – March 31 (220 lbs/acre)

50% Perennial Rye, 30% Creeping Fescue, 15% Kentucky Bluegrass, 5% Winter Wheat (Fall), Spring Wheat (Spring), or Annual Ryegrass

Seeding outside the growing season may require follow up mowing of established annual grasses to limit competition with perennial grasses.

An alternative seed mix and additional mulching is required for seeding that occurs outside the recommended seeding dates in spring and fall. In this case, an annual companion crop is added. A companion crop provides rapid germination and establishment, preventing erosion and protecting the seed bed. Also, the species selected will continue to grow well outside the normal growing season for many other types of grasses.

Dust Control – If dry weather conditions persist such that dust is transported outside property boundaries or into the on-site wetland area to the north, any exposed soils on the site shall be wetted via water truck or irrigation equipment. Water application shall be up to, but not beyond the point that applied water begins to runoff. Water applications shall be repeated as necessary.

Construction Details

For this example project, SESC construction/installation details and material specifications are necessary for each of the following: Sediment basin, riser outlet, check dams, energy dissipaters, silt fence, culvert installations, concentrated flow channels, aggregate access road, and catch basin installation. Details and specifications are not provided in this example. Please see the specification sheets in Chapter 9 for more information and example details

**Appendix 10E
Completed Example from Exercise 5**

Example SESC Plan for Phase 2 (Exercise 5)

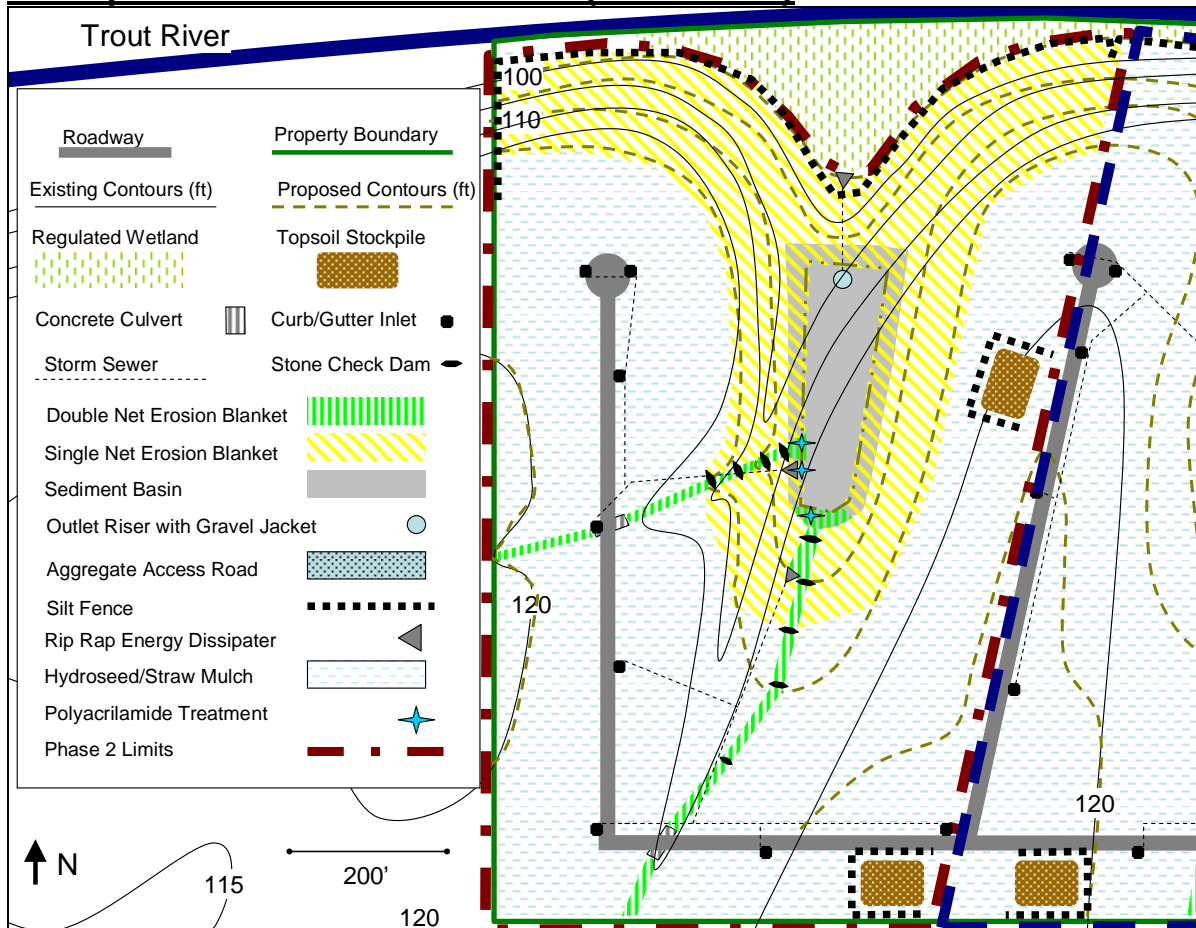

Phase 2 Example Construction Schedule

Start Phase 2 approx. March 15, 2012 as weather allows

Weeks 1-3: Install Sediment Basin and Silt Fence. Clear and grub topsoil storage areas. Clear, grub, scrape topsoil, and grade only as necessary facilitate installation and stabilization of these areas. Stabilize with seed and mulch as specified after installation.

Weeks 4-7: Clear, grub, scrape topsoil, and rough grade swales, slopes along the wetland boundary, and concentrated flow areas. Install polyacrilamide treatment systems at swale outlets upon earth change.

Weeks 5-8: Finish grade, replace topsoil, and install erosion blankets, and/or check dams on swales, slopes along wetland boundary, and concentrated flow areas. Complete installation within 5 days after area has reached final grade.

Weeks 9-11: Clear, grub, scrape topsoil, and rough grade in remaining areas in Phase 2 (upland areas near future roads).

Weeks 10-12: Finish grade, replace topsoil, and hydroseed any remaining exposed areas in Phase 1. Complete hydroseeding within 5 days after area has reached final grade.

Weeks 12+: Install road base, road surface, curb and gutter, storm water system, and utilities as weather allows. Install polyacrylamide treatment system, at storm water system outlets, into sediment basin immediately upon completion. Stabilize disturbed areas with seed and 2 tons of straw per acre within 5 days of completion of each area.

Construction Notes (*Decision making commentary in italics*)

Include all notes from Phase 1

Erosion Blankets

Phase 2 of the site has significantly more erodible soils than those found in Phase 1. Therefore, more critical areas exist. In addition, the fine textured soils will reduce the effectiveness of sediment control measures, making erosion control more important.

Polyacrylamide (PAM) Treatment – Shall be accomplished with partially hydrated gel “logs” of a specific PAM chemical makeup which has been tested and proven effective at flocculating on-site soils. The number and placement of PAM treatment logs shall be determined by the engineer based on manufacturer recommendations.

PAMs were utilized on this portion of the site because the soil type (Silty Clay Loam) is erodible and comprised of fine particles. Therefore, the sediment basin is likely to be ineffective without the addition of PAMs. In general, PAMs are very soil specific; therefore, the on-site soils must be tested to assure proper function of the system. Also, the sediment basin receives runoff from both concentrated flows and sheet flow. Therefore, specific hydrologic information is required to determine the number and location of PAM logs.

Construction Details

Include all details from Phase 1.

Specifications and drawings should be provided for the PAM treatment system and Phase 2 sediment basin.

Appendix I: SESC Best Management Practices Guidance Sheets

Introduction

Best Management Practices (BMP):

BMPs are any structural, vegetative or managerial practice used to treat, prevent or reduce water pollution.

The following BMPs include guidance which will provide the user with information to help design and implement the BMP. This is an important concept, in that: 1) no BMP can be used at every site; and 2) no BMP can include so many specifications that all possible uses and all possible conditions are included. Each site must be evaluated, and specific BMPs can be selected which will perform under the site conditions.

The SESC BMPs found in this manual were developed for use in Michigan. BMPs developed for other states may not necessarily work in Michigan. For example, vegetative BMPs should emphasize the use of grasses which have adapted to Michigan. Vegetation which has adapted to Michigan is not necessarily going to adapt to other states. We acknowledge that this set of BMPs is not all-inclusive. There are many additional BMPs that can be found in the Michigan Department of Environmental Quality (DEQ) [Guidebook of Best Management Practices for Michigan Watersheds](#), hereafter referred to as the BMP Guidebook. Additionally, specifications for individual SESC products can be found at SESC retailers and on supplier websites. Several of the BMPs listed here include companion and alternative BMPs which are not included in the training manual, but are included in the BMP Guidebook. In these cases, the page number where the BMP can be found in the BMP Guidebook is provided.

We encourage creativity and innovation, but provide potential users with this list of SESC BMPs because they have been proven to work when designed, installed and maintained correctly, and are some of the most commonly used SESC BMPs in Michigan.

Remember, it is important to follow all specifications when designing and installing BMPs. It is also pertinent that the BMP be maintained. Maintenance is most often the shortcoming of BMP performance.

SESC BMP Contents

Silt Fence I-3
Turbidity Curtain I-7
Storm Sewer Inlet Protection..... I-12
Access Road..... I-18
Check Dam I-24
Riprap–Stabilized Outlet I-30
Rolled Erosion Control Products I-41
Diversion I-49
Sediment Basin I-54
Mulching I-65
Hydroseeding I-69
Dust Control I-73
Polyacrylamide (PAM)..... I-78

Silt Fence Definition

Silt fence is a perimeter sediment control device. Generally, silt fence is constructed of porous woven geotextile fabric attached to wooden posts.

Description and Purpose

Silt fence is a linear fence installed at the edge of earth disturbances. The purpose of silt fence is to protect downslope surface waters and properties by removing suspended solids from runoff prior to leaving the site.

The practice may also be called filter fence.

Pollutant(s) controlled:

- Suspended solids

Treatment Mechanisms:

- Slowing and ponding of runoff water to promote settlement of suspended solids
- Fabric provides some filtration of larger soil particles

Pollution Removal Efficiencies:

- Moderate to good removal of silt and sand particles if properly placed, installed, and maintained
- Poor removal of clay particles

Companion and Alternative BMPs

- Perimeter Controls - Page # BMP Guidebook
- Storm Sewer Inlet Protection

Advantages and Disadvantages

Advantages:

- Relatively inexpensive
- Easy to install
- Readily available

Disadvantages:

- Poor effectiveness on fine sized soil particles such as clay
- May require frequent maintenance
- Effective only for sheet runoff flow, fails in concentrated flow areas due to low permeability
- Limited effectiveness at large, sloping sites

Location

Silt fence should be installed at the downslope edge of disturbed areas, along a line

of equal elevation (parallel to contour lines). Place beyond the toe of steeper slopes if possible to increase the “ponding” or settling effect.

Materials

Table 1: Materials and properties for silt fence construction

Woven Geotextile Fabric Width	Min. Hardwood Post Length*	Min. Grab Tensile (ASTM D 4632)	Min. Trapezoidal Tear Strength (ASTM D 4533)	Min. Permittivity (ASTM D 4491)	Max. Apparent Opening Size (ASTM D 4751)
24"	36"	100 lbs	45 lbs	0.1 sec ⁻¹	0.6 mm
36"	48"	100 lbs	45 lbs	0.1 sec ⁻¹	0.6 mm

*Hardwood posts shall be a minimum of 1 1/8" x 1 1/8" thickness

Source: Adapted from Michigan Department of Transportation 2003 Standard Specifications for Construction

Additional materials:

- Metal Staples or nails for attaching lath and fabric to posts
- Hardwood Lath 6 to 8 inches shorter than fabric width

Design Specifications

- Fabric attached to post by stapling or nailing through lath and into hardwood posts, at a minimum of four locations, evenly spaced along lath to prevent fabric tear out
- 6 inch loose bury flap unattached to post at bottom of lath
- Maximum post spacing: 10feet
- Whenever possible, place silt fence in flat areas at least 10 feet from the toe of slopes (silt fence is not an appropriate measure for placement on steep slopes)
- Maximum contributing drainage area is ½ acre per 100 linear feet of fence

Performance Enhancers

- Wider Fabric and longer posts (ie. 36" fabric and 48" posts)
- Heavier posts (ie. 2" x 2")
- More frequent post spacing (ie. 6.5')
- Reinforcing mesh on fabric
- Placing multiple parallel rows may provide a factor of safety

Construction Guidelines

Guidelines are in consecutive order:

1. Dig a 6 inch trench at equal elevation (parallel to contour lines) at the downslope edge of earth disturbance (avoid placement on steep slopes).
2. Unroll and extend silt fence along trench line. Orient fence such that the posts are down slope of the fabric and lath (ie. storm water will push the lath and fabric against the post).
3. Turn end post 360 degrees so that fabric surrounds the post

4. Pound end post into the ground at the downslope edge of the trench until the top of the 6" bury flap is at ground elevation.
5. Continue to pound in posts consecutively starting with post adjacent to the end already installed. Assure fabric is as taught as possible.
6. Join consecutive rolls by rolling end posts similar to Item 3 above. Cross over the end posts or place them side by side and roll them (180 or 360 degrees). Drive the end posts together.
7. Backfill the trench and compact. If possible, leave a compacted ridge of soil along the upslope edge of the fabric.

Alternative Construction:

1. In situations where the bury flap cannot be trenched in, backfill and compact over the bury flap (note: less effective and more prone to failure).
2. In some cases, it may be advantageous to construct silt fence in the field (i.e. fabric, posts, and lath) come separate and must be put together. The same construction guidelines apply.
3. Silt fence installation machines may make the process of installing silt fence easier. The machines "slice" the fabric into the ground, then posts and lath are manually installed.

Monitoring

Silt Fence should be inspected at least weekly, immediately before a forecasted runoff event, and after each runoff event from rain or snowmelt. Look for fabric tears, post failure, undermining, sediment build up, overtopping, side cutting around the silt fence, and areas damaged by construction activities.

Maintenance

- Fabric tears, post failures, vehicle damage, and/or undermining should be repaired immediately
- Sediment build up should be removed when it reaches 1/3 to 1/2 the height of the silt fence above ground elevation
- Overtopping and side cutting are signs that the silt fence is either not appropriately placed or that additional measures are necessary due to site runoff conditions
- REMOVE THE SILT FENCE ONCE THE SITE IS STABILIZED WITH PERMANENT SESC MEASURES

References

Michigan Department of Transportation. 2003. Standard Specifications for Construction.

Oakland County, Michigan Water Resources Commissioner. Individual Soil Erosion and Sedimentation Details, SP-2-Silt Fence

Exhibit 1: Silt fence construction and installation diagram

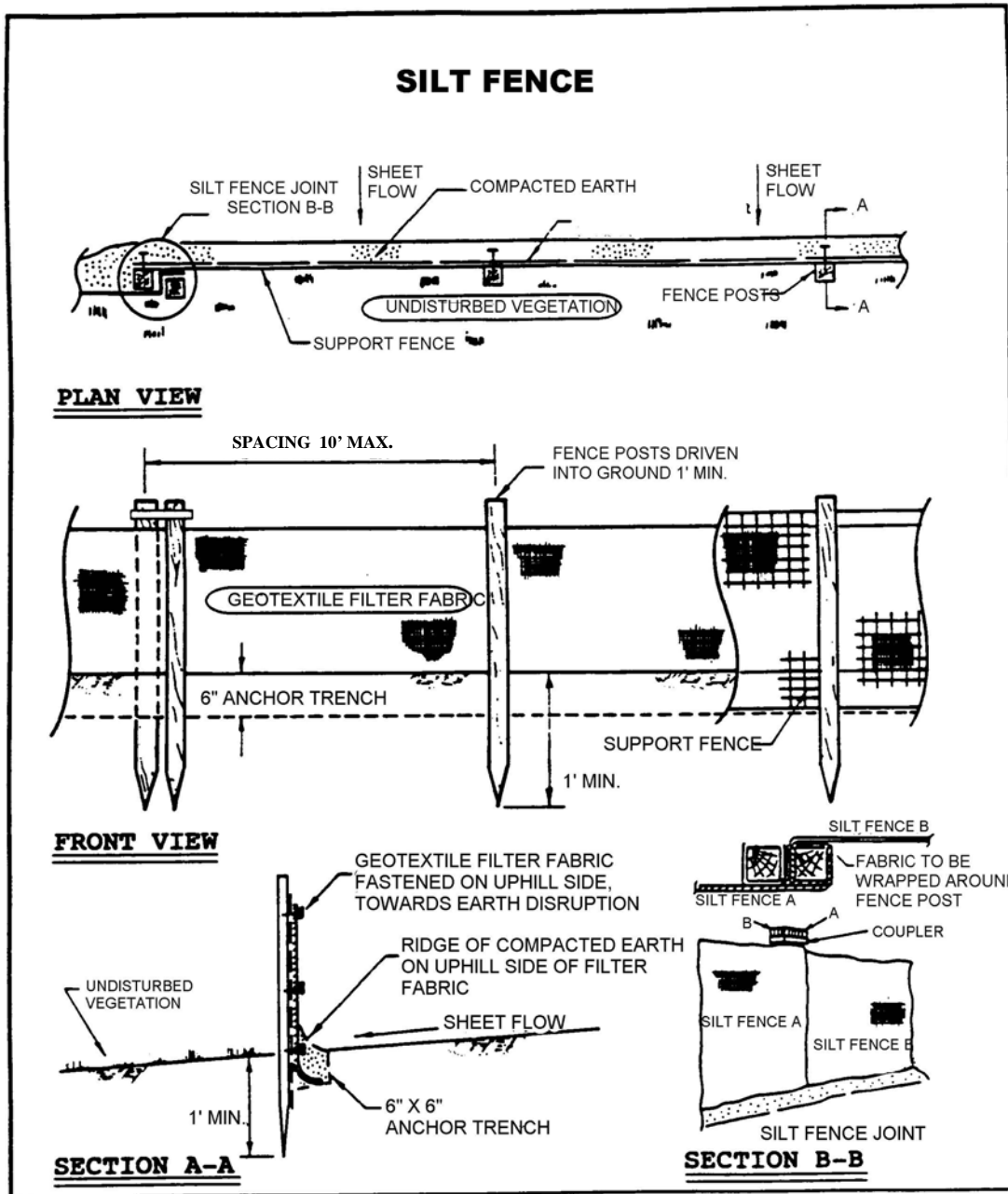

Source: Adapted from Oakland County (Michigan) Erosion Control Manual

Turbidity Curtain

Definition

A flexible, impermeable barrier used to trap sediment in water bodies. This curtain is generally weighted at the bottom to ensure that sediment does not travel under the curtain which is supported at the top through a flotation system. Staked curtains are available for applications with very limited exposure to water flow or wave action.

Description and Purpose

To prevent the migration of sediment from a work site in a water environment into the larger body of water

The practice may also be called turbidity barrier, silt curtain

Pollutant(s) controlled:

- Suspended Solids

Treatment Mechanisms:

- Settling

Advantages and Disadvantages

Advantages:

- Allows for containment of sediment-laden water within a work area
- Protects contained water from turbulence, allowing particles to fall out of suspension

Disadvantages:

- Can fail when subjected to significant water flows or wave action
- Cannot be used as a filter across stream flow
- Possible mobilization of fine sized settled particles after removal

Location

A turbidity curtain is generally used when construction activity occurs within a waterbody or along its shoreline and is of short duration, generally less than one month. Curtains are used in calm water surfaces. **Turbidity curtains are not to be used across flowing watercourses.**

General Characteristics

- Turbidity curtains should be oriented parallel to the direction of flow
- For sites not subject to heavy wave action, the curtain height shall provide sufficient slack to allow the top of the curtain to rise to the maximum expected high-water level (including waves) while the bottom maintains continuous contact with the bottom of the water body. The bottom edge of

the curtain shall have a weight system capable of holding the bottom of the curtain down and conforming to the bottom of the water body, so as to prohibit escape of turbid water under the curtain

- For sites subject to heavy wave action, the curtain height shall provide sufficient slack to allow the top of the curtain to rise to the maximum expected high-water level (including waves) while the bottom remains 1 foot above the bottom. The weight system shall hold the lower edge of the curtain in place so as to allow 1 foot of clearance above the bottom at mean low water, so that the curtain does not stir up sediment by repeatedly striking the bottom
- The curtain should be constructed of nonwoven material.
- Materials should be of bright colors, when applicable, to attract attention of boaters or swimmers using areas near the work site

Materials

- Rope or cable with floats
- Anchors
- Premanufactured Turbidity Barrier (generally woven geotextile with polymer coat)

Design Specifications

- The turbidity curtain shall be located beyond the lateral limits of the construction site and firmly anchored in place
- The alignment should be set as close to the work area as possible but not so close as to be disturbed by construction equipment
- The height of the curtain should be designed to account for expected wave action and water level fluctuations as a result of storm events. At a minimum, the curtain height should be 20 percent greater than the depth of the water
- The area that the turbidity curtain protects shall not contain large culverts or drainage outlets which may cause the curtain to fail during flow events
- If water depths (<2 feet) and flow at the designed alignment is minimal, the toe can be anchored in place by staking (Exhibit 1: Shallow)
- When water is greater than 2 feet deep or where high flow exists, the "Turbidity Curtain (Deep)" design must be used (Exhibit 1)
- Hard armor (ie. concrete barriers) may be necessary to protect the curtain on the upstream side in certain flowing water applications

Construction Guidelines

8. Assure that all necessary permits for work within a water of the state are obtained from the DEQ Water Resources Division prior to starting work.
9. The area of proposed installation of the curtain shall be inspected for obstacles and impediments that could damage the curtain or impair its effectiveness to retain sediment.
10. All construction materials shall be removed so they cannot enter the water body.

11. Shallow installations can be made by securing the curtain by staking rather than using a flotation system.
12. Supplemental anchors of the turbidity curtain toe shall be used, as needed, depending on water surface disturbances such as boats and wave action by winds.

Monitoring

1. The turbidity curtain shall be inspected daily and repaired or replaced immediately.
2. If the curtain is oriented in a manner that faces the prevailing winds, frequent checks of the anchorage shall be made.
3. While inspecting, look for areas where turbid water is escaping into the larger water body.

Maintenance

- It is not normally necessary to remove sediment deposited behind the curtain; but, when necessary, removal is usually done by hand prior to removal of the barrier. All removed silt is stabilized away from the water body.
- The barrier shall be removed by carefully pulling it toward the construction site to minimize the release of attached sediment.
- Any floating construction or natural debris shall be immediately removed to prevent damage to the curtain.

References

Michigan Department of Transportation 2006 Soil Erosion & Sedimentation Control Manual
Michigan Department of Management and Budget 2003 Soil Erosion and Sedimentation Control Guidebook

Exhibit 1:

Turbidity Curtain

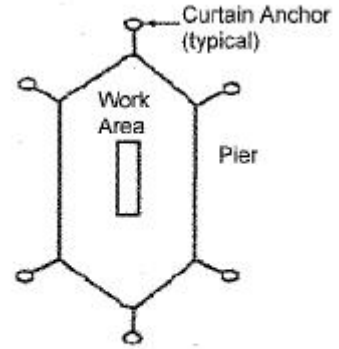
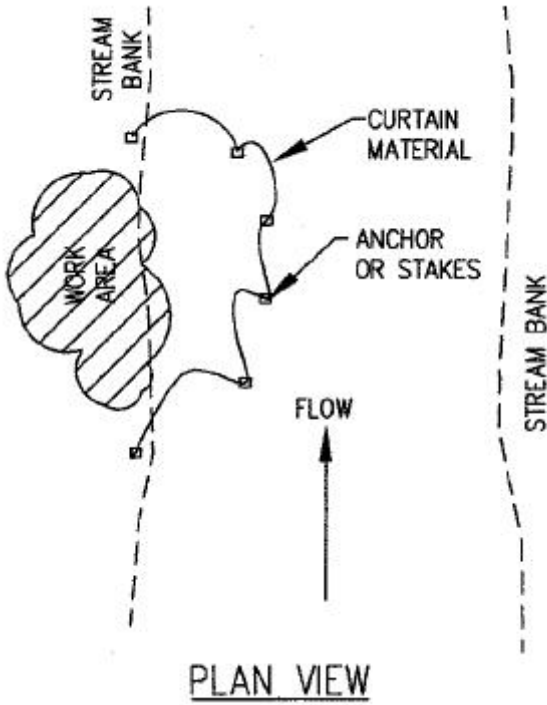

In-Stream Construction

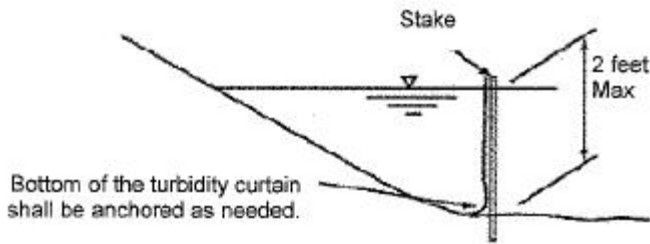

When water is less than 2 feet deep and has low flow, a shallow turbidity curtain may be used. Curtain shall be securely fastened to stakes.

Shallow Turbidity Curtain

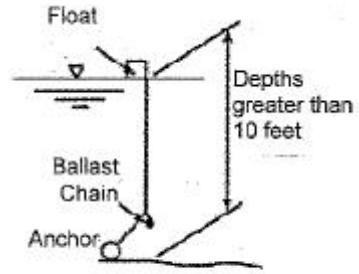
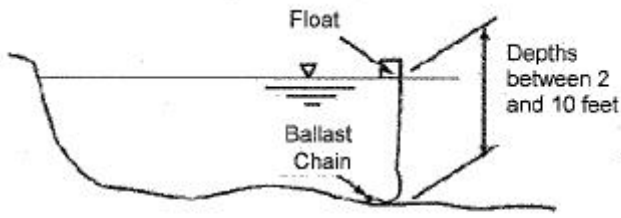

Deep Turbidity Curtain

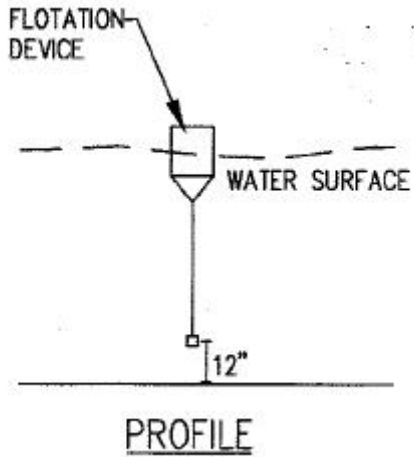

Source: Adapted from Michigan Department of Transportation 2006 Soil Erosion & Sedimentation Control Manual and Michigan Department of Management and Budget 2003 Soil Erosion and Sedimentation Control Guidebook

Storm Sewer Inlet Protection

Definition

Storm sewer inlet protection consists of a sediment filter or an impounding area around or upstream of a storm sewer, drop inlet, or curb catch basin.

Description and Purpose

Storm sewer inlet protection measures temporarily pond runoff before it enters the storm sewer, allowing sediment to settle, or remove sediment by filtering.

The practice may also be called Storm Sewer Inlet Protection or Inlet Protection

Pollutant(s) controlled:

- Suspended Solids

Treatment Mechanisms:

- Settling of sediment through detention
- Filtration of sediment

Pollution Removal Efficiencies:

- Varies with soil type on site and type of inlet protection selected

Companion and Alternative BMPs

- Silt fence
- Sediment basins

Advantages and Disadvantages

Advantages:

- Will reduce the amount of sediment entering the storm sewer system, potentially extending the time until maintenance is needed
- In many cases, provides a last chance to remove suspended particles from runoff
- Areas requiring protection are easy to identify during both planning and construction

Disadvantages:

- Requires an adequate area for water to pond without encroaching into portions of the site where active construction is occurring or onto roadways subject to traffic
- Inlet protection usually requires other methods of temporary protection to prevent sediment-laden storm water and non-storm water discharges from entering the storm sewer system
- Sediment removal may be difficult in high flow conditions or if runoff is heavily sediment laden
- Frequent maintenance is required

- May be improperly used as the sole method of erosion and sedimentation control

Location

Every storm sewer inlet receiving sediment-laden runoff should be protected.

General Characteristics

- Three types of inlet protection are detailed in this specification:
 1. Silt Fence Barrier: Appropriate for drainage basins with less than a 5% slope, sheet flows, and flows under 0.5 cfs.
 2. Block and Gravel Filter: Appropriate for flows greater than 0.5 cfs.
 3. Premanufactured devices: A variety of manufactured products are available including: storm inlet filter socks, synthetic filter tubes for open throat curb inlets, inlet inserts, pop-up filters for area inlets, and many others. These products should be used and installed according to the manufacturer's recommendations.
- DEQ does not recommend the use of filter fabric under the grate as an inlet protection measure. Fabric blinds off quickly when the pores space in the fabric close with sediment causing flooding to occur. When flooding occurs the fabric is often tampered with (slits cut in) rendering it ineffective at reducing or preventing sediment discharge into the storm water system. In addition fabric is often unable to be effectively removed without causing the sediment on top of the fabric to drop into the catch basin.

Materials

1. Silt Fence Barrier:

Table 1: Materials and properties for silt fence construction

Woven Geotextile Fabric Width	Min. Hardwood Post Length*	Min. Grab Tensile (ASTM D 4632)	Min. Trapezoidal Tear Strength (ASTM D 4533)	Min. Permittivity (ASTM D 4491)	Max. Apparent Opening Size (ASTM D 4751)
24"	36"	100 lbs	45 lbs	0.1 sec ⁻¹	0.6 mm
36"	42"	100 lbs	45 lbs	0.1 sec ⁻¹	0.6 mm

*Hardwood posts shall be a minimum of 1 1/8" x 1 1/8" thickness

Source: Adapted from Michigan Department of Transportation 2003 Standard Specifications for Construction

Additional materials:

- Metal Staples or nails for attaching lath and fabric to posts
- Hardwood Lath 6 to 8 inches shorter than fabric width

2. Block and Gravel Filter:

- Hardware cloth or comparable wire mesh with 0.5 inch openings
- Concrete blocks
- Washed stone 0.75 to 3 inches

Design Specifications

- If high flow conditions are expected, use other onsite sediment trapping techniques in conjunction with inlet protection.
- Using any inlet protection device that restricts the flow into the inlet should be avoided for inlets that are on-grade. Because of the flow restriction, a majority of the flow to an on-grade inlet will be bypassed to the downstream inlet. This creates the potential for flooding problems downstream.
- To limit the potential for flooding, limit the upstream drainage area to 1 acre.
- Runoff should be routed to a sediment-trapping device designed for larger flows (e.g. sediment basin) when the drainage area exceeds 1/2 acre.
- Silt Fence Barrier (see figure 1)
 1. Silt fence must be installed per Silt Fence Specification
 2. Stakes must be a maximum of 3 feet apart
 3. Fabric must be trenched in
 4. You may want to consider spill-over protection on the inlet side of the silt fence barrier such as mulch blanket, geotextile fabric, stone, etc. This prevents the dislodging of soil on the inside of the silt fence barrier by water passing through or over top of the silt fence.
- Block and Gravel Filter (see Figure 2)
 1. Place concrete blocks lengthwise on their sides in a single row around the perimeter of the inlet, so that the open ends face outward, not upward. The ends of adjacent blocks should abut. The height of the barrier can be varied, depending on design needs, by stacking combinations of blocks that are 4 inches, 8 inches, and 12 inches wide. The row of blocks should be at least 12 inches but no greater than 24 inches high.
 2. Place wire mesh over the outside vertical face (open end) of the concrete blocks to prevent stone from being washed through the blocks. Use hardware cloth or comparable wire mesh with 0.5 inches opening.
 3. Pile washed stone against the wire mesh to the top of the blocks. Use 0.75 to 3 inches

Performance Enhancers

- An excavated drop inlet sediment trap can be used in conjunction with other inlet protection to enhance the settling of large sediment particles prior to it entering the storm sewer system.

Construction Guidelines

- Identify existing and planned storm sewer inlets that have the potential to receive sediment laden surface runoff. Determine if storm drain inlet protection is needed and which method to use.
- Determine the acceptable location and extent of ponding in the vicinity of the storm drain inlet. The acceptable location and extent of ponding will influence the type and design of the storm sewer inlet protection device.
- Select the appropriate type of inlet protection and design
- Inlet protection should be placed immediately after storm sewer inlets are installed.
- Inlet protection should be left in place and maintained until the drainage area is stabilized with established vegetation and pavement.
- Remove storm sewer inlet protection once the drainage area is stabilized.

Monitoring

Inspect BMPs prior to forecast rain, daily during extended rain events, after rain events, weekly during the rainy season, and at two-week intervals during the non-rainy season.

Maintenance

- Silt Fence Barriers. If the fabric becomes clogged, torn, or degrades, it should be replaced. Make sure the stakes are securely driven in the ground and are in good shape (i.e., not bent, cracked, or splintered, and are reasonably perpendicular to the ground). Replace damaged stakes.
- Block and Gravel Filters. If the gravel becomes clogged with sediment, it must be carefully removed from the inlet and either cleaned or replaced. Since cleaning gravel at a construction site may be difficult, consider using the sediment-laden stone as fill material and put fresh stone around the inlet.
- Sediment that accumulates in the BMP must be periodically removed in order to maintain BMP effectiveness. Sediment should be removed when the sediment accumulation reaches 1/3 – 1/2 of the silt fence height. Sediment removed during maintenance may be incorporated into earthwork on the site or disposed at an appropriate location.

References

California Stormwater BMP Handbook, Construction, 2003

Figure 1. Silt Fence Barrier

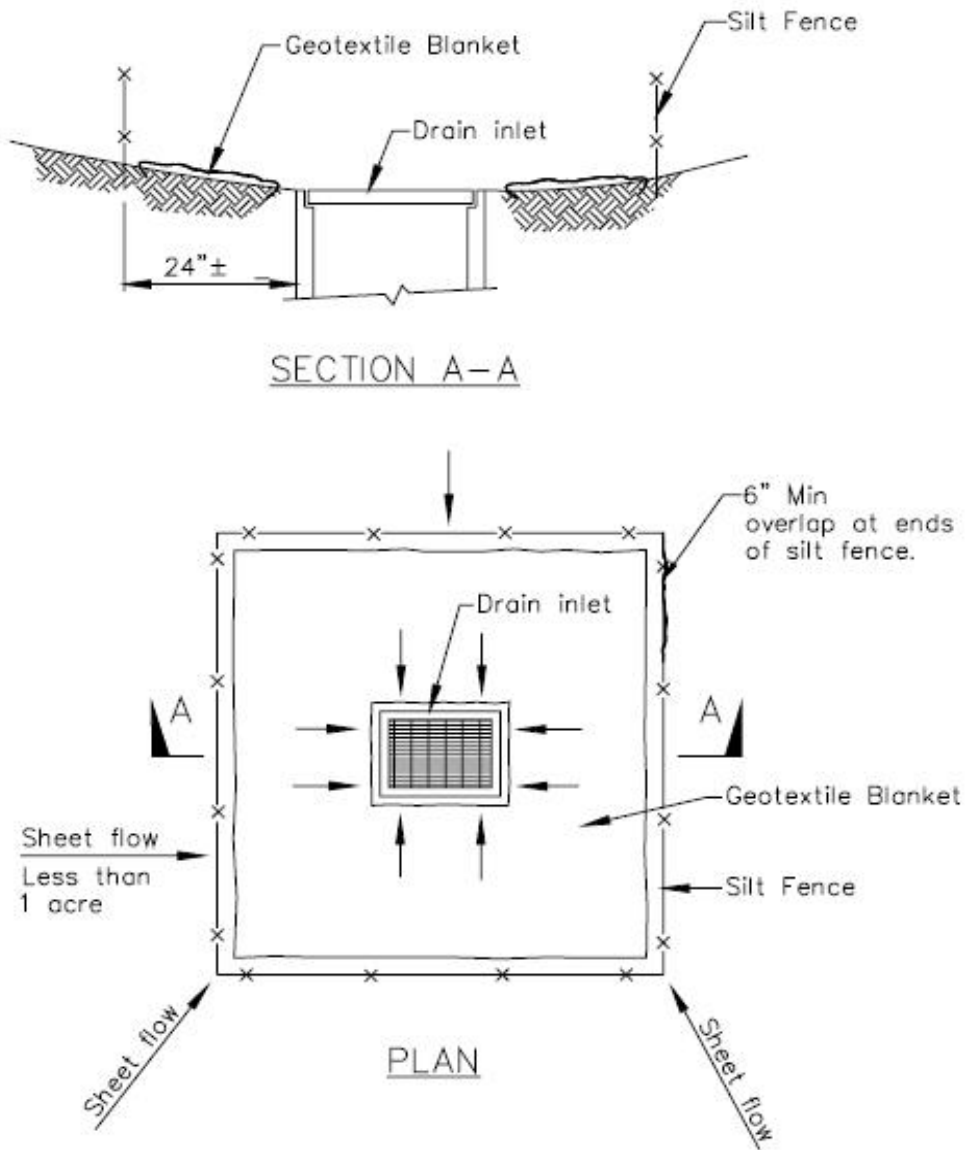

Source: California Stormwater BMP Handbook, Construction, 2003

Figure 2. Block and Gravel Filter

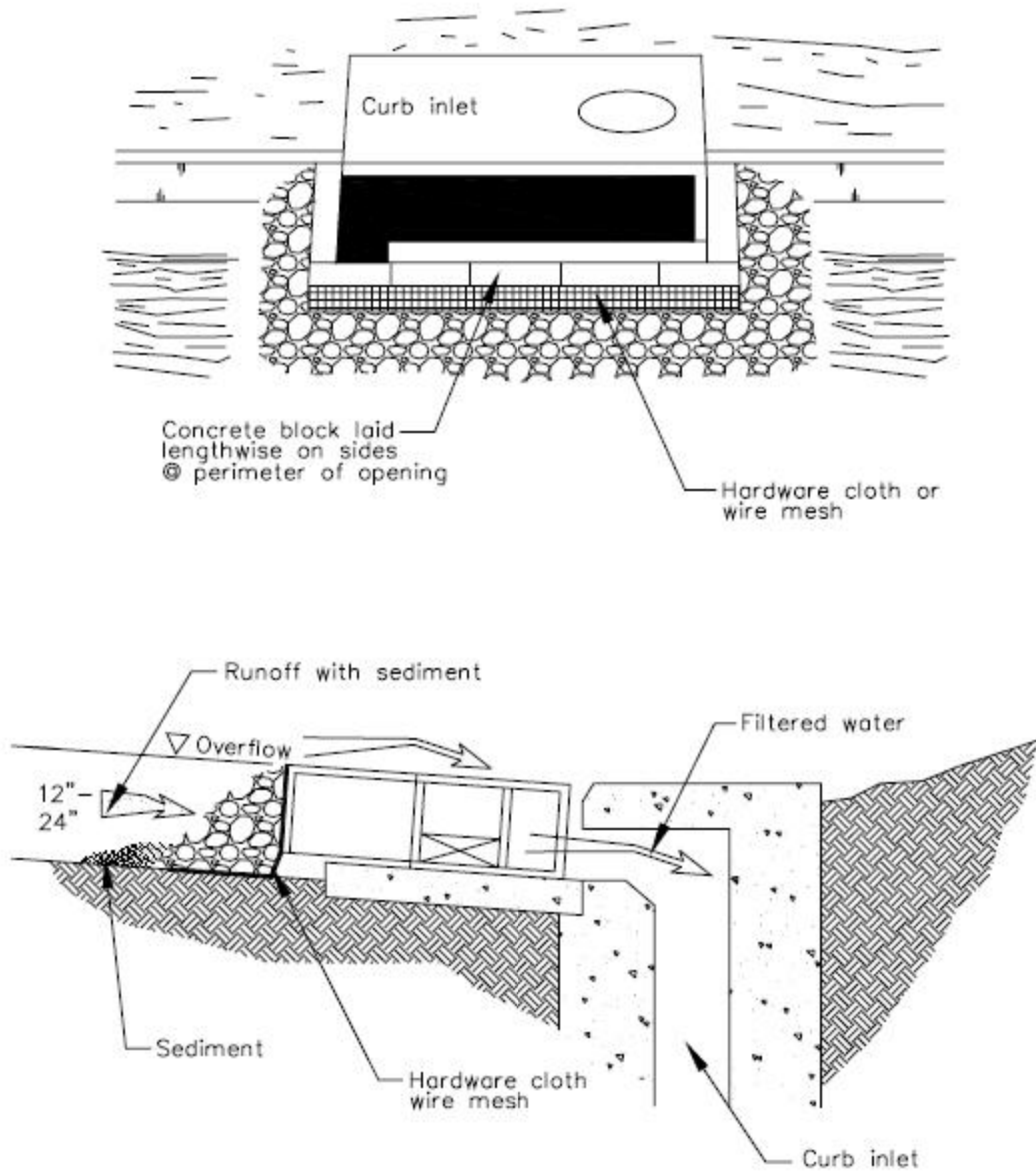

Source: California Stormwater BMP Handbook, Construction, 2003

Access Road

Definition

An access road is an aggregate armored and stabilized roadway which acts as a defined point of ingress and egress from a site with disturbed soils.

Description and Purpose

Access road is a sediment control BMP consisting of a stabilized aggregate driving surface which is used to prevent off-site migration of sediment from construction traffic. This practice allows ingress and egress of construction traffic from a project site, while protecting vegetative cover, preventing erosion and sediment tracking, reducing areas of soil compaction, and protecting water quality. Access roads define and limit the number of access points at a project site. They may be used throughout a site for similar purposes.

The practice may also be called an ingress road or egress road, aggregate access road, driveway, haul road, or stabilized construction entrance or roadway.

Pollutant controlled:

- Suspended solids

Treatment Mechanisms:

- Prevents devegetation, soil compaction, and erosion at site access points
- Removes sediment from tires prior to egress onto public right-of-ways
- Stores and stabilizes sediment in pore spaces between aggregate
- Limits construction traffic disturbance if properly designed and installed

Pollution Removal Efficiencies:

- May have poor performance on sites with clay soils, possibly requiring a tire washdown

Companion and Alternative BMPs

- Construction Barriers may limit construction traffic to intended areas (Access Roads) – Page # BMP Guidebook
- Street Sweeping, Tire Washdown, and Watercourse Crossing where appropriate – Page # BMP Guidebook
- Diversions direct runoff from the Access Road to stable areas or treatment

Advantages and Disadvantages

Advantages:

- Applicable to nearly all sites with disturbed soils and construction/equipment traffic
- Simple design; easy to install and remove
- Ease of access for maintenance
- Materials may include recycled/reused concrete – good for road projects
- Effective for minimizing street sweeping and sediment loading to inlet protection devices

Disadvantages:

- Limited effectiveness on heavy clay soil
- May require frequent maintenance or several reinstallations on heavy traffic sites
- Needs to be removed or paved when the project is complete
- Aggregate may be expensive

Location

Locate access roads at every point where construction traffic enters or leaves a site with disturbed soils.

Avoid placing access roads in wetlands, flood plains, rivers, streams, or drains. If such placement is unavoidable, a permit from the DEQ may be required prior to construction.

General Characteristics

- Compacted roadway with an open graded (limited fines) aggregate surface.
- Flared entrance adjacent to roadways
- Optional improvements: Tire washing station; mountable berm adjacent to roadway; turn-arounds or widened areas for passing.

Materials

- 2-3 inch diameter open-graded or washed aggregate (stone or crushed concrete). Angular or crushed aggregate will increase effectiveness of sediment removal, increase road stability, and increase the service life of the Access Road by providing pore space for sediment storage. An increase in aggregate size and depth is necessary for heavier equipment. Avoid aggregate sizes that may wedge between dual tires if such traffic is expected.
- Non-woven geotextile fabric (8-12 oz/yd³) underlay. Geotextile material increases the service life and increases road stability.

Design Specifications

- Determine the location and construction specifications during the project planning stage
- Locate, size, and design for use by all applicable construction traffic. Consider additional space to turn trucks/trailers
- Address and treat sediment laden runoff prior to discharging from the site
- Whenever possible, construct the entrance on a firm, compacted subgrade. This can substantially increase the effectiveness of the pad and reduce the need for maintenance
- State permits for crossing streams or wetlands will generally be necessary, and special precautions may be required to protect water quality
- Use the following specifications unless local or state requirements, or project engineer specifications, differ:
 - a. Minimum length: 50 feet
 - b. Minimum width: 10 feet. Design for at least 2 feet wider than the width of the largest vehicle or piece of equipment expected, with additional width for turning radius on corners
 - c. Suggested minimum thickness: 6 inches of 2-3 inch diameter open graded or washed angular aggregate. Larger diameter aggregate requires additional thickness
 - d. Flare the entrance to the adjacent road to provide a turning radius
 - e. Side slopes should be no steeper than 2H:1V
 - f. Do not construct an earthen road shoulder except where turn-outs are needed
 - g. Underlay Access Road with a nonwoven geotextile fabric
 - h. Place and compact aggregate in uniform layers of not more than 6 inches, nor less 3 inches

Performance Enhancers

- Tire washing or corrugated or ribbed "drive-on" steel panels improve effectiveness
- Mountable Berm at transition to pavement to encourage sediment to dislodge from tires
- Install turn-arounds and passing lanes if appropriate
- Install/maintain Filter Strips, Sediment Basins, or other sediment controls to address runoff

Construction Guidelines

Guidelines are in consecutive order:

1. Construct prior to initiating earth disturbance at the site, during any time of year
2. Clear, grade, and compact the Access Road subgrade and surrounding area according to Grading Practices specifications
3. Apply non-woven geotextile fabric over the existing subgrade prior to placing aggregate
4. Apply the aggregate in layers, compacting prior to placement of the next

- layer
5. Install Construction Barriers to prevent ingress and egress on unprotected soils
 6. At the project completion, remove access roads and reuse or dispose of aggregate
 7. Re-grade as necessary, and install permanent stabilization measures as soon as possible
 8. Once the access road has been removed, special attention is necessary to ensure that off-site sedimentation/tracking is not occurring, or is addressed by Street Sweeping

Monitoring

Access roads should be inspected daily during use. Performance is determined by the lack of tracking out of materials onto adjacent right-of-ways.

Maintenance

- Routinely inspect (daily during use) the access road and adjacent roadways for trackout, soil build-up, filled aggregate voids, and signs of road bed failure such as migration of the stone into the sub-base, rutting, etc. Repair failures and sweep/remove trackout immediately
- Inspect and maintain any companion BMPs that treat or control runoff or prevent erosion
- Clean, replenish (adding additional aggregate layers), or replace the aggregate surface before soil buildup causes track-out
- Keep drainage ways for the access road clear
- Increase the length of the Access Road or install a tire wash if the Access Road is not effectively removing sediment from tires during egress. Tire wash water should drain into a Sediment Basin or other suitable treatment practice for suspended solids.
- Where site constraints limit the effectiveness of the access road, daily street sweeping can keep the soil that is tracked out from reaching sewers
- Immediately remove all sediment dropped or eroded onto public right-of-ways by sweeping or shoveling. Do not wash sediment into waterways or storm sewers.
- Immediately remove any aggregate that has loosened from the pad and ended up on the roadway.

References

- California Stormwater Quality Association. 2003. *California Stormwater BMP Handbook, Construction*. Menlo Park CA. <https://www.casqa.org/resources/bmp-handbooks>
- DTMB. 2005. *SESC Guidebook*. Facilities Administration, Design & Construction Division. Lansing MI. <https://www.michigan.gov/dtmb/procurement/Design-and-Construction/Sustainability/soil-erosion-and-sedimentation-control>
- MDOT. 2006. *Soil Erosion and Sedimentation Control Manual*. Construction and

Technology Support Area. Lansing MI. <https://www.michigan.gov/-/media/Project/Websites/MDOT/Programs/Highway-Programs/Environmental-Efforts/Stormwater-Management/SESC-Manual.pdf>

Montana Department of Transportation. 2004. *Erosion and Sediment Control Best Management Practices: Field Manual*. Section 2i, Tracking Control. BMPs. Helena MT.

mdt.mt.gov/research/docs/research_proj/erosion/refman/section3e.pdf

Salt Lake County Engineering Division. 1999. *Stormwater Discharge Management from Construction Activities*. Salt Lake City UT.
(The link provided was broken and has been removed)

New York Standards and Specifications for Erosion and Sediment Control. 2005, *Stabilized Construction Entrance*

Figure 1. Access Road

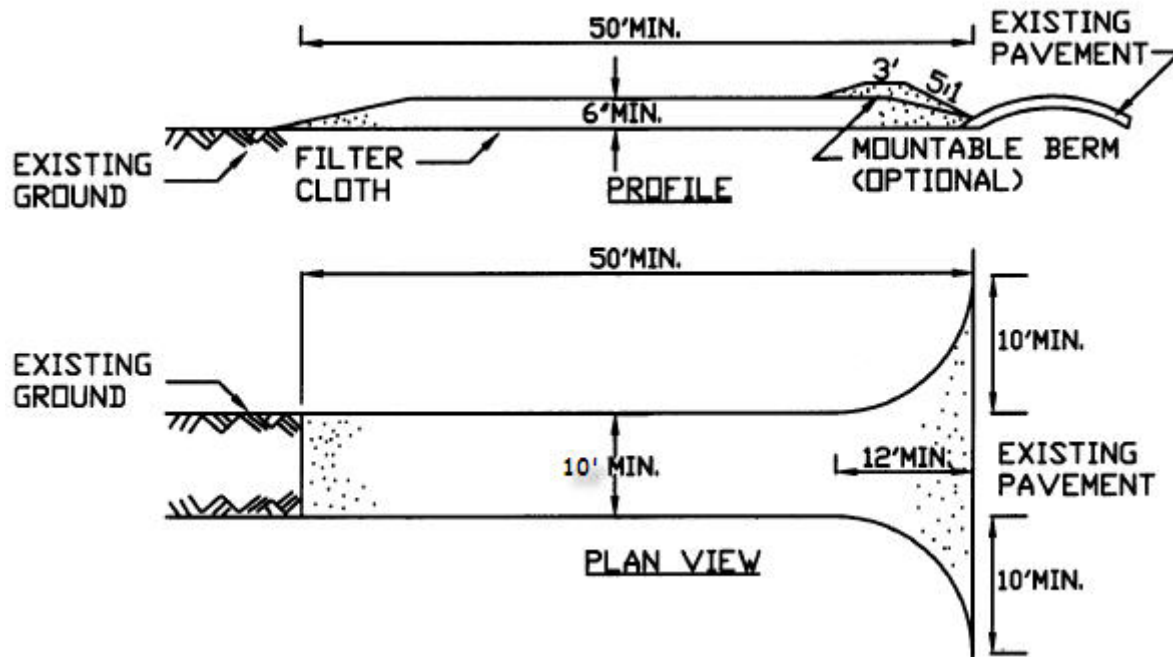

Source: New York Standards and Specifications for Erosion and Sediment Control. 2005, *Stabilized Construction Entrance*

Check Dam

Definition

Small barrier, grade control structure, or dam constructed across a swale, drainage ditch, or other channelized flow of water. Also known as in-stream/channel energy dissipaters, ditch checks, prefabricated check dams, and permeable runoff structures.

Description and Purpose

Check dams reduce scour and channel erosion by reducing flow velocity and encouraging sediment settlement by reducing the effective slope of the channel. A check dam is a device constructed of angular or crushed stone, crushed concrete, gravel bags, fiber rolls, or other prefabricated products placed across a natural or man-made channel or ditch.

Runoff water runs through and spills over the top of check dams and continues along the drainage way or swale. Check dams in a channel or ditch should be placed in series along gradients to act like terraces.

Check dams can be either temporary (during construction) or permanent.

Pollutants controlled:

- Suspended solids

Treatment Mechanisms:

- Slows runoff velocity and protects the channel substrate and establishing vegetation.
- Disperses or redirects concentrated flows within in the channel to reduce erosion potential.
- May collect sediment by acting as a small settling basin

Pollution Removal Efficiencies:

- Primary purpose is to prevent channel erosion.
- May be effective in removing large, dense particulates. Removal efficiency is typically less than 80 percent

Companion and Alternative BMPs

- Utilized in Diversions, Storm Water Conveyance Channels, and Grassed Waterways to reduce erosive velocity and aid vegetation establishment. Page # BMP Guidebook

Advantages and Disadvantages

Advantages:

- Small footprint, fits within an existing channel
- Simple and inexpensive design, easy to install
- Ease of access for cleanout and maintenance
- Can be used for pretreatment to reduce velocity and provide some removal of solids
- May be modified to provide filtration
- Materials may be recycled/reused: (stone, crushed concrete, and prefabricated products)

Disadvantages:

- Can not be used in streams unless approved by DEQ permit.
- Additional downstream treatment necessary for sediment laden storm water
- Reduce the hydraulic capacity of the channel
- May clog with leaves in autumn
- Must be carefully designed and installed to assure minimization of erosion

Location

- In temporary and permanent storm water conveyance channels draining less than ten acres.
- Upstream of surface waters or treatment practices

General Characteristics

- Installed in a series with spacing dependent on channel slope
- Installed perpendicular to channel flow
- Low point of the dam (spillway) in the center. High point along the channel side slope.
- May be temporary or permanent

Materials

- Materials and design can vary according to need and conditions.
- Crushed or angular aggregate (stone or crushed concrete) underlain with geotextile.
- Other materials: Gravel bags, prefabricated synthetic products
- Do Not Use: straw bales, silt fence, logs, and similar materials which create a vertical downstream face, as they may create a plunge pool and undercutting, leading to failure

Design

1. Install perpendicular to channel flow to ensure that water does not flow around them.
2. Installed in a series. Steeper gradients require dams to be closer together. The down-gradient toe of the dam is at the same elevation as the bottom of the

- spillway opening of the next dam downstream.
3. The middle of the dam should be at least 9 inches lower than the outer edges.
 4. Spillway should be no taller than 2 feet above the channel bottom, or the potential for downstream scouring increases
 5. Underlay with a non-woven geotextile fabric, which is toed in 6 inches at the upstream edge.
 6. The upstream and downstream faces should be 2:1 or flatter. Flatter slopes reduce traffic hazards. Slope and height of check dams in transportation corridors must follow safety specifications of the transportation agency.
 7. Scour protection (riprap, geotextile fabric, or mulch blankets) should be installed for at least 2 feet immediately below the check dam to dissipate energy and to prevent scouring and undercutting.
 8. Aggregate size should increase with increased slope and velocity. Size may range from 4 to 15 inches. A small "bedding stone" placed under large aggregate may prevent scouring and undercutting
 9. Aggregate should extend up the banks of the channel to a point a minimum of 18 inches above anticipated flows to avoid washouts and overflow around the dam.
 10. Gravel bags must be securely sealed and placed by hand in an interlocking pattern.

Performance Enhancers

- Excavate a sump/sediment pool above the dam to increase storage volume and enhance settling.
- Can be modified to work as a Filter by adding smaller aggregate on the upstream side.

Construction Guidelines

1. Construct concurrently with channel construction, during any time of year
2. Place and toe-in geotextile underlay and downstream scour protection
3. Place aggregate material in the center of the channel to the desired center height
4. Place aggregate moving outward toward channel edge. The top of the check dam at the channel edge should be at least 9 inches higher than the center, creating a parabolic or trapezoidal downstream overflow profile.

After Construction

- Remove temporary check dams only after vegetation or permanent channel lining has been established.
- Remove or grade accumulated sediment prior to permanent seeding and mulching.
- For permanent check dams, an operation and maintenance plan which includes regular inspections of structural integrity and removal of accumulated sediment, shall be developed. It is important that the placement of permanent check dams be considered during channel design, as check dams will decrease the capacity of the channel.

Maintenance

Check dams should be inspected weekly and after each runoff event from rain or snowmelt. Washouts, sidecutting, undercutting, scouring, and deteriorating gravel bags should be repaired immediately. If erosion occurs between dams, install a protective channel liner (riprap, mulch blanket, etc.), or additional checkdams

To ensure water can flow through the dam, sediment should be removed when it accumulates to 1/2 the height of the dam, placed in an approved upland area and stabilized.

References

- California Stormwater Quality Association. 2003. *California Stormwater BMP Handbook*. Section SE-4: Check Dams.
<https://www.casqa.org/resources/bmp-handbooks>
- Massachusetts DEP. 2008. *Massachusetts Stormwater Handbook*. Volume 2, Chapter 2: Structural BMP Specifications.
(The link provided was broken and has been removed)
- National Pollutant Discharge Elimination System (NPDES) BMPs.
- Virginia Department of Conservation and Recreation. 1995. *Virginia Erosion & Sediment Control Field Manual*. 2nd ed. Virginia Department of Conservation and Recreation, Division of Soil and Water Conservation, Richmond, VA.
- Metropolitan Council/Barr Engineering co. 2000 Sediment Control Check Dams DNRE Storm Water Best Management Practices Catalog, September 2005
- State of New York Department of Transportation, 2003. Soil Erosion & Sedimentation Control – Check Dams

Exhibit 1: Typical Aggregate Check Dam Schematic

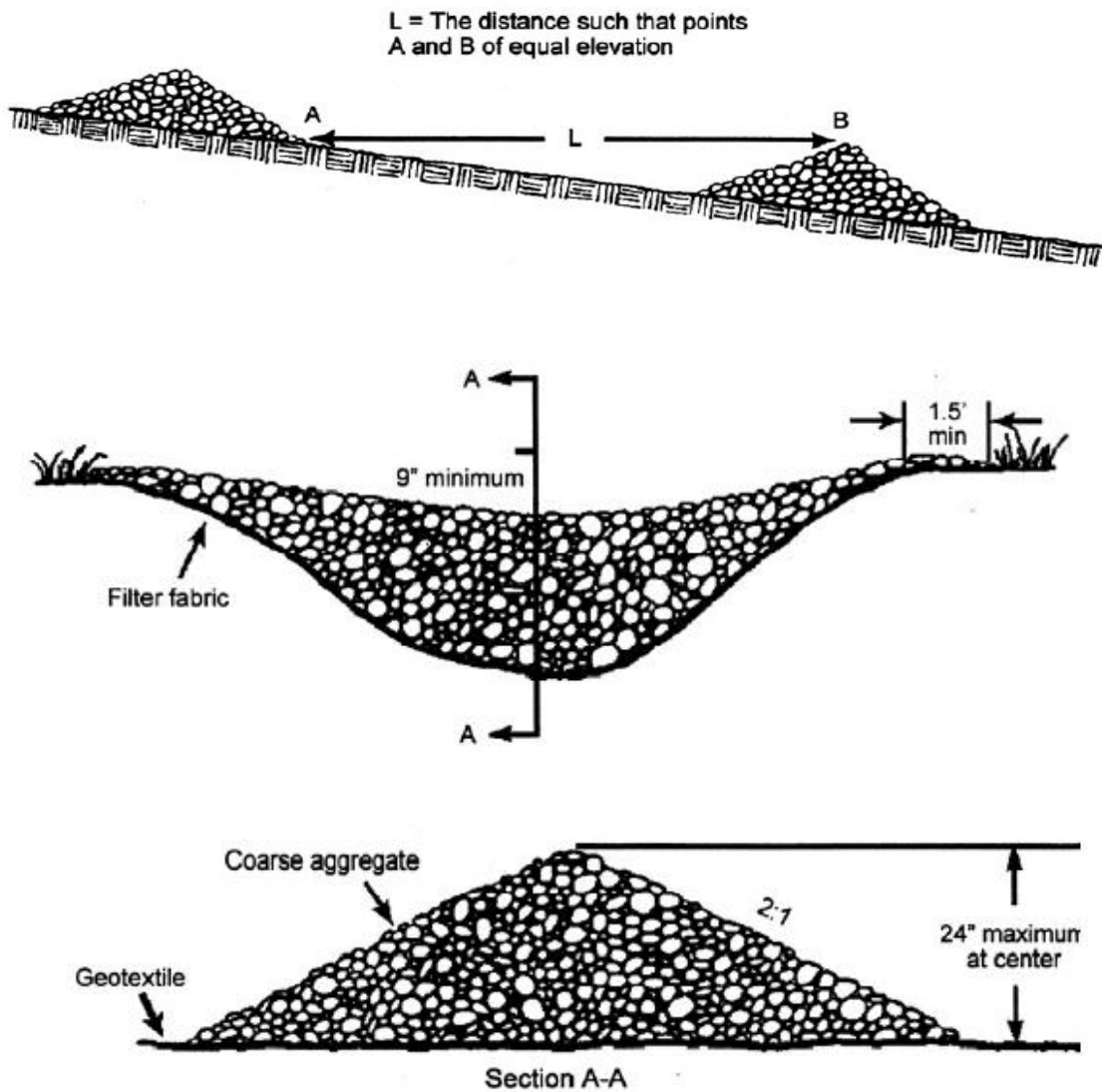

Source: Metropolitan Council/Barr Engineering co. 2000 Sediment Control Check Dams

Exhibit 2: Typical Cross Sectional Schematic of a Gravel Bag Check Dam

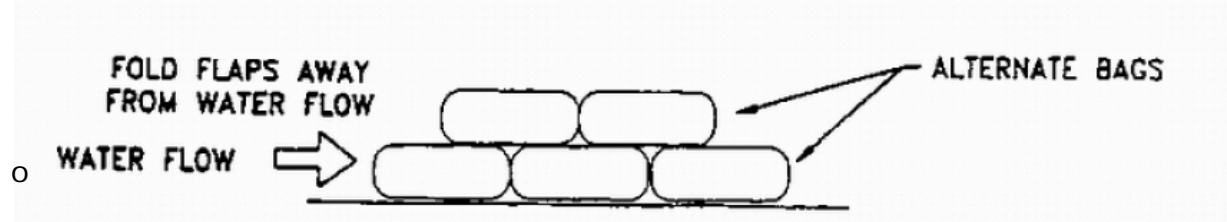

Source: DNRE Storm Water Best Management Practices Catalog, September 2005

Exhibit 3: Typical Prefabricated Permeable Runoff Control Structure Schematic

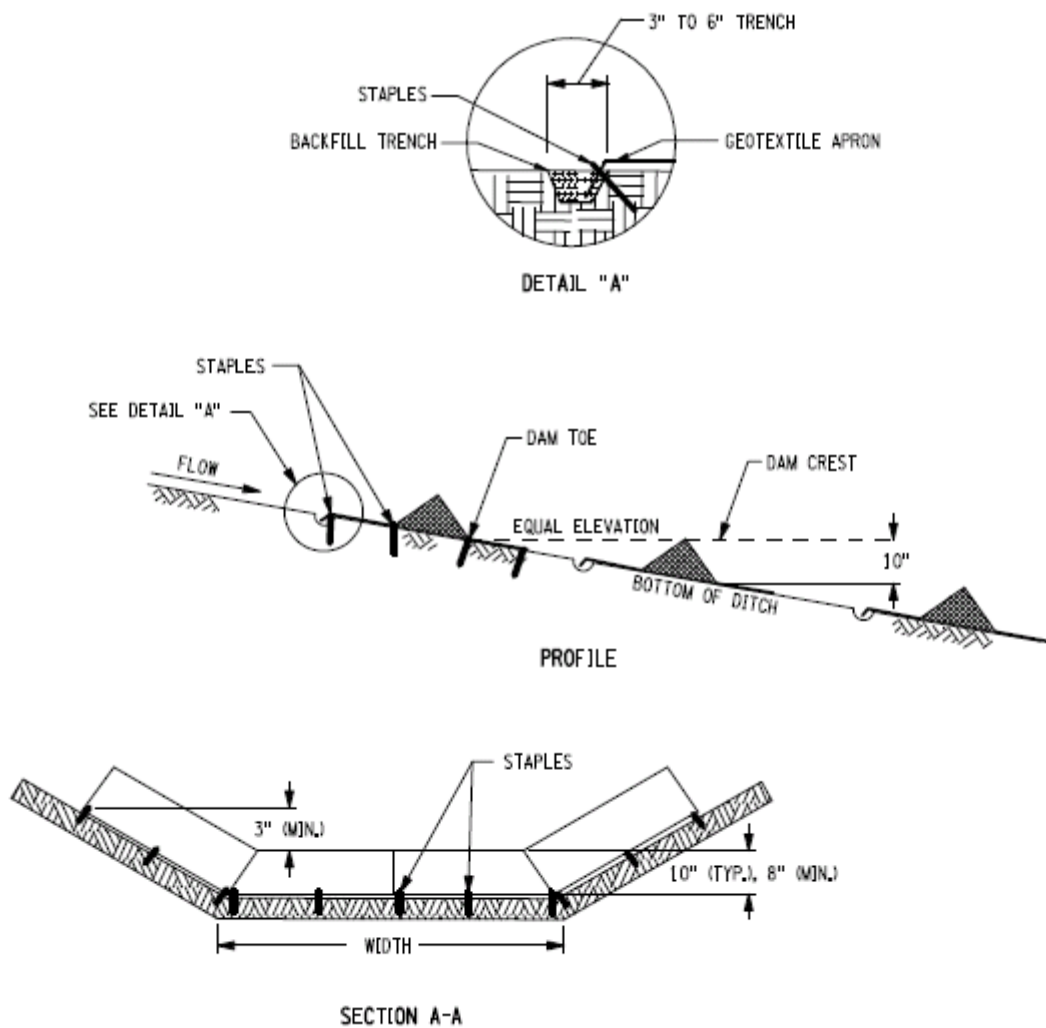

- Notes: 1. Install per manufacturer's specifications
 2. Use in conjunction with mulch blankets or other downstream scour protection

Source: State of New York Department of Transportation, 2003. Soil Erosion & Sedimentation Control – Check Dams

Riprap–Stabilized Outlet

Definition

A section of stone or crushed concrete protection placed at the outlet end of the culverts, conduits, or channels.

Description and Purpose

The purpose of the rock outlet protection is to reduce the velocity, and energy of water, such that the flow will not erode the receiving downstream reach.

The practice may also be called armoring or an energy dissipater

Pollutant(s) controlled

- Suspended Solids

Advantages and Disadvantages

Advantages

- Permanent low maintenance erosion control

Disadvantages

- Aesthetics

Location

This practice applies where discharge velocities and energies at the outlets of culverts, conduits, or channels are sufficient to erode the downstream reach. This applies to:

- Culvert outlets of all types.
- Pipe conduits from all sediment basins, dry storm water ponds, and permanent type ponds.
- New channels constructed as outlets for culverts and conduits.
-

General Characteristics

- Riprap structures should be designed by registered professional engineers.
- All work conducted below the ordinary high water mark of a lake or stream, or in a floodplain or wetland will require permits from the DEQ, Water Resources Division. This includes placement of riprap. See Exhibit 1 for an explanation of the ordinary high water mark.

Materials

- Nonwoven geotextile fabric or well-graded gravel or sand-gravel mix for filter blanket
- Crushed or angular aggregate

Design Specifications

General Considerations

The design of rock outlet protection depends entirely on the location. Pipe outlet at the top of cuts or on slopes steeper than 10 percent, cannot be protected by rock aprons or riprap sections due to re-concentration of flows and high velocities encountered after the flow leaves the apron.

Many counties and state agencies have regulations and design procedures already established for dimensions, type and size of materials, and locations where outlet protection is required. Where these requirements exist, they shall be followed.

1. Investigate the downstream channel to assure that nonerosive velocities can be maintained.
2. Determine the tailwater condition at the outlet to establish which design criteria to use.
3. Enter the appropriate chart with the design discharge to determine the riprap size and apron length required. It is noted that references to pipe diameters in the charts are based on full flow. For other than full pipe flow, the parameters of depth of flow and velocity must be used to adjust the design discharges.
4. Calculate apron width at the downstream end if a flare section is to be employed.

Tailwater Depth

The depth of tailwater immediately below the pipe outlet must be determined for the design capacity of the pipe.

- If the tailwater depth is less than half the diameter of the outlet pipe, and the receiving stream is wide enough to accept divergence of the flow, it shall be classified as a Minimum Tailwater Condition; see Figure 1 as an example.
- If the tailwater depth is greater than half the pipe diameter and the receiving stream will continue to confine the flow, it shall be classified as a Maximum Tailwater Condition; see Figure 2 as an example.
- Pipes which outlet onto flat areas with no defined channel may be assumed to have a Minimum Tailwater Condition; see Figure 1 as an example.

Apron Size

- The apron length and width shall be determined from the curves according to the tailwater conditions:
 - Minimum Tailwater – Use Figure 1
 - Maximum Tailwater – Use Figure 2
- If the pipe discharges directly into a well defined channel, the apron shall extend across the channel bottom and up the channel banks to an elevation one foot above the maximum tailwater depth or to the top of the bank, whichever is less.
- The upstream end of the apron, adjacent to the pipe, shall have a width two (2) times the diameter of the outlet pipe, or conform to pipe end section if used.

Bottom Grade

- The outlet protection apron shall be constructed with no slope along its length.

- There shall be no overfall at the end of the apron.
- The elevation of the downstream end of the apron shall be equal to the elevation of the receiving channel or adjacent ground.

Alignment

The outlet protection apron shall be located so that there are no bends in the horizontal alignment.

Materials

- The outlet protection may be done using rock riprap, grouted riprap, or gabions.
- Riprap shall be composed of a well-graded mixture of aggregate size so that 50 percent of the pieces, by weight, shall be larger than the d_{50} size determined by using the charts. A well-graded mixture, as used herein, is defined as a mixture composed primarily of larger aggregate sizes, but with a sufficient mixture of other sizes to fill the smaller voids between the aggregates. The diameter of the largest aggregate size in such a mixture shall be 1.5 times the d_{50} size.

Thickness

The minimum thickness of the riprap layer shall be 1.5 times the maximum aggregate diameter for d_{50} of 15 inches or less; and 1.2 times the maximum aggregate size for d_{50} greater than 15 inches. The following chart lists some examples:

d_{50} (inches)	d_{max} (inches)	Minimum Blanket Thickness (inches)
4	6	9
6	9	14
9	14	20
12	18	27
15	22	32
18	27	32
21	32	38
24	36	43

Aggregate Quality

- Aggregate for riprap shall consist of field stone, rough unhewn quarry stone, crushed concrete, or other similar material. The aggregate shall be hard and angular and of a quality that will not disintegrate on exposure to water or weathering.
- The specific gravity of the individual aggregates shall be at least 2.5.
- Recycled concrete equivalent may be used provided it has a density of at least 150 pounds per cubic foot, and does not have any exposed steel or reinforcing bars.

Filter Blanket

- A filter blanket is a layer of material placed between the riprap and the underlying soil surface to prevent soil movement into and through the riprap. Riprap shall have a filter blanket placed under it in all cases. A filter blanket can be of two general forms: a gravel layer or a nonwoven geotextile filter.
- Gravel filter blanket shall be designed by comparing particle sizes of the overlying material and the base material. Design criteria are available in Standard and Specification for Riprap - Slope Protection.

- A nonwoven geotextile filter (aka. Filter fabric, geotextile liner, filter cloth) should have properties as identified below:

Aggregate Size	Grab Tensile Strength (min.)	Trapezoidal Tear Strength (min.)	Puncture Strength (min.)	Mullen Burst Strength (min.)	Permittivity	Apparent Opening Size (max.)
in.	ASTM D4632	ASTM D4533	ASTM D4833	ASTM D4833	ASTM D4491	ASTM D4751
	lbs	lbs	lbs	lbs	per second	mm
<16	200	75	75	200	0.5	0.21
16-24	270	100	100	400	0.5	0.21
>24	*	*	*	*	*	*

***As directed by engineer**

Gabions

- Gabions shall be made of hexagonal triple twist mesh with heavily galvanized steel wire. The maximum linear dimension of the mesh opening shall not exceed 4 ½ inches and the area of the mesh opening shall not exceed 10 square inches.
- Gabions shall be fabricated in such a manner that the sides, ends, and lid can be assembled at the construction site into a rectangular basket of the specified sizes. Gabions shall be of single unit construction and shall be installed according to manufacturer's recommendations.
- The area on which the gabion is to be installed shall be graded as shown on the drawings. Foundation conditions shall be the same as for placing rock riprap, and filter cloth shall be placed under all gabions. Where necessary, key, or tie, the structure into the bank to prevent undermining of the main gabion structure.

Construction Guidelines

1. The subgrade for the filter, riprap, or gabion shall be prepared to the required lines and grades. Any fill required in the subgrade shall be compacted to a density of approximately that of the surrounding undisturbed material.
2. The rock or gravel shall conform to the specified grading limits when installed respectively in the riprap or filter.
3. Filter cloth shall be protected from punching, cutting, or tearing. Any damage other than an occasional small hole shall be repaired by placing another piece of cloth over the damaged part or by completely replacing the cloth. All overlaps, whether for repairs or for joining two pieces of cloth shall be a minimum of one foot.
4. Aggregate for the riprap or gabion outlets may be placed by equipment. Both shall each be constructed to the full course thickness in one operation and in such a manner as to avoid displacement of underlying materials. The aggregate for riprap or gabion outlets shall be delivered and placed in a manner that will ensure that it is reasonably homogenous with the smaller aggregates and spalls filling the voids between the larger aggregates. Riprap shall be placed in a manner to prevent damage to the filter blanket or filter

cloth. Hand placement will be required to the extent necessary to prevent damage to the permanent works.

Monitoring

- Inspect after high flows for evidence of undermining, scour, and/or dislodged aggregates.

Maintenance

- Once a riprap outlet has been installed, the maintenance needs are very low.

References

New York Standards and Specifications For Erosion and Sediment Control

Figure 1. Outlet Protection Design—Minimum Tailwater Condition
Design of Outlet Protection from a Round Pipe Flowing Full,
Minimum Tailwater Condition: $T_w < 0.5D_o$ (USDA - NRCS)

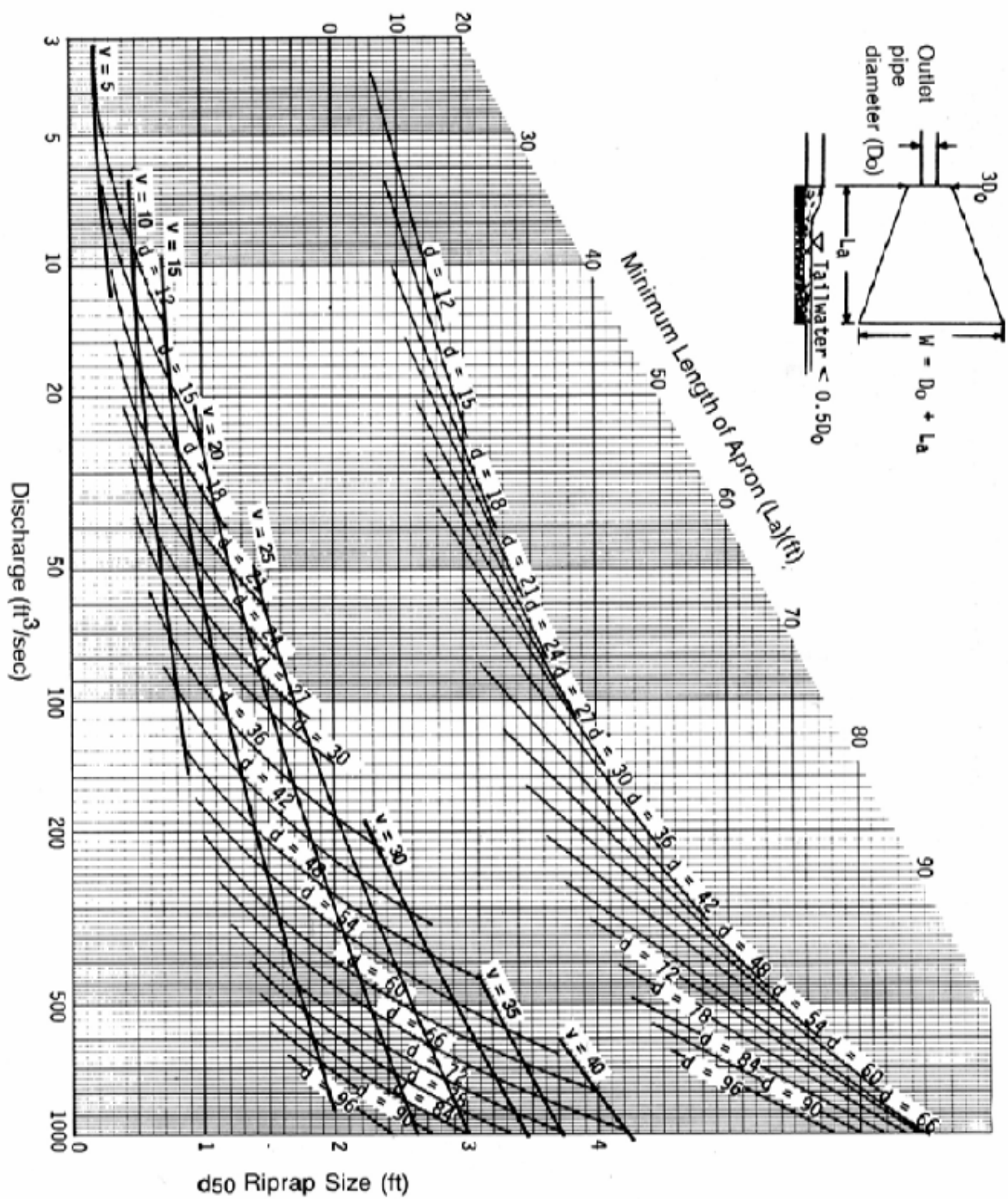

Figure 2. Outlet Protection Design—Maximum Tailwater Condition
Design of Outlet Protection from a Round Pipe Flowing Full,
Maximum Tailwater Condition: $T_w \geq 0.5D_o$ (USDA - NRCS)

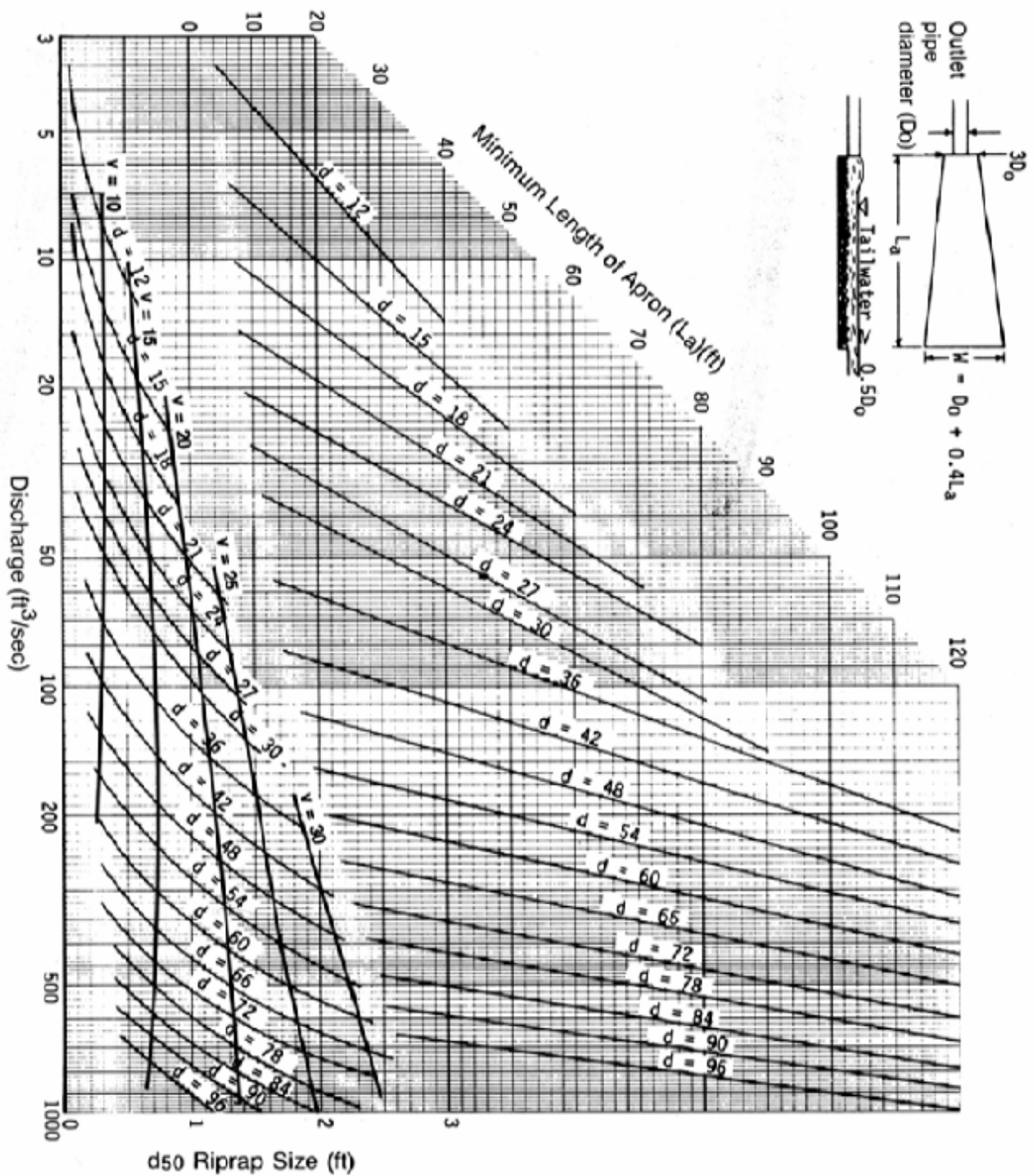

Figure 3. Riprap Outlet Protection Detail—1 of 3

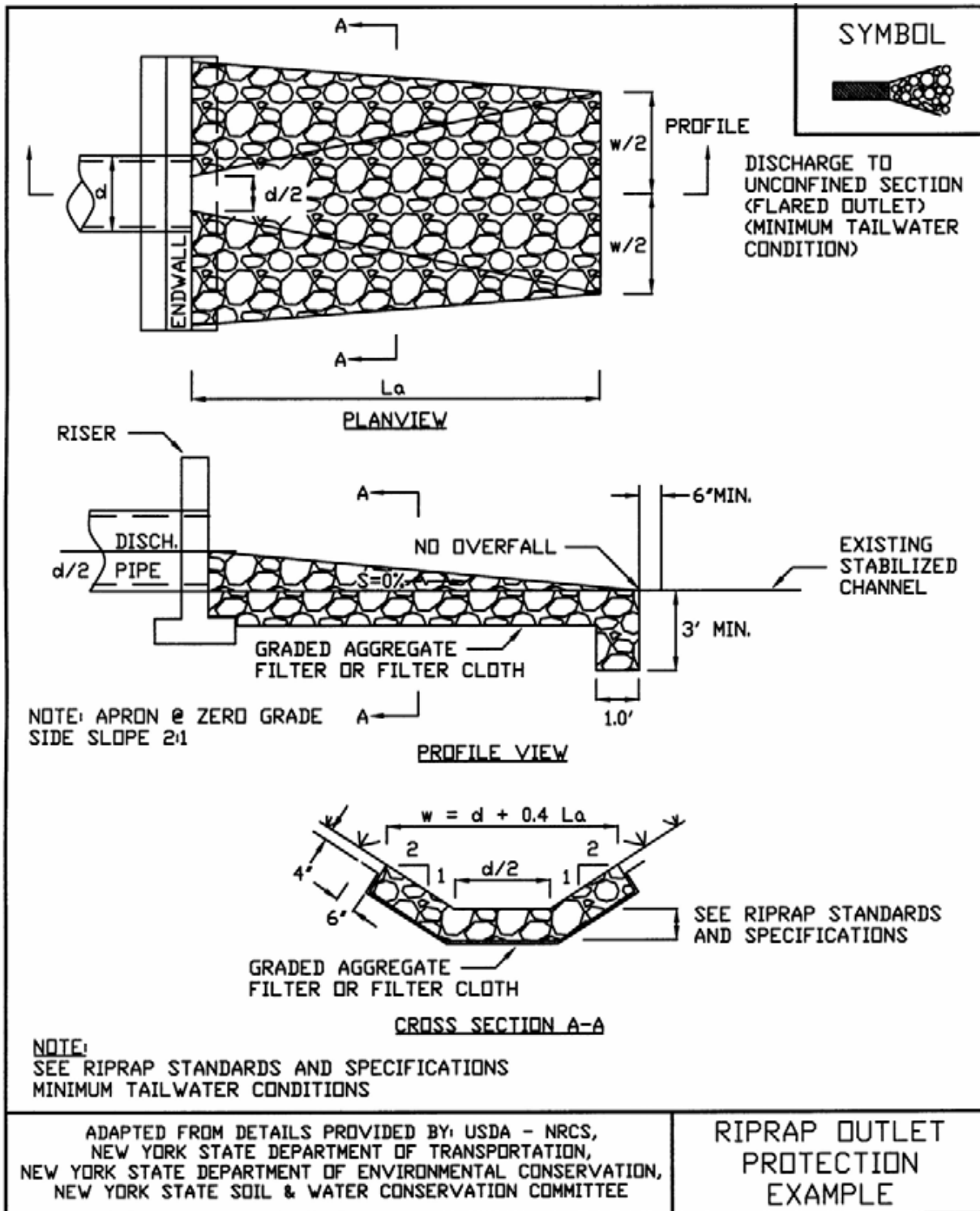

Figure 4. Riprap Outlet Protection Detail—2 of 3

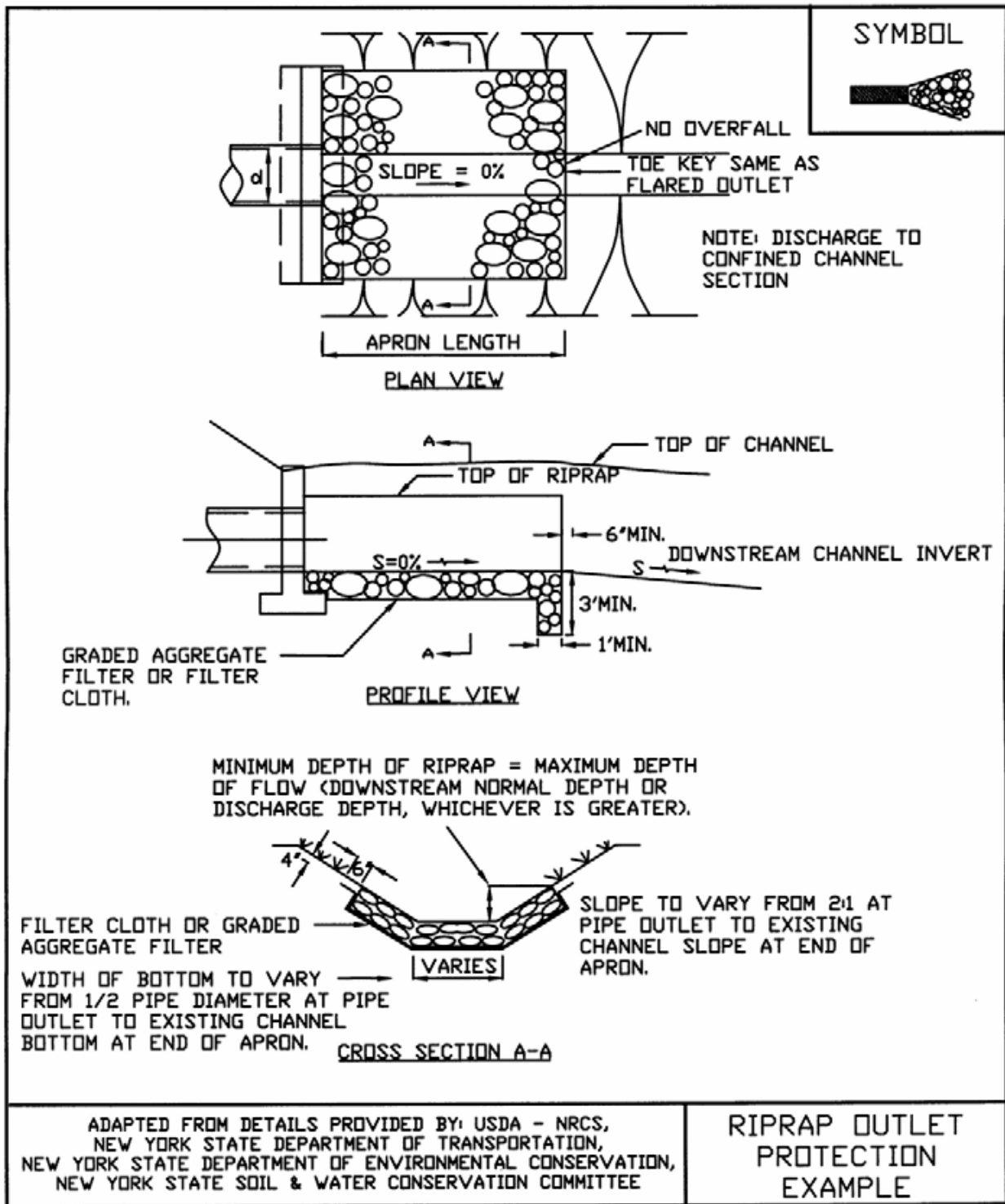

Figure 5. Riprap Outlet Protection Detail—3 of 3

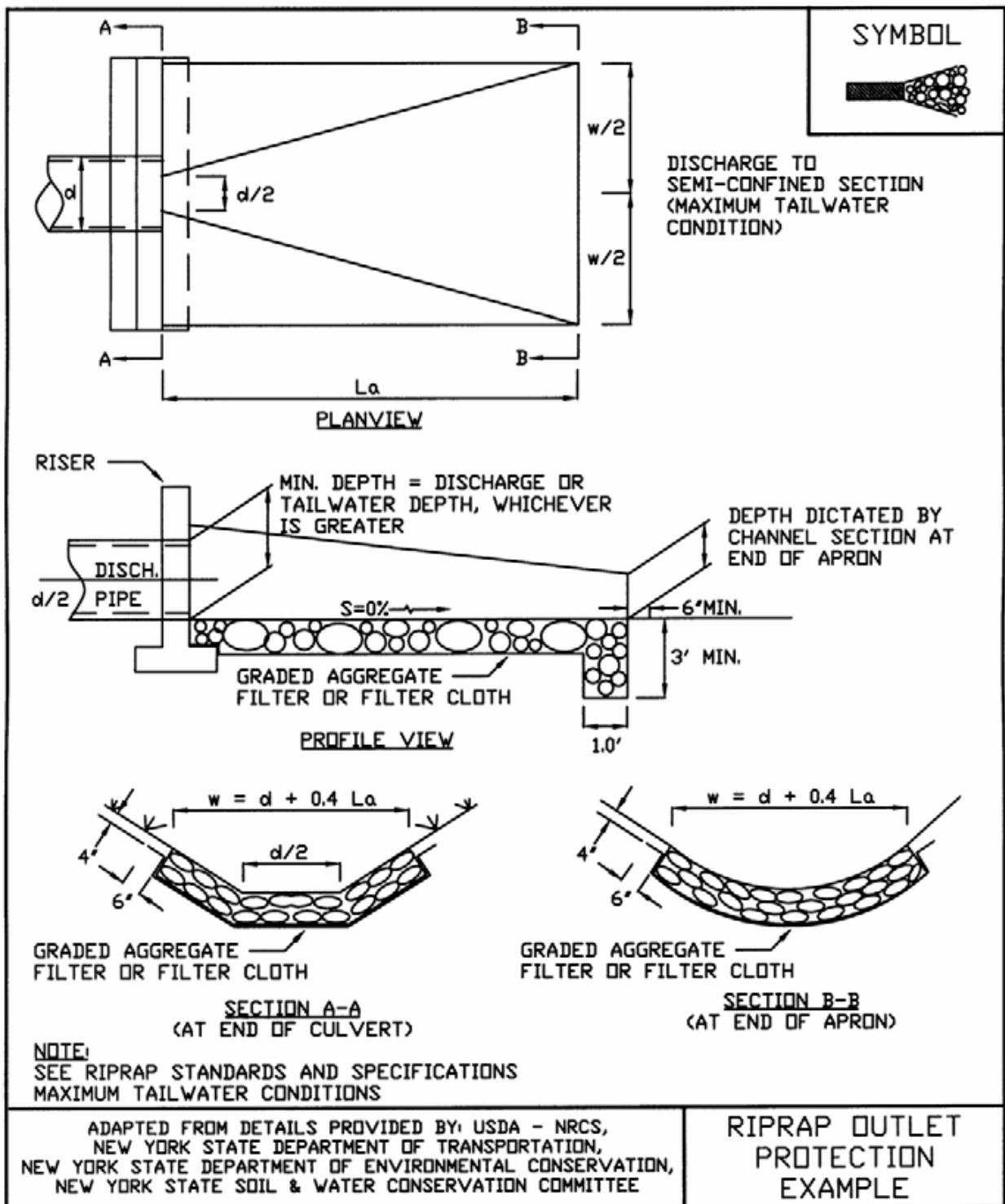
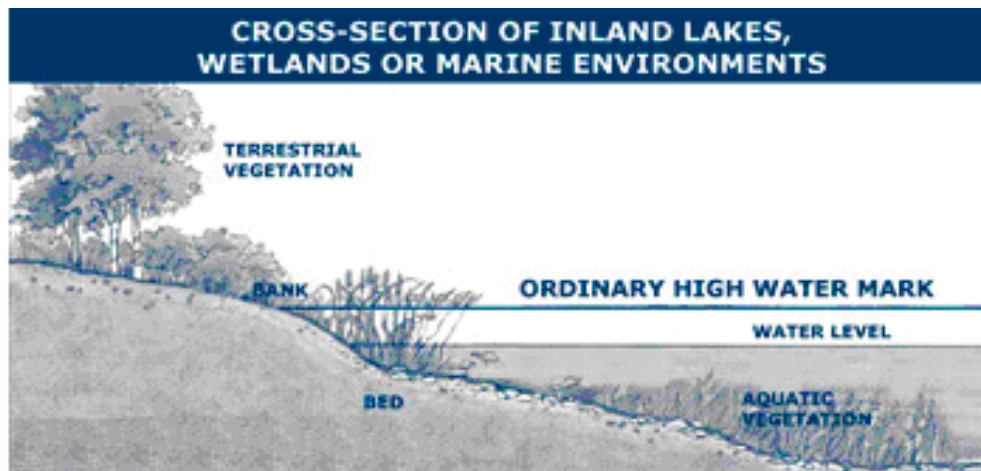
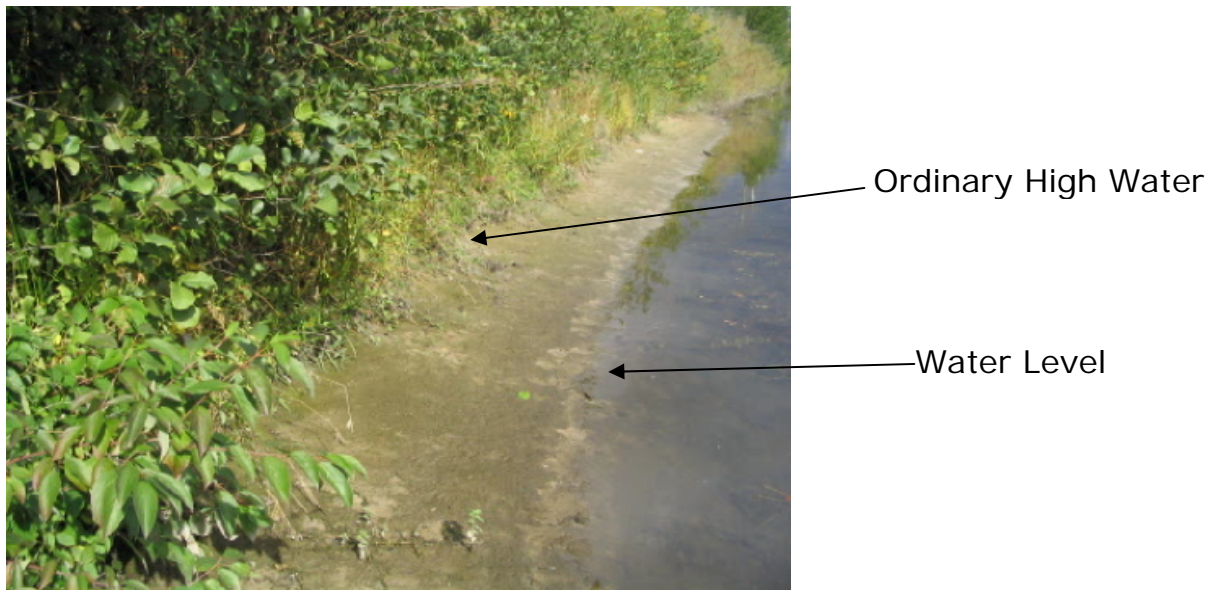

Figure 6. Ordinary High Water Mark



“Ordinary High Water Mark” means the line between upland and bottomland that persists through successive changes in water levels, below which the presence and action of the water is so common or recurrent that the character of the land is marked distinctly from the upland and is apparent in the soil itself, the configuration of the surface of the soil, and the vegetation. On a lake that has a level established by law, it means the high established level. Where water returns to its natural level as the result of the permanent removal or abandonment of a dam, it means the natural ordinary high-water mark.



Rolled Erosion Control Products

Definition

Rolled erosion control products (RECPs) consist of prefabricated blankets or netting which are formed from both natural and synthetic materials.

Description and Purpose

The predominantly used RECPs generally fall into the following two categories, each having unique characteristics:

- Erosion control blanket: A temporary degradable rolled erosion control product composed of processed natural or polymer fibers mechanically, structurally or chemically bound together to form a continuous matrix to provide erosion control and facilitate vegetation establishment.
- Turf reinforcement mat (TRM): A rolled erosion control product composed of non-degradable synthetic fibers, filaments, nets, wire mesh and/or other elements, processed into a permanent, three-dimensional matrix. TRMs, which may be supplemented with degradable components, are designed to provide immediate erosion protection, enhance vegetation establishment and provide long-term functionality by permanently reinforcing vegetation during and after maturation. Note: TRMs are typically used in hydraulic applications, such as high flow ditches and channels, steep slopes, stream banks, and shorelines, where erosive forces may exceed the limits of natural, unreinforced vegetation or in areas where limited vegetation establishment is anticipated.

The practice may also be called Erosion Control Blanket, Mulch Blanket, Erosion Control Matting

Pollutant(s) controlled:

- Suspended Sediment

Companion and Alternative BMPs

- Seeding/Vegetation Page # BMP Guidebook
- Mulching

Advantages and Disadvantages

Advantages:

- Can provide for some degree of immediate stabilization
- Numerous manufacturers, each with a number of different products, allow for the selection of a product which meets the individual characteristics of each site.
- Stabilizes disturbed slope and protects surface from erosive forces of raindrop impact.

- Promotes growth of vegetation.
- Most products degrade over time, eliminating potential maintenance issue.

Disadvantages:

- Various products and manufacturers have different design and construction standards. Designer must rely on manufacturer's data.
- Permanent stabilization and protection is dependent on the establishment of vegetation unless TRMs are used.

Location

Rolled erosion control products should be used on bare ground that is highly susceptible to erosion, such as steep slopes and channels, and in locations where establishing vegetation may otherwise be difficult.

General Characteristics

- Several factors, such as soil conditions, steepness and length of slope, depth of flow, runoff velocities, and time required to establish desired vegetation, influence the choice of product.
- RECPs and TRMs are manufactured from a wide variety of different materials including coconut fiber (coir), jute, nylon, polypropylene, PVC, straw, hay, or wood fibers. These materials may be used individually, or in combination to form nets or blankets.
- The products function by protecting the ground surface from the impact of raindrops and stabilize the surface until vegetation can be established. RECPs and TRMs also promote the growth of vegetation by helping to keep seed in place, and by maintaining a consistent temperature and moisture content in the soil.
- Most RECPs are either biodegradable or photodegradable and will decompose over a period of time.
- RECPs should generally be installed parallel to the direction of water flow.

Materials

- Seed
- Fertilizer
- RECP
- Degradable Stakes/Pegs/Pins

Design Specifications

- RECPs are produced by a number of manufacturers, and are available in a wide variety of different configurations. Competing products from different manufacturers can have completely different material compositions and construction, but be intended to serve the same purpose. Given the wide variety of RECPs available, product selection and specification can be difficult. Fortunately, the Erosion Control Technology Council (ECTC) has developed a uniform product selection guide for RECPs.

- Table 1 is modified from the product selection guide produced by the ECTC and classifies products based upon longevity and product description.
- Factors such as the slope on which the RECP is to be placed and the sheer stress that the RECP will experience shall be used to determine which RECP product is adequate for the application it is intended for.
- Stake placement and installation should follow manufacturer recommendations

Construction Guidelines

1. Prior to placing a RECP, a topsoil seedbed should be prepared, smooth graded, and seeded and fertilized. It is imperative that seeding occur prior to placement of the RECP to ensure proper contact between seed and soil. Some manufacturers can embed the specified seed mixture into the product during the manufacturing process (if this process is used, follow the manufacturer's recommended installation specifications).
2. After seeding, the appropriate RECP may be placed and anchored with stakes or staples. The manufacturer will provide specifications for the pattern and spacing of anchor stakes or staples, overlap between rolls (typically 6 inches), and any additional product requirements.
3. It is important that the stakes or staples be properly installed to prevent "tenting" of the product as the vegetation begins to grow and push up on the matting. This can impact vegetative establishment and the product can become entangled in mowing equipment.
4. At the tops of slopes and at the entrance to a channel, the leading edge of the RECP should be trenched into the ground, approximately 6 inches, anchored in place with stakes or staples, and backfilled. This prevents runoff from lifting the leading edge, and flowing between the ground and the RECP.
5. Subsequent segments of RECPs should have their upstream edges trenched in, and the downstream edge should slightly overlap the next section to prevent water from flowing under the product.

Monitoring

Inspect weekly and after every storm event that results in a discharge from the site until adequate vegetation is established.

Maintenance

- Repair erosion and/or undermining at the top of the slope.
- Repair undermining beneath RECP(s), pull back the RECP(s), fill and compact eroded area, reseed and then secure RECP(s) firmly.
- Reposition or replace RECPs that have moved along the slope or channel and secure firmly.
- Replace damaged RECPs.

References

Erosion Control Technology Council Standard Specification for Rolled Erosion Control Products, 2006.

Statewide Urban Design and Specifications, Design Manual 7E-7 10/21/2008
Ontario, Rolled Erosion Control Product (RECP) BMP 11

Table 1:

RECP Product Comparison

SHORT-TERM - Typical 3 - 12 month functional longevity				
Type	Product Description	Material Composition	Slope Applications*	Channel Applications*
			Maximum Gradient	Max. Shear Stress ^{1,2,3}
1.A	Single-net Erosion Control Blankets & Open Weave Textiles	Processed degradable natural and/or polymer fibers mechanically bound together by a single rapidly degrading, synthetic or natural fiber netting or an open weave textile of processed rapidly degrading natural or polymer yarns or twines woven into a continuous matrix.	3:1 (H:V)	1.5 lbs/ft ² (72 Pa)
1.B	Double-net Erosion Control Blankets	Processed degradable natural and/or polymer fibers mechanically bound together between two rapidly degrading, synthetic or natural fiber nettings.	2:1 (H:V)	1.75 lbs/ft ² (84 Pa)
EXTENDED-TERM - Typical 24 month functional longevity				
Type	Product Description	Material Composition	Slope Applications*	Channel Applications*
			Maximum Gradient	Max. Shear Stress ^{1,2,3}
2.A	Erosion Control Blankets & Open Weave Textiles	An erosion control blanket composed of processed slow degrading natural or polymer fibers mechanically bound together between two slow degrading synthetic or natural fiber nettings to form a continuous matrix or an open weave textile composed of processed slow degrading natural or polymer yarns or twines woven into a continuous matrix.	1.5:1 (H:V)	2.00 lbs/ft ² (96 Pa)
LONG-TERM - Typical 36 month functional longevity				
Type	Product Description	Material Composition	Slope Applications*	Channel Applications*
			Maximum Gradient	Max. Shear Stress ^{1,2,3}
3.A	Erosion Control Blankets & Open Weave Textiles	An erosion control blanket composed of processed slow degrading natural or polymer fibers mechanically bound together between two slow degrading synthetic or natural fiber nettings to form a continuous matrix or an open weave textile composed of processed slow degrading natural or polymer yarns or twines woven into a continuous matrix.	1:1 (H:V)	2.25 lbs/ft ² (108 Pa)

¹ Required minimum shear stress RECP (unvegetated) can sustain without physical damage or excess erosion (> 12.7 mm (0.5 in) soil loss) during a 30-minute flow event in large-scale testing.

² The permissible shear stress levels established for each performance category are based on historical experience with products characterized by Manning's roughness coefficients in the range of 0.01 - 0.05.

³[Acceptable large-scale test methods may include ASTM D 6459, or other independent testing deemed acceptable by the engineer.](#)

Table 2 ECTC Standard Specification for Permanent Rolled Erosion Control Products

For applications where vegetation alone will not sustain expected flow conditions and/or provide sufficient long-term erosion protection.

PERMANENT¹ - All categories of TRMs must have a minimum thickness of 0.25 inches (6.35 mm) per ASTM D 6525 and U.V. stability of 80% per ASTM D 4355 (500 hours exposure).				
			Slope Applications	Channel Applications
Type	Product Description	Material Composition	Maximum Gradient	Maximum Shear Stress^{1,2}
4.A	Turf Reinforcement Mat	Turf Reinforcement Mat (TRM) – A rolled erosion control product composed of non-degradable synthetic fibers, filaments, nets, wire mesh and/or other elements, processed into a permanent, three-dimensional matrix of sufficient thickness. TRMs, which may be supplemented with degradable components, are designed to impart immediate erosion protection, enhance vegetation establishment and provide long-term functionality by permanently reinforcing vegetation during and after maturation. Note: TRMs are typically used in hydraulic applications, such as high flow ditches and channels, steep slopes, stream banks, and shorelines, where erosive forces may exceed the limits of natural, unreinforced vegetation or in areas where limited vegetation establishment is anticipated.	0.5:1 (H:V)	6.0 lbs/ft ² (288 Pa)
4.B	Turf Reinforcement Mat		0.5:1 (H:V)	8.0 lbs/ft ² (384 Pa)
4.C	Turf Reinforcement Mat		0.5:1 (H:V)	10.0 lbs/ft ² (480 Pa)

¹ Required minimum shear stress TRM (fully vegetated) can sustain without physical damage or excess erosion (> 12.7 mm (0.5 in.) soil loss) during a 30-minute flow event in large scale testing.

² Acceptable large-scale testing protocol may include ASTM D 6460, or other independent testing deemed acceptable by the engineer.

Source: Modified from Erosion Control Technology Council Standard Specification for Rolled Erosion Control Products, 2006.

Exhibit 1:

Rolled Erosion Control Product Channel Installation

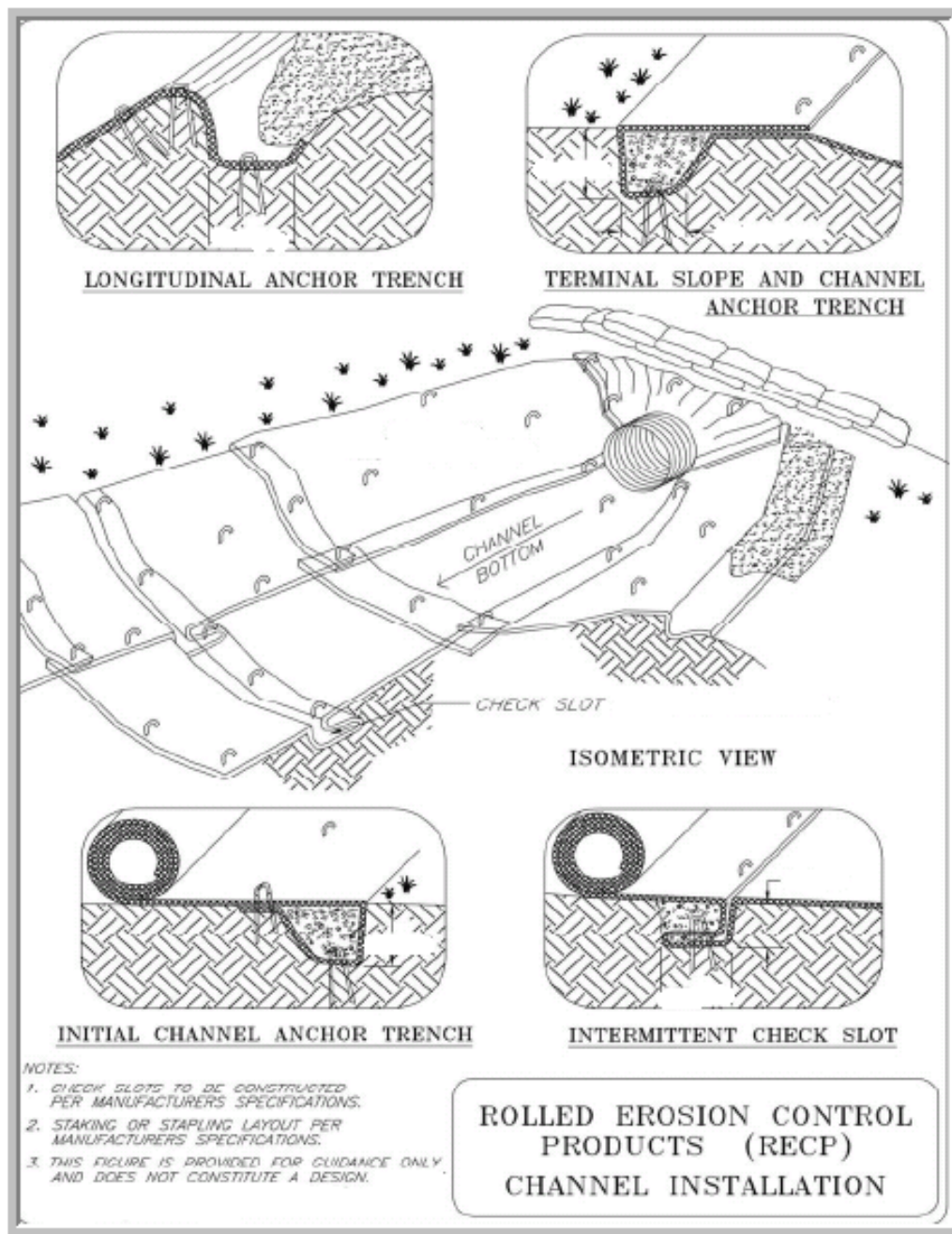

Source: Ontario, Rolled Erosion Control Product (RECP) BMP 11

Exhibit 2:

Rolled Erosion Control Product Slope Installation

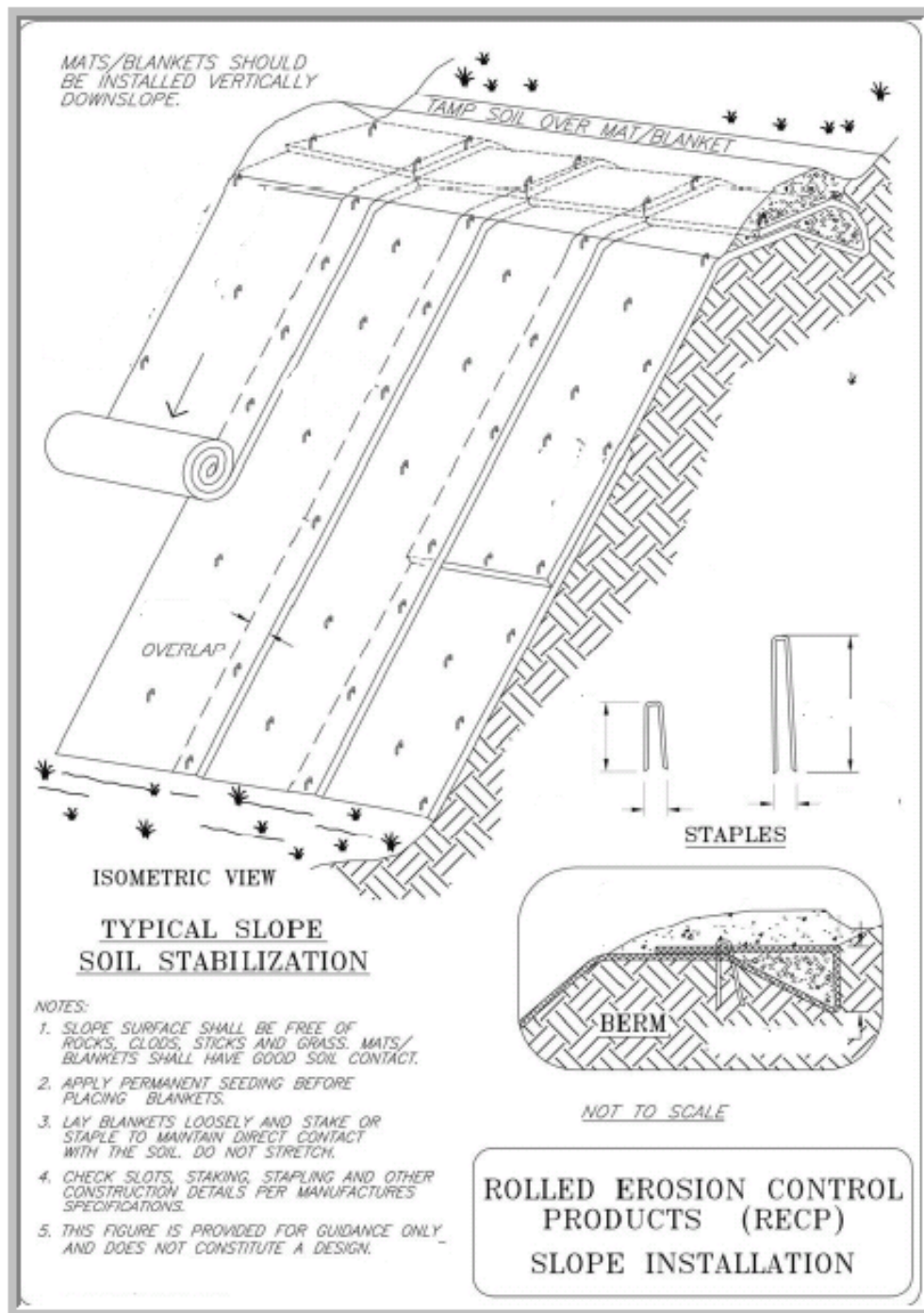

Source: Ontario, Rolled Erosion Control Product (RECP) BMP 11

Diversions

Definition

A diversion is a temporary ridge or excavated channel or combination ridge and channel constructed to divert concentrated and sheet surface water, and possibly subsurface water, from or around areas under construction or development, to sites where it can be used or disposed of.

Description and Purpose

Diversion structures consist of ridges or channels that are used to temporarily divert water around or from an area that is under construction or is being stabilized. Specific applications include perimeter control, diversion away from disturbed slopes, and diversion of sediment-laden water to treatment facilities.

The practice may also be called Interceptor, Berms, or Dikes

Pollutant(s) controlled:

- Suspended sediment

Companion and Alternative BMPs

- Riprap - Stabilized Outlet
- Rolled Erosion Control Products
- Seeding/Vegetation Page # BMP Guidebook
-

Advantages and Disadvantages

Advantages:

- Reduces the volume of flow across disturbed areas, thereby reducing the potential for erosion.
- Breaks up concentration of water on long slopes.
- Maintaining a separation between clean water and sediment-laden water allows sediment basins and traps to function more efficiently.

Disadvantages:

- High flow velocities can cause erosion in the diversion structure.
- Diversion structures must be stabilized immediately after installation.
- Easily constructed with equipment found on most construction sites and thus often improperly designed

Location

Diversions are used where:

- Runoff from higher areas has potential for damaging properties, causing erosion, or interfering with, or preventing the establishment of, vegetation on lower areas.
- Surface and/or shallow subsurface flow is damaging sloping upland.

- The length of slopes needs to be reduced so that soil loss will be kept to a minimum.

General Characteristics

- **All diversions should be designed by a Licensed Professional Engineer**
- Areas above a diversion should be stabilized with other BMPs to prevent excessive sediment from accumulating in the diversion channel.
- Channel dimensions should be adapted for the equipment that will be used to maintain the diversion.
- The length of the diversion is often fixed by the availability of stabilized outlets.
- To prevent scour or excessive seepage a stabilized outlet should be constructed.

Materials

- Seed
- Rolled erosion control products
- Riprap

Design Specifications

- **Capacity.** Diversion channels designed to protect areas such as minor buildings and roads should have enough capacity to carry the peak runoff expected from a 25-year frequency, 24-hour duration storm. Diversions designed to protect major structures, homes, school buildings and high capacity roads should have enough capacity to carry the peak runoff from a 100-year frequency 24-hour duration storm.
- **Channel Shape.** The channel may be parabolic or trapezoidal in shape. The diversion must be designed to have stable side slopes. A ridge placed on the downstream side of the channel must be high enough to keep the runoff in the channel without overtopping. The ridge height should provide at least 6 inches of freeboard and a settlement allowance of 10%. The ridge shall have a minimum top width of 4 feet
- **Velocity.** Channel velocity shall not exceed what is considered non-erosive for the soil and planned stabilization. Table 1 shows maximum permissible velocities for vegetated channels. Rolled Erosion Control Products can be used in conjunction with vegetation to provide stabilization at increased velocities.
- **Channel Slope.** Runoff Diversion channels must be graded to prevent water standing long enough to drown vegetation in the channel. If possible design velocities greater than 1.5 feet per second should be used to avoid sediment accumulation in the channel. Steeply sloped channels that generate flow velocities greater than 2.5 feet per second will require some type of lining material other than vegetation.
- **Channel Lining.** Channel lining materials may include one or a combination of the following materials: vegetation, synthetic erosion control mats (ECM) or turf reinforcement mats (TRM), rock or concrete, as determined by a licensed Engineer.

- **Outlets.** Diversion channels must be able to deliver the runoff to a stable outlet, at a point where outflow will not cause damage. Some type of outlet structure or special lining over the outlet section of the diversion channel may be required

Construction Guidelines

1. All ditches or gullies shall be filled, and trees and other obstructions shall be removed before construction begins or shall be part of the construction.
2. If underground conduits are located under or through diversions, mechanical compaction, water packing, and installation and backfill of conduit trenches shall be made in advance to allow adequate settlement.
3. Diversion ridges constructed across gullies or depressions shall be compacted to a uniform grade to ensure proper functioning of the diversion.
4. Seeded areas need protection during establishment and will be mulched or covered with rolled erosion control products
5. Diversions must be completely stabilized prior to directing runoff to them.
6. Once soil is exposed for a diversion channel, it should be immediately shaped, graded and stabilized.
7. Vegetated diversions need to be stabilized early during the growing season (prior to October 1). If final seeding of diversions is delayed past October 1, other stabilization measures, such as rolled erosion control products or riprap may be required to stabilize the channel.

Monitoring

Inspect weekly and following each storm event.

Maintenance

- Remove debris and sediment from the channel and rebuild and stabilize the ridge as needed.
- Check outlets and make necessary repairs immediately.
- If sediment traps are used as a performance enhancer, remove sediment from traps when they are 50 percent full.
- When the work area has been stabilized, remove the ridge and fill in the channel to blend with the natural ground. Remove temporary slope drains and stabilize all disturbed areas with vegetation or other erosion control practices.

References

Maine Erosion and Sediment Control BMP, 3/2003. Water Diversion
Dyersburg, Tennessee Erosion Control Handbook. Diversions

Table 1:

Diversion Maximum Permissible Design Velocities

Soil Texture	Retardance and Cover	Permissible Velocity (ft / second) for Selected Channel Vegetation
Sand, Silt, Sandy loam, silty loam, loamy sand (ML, SM, SP, SW)	C-Kentucky 31 tall fescue and Kentucky bluegrass	3.0
	D-Annuals ¹ Small grain (rye, oats, barley, millet) Ryegrass	2.5
Silty clay loam, Sandy clay loam (ML-CL, SC)	C-Kentucky 31 tall fescue and Kentucky bluegrass	4.0
	D-Annuals ¹ Small grain (rye, oats, barley, millet) Ryegrass	3.5
Clay (CL)	C-Kentucky 31 tall fescue and Kentucky bluegrass	5.0
	D-Annuals ¹ Small grain (rye, oats, barley, millet) Ryegrass	4.0

¹ Annuals—Use only as temporary protection until permanent vegetation is established.

Exhibit 1:

Typical Diversion Cross-Sections

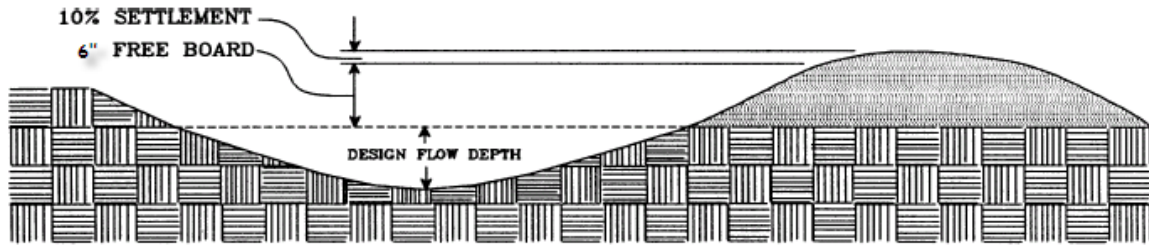

Typical Parabolic Diversion

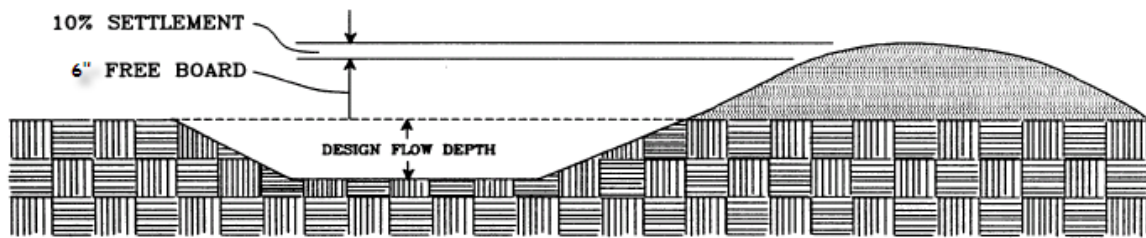

Typical Trapezoidal Diversion

Sediment Basin

Definition

A sediment basin is a temporary pond built on a construction site to capture eroded or disturbed soil that is washed off during rain storms, protect neighboring properties, and protect the water quality of a nearby stream, river, lake, wetland or bay.

Description and Purpose

Sediment basins collect and store runoff to allow suspended solids to settle out prior to leaving the site. The primary purpose of sediment basins is to prevent sediment laden runoff from reaching lakes, streams and wetlands.

The practice may also be called settling basins, sumps, debris basins, dewatering basins.

Pollutant(s) controlled:

- Suspended solids

Treatment Mechanisms:

- Settling causes coarse and medium size particles to settle out in the basin

Pollution Removal Efficiencies:

- Sediment basins are not effective in controlling fine particles (i.e. silt, clay)
- Sediment basins remove only 70-80 percent of large sized sediment particles and so should be used in conjunction with other erosion control BMP's.

Companion and Alternative BMPs

- Riprap – Stabilized Outlet

Advantages and Disadvantages

Advantages:

- Cost effective measure for treating sediment laden runoff
- Relatively easy to construct

Disadvantages:

- There must be adequate space and topography for the basin to be constructed and for it to function properly.
- Sediment basins must be installed only within the property or special easement limits and where failure of the structure will not result in loss of life, damage to homes or buildings, or interruption of use or service of public roads or utilities.
- Sediment basins are attractive to children and can be very dangerous. Local ordinances regarding health and safety must be adhered to. If fencing of the basin is required, the type of fence and its location should be shown in the SESC plan and in the construction specifications

- Sediment basins are only practically effective in removing sediment down to about the medium silt size fraction. Sediment-laden runoff with smaller size fractions (fine silt and clay) may not be adequately treated unless chemical treatment is used in addition to the sediment basin.
- Standing water may cause mosquitoes or other pests to breed.
- Basins require large surface areas to permit settling of sediment. Size may be limited by the available area.

Location

- Sediment basins are utilized in areas of concentrated flow or points of discharge during construction activities.
- Sediment basins shall be constructed at locations accessible for clean out.
- Site conditions must allow for runoff to be directed into the basin.
- Do not locate sediment basins in perennial streams or wetlands. In-stream sediment basins are only allowed upon permit by the DEQ, Water Resources Division.

General Characteristics

- **Sediment basins should be designed by Licensed Professional Engineers**
- Sediment basins are designed to be in place until the contributory drainage area has been stabilized.
- Sediment basins are temporary and serve drainage areas up to 100 acres however other conservation practices are often more economical for smaller drainage areas.
- Sediment basins should be four times longer than wide (unless baffles are used to increase the flow length)
- The basin depth should be a minimum of two feet deep and no shallower than the average distance from the inlet to the outlet (length) divided by 200.

Materials

- Earth
- Riprap
- Risers
- Collars
- Seed for stabilization of disturbed soil.

Design Specifications

- Conduct a site investigation to determine the size of the drainage area and the best location for the basin or basins.
- Determine soil types. (If the soils are predominantly clay, the basin size required may be larger than practical. However, if soils are sand or silts there will be little structural integrity of the basin if constructed with on-site soils. With clay soils it is particularly important to make the best use of soil erosion control measures, because sedimentation measures, including sediment basins, do not readily retain clays.)

- Select the site for the sediment basin based on the natural drainage of the area and the soil type.
 - Determine the number of basins needed. In some cases, it is more effective to have a number of smaller basins rather than on large basin. This is particularly important in areas with larger-grained sediments. In addition, the damage caused by one small basin which fails is much less than the damage caused by one large basin which fails.
 - The area(s) chosen should be such that runoff can be easily diverted to the basin. The most logical location is usually at the lower end of the drainage area.
 - The discharge from basins should approximate the pre-development runoff from the site.
 - Where necessary, the site(s) should also easily accommodate periodic clean-outs.
 - Determine the ultimate fate of the basin. If the basin is to become part of a storm water runoff "treatment train" upon completion, then the design of the basin must be coordinated with the design of the "future use" of the basin. If the ultimate fate of the basin is an infiltration basin, avoid using heavy equipment in the area so as not to compact the soils. Soils compaction will decrease the ability of the soil to infiltrate water. If the basin is to be a temporary structure which will be filled and stabilized upon completion of the project, then proceed with the design criteria below.
- Select the appropriate type of basin based on the information below:
 - There are three classes of sediment basins. Classification is based on:
 1. The maximum drainage area a basin serves
 2. The height of the dam
 3. The extent of the mechanical control devices provided with a basin
 - If the basin is to be a temporary structure, choose between Class 1 and Class 2 basins. If the structure is to be permanent, then choose between the Class 2 and Class 3 basin and remember that the design criteria for both the sediment basin and the storm water basin must be met.
 1. Class 1: This is a simple temporary basin, frequently used on construction sites. This basin consists of an excavated area or an earth embankment or dam less than 3 feet high constructed of the soil or stone which is available on the site. These basins can be quickly located and constructed with equipment available on most construction sites. Stabilization of the embankment with vegetation or paving is necessary. Maximum drainage is 20 acres.
 2. Class 2: This is a carefully constructed temporary or permanent sediment basin. It consists of an embankment of selected soil materials constructed under controlled procedures, with provisions for an emergency discharge for storm water to prevent embankment failure. A class 2 basin is most applicable in situation where significant damage can result to downstream and off-site areas if the basin should fail. Maximum drainage is 30 acres.
 3. Class 3: Class 3 basins have carefully engineered, sophisticated controls and are usually permanent. Both spillways and embankments are intended to serve as grade stabilization structures which will continue to function as storm water control

measures after construction activities are completed. A Class 3 basin should always be constructed if a basin is to be converted to a permanent storm water detention site. **Class 3 basins must be restored to original design specifications prior to conversion to a storm water control.** The maximum drainage is 100 acres.

- The basin should be stabilized before the upstream area is cleared
- Disposal sites for the sediment removed from the basin should be incorporated into the overall site plan.
- Sediment basins with dams over six feet in height or more and impounding five or more surface acres, are regulated under the Dam Safety Act. Other permits may also be needed.
- The effectiveness in reducing in-stream velocity and allowing suspended solids to settle out depends on the:
 - Surface area of the basin. In general the greater the area, the greater the detention time and the less the flow velocity
 - Size of the particles coming into the basin
 - Concentration of particles coming into the basin
 - Rate of flow into the basin
 - Volume. As sediment accumulates, the volume decreases (as does the effectiveness of the basin)
 - Travel distance
- **Temporary structures** should be designed with an expected life of no more than 3 years. Structures which will be in place longer than that should be designed as permanent structures (i.e. have emergency spillways).
- **Side Slopes:** For safety reasons, the side slopes of sediment basins should be no greater than 2:1 (horizontal to vertical). Use flatter slopes in urban or urbanizing areas for safety and liability.
- **Shape:** The basin shape should be greater than 4:1 (length to width), to improve trapping efficiency. Baffles can be used to modify the effective flow distance on shorter basins if the construction site is unable to accommodate a 4:1 basin.
- **Basin Capacity:** At a minimum, the sediment capacity of a sediment basin should be equal volume to contain 1 inch of runoff from the entire drainage area. This is roughly equivalent to 3,600 ft³/acre.
- **Dimensions:** The longer the basin, the more settling will occur. Therefore, at a minimum, the length of the basin should be no less than four times the width.

The length can effectively be "extended" for basins on sites that do not have the space to accommodate a 4:1 shape by adding a baffle in the basin perpendicular to the direction of the incoming sediment/water.

The basin depth should be a minimum of two feet deep and no shallower than the average distance from the inlet to the outlet (length) divided by 200

Basin dimensions can be determined using the following equations:

1. $Volume = Length \times Width \times Depth$
2. Basins with Volumes less than 80,000 ft³
 $Width = \sqrt{Volume / 8}$

$$Length = 4 \times Width$$

$$Depth = 2 \text{ feet (a constant)}$$

3. Basins with volumes more than 80,000 ft³

$$Width = \sqrt[3]{12.5 \times Volume}$$

$$Length = 4 \times Width$$

$$Depth = Length / 200$$

- **Spillway System:** The spillway system should carry the peak runoff from the sediment basin design storm allowing for a two foot freeboard. The velocity of the flow discharged from the basin should not exceed that allowable for the receiving water body.
- **Principal Spillway (Mechanical Spillway):** Class 2 and 3 basins include the design of a principal spillway to allow a controlled discharge of water. The principle spillway normally consists of a vertical pipe (or riser) located at the deepest part of the basin, connected to a horizontal pipe which outlets through the dam or lower slope.
 - The top of the riser should be at least three feet below the top of the dam or crest of the emergency spillway.
 - The riser may be solid or perforated. Perforated risers are surrounded by wire mesh and a mound of well graded gravel. A trash rack over the top of the riser prevents debris from entering and clogging the spillway. **Geotextile fabric should not be wrapped around perforated risers because it can blind off quickly and effectively block the perforations.**
 - The horizontal pipe should be provided with anti-seep collars to prevent piping along the outside of the pipe.
 - The outlet of the principal spillway for Class 2 and Class 3 basins should be stabilized with riprap. Follow the specifications for Riprap – stabilized outlet. Class 1 basins will not have a spillway.
 - The size of the principal spillway should be large enough to pass 80% of the calculated peak discharge from the drainage area. For Class 1 basins, the peak discharge should be based on the storm frequency equivalent to the lifetime of the project in years, and the Class 2 and Class 3 basins should be designed on a 10-year and 25-year storm frequency, respectively. If the sediment basin will also be used as a storm water basin then be sure to design the spillway using the appropriate storm water basin procedure.
- **Emergency Spillway:** Class 2 and 3 basins require an emergency spillway to protect the embankment by providing an outlet from the basin for runoff volumes which exceed the capacity of the principle spillway.
 - The emergency spillway should be sized to pass the difference in discharge between the design storm frequency and the capacity of the principle spillway.
 - If the basin will be used as a storm water basin, the emergency spillway should be designed to pass the 100-year storm.
 - Emergency spillways can be as simple as a slope drain constructed of a half section of corrugated metal pipe, or a riprap channel constructed down the dam slope.
 - The crest of the spillway should be three feet above the crest of the

mechanical riser and a minimum of two feet above the expected water level for the design storm.

- The cross-section should be trapezoidal, with side slopes 3:1 or flatter.
- The outlet of the emergency spillway for Class 2 and Class 3 basins should be stabilized with riprap. Follow the specifications in the Riprap – stabilized outlet BMP. The emergency spillway for a Class 1 basin can consist of a simple berm alongside the outlet to channel water to a stabilized area.
- **Riser and Barrel:** To facilitate installation and reduce the potential for failure from blockage, the minimum barrel size for corrugated metal pipe should be eight inches, and six inches for smooth wall pipe. The cross-sectional area of the riser at least 1.5 times that of the barrel to improve the efficiency of the principal spillway system.
- **Embankments:** The embankments should always be constructed with the most stable fill material available. For permanent embankments, selected material may have to be hauled in. Where possible, use soils other than sand. Sandy soils tend to shift.

Construction Guidelines

- 1. Never build a sediment basin in a perennial stream or wetlands. In-stream sediment basins are only allowed upon permit by the DEQ, Water Resources Division.**
2. Construct the sediment basins before any other land clearing or grading is done. Construct according to the design and by following the guidelines below.
3. The natural ground under any proposed embankment or dam should be cleared and stripped of trees, other vegetation and roots. The remainder of the basin area should be cleared of trees and larger vegetation to allow easy periodic removal of sediment. Natural grasses and groundcover, however, should be retained to provide stabilization.
4. Disc or scarify the area where embankment fill will be placed to allow a good bond between the fill and the existing soil. The placement of fill should be in controlled, uniform layers, and should be compacted.
5. Stabilize all exposed areas of the embankment by seeding and mulching or sodding. Stabilization of the embankment is particularly important with Class 1 basins since the embankment functions as the spillway.
6. Immediately after the sediment basin is constructed, the top banks of the basin and all surrounding areas should be stabilized with vegetation.
7. After the entire construction project is completed, temporary sediment basins should be dewatered, and then filled in to conform to the contours of the area. The bulkhead and structures should be removed. Stabilize the area following the seeding, mulching or sodding BMPS.
8. For sediment basins that will be converted to permanent storm water controls, the sediment accumulated in the basin during construction, but should be removed to accommodate the conversion.

Monitoring

- Check the basin depth to ensure the capacity of the basin is adequate for storm

water and sediment deposition

- Check the basin for piping, seepage, and other mechanical damage
- Check for the presence of soil caking around the perforated riser pipe, which would prevent proper drainage from the basin.
- Check the outfall to ensure drainage is not causing erosive velocities, and to ensure the outlet is not clogged.

Maintenance

- Remove sediment when it has accumulated to no more than 50% of the design depth.
- Any problems discovered during the maintenance monitoring should be addressed immediately.
- Sediment removed during cleaning should be placed at an upland area and stabilized so that it does not re-enter the drainage course.

References

California Storm water BMP Handbook, Construction. 2003 Sediment Basin
Dyersburg, Tennessee. Erosion Control Handbook. Sediment Basin

Exhibit 1:

Sediment Basin – Standard Riser

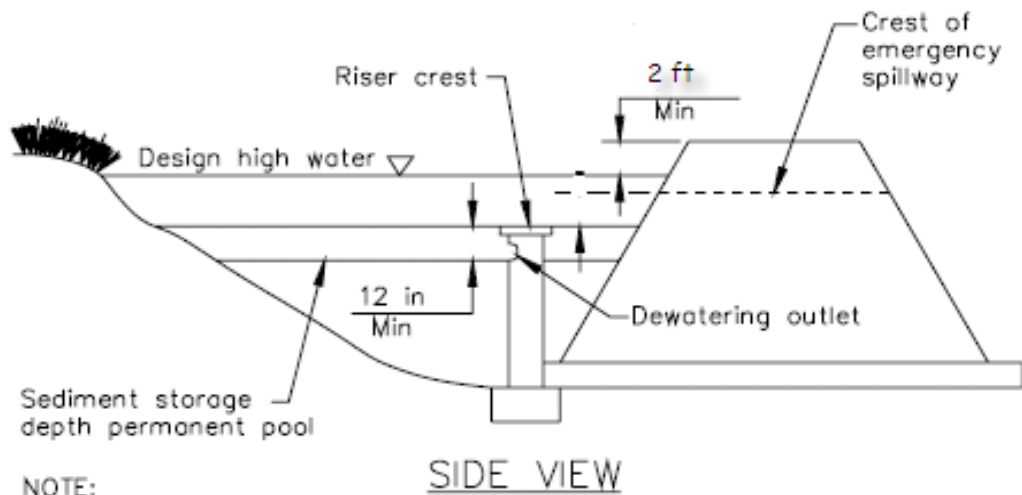
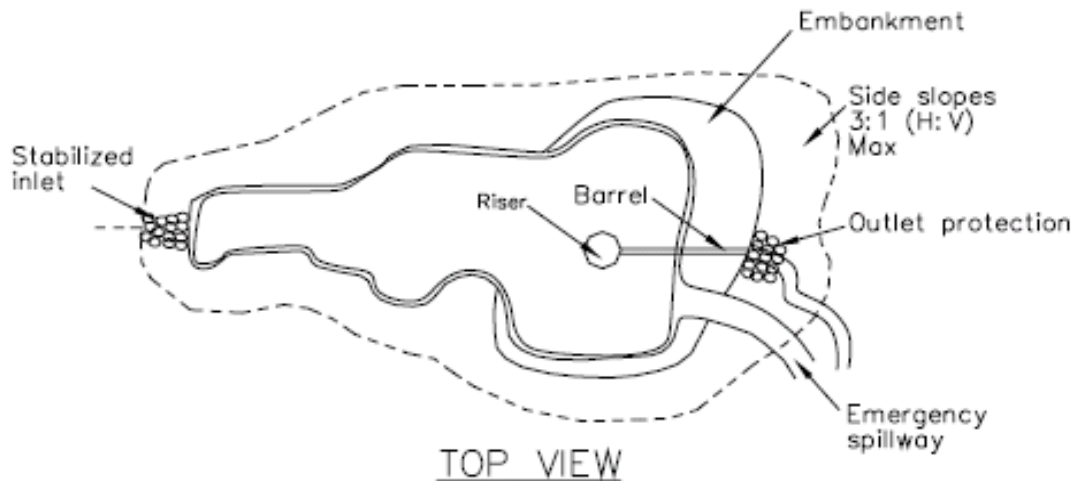

NOTE:
This outlet provides no drainage
for permanent pool.

Exhibit 2:

Sediment Basin – Perforated Riser

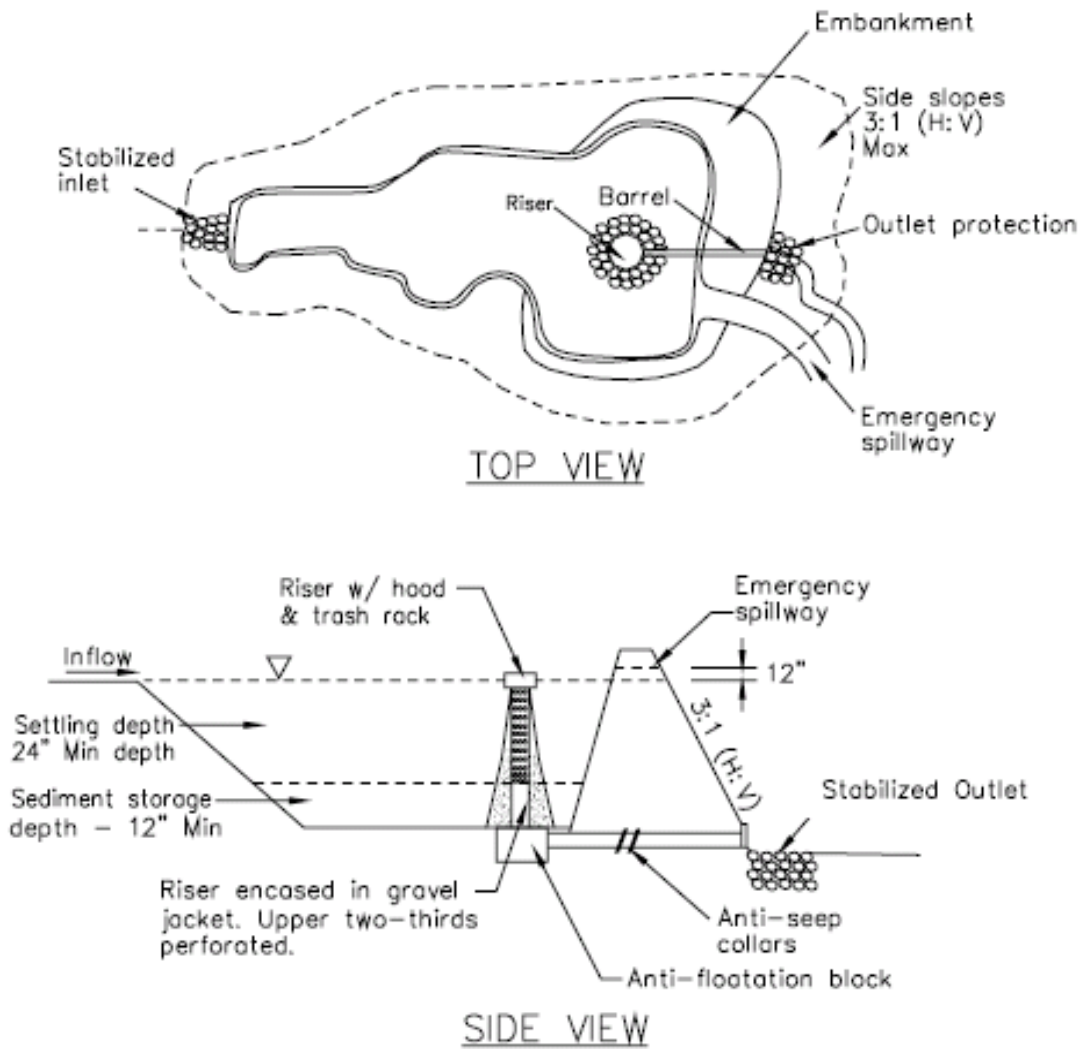

Exhibit 3:

Sediment Basin – Outlet Riser

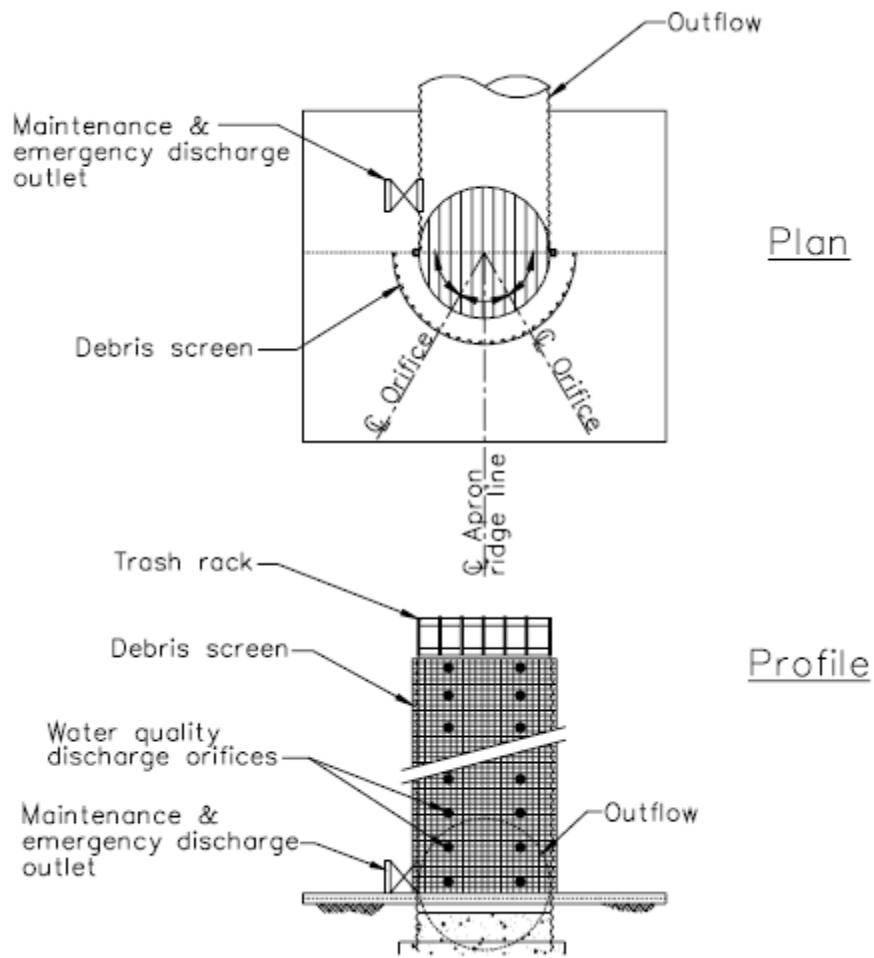
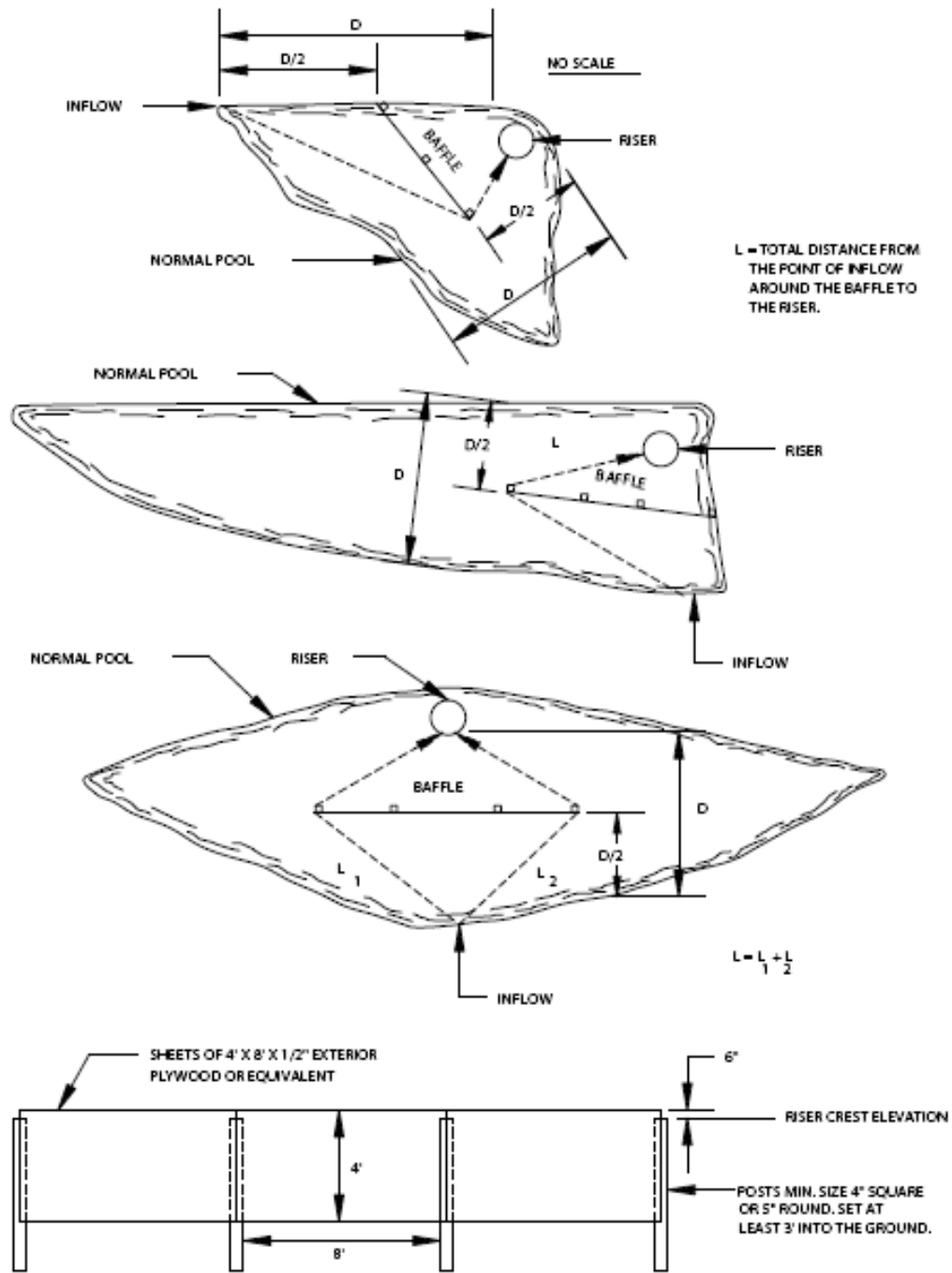

Exhibit 4:

Sediment Basin – Baffle Placement



Mulching Definition

Applying coarse plant residue or chips, or other suitable materials, to cover the soil surface.

Description and Purpose

The primary purpose is to provide initial erosion control while a seeding or shrub planting is establishing. Mulch will conserve moisture and modify the surface soil temperature and reduce fluctuation of both. Mulch will prevent soil surface crusting and aid in weed control. Mulch is also used alone for temporary stabilization in nongrowing months

Pollutant(s) controlled:

- Suspended Sediments

Companion and Alternative BMPs

- Rolled Erosion Control Products
- Hydroseeding
- Seeding/vegetation Page # BMP Guidebook
- Compost Products Page # BMP Guidebook

Advantages and Disadvantages

Advantages:

- Mulch offers a moist, shaded growing zone which reduces plant burn-off
- Proper and timely application can help keep seed and soil nutrients or fertilizer in place.
- Mulch can help suppress weed growth

Disadvantages:

- Unanchored mulch can be mobilized in concentrated flow or high wind conditions or when on slopes.

Location

On soils subject to erosion and on new seedings and shrub plantings. Mulch is useful on soils with low infiltration rates by retarding runoff.

General Characteristics

- Site preparation prior to mulching requires the installation of necessary erosion control or water management practices and drainage systems. To keep eroded soil or concentrated runoff away from the mulched area.
- Several types of mulch materials exist, several of the most common are described as follows:
 - Straw – Straw is the most commonly used type of mulch, is readily available in most areas, and is effective when applied properly. Use

small grain straw (wheat or oat) that is reasonable free of grain and weed seeds or mold. Straw of winter rye is preferable to spring-seeded grains, since fewer weed seeds generally are present. Hay should only be used if straw is not available.

- Wood Chips – Wood chips are suitable for areas which will not be mowed, and around landscaped areas. Wood chips should not be used in areas which are drained by storm sewers, areas subject to flooding, or any other place where they would cause problems if they floated away. Wood chips do not require anchoring, but need to be applied evenly to be effective as an erosion control measure.
- Bark Chips and Shredded Bark – Bark chips and shredded bark are bi-products of timber processing and are often used in landscaping. They may also serve as mulch for areas planted to grasses which are not mowed, and on slopes which are not steep. Applied with a blower, bark chips and shredded bark are less likely to leave the site than wood chips because of their rough edges.
- Compost – Compost can be used as mulch. See the Compost Product BMP on Page # BMP Guidebook for additional details.
- Anchoring should be done at the time of or immediately following the application of the mulch.
-

Materials

- Mulch of choice
- Seed
- Anchoring

Design Specifications

- See Table 1 for specific design specifications by mulch type and Table 2 for specific anchoring selection details

Construction Guidelines

1. Slope, grade and smooth the site to fit needs of selected mulch products.
2. Remove all undesirable stones and other debris to meet the needs of the anticipated land use and maintenance required.
3. Apply mulch after soil amendments and planting is accomplished or simultaneously if hydroseeding is used.
4. Select appropriate mulch material and application rate or material needs. Determine local availability.
5. Select appropriate mulch anchoring material.
6. Anchor mulch immediately after the mulch is applied

Monitoring

- Mulched areas should be checked following each rain to ensure the mulch is staying in place.

Maintenance

- Maintenance procedures should be followed for the BMPs which were implemented to keep the eroded soil or concentrated runoff away from the mulched area.

References

New York Standards and Specifications for Erosion and Sediment Control. 2005.
Mulching

Table 1:

Guide to Mulch Materials, Rates, and Uses

Mulch Material	Quality Standards	per 1000 Sq. Ft.	per Acre	Depth of Application	Remarks
Wood chips or shavings	Air-dried. Free of objectionable coarse material	500-900 lbs.	10-20 tons	2-7"	Used primarily around shrub and tree plantings and recreation trails to inhibit weed competition. Resistant to wind blowing. Decomposes slowly.
Wood fiber cellulose (partly digested wood fibers)	Made from natural wood usually with green dye and dispersing agent	50 lbs.	2,000 lbs.	—	Apply with hydromulcher. No tie down required. Less erosion control provided than 2 tons of hay or straw.
Gravel, Crushed Stone or Slag	Washed; Size 2B or 3A—1 1/2"	9 cu. yds.	405 cu. yds.	3"	Excellent mulch for short slopes and around plants and ornamentals. Use 2B where subject to traffic. (Approximately 2,000 lbs./cu. yd.). Frequently used over filter fabric for better weed control.
Hay or Straw	Air-dried; free of undesirable seeds & coarse materials	90-100 lbs. 2-3 bales	2 tons (100-120 bales)	cover about 90% surface	Use small grain straw where mulch is maintained for more than three months. Subject to wind blowing unless anchored. Most commonly used mulching material. Provides the best micro-environment for germinating seeds.
Jute twisted yarn	Undyed, unbleached plain weave. Warp 78 ends/yd., Weft 41 ends/yd. 60-90 lbs./roll	48" x 50 yds. or 48" x 75 yds.	—	—	Use without additional mulch. Tie down as per manufacturers specifications. Good for center line of concentrated water flow.
Excelsior wood fiber mats	Interlocking web of excelsior fibers with photodegradable plastic netting	8" x 100" 2-sided plastic, 48" x 180" 1-sided plastic	—	—	Use without additional mulch. Excellent for seeding establishment. Tie down as per manufacturers specifications. Approximately 72 lbs./roll for excelsior with plastic on both sides. Use two sided plastic for centerline of waterways.
Compost	Up to 3" pieces, moderately to highly stable	3-9 cu. yds.	134-402 cu. yds.	1-3"	Coarser textured mulches may be more effective in reducing weed growth and wind erosion.
Straw or coconut fiber, or combination	Photodegradable plastic net on one or two sides	Most are 6.5 ft. x 3.5 ft.	81 rolls	—	Designed to tolerate higher velocity water flow, centerlines of waterways, 60 sq. yds. per roll.

Table 2:

Guide to Mulch Anchoring

Anchoring Method or Material	Kind of Mulch to be Anchored	How to Apply
1. Peg and Twine	Hay or straw	After mulching, divide areas into blocks approximately 1 sq. yd. in size. Drive 4-6 pegs per block to within 2" to 3" of soil surface. Secure mulch to surface by stretching twine between pegs in criss-cross pattern on each block. Secure twine around each peg with 2 or more tight turns. Drive pegs flush with soil. Driving stakes into ground tightens the twine.
2. Mulch netting	Hay or straw	Staple the light-weight paper, jute, wood fiber, or plastic nettings to soil surface according to manufacturer's recommendations. Should be biodegradable. Most products are not suitable for foot traffic.
3. Wood cellulose fiber	Hay or straw	Apply with hydroseeder immediately after mulching. Use 500 lbs. wood fiber per acre. Some products contain an adhesive material ("tackifier"), possibly advantageous.
4. Mulch anchoring tool	Hay or straw	Apply mulch and pull a mulch anchoring tool (blunt, straight discs) over mulch as near to the contour as possible. Mulch material should be "tucked" into soil surface about 3".
5. Tackifier	Hay or straw	Mix and apply polymeric and gum tackifiers according to manufacturer's instructions. Avoid application during rain. A 24-hour curing period and a soil temperature higher than 45 ^o Fahrenheit are required.

Hydroseeding

Definition

Hydroseeding is a mechanical method of applying seed, fertilizer, and mulch to land in one step.

Description and Purpose

Hydroseeding typically consists of applying a mixture of wood fiber, seed, fertilizer, and stabilizing emulsion with hydro-mulch equipment, which temporarily protects exposed soils from erosion by water and wind.

The practice may also be called hydro mulching, hydraulic planting, hydraulic mulch seeding, hydraseeding

Pollutant(s) controlled:

- Suspended Sediments

Pollution Removal Efficiencies:

- Hydroseeding initially reduces sediment generation by 70 to 80% as compared to sediment production off bare slopes.

Companion and Alternative BMPs

- Mulching
- Seeding/Vegetation Page # BMP Guidebook
- Rolled Erosion Control Products

Advantages and Disadvantages

Advantages:

- Tackifiers can be used with the application to help keep the seed in place
- Provides mulching medium around the seed to hold moisture

Disadvantages:

- Hydroseeding may be used alone only when there is sufficient time in the season to ensure adequate vegetation establishment and erosion control. Otherwise, hydroseeding must be used in conjunction with a soil binder or mulching
- Hydroseeding may be inappropriate in dry periods without supplemental irrigation
- Wood fiber hydraulic mulches are generally short-lived (only last a part of a growing season) and need 24 hours to dry before rainfall occurs to be effective.
- May not be able to access remote areas with hydroseeder

Location

Hydroseeding is applied on disturbed soil areas requiring temporary protection until permanent vegetation is established or disturbed soil areas that must be re-disturbed following an extended period of inactivity

General Characteristics

- Hydraulic planting mulch is the ingredient that makes the technique possible. Water-laden mulch shot from high-pressure hose or spray gun travels farther than seed and water alone. Once the mulch is on the soil surface, it creates a “mat” or blanket that holds the seed in place, retains soil moisture, resists wind and water erosion, and creates a favorable environment for seed germination.
- Mulch materials may be made from wood chips, newsprint, or corrugated cardboard. Some products may include synthetic poly-based fibers or natural agricultural fibers, paper mill sludge, sawdust, slick papers, or some combination of these.
- Each mulch product group has unique performance characteristics and associated costs. Some materials simply perform the mulch function better than others
- Mulch Fiber length is the key to holding power, while germination is most influenced by moisture holding ability and application rates.
- Virtually any fertilizer formulation can be incorporated into the hydroseeding slurry. It is important to use soil testing to determine the appropriate fertilizer for the site.
- A difficult to access site is best fertilized with a long acting or time-release product at the same time it is seeded. An easily accessible site can be fertilized (again) after germination.
- Tackifier is powdered or granular glue, which when added to the slurry, serves to glue the mulch blanket in place, helping it to withstand wind and rain erosion. Steep slopes are best protected with a tackifier, though any site susceptible to erosion (including that caused by the project’s own irrigation) should be a candidate.
- A wide variety of special use products can be incorporated into the hydroseed slurry when conditions dictate. Soil amendments, such as lime and gypsum, or organics such as sludge and humus can be applied right along with the seed and other ingredients. Dyes, surfactants, growth stimulators, fungicides, inoculants, and a host of other liquid, powdered and granular products are also widely available.

Materials

- Cellulose Fiber Mulch
- Fertilizer
- Tackifier
- Hydro – seed mix.

Design Specifications

- To select appropriate hydroseeding mixtures, an evaluation of site conditions shall be performed with respect to:
 - soil conditions
 - site topography
 - season and climate
 - vegetation types
 - maintenance requirements
 - sensitive adjacent areas
 - water availability
 - plans for permanent vegetation.
- Paper Mulch is frequently applied at 1,200-1,500 pounds per acre (approximately 25lbs-35 lbs per 1,000 square feet). With a polyacrylamide additive, such rates can be effective. Many contractors avoid using more than 2,000-2,500 lbs per acre of paper mulch, because too much paper mulch tends to crust, and can inhibit germination.
- Wood Mulch is most effective at rates beginning at 2,000 lbs per acre (about 45 lbs per 1,000 square feet). In very hot conditions, 3,000 lbs (about 70 lbs per 1,000 square feet) per acre will provide more moisture retention, and will therefore improve the probability of success significantly. A guar based tackifier is also highly recommended to improve the probability of yielding an excellent grass stand.
- Bonded Fiber Matrix rates start at about 3,000 lbs per acre. At 4,000 lbs per acre (about 90 lbs per 1,000 square feet), most wood based Bonded Fiber Matrix products provide an excellent probability of achieving total coverage of grass, even when pounded with destructive rains or in very hot conditions.
- Regardless of the quality of the mulch protection, rainfall or irrigation is always necessary to produce a stand of grass.
- Guar tackifier can be used at 25-150 lbs per acre. The standard recommend application rate is 1½ lbs per 1,000 square feet or about 60 lbs per acre. This product has been the mainstay as a glue additive for hydro-mulching for many years.
- Seed and fertilizer recommendations are dependent upon the location of the area to be treated. See the Seeding/Vegetation BMP on Page # BMP Guidebook for specific seed recommendations
- Hydroseeding can be accomplished using a multiple-step or one-step process.
 - The multiple-step process ensures maximum direct contact of the seeds to soil.
 - When the one-step process is used to apply the mixture of seed, fiber, etc., the seed rate shall be increased to compensate for all seeds not having direct contact with the soil.
- Follow-up applications shall be made as needed to cover weak spots.
- The time allowed between placement of seed in the hydraulic mulcher and the emptying of the hydraulic mulcher tank should not exceed 30 minutes.
- Application of the slurry should proceed until a uniform cover is achieved. The applicator should not be directed at one location for too long a period of time or the applied water will cause erosion.

Construction Guidelines

1. Prior to application, roughen embankment and fill areas by rolling with a crimping or punching type roller or by track walking. Track walking shall only be used where other methods are impractical.
2. Hydraulic matrices require 24 hours to dry before rainfall occurs to be effective

Monitoring

- Hydromulched slopes should be inspected periodically for damage due to wind, water, or human disturbance.

Maintenance

- Repair all damaged areas immediately using hydromulching at the original specifications or straw mulch.
- Supplemental watering may be required

References

DNRE Storm Water Best Management Practices Catalog, September 2005
Hydromulching
Hydroseeding . . . Getting All You Paid For Author: Michael Mellon

Dust Control

Definition

Control of fugitive dust at construction sites that result from grading, demolition, hauling, and traffic.

Description and Purpose

Dust is generated by vegetation removal plus wind or mechanical movement of soil. Dust may include silty soils, fine sands and clays. Control measures prevent significant movement of soil and attached pollutants

Pollutant controlled: Airborne soil particles (suspended solids) and attached chemicals, including nutrients, pesticides, metals.

Treatment Mechanisms:

- Cover bare soils and other loose particulates
- Bind particles (water, chemicals, adhesives)
- Good housekeeping (sweeping or other removal of free particulates)
- Control, block, or reduce wind
- Confine or restrict vehicles and equipment

The practice provides pollution prevention rather than removal.

Companion and Alternative BMPs

- Access Road
- Construction Staging and Scheduling Page # BMP Guidebook
- Critical Area Stabilization Page # BMP Guidebook
- Dune/Sand Stabilization Page # BMP Guidebook
- Mulching
- Seeding/Vegetation Page # BMP Guidebook
- Street Sweeping Page # BMP Guidebook

Advantages and Disadvantages

Advantages:

- Many practices also provide soil erosion and sedimentation control
- Widely applicable, easy to apply, and many options
- Multiple benefits: preserves visibility and nuisance conditions on worksites; protects health, equipment, and neighboring property; and maintains soil structure and texture for vegetation establishment

Disadvantages:

- Controls that may cause water pollution are not well regulated. Used oil and brine

wastes are still used today in many areas because of availability and lack of knowledge or concern about environmental impacts

- Repeat application is required. Plain water is cheap, readily available, and environmentally benign, but applications daily or more frequently increase labor and fuel costs
- Some agents reduce soil permeability and increase runoff rate & volume
- Chemicals may be expensive or be useful only on specific soil types.
- Polyacrylamide (PAM) can be very effective but users should be aware of disadvantages:
 - Each formula must be matched to a specific soil type
 - Overuse can clog soil and reduce infiltration
 - Does not work on coarse soils
 - Not effective if there is snow cover
- Many materials or methods require unique equipment to apply
- Windbreaks require space and they only work when the wind is from one direction
- Chlorides inhibit vegetative growth so they should not be applied where vegetation will be planted
- Lignins are sticky so they are tracked into buildings and onto paved roads
- Tarps and hard covers do not allow vehicle traffic

Location

- Unpaved roads and other areas where soils are bare (construction, demolition, mining, forestry, soil stockpiles)
- Areas of fine, non-organic soils
- Open areas lacking windbreaks
- Where vehicle traffic is heavy such as entrances to construction and demolition sites
- Where surface waters are nearby that can be contaminated with dust
- Where "Built-up" areas are adjacent to project site

General Characteristics

- Often sprayed on as a liquid where vehicles travel
- Solid materials such as tarps may be used for temporary covers of stockpiles and other areas where vehicle traffic does not occur
- Not usually required in winter when soils are frozen or during spring thaw when soils are continuously muddy or moist
- No single dust control agent is perfect for all sites

Materials

- Water binds soils by moistening
- Chlorides draw moisture from the air to make soils self dampening. These include: calcium chloride (flake or liquid), magnesium chloride (liquid), and sodium chloride (table salt)
- Lignin sulfonate is a sticky resin by-product from tree pulp which is mixed with water and sprayed on as a soil binder. Marketed by several commercial names
- Polyacrylamides (anionic PAM) are long-chain molecules that bind fine particles together by chemical attraction. Do not use cationic PAM which has aquatic toxicity
- Vegetable oil penetrates the soil surface and provides binding. Usually soybean oil
- Mulch retains soil moisture and covers fine loose soils. Mulches include organic soils and compost
- Vegetation binds and covers the soil when established. Regular watering during germination and also mulch will control dust until vegetation is established
- Wind barriers reduce the velocity and erosivity of wind. These including: solid board fences, snow fencing, burlap fencing, crate walls, hay bales
- Thinned liquid asphalts, asphalt emulsions, and waste oils raise environmental concerns, and should not be used.

Design Specifications

- Identify performance objectives for dust controls during project design
- Use multiple dust control methods and/or a phased approach where no one agent can meet the performance objectives
- Minimize soil disturbance by retaining grass, trees and shrubs on project sites as much as possible, and installing Access Roads
- Install irrigation systems as a first step where dust is a concern and systems can be protected from construction traffic
- Allow adequate space for wind breaks (Construction Barriers). Account for the prevailing wind direction, and place barriers perpendicular to the prevailing direction, spaced evenly at intervals of about 15 times the height of the barrier
- Be prepared to apply dust controls when soil disturbance is occurring during hot dry months. For watering without an irrigation system, a truck and driver must be available at all times during dry periods
- Anionic PAM: always test soils to identify the appropriate PAM product
- Covers/tarps over trucks and stockpiles: provide adequate cover and anchor it well against all possible wind events
- Street sweeping: brush type sweepers wet the pavement surface to reduce dust movement and bind it temporarily to the pavement. Vacuum type sweepers remove fine particles as well as coarse ones
- Travel on paved routes as much as possible
- Permanently stabilize soils by paving, vegetating, or adding other landscaping as soon as possible.

Performance Enhancers

- For gravel/dirt road surfaces, graders with edges that roughen the soil surface aid incorporation of the dust control agent
- Pre-wet roads and exposed soils to improve effectiveness of solid dust controls (e.g., calcium chloride)

Construction Guidelines

- When large areas require dust control for the first time, test a small area first to determine the effectiveness of agents applied to soils.
- Follow manufacturer's specifications for wind barriers and agents applied to soils
- Treat areas early in the day if they appear dry and dusty. Early treatment prevents problems later as vehicle traffic and temperatures increase
- Limit vehicle speeds on dusty materials and limit vehicle traffic and earth moving on windy days, if possible
- Tillage can provide emergency dust control. Use chisel plow blades set about 12" apart, or spring-tooth harrows, or similar plow. Start on the windward side of a project site

Monitoring

- Inspect for sedimentation on site. Deposited fines are subject to wind erosion and tracking
- Inspect Access Roads and public rights-of-way for tracked sediment
- Watch for water erosion which results from over watering
- Watch for dust clouds indicating that reapplication of dust control mechanism is required

Maintenance

- Reapply liquid or solid agents to control dust by 80% or more
- Assure that tarps and other solid covers are in place and anchored
- Provide street sweeping or Access Road maintenance as needed.

References

DTMB. 2005. *Soil Erosion and Sedimentation Control Guidebook*. Specification E5: Dust Control. Infrastructure Services, Facilities Administration, Design & Construction Division. Lansing MI. <https://www.michigan.gov/dtmb/procurement/Design-and-Construction/Sustainability/soil-erosion-and-sedimentation-control>

MDOT. 2006. *Soil Erosion and Sedimentation Control Manual*. Construction and Technology Support Area. Lansing MI. <https://www.michigan.gov/-/media/Project/Websites/MDOT/Programs/Highway-Programs/Environmental-Efforts/Stormwater-Management/SESC-Manual.pdf>

San Juan County. 2005. *Construction Best Management Practices, Vol II*. BMP C140: Dust Control. Department of Ecology. San Juan County WA.

<http://www.mdt.mt.gov/research/projects/env/erosion.shtml> USEPA. 2006. *Dust Control*. National Menu of BMPs, Construction Site Stormwater Runoff Control, Erosion Control. Storm water Program. Washington DC. cfpub2.epa.gov/npdes/stormwater/menuofbmps/index.cfm

Polyacrylamide (PAM)

Definition

Polyacrylamides (PAMs), are polymer-based materials used to facilitate erosion control and decrease soil sealing by binding soil particles, especially clays, to hold them on site. In addition, these types of materials may also be used as a water treatment additive to remove suspended particles from runoff.

Description and Purpose

PAM increases the soil's available pore volume, thus increasing infiltration and reducing the quantity of storm water runoff that can cause erosion. Suspended sediments from PAM treated soils exhibit increased flocculation over untreated soils. The increased flocculation aids in their deposition, thus reducing storm water runoff turbidity and improving water quality. PAMs may be used as a water treatment additive to remove suspended particles from runoff. PAMs may also be used to provide an appropriate medium for the growth of vegetation for further stabilization.

Pollutant(s) controlled:

- Suspended Solids

Treatment Mechanisms:

- Chemical (flocculation & coagulation)

Companion and Alternative BMPs

- Dust Control
- Hydroseeding
- Sediment Basin

Advantages and Disadvantages

Advantages:

- Improves stability of problem soils to prevent soil detachment (i.e. prevents erosion) in the first place
- Provides quick stabilization where vegetation has yet to be established
- Promotes flocculation (reduces settling time) of smallest particles
- Increases soil pore volume and permeability, thus decreasing impervious cover
- Less obtrusive than some conventional measures - doesn't interfere with construction machinery/activity
- Convenient and easy to apply and store along with other soil amendments (fertilizer, mulch, etc.) with conventional seeding, mulching, or irrigation equipment
- Material is specifically designed for the soil, waters, and other on site characteristics
- May prevent costly repair and reshaping of rilling or failing slopes

- Re-application may not be necessary for several months if treated areas are mulched
- Reduces seed, pesticide, and fertilizer (phosphorus and nitrogen) losses that hinder vegetation establishment on site, increase costs, and promote nutrient and chemical loading offsite
- Reduces windborne dust conditions

Disadvantages:

- Materials are soil type-specific so a contractor cannot use leftover material at another site or bulk order for multiple sites.
- Using it requires site-specific testing that may take several days to complete.
- Overuse may clog soils, thereby decreasing infiltration.
- It is not effective when applied to pure sand or gravel with no fine silts or clays, nor when applied over snow cover.
- PAM shall not be directly applied to water or allowed to enter a water body.
- Do not use PAM on a slope that flows into a water body without passing through a sediment trap or sediment basin.
- PAM will work when applied to saturated soil but is not as effective as applications to dry or damp soil.
- Some PAMs are more toxic and carcinogenic than others. Only the most environmentally safe PAM products should be used.
- The specific PAM copolymer formulation must be anionic. **Cationic PAM shall not be used in any application because of known aquatic toxicity problems.**
- A review of scientific literature and field demonstrations has identified several forms of PAMs that are potentially toxic to the aquatic environment and not suitable for use in Michigan. These toxic forms include:
 - Non-food grade PAMs. These PAMs contain residual monomer acrylamides in concentrations that may be toxic in the environment. Only food grade (National Sanitary Foundation/American National Standards Institute) or products containing less than 0.05 percent residual monomer by volume should be used.
 - Any cationic PAM or a form other than an anionic polymer. Only anionic forms of PAMs demonstrate non-toxic qualities.
 - Emulsion-based PAMs or any polymer that is pre-mixed in a substance other than pure water. Some of these emulsions have a surfactant base for easy application. While the polymer may not be toxic, some emulsions demonstrated significant toxicity during field trials

Location

PAM can be applied to the following areas:

- Rough graded soils that will be inactive for a period of time.
- Final graded soils before application of final stabilization (e.g., paving, planting, mulching).
- Temporary haul roads prior to placement of crushed rock surfacing.
- Compacted soil road base.
- Construction staging, materials storage, and layout areas.
- Soil stockpiles.
- Areas that will be mulched.

General Characteristics

- PAM can be used in several forms:
 - Powder
 - Powder added to water (wet, as a stock solution)
 - Emulsion
 - Gel Blocks or Bricks
- When used correctly and in concert with existing erosion control best management practices (BMPs), land applied PAMs should not enter surface waters of the state.
- PAMs are manufactured in various forms to be used on specific soil types, and are generally applied at a rate of up to 10 pounds/acre.
- Using the wrong form of a PAM on a soil will result in some degree of performance failure, and increase the potential for this material to enter surface waters.
- The use of PAMs as a soil erosion control should be listed with all other BMPs as part of your soil erosion control plan.
- Pam shall be used in conjunction with other BMPs and not in place of other BMPs, including both erosion controls and sediment controls.
- Storm water runoff from PAM treated soils should pass through a sediment control BMP prior to discharging to surface waters.
- PAM can be applied to wet soil, but dry soil is preferred due to less sediment loss.
- Keep the granular PAM supply out of the sun. Granular PAM loses its effectiveness in three months after exposure to sunlight and air.
- Proper application and re-application plans are necessary to ensure total effectiveness of PAM usage.
- PAM, combined with water, is very slippery and can be a safety hazard. Care must be taken to prevent spills of PAM powder onto paved surfaces. During an application of PAM, prevent over spray from reaching pavement, as pavement will become slippery. If PAM powder gets on skin or clothing, wipe it off with a rough towel rather than washing with water this only makes cleanup messier and longer.
- PAM tackifiers are available and being used in place of guar and alpha plantago. Typically, PAM tackifiers should be used at a rate of no more than 0.5-1 lb per 1,000 gallons of water in hydro mulch machine. Some tackifier product instructions say to use at a rate of 3-5 lbs per acre, which can be too much. In addition, pump problems can occur at higher rates due to increased viscosity.
- **Prior to the application of polyacrylamides [PAMs] directly within "Surface Waters of the State", MDEQ must approve their use.** To obtain approval, specific project information must be submitted to and reviewed by MDEQ. All requests involving the use of PAMs in direct contact with surface water, including facilities covered by National Pollutant Discharge Elimination System permits through Permit by Rule, or soil erosion and sedimentation control permits or plans, must be submitted to:
 - Ms. Diana Klemans of the Surface Water Assessment Section, Water Resources Division, P.O. Box 30458, Lansing, Michigan 48909-7958.
 - Requests should include the following:
 - applicant's name and address
 - the specific application location

- area and frequency of treatment
- name and amount of Pam(s) being used
- the name and location of receiving surface waters
- Please specify if the characteristics of the PAM(s) meet the guidelines specified above and if on-site soil or sediment characteristics have been identified and matched to the appropriate polymer

Materials

- Polyacrylamide
- Mulch

Design Specifications

- PAM may be applied in dissolved form with water, or it may be applied in dry, granular, or powdered form. The preferred application method is the dissolved form.
- PAM is to be applied at a maximum rate of ½ pound PAM per 1000 gallons water per 1 acre of bare soil. Table 1 and Figure 1 can be used to determine the PAM and water application rate for a disturbed soil area. Higher concentrations of PAM **do not** provide any additional effectiveness.

Construction Guidelines

1. Pre-measure the area where PAM is to be applied and calculate the amount of product and water necessary to provide coverage at the specified application rate (1/2 pound PAM/1000 gallons/acre).
2. PAM has infinite solubility in water, but dissolves very slowly. Dissolve pre-measured dry granular PAM with a known quantity of clean water in a bucket several hours or overnight. Mechanical mixing will help dissolve the PAM. Always add PAM to water – not water to PAM.
3. Pre-fill the water truck about 1/8 full with water. The water does not have to be potable, but it must have relatively low turbidity – in the range of 20 NTU or less.
4. Add the dissolved PAM and water mixture to the truck.
5. Fill the water truck to specified volume for the amount of PAM to be applied.
6. Spray the PAM/water mixture onto dry soil until the soil surface is uniformly and completely wetted
7. PAM may also be applied as a powder at the rate of 5 lbs per acre. This must be applied on a day that is dry. For areas less than 5-10 acres, a hand held “organ grinder” fertilizer spreader set to the smallest setting will work. Tractor mounted spreaders will work for larger areas.

Monitoring

- Inspect BMPs prior to forecast rain, daily during extended rain events, after rain events, weekly during the rainy season, and at two-week intervals during the non-rainy season.

Maintenance

- Areas where erosion is evident should be repaired and BMPs re-applied as soon as possible. Care should be exercised to minimize the damage to protected areas while making repairs, as any area damaged will require re-application of BMPs.
- PAM must be reapplied on actively worked areas after a 48-hour period if PAM is to remain effective.
- Reapplication is not required unless PAM treated soil is disturbed or unless turbidity levels show the need for an additional application.
- If PAM treated soil is left undisturbed a reapplication may be necessary after two months.
- More PAM applications may be required for steep slopes, silty and clayey soils (USDA Classification Type "C" and "D" soils), long grades, and high precipitation areas.
- When PAM is applied first to bare soil and then covered with straw, a reapplication may not be necessary for several months.
- Rinse all PAM mixing and application equipment thoroughly with water to avoid formation of PAM residues
- Downstream deposition from the use of PAM may require periodic sediment removal to maintain normal functions

References

California Storm water BMP Handbook, Construction, 2003 Polyacrylamide

Table 1:

Table 1 PAM and Water Application Rates		
Disturbed Area (acre)	PAM (lbs)	Water (gallons)
0.50	0.25	500
1.00	0.50	1,000
1.50	0.75	1,500
2.00	1.00	2,000
2.50	1.25	2,500
3.00	1.50	3,000
3.50	1.75	3,500
4.00	2.00	4,000
4.50	2.25	4,500
5.00	2.50	5,000