



STATE OF MICHIGAN

GRETCHEN WHITMER  
GOVERNOR

DEPARTMENT OF TECHNOLOGY, MANAGEMENT & BUDGET  
LANSING

TRICIA L. FOSTER  
DIRECTOR

## Connecting Michigan Communities Grant Application

**Please read through the entire Connecting Michigan Communities Grant Information and Application – 2019 package before you begin to respond to the application questions. This will help ensure you understand the full scope of the application as well as the details you will need to provide to complete the application.**

**Application Deadline:** All grant applications are due by 4:00PM EST, Friday, August 30, 2019.

**Submission Guidelines:** Completed application and supporting documentation must be received by the Department of Technology, Management, and Budget (DTMB), Center for Shared Solutions by 4:00 p.m. on Friday, August 30, 2019, to be considered for funding. Applicants should email their applications and all attachments in PDF format to [DTMB-CMICGrant@michigan.gov](mailto:DTMB-CMICGrant@michigan.gov). Applicants will receive an email confirmation of their submission within 48 business hours. Please fill out the entire application and clearly label any attachments with the question/statement number from the application form. Award decisions are estimated to be made in the fourth quarter of 2019.

**Questions and Contact:** If you have questions after reviewing the application and supporting documentation, please see the Frequently Asked Questions (FAQ) document available on the grant website at: [www.michigan.gov/CMICGrant](http://www.michigan.gov/CMICGrant). The FAQ will be updated throughout the application process. Questions and comments can also be submitted via email to: [DTMB-CMICGrant@michigan.gov](mailto:DTMB-CMICGrant@michigan.gov).

## Application Checklist

This checklist is part of your application and should be returned along with your completed application and attachments.

### Application Submission Checklist:

- Read the entire application package.
- Public application is complete and file name meets the standards.
- Non-Public application is complete and file name meets the standards.
- Confidential Treatment Form is complete.
- Attachments have been gathered and file names meet the standards.
  - Attachment 1: Map of proposed service area in PDF format (including both last mile coverage and middle mile routes)
  - Attachment 2: GIS-compatible file of the proposed service area (including both last mile coverage and middle mile routes)
  - Attachment 3: Spreadsheet of census blocks that are part of the proposed service area
  - Attachment 4: Match commitment letters or evidence
  - Attachment 5: Applicant organizational chart
  - Attachment 6: Resumes of key officers, management personnel, and proposed project management team
  - Attachment 7: Audited financial statements.
  - Attachment 8: Evidence of network scalability
  - Attachment 9: Five year, stand-alone project financial plan/forecast
  - Attachment 10: Affidavit of commitment to offer the proposed service and cost in the proposed service area for a minimum of five years after project completion
  - Attachment 11: Budgetary engineering designs, diagrams, and maps that show the proposed project
  - Attachment 12: Letters of support
  - Attachment 13: Demonstration of customer interest in the proposed project
  - Attachment 14: Statements of impact/support from CAs (if applicable)
  - Attachment 15: Evidence of application for a SPIN (if applicable)
  - Attachment 16: Statements of impact/support from businesses (if applicable)

NOTE: Attachments must be submitted following the designated naming structure. Applicants are to use the name of their organization followed by the attachment number and file type (e.g. ABCTelecom\_Attachment\_1.xlsx).

# Application

## Applicant and Project Information, Contact Information, and Summary

1. Project Name:  
Mercury Connects | Calhoun
2. Applicant Name:  
Mercury Wireless Indiana, LLC.  
DBA (if applicable):  
Mercury Wireless  
Mailing Address:  
6004 Highview Drive. STE B  
Fort Wayne, IN 46818
3. Primary Grant Contact:  
Matthew Sams  
Primary Contact Organization (if not part of the applicant's organization):  
  
Primary Contact Phone Number:  
(800) 354-4915  
Primary Contact Email Address:  
matthew.sams@mercurywireless.com
4. Application Author Name:  
Matthew Sams  
Application Author Email:  
matthew.sams@mercurywireless.com
5. Eligibility Status: Please select the means by which the applicant is eligible to apply for the grant:  
 Licensed under the Michigan Telecommunications Act (1991 PA 179, MCL 484.2101 to 484.2603)  
 Franchise holder under the Uniform Video Services Local Franchise Act (2006 PA 480, MCL 484.3301 to 484.3315)  
 Broadband service provider currently providing service in Michigan
6. Are you registered with the [Michigan Public Service Commission's Intrastate Telecommunications Service Providers Registry \(ITSP\)](#)?  
 Yes    No    Unsure
7. Have you provided broadband coverage data to Connect Michigan in the last five years?  
 Yes    No    Unsure
8. Applicant Identification Numbers: Please provide the following identification numbers for the applicant (if available):  
  
Federal Employer Identification Number (EIN):  
[REDACTED]  
Michigan Tax Identification Number:  
[REDACTED]  
Michigan Vendor Identification Number:  
[REDACTED]  
Federal Communications Commission Registration Number (FRN):  
0025151754

Service Provider Identification Number (SPIN):  
143051573

9. Project Summary (250 words max.):

Mercury Connects | Calhoun is a project to establish a broadband wireless access (BWA) network built and operated by Mercury Wireless Indiana, LLC. in Calhoun county, Michigan. BWA networks offer a high performance and cost-effective alternative to fiber-optic networks. This project will provide broadband Internet to 396 unserved households, 41 businesses, and 3 community anchor institutions utilizing state of the art fixed-wireless LTE technology, as well as the surrounding communities. Mercury Wireless will improve broadband access in these unserved areas to 100 Mbps DL and 20 Mbps UL by September of 2023. Providing fast, reliable, and unlimited broadband Internet is crucial to the economic success of our communities, and wireless networks are ideal solution to help close the digital divide allowing access to critical applications such as e-commerce, distance learning, and telehealth services. For over 10 years, Mercury Wireless has been developing and deploying carrier-class wireless networks using scalable technologies and has a proven track record of success. This project will utilize existing network infrastructure and assets from Mercury's Indiana network, while further extending its capacity and reach to connect Calhoun county. In the spirit of closing the digital divide in these unserved areas, Mercury is requesting funding from the Connecting Michigan Communities Grant Program of \$360,000.00, with an applicant match of \$120,000.00, for a total project cost of \$480,000.00.

**Locations Passed and Proposed Service:**

*Attachment 1: Map of proposed service area in PDF format (including both last mile coverage and middle mile routes)*

Name of Attachment 1:

MercuryWirelessIndianaLLC\_Attachment\_1

*Attachment 2: GIS-compatible file of the proposed service area (including both last mile coverage and middle mile routes)*

Name of Attachment 2:

MercuryWirelessIndianaLLC\_Attachment\_2

*Attachment 3: Spreadsheet of census blocks that are part of the proposed service area.*

Name of Attachment 3:

MercuryWirelessIndianaLLC\_Attachment\_3

10. Please provide a brief description of the proposed service area (250 words max.):

The Mercury Connects | Calhoun project is designed to identify and connect non-contiguous census blocks reporting a lack of broadband Internet availability. Utilizing several data sources including information available from the US Census Bureau, FCC, USDA, DTMB, Melissa Data, county agencies, and citizen feedback, Mercury has identified the census blocks in Attachment\_3 as lacking sufficient access to broadband. These areas of Calhoun county include households, businesses, and community anchor institutions located in Albion, Battle Creek, Burlington, Ceresco, Homer, Marshall, and Tekonsha. In addition to the census blocks identified in this project, the construction of a broadband wireless access network would make these services available to areas with existing broadband services increasing local competition and improving services for all citizens in the surrounding communities.

11. Does the project include a middle mile component:

Yes No

12. Locations Passed: Please indicate the total number of locations by type that will be able to receive improved broadband services as a result of the proposed project:

Households:

396

Businesses:

41

Community Anchor Institutions:

3

13. Are any vacant lots included in the total number of locations passed listed above?

Yes No

If yes, these vacant lots should be anticipated for growth in the next five years according to a local, county, or regional master plan or economic development plan. Please list the name of the relevant plan and the jurisdiction implementing the plan.

Plan Name:

n/a

Jurisdiction:

n/a

14. Please list the jurisdictions impacted by the proposed service area:

City(ies)/Village(s):

Albion, Battle Creek, Burlington, Homer, Marshall, Tekonsha

Township(s):

Ceresco, Sheridan

County(ies):

Calhoun

State House District(s):

62, 63

State Senate District(s):

19

15. Please provide a brief description of the broadband service to be provided including, but not limited to, the technology to be used, will bandwidth be dedicated or shared, etc. (250 words max.):

**Project Costs and Budget**

16. Total eligible project cost:

\$480,000.00

17. Total grant request:

\$360,000.00

*Attachment 4: Match commitment letters or evidence*

Name of Attachment 4:

MercuryWirelessIndianaLLC\_Attachment\_4

18. Total matching funds: Please complete the table below summarizing the source, amount, and type of matching funds contributed to the project. Applicants should also indicate if the match is secured or not. Attach additional sheets if necessary.

Source	Amount	Type	Secured?
Internal Revenues	\$120,000.00	<input checked="" type="checkbox"/> Cash <input type="checkbox"/> In-Kind	<input checked="" type="checkbox"/> Yes <input type="checkbox"/> No
		<input type="checkbox"/> Cash <input type="checkbox"/> In-Kind	<input type="checkbox"/> Yes <input type="checkbox"/> No
		<input type="checkbox"/> Cash <input type="checkbox"/> In-Kind	<input type="checkbox"/> Yes <input type="checkbox"/> No
		<input type="checkbox"/> Cash <input type="checkbox"/> In-Kind	<input type="checkbox"/> Yes <input type="checkbox"/> No
		<input type="checkbox"/> Cash <input type="checkbox"/> In-Kind	<input type="checkbox"/> Yes <input type="checkbox"/> No
		<input type="checkbox"/> Cash <input type="checkbox"/> In-Kind	<input type="checkbox"/> Yes <input type="checkbox"/> No

19. If matching funds or in-kind contributions listed above are not yet secured, please describe the process remaining to secure the funds and the anticipated timeline to do so, (250 words max.):

The Mercury Connects | Calhoun project cost is \$480,000.00, with matching funds from Mercury Wireless of \$120,000.00, and a request for grant funds of \$360,000.00. Mercury Wireless will provide its matching funds with cash generated from Mercury Wireless Inc. and subsidiaries' internal revenues, as demonstrated in our 2018 audited financials included with Attachment 7 – Audited Financial Statements. Additionally, the Company will utilize internal revenues from anticipated market capture as demonstrated in Attachment 9 – Five Year Project Forecast. These internal funds along with the grant proceeds from the Connecting Michigan Communities Grant Program will allow Mercury to meet its build out obligations and deliver broadband Internet to rural communities in the project area. Included with Attachment 4 is the 2018 Consolidated Statement of Cash Flows, and the Five-Year Project Forecast.

20. Project Budget: Please use the following table to provide a budget for the proposed project. Please use the recommended categories in the table where possible, creating other categories where anticipated expenses do not fall within one of the recommended categories.

Use of Funds	Match Amount	Grant Amount	Total
Buildings and Labor	\$7,000.00	\$21,000.00	\$28,000.00
Last Mile Construction Labor	\$4,375.00	\$13,125.00	\$17,500.00
Middle Mile Construction Labor	\$2,625.00	\$7,875.00	\$10,500.00
Construction Material	\$0.00	\$0.00	\$0.00
Customer Premise Equipment	\$33,750.00	\$101,250.00	\$135,000.00
Customer Premise Installation	\$16,250.00	\$48,750.00	\$65,000.00
Electronics	\$49,875.00	\$149,625.00	\$199,500.00
Permits	\$875.00	\$2,625.00	\$3,500.00
Professional Services and Engineering	\$5,250.00	\$15,750.00	\$21,000.00
Other:			\$0.00
Other:			\$0.00
Other:			\$0.00
Other:			\$0.00
Other:			\$0.00
<b>Total</b>			<b>\$480,000.00</b>

21. Please briefly describe why this project needs funding from the CMIC Grant program and why the project could not proceed without this funding, (250 words max.):

Access to fast, reliable, and unlimited broadband Internet is critical in allowing our communities to economically flourish. In 2018 Mercury Wireless was selected to participate in the FCC's Connect America Fund Phase II initiative, with funding awarded in select areas of Berrien, Cass, and St. Joseph county Michigan. The purpose of this FCC funding is to build out advanced networks capable of 25 Mbps DL by 3Mbps UL for underserved rural communities. Funding partnership with the state of Michigan will allow Mercury Wireless to further accelerate its time to market and build on the momentum of the FCC's CAF II initiative. Funding from the CMIC Grant Program will allow the Company to improve service levels from 25 Mbps by 3 Mbps to 100 Mbps by 20Mbps for areas contiguous to the CAF II network in Berrien, Cass, and St. Joseph county, as well as extend the network further to serve more rural residents. Mercury estimates that without this funding partnership, the infrastructure improvements proposed in this project may take an additional 5 years, further constraining the development of these rural communities and slowing progress towards Michigan's goal of a high-speed, secure, and connected state. Additionally, the requested funding will help to eliminate several cost barriers associated with connecting rural communities. Mercury is confident that this funding partnership will improve the quality of life for all Michiganders in the proposed service areas, in addition to spurring more competition among rural carriers.

### **Experience and Financial Wherewithal**

*Attachment 5: Applicant organizational chart*

Name of Attachment 5:

MercuryWirelessIndianaLLC\_Attachment\_5

*Attachment 6: Resumes of key officers, management personnel, and proposed project management team*

Name of Attachment 6:

MercuryWirelessIndianaLLC\_Attachment\_6

22. Please provide a brief history of your organization including experience relevant to the proposed project, (250 words max.):

Mercury Wireless was founded in Topeka, KS in September 2007 after recognizing a need for broadband Internet access in rural America and seeing a lack of viable options. The Company began building out a Broadband Wireless Access (BWA) network, a hybrid approach to serve these "last-mile" customers. The company connected its first subscriber December 28, 2007. Over the next several years the network continued to expand through organic customer growth and acquisition of other telecommunications companies. In 2014 the Company launched its second network in Indiana utilizing new technologies and the methods developed to service its Kansas market. This second network has grown to encompass most of northeast Indiana and is ready to expand further into Michigan. In 2018 the Company participated in the Connect America Phase II Auction 903 and was awarded support to help build out rural broadband infrastructure in rural Michigan beginning in Berrien, Cass, and St. Joseph counties. Many of Mercury's employees have been with the company since its inception in 2007. These employees possess an incredible insight and knowledge of everything Mercury, from managing the terrain of the network and the Company's footprint, establishing strategic relationships, planning and deploying numerous concurrent projects, and servicing its customer base. This experience will provide the technical capabilities and knowledge to repeat our success in Michigan, expanding further to connect underserved communities.

*Attachment 7: Audited financial statements*

Name of Attachment 7:

MercuryWirelessIndiana\_Attachment\_7



23. Please provide a brief statement to accompany your attached audited financial statements and documentation, (250 words max.):

Mercury Wireless has submitted consolidated financial statements for the years ending December 31, 2016, 2017 and 2018. These are calendar year financials for Mercury Wireless, Inc. and subsidiaries and are presented in accordance with U.S. generally accepted accounting principles. In 2017, Mercury Wireless switched audit firms to BKD, LLP. BKD added some industry expertise with their audit team, which enhanced Mercury's financial statement presentation. All related footnotes and disclosures accompany the financials.

### **Long-Term Viability and Scalability**

#### *Attachment 8: Evidence of network scalability*

Name of Attachment 8:

MercuryWirelessIndianaLLC\_Attachment\_8

24. Please provide a description and evidence that the proposed infrastructure is scalable to meet the anticipated future connectivity demands of the proposed service area. Please indicate the end-user connection speed to which the proposed network is designed to scale. This information must be certified by the equipment manufacturer or a professional engineer, (250 words max.):

Mercury Wireless will maintain maximum service levels of 100 Mbps x 20 Mbps with latency no more than 100ms during its initial deployment. The Company has selected Airspan as its partner for these deployments, and a certification letter regarding the capabilities of the proposed platform is included with Attachment\_8. The Company will install devices at the customer premises and monitor bandwidth availability during peak times. The devices will test back to the Company's core infrastructure as well as any sites the Michigan Department of Technology, Management, and Budget establishes as official test sites. As the network continues to grow and subscriber demand continues to increase the Company will follow a small cell off load model. Small cell sites will be deployed in areas with dense pockets of existing subscribers. The subscribers will be moved from the macro tower sites to the small cell solution, alleviating macro capacity to ensure a consistent experience for the Company's subscribers. Mercury Wireless' network has been designed to ensure forward compatibility with 5G technologies to provide future throughput improvements to the network. Some key characteristics of 5G networks include; more capacity per device with connections estimated to exceed 1Gbps, support for more simultaneous device connections, and higher capacity density. As emerging technologies become available Mercury will upgrade its infrastructure to support the increasing bandwidth demands of subscribers.

#### *Attachment 9: Five-year, stand-alone project financial plan/forecast*

Name of Attachment 9:

MercuryWirelessIndianaLLC\_Attachment\_9

*Attachment 10: Affidavit of commitment to offer the proposed service and cost in the proposed service area for a minimum of five years after project completion.*

Name of Attachment 10:

MercuryWirelessIndianaLLC\_Attachment\_10

25. Please provide a brief narrative to accompany your attached five-year stand-alone project financial plan/forecast, (400 words max.):

The five-year stand-alone project forecast is broken down into 3 sections, the Income Statement, Statement of Cash Flows, and Balance Sheet. The Income Statement demonstrates the operating income generated as sites are completed on the network, and customer installations begin. Revenue is not recognized until earned in accordance with US generally accepted accounting principles. Subscriber revenues increase across the course of the project based on Mercury's estimated market capture rate, which fluctuates by market based on several factors including local competition, poverty rates, household income, housing churn, and market demographics information made available by the U.S. Census Bureau. The Statement of Cash Flows outlines Mercury's operating, investing and financing activities for the project time-line, with a summary of the grant funds requested, the applicant match, and additional investment from Mercury Wireless for ineligible operational costs. The balance sheet demonstrates the financial stability and growth over the project timeline based on the projected build out with support from the program. Costs are distributed over this time-line to accelerate our time to market, and to target profitability for the project in year 4.

**Readiness**

*Attachment 11: Budgetary engineering designs, diagrams, and maps that show the proposed project. Design documents must clearly demonstrate the applicant's complete understanding of the project and ability to provide the proposed solution. This information must be certified by a Professional Engineer registered in Michigan.*

Name of Attachment 11:

MercuryWirelessIndianaLLC\_Attachment\_11

26. Please provide a brief statement to accompany your attached engineering designs, diagrams, and maps indicating your readiness to build, manage, and operate the proposed network, (250 words max.):

Mercury Wireless has thoughtfully prepared our attached engineering designs, diagrams, and maps to demonstrate our readiness to build out the proposed network. The Company's existing network infrastructure is currently ready to service areas of Berrien, Cass, St. Joseph, Branch, and Hillsdale county for the initial phases of deployments in Michigan. The Company intends to collocate on existing sites owned by its telecommunication real estate partners. Deployments will be accelerated by utilizing our real estate partners local knowledge for permitting, access, and structural analysis needed prior to deployment. Based on our existing partnerships, the Company believes sufficient infrastructure currently exists for it to utilize. If infrastructure at a given location is deemed inadequate, the Company will work with the local community to utilize existing structures from small sites or erecting new sites to meet its specific needs. The Company intends to utilize its existing work force during the initial phases of deployment and will establish a local office for managing and maintaining infrastructure, and the installation and maintenance of subscriber equipment. Customer service, support, and billing will continue to function out of Mercury's existing operational hubs located in Indiana and Kansas.

27. Please use the table below to complete a project schedule outlining individual tasks and their timing by quarter and year. All projects must be complete by September 30, 2023.

Task	2020			2021				2022				2023		
	Q2	Q3	Q4	Q1	Q2	Q3	Q4	Q1	Q2	Q3	Q4	Q1	Q2	Q3

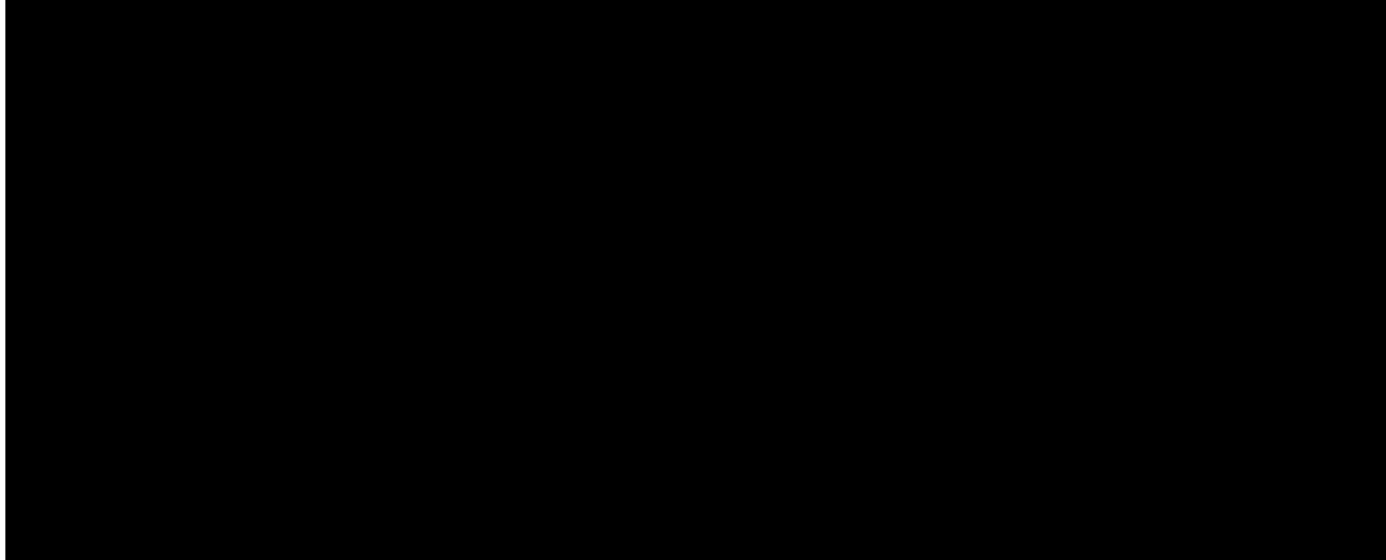

28. Please indicate the anticipated date upon which service to the last location in the proposed project area will be turned on:



29. Please list any factors that would change or delay the proposed schedule:

Delays in grant award notifications or decisions may change our project schedule.

30. Have all the required local/city/county/state approvals necessary for this project to proceed been obtained?

Yes  No

If not, what remains to be done and what is required for completing the process of obtaining approvals? Include this information in the project schedule.

Permitting approvals and structural analysis are pending contingent on a successful grant award and notification. Permitting and structural analysis will be handled by our real estate partners for collocation sites. When this option is not available our Field Operations team will obtain relevant permits for the respective county/city/township in which projects are located in to complete site construction.

31. Have state environmental review requirements been met, if applicable?

Yes  No

If not, what remains to be done and what is required for completing the process of obtaining approvals? Include this information in the project schedule.

Not applicable.

32. Does this project affect/is the project located in or near local, state, or federal historic or potentially historic, architectural, or archeological resources?  
Yes No

If not, what remains to be done and what is required for completing the process of obtaining approvals? Include this information in the project schedule.

Not applicable.

33. Please briefly describe how the proposed project will leverage existing broadband networks, where practical, or be built in conjunction with other broadband infrastructure project(s), (250 words max.):

Mercury Wireless will extend its existing wireless coverage into the southern portions of Berrien, Branch, Cass, and St. Joseph county for the initial phases of the project. The Company's Indiana network has been in operation since 2014 and has been developed to connect future network segments through fiberoptic middle mile backhaul or direct fiber termination to interconnect to our datacenters. For the CMIC Grant Program, the Company intends to use direct fiber termination at key collocation sites for access to its datacenters during its initial deployment timeline, with future segments utilizing wireless backhaul to interconnect to Mercury's datacenters. Additionally, through the FCC's Connect America Fund Phase II initiative, the Company will leverage additional projects already planned in Berrien, Cass, and St. Joseph county to further extend wireless coverage and improve service offerings. These projects will serve to bridge the Michigan and Indiana networks together taking advantage of existing infrastructure and resources. The Company will utilize its existing operations centers for sales, customer support, and administration functions.

### **Community and Economic Development**

*Attachment 12: Community letters of support*

Name of Attachment 12:

MercuryWirelessIndianaLLC\_Attachment\_12

*Attachment 13: Demonstration of customer interest in the proposed project*

Name of Attachment 13:

MercuryWirelessIndianaLLC\_Attachment\_13

34. Please provide a brief statement to accompany the demonstration of customer interest you have attached to this application. This description should include the method used for gauging customer interest and the results, (250 words max.):

Gathering evidence of community interest and support was critical to Mercury Wireless' determination of how to structure our proposed service area and details for our grant application. As part of our efforts to determine interest, Mercury Wireless constructed a questionnaire designed to gather feedback from residents, businesses, and community anchor institutions residing in the proposed service area. This questionnaire was posted on our web page, made available to the public, and distributed using targeted advertising campaigns over social media. Additionally, targeted E-mail communication was sent to residential, business, and community anchor institution E-mail addresses. Utilizing these communication methods potential respondents were directed to the questionnaire where they could voluntarily provide information as one method of demonstrating community support. The findings from feedback support the need for our project and the desire for improved broadband services in the proposed service area. A detailed description of the questionnaire, advertising campaign, and summary of the information can be found in Attachment 13.

*Attachment 14: Statements of impact/support from CAIs (if applicable)*

Name of Attachment 14:

MercuryWirelessIndianaLLC\_Attachment\_14

35. In the table below, please list the specific community anchor institutions (CAIs) to be served by the proposed project, (attach additional sheets if necessary). Please also attach statements or evidence from these CAIs regarding the benefits of the proposed connectivity solution and how it will impact the organizations.

CAI Name	Address	Type (e.g. healthcare, library, school, etc.)
First Kids Learning Center	12866 Beadle Lake Rd, Battle	School
Rice Creek Community Church	23906 L Dr N, Marshall	Church
Wilder Creek Conservation Club	19833 D Dr S, Marshall	Youth Center

*Attachment 15: Evidence of application for a SPIN (if applicable)*

Name of Attachment 15:

MercuryWirelessIndianaLLC\_Attachment\_15

36. If the proposed project includes connections to schools or libraries, please provide your SPIN or evidence of application for a SPIN from the FCC/Universal Service Administrative Company (USAC) and demonstration of your knowledge of E-rate and working with the FCC/USAC, (250 words max.):

Mercury Wireless Indiana, LLC.s SPIN number is 143051573. Through the USAC Schools and Libraries program, the Company has partnered with numerous schools and libraries to bring improved connectivity to the communities we serve. From the FCC Form 470 process to project completion, Mercury Wireless has been participating in the E-rate program since 2012. The Company has completed both small scale and large-scale deployments including; local area wired and wireless networks (Internal Connections and Managed Broadband Services), district wide digital phone system deployments, long range back haul solutions for interconnecting larger district segments and deploying high-speed internet (Data Transmission Services) across numerous districts. The Company has successfully maintained these relationships working to upgrade network infrastructure as the needs of our students and educators evolve and technologies advance. As rural communities are struggling to bridge the network connectivity gap, Mercury recognizes the importance of providing this critical infrastructure to the schools within our communities while striving to be the most cost effective and efficient solution. Affordability is a barrier for both schools and families.

37. Please briefly summarize how the proposed service will impact the following sectors in the community:

**Public safety:**

Broadband access increasingly important to the interoperability of police, fire, health, and crisis response entities. Examples include improved responsiveness of communication during disasters, communication with early warning systems, and providing communication network backups.

**Healthcare:**

Broadband access can provide residents the ability to utilize telemedicine and telehealth services. These services include but are not limited to; dentistry, counseling, physical and occupational therapy, home health care, and disease monitoring and management.

**Education:**

Broadband networks provide teachers and students access to a number of resources including web-based curriculum, video, photo, and music. This allows traditional and non-traditional students to participate in distance learning opportunities from any location that has broadband.

**Government entities:**

Broadband availability benefits government entities by promoting interaction with its citizens. Open communication, availability of information, and encouraging citizens to interact with their respective government entities helps to lower costs and engage communities.

**Libraries:**

Nearly half of all public libraries are in rural areas. They serve as resource centers and social meeting places for community organizations. Broadband availability allows these trusted public institutions to better serve communities with access to child education services, on-line resources, and digital literacy training programs.

*Attachment 16: Statements of impact/support from businesses (if applicable)*

Name of Attachment 16:

MercuryWirelessIndianaLLC\_Attachment\_16

38. Please provide a brief description of businesses needing improved broadband service in the proposed project area and the level of improvement needed. Please also attach statements or evidence from any impacted businesses regarding the benefits of the proposed connectivity solution and how it will impact the business, (250 words max.):

High-speed Internet access removes barriers created by distance and time, allowing residents, small businesses, telecommuters, and entrepreneurs to participate in a modern economy that reaches beyond their immediate area. Often rural businesses are restricted to local markets without access to broadband, limiting their reach and economic potential. When broadband is available it's often considerably more expensive for rural businesses than their urban counterparts. Making these services widely available, especially through wireless networks, at an affordable rate helps boost the economic potential of these businesses while also bolstering urban revitalization. This can lead to increases in job creation and entrepreneurship for the younger population, often reinvigorating communities previously blighted. Additionally, affordable access to wireless broadband services can significantly increase participation of businesses run out of the home, or recently established in rural locations away from existing infrastructure. In Attachment 16 you will find a list of businesses that will be significantly impacted by this project located in the census blocks identified as partially or wholly underserved. The blocks in this list represent underserved home-based businesses, small to medium size businesses, and farms.

39. If the proposed service area has a significant agricultural presence, please briefly describe how the proposed service will impact farmers and the agriculture community, (250 words max.):

Availability of fast and affordable broadband access is critical to modern agriculture, and often agriculture is overlooked in conversations about connecting rural businesses. According to the USDA an estimated 29% of farmers lack access to broadband or even basic Internet connectivity. Farmers and ranchers can use these services to follow commodity markets, communicate with vendors and customers, and for access to markets across the world. Agricultural technology is also rapidly advancing. Farmers are embracing these technological changes to become more efficient, effective, and economically and environmentally responsible. Precision agriculture, which can maximize yields, depends on broadband just as much as transportation methods for moving product, and many of the latest yield maximizing techniques are dependent on this technology. Farmers also face many challenges with regulatory compliance and the need for a fast, reliable, and unlimited connection to support these efforts. Broadband wireless access networks are a critical component in connecting these farmers to an affordable and quickly deployable high-speed internet connection, and these services are increasingly critical to the success of many farming businesses.

40. Is broadband included in a local, county, or regional economic development plan, master plan, or similar up-to-date planning document, or does the community in which the proposed service is to be deployed have a specific broadband/technology plan in place?

Yes  No

If yes, please list the name of the relevant plan and the jurisdiction implementing the plan.

Plan Name:

Jurisdiction:

**Affordability and Service Limitations**

41. Using the table below, please indicate the download and upload speeds of the services to be offered in the proposed service area offered over the initial five years of the project (attach additional sheets if necessary). The non-discounted/rack rate monthly pricing of unbundled internet-only service should be included for each service offered, as well as the monthly data allowance for customers (if applicable):

Download Speed (Mbps)	Upload Speed (Mbps)	Monthly Cost	Monthly Data Allowance (GB)
10 Mbps	2 Mbps		Unlimited
30 Mbps	6 Mbps		Unlimited
100 Mbps	20 Mbps		Unlimited

42. Do you participate in the federal Lifeline program?  
 Yes  No



43. Do you plan to offer a lower-cost monthly subscription plan for low-income households in the proposed service area?  
 Yes  No

If yes, please briefly describe the program including the type of service to be offered, the monthly cost for qualifying household, and how you plan to determine household eligibility for such a program, (400 words max.):

Not applicable.

44. Does any of the proposed service area include (wholly or partially) an eligible distressed area (a list of eligible distressed areas can be found here: [https://www.michigan.gov/mshda/0,4641,7-141-48987\\_75951-181277--,00.html](https://www.michigan.gov/mshda/0,4641,7-141-48987_75951-181277--,00.html))?  
 Yes  No

If yes, please list the distressed community(ies) impacted by the proposed service area:  
Albion, Battle Creek, Marshall, and Sheridan Township

## Adoption Strategy

45. Please briefly describe any proposed digital literacy training events, materials, and/or resources that will be provided to residents or businesses impacted by the proposed connectivity. This description should include commitments from any partners included in the digital literacy training and the anticipated outcomes from related activities, (400 words max.):

Mercury Wireless recognizes the need for continually improving access to resources and information for its subscribers. In Q1 2020 Mercury will be launching its Digital Well Being resource page. The goal of this addition to our web site available at [www3.mercurywireless.com/digital-well-being](http://www3.mercurywireless.com/digital-well-being) is to provide materials and resources to current subscribers, potential subscribers, and anyone interested in learning more about the impacts and benefits of a broadband connection. The Digital Well Being resource page will contain internally developed materials and public resources aimed at improving digital literacy by promoting knowledge on how to leverage a broadband Internet connection to benefit families and businesses. Resources available on the Digital Well Being page will include knowledgebases and white papers published online, information on the benefits for community revitalization and economic development, government resources such as local broadband and economic development plans, resources for education and career development, information on access to telehealth and telemedicine applications, and computer literacy training. This information will be updated regularly as new resources become available or are developed internally by the Company. Mercury Wireless is also in the process of developing local partnerships with various organizations in the education and health care industry to promote learning opportunities, training events, availability of new services, and new applications as they become available. These partnerships include technical schools, universities, health care systems, and private organizations who share a similar goal of promoting digital literacy, especially in rural communities. Since Mercury Wireless provides service to a mostly rural population, we anticipate the access to this resource page will generate a greater awareness among current and potential subscribers on how to leverage a broadband connection to improve the wellbeing of rural Michiganders.

46. Please briefly describe the materials and method(s) to be used for providing residents and businesses with information promoting the use of an internet connection for improving quality of life, access to resources, economic opportunity, etc., in the proposed service area. Partnerships with local CAIs that build awareness for enriching online opportunities for residents and businesses are highly encouraged. Examples of these opportunities include, but are not limited to, telehealth applications, access to government services, e-learning, job and career readiness programs, public safety information, cybersecurity training, etc., (400 words max.):

In Q1 2020 Mercury will be launching its Digital Well Being resource page. The goal of this addition to our web site available at [www3.mercurywireless.com/digital-well-being](http://www3.mercurywireless.com/digital-well-being) is to provide materials and resources to current subscribers, potential subscribers, and anyone interested in learning more about the impacts and benefits of a broadband connection. The Digital Well Being resource page will contain internally developed materials and public resources aimed at improving digital literacy by promoting knowledge on how to leverage a broadband Internet connection to benefit families and businesses. The Company will promote awareness of this resource page utilizing several digital and physical distribution methods. Beginning during the construction phase of the project, the Company will leverage social media platforms to promote awareness of the project and connect potential subscribers to the Digital Well Being page. This will be accomplished through targeted advertising utilizing Facebook and other social networks. The second phase of digital distribution will be a direct E-mail campaign promoting awareness of the project and connecting potential residential and business subscribers with Mercury's Digital Well Being page. The third phase which will take place nearing project completion will utilize a direct-mail campaign through EDDM promoting awareness of the new services available and the Digital Well Being page. The fourth and final phase of distribution will be electronic communication provided to new subscribers confirming the details of their pending installation and directing them to the resources available on our Digital Well Being page. The Company will also work with local government agencies, educational institutions, and public health and safety entities to increase awareness of the program, share information, and collaborate on resources.



STATE OF MICHIGAN

GRETCHEN WHITMER  
GOVERNOR

DEPARTMENT OF TECHNOLOGY, MANAGEMENT & BUDGET  
LANSING

TRICIA L. FOSTER  
DIRECTOR

## **Connecting Michigan Communities Grant Confidential Treatment Form and the Freedom of Information Act**

CONFIDENTIAL TREATMENT FORM AND THE FREEDOM OF INFORMATION ACT. All portions of the Applicant's proposal and resulting award are subject to disclosure as required under Michigan's Freedom of Information Act (FOIA), MCL 15.231, et seq. However, some information may be exempt from disclosure. Under MCL 18.1261(13)(b), records containing "a trade secret as defined under section 2 of the uniform trade secrets act, 1998 PA 448, MCL 445.1902," are exempt from disclosure under FOIA. In addition, "financial or proprietary information" submitted with a proposal is exempt from disclosure under FOIA. An applicant's failure to comply with this Section is grounds for rejecting an applicant's proposal as non-responsive. As a part of its proposal, each applicant must follow the procedure below.

1. **SUBMIT A COMPLETED "CONFIDENTIAL TREATMENT FORM" (CT FORM) WITH YOUR APPLICATION.** Completion and submission of the CT Form is required regardless of whether the Applicant seeks confidential treatment of information. Failure to submit a completed CT Form may be cause for disqualification from the application process.
  - a. Complete and sign Section 1 of the CT Form if the Applicant does NOT request confidential treatment of information contained in its proposal; or
  - b. Complete and sign Section 2 of the CT Form if the Applicant requests confidential treatment of certain information. Applicant must also submit a "Public Copy" of the proposal with the trade secret, financial, and proprietary information redacted and clearly labeled as the "Public Copy."
2. **FOIA REQUESTS.** If a FOIA request is made for an Applicant's proposal, the Public Copy may be distributed to the public along with the Applicant's CT Form. The CT Form is a public document and serves as an explanation for the redactions to the Public Copy. Do not put any trade secret, financial, or proprietary information in the CT Form. Do not redact the CT Form itself.
3. **NO ADVICE.** The State will not advise an Applicant as to the nature or content of documents entitled to protection from disclosure under FOIA or other laws, as to the interpretation of such laws, or as to the definition of trade secret or financial or proprietary information. Nothing contained in this provision will modify or amend requirements and obligations imposed on the State by FOIA or other applicable law.
4. **FAILURE TO REQUEST CONFIDENTIAL TREATMENT.** Failure to request material be treated as confidential as specified herein relieves the State, its agencies, and personnel from any responsibility for maintaining material in confidence.
5. Applicants containing a request to maintain an entire proposal as confidential may be rejected as non-responsive. The State reserves the right to determine whether material designated as

exempt by an Applicant falls under MCL 18.1261 or other applicable FOIA exemptions. If a FOIA request is made for materials that the Applicant has identified as trade secret, financial, or proprietary information, the State has the final authority to determine whether the materials are exempt from disclosure under FOIA.

6. Applicant forever releases the State, its departments, subdivisions, officers, and employees from all claims, rights, actions, demands, damages, liabilities, expenses and fees, which arise out of or relate to the disclosure of all or a portion of an Applicant's proposal submitted under this grant program. Applicant must defend, indemnify and hold the State, its departments, subdivisions, officers, and employees harmless, without limitation, from and against all actions, claims, losses, liabilities, damages, costs, attorney fees, and expenses (including those required to establish the right to indemnification), arising out of or relating to any FOIA request, including potential litigation and appeals, related to the portion of Applicant's proposal submitted under this grant program that the Applicant has identified as a trade secret, or financial or proprietary information. The State will notify the Applicant in writing if indemnification is sought. The State is entitled to: (i) regular updates on proceeding status; (ii) participate in the defense of the proceeding; (iii) employ its own counsel; and to (iv) retain control of the defense, or any portion thereof, if the State deems necessary. Applicant will not, without the State's written consent (not to be unreasonably withheld), settle, compromise, or consent to the entry of any judgment in or otherwise seek to terminate any claim, action, or proceeding. If a State employee, official, or law is involved or challenged, the State may control the defense of that portion of the claim. Any litigation activity on behalf of the State, or any of its subdivisions under this Section, must be coordinated with the Department of Attorney General. An attorney designated to represent the State may not do so until approved by the Michigan Attorney General and appointed as a Special Assistant Attorney General.

## CONFIDENTIAL TREATMENT FORM (CT FORM)

**INSTRUCTIONS:** Complete either Section 1 or Section 2 of this CT Form and sign where indicated. This CT Form must be signed by the individual who signed the grant application. A completed CT Form must be submitted with your proposal, regardless of whether your proposal contains confidential information. Failure to submit a completed CT Form with your application is grounds for rejecting the proposal as non-responsive. See Section 4.1.5 of the CMIC Grant Overview for additional information.

---

### **Section 1. Confidential Treatment Is Not Requested**

This section must be completed, signed, and submitted with the proposal if the Applicant does not request confidential treatment of any material contained in the proposal.

By signing below, the Applicant affirms that confidential treatment of material contained in the proposal is not requested.

\_\_\_\_\_  
Project Name

\_\_\_\_\_  
Signature

\_\_\_\_\_  
Date

\_\_\_\_\_  
[Printed Name]

\_\_\_\_\_  
[Title]

\_\_\_\_\_  
[Company]

---

### **Section 2. Confidential Treatment Is Requested**

The section must be completed, signed, and submitted with the proposal if bidder requests confidential treatment of any material contained in the proposal. Submission of a completed CT Form is required to request confidential treatment.

Provide the information in the table below. Applicant may add rows or additional pages using the same format shown in the table. Applicant must specifically identify the information to be protected as confidential and state the reasons why protection is necessary. The CT Form will not be considered fully complete unless, for each confidentiality request, the Applicant: (1) identifies whether the material is a trade secret (TS), financial information (FI), or proprietary information (PI); (2) explains the specific legal grounds that support treatment of the material as TS, FI, or PI; and (3) provides the contact information for the person at bidder's organization authorized to respond to inquiries by the State concerning the material. Applicants must not simply cite to an applicable act or case name; rather, bidders must provide a complete justification as to how the material falls within the scope of an applicable act or relevant case law.

Application page #, paragraph #, and section #	State whether the material is a trade secret (TS), financial information (FI), or proprietary information (PI)	Explain the specific grounds in State or other applicable law which supports treatment of the material as TS, FI, or PI. Do not simply cite to the applicable act. Provide a complete justification as to how the material falls within the scope of the applicable act or relevant case law.	Provide the Applicant contact information
Attachment 4 – Pages 2, 3, and 4	Financial Information	Mercury Wireless, Inc. and Subsidiaries consolidated 2017 and 2018 financials. Mercury Wireless Indiana, LLC. 5-year financial forecast. FOIA Act 442, section 15.243 (f) – disclosure of sensitive financial information will put the company at a competitive disadvantage, providing insight into the Company's operations that would allow a competing entity to disrupt or prevent successful deployment.	Matthew Sams Chief of Staff <a href="mailto:Matthew.sams@mercurywireless.com">Matthew.sams@mercurywireless.com</a> (800) 354-4915 x504
Attachment 7 – Page 3, paragraph 3	Financial Information	Statement of organization accounting principles and specific dates for adoption of methods. FOIA Act 442, section 15.243 (f) – disclosure of sensitive financial information will put the company at a competitive disadvantage, providing insight into the Company's operations that would allow a competing entity to disrupt or prevent successful deployment.	Matthew Sams Chief of Staff <a href="mailto:Matthew.sams@mercurywireless.com">Matthew.sams@mercurywireless.com</a> (800) 354-4915 x504
Attachment 7 – Page 4	Financial Information	Financial information for Mercury Wireless, Inc. & Subsidiaries consolidated balance sheets for years 2015 and 2016. FOIA Act 442, section 15.243 (f) – disclosure of sensitive financial information will put the company at a competitive disadvantage, providing insight into the Company's operations that would allow a competing entity to disrupt or prevent successful deployment.	Matthew Sams Chief of Staff <a href="mailto:Matthew.sams@mercurywireless.com">Matthew.sams@mercurywireless.com</a> (800) 354-4915 x504
Attachment 7 – Page 5	Financial Information	Financial information for Mercury Wireless, Inc. & Subsidiaries consolidated statement of operations for years 2015 and 2016. FOIA Act 442, section 15.243 (f) – disclosure of sensitive financial information will put the company at a competitive disadvantage, providing insight into the Company's operations that would allow a competing entity to disrupt or prevent successful deployment.	Matthew Sams Chief of Staff <a href="mailto:Matthew.sams@mercurywireless.com">Matthew.sams@mercurywireless.com</a> (800) 354-4915 x504
Attachment 7 – Page 6	Financial Information	Financial information for Mercury Wireless, Inc. & Subsidiaries consolidated statement of changes in stockholders' equity for years 2015 and 2016. FOIA Act 442, section 15.243 (f) – disclosure of sensitive financial information will put the company at a competitive disadvantage, providing insight into the Company's operations that would allow a competing entity to disrupt or prevent successful deployment.	Matthew Sams Chief of Staff <a href="mailto:Matthew.sams@mercurywireless.com">Matthew.sams@mercurywireless.com</a> (800) 354-4915 x504

Attachment 7 – Page 7	Financial Information	Financial information for Mercury Wireless, Inc. & Subsidiaries consolidated statements of cash flows for years 2015 and 2016. FOIA Act 442, section 15.243 (f) – disclosure of sensitive financial information will put the company at a competitive disadvantage, providing insight into the Company’s operations that would allow a competing entity to disrupt or prevent successful deployment.	Matthew Sams Chief of Staff <a href="mailto:Matthew.sams@mercurywireless.com">Matthew.sams@mercurywireless.com</a> (800) 354-4915 x504
Attachment 7 – Page 8, paragraphs 5 and 6	Financial Information	AR schedule, amounts for allowance for doubtful accounts, and property and equipment depreciation schedules. FOIA Act 442, section 15.243 (f) – disclosure of sensitive financial information will put the company at a competitive disadvantage, providing insight into the Company’s operations that would allow a competing entity to disrupt or prevent successful deployment.	Matthew Sams Chief of Staff <a href="mailto:Matthew.sams@mercurywireless.com">Matthew.sams@mercurywireless.com</a> (800) 354-4915 x504
Attachment 7 – Page 9, paragraphs 2 and 7	Financial Information	Depreciation schedule for various types of assets, and advertising expenses incurred for years ending December 31, 2015 and 2016. FOIA Act 442, section 15.243 (f) – disclosure of sensitive financial information will put the company at a competitive disadvantage, providing insight into the Company’s operations that would allow a competing entity to disrupt or prevent successful deployment.	Matthew Sams Chief of Staff <a href="mailto:Matthew.sams@mercurywireless.com">Matthew.sams@mercurywireless.com</a> (800) 354-4915 x504
Attachment 7 – Page 10, sections 1, 2, and 3	Financial Information	Property and equipment, CPEs, base stations, and tower supplies amounts for 2015 and 2016. Intangible asset categories and amounts for 2015 and 2016. FOIA Act 442, section 15.243 (f) – disclosure of sensitive financial information will put the company at a competitive disadvantage, providing insight into the Company’s operations that would allow a competing entity to disrupt or prevent successful deployment.	Matthew Sams Chief of Staff <a href="mailto:Matthew.sams@mercurywireless.com">Matthew.sams@mercurywireless.com</a> (800) 354-4915 x504
Attachment 7 – Page 11, sections 1, 2, and 3	Financial Information	Intangible assets, goodwill, and long-term debt amounts for 2015 and 2016. FOIA Act 442, section 15.243 (f) – disclosure of sensitive financial information will put the company at a competitive disadvantage, providing insight into the Company’s operations that would allow a competing entity to disrupt or prevent successful deployment.	Matthew Sams Chief of Staff <a href="mailto:Matthew.sams@mercurywireless.com">Matthew.sams@mercurywireless.com</a> (800) 354-4915 x504
Attachment 7 – Page 12, section 1, paragraphs 1, 3, 4, and 5	Financial Information	Amortization amounts, long term debt amounts, and financial information regarding the structure and amounts for lines of credit for 2015 and 2016. FOIA Act 442, section 15.243 (f) – disclosure of sensitive financial information will put the company at a competitive disadvantage, providing insight into the Company’s operations that would allow a competing entity to disrupt or prevent successful deployment.	Matthew Sams Chief of Staff <a href="mailto:Matthew.sams@mercurywireless.com">Matthew.sams@mercurywireless.com</a> (800) 354-4915 x504
Attachment 7 – Page 13, sections 1, 2, and 3	Financial Information	Lines of credit, operating leases, and cash flows for 2015 and 2016. FOIA Act 442, section 15.243 (f) – disclosure of sensitive financial information will put the company at a competitive disadvantage, providing insight into the Company’s operations that would allow a competing entity to disrupt or prevent successful deployment.	Matthew Sams Chief of Staff <a href="mailto:Matthew.sams@mercurywireless.com">Matthew.sams@mercurywireless.com</a> (800) 354-4915 x504

Attachment 7 – Page 14, sections 1, 2, and 3	Financial Information	Related party transactions, non-cash transactions, and acquisitions for 2015 and 2016. FOIA Act 442, section 15.243 (f) – disclosure of sensitive financial information will put the company at a competitive disadvantage, providing insight into the Company’s operations that would allow a competing entity to disrupt or prevent successful deployment.	Matthew Sams Chief of Staff <a href="mailto:Matthew.sams@mercurywireless.com">Matthew.sams@mercurywireless.com</a> (800) 354-4915 x504
Attachment 7 – Page 15, paragraphs 1 and 2	Financial Information	Acquisitions and subsequent events for 2015 and 2016. FOIA Act 442, section 15.243 (f) – disclosure of sensitive financial information will put the company at a competitive disadvantage, providing insight into the Company’s operations that would allow a competing entity to disrupt or prevent successful deployment.	Matthew Sams Chief of Staff <a href="mailto:Matthew.sams@mercurywireless.com">Matthew.sams@mercurywireless.com</a> (800) 354-4915 x504
Attachment 7 – Page 18, section 1	Financial Information	Mercury Wireless, Inc. and Subsidiaries consolidated selling, general, and administrative expenses. FOIA Act 442, section 15.243 (f) – disclosure of sensitive financial information will put the company at a competitive disadvantage, providing insight into the Company’s operations that would allow a competing entity to disrupt or prevent successful deployment.	Matthew Sams Chief of Staff <a href="mailto:Matthew.sams@mercurywireless.com">Matthew.sams@mercurywireless.com</a> (800) 354-4915 x504
Attachment 7 – Page 23	Financial Information	Mercury Wireless, Inc. and Subsidiaries consolidated balance sheet for 2017. FOIA Act 442, section 15.243 (f) – disclosure of sensitive financial information will put the company at a competitive disadvantage, providing insight into the Company’s operations that would allow a competing entity to disrupt or prevent successful deployment.	Matthew Sams Chief of Staff <a href="mailto:Matthew.sams@mercurywireless.com">Matthew.sams@mercurywireless.com</a> (800) 354-4915 x504
Attachment 7 – Page 24	Financial Information	Mercury Wireless, Inc. and Subsidiaries liabilities and stockholder’ equity for 2017. FOIA Act 442, section 15.243 (f) – disclosure of sensitive financial information will put the company at a competitive disadvantage, providing insight into the Company’s operations that would allow a competing entity to disrupt or prevent successful deployment.	Matthew Sams Chief of Staff <a href="mailto:Matthew.sams@mercurywireless.com">Matthew.sams@mercurywireless.com</a> (800) 354-4915 x504
Attachment 7 – Page 25	Financial Information	Mercury Wireless, Inc. and Subsidiaries consolidated statement of income for 2017. FOIA Act 442, section 15.243 (f) – disclosure of sensitive financial information will put the company at a competitive disadvantage, providing insight into the Company’s operations that would allow a competing entity to disrupt or prevent successful deployment.	Matthew Sams Chief of Staff <a href="mailto:Matthew.sams@mercurywireless.com">Matthew.sams@mercurywireless.com</a> (800) 354-4915 x504
Attachment 7 – Page 26	Financial Information	Mercury Wireless, Inc. and Subsidiaries consolidated statement of stockholders’ equity for 2017. FOIA Act 442, section 15.243 (f) – disclosure of sensitive financial information will put the company at a competitive disadvantage, providing insight into the Company’s operations that would allow a competing entity to disrupt or prevent successful deployment.	Matthew Sams Chief of Staff <a href="mailto:Matthew.sams@mercurywireless.com">Matthew.sams@mercurywireless.com</a> (800) 354-4915 x504



Attachment 7 – Page 27	Financial Information	Mercury Wireless, Inc. and Subsidiaries consolidated statement of cash flows. FOIA Act 442, section 15.243 (f) – disclosure of sensitive financial information will put the company at a competitive disadvantage, providing insight into the Company’s operations that would allow a competing entity to disrupt or prevent successful deployment.	Matthew Sams Chief of Staff <a href="mailto:Matthew.sams@mercurywireless.com">Matthew.sams@mercurywireless.com</a> (800) 354-4915 x504
Attachment 7 – Page 28, paragraphs 4 and 7	Financial Information	Cash amounts, pre-paid expenses, and other expenses for 2017. AR schedule. FOIA Act 442, section 15.243 (f) – disclosure of sensitive financial information will put the company at a competitive disadvantage, providing insight into the Company’s operations that would allow a competing entity to disrupt or prevent successful deployment.	Matthew Sams Chief of Staff <a href="mailto:Matthew.sams@mercurywireless.com">Matthew.sams@mercurywireless.com</a> (800) 354-4915 x504
Attachment 7 – Page 29, paragraph 1	Financial Information	Property, plant, and equipment depreciation schedules. FOIA Act 442, section 15.243 (f) – disclosure of sensitive financial information will put the company at a competitive disadvantage, providing insight into the Company’s operations that would allow a competing entity to disrupt or prevent successful deployment.	Matthew Sams Chief of Staff <a href="mailto:Matthew.sams@mercurywireless.com">Matthew.sams@mercurywireless.com</a> (800) 354-4915 x504
Attachment 7 – Page 30, paragraph 7	Financial Information	Stock option plan details. FOIA Act 442, section 15.243 (f) – disclosure of sensitive financial information will put the company at a competitive disadvantage, providing insight into the Company’s operations that would allow a competing entity to disrupt or prevent successful deployment.	Matthew Sams Chief of Staff <a href="mailto:Matthew.sams@mercurywireless.com">Matthew.sams@mercurywireless.com</a> (800) 354-4915 x504
Attachment 7 – Page 31	Financial Information	Common control transaction information. Assets, liabilities, and stockholders’ equity amounts for 2017. FOIA Act 442, section 15.243 (f) – disclosure of sensitive financial information will put the company at a competitive disadvantage, providing insight into the Company’s operations that would allow a competing entity to disrupt or prevent successful deployment.	Matthew Sams Chief of Staff <a href="mailto:Matthew.sams@mercurywireless.com">Matthew.sams@mercurywireless.com</a> (800) 354-4915 x504
Attachment 7 – Page 32, sections 1 and 2	Financial Information	Property, plant, and equipment amounts for 2017. Intangible assets and goodwill amounts for 2017. FOIA Act 442, section 15.243 (f) – disclosure of sensitive financial information will put the company at a competitive disadvantage, providing insight into the Company’s operations that would allow a competing entity to disrupt or prevent successful deployment.	Matthew Sams Chief of Staff <a href="mailto:Matthew.sams@mercurywireless.com">Matthew.sams@mercurywireless.com</a> (800) 354-4915 x504
Attachment 7 – Page 33	Financial Information	Estimated intangible asset and goodwill amortization amounts for 2017. Long-term debt summary for 2017. FOIA Act 442, section 15.243 (f) – disclosure of sensitive financial information will put the company at a competitive disadvantage, providing insight into the Company’s operations that would allow a competing entity to disrupt or prevent successful deployment.	Matthew Sams Chief of Staff <a href="mailto:Matthew.sams@mercurywireless.com">Matthew.sams@mercurywireless.com</a> (800) 354-4915 x504

Attachment 7 – Page 34	Financial Information	Notes to consolidated financial statements, 2017. FOIA Act 442, section 15.243 (f) – disclosure of sensitive financial information will put the company at a competitive disadvantage, providing insight into the Company’s operations that would allow a competing entity to disrupt or prevent successful deployment.	Matthew Sams Chief of Staff <a href="mailto:Matthew.sams@mercurywireless.com">Matthew.sams@mercurywireless.com</a> (800) 354-4915 x504
Attachment 7 – Page 35	Financial Information	Operating leases, employee benefits plan, and stock option plan information for 2017. FOIA Act 442, section 15.243 (f) – disclosure of sensitive financial information will put the company at a competitive disadvantage, providing insight into the Company’s operations that would allow a competing entity to disrupt or prevent successful deployment.	Matthew Sams Chief of Staff <a href="mailto:Matthew.sams@mercurywireless.com">Matthew.sams@mercurywireless.com</a> (800) 354-4915 x504
Attachment 7 – Page 36	Financial Information	Summary of option activity under the Plan as of December 31, 2017. FOIA Act 442, section 15.243 (f) – disclosure of sensitive financial information will put the company at a competitive disadvantage, providing insight into the Company’s operations that would allow a competing entity to disrupt or prevent successful deployment.	Matthew Sams Chief of Staff <a href="mailto:Matthew.sams@mercurywireless.com">Matthew.sams@mercurywireless.com</a> (800) 354-4915 x504
Attachment 7 – Page 41	Financial Information	Mercury Wireless, Inc. and Subsidiaries consolidated balance sheets for 2017 and 2018. Assets. FOIA Act 442, section 15.243 (f) – disclosure of sensitive financial information will put the company at a competitive disadvantage, providing insight into the Company’s operations that would allow a competing entity to disrupt or prevent successful deployment.	Matthew Sams Chief of Staff <a href="mailto:Matthew.sams@mercurywireless.com">Matthew.sams@mercurywireless.com</a> (800) 354-4915 x504
Attachment 7 – Page 42	Financial Information	Mercury Wireless, Inc. and Subsidiaries consolidated balance sheets for 2017 and 2018 continued. Liabilities and stockholders’ equity. FOIA Act 442, section 15.243 (f) – disclosure of sensitive financial information will put the company at a competitive disadvantage, providing insight into the Company’s operations that would allow a competing entity to disrupt or prevent successful deployment.	Matthew Sams Chief of Staff <a href="mailto:Matthew.sams@mercurywireless.com">Matthew.sams@mercurywireless.com</a> (800) 354-4915 x504
Attachment 7 – Page 43	Financial Information	Mercury Wireless, Inc. and Subsidiaries consolidated statements of income for 2017 and 2018. FOIA Act 442, section 15.243 (f) – disclosure of sensitive financial information will put the company at a competitive disadvantage, providing insight into the Company’s operations that would allow a competing entity to disrupt or prevent successful deployment.	Matthew Sams Chief of Staff <a href="mailto:Matthew.sams@mercurywireless.com">Matthew.sams@mercurywireless.com</a> (800) 354-4915 x504
Attachment 7 – Page 44	Financial Information	Mercury Wireless, Inc. and Subsidiaries consolidated statements of stockholders’ equity for 2017 and 2018. FOIA Act 442, section 15.243 (f) – disclosure of sensitive financial information will put the company at a competitive disadvantage, providing insight into the Company’s operations that would allow a competing entity to disrupt or prevent successful deployment.	Matthew Sams Chief of Staff <a href="mailto:Matthew.sams@mercurywireless.com">Matthew.sams@mercurywireless.com</a> (800) 354-4915 x504

Attachment 7 – Page 45	Financial Information	Mercury Wireless, Inc. and Subsidiaries consolidated statements of cash flows for 2017 and 2018. FOIA Act 442, section 15.243 (f) – disclosure of sensitive financial information will put the company at a competitive disadvantage, providing insight into the Company’s operations that would allow a competing entity to disrupt or prevent successful deployment.	Matthew Sams Chief of Staff <a href="mailto:Matthew.sams@mercurywireless.com">Matthew.sams@mercurywireless.com</a> (800) 354-4915 x504
Attachment 7 – Page 46, paragraphs 4 and 5	Financial Information	Cash information and AR schedule. FOIA Act 442, section 15.243 (f) – disclosure of sensitive financial information will put the company at a competitive disadvantage, providing insight into the Company’s operations that would allow a competing entity to disrupt or prevent successful deployment.	Matthew Sams Chief of Staff <a href="mailto:Matthew.sams@mercurywireless.com">Matthew.sams@mercurywireless.com</a> (800) 354-4915 x504
Attachment 7 – Page 47, paragraphs 1 and 2	Financial Information	Prepaid and other expenses, depreciation and amortization schedules. FOIA Act 442, section 15.243 (f) – disclosure of sensitive financial information will put the company at a competitive disadvantage, providing insight into the Company’s operations that would allow a competing entity to disrupt or prevent successful deployment.	Matthew Sams Chief of Staff <a href="mailto:Matthew.sams@mercurywireless.com">Matthew.sams@mercurywireless.com</a> (800) 354-4915 x504
Attachment 7 – Page 48, paragraph 7	Financial Information	Stock option plan information. FOIA Act 442, section 15.243 (f) – disclosure of sensitive financial information will put the company at a competitive disadvantage, providing insight into the Company’s operations that would allow a competing entity to disrupt or prevent successful deployment.	Matthew Sams Chief of Staff <a href="mailto:Matthew.sams@mercurywireless.com">Matthew.sams@mercurywireless.com</a> (800) 354-4915 x504
Attachment 7 – Page 49, section 2	Financial Information	Common control transaction and financial details for assts, liabilities, and stockholders’ equity for 2017 and 2018. FOIA Act 442, section 15.243 (f) – disclosure of sensitive financial information will put the company at a competitive disadvantage, providing insight into the Company’s operations that would allow a competing entity to disrupt or prevent successful deployment.	Matthew Sams Chief of Staff <a href="mailto:Matthew.sams@mercurywireless.com">Matthew.sams@mercurywireless.com</a> (800) 354-4915 x504
Attachment 7 – Page 50, sections 1 and 2	Financial Information	Property, plant, and equipment amounts for 2017 and 2018. Intangible assets and goodwill amounts for 2017 and 2018. FOIA Act 442, section 15.243 (f) – disclosure of sensitive financial information will put the company at a competitive disadvantage, providing insight into the Company’s operations that would allow a competing entity to disrupt or prevent successful deployment.	Matthew Sams Chief of Staff <a href="mailto:Matthew.sams@mercurywireless.com">Matthew.sams@mercurywireless.com</a> (800) 354-4915 x504
Attachment 7 – Page 51, sections 1 and 2	Financial Information	Estimated intangibles and good will amortization, and long-term debt summary for 2017 and 2018. FOIA Act 442, section 15.243 (f) – disclosure of sensitive financial information will put the company at a competitive disadvantage, providing insight into the Company’s operations that would allow a competing entity to disrupt or prevent successful deployment.	Matthew Sams Chief of Staff <a href="mailto:Matthew.sams@mercurywireless.com">Matthew.sams@mercurywireless.com</a> (800) 354-4915 x504

Attachment 7 – Page 52	Financial Information	Mercury Wireless, Inc. and Subsidiaries notes on consolidated financial statements and long-term debt summary with details for 2017 and 2018. FOIA Act 442, section 15.243 (f) – disclosure of sensitive financial information will put the company at a competitive disadvantage, providing insight into the Company’s operations that would allow a competing entity to disrupt or prevent successful deployment.	Matthew Sams Chief of Staff <a href="mailto:Matthew.sams@mercurywireless.com">Matthew.sams@mercurywireless.com</a> (800) 354-4915 x504
Attachment 7 – Page 53, sections 1, 2, and 3	Financial Information	Annual maturities of long-term debt for 2018, operating leases for 2018, and 401(k) details for company plan. FOIA Act 442, section 15.243 (f) – disclosure of sensitive financial information will put the company at a competitive disadvantage, providing insight into the Company’s operations that would allow a competing entity to disrupt or prevent successful deployment.	Matthew Sams Chief of Staff <a href="mailto:Matthew.sams@mercurywireless.com">Matthew.sams@mercurywireless.com</a> (800) 354-4915 x504
Attachment 7 – Page 54, paragraph 5	Financial Information	Summary of option activity under the Plan for 2017 and 2018. FOIA Act 442, section 15.243 (f) – disclosure of sensitive financial information will put the company at a competitive disadvantage, providing insight into the Company’s operations that would allow a competing entity to disrupt or prevent successful deployment.	Matthew Sams Chief of Staff <a href="mailto:Matthew.sams@mercurywireless.com">Matthew.sams@mercurywireless.com</a> (800) 354-4915 x504
Attachment 7 – Page 55, paragraphs 2 and 3	Financial Information	Summary of expenses related to obtaining grant funds. Summary of related party transactions and dollar amounts for 2017 and 2018. FOIA Act 442, section 15.243 (f) – disclosure of sensitive financial information will put the company at a competitive disadvantage, providing insight into the Company’s operations that would allow a competing entity to disrupt or prevent successful deployment.	Matthew Sams Chief of Staff <a href="mailto:Matthew.sams@mercurywireless.com">Matthew.sams@mercurywireless.com</a> (800) 354-4915 x504
Attachment 8 – Page 1, paragraphs 1, 3, and 4	Trade Secret	Detailed information regarding the manufacture, make, and model of core infrastructure. Information regarding network budget and link capacity management. Information regarding spectrum. FOIA Act 442, section 15.243 (f) – disclosure of trade secrets will put the company at a competitive disadvantage, providing insight into the Company’s operations that would allow a competing entity to disrupt or prevent successful deployment.	Matthew Sams Chief of Staff <a href="mailto:Matthew.sams@mercurywireless.com">Matthew.sams@mercurywireless.com</a> (800) 354-4915 x504
Attachment 8 - Page 2, paragraphs 1, 2, 3, 4, and 5	Trade Secret	Detailed information regarding the manufacture, make, and model of core infrastructure. Information regarding network budget and link capacity management. Information regarding spectrum. FOIA Act 442, section 15.243 (f) – disclosure of trade secrets will put the company at a competitive disadvantage, providing insight into the Company’s operations that would allow a competing entity to disrupt or prevent successful deployment.	Matthew Sams Chief of Staff <a href="mailto:Matthew.sams@mercurywireless.com">Matthew.sams@mercurywireless.com</a> (800) 354-4915 x504

Attachment 8 – Page 3, paragraphs 2, 4, and 5	Trade Secret	Network congestion management strategies, detailed network monitoring information, and detailed operational information about the Company's Network Operations Center (NOC). FOIA Act 442, section 15.243 (f) – disclosure of trade secrets will put the company at a competitive disadvantage, providing insight into the Company's operations that would allow a competing entity to disrupt or prevent successful deployment.	Matthew Sams Chief of Staff <a href="mailto:Matthew.sams@mercurywireless.com">Matthew.sams@mercurywireless.com</a> (800) 354-4915 x504
Attachment 8 – Page 4, table 1, paragraphs 1 and 2	Trade Secret	Detailed information on spectrum access and management strategies. FOIA Act 442, section 15.243 (f) – disclosure of trade secrets will put the company at a competitive disadvantage, providing insight into the Company's operations that would allow a competing entity to disrupt or prevent successful deployment.	Matthew Sams Chief of Staff <a href="mailto:Matthew.sams@mercurywireless.com">Matthew.sams@mercurywireless.com</a> (800) 354-4915 x504
Attachment 8 – Page 5, paragraph 1	Trade Secret	Information regarding the manufacture, make, and model of equipment used for deployment. FOIA Act 442, section 15.243 (f) – disclosure of trade secrets will put the company at a competitive disadvantage, providing insight into the Company's operations that would allow a competing entity to disrupt or prevent successful deployment.	Matthew Sams Chief of Staff <a href="mailto:Matthew.sams@mercurywireless.com">Matthew.sams@mercurywireless.com</a> (800) 354-4915 x504
Attachment 9 – Pages 1 and 2	Financial Information	5-year financial forecast. FOIA Act 442, section 15.243 (f) – disclosure of sensitive financial information will put the company at a competitive disadvantage, providing insight into the Company's operations that would allow a competing entity to disrupt or prevent successful deployment.	Matthew Sams Chief of Staff <a href="mailto:Matthew.sams@mercurywireless.com">Matthew.sams@mercurywireless.com</a> (800) 354-4915 x504
Attachment 10 – Table 1	Trade Secret	Proposed pricing information that would put us at a competitive disadvantage if public prior to deployment. FOIA Act 442, section 15.243 (f) – disclosure of trade secrets will put the company at a competitive disadvantage, providing insight into the Company's operations that would allow a competing entity to disrupt or prevent successful deployment.	Matthew Sams Chief of Staff <a href="mailto:Matthew.sams@mercurywireless.com">Matthew.sams@mercurywireless.com</a> (800) 354-4915 x504
Attachment 11 – Page 2	Proprietary Information	Personal and contact information about the certifying engineer for this project. FOIA Act 442, section 15.243 (f) – disclosure of proprietary information will put the company at a competitive disadvantage, providing insight into the Company's operations that would allow a competing entity to disrupt or prevent successful deployment.	Matthew Sams Chief of Staff <a href="mailto:Matthew.sams@mercurywireless.com">Matthew.sams@mercurywireless.com</a> (800) 354-4915 x504
Attachment 11 – Page 5, paragraph 2 and 3	Trade Secret	Information about planned spectrum access and strategies for managing the network budget and congestion. FOIA Act 442, section 15.243 (f) – disclosure of trade secrets will put the company at a competitive disadvantage, providing insight into the Company's operations that would allow a competing entity to disrupt or prevent successful deployment.	Matthew Sams Chief of Staff <a href="mailto:Matthew.sams@mercurywireless.com">Matthew.sams@mercurywireless.com</a> (800) 354-4915 x504

Attachment 11 – Page 7, paragraphs 1, 2, and 3	Trade Secret	Sensitive information on the number of sites planned for deployment, site capacity, link capacity, take rate, and oversubscription ratios. FOIA Act 442, section 15.243 (f) – disclosure of trade secrets will put the company at a competitive disadvantage, providing insight into the Company’s operations that would allow a competing entity to disrupt or prevent successful deployment.	Matthew Sams Chief of Staff <a href="mailto:Matthew.sams@mercurywireless.com">Matthew.sams@mercurywireless.com</a> (800) 354-4915 x504
Attachment 11 – Page 8, images 1 and 2	Trade Secret	Key site location, backhaul path, and propagation study diagrams that would put the Company at a competitive disadvantage if publicly disclosed. FOIA Act 442, section 15.243 (f) – disclosure of trade secrets will put the company at a competitive disadvantage, providing insight into the Company’s operations that would allow a competing entity to disrupt or prevent successful deployment.	Matthew Sams Chief of Staff <a href="mailto:Matthew.sams@mercurywireless.com">Matthew.sams@mercurywireless.com</a> (800) 354-4915 x504
Attachment 11 – Page 9, paragraphs 1, 3, and 4	Trade Secret	Detailed information regarding the manufacture, make, and model of core infrastructure. Information regarding network budget and link capacity management. Information regarding spectrum. FOIA Act 442, section 15.243 (f) – disclosure of trade secrets will put the company at a competitive disadvantage, providing insight into the Company’s operations that would allow a competing entity to disrupt or prevent successful deployment.	Matthew Sams Chief of Staff <a href="mailto:Matthew.sams@mercurywireless.com">Matthew.sams@mercurywireless.com</a> (800) 354-4915 x504
Attachment 11 – Page 10, paragraphs 1, 2, 3, 4, and 5	Trade Secret	Detailed information regarding the manufacture, make, and model of core infrastructure. Information regarding network budget and link capacity management. Information regarding spectrum. FOIA Act 442, section 15.243 (f) – disclosure of trade secrets will put the company at a competitive disadvantage, providing insight into the Company’s operations that would allow a competing entity to disrupt or prevent successful deployment.	Matthew Sams Chief of Staff <a href="mailto:Matthew.sams@mercurywireless.com">Matthew.sams@mercurywireless.com</a> (800) 354-4915 x504
Attachment 11 – Page 11, paragraph 1	Trade Secret	Detailed information regarding the manufacture, make, and model of customer equipment that hasn’t been made publicly available yet and would put the Company at a competitive disadvantage if disclosed prior to deployment. FOIA Act 442, section 15.243 (f) – disclosure of trade secrets will put the company at a competitive disadvantage, providing insight into the Company’s operations that would allow a competing entity to disrupt or prevent successful deployment.	Matthew Sams Chief of Staff <a href="mailto:Matthew.sams@mercurywireless.com">Matthew.sams@mercurywireless.com</a> (800) 354-4915 x504
Attachment 11 – Page 13, paragraphs 2, 3, and 4	Trade Secret	Network congestion management strategies, detailed network monitoring information, and detailed operational information about the Company’s Network Operations Center (NOC). FOIA Act 442, section 15.243 (f) – disclosure of trade secrets will put the company at a competitive disadvantage, providing insight into the Company’s operations that would allow a competing entity to disrupt or prevent successful deployment.	Matthew Sams Chief of Staff <a href="mailto:Matthew.sams@mercurywireless.com">Matthew.sams@mercurywireless.com</a> (800) 354-4915 x504

Attachment 11 – Page 14, table 1, paragraph 1	Trade Secret	Detailed information on spectrum access and management strategies. FOIA Act 442, section 15.243 (f) – disclosure of trade secrets will put the company at a competitive disadvantage, providing insight into the Company's operations that would allow a competing entity to disrupt or prevent successful deployment.	Matthew Sams Chief of Staff <a href="mailto:Matthew.sams@mercurywireless.com">Matthew.sams@mercurywireless.com</a> (800) 354-4915 x504
Attachment 11 – Page 15, paragraphs 7, 8, and 10	Trade Secret	Detailed information regarding the Company's oversubscription rate, assumption on average level of bandwidth sold, and assumed take rate. FOIA Act 442, section 15.243 (f) – disclosure of trade secrets will put the company at a competitive disadvantage, providing insight into the Company's operations that would allow a competing entity to disrupt or prevent successful deployment.	Matthew Sams Chief of Staff <a href="mailto:Matthew.sams@mercurywireless.com">Matthew.sams@mercurywireless.com</a> (800) 354-4915 x504
Attachment 15 – Pages 2 and 3	Proprietary Information	Proprietary customer and contact information for Mercury Wireless, Inc. and Subsidiaries E-rate partners. This information would put the Company at a disadvantage if publicly disclosed. FOIA Act 442, section 15.243 (f) – disclosure of proprietary information will put the company at a competitive disadvantage, providing insight into the Company's operations that would allow a competing entity to disrupt or prevent successful deployment.	Matthew Sams Chief of Staff <a href="mailto:Matthew.sams@mercurywireless.com">Matthew.sams@mercurywireless.com</a> (800) 354-4915 x504
Grant Application – Page 3, question 8.	Proprietary Information	Mercury Wireless Indiana, LLC.'s EIN, Michigan TIN, Michigan VIN information. FOIA Act 442, section 15.243 (f) – disclosure of proprietary information will put the company at a competitive disadvantage, providing insight into the Company's operations that would allow a competing entity to disrupt or prevent successful deployment.	Matthew Sams Chief of Staff <a href="mailto:Matthew.sams@mercurywireless.com">Matthew.sams@mercurywireless.com</a> (800) 354-4915 x504
Grant Application – Page 6, question 15.	Trade Secret	The redacted information outlines spectrum to be used for deployment and would put the Company at a competitive disadvantage if publicly disclosed, allowing a competing entity to disrupt or prevent successful deployments. FOIA Act 442, section 15.243 (f) – disclosure of trade secrets will put the company at a competitive disadvantage, providing insight into the Company's operations that would allow a competing entity to disrupt or prevent successful deployment.	Matthew Sams Chief of Staff <a href="mailto:Matthew.sams@mercurywireless.com">Matthew.sams@mercurywireless.com</a> (800) 354-4915 x504
Grant Application – Page 11, question 27.	Trade Secret	This table contains sensitive information on the Company's deployment strategy. This would put the Company at a competitive disadvantage if publicly disclosed allowing competing entities to disrupt or prevent successful deployments. FOIA Act 442, section 15.243 (f) – disclosure of trade secrets will put the company at a competitive disadvantage, providing insight into the Company's operations that would allow a competing entity to disrupt or prevent successful deployment.	Matthew Sams Chief of Staff <a href="mailto:Matthew.sams@mercurywireless.com">Matthew.sams@mercurywireless.com</a> (800) 354-4915 x504

Grant Application – Page 16, question 41	Trade Secret	Proposed pricing information that would put us at a competitive disadvantage if public prior to deployment. FOIA Act 442, section 15.243 (f) – disclosure of trade secrets will put the company at a competitive disadvantage, providing insight into the Company's operations that would allow a competing entity to disrupt or prevent successful deployment.	Matthew Sams Chief of Staff <a href="mailto:Matthew.sams@mercurywireless.com">Matthew.sams@mercurywireless.com</a> (800) 354-4915 x504
--	--------------	---	---

By signing below, the Applicant affirms that confidential treatment of material contained in its proposal is requested and has attached to this form a redacted “Public Copy” of the Applicant’s proposal.

Mercury Connects | Calhoun

Project Name



Signature

3/19/2020

Date

Matthew Sams

[Printed Name]

Chief of Staff

[Title]

Mercury Wireless Indiana, LLC.

[Company]





STATE OF MICHIGAN

DEPARTMENT OF TECHNOLOGY, MANAGEMENT & BUDGET  
LANSING

GRETCHEN WHITMER  
GOVERNOR

TRICIA L. FOSTER  
DIRECTOR

Connecting Michigan Communities Grant Application Request for Clarification

December 3, 2019

Company Name: Mercury Wireless  
Application Proposal: Mercury Connects Calhoun  
Application Contact: Matthew Sams

Dear Mr. Sams,

Thank you for submitting your Connecting Michigan Communities (CMIC) grant application. During the review of your application, it was found that some locations to be served in your proposed service area overlap census blocks that are designated for funding from the FCC's Connect America Fund. Public Act 618 of 2018, Sec. 806<sup>1</sup>, the legislation that created the CMIC grant, states the CMIC Grant program cannot provide funding for locations in census blocks that have been selected to receive Connect America Funds:

(8) The department shall not award a grant to an applicant if verifiable information is made available that shows any of the following: (d) The project includes an area that has been selected to receive, provisionally or otherwise, Connect America Funds from the Federal Communications Commission.

The following is an analysis of your proposed census block service areas and those included in the Connect America Fund<sup>2</sup>. The attached map shows the census blocks identified in your application that are proposed for service and the census blocks selected to receive Connect America Funds.

Total housing units in the census blocks in your proposed service area based on the 2010 Census:	983
Total locations to be served per your application (homes, businesses, and institutions):	440
Total housing units in CAF Funded Census Blocks in your proposed service area:	583
Estimated housing units in your proposed service area outside of Connect America Fund Census Blocks based on the 2010 Census:	400

Considering the CMIC grant cannot fund areas selected to receive Connect America Funds, the CMIC Steering Committee is offering the following options for applicants:

- 1) Submit revised application documents to reflect a proposed service area that does not include census blocks selected for Connect America Funds;
- 2) Validate there are no changes to your original application; or
- 3) Withdraw your application from consideration.

<sup>1</sup> <http://www.legislature.mi.gov/documents/2017-2018/billenrolled/Senate/pdf/2017-SNB-0601.pdf>

<sup>2</sup> A list of all Connect America Fund census blocks can be found here: [https://www.michigan.gov/documents/dtmb/Michigan\\_Census\\_Blocks\\_CAF\\_650783\\_7.xlsx](https://www.michigan.gov/documents/dtmb/Michigan_Census_Blocks_CAF_650783_7.xlsx).

If you choose to submit revised application documents that reflect a proposed service area which does not include census blocks selected for Connect America Funds, this completed Request for Clarification (RFC) document along with the identified attachments must be received via email to [DTMB-CMICGrant@michigan.gov](mailto:DTMB-CMICGrant@michigan.gov) by Friday, December 13, 2019.

<b>Revised Application Summary</b>		
	Original Application	Revised Application
Households to be served	396	200
Businesses to be served	41	24
Community Anchor Institutions to be served	3	1
Total Project Cost	\$480,000.00	\$400,000.00
Total Grant Request	\$360,000.00	\$300,000.00
Total Matching Funds	\$120,000.00	\$100,000.00

<b>Revised Attachment 1</b>
<p>Applicant must provide a map of proposed service area that excludes CAF funded census blocks in PDF format (including both last mile coverage and middle mile routes). Revised applications cannot include locations to be served that were not part of your original application.</p>
<p>Response: Please find a revised .PDF map excluding CAF funded census blocks attached and labeled 'MercuryWirelessIndianaLLC_Attachment_1.pdf'.</p>

<b>Revised Attachment 3</b>			
<p>Applicant must provide a spreadsheet of census blocks in XLS or XLSX format identifying the locations served that are part of the non-CAF proposed service area using the following heading format. Revised applications cannot include locations to be served that were not part of your original application. If you feel there is a discrepancy between the figures as reported in the 2010 Census and actual number of housing units, please explain in the response field of this section in addition to completing the required spreadsheet.</p>			
	Total Number of Households to be Served	Is Service Provided to Whole or Part of Census Block? Y/N	Is Census Block Wholly Contained Within Service Area? Y/N
Census Block ID			
<p>Response: Please find a revised .xls spreadsheet of census blocks attached and labeled 'MercuryWirelessIndianaLLC_Attachment_3.xls'.</p>			

<b>Revised Attachment 9</b>
Applicant must provide a revised five-year, stand-alone project financial plan/forecast that includes only locations within the proposed service area and does not include census blocks selected for CAF.
Response: Please find a revised .pdf providing a five-year, stand-alone financial plan/forecast labeled 'MercuryWirelessIndianaLLC_Attachment_9'.

<b>Revised Project Budget</b>			
Applicant must complete this table to provide a revised project budget that includes only locations within the proposed service area and does not include census blocks selected for CAF.			
Use of Funds	Match Amount	Grant Amount	Total
Buildings and Labor	\$5,000.00	\$15,000.00	\$20,000.00
Last Mile Construction Labor	\$3,125.00	\$9,375.00	\$12,500.00
Middle Mile Construction Labor	\$1,875.00	\$5,625.00	\$7,500.00
Construction Material	\$0.00	\$0.00	\$0.00
Customer Premise Equipment	\$33,750.00	\$101,250.00	\$135,000.00
Customer Premise Installation	\$16,250.00	\$48,750.00	65000
Electronics	\$35,625.00	\$106,875.00	\$142,500.00
Permits	\$625.00	\$1,875.00	\$2,500.00
Professional Services and Engineering	\$3,750.00	\$11,250.00	\$15,000.00
Other:	\$0.00	\$0.00	\$0.00
Other:	\$0.00	\$0.00	\$0.00
Other:	\$0.00	\$0.00	\$0.00
Other:	\$0.00	\$0.00	\$0.00
Other:	\$0.00	\$0.00	\$0.00
<b>Total</b>			<b>\$400,000.00</b>

**CMIC Grant RFC – Mercury – Calhoun**

**December 3, 2019**

**Page 4**

This completed RFC and revised attachments must be received via email to [DTMB-CMICGrant@michigan.gov](mailto:DTMB-CMICGrant@michigan.gov). Do not return this document with your responses without also updating and returning the relevant attachments listed above. Any questions should be submitted via email to [DTMB-CMICGrant@michigan.gov](mailto:DTMB-CMICGrant@michigan.gov).

To validate there are no changes to your original application, you must send an email to [DTMB-CMICGrant@michigan.gov](mailto:DTMB-CMICGrant@michigan.gov) with the phrase, "Validate No Changes to Application" followed by your company name and name of the project in the subject line.

To withdraw your application from consideration, you must send an email to [DTMB-CMICGrant@michigan.gov](mailto:DTMB-CMICGrant@michigan.gov) with the phrase, "Withdraw Application" followed by your company name and name of the project in the subject line.

**Your response, including Validation, Withdrawal, or completed RFC and amended Attachments must be received via email to [DTMB-CMICGrant@michigan.gov](mailto:DTMB-CMICGrant@michigan.gov) by Friday, December 13, 2019, at 3:00 p.m. EST. No extensions shall be granted. You will receive an email confirmation of your submission. If you have not received a confirmation receipt by December 20, 2019, you must contact the CMIC Grant Program Office at (517) 335-3727. Failure to respond to this request may affect the scoring of your application, including up to elimination of further consideration.**

Connecting Michigan  
Communities (CMIC)

Provider: Mercury  
Project: Calhoun

Grant Application by Census Block

vs.

CAF Funded Block Area

DTMB Grant Program

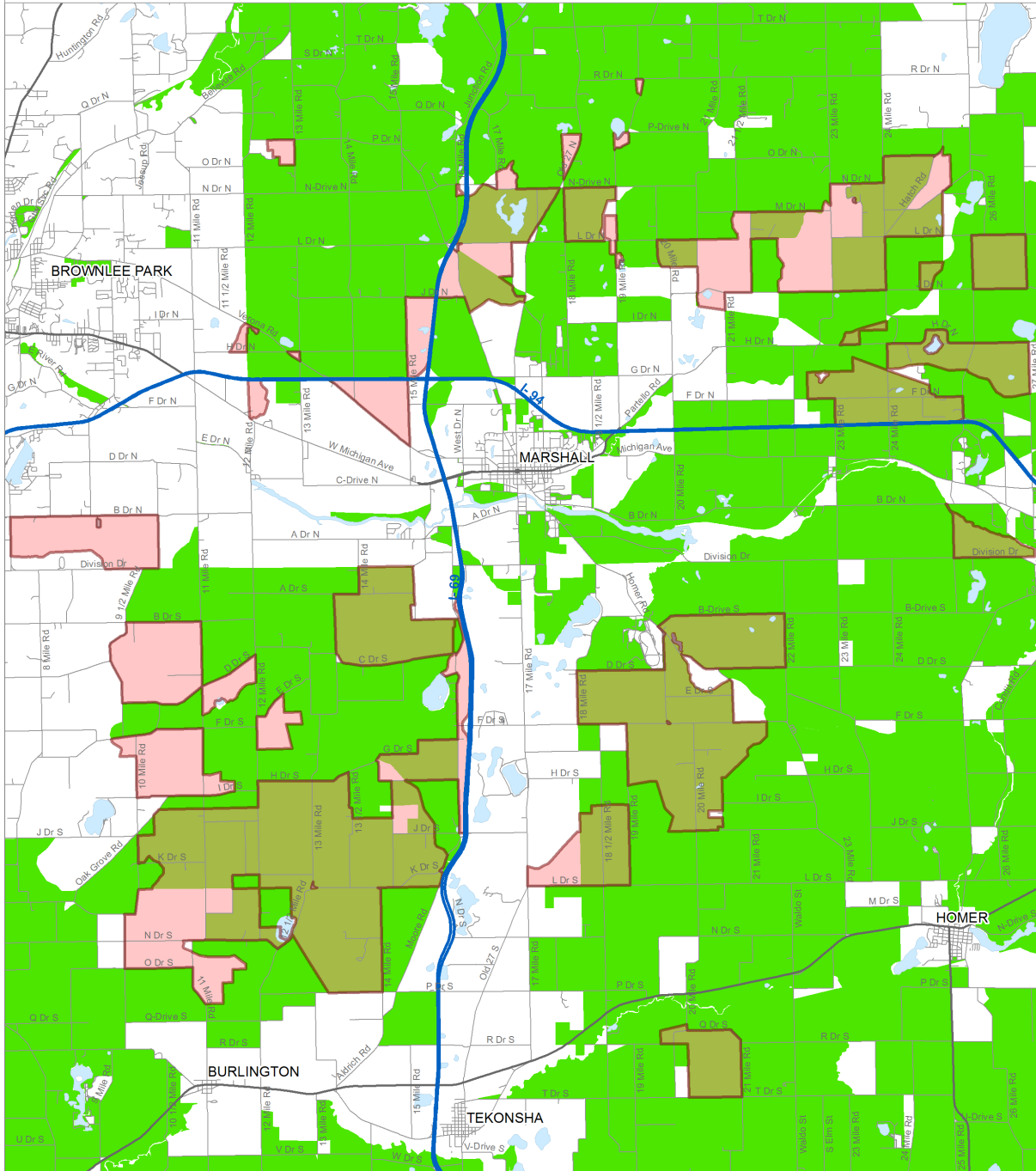

 Application by Block

 CAF Funded Block

All Rights Reserved. © Copyright 2019, Connected Nation

# Mercury Connects Calhoun

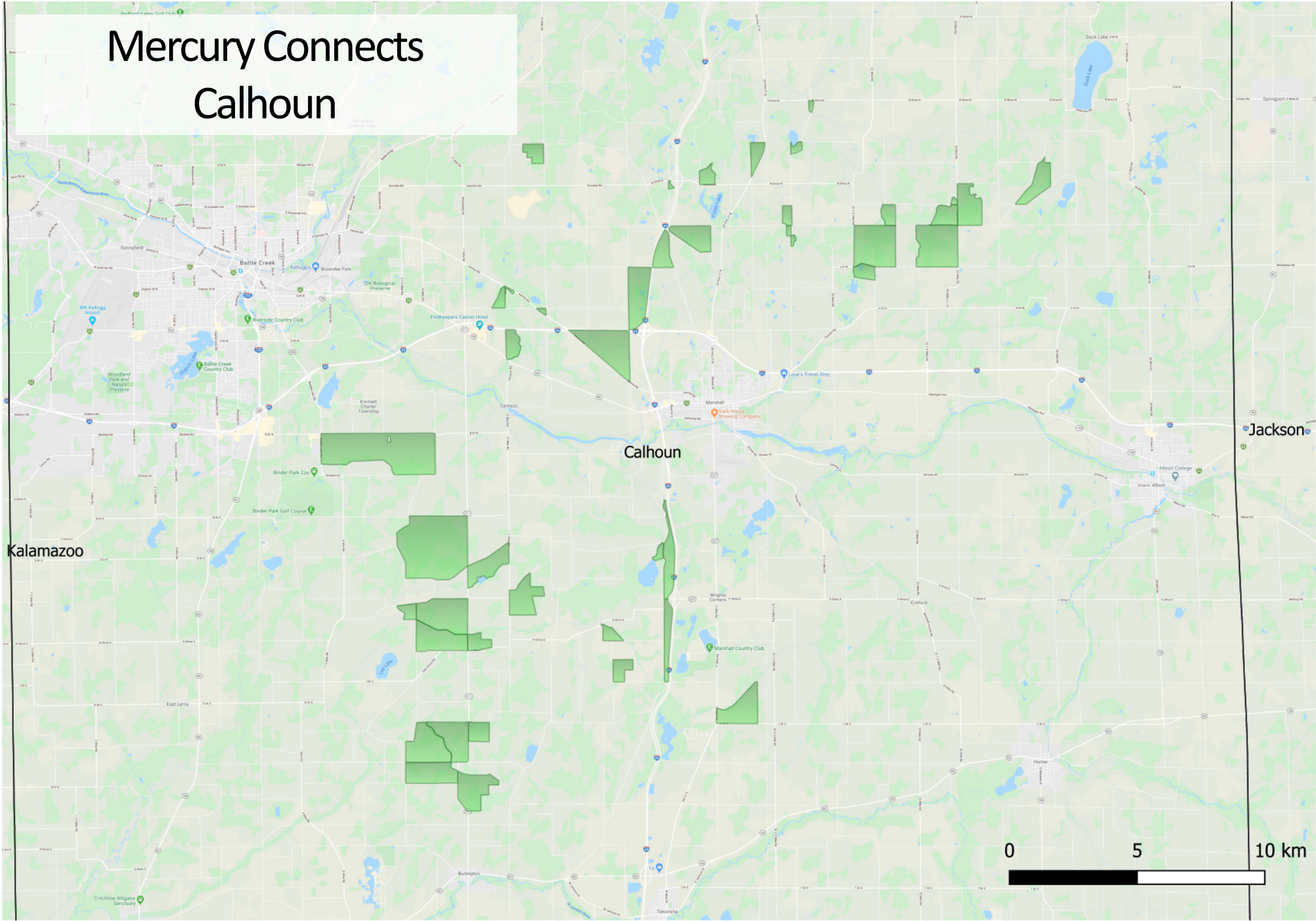



**Attachment 3 | Census Block List**

Census Block ID	Total Number of Households to be Served	Is Service Provided to Whole or Part of Census Block? Y/N	Is Census Block Wholly Contained Within Service Area? Y/N
260250029001040	2	Y	Y
260250027004007	3	Y	Y
260250027004005	13	Y	Y
260250027004026	5	Y	Y
260250038001022	8	Y	Y
260250038003035	2	Y	Y
260250038002012	18	Y	Y
260250037003062	1	Y	Y
260250038003001	1	Y	Y
260250037002117	3	Y	Y
260250038003003	3	Y	Y
260250037003056	1	Y	Y
260250038001007	1	Y	Y
260250038001003	2	Y	Y
260250029001029	1	Y	Y
260250029001015	5	Y	Y
260250037003055	11	Y	N
260250019003053	15	Y	N
260250020003011	7	Y	Y
260250029001044	1	Y	Y
260250027004016	2	Y	Y
260250027004017	7	Y	Y
260250027004025	12	Y	Y
260250037003060	2	Y	Y
260250029001036	8	Y	Y
260250037002115	2	Y	Y
260250037001069	8	Y	Y
260250028004002	5	Y	Y
260250028004001	4	Y	Y
260250028004007	1	Y	N
260250038001060	2	Y	Y
260250038001013	3	Y	Y
260250028004003	2	Y	N
260250029002014	1	Y	Y
260250037002094	8	Y	Y
260250028004004	1	Y	N
260250038001063	1	Y	Y



Mercury Wireless Indiana, LLC.  
6004 Highview Drive, Suite B  
Fort Wayne, IN 46818

260250038001059	1	Y	Y
260250038002017	1	Y	Y
260250038001053	8	Y	Y
260250037002076	1	Y	Y
260250029002008	2	Y	Y
260250037002092	6	Y	Y
260250037002089	1	Y	Y
260250037003061	8	Y	Y





Mercury Wireless Indiana, LLC  
6004 Highview Drive, STE B  
Fort Wayne, IN 46818

#### **Attachment 4 | Match Commitment Evidence**

The Mercury Connects | Calhoun project cost is \$480,000.00, with matching funds from Mercury Wireless of \$120,000.00, and a request for grant funds of \$360,000.00. Mercury Wireless will provide its matching funds with cash generated from Mercury Wireless Inc. and subsidiaries' internal revenues, as demonstrated in our 2018 audited financials included with Attachment 7 – Audited Financial Statements. Additionally, the Company will utilize internal revenues from anticipated market capture as demonstrated in Attachment 9 – Five Year Project Forecast. These internal funds along with the grant proceeds from the Connecting Michigan Communities Grant Program will allow Mercury to meet its build out obligations and deliver broadband Internet to rural communities in the project area. Included with this attachment is the 2018 Consolidated Statement of Cash Flows, and the Five-Year Project Forecast.

**Mercury Wireless, Inc. & Subsidiaries**  
**Consolidated Statements of Cash Flows**  
**Years Ended December 31, 2018 and 2017**

	2018	2017
[REDACTED]	[REDACTED]	[REDACTED]
[REDACTED]	[REDACTED]	[REDACTED]
[REDACTED]	[REDACTED]	[REDACTED]
[REDACTED]	[REDACTED]	[REDACTED]
[REDACTED]	[REDACTED]	[REDACTED]
[REDACTED]	[REDACTED]	[REDACTED]
[REDACTED]	[REDACTED]	[REDACTED]
[REDACTED]	[REDACTED]	[REDACTED]
[REDACTED]	[REDACTED]	[REDACTED]
[REDACTED]	[REDACTED]	[REDACTED]
[REDACTED]	[REDACTED]	[REDACTED]
[REDACTED]	[REDACTED]	[REDACTED]
[REDACTED]	[REDACTED]	[REDACTED]
[REDACTED]	[REDACTED]	[REDACTED]
[REDACTED]	[REDACTED]	[REDACTED]
[REDACTED]	[REDACTED]	[REDACTED]
[REDACTED]	[REDACTED]	[REDACTED]
[REDACTED]	[REDACTED]	[REDACTED]

## Attachment 9 | Five-year Project Forecast

**PFSA 5 Income Statement**

	Year 1	Year 2	Year 3	Year 4	Year 5
[REDACTED]	[REDACTED]	[REDACTED]	[REDACTED]	[REDACTED]	[REDACTED]
[REDACTED]	[REDACTED]	[REDACTED]	[REDACTED]	[REDACTED]	[REDACTED]
[REDACTED]	[REDACTED]	[REDACTED]	[REDACTED]	[REDACTED]	[REDACTED]
[REDACTED]	[REDACTED]	[REDACTED]	[REDACTED]	[REDACTED]	[REDACTED]
[REDACTED]	[REDACTED]	[REDACTED]	[REDACTED]	[REDACTED]	[REDACTED]
[REDACTED]	[REDACTED]	[REDACTED]	[REDACTED]	[REDACTED]	[REDACTED]
[REDACTED]	[REDACTED]	[REDACTED]	[REDACTED]	[REDACTED]	[REDACTED]
[REDACTED]	[REDACTED]	[REDACTED]	[REDACTED]	[REDACTED]	[REDACTED]
[REDACTED]	[REDACTED]	[REDACTED]	[REDACTED]	[REDACTED]	[REDACTED]

**PFSA 5 Statement of Cash Flows**

	Year 1	Year 2	Year 3	Year 4	Year 5
[REDACTED]	[REDACTED]	[REDACTED]	[REDACTED]	[REDACTED]	[REDACTED]
[REDACTED]	[REDACTED]	[REDACTED]	[REDACTED]	[REDACTED]	[REDACTED]
[REDACTED]	[REDACTED]	[REDACTED]	[REDACTED]	[REDACTED]	[REDACTED]
[REDACTED]	[REDACTED]	[REDACTED]	[REDACTED]	[REDACTED]	[REDACTED]
[REDACTED]	[REDACTED]	[REDACTED]	[REDACTED]	[REDACTED]	[REDACTED]
[REDACTED]	[REDACTED]	[REDACTED]	[REDACTED]	[REDACTED]	[REDACTED]
[REDACTED]	[REDACTED]	[REDACTED]	[REDACTED]	[REDACTED]	[REDACTED]
[REDACTED]	[REDACTED]	[REDACTED]	[REDACTED]	[REDACTED]	[REDACTED]
[REDACTED]	[REDACTED]	[REDACTED]	[REDACTED]	[REDACTED]	[REDACTED]



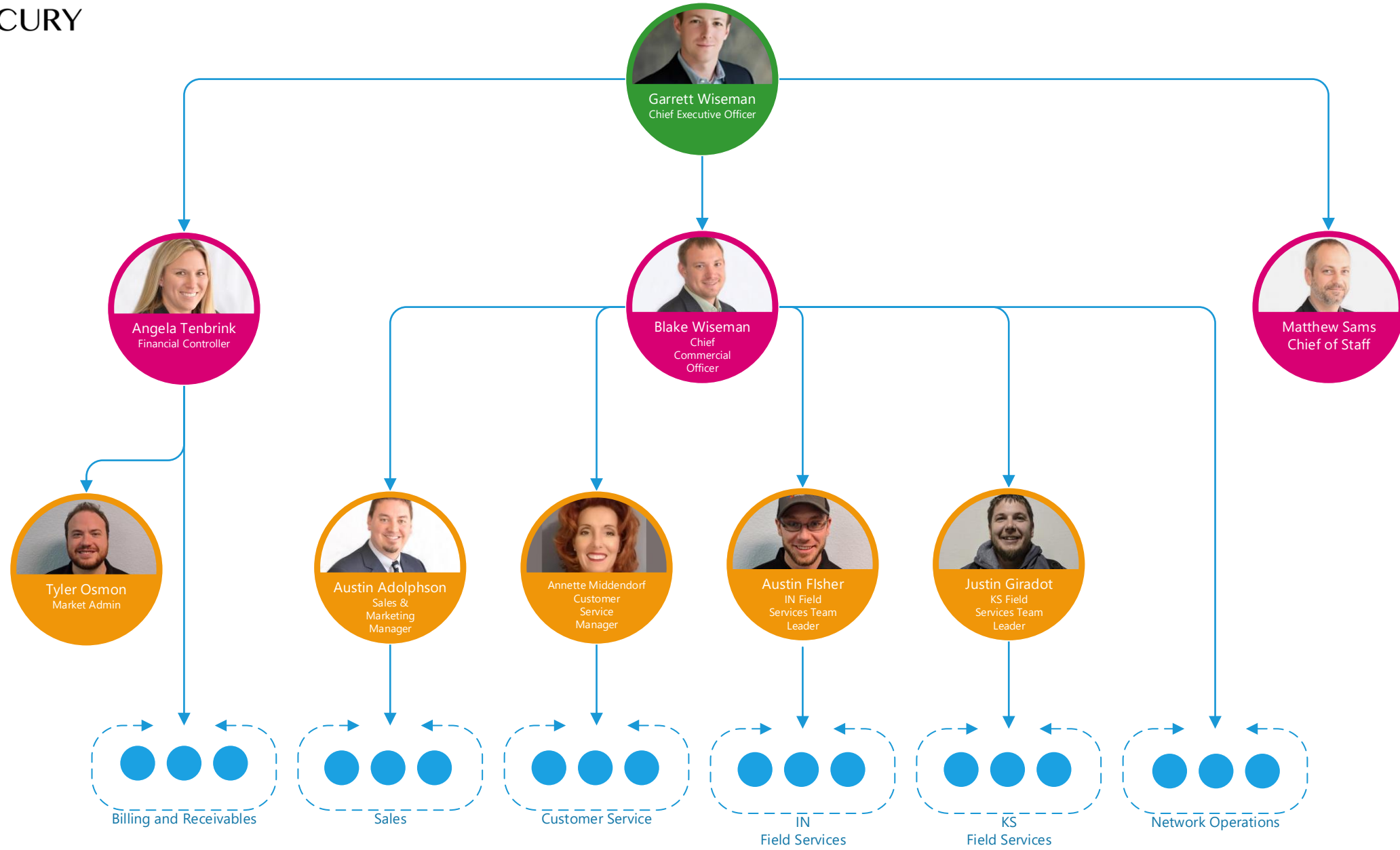

## Attachment 6 | Resumes of Key Management



### **Garrett R. Wiseman – Founder and Chief Executive Officer**

Garrett Wiseman founded Mercury Wireless in 2007 and is also the CEO of Mercury Networks, LLC; a company that builds, designs, and manufacturers 4G Broadband radios used by the corporation and in nearly 250 other networks worldwide. In addition to his regular duties Garrett remains active in developing Ceres: the operating software in which Mercury Wireless is being built on. Prior to Mercury, Garrett served in the United States Air Force. Garrett studied engineering at Washburn University and graduated from the Community College of The Air Force as an honor graduate while also receiving a distinguished graduate award.

---

#### Work History

- 2007 – Current – Mercury Wireless, Inc. – Chief Executive Officer

##### Job Duties

- Provide inspired leadership company wide
  - High-level decisions about policy and strategy
  - Develop and implement strategic plans
  - Develop the company’s culture and overall company vision
  - Oversee the Company’s fiscal activity including budgeting, reporting, and auditing
  - Work with stakeholders, chief commercial officer, financial controller, and chief of staff
  - Work with executive board to determine plan for short and long-term goals
  - Build alliances and partnerships with other organizations
  - Oversee day-to-day company operations
- 2006 – 2012 – United States Air Force – Staff Sergeant, Avionics Guidance Control Systems



### **Blake Wiseman – Chief Commercial Officer**

Blake Wiseman joined Mercury Wireless in 2008 where he began as a Field Service Technician. Blake has served the company in multiple capacities including sales, support, and operations. Today Blake oversees the operations of the company and assists with guiding and implementing its vision and strategy. Blake has played a key role in multiple successful M&A transactions with the company throughout the past decade. Prior to Mercury, Blake studied at Washburn University.

---

#### Work History

- 2008 – Current – Mercury Wireless, Inc. – Chief Commercial Officer
  - Oversee marketing, sales, product development, and customer service
  - Oversee field services, field operations, and network operations
  - Oversee day-to-day performance of the network and make recommendations/changes
  - Assess current and future network needs
  - Work with chief executive officer, financial controller, and chief of staff to plan, implement, and deploy network segments
  - Ensure integrated commercial success of the Company

**Angela Tenbrink, CPA – Financial Controller, Treasurer**

Angela Tenbrink is Mercury Wireless' Financial Controller. She partners with Mercury's leadership team to provide financial reporting, planning and analysis as well as management of Mercury's financial assets and information. Angela is a Certified Public Accountant and has held her certification since June 2013. Angela attended Washburn University from 2006 – 2010, where she earned her bachelor's degree from the School of Business with an accounting major. Angela spent these four years as a student-athlete and starting mid-fielder for the Washburn Lady Blues soccer team. She then went on to secure her Master of Accounting degree from the University of Kansas in 2012. Prior to joining Mercury Wireless, Angela spent 3 years in public accounting as an auditor specializing primarily on the construction industry and non-profit sector.

---

**Work History**

- 2015 – Current – Mercury Wireless, Inc. – Financial Controller, Treasurer

**Job Duties**

- Prepare financial reports and participate in the budgeting process
- Manage financial transaction and monitor internal controls
- Coordinate audit process and streamline accounting functions
- Develop plans for financial growth and evaluate and manage risk
- Forecast cash flow positions, related borrowing needs, and funds available for investment
- Maintain banking relationships and ensure funds are available to meet ongoing operational and capital investments

- 2012 – 2015 – CBIZ MHM - Auditor

**Education**

- 2012 - Kansas University – Master's in Accounting
- 2010 - Washburn University – Bachelor's in Business, Major: Accounting

**Matthew Sams – Chief of Staff**

Matthew Sams joined Mercury Wireless in 2011 after graduating from Washburn University with a Bachelor's in Business Administration. Matthew also has an Associates from Washburn University in Industrial Technology Management, in addition to completing coursework at the Washburn Institute of Technology for CompTIA A+ and PC Repair and Networking. Matthew has served the company in multiple capacities including sales, support, and operations. Today Matthew assists with strategic operations, regulatory compliance, and project management. Prior to joining Mercury Wireless, Matthew worked as a retail manager from May of 2002 to July of 2011 serving in several roles including sales, customer service, and logistics.

---

**Work History**

- 2011 – Current – Mercury Wireless, Inc. – Chief of Staff

**Job Duties**

- Oversee strategic business initiatives
- Assist and communicate with executives in decision-making and program management
- Review, design, and execute improvements to organizational structure
- Assist human resources department with new hires
- Oversee daily operations through collaboration with senior management

- 2002 - 2011 – OfficeMax Inc. – Assistant Store Manager

**Education**

- 2011 - Washburn University – Bachelor of Business Administration
- 2004 – Washburn University – Associate of Applied Science in Industrial Technology Management

---

**MERCURY WIRELESS, INC. & SUBSIDIARIES**

---

**CONSOLIDATED FINANCIAL STATEMENTS**

---

**YEARS ENDED DECEMBER 31, 2016 AND 2015**







990 SW Fairlawn ■ Topeka, KS 66606  
Main: 785.272.3176 ■ Fax: 785.272.2903 ■ [www.mhmcpa.com](http://www.mhmcpa.com)

## INDEPENDENT AUDITORS' REPORT

To the Board of Directors  
Mercury Wireless  
Fort Wayne, Indiana

We have audited the accompanying consolidated financial statements of Mercury Wireless, Inc. & Subsidiaries, which comprise the consolidated balance sheets as of December 31, 2016 and 2015, and the related consolidated statements of operations, changes in stockholders' equity, and cash flows for the years then ended, and the related notes to the financial statements.

### ***Management's Responsibility for the Financial Statements***

Management is responsible for the preparation and fair presentation of the consolidated financial statements in accordance with accounting principles generally accepted in the United States of America and for designing, implementing, and maintaining internal control relevant to the preparation and fair presentation of the financial statements.

### ***Auditors' Responsibility***

Our responsibility is to express an opinion on these consolidated financial statements based on our audits. We conducted our audits in accordance with auditing standards generally accepted in the United States of America. Those standards require that we plan and perform the audit to obtain reasonable assurance about whether the consolidated financial statements are free from material misstatement.

An audit involves performing procedures to obtain audit evidence about the amounts and disclosures in the consolidated financial statements. The procedures selected depend on the auditors' judgment, including the assessment of the risks of material misstatement of the consolidated financial statements, whether due to fraud or error. In making those risk assessments, the auditor considers internal control relevant to the entity's preparation and fair presentation of the consolidated financial statements in order to design audit procedures that are appropriate in the circumstances, but not for the purpose of expressing an opinion on the effectiveness of the entity's internal control. Accordingly, we express no such opinion. An audit also includes evaluating the appropriateness of accounting policies used and the reasonableness of significant accounting estimates made by management, as well as evaluating the overall presentation of the consolidated financial statements.

We believe that the audit evidence we have obtained is sufficient and appropriate to provide a basis for our audit opinion.

***Opinion***

In our opinion, the consolidated financial statements referred to above present fairly, in all material respects, the financial position of Mercury Wireless, Inc. & Subsidiaries, as of December 31, 2016 and 2015, and the results of its operations and its cash flows for the years then ended in accordance with accounting principles generally accepted in the United States of America.

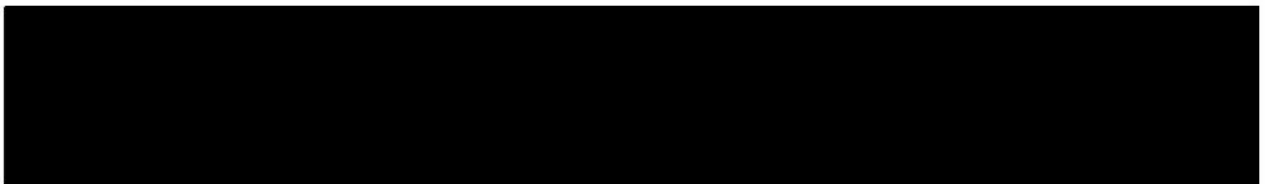

*Mayer Hoffman McCann P.C.*

Mayer Hoffman McCann P.C.  
Topeka, Kansas  
March 17, 2017

MERCURY WIRELESS, INC. & SUBSIDIARIES  
CONSOLIDATED BALANCE SHEETS

December 31,

2016

2015

ASSETS



LIABILITIES AND STOCKHOLDERS' EQUITY

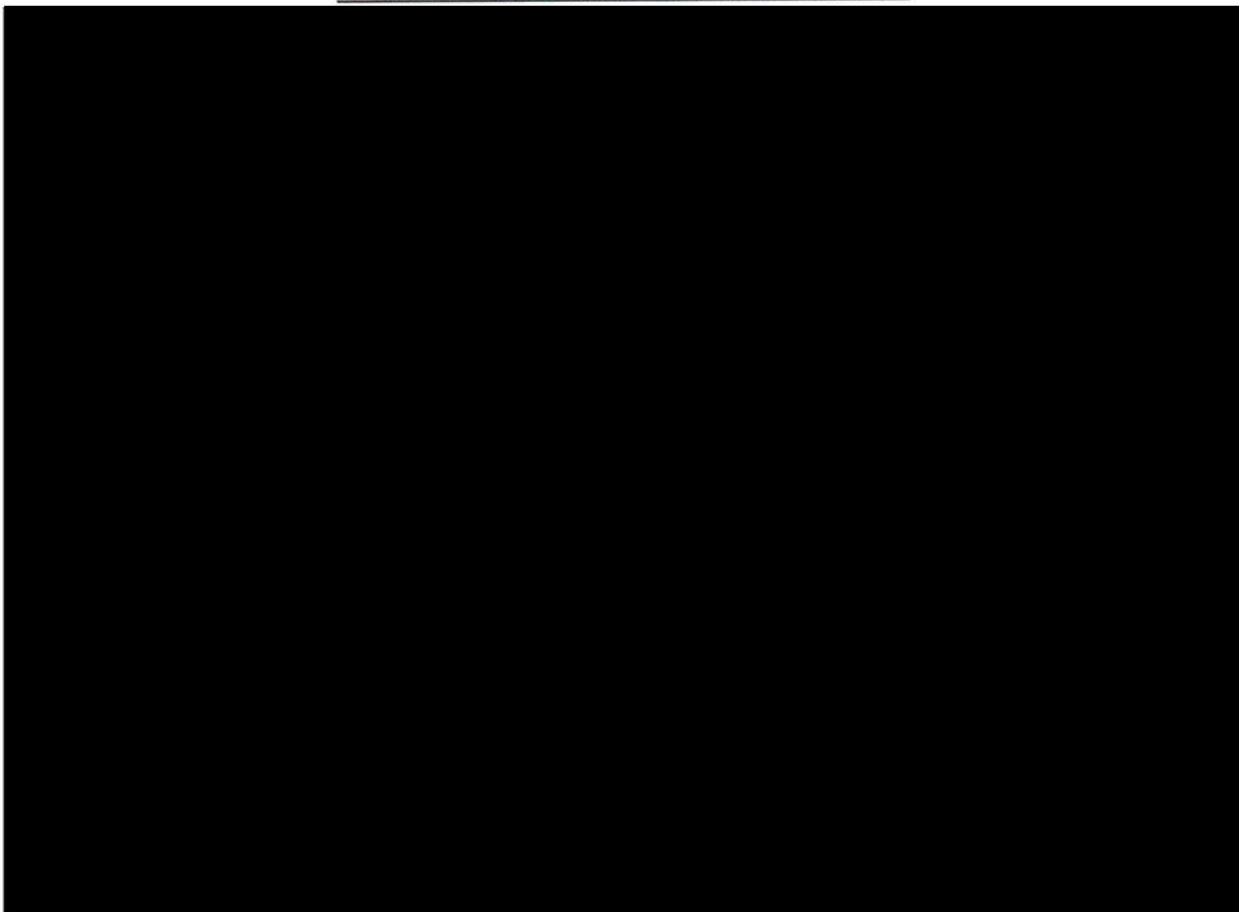

MERCURY WIRELESS, INC. & SUBSIDIARIES  
CONSOLIDATED STATEMENTS OF OPERATIONS

Years ended December 31,

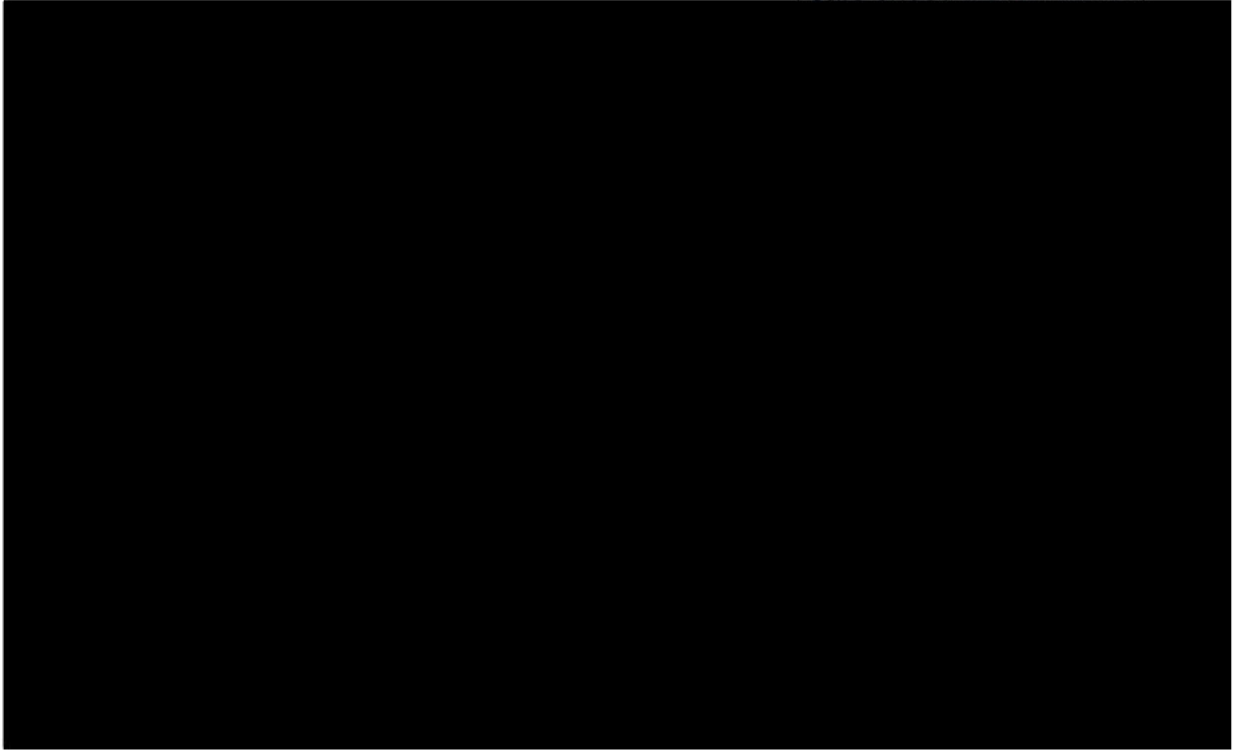

See Notes to the Consolidated Financial Statements

MERCURY WIRELESS, INC. & SUBSIDIARIES  
CONSOLIDATED STATEMENTS OF CHANGES IN STOCKHOLDERS' EQUITY  
Years ended December 31, 2016 and 2015



See Notes to the Consolidated Financial Statements

MERCURY WIRELESS, INC. & SUBSIDIARIES  
CONSOLIDATED STATEMENTS OF CASH FLOWS

Years ended December 31,	
2016	2015

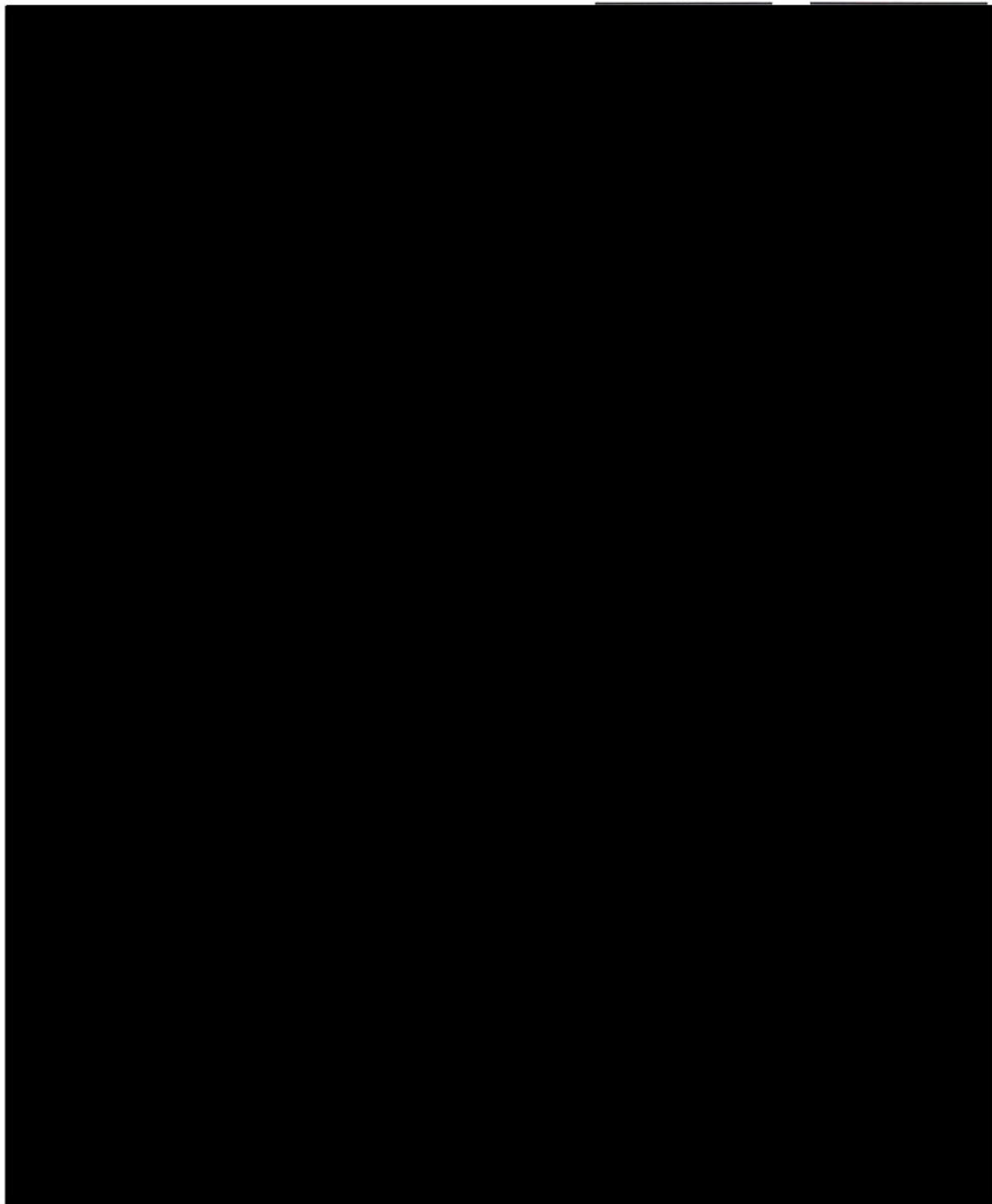

See Notes to the Consolidated Financial Statements

MERCURY WIRELESS, INC. & SUBSIDIARIES  
NOTES TO THE CONSOLIDATED FINANCIAL STATEMENTS

(1) **Summary of significant accounting policies**

**History and business** – Mercury Wireless, Inc. & Subsidiaries provides wireless internet and phone service to underserved rural areas within northeast Kansas and northeast Indiana. The Company has offices in Topeka, Kansas and Fort Wayne, Indiana.

**Principles of Consolidation** - The consolidated financial statements include the accounts of Mercury Wireless, Inc., Mercury Wireless Kansas, LLC, Mercury Wireless Indiana, LLC, and Mercury Access Solutions, LLC. All significant intercompany transactions and balances have been eliminated. Mercury Wireless, Inc. owns 100% of the ownership interest of the Subsidiaries. Accordingly, the Company has consolidated the assets, liabilities, and results of operations of the subsidiaries in the accompanying consolidated financial statements.

**Recent Accounting Pronouncement** - In April 2015, the Financial Accounting Services Board (FASB) published Accounting Standards Update (ASU) No. 2015-03, which changes the presentation and disclosure of debt issuance costs in the financial statements by requiring these amounts to be presented as a direct deduction from the carrying amount of the related debt. Previous U.S. GAAP required debt issuance costs to be reported as an asset. The new guidance does not change the subsequent accounting for debt issuance costs and these amounts will continue to be amortized over the term of the related debt. However, amortization of debt issuance costs will now be required to be reported as a component of interest expense. The Company reclassified the debt issuance costs of \$228 as a contra-account to the mortgage liability.

**Revenue recognition** - The Company recognizes revenues when services are performed, generally over the service contract for the month. Revenue is recorded net of sales returns and applicable taxes.

**Accounts receivable** - Accounts receivable are due on [REDACTED] terms and are stated at the net amount due from customers, less an allowance for doubtful accounts. The Company determines its allowance for doubtful accounts by considering a number of factors, including the length of time trade accounts receivable are past due, the Company's previous loss history, the customer's current ability to pay its obligations to the Company, and the condition of the general economy and the industry as a whole. The Company writes off accounts receivable when they become uncollectible, and payments subsequently received on such receivables are credited to bad debt expense. Allowance for doubtful account as of December 31, 2016 and 2015, [REDACTED] respectively.

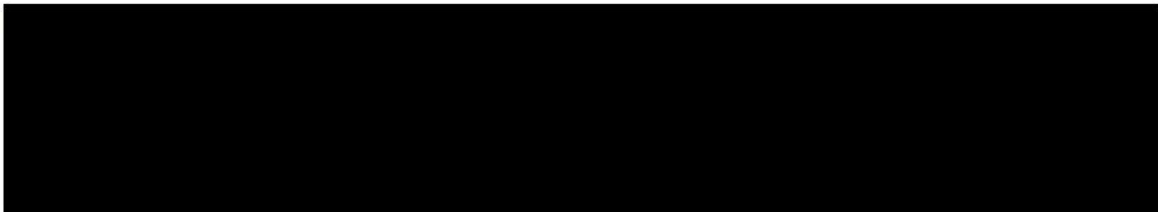

MERCURY WIRELESS, INC. & SUBSIDIARIES  
NOTES TO THE CONSOLIDATED FINANCIAL STATEMENTS

The ranges of depreciable lives used in computing depreciation for financial statement purposes are as follows:

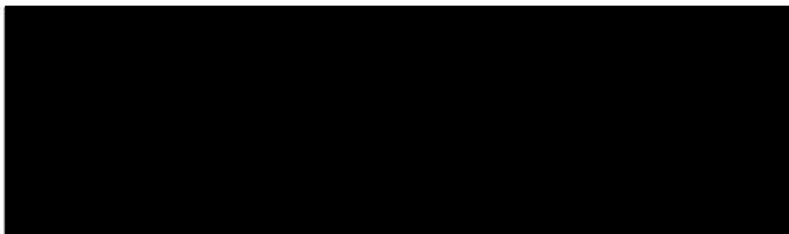

The Company evaluates long-lived assets for impairment whenever events or changes in circumstances indicate that the carrying amount of an asset may not be recoverable. No impairment has been recognized for the years ended December 31, 2016 and 2015.

**Income taxes** – The Company has elected by consent of its stockholders to be taxed under the provisions of Subchapter S of the Internal Revenue Code beginning January 1, 2014. Under these provisions, the Company does not pay federal or state corporate income taxes on its taxable income. Instead, the stockholders are liable for individual federal and state income taxes on the Company's taxable income.

**Cash and cash equivalents** - Cash includes cash in checking accounts and cash on hand. The Federal Deposit Insurance Corporation insures amounts held by each institution in the Company's name up to \$250,000.

**Use of estimates in financial statement preparation** – Management uses estimates and assumptions in preparing these consolidated financial statements in accordance with U.S. generally accepted accounting principles. Those estimates and assumptions affect the reported amounts of assets and liabilities, the disclosure of contingent assets and liabilities, and the reported amounts of revenues and expenses. Management's estimates and assumptions include, but are not limited to, estimates of collectability of accounts receivable, salvage values and estimated useful lives of fixed assets, and obsolescence of inventory. Management's estimates and assumptions are derived from and are continually evaluated based upon available information, judgment and experience. Actual results could vary from the estimates that were used.



**Sales taxes** - The Company records revenues net of any sales tax collected.

**Intangible assets and goodwill** – Intangible assets consist of loan costs, non-compete agreements, customer lists, internal software development costs, and goodwill acquired in connection with an acquisition. The Company amortizes goodwill in accordance with FASB Accounting Standards Update 2014-02.



MERCURY WIRELESS, INC. & SUBSIDIARIES  
NOTES TO THE CONSOLIDATED FINANCIAL STATEMENTS

(2) Property and equipment

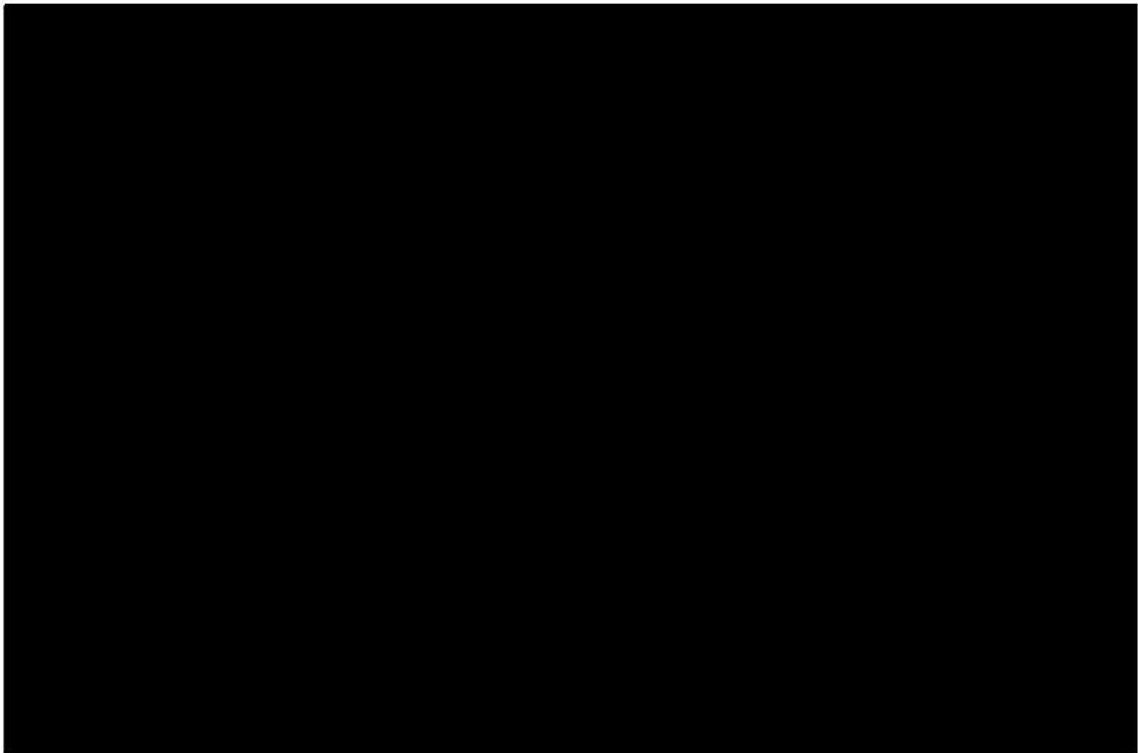

(3) CPE's, base stations, and tower supplies

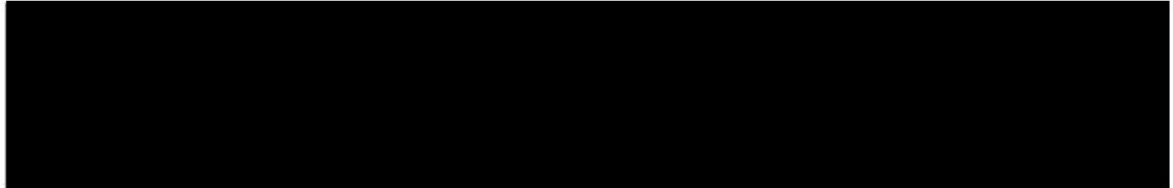

(4) Intangible assets

December 31,	
2016	2015

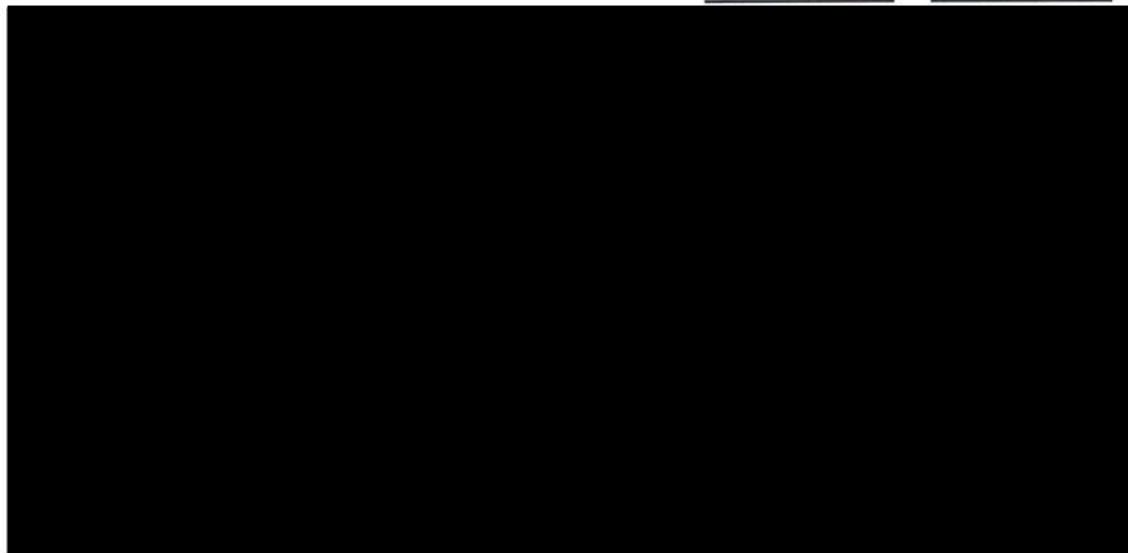

MERCURY WIRELESS, INC. & SUBSIDIARIES  
NOTES TO THE CONSOLIDATED FINANCIAL STATEMENTS



(5) Goodwill

December 31,  
2016                      2015



(6) Long-term debt

Long-term debt consists of the following as of December 31,

2016                      2015

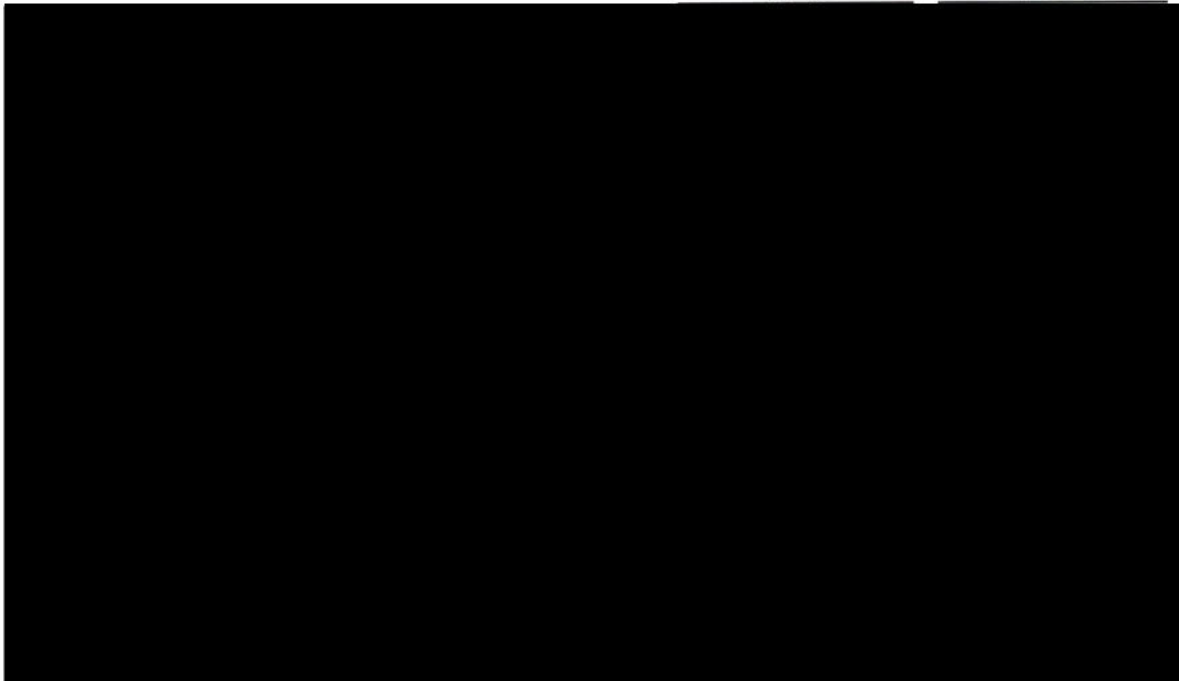

MERCURY WIRELESS, INC. & SUBSIDIARIES  
NOTES TO THE CONSOLIDATED FINANCIAL STATEMENTS

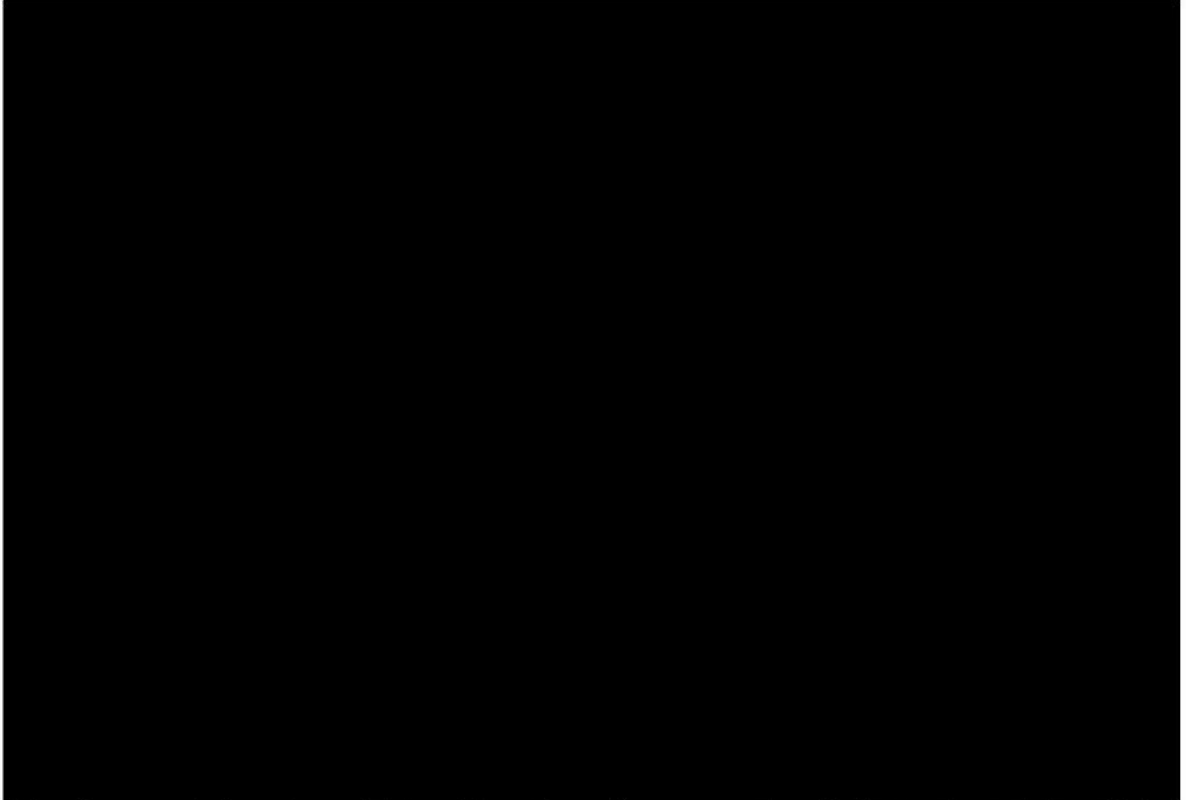

The Company's long-term debt and line of credit agreements with the bank contain certain restrictions and covenants. The Company must maintain certain levels of tangible capital base and cash flow coverage. As of December 31, 2016, the Company has met all covenants.

(7) Lines of credit

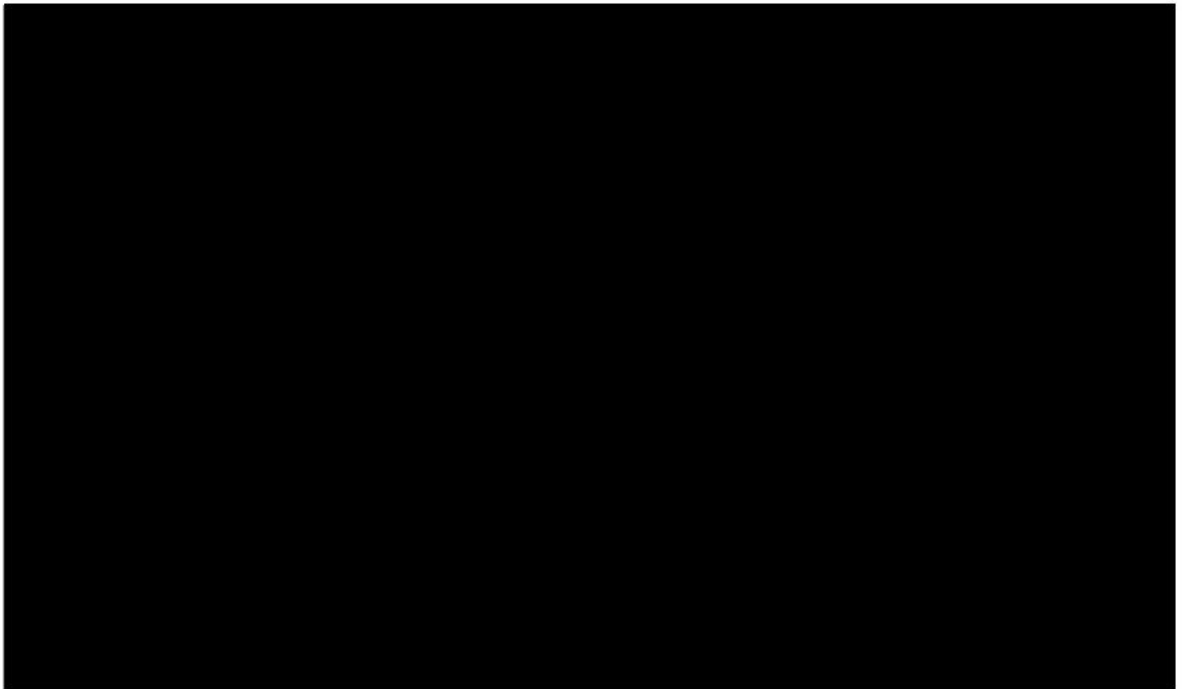

MERCURY WIRELESS, INC. & SUBSIDIARIES  
NOTES TO THE CONSOLIDATED FINANCIAL STATEMENTS

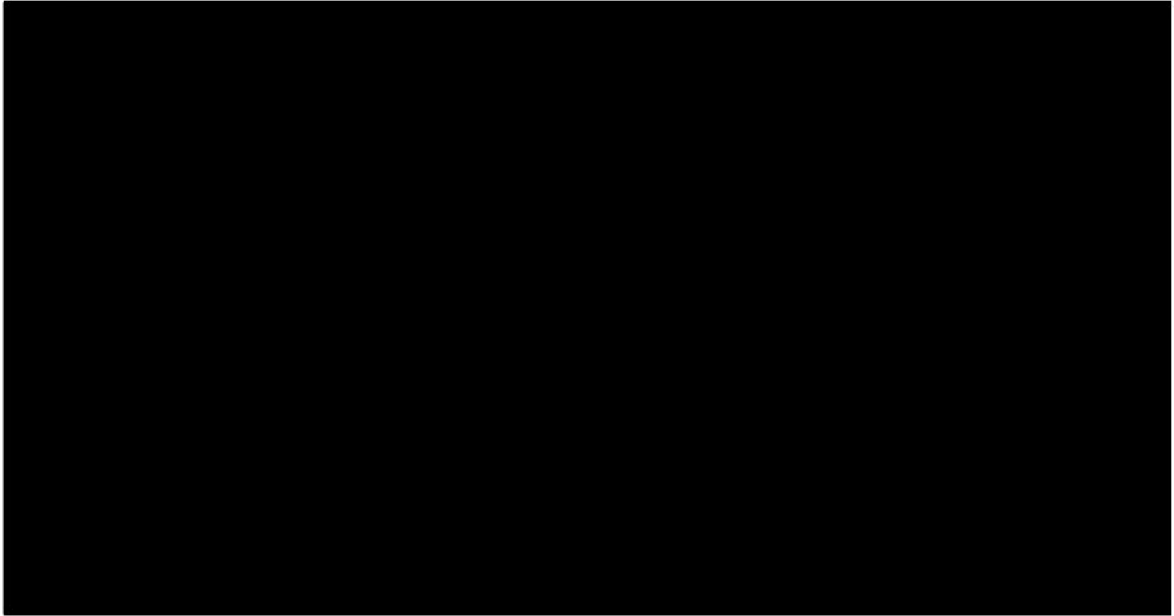

(8) Operating leases

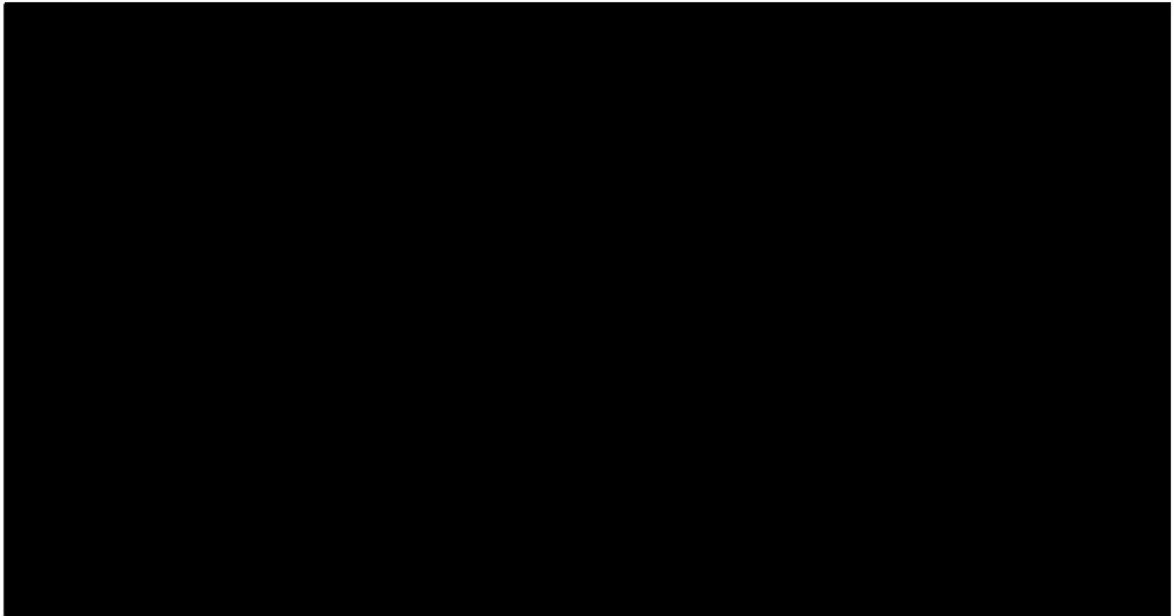

(9) Cash flow disclosures

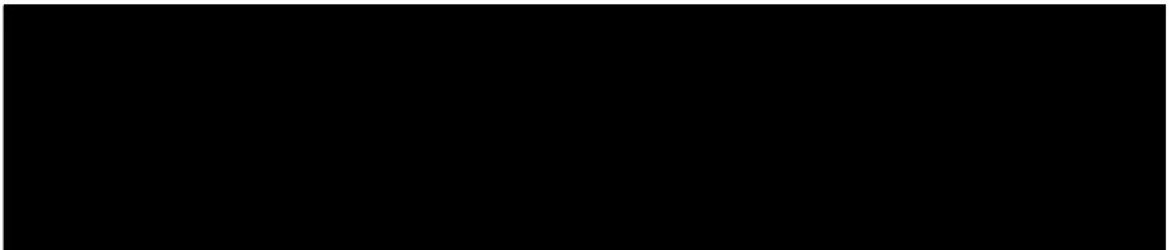

(10) Concentrations



MERCURY WIRELESS, INC. & SUBSIDIARIES  
NOTES TO THE CONSOLIDATED FINANCIAL STATEMENTS

(11) Related party transactions



(12) Non-cash transactions

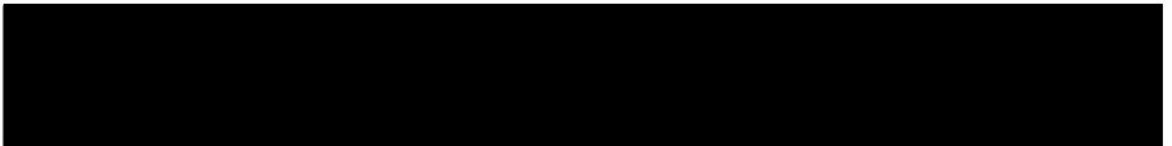

(13) Acquisitions

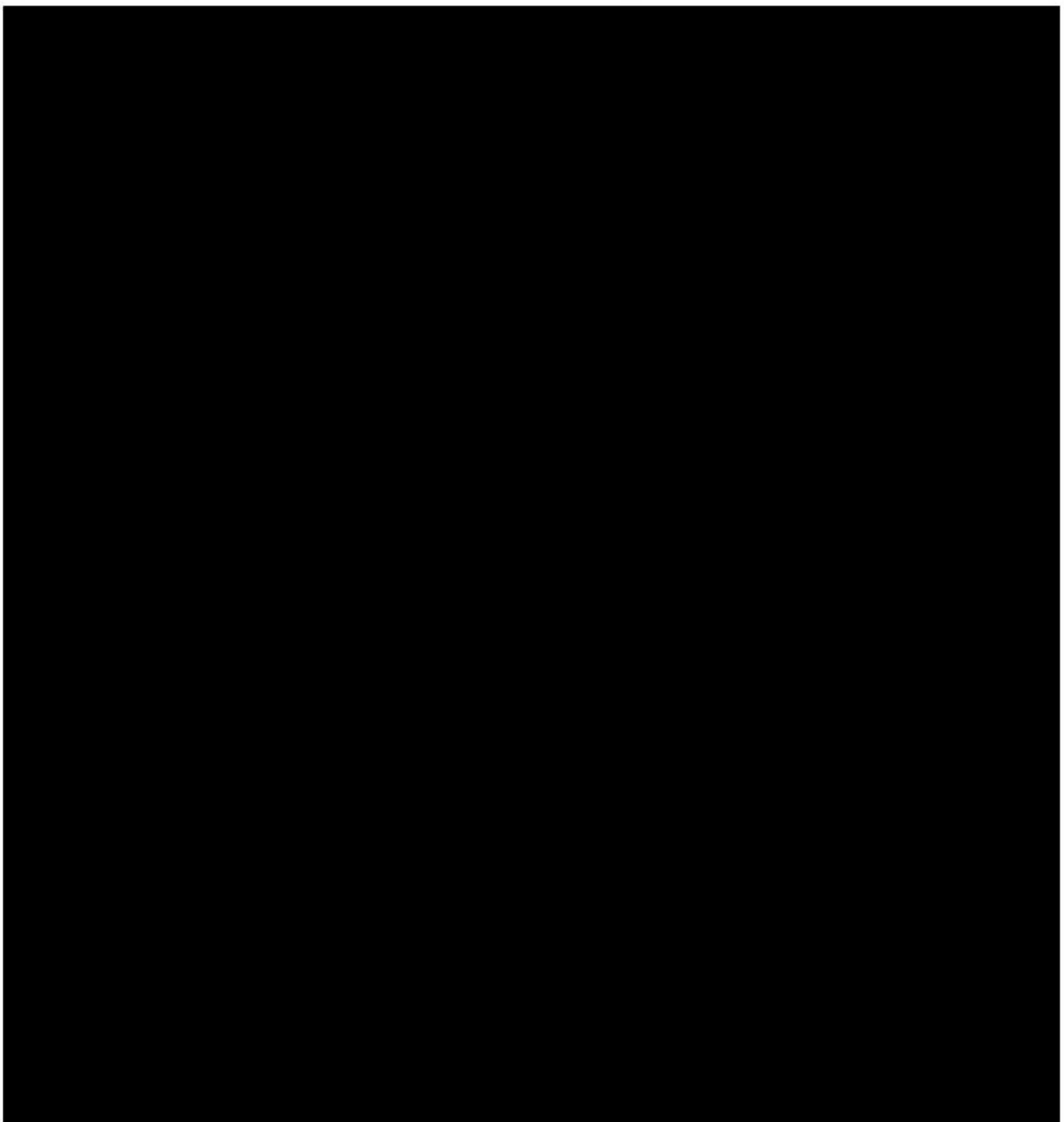

MERCURY WIRELESS, INC. & SUBSIDIARIES  
NOTES TO THE CONSOLIDATED FINANCIAL STATEMENTS



(14) Subsequent events



SUPPLEMENTAL INFORMATION



990 SW Fairlawn ■ Topeka, KS 66606  
Main: 785.272.3176 ■ Fax: 785.272.2903 ■ [www.mhmcpa.com](http://www.mhmcpa.com)

## INDEPENDENT AUDITORS' REPORT ON SUPPLEMENTARY INFORMATION

To the Board of Trustees  
Mercury Wireless, Inc.  
Fort Wayne, Indiana

We have audited the consolidated financial statements of Mercury Wireless, Inc. & Subsidiaries as of and for the years ended December 31, 2016 and 2015, and our report thereon dated March 17, 2017, which expressed an unmodified opinion on the consolidated financial statements, appears on page 1. Our audits were conducted for the purpose of forming an opinion on the consolidated financial statements as a whole. The supplementary information on page 16 is presented for purposes of additional analysis and is not a required part of the consolidated financial statements. Such information is the responsibility of management and was derived from and relates directly to the underlying accounting and other records used to prepare the consolidated financial statements. The information has been subjected to the auditing procedures applied in the audits of the consolidated financial statements and certain additional procedures; including comparing and reconciling such information directly to the underlying accounting and other records used to prepare the consolidated financial statements or to the consolidated financial statements themselves, and other additional procedures in accordance with auditing standards generally accepted in the United States of America. In our opinion, the information is fairly stated in all material respects in relation to the consolidated financial statements as a whole.

*Mayer Hoffman McCann P.C.*

Mayer Hoffman McCann P.C.  
Topeka, Kansas  
March 17, 2017



MERCURY WIRELESS, INC. & SUBSIDIARIES  
CONSOLIDATED SELLING, GENERAL AND ADMINISTRATIVE EXPENSES

Years ended December 31,  
2016                      2015

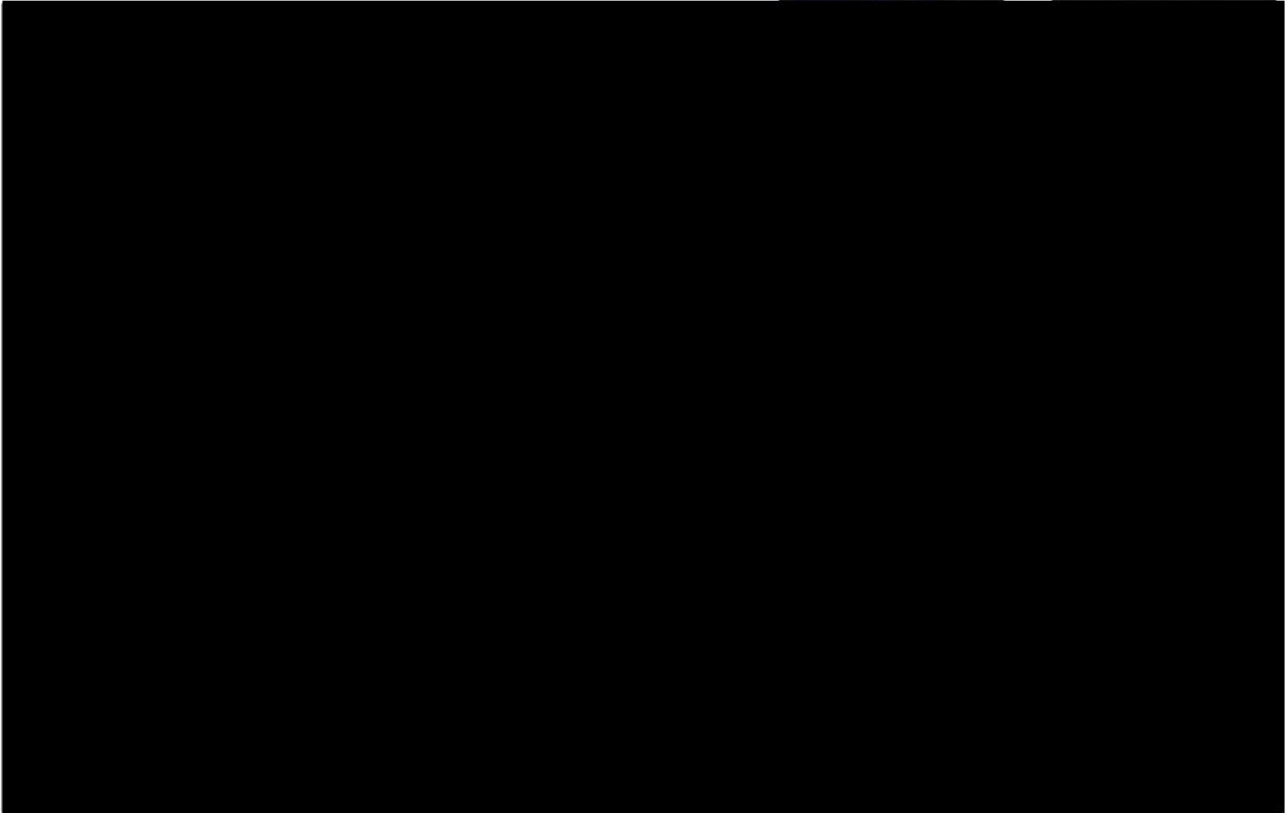

# **Mercury Wireless, Inc. & Subsidiaries**

Independent Auditor's Reports and  
Consolidated Financial Statements

December 31, 2017



**Mercury Wireless, Inc. & Subsidiaries**  
December 31, 2017

**Contents**

**Independent Auditor's Report..... 1**

**Consolidated Financial Statements**

Balance Sheet ..... 3  
Statement of Income..... 4  
Statement of Stockholders' Equity ..... 5  
Statement of Cash Flows ..... 6  
Notes to Financial Statements ..... 7

## Independent Auditor's Report

Board of Directors  
Mercury Wireless, Inc. & Subsidiaries  
Topeka, Kansas

### *Report on the Financial Statements*

We have audited the accompanying consolidated financial statements of Mercury Wireless, Inc. & Subsidiaries, which comprise the balance sheet as of December 31, 2017, and the related consolidated statements of income, stockholders' equity and cash flows for the year then ended, and the related notes to the consolidated financial statements.

### *Management's Responsibility for the Financial Statements*

Management is responsible for the preparation and fair presentation of these consolidated financial statements in accordance with accounting principles generally accepted in the United States of America; this includes the design, implementation and maintenance of internal control relevant to the preparation and fair presentation of consolidated financial statements that are free from material misstatement, whether due to fraud or error.

### *Auditor's Responsibility*

Our responsibility is to express an opinion on these consolidated financial statements based on our audit. We conducted our audit in accordance with auditing standards generally accepted in the United States of America. Those standards require that we plan and perform the audit to obtain reasonable assurance about whether the consolidated financial statements are free from material misstatement.

An audit involves performing procedures to obtain audit evidence about the amounts and disclosures in the consolidated financial statements. The procedures selected depend on the auditor's judgment, including the assessment of the risks of material misstatement of the consolidated financial statements, whether due to fraud or error. In making those risk assessments, the auditor considers internal control relevant to the entity's preparation and fair presentation of the consolidated financial statements in order to design audit procedures that are appropriate in the circumstances, but not for the purpose of expressing an opinion on the effectiveness of the entity's internal control. Accordingly, we express no such opinion. An audit also includes evaluating the appropriateness of accounting policies used and the reasonableness of significant accounting estimates made by management, as well as evaluating the overall presentation of the consolidated financial statements.

We believe that the audit evidence we have obtained is sufficient and appropriate to provide a basis for our audit opinion.

Board of Directors  
Mercury Wireless, Inc. & Subsidiaries  
Page 2

*Opinion*

In our opinion, the consolidated financial statements referred to above present fairly, in all material respects, the financial position of Mercury Wireless, Inc. & Subsidiaries as of December 31, 2017, and the results of their operations and their cash flows for the year then ended in accordance with accounting principles generally accepted in the United States of America.

*BKD, LLP*

Kansas City, Missouri  
June 4, 2018

**Mercury Wireless, Inc. & Subsidiaries**  
**Consolidated Balance Sheet**  
**December 31, 2017**

**Assets**

<div style="background-color: black; width: 100%; height: 15px;"></div> <div style="background-color: black; width: 90%; height: 15px; margin-left: 10px;"></div> <div style="background-color: black; width: 70%; height: 15px; margin-left: 30px;"></div> <div style="background-color: black; width: 50%; height: 15px; margin-left: 50px;"></div> <div style="background-color: black; width: 100%; height: 15px; margin-top: 10px;"></div> <div style="background-color: black; width: 95%; height: 15px; margin-left: 5px;"></div> <div style="background-color: black; width: 80%; height: 15px; margin-left: 20px;"></div> <div style="background-color: black; width: 60%; height: 15px; margin-left: 40px;"></div> <div style="background-color: black; width: 40%; height: 15px; margin-left: 60px;"></div> <div style="background-color: black; width: 20%; height: 15px; margin-left: 80px;"></div> <div style="background-color: black; width: 10%; height: 15px; margin-left: 90px;"></div>		<div style="background-color: black; width: 100%; height: 15px;"></div> <div style="background-color: black; width: 10%; height: 15px; margin-left: 10px;"></div> <div style="background-color: black; width: 15%; height: 15px; margin-left: 5px;"></div> <div style="border-top: 1px solid black; background-color: black; width: 100%; height: 15px;"></div> <div style="background-color: black; width: 100%; height: 15px;"></div> <div style="border-top: 1px solid black; background-color: black; width: 100%; height: 15px;"></div> <div style="background-color: black; width: 100%; height: 15px;"></div> <div style="border-top: 1px solid black; background-color: black; width: 100%; height: 15px;"></div> <div style="background-color: black; width: 100%; height: 15px;"></div> <div style="border-top: 1px solid black; background-color: black; width: 100%; height: 15px;"></div> <div style="background-color: black; width: 100%; height: 15px;"></div> <div style="border-top: 1px solid black; border-bottom: 3px double black; background-color: black; width: 100%; height: 15px;"></div>
--	--	--

*See Notes to Consolidated Financial Statements*

## Liabilities and Stockholders' Equity

<b>Accounts payable</b>		
<b>Notes payable</b>		
<b>Accrued liabilities</b>		
<b>Accounts receivable</b>		
<b>Inventory</b>		
<b>Prepaid expenses</b>		
<b>Land</b>		
<b>Buildings</b>		
<b>Equipment</b>		
<b>Accumulated depreciation</b>		
<b>Common stock</b>		
<b>Retained earnings</b>		
<b>Total</b>		

**Mercury Wireless, Inc. & Subsidiaries**  
**Consolidated Statement of Income**  
**Year Ended December 31, 2017**

Revenue	100
Cost of Sales	50
Operating Expenses	30
Operating Income	20
Non-Operating Income	10
Income Before Taxes	30
Income Tax Expense	5
Net Income	25
Other Comprehensive Income	1
Comprehensive Income	26



**Mercury Wireless, Inc. & Subsidiaries**  
**Consolidated Statement of Stockholders' Equity**  
**Year Ended December 31, 2017**

	Common Stock	Additional Paid-in Capital	Retained Earnings	Total Stockholders' Equity
████████████████████				
████████████████████				
████████████████████				
████████████████████				
████████████████████				
████████████████████				
████████████████████				
████████████████████				
████████████████████				
████████████████████				

**Mercury Wireless, Inc. & Subsidiaries**  
**Consolidated Statement of Cash Flows**  
**Year Ended December 31, 2017**

<div style="background-color: black; width: 100%; height: 15px; margin-bottom: 5px;"></div> <div style="background-color: black; width: 100%; height: 15px; margin-bottom: 5px;"></div> <div style="background-color: black; width: 100%; height: 15px; margin-bottom: 5px;"></div> <div style="background-color: black; width: 100%; height: 15px; margin-bottom: 5px;"></div> <div style="background-color: black; width: 100%; height: 15px; margin-bottom: 5px;"></div> <div style="background-color: black; width: 100%; height: 15px; margin-bottom: 5px;"></div> <div style="background-color: black; width: 100%; height: 15px; margin-bottom: 5px;"></div> <div style="background-color: black; width: 100%; height: 15px; margin-bottom: 5px;"></div> <div style="background-color: black; width: 100%; height: 15px; margin-bottom: 5px;"></div>		<div style="background-color: black; width: 80%; height: 15px; margin-bottom: 5px;"></div> <div style="background-color: black; width: 80%; height: 15px; margin-bottom: 5px;"></div> <div style="background-color: black; width: 80%; height: 15px; margin-bottom: 5px;"></div> <div style="background-color: black; width: 80%; height: 15px; margin-bottom: 5px;"></div> <div style="border-top: 1px solid black; background-color: black; width: 80%; height: 15px; margin-bottom: 5px;"></div> <div style="border-top: 1px solid black; background-color: black; width: 80%; height: 15px; margin-bottom: 5px;"></div> <div style="border-top: 1px solid black; background-color: black; width: 80%; height: 15px; margin-bottom: 5px;"></div> <div style="border-top: 1px solid black; background-color: black; width: 80%; height: 15px; margin-bottom: 5px;"></div> <div style="border-top: 1px solid black; background-color: black; width: 80%; height: 15px; margin-bottom: 5px;"></div> <div style="border-top: 1px solid black; background-color: black; width: 80%; height: 15px; margin-bottom: 5px;"></div> <div style="border-top: 1px solid black; background-color: black; width: 80%; height: 15px; margin-bottom: 5px;"></div> <div style="border-top: 1px solid black; background-color: black; width: 80%; height: 15px; margin-bottom: 5px;"></div> <div style="border-top: 1px solid black; background-color: black; width: 80%; height: 15px; margin-bottom: 5px;"></div> <div style="border-top: 1px solid black; background-color: black; width: 80%; height: 15px; margin-bottom: 5px;"></div>
<div style="background-color: black; width: 100%; height: 15px; margin-bottom: 5px;"></div> <div style="background-color: black; width: 100%; height: 15px; margin-bottom: 5px;"></div> <div style="background-color: black; width: 100%; height: 15px; margin-bottom: 5px;"></div> <div style="background-color: black; width: 100%; height: 15px; margin-bottom: 5px;"></div> <div style="background-color: black; width: 100%; height: 15px; margin-bottom: 5px;"></div> <div style="background-color: black; width: 100%; height: 15px; margin-bottom: 5px;"></div>		<div style="border-top: 1px solid black; background-color: black; width: 80%; height: 15px; margin-bottom: 5px;"></div> <div style="border-top: 1px solid black; background-color: black; width: 80%; height: 15px; margin-bottom: 5px;"></div> <div style="border-top: 1px solid black; background-color: black; width: 80%; height: 15px; margin-bottom: 5px;"></div> <div style="border-top: 1px solid black; background-color: black; width: 80%; height: 15px; margin-bottom: 5px;"></div>
<div style="background-color: black; width: 100%; height: 15px; margin-bottom: 5px;"></div> <div style="background-color: black; width: 100%; height: 15px; margin-bottom: 5px;"></div> <div style="background-color: black; width: 100%; height: 15px; margin-bottom: 5px;"></div>		<div style="border-top: 1px solid black; background-color: black; width: 80%; height: 15px; margin-bottom: 5px;"></div> <div style="border-top: 1px solid black; background-color: black; width: 80%; height: 15px; margin-bottom: 5px;"></div>
<div style="background-color: black; width: 100%; height: 15px; margin-bottom: 5px;"></div> <div style="background-color: black; width: 100%; height: 15px; margin-bottom: 5px;"></div> <div style="background-color: black; width: 100%; height: 15px; margin-bottom: 5px;"></div> <div style="background-color: black; width: 100%; height: 15px; margin-bottom: 5px;"></div> <div style="background-color: black; width: 100%; height: 15px; margin-bottom: 5px;"></div>		<div style="border-top: 1px solid black; background-color: black; width: 80%; height: 15px; margin-bottom: 5px;"></div> <div style="border-top: 1px solid black; background-color: black; width: 80%; height: 15px; margin-bottom: 5px;"></div> <div style="border-top: 1px solid black; background-color: black; width: 80%; height: 15px; margin-bottom: 5px;"></div>
<div style="background-color: black; width: 100%; height: 15px; margin-bottom: 5px;"></div>		<div style="border-top: 1px solid black; background-color: black; width: 80%; height: 15px; margin-bottom: 5px;"></div>
<div style="background-color: black; width: 100%; height: 15px; margin-bottom: 5px;"></div> <div style="background-color: black; width: 100%; height: 15px; margin-bottom: 5px;"></div> <div style="background-color: black; width: 100%; height: 15px; margin-bottom: 5px;"></div> <div style="background-color: black; width: 100%; height: 15px; margin-bottom: 5px;"></div>		<div style="border-top: 1px solid black; background-color: black; width: 80%; height: 15px; margin-bottom: 5px;"></div> <div style="border-top: 1px solid black; background-color: black; width: 80%; height: 15px; margin-bottom: 5px;"></div> <div style="border-top: 1px solid black; background-color: black; width: 80%; height: 15px; margin-bottom: 5px;"></div>
<div style="background-color: black; width: 100%; height: 15px; margin-bottom: 5px;"></div> <div style="background-color: black; width: 100%; height: 15px; margin-bottom: 5px;"></div> <div style="background-color: black; width: 100%; height: 15px; margin-bottom: 5px;"></div> <div style="background-color: black; width: 100%; height: 15px; margin-bottom: 5px;"></div> <div style="background-color: black; width: 100%; height: 15px; margin-bottom: 5px;"></div> <div style="background-color: black; width: 100%; height: 15px; margin-bottom: 5px;"></div>		<div style="border-top: 1px solid black; background-color: black; width: 80%; height: 15px; margin-bottom: 5px;"></div> <div style="border-top: 1px solid black; background-color: black; width: 80%; height: 15px; margin-bottom: 5px;"></div> <div style="border-top: 1px solid black; background-color: black; width: 80%; height: 15px; margin-bottom: 5px;"></div> <div style="border-top: 1px solid black; background-color: black; width: 80%; height: 15px; margin-bottom: 5px;"></div> <div style="border-top: 1px solid black; background-color: black; width: 80%; height: 15px; margin-bottom: 5px;"></div>

**Mercury Wireless, Inc. & Subsidiaries**  
**Notes to Consolidated Financial Statements**  
**December 31, 2017**

**Note 1: Nature of Operations and Summary of Significant Accounting Policies**

***Nature of Operations***

Mercury Wireless, Inc. & Subsidiaries (herein referred to as “the Company”) is a provider of Internet, phone and other telecommunications services throughout the Midwestern United States. The Company has offices in Topeka, Kansas and Fort Wayne, Indiana.

***Principles of Consolidation***

The consolidated financial statements include the accounts of the Company, its wholly-owned subsidiaries, Mercury Wireless Kansas, LLC, Mercury Wireless Indiana, LLC, Mercury Access Solutions, LLC and Mercury Networks, LLC. All significant intercompany accounts and transactions have been eliminated in consolidation. See *Note 2* for additional discussion of the Common Control Transaction.

***Use of Estimates***

The preparation of financial statements in conformity with accounting principles generally accepted in the United States of America requires management to make estimates and assumptions that affect the reported amounts of assets and liabilities and disclosure of contingent assets and liabilities at the date of the financial statements and the reported amounts of revenues and expenses during the reporting period. Actual results could differ from those estimates.

***Cash***

██

***Accounts Receivable***

Accounts receivable are stated at the amount billed to customers plus any accrued and unpaid fees. The Company provides an allowance for doubtful accounts, which is based upon a review of outstanding receivables, historical collection information and existing economic conditions. Accounts receivable are ordinarily due ██████████ after the issuance of the invoice. Receivables are written off when they become uncollectible based on individual credit evaluation and specific circumstances of the customer.

***Materials and Supplies Pricing***

Materials and supplies consists of CPEs, base stations and tower supplies. Inventories are stated at the lower of cost or net realizable value. Costs are determined using the FIFO method.

***Prepaid Expenses and Other***

██  
██

**Mercury Wireless, Inc. & Subsidiaries**  
**Notes to Consolidated Financial Statements**  
**December 31, 2017**

***Property, Plant and Equipment***

Property, plant and equipment acquisitions are stated at cost less accumulated depreciation and amortization. Depreciation and amortization is charged to expense on the straight-line basis over the estimated useful life of each asset. The estimated useful lives for each major depreciable classification of property, plant and equipment are as follows:

The table content is completely redacted with black boxes, obscuring the estimated useful lives for each major depreciable classification.

***Goodwill***

The Company has elected the accounting alternative for the subsequent measurement of goodwill. Under this alternative, goodwill is amortized on a straight-line basis over 10 -15 years depending on the goodwill acquired. The Company evaluates the recoverability of the carrying value of goodwill at the entity level whenever events or circumstances indicate the carrying amount may not be recoverable.

In testing goodwill for impairment, the Company has the option first to perform a qualitative assessment to determine whether it is more likely than not that goodwill is impaired or the entity can bypass the qualitative assessment and proceed directly to the quantitative test by comparing the carrying amount, including goodwill, of the entity with its fair value. The goodwill impairment loss, if any, is measured as the amount by which the carrying amount of an entity, including goodwill, exceeds its fair value. Subsequent increases in goodwill value are not recognized in the consolidated financial statements.

***Long-lived Asset Impairment***

The Company evaluates the recoverability of the carrying value of long-lived assets whenever events or circumstances indicate the carrying amount may not be recoverable. If a long-lived asset is tested for recoverability and the undiscounted estimated future cash flows expected to result from the use and eventual disposition of the asset is less than the carrying amount of the asset, the asset cost is adjusted to fair value and an impairment loss is recognized as the amount by which the carrying amount of a long-lived asset exceeds its fair value. No asset impairment was recognized during the year ended December 31, 2017.

**Mercury Wireless, Inc. & Subsidiaries**  
**Notes to Consolidated Financial Statements**  
**December 31, 2017**

***Asset Retirement Obligations***

Generally accepted accounting principles require entities to record the fair value of a liability for legal obligations associated with an asset retirement in the period in which the obligations are incurred. When the liability is initially recorded, the Company capitalizes the costs of the assets retirement obligation by increasing the carrying amount of related long-lived assets.

Over time, the liability is accreted to its present value each period, and the capitalized cost is depreciated over the useful life of the related asset.

The Company has determined it does not have a material legal obligation to remove long-lived assets, and accordingly, there have been no liabilities recorded for the year ended December 31, 2017.

***Intangible Assets***

Intangible assets are being amortized on the straight-line basis over periods ranging from 5 to 10 years. Such assets are periodically evaluated as to the recoverability of their carrying values.

***Income Taxes***

The Company's stockholders have elected to have the Company's income taxed as an "S" Corporation under provisions of the Internal Revenue Code and a similar section of the Kansas income tax law. Therefore, taxable income or loss is reported to the individual stockholders for inclusion in their respective tax returns and no provision for federal and state income taxes is included in these statements.

***Revenue Recognition***

The Company recognizes revenues when earned regardless of the period in which the customer is billed. The Company is required to provide service to subscribers within its defined service territory. Internet revenues are recognized over the period a subscriber is connected to the network.

***Stock Option Plan***

[REDACTED]

***Taxes Collected from Customers and Remitted to Governmental Authorities***

Taxes collected from customers and remitted to governmental authorities are presented in the accompanying consolidated statement of income on a net basis.

**Mercury Wireless, Inc. & Subsidiaries**  
**Notes to Consolidated Financial Statements**  
**December 31, 2017**

**Note 2: Common Control Transaction**

[REDACTED]

[REDACTED]

[REDACTED]

[REDACTED]

[REDACTED]

[REDACTED]

[REDACTED]

**Mercury Wireless, Inc. & Subsidiaries**  
**Notes to Consolidated Financial Statements**  
**December 31, 2017**

**Note 3: Property, Plant and Equipment**

Property, plant and equipment includes the following as of December 31, 2017:

[REDACTED]	[REDACTED]
[REDACTED]	[REDACTED]
[REDACTED]	[REDACTED]

**Note 4: Intangible Assets and Goodwill**

The carrying basis and accumulated amortization of recognized intangible assets at December 31, 2017, were:

	Gross Carrying Amount	Accumulated Amortization
[REDACTED]	[REDACTED]	[REDACTED]
[REDACTED]	[REDACTED]	[REDACTED]
[REDACTED]	[REDACTED]	[REDACTED]
[REDACTED]	[REDACTED]	[REDACTED]
[REDACTED]	[REDACTED]	[REDACTED]
	<u>[REDACTED]</u>	<u>[REDACTED]</u>
	<u>[REDACTED]</u>	<u>[REDACTED]</u>

The changes in the carrying amount of goodwill for the year ended December 31, 2017 included amortization expense of \$66,559. Amortization expense for the year ended December 31, 2017 was \$16,588 for intangibles.

**Mercury Wireless, Inc. & Subsidiaries**  
**Notes to Consolidated Financial Statements**  
**December 31, 2017**

Estimated intangibles and goodwill amortization expense for each of the following five years and thereafter is:

<div style="background-color: black; width: 80px; height: 100px; margin: 0 auto;"></div>	<table style="margin: 0 auto; border-collapse: collapse;"> <tr> <td style="border-bottom: 1px solid black; width: 80%;"></td> <td style="border-bottom: 1px solid black; width: 20%;"></td> </tr> <tr> <td style="border-bottom: 1px solid black; width: 80%;"></td> <td style="border-bottom: 1px solid black; width: 20%;"></td> </tr> <tr> <td style="border-bottom: 1px solid black; width: 80%;"></td> <td style="border-bottom: 1px solid black; width: 20%;"></td> </tr> <tr> <td style="border-bottom: 1px solid black; width: 80%;"></td> <td style="border-bottom: 1px solid black; width: 20%;"></td> </tr> <tr> <td style="border-bottom: 1px solid black; width: 80%;"></td> <td style="border-bottom: 1px solid black; width: 20%;"></td> </tr> <tr> <td style="border-bottom: 1px solid black; width: 80%;"></td> <td style="border-bottom: 1px solid black; width: 20%;"></td> </tr> <tr> <td style="border-bottom: 1px solid black; width: 80%;"></td> <td style="border-bottom: 1px solid black; width: 20%;"></td> </tr> <tr> <td style="border-bottom: 1px solid black; width: 80%;"></td> <td style="border-bottom: 1px solid black; width: 20%;"></td> </tr> <tr> <td style="border-bottom: 1px solid black; width: 80%;"></td> <td style="border-bottom: 1px solid black; width: 20%;"></td> </tr> <tr> <td style="border-bottom: 1px solid black; width: 80%;"></td> <td style="border-bottom: 1px solid black; width: 20%;"></td> </tr> </table>																				

**Note 5: Long-Term Debt**

Long-term debt as of December 31, 2017 consists of the following:

<div style="background-color: black; width: 200px; height: 180px; margin: 0 auto;"></div>	<table style="margin: 0 auto; border-collapse: collapse;"> <tr> <td style="border-bottom: 1px solid black; width: 80%;"></td> <td style="border-bottom: 1px solid black; width: 20%;"></td> </tr> <tr> <td style="border-bottom: 1px solid black; width: 80%;"></td> <td style="border-bottom: 1px solid black; width: 20%;"></td> </tr> <tr> <td style="border-bottom: 1px solid black; width: 80%;"></td> <td style="border-bottom: 1px solid black; width: 20%;"></td> </tr> <tr> <td style="border-bottom: 1px solid black; width: 80%;"></td> <td style="border-bottom: 1px solid black; width: 20%;"></td> </tr> <tr> <td style="border-bottom: 1px solid black; width: 80%;"></td> <td style="border-bottom: 1px solid black; width: 20%;"></td> </tr> <tr> <td style="border-bottom: 1px solid black; width: 80%;"></td> <td style="border-bottom: 1px solid black; width: 20%;"></td> </tr> <tr> <td style="border-bottom: 1px solid black; width: 80%;"></td> <td style="border-bottom: 1px solid black; width: 20%;"></td> </tr> <tr> <td style="border-bottom: 1px solid black; width: 80%;"></td> <td style="border-bottom: 1px solid black; width: 20%;"></td> </tr> <tr> <td style="border-bottom: 1px solid black; width: 80%;"></td> <td style="border-bottom: 1px solid black; width: 20%;"></td> </tr> <tr> <td style="border-bottom: 1px solid black; width: 80%;"></td> <td style="border-bottom: 1px solid black; width: 20%;"></td> </tr> <tr> <td style="border-bottom: 1px solid black; width: 80%;"></td> <td style="border-bottom: 1px solid black; width: 20%;"></td> </tr> <tr> <td style="border-bottom: 1px solid black; width: 80%;"></td> <td style="border-bottom: 1px solid black; width: 20%;"></td> </tr> </table>																								

<div style="background-color: black; width: 600px; height: 40px; margin: 0 auto;"></div>	<div style="background-color: black; width: 600px; height: 40px; margin: 0 auto;"></div>
<div style="background-color: black; width: 600px; height: 40px; margin: 0 auto;"></div>	<div style="background-color: black; width: 600px; height: 40px; margin: 0 auto;"></div>
<div style="background-color: black; width: 600px; height: 40px; margin: 0 auto;"></div>	<div style="background-color: black; width: 600px; height: 40px; margin: 0 auto;"></div>



# Mercury Wireless, Inc. & Subsidiaries

## Notes to Consolidated Financial Statements

December 31, 2017

- [REDACTED]
- [REDACTED]
- [REDACTED]
- [REDACTED]
- [REDACTED]
- [REDACTED]
- [REDACTED]
- [REDACTED]
- [REDACTED]

[REDACTED]	[REDACTED]
[REDACTED]	[REDACTED]
[REDACTED]	[REDACTED]

**Mercury Wireless, Inc. & Subsidiaries**  
**Notes to Consolidated Financial Statements**  
**December 31, 2017**

**Note 6: Operating Leases**



The table for Note 6 is completely redacted with black boxes. It appears to be a multi-column table with at least two columns, as indicated by the horizontal lines and the vertical bars. The redaction covers all text and numbers within the table.

**Note 7: Employee Benefit Plan**

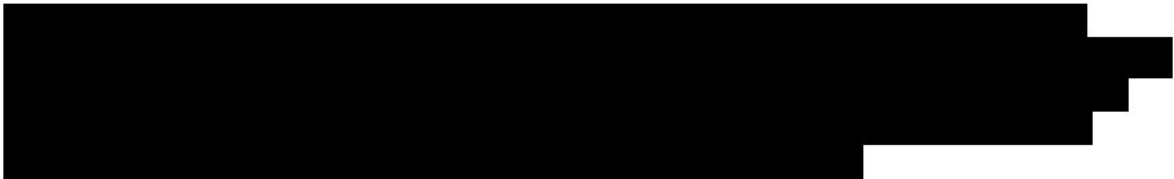

The table for Note 7 is completely redacted with black boxes. It appears to be a multi-column table with at least two columns, as indicated by the horizontal lines and the vertical bars. The redaction covers all text and numbers within the table.

**Note 8: Stock Option Plan**



The table for Note 8 is completely redacted with black boxes. It appears to be a multi-column table with at least two columns, as indicated by the horizontal lines and the vertical bars. The redaction covers all text and numbers within the table.

**Mercury Wireless, Inc. & Subsidiaries**  
**Notes to Consolidated Financial Statements**  
**December 31, 2017**

The fair value of each option award is estimated on the date of grant using a Black-Scholes option valuation model that uses the assumptions noted in the following table. Expected volatility is based on a peer group of similar public companies' historical common stock volatility derived from historical stock price data for historical period commensurate with the Company's options' expected life. The Company could not determine its own stock price volatility due to few and infrequent stock transactions and thus, utilized the average volatility of two similar public companies. The expected term of options granted represents the period of time that options are expected to be outstanding. The risk-free rate for periods within the contractual life of the option is based on the U.S. Treasury yield curve in effect at the time of grant. The expected dividend yield is zero, as the Company has historically paid no dividends and does not anticipate dividends to be paid in the future.

A summary of option activity under the Plan as of December 31, 2017, and changes during the year then ended, is presented below:

	Shares	Weighted - Average Exercise Price	Weighted - Average Remaining Contractual Term
[REDACTED]	[REDACTED]	[REDACTED]	[REDACTED]
[REDACTED]	[REDACTED]	[REDACTED]	[REDACTED]
[REDACTED]	[REDACTED]	[REDACTED]	[REDACTED]
[REDACTED]			

**Note 9: Subsequent Events**

Subsequent events have been evaluated through June 4, 2018, which is the date the consolidated financial statements were available to be issued.

**Mercury Wireless, Inc. & Subsidiaries**

Independent Auditor's Reports and  
Consolidated Financial Statements

December 31, 2018 and 2017

*DRAFT*  
*2/19/2019*

**Mercury Wireless, Inc. & Subsidiaries**  
December 31, 2018 and 2017

**Contents**

**Independent Auditor's Report..... 1**

**Consolidated Financial Statements**

Balance Sheets..... 3  
Statements of Income ..... 4  
Statements of Stockholders' Equity ..... 5  
Statements of Cash Flows ..... 6  
Notes to Financial Statements ..... 7

*/201*

## Independent Auditor's Report

Board of Directors  
Mercury Wireless, Inc. & Subsidiaries  
Topeka, Kansas

### *Report on the Financial Statements*

We have audited the accompanying consolidated financial statements of Mercury Wireless, Inc. & Subsidiaries, which comprise the balance sheets as of December 31, 2018 and 2017, and the related consolidated statements of income, stockholders' equity and cash flows for the years then ended, and the related notes to the consolidated financial statements.

### *Management's Responsibility for the Financial Statements*

Management is responsible for the preparation and fair presentation of these consolidated financial statements in accordance with accounting principles generally accepted in the United States of America; this includes the design, implementation and maintenance of internal control relevant to the preparation and fair presentation of consolidated financial statement that are free from material misstatement, whether due to fraud or error.

### *Auditor's Responsibility*

Our responsibility is to express an opinion on these consolidated financial statements based on our audits. We conducted our audits in accordance with auditing standards generally accepted in the United States of America. Those standards require that we plan and perform the audit to obtain reasonable assurance about whether the consolidated financial statements are free from material misstatement.

An audit involves performing procedures to obtain audit evidence about the amounts and disclosures in the consolidated financial statements. The procedures selected depend on the auditor's judgment, including the assessment of the risks of material misstatement of the consolidated financial statements, whether due to fraud or error. In making those risk assessments, the auditor considers internal control relevant to the entity's preparation and fair presentation of the consolidated financial statements in order to design audit procedures that are appropriate in the circumstances, but not for the purpose of expressing an opinion on the effectiveness of the entity's internal control. Accordingly, we express no such opinion. An audit also includes evaluating the appropriateness of accounting policies used and the reasonableness of significant accounting estimates made by management, as well as evaluating the overall presentation of the consolidated financial statements.

We believe that the audit evidence we have obtained is sufficient and appropriate to provide a basis for our audit opinion.

Board of Directors  
Mercury Wireless, Inc. & Subsidiaries  
Page 2

*Opinion*

In our opinion, the consolidated financial statements referred to above present fairly, in all material respects, the financial position of Mercury Wireless, Inc. & Subsidiaries as of December 31, 2018 and 2017, and the results of their operations and their cash flows for the years then ended in accordance with accounting principles generally accepted in the United States of America.

Kansas City, Missouri  
February \_\_, 2019

*/201*

# Mercury Wireless, Inc. & Subsidiaries

## Consolidated Balance Sheets

December 31, 2018 and 2017

	<u>2018</u>	<u>2017</u>
<b>Assets</b>		
Current assets:		
Cash and cash equivalents	\$ 1,234,567	\$ 1,234,567
Accounts receivable	1,234,567	1,234,567
Inventory	123,456	123,456
Prepaid expenses	123,456	123,456
Other current assets	123,456	123,456
Total current assets	<u>2,849,502</u>	<u>2,849,502</u>
Property and equipment, net	1,234,567	1,234,567
Goodwill	1,234,567	1,234,567
Intangible assets, net	123,456	123,456
Other non-current assets	123,456	123,456
Total assets	<u>\$ 5,564,508</u>	<u>\$ 5,564,508</u>

/201



2018

2017

Liabilities and Stockholders' Equity

[REDACTED]	[REDACTED]	[REDACTED]
[REDACTED]	[REDACTED]	[REDACTED]
[REDACTED]	[REDACTED]	[REDACTED]
[REDACTED]	[REDACTED]	[REDACTED]
[REDACTED]	[REDACTED]	[REDACTED]
[REDACTED]	[REDACTED]	[REDACTED]
[REDACTED]	[REDACTED]	[REDACTED]
[REDACTED]	[REDACTED]	[REDACTED]
[REDACTED]	[REDACTED]	[REDACTED]
[REDACTED]	[REDACTED]	[REDACTED]
[REDACTED]	[REDACTED]	[REDACTED]

/201

**Mercury Wireless, Inc. & Subsidiaries**  
Consolidated Statements of Income  
Years Ended December 31, 2018 and 2017

	2018	2017
[REDACTED]	[REDACTED]	[REDACTED]
[REDACTED]	[REDACTED]	[REDACTED]
[REDACTED]	[REDACTED]	[REDACTED]
[REDACTED]	[REDACTED]	[REDACTED]
[REDACTED]	[REDACTED]	[REDACTED]
[REDACTED]	[REDACTED]	[REDACTED]
[REDACTED]	[REDACTED]	[REDACTED]
[REDACTED]	[REDACTED]	[REDACTED]
[REDACTED]	[REDACTED]	[REDACTED]
[REDACTED]	[REDACTED]	[REDACTED]
[REDACTED]	[REDACTED]	[REDACTED]

/201

**Mercury Wireless, Inc. & Subsidiaries**  
**Consolidated Statements of Stockholders' Equity**  
**Years Ended December 31, 2018 and 2017**

	Common Stock	Additional Paid-in Capital	Retained Earnings	Total Stockholders' Equity
[REDACTED]				
[REDACTED]				
[REDACTED]				
[REDACTED]				
[REDACTED]				
[REDACTED]				
[REDACTED]				
[REDACTED]				
[REDACTED]				
[REDACTED]				
[REDACTED]				
[REDACTED]				
[REDACTED]				
[REDACTED]				
[REDACTED]				
[REDACTED]				
[REDACTED]				
[REDACTED]				
[REDACTED]				
[REDACTED]				
[REDACTED]				
[REDACTED]				

/201

**Mercury Wireless, Inc. & Subsidiaries**  
**Consolidated Statements of Cash Flows**  
**Years Ended December 31, 2018 and 2017**

	2018	2017
Net income	1,100	1,100
Adjustments to reconcile net income to cash provided by operating activities:		
Depreciation	1,500	1,500
Amortization of intangible assets	1,000	1,000
Loss on sale of assets	1,000	1,000
Share-based compensation	1,000	1,000
Change in current and non-current assets and liabilities	1,000	1,000
Cash provided by operating activities	6,600	6,600
Investing activities:		
Purchase of property and equipment	(1,000)	(1,000)
Purchase of intangible assets	(1,000)	(1,000)
Proceeds from sale of assets	1,000	1,000
Cash provided by investing activities	(1,000)	(1,000)
Financing activities:		
Proceeds from issuance of common stock	1,000	1,000
Proceeds from issuance of debt	1,000	1,000
Payments of principal on debt	(1,000)	(1,000)
Cash provided by financing activities	1,000	1,000
Change in cash and cash equivalents	6,600	6,600
Cash and cash equivalents at beginning of period	1,400	1,400
Cash and cash equivalents at end of period	8,000	8,000

**Mercury Wireless, Inc. & Subsidiaries**  
**Notes to the Consolidated Financial Statements**  
**December 31, 2018 and 2017**

**Note 1: Nature of Operations and Summary of Significant Accounting Policies**

***Nature of Operations***

Mercury Wireless, Inc. & Subsidiaries (herein referred to as “the Company”) is a provider of Internet, phone and other telecommunications services throughout the Midwestern United States. The Company has offices in Topeka, Kansas, Fort Wayne, Indiana and Kansas City, Missouri.

***Principles of Consolidation***

The consolidated financial statements include the accounts of the Company, its wholly-owned subsidiaries, Mercury Wireless Kansas, LLC, Mercury Wireless Indiana, LLC, Mercury Access Solutions, LLC and Mercury Networks, LLC. All significant intercompany accounts and transactions have been eliminated in consolidation. See *Note 2* for additional discussion of the Common Control Transaction.

***Use of Estimates***

The preparation of consolidated financial statements in conformity with accounting principles generally accepted in the United States of America requires management to make estimates and assumptions that affect the reported amount of assets and liabilities and disclosure of contingent assets and liabilities at the date of the consolidated financial statements and the reported amounts of revenues and expenses during the reporting period. Actual results could differ from those estimates.

***Cash***

██

***Accounts Receivable***

Accounts receivable are stated at the amount billed to customers plus any accrued and unpaid fees. The Company provides an allowance for doubtful accounts, which is based upon a review of outstanding receivables, historical collection information and existing economic conditions. Accounts receivable are ordinarily due ██████████ after the issuance of the invoice. Receivables are written off when they become uncollectible based on individual credit evaluation and specific circumstances of the customer.

***Materials and Supplies Pricing***

Materials and supplies consists of CPEs, base stations and tower supplies. Inventories are stated at the lower of cost or net realizable value. Costs are determined using the FIFO method.

**Mercury Wireless, Inc. & Subsidiaries**  
**Notes to the Consolidated Financial Statements**  
**December 31, 2018 and 2017**

***Prepaid Expenses and Other***



***Property, Plant and Equipment***

Property, plant and equipment acquisitions are stated at cost less accumulated depreciation and amortization. Depreciation and amortization is charged to expense on the straight-line basis over the estimated useful life of each asset. The estimated useful lives for each major depreciable classification of property, plant and equipment are as follows:



***Goodwill***

The Company has elected the private company accounting alternative for the subsequent measurement of goodwill. Under this alternative, goodwill is amortized on a straight-line basis over 10 - 15 years depending on the goodwill acquired. The Company evaluates the recoverability of the carrying value of goodwill at the entity level whenever events or circumstances indicate the carrying amount may not be recoverable.

In testing goodwill for impairment, the Company has the option first to perform a qualitative assessment to determine whether it is more likely than not that goodwill is impaired or the entity can bypass the qualitative assessment and proceed directly to the quantitative test by comparing the carrying amount, including goodwill, of the entity with its fair value. The goodwill impairment loss, if any, is measured as the amount by which the carrying amount of an entity, including goodwill, exceeds its fair value. Subsequent increases in goodwill value are not recognized in the consolidated financial statements.

***Long-lived Asset Impairment***

The Company evaluates the recoverability of the carrying value of long-lived assets whenever events or circumstances indicate the carrying amount may not be recoverable. If a long-lived asset is tested for recoverability and the undiscounted estimated future cash flows expected to result from the use and eventual disposition of the asset is less than the carrying amount of the asset, the asset cost is adjusted to fair value and an impairment loss is recognized as the amount by which the carrying amount of a long-lived asset exceeds its fair value. No asset impairment was recognized during the years ended December 31, 2018 or 2017.

**Mercury Wireless, Inc. & Subsidiaries**  
**Notes to the Consolidated Financial Statements**  
**December 31, 2018 and 2017**

***Asset Retirement Obligations***

Generally accepted accounting principles require entities to record the fair value of a liability for legal obligations associated with an asset retirement in the period in which the obligations are incurred. When the liability is initially recorded, the Company capitalizes the costs of the assets retirement obligation by increasing the carrying amount of related long-lived assets.

Over time, the liability is accreted to its present value each period, and the capitalized cost is depreciated over the useful life of the related asset.

The Company has determined it does not have a material legal obligation to remove long-lived assets, and accordingly, there have been no liabilities recorded for the years ended December 31, 2018 or 2017.

***Intangible Assets***

Intangible assets are being amortized on the straight-line basis over periods ranging from 5 to 10 years. Such assets are periodically evaluated as to the recoverability of their carrying values.

***Income Taxes***

The Company's stockholders have elected to have the Company's income taxed as an "S" Corporation under provisions of the Internal Revenue Code and a similar section of the Kansas income tax law. Therefore, taxable income or loss is reported to the individual stockholders for inclusion in their respective tax returns and no provision for federal and state income taxes is included in these statements.

***Revenue Recognition***

The Company recognizes revenues when earned regardless of the period in which the customer is billed. The Company is required to provide service to subscribers within its defined service territory. Internet revenues are recognized over the period a subscriber is connected to the network.

***Stock Option Plan***

[REDACTED]

***Taxes Collected from Customers and Remitted to Governmental Authorities***

Taxes collected from customers and remitted to governmental authorities are presented in the accompanying consolidated statement of income on a net basis.

**Mercury Wireless, Inc. & Subsidiaries**  
**Notes to the Consolidated Financial Statements**  
**December 31, 2018 and 2017**

***Reclassifications***

Certain reclassifications have been made to the 2017 consolidated financial statements to conform to the 2018 consolidated financial statement presentation. These reclassifications had no effect on net earnings.

**Note 2: Common Control Transaction**



	<i>/201</i>	



**Mercury Wireless, Inc. & Subsidiaries**  
**Notes to the Consolidated Financial Statements**  
**December 31, 2018 and 2017**

**Note 3: Property, Plant and Equipment**

Property, plant and equipment includes the following as of December 31, 2018 and 2017:

	2018	2017
[REDACTED]	[REDACTED]	[REDACTED]
[REDACTED]	[REDACTED]	[REDACTED]
[REDACTED]	[REDACTED]	[REDACTED]
[REDACTED]	[REDACTED]	[REDACTED]
[REDACTED]	[REDACTED]	[REDACTED]
[REDACTED]	[REDACTED]	[REDACTED]
[REDACTED]	[REDACTED]	[REDACTED]
[REDACTED]	[REDACTED]	[REDACTED]
[REDACTED]	[REDACTED]	[REDACTED]
[REDACTED]	[REDACTED]	[REDACTED]

**Note 4: Intangible Assets and Goodwill**

The carrying basis and accumulated amortization of recognized intangible assets at December 31, 2018 and 2017, were:

	2018		2017	
	Gross Carrying Amount	Accumulated Amortization	Gross Carrying Amount	Accumulated Amortization
[REDACTED]	[REDACTED]	[REDACTED]	[REDACTED]	[REDACTED]
[REDACTED]	[REDACTED]	[REDACTED]	[REDACTED]	[REDACTED]
[REDACTED]	[REDACTED]	[REDACTED]	[REDACTED]	[REDACTED]
[REDACTED]	[REDACTED]	[REDACTED]	[REDACTED]	[REDACTED]
[REDACTED]	[REDACTED]	[REDACTED]	[REDACTED]	[REDACTED]
[REDACTED]	[REDACTED]	[REDACTED]	[REDACTED]	[REDACTED]
[REDACTED]	[REDACTED]	[REDACTED]	[REDACTED]	[REDACTED]
[REDACTED]	[REDACTED]	[REDACTED]	[REDACTED]	[REDACTED]
[REDACTED]	[REDACTED]	[REDACTED]	[REDACTED]	[REDACTED]

[REDACTED]

**Mercury Wireless, Inc. & Subsidiaries**  
**Notes to the Consolidated Financial Statements**  
**December 31, 2018 and 2017**

Estimated intangibles and goodwill amortization expense for each of the following five years and thereafter is:

<div style="background-color: black; width: 100px; height: 100px; margin: 0 auto;"></div>	<table style="margin: 0 auto;"> <tr> <td style="border-bottom: 1px solid black; width: 50px; height: 20px;"></td> <td style="border-bottom: 1px solid black; width: 50px; height: 20px;"></td> </tr> <tr> <td style="border-bottom: 1px solid black; width: 50px; height: 20px;"></td> <td style="border-bottom: 1px solid black; width: 50px; height: 20px;"></td> </tr> </table>				

**Note 5: Long-Term Debt**

Long-term debt as of December 31, 2018 and 2017 consists of the following:

	2018	2017
<div style="background-color: black; width: 100%; height: 150px; margin-bottom: 10px;"></div> <div style="background-color: black; width: 100%; height: 20px;"></div>	<div style="background-color: black; width: 100%; height: 150px; margin-bottom: 10px;"></div> <div style="border-top: 1px solid black; background-color: black; width: 100%; height: 20px;"></div> <div style="border-top: 1px solid black; background-color: black; width: 100%; height: 20px;"></div>	<div style="background-color: black; width: 100%; height: 150px; margin-bottom: 10px;"></div> <div style="border-top: 1px solid black; background-color: black; width: 100%; height: 20px;"></div> <div style="border-top: 1px solid black; background-color: black; width: 100%; height: 20px;"></div>
<ul style="list-style-type: none"> <li style="margin-bottom: 10px;">■ <span style="background-color: black; display: inline-block; width: 80%; height: 1.2em; vertical-align: middle;"></span></li> <li>■ <span style="background-color: black; display: inline-block; width: 80%; height: 1.2em; vertical-align: middle;"></span></li> </ul>		

# Mercury Wireless, Inc. & Subsidiaries

## Notes to the Consolidated Financial Statements

December 31, 2018 and 2017

- [REDACTED]
- [REDACTED]
- [REDACTED]
- [REDACTED]
- [REDACTED]
- [REDACTED]
- [REDACTED]
- [REDACTED]
- [REDACTED]

**Mercury Wireless, Inc. & Subsidiaries**  
**Notes to the Consolidated Financial Statements**  
**December 31, 2018 and 2017**

Aggregate annual maturities of long-term debt at December 31, 2018 are:

[REDACTED]	[REDACTED]
	<u>[REDACTED]</u>
	<u>[REDACTED]</u>

**Note 6: Operating Leases**

[REDACTED]	[REDACTED]
	<u>[REDACTED]</u>
	<u>[REDACTED]</u>

/201

[REDACTED]	[REDACTED]
	<u>[REDACTED]</u>
	<u>[REDACTED]</u>

# Mercury Wireless, Inc. & Subsidiaries

## Notes to the Consolidated Financial Statements

December 31, 2018 and 2017

### Note 8: Stock Option Plan

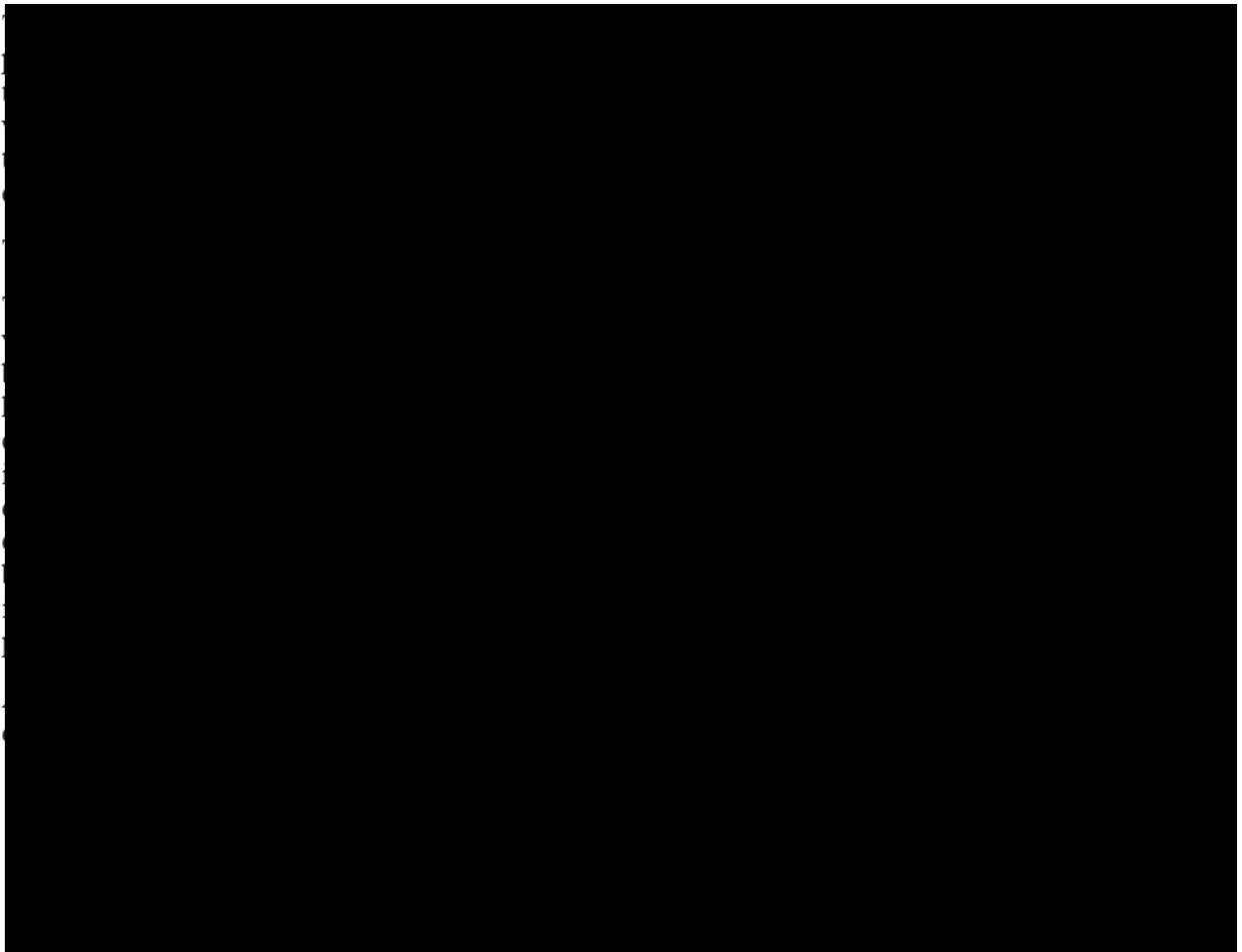



**Mercury Wireless, Inc. & Subsidiaries**  
**Notes to the Consolidated Financial Statements**  
**December 31, 2018 and 2017**

**Note 9: Federal Funding**

During 2018, the Company successfully bid to receive funding through the Federal Communications Commission's Connect America Fund Phase II ("CAF II") auction. The auction allocated funds to distribute over a ten year period to expand rural broadband services in unserved areas in 45 states as part of an effort to close the digital divide in rural America. Providers must build out up to 40 percent of the assigned homes and businesses in a state within three years of becoming authorized to receive support. Buildout must increase by 20 percent in each subsequent year, until complete buildout is reached at the end of the sixth year.

The Company successfully bid and was awarded funding of \$4,610,330 to buildout broadband services in five states: Kansas, Missouri, Indiana, Michigan and Ohio. No funds were distributed to the Company in 2018; funds are expected to be distributed over the next ten years. During 2018, the Company recorded [REDACTED] of expenses related to obtaining the funding of grant funds.

**Note 10: Related Party Transactions**

[REDACTED]

**Note 11: Future Change in Accounting Principle**

The Financial Accounting Standards Board amended its standard related to the accounting for leases. Under the new standard, lessees will now be required to recognize substantially all leases on the balance sheet as both a right-of-use asset and a liability. The standard has two types of leases for income statement recognition purposes: operating leases and finance leases. Operating leases will result in the recognition of a single lease expense on a straight-line basis over the lease term similar to the treatment for operating leases under existing standards. Finance leases will result in an accelerated expense similar to the accounting for capital leases under existing standards. The determination of lease classification as operating or finance will be done in a manner similar to existing standards. The new standard also contains amended guidance regarding the identification of embedded leases in service contracts and the identification of lease and nonlease components in an arrangement. The new standard is effective for annual periods beginning after December 15, 2019, and any interim periods within annual reporting periods that begin after December 15, 2020. The Company is evaluating the impact the standard will have on the consolidated financial statements; however, the standard is expected to have a material impact on the consolidated financial statements due to the recognition of additional assets and liabilities for operating leases.

**Note 12: Subsequent Events**

Subsequent events have been evaluated through February \_\_\_, 2019, which is the date the consolidated financial statements were available to be issued.



## **Attachment 8 | Evidence of Network Scalability**

### **Middle Mile Architecture and Technologies (Backhaul/Transport)**

Mercury Wireless will use a combination of microwave and fiberoptic backhaul between sites serving access to the customer premises and interconnecting its datacenters. The Company has selected [REDACTED] as its primary microwave backhaul vendor for licensed links. Mercury will use the [REDACTED] to provide transport between macro sites and its small cell sites.

Mercury Wireless will partner with existing vendors to provide fiber optic transport between its access sites and data centers. These links will be strategically located at key sites and driven primarily by network utilization.

[REDACTED]

[REDACTED]

[REDACTED]

[REDACTED]

**Last Mile Architecture and Technologies (Access)**

Mercury Wireless will deploy a fixed wireless LTE network for last mile network access. The Company has selected [REDACTED] as its primary eNodeB vendor.

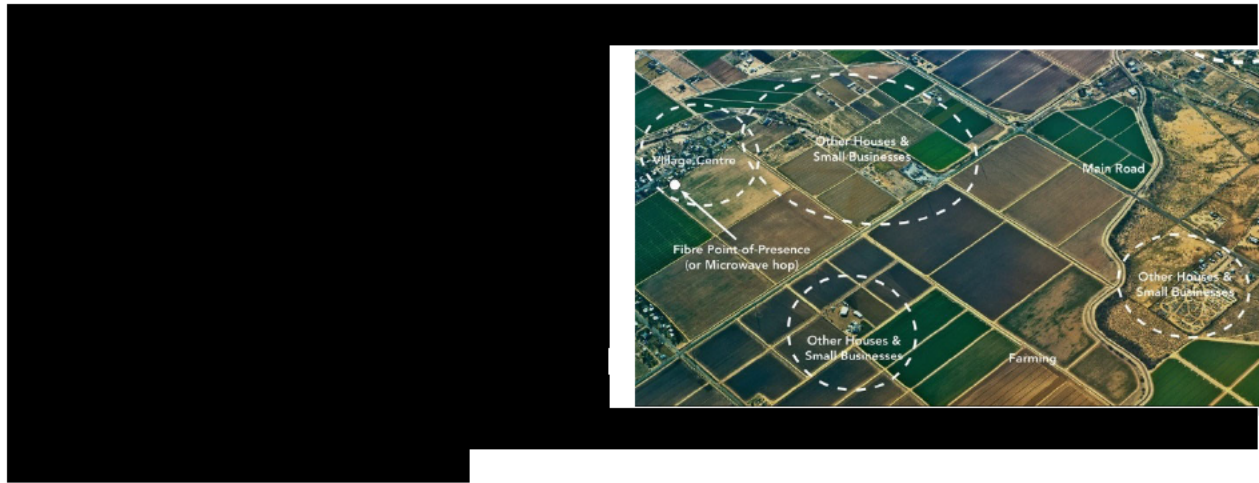





**Network Scalability**

Mercury Wireless will maintain service levels of 100 Mbps x 20 Mbps with latency no more than 100ms. Monitoring service levels will be a critical component of the company's deployment strategy. The Company will install devices at the customer premises to monitor the bandwidth availability during peak times. The devices will test back to the Company's core infrastructure as well as any sites the Michigan Department of Technology, Management, and Budget establishes as official test sites. The tests will be initiated throughout peak network usage periods.

As the network continues to grow and subscriber demand continues to increase the Company will

Mercury Wireless' network is designed to ensure forward compatibility with 5G technologies to provide future throughput improvements to the network. Some key characteristics of 5G networks include:

- More capacity per device with connections estimated to exceed 1Gbps
- Support for more simultaneous device connections
- Higher capacity density

**Network Reliability (Availability)**

Mercury Wireless has designed the network to provide at least 99.99% availability to its subscribers.

Field Operations will be responsible for on-site troubleshooting and maintenance, and are available 24 hours a day, 365 days a year to respond to network issues and outages. As part of the Company's expansion efforts, Mercury Wireless intends to establish satellite offices in key locations to manage infrastructure and service subscribers locally.



**Spectrum Access**

Mercury Wireless will utilize spectrum from multiple bands to complete its buildout.

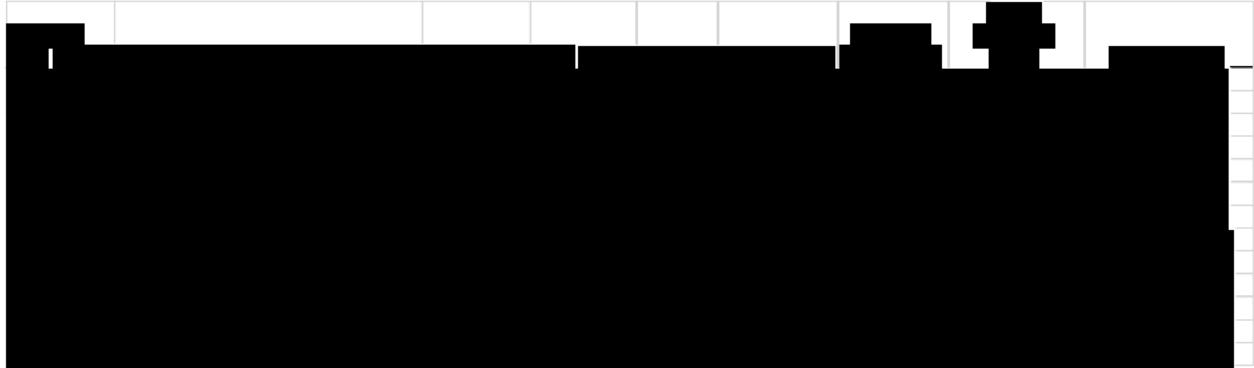

- [Redacted bullet point]

[Redacted paragraph of text]

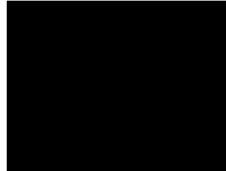

---

Michigan Department of Technology, Management, and Budget  
Center for Shared Solutions  
111 South Capitol Ave  
Lansing, Michigan 48933

To Whom It May Concern:

This letter is to certify that the  product line proposed to be used in Mercury Wireless' "Mercury Connects" project in partnership with the Indiana Office of Community & Rural Affairs Next Level Connections program is capable of delivering 100 mbps x 20 mbps connectivity to connected subscribers.

Regards,



COO









**Attachment 10 | Affidavit of Commitment**

**Proposed Service Levels and Pricing Details**

Mercury Wireless will utilize fixed wireless LTE technology to extend coverage to unserved communities for which it is requesting funding. The Company is proposing maximum information rate broadband Internet connection speeds up to 100 Mbps DL x 20 Mbps UL with sub 100 ms latency. Each package proposed will provide an unlimited data connection to every subscriber with no usage restrictions, throttling, or overage charges. Below is a summary of the package and pricing structure the Company proposes for general availability:

Download Speed (Mbps)	Upload Speed (Mbps)	Price	Monthly Data Allowance (Gb)
10 Mbps	2 Mbps		Unlimited
30 Mbps	6 Mbps		Unlimited
100 Mbps	20 Mbps		Unlimited

As part of the Company’s funding proposal, Mercury Wireless Indiana, LLC (‘Mercury Wireless’) is committing to providing the proposed service and pricing structure for a minimum of five years after project completion, scheduled tentatively for Q1 2021.

1. My title is President and Chief Executive Officer of Mercury Wireless Indiana, LLC. In this capacity I am in a position of authority to authorize the package and pricing structure outlined in this affidavit.
2. By this affidavit, I certify that Mercury Wireless Indiana, LLC. is committing to providing the package and pricing structure outlined in this affidavit for a period of no less than 5 years after the project completion date.
3. I certify that this document and its contents are accurate to the best of knowledge.

FURTHER AFFIANT SAYETH NAUGHT

Signature

Garrett R. Wiseman  
President & CEO  
Mercury Wireless Indiana, LLC.  
6004 Highview Drive, STE B  
Fort Wayne, IN 46818

**Attachment 11**  
**Mercury Connects | Calhoun - Budgetary Engineering Designs, Diagrams, and Maps of Proposed Project**

**CONFIDENTIAL INFORMATION**

The information in this document is confidential and is intended for person to whom it is addressed. This information should not be disclosed to any other person. It may not be reproduced in whole, or in part, nor may any of the information contained therein be disclosed without the prior consent of the directors of Mercury Wireless, Inc. ('Mercury'). A recipient may not solicit, directly or indirectly (whether through an agent or otherwise the participation of another institution or person) without the prior approval of the directors of Mercury. Any form of reproduction, dissemination, copying, disclosure, modification, distribution and or publication of this material is strictly prohibited.

**ADDITIONAL INFORMATION**

All communications or inquiries relating to these materials should be directed to:

Garrett R. Wiseman  
Chief Executive Officer  
Office: (800) 354-4915

[garrett.wiseman@mercurywireless.com](mailto:garrett.wiseman@mercurywireless.com)

Matthew Sams  
Chief of Staff  
Office (800) 354-4915 x504

[matthew.sams@mercurywireless.com](mailto:matthew.sams@mercurywireless.com)





Mercury Wireless Indiana, LLC  
6004 Highview Drive, Suite B  
Fort Wayne, IN 46818

PE Certification Letter

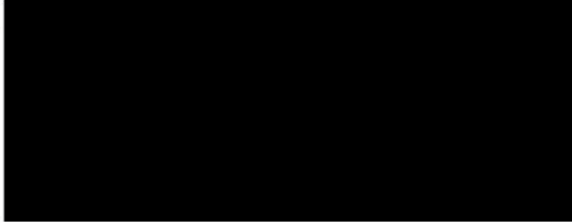

SEAL & SIGNATURE: \_\_\_\_\_

08/13/2019

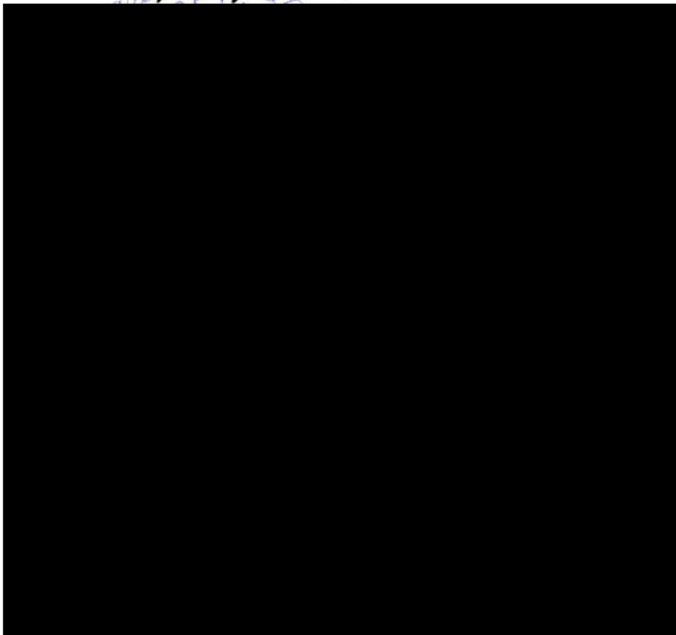





**Table of Contents**

Introduction..... Page 04

Summary ..... Page 05

Mapping of Proposed Service Area ..... Page 06

Middle Mile Architecture and Technologies (Backhaul/Transport)..... Page 08

Last Mile Architecture and Technologies (Access)..... Page 09

Customer Premises Equipment ..... Page 10

Voice Services ..... Page 11

Scalability & Availability ..... Page 12

Spectrum Access ..... Page 13

Engineering Assumptions ..... Page 14

RF Propagation Prediction Model ..... Page 15

About the Company ..... Page 16



## **Introduction**

- Mercury Wireless has successfully developed an operating model to provide rural Internet Service in Kansas and the company has now duplicated its success in Indiana proving the model is repeatable.
- Mercury has thoughtfully considered its expansion plan considering all business, technical and competitive implications.
- Mercury believes that the following plan will support the Connecting Michigan Communities (CMIC) Grant Program goal of promoting access to broadband service in all areas of the state, which is necessary for a highly functioning 21<sup>st</sup> century economy.

As part of the Company's funding proposal, Mercury will be extending and upgrading network access in Calhoun county Michigan. The following overview outlines the critical components of the Company's deployment strategy and how it will meet its obligations under the CMIC Grant Program including deployment locations, coverage, and bandwidth requirements.

The purpose of this plan is to establish an understanding of the company and outline the technical and operational plans being implemented to complete its objectives. This document will serve as a roadmap for the Company's ongoing deployment.

## **About the Company**

Mercury Wireless provides Internet access to rural communities beyond the reach of fiber networks by extending fiber with wireless LTE technology.

Mercury Wireless was founded in Topeka, KS in September of 2007 after recognizing a need for Broadband Internet access in rural America and seeing a lack of viable options. A hybrid approach to serve these "last-mile" customers was developed by extending high capacity fiberoptic networks with the range, reliability, and flexibility of carrier class wireless technologies. The Company connected its first subscriber December of 2007.

Since its inception, Mercury has continued to expand its network coverage and increase the services available to its subscribers. Today the Company provides Internet access and voice services in Indiana and Kansas. The CMIC Grant Program will enable the Company to continue expanding its network coverage reaching more unserved and underserved markets in Michigan.



## Summary

The Company will utilize fixed wireless LTE technology to extend coverage to unserved communities in Calhoun county. The network will be forward compatible with 5G technology allowing the Company to continue to scale the network with additional technological advances on the horizon. Mercury will leverage existing network resources where possible enabling it to accelerate its time to market.

Mercury will utilize multiple spectrum bands including [REDACTED]. Spectrum availability and market demands will be assessed on a market by market basis. The Company will take appropriate action to ensure an adequate amount of spectrum is available for it to meet its requirements under CMIC Grant Program.

Maintaining the bandwidth and latency requirements under the CMIC Grant Program will be a critical factor in this deployment. Bandwidth and latency will be measured to the customer premises on an ongoing basis using standard network protocols. The Company will utilize [REDACTED]

The Company will use a combination of microwave and fiberoptic middle mile backhaul between sites serving access to the customer premises and its datacenters. Fiberoptic backhaul will be used to interconnect key sites and provide transport to Mercury's datacenters.

The Company intends to collocate on existing sites owned and operated by its telecommunication real estate partners. The Company believes that sufficient infrastructure already exists for it to utilize. In the event that infrastructure at a given location is deemed inadequate, the Company will work with the local community to utilize existing infrastructure from small sites or erecting new sites to meet its specific needs.

## Mercury Connects | Calhoun

Mercury Wireless is applying for funding to provide service to 396 unserved locations in Michigan under the CMIC Grant Program. Eligible service areas identified in the census block map below include census blocks without at least (1) provider providing broadband service within the census block, or a delineated area within a census block without at least (1) provider providing broadband service. Census block locations for this project either partially or wholly underserved are in Calhoun county. Mercury Wireless will provide service levels up to 100 Mbps x 20 Mbps with less than 100ms latency in all unserved areas identified in this project.

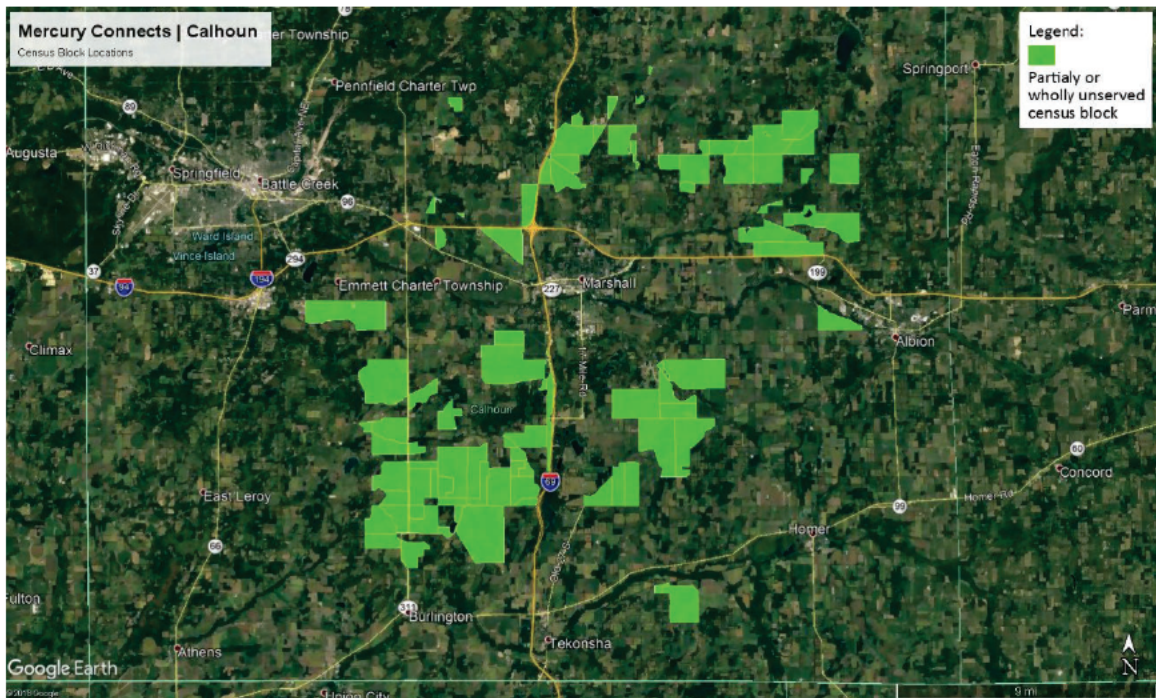

*The above map shows census blocks in green where the Company is requesting funding. A .kml and .xls attachment has been included with our funding application to provide further detail.*

Mercury Wireless will buildout [REDACTED] sites across Calhoun county to cover the 421 unserved locations, and the surrounding communities. These access site locations also impact more than 1249 housing units, and 23 businesses and community anchor institutions.

Each of Mercury's access sites will be capable of delivering up to [REDACTED] through its access layer servicing last mile connections. The [REDACTED] addition to Mercury's network segments will be capable of supporting a total of [REDACTED]. Assuming a take rate of [REDACTED], an oversubscription ratio of [REDACTED] and an average subscription rate of [REDACTED]s, the network has been engineered to support [REDACTED] locations in its initial deployment.

Each access site will be interconnected with an upgradable wireless backhaul capable of supporting at least [REDACTED] during the initial project deployment. This will be accomplished utilizing either licensed or unlicensed spectrum. Access sites are strategically located to service the census blocks identified in this application and provide wireless coverage availability to all areas.



*The above map demonstrates site locations and back-haul links in relation to the underserved census blocks.*



*The above map demonstrates site locations and wireless propagation studies performed.*



**Middle Mile Architecture and Technologies (Backhaul/Transport)**

Mercury Wireless will use a combination of microwave and fiberoptic backhaul between sites serving access to the customer premises and interconnecting its datacenters. The Company has selected [REDACTED] as its primary microwave backhaul vendor for licensed links. Mercury will use the [REDACTED] to provide transport between macro sites and its small cell sites.

Mercury Wireless will partner with existing vendors to provide fiber optic transport between its access sites and data centers. These links will be strategically located at key sites and driven primarily by network utilization. Proposed key site locations are demonstrated in the previous section.

[REDACTED]

[REDACTED]

[REDACTED]

[REDACTED]

### Last Mile Architecture and Technologies (Access)

Mercury Wireless will deploy a fixed wireless LTE network for last mile network access. The Company has selected [REDACTED] as its primary eNodeB vendor.



### Customer Premises Equipment

Mercury Wireless will source customer premises equipment from [REDACTED]. The Company will use a combination of Category [REDACTED] and Category [REDACTED] UE (user equipment). The UE will be capable of delivering 100 Mbps x 20 Mbps to the subscriber's home. The UE will be an outdoor design and professionally installed by Mercury's Field Services Team.



### **Broadband Installation**

The customer premises equipment will be installed in the following manner:

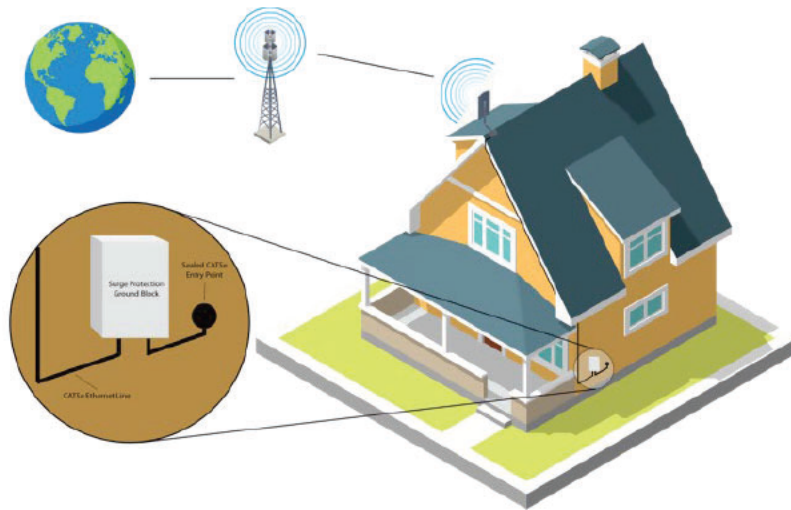

All subscribers will be installed by a Mercury Wireless Field Services Technician. An outdoor LTE UE will be mounted to the outside of the subscriber's home and aligned with a nearby Subscriber Access Site. CAT5e cable will be run from the UE to a ground block/surge protector located on the outside of the subscriber's home near the common ground for the house. A second CAT5e cable will be run from the ground block to a POE (power over ethernet) device. The POE will be capable of powering the UE over the CAT5e cable

eliminating the need for a separate power cable.

From the POE, a third CAT5e cable will be connected to the subscriber's router. The WiFi router will be capable of communicating with all subscriber peripheral including computers, tablets, smart tv's, etc. Mercury Wireless will provide the subscriber with a WiFi router as part of its standard installation. The Company will retain ownership of the WiFi router, the UE, and the power supply and will continue to provide support and maintenance for these devices as needed.

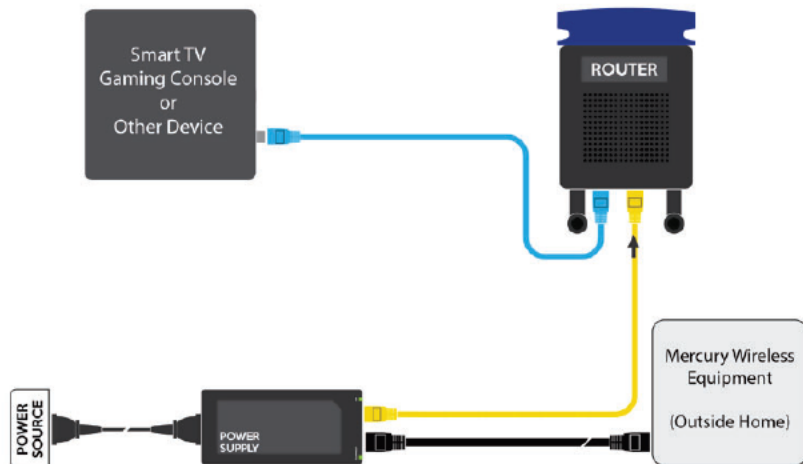



## Voice Services Installation

Mercury Wireless will provide voice services to its subscribers using VoIP (voice over Internet protocol). The company will provide local and long distance calling as well as services such as digital voicemail, caller id and 3 way calling. Mercury will also provide access to 911 emergency services through E911.

The voice service equipment will be installed in the following manner:



All voice service equipment will be installed by a Mercury Wireless Field Services Technician.

From the POE a CAT5e cable will be connected to a VoIP ATA (analog telephone adapter). The ATA is capable of connected traditional analog

telephones with Mercury's VoIP service. The ATA will connect to the subscriber's existing home phones using a traditional CAT3 cable. The ATA will then be connected via a CAT5e cable to the subscriber's router. The WiFi router will be capable of communicating with all subscriber peripheral including computers, tablets, smart tv's, etc. Mercury Wireless will provide the subscriber with a WiFi router as part of its standard installation. The Company will retain ownership of the WiFi router, ATA, and the power supply and will continue to provide support and maintenance

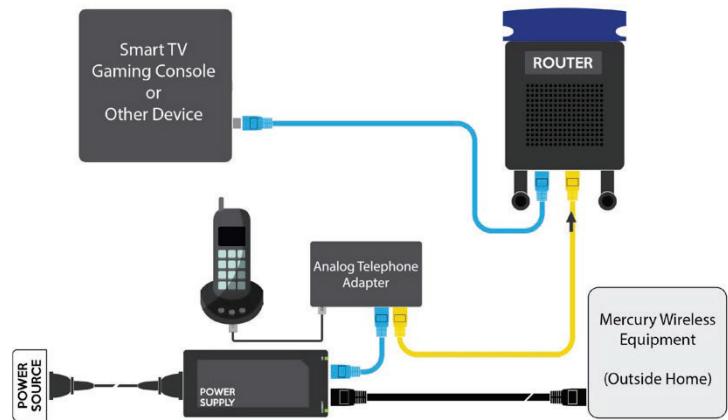



**Network Scalability**

Mercury Wireless will maintain service levels of 100 Mbps x 20 Mbps with latency no more than 100ms. Monitoring service levels will be a critical component of the company's deployment strategy. The Company will install devices at the customer premises to monitor the bandwidth availability during peak times. The devices will test back to the Company's core infrastructure as well as any sites the Michigan Department of Technology, Management, and Budget establishes as official test sites. The tests will be initiated throughout peak network usage periods.

As the network continues to grow and subscriber demand continues to increase the Company will

**Network Reliability (Availability)**

Mercury Wireless has designed the network to provide at least 99.99% availability to its subscribers.

Field Operations will be responsible for on-site troubleshooting and maintenance, and are available 24 hours a day, 365 days a year to respond to network issues and outages.

**Spectrum Access**

Mercury Wireless will utilize spectrum from multiple bands to complete its buildout.

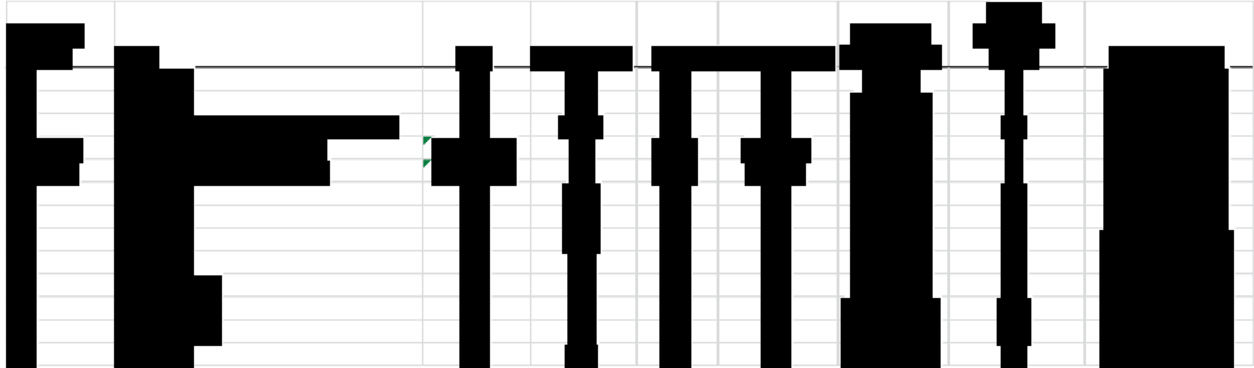

- [Redacted]

[Redacted]



## **Engineering Assumptions**

Certain engineering assumptions have been made throughout the initial phase of planning for the CMIC Grant Program. Those assumptions are outlined in this section.

### **Propagation Model**

The propagation model used for the CMIC initiative was Longley-Rice. Additional information on the Longley-Rice model is detailed in the RF Propagation Prediction Model Section of this document.

### **Topographical Data**

Topographical data has been sourced from publicly available data from the NASA SRTM (shuttle radar topography mission) program. The topographical data used in the analysis is 1/3 arc-second (10 meter) resolution.

### **Landcover Data**

Landcover data has been sourced from the USGS Seamless Data Distribution System. The landcover data used in the analysis was 3 arc-second (100 meter) resolution.

### **Access to Tower Sites & Infrastructure**

Mercury Wireless will leverage its existing relationships with real estate partners for access and transport sites. Upon project funding approval a full structural analysis will need to be completed on each site the Company will attach equipment too. These structural analyses are typically performed by our real estate partners, in addition to the necessary permitting requirements in each respective jurisdiction. The Company has selected strategic site locations from these real estate partners based on tentative site availability for collocation and existing contracts in place to execute site agreements. The Company intends to utilize the existing electric infrastructure as part of its agreement with real estate partners. When this option is not available, the Company will work with local utility companies and municipalities to terminate power and coordinate for the necessary permitting requirements for each jurisdiction.

Updates may be made to access site locations as the Company completes the build, maintaining that the Company completes its requirements under the CMIC Grant Program. The Company will coordinate with the Michigan Department of Technology, Management, and Budget to ensure any changes to its deployment strategy satisfy the requirements of the grant program obligations prior to execution.

### **Oversubscription Rate**

Mercury Wireless has engineered the network assuming an oversubscription rate of [REDACTED].

### **Service Level Subscription**

Mercury Wireless has engineered the network assuming a maximum service level subscription of 100 Mbps x 20 Mbps, and an average subscription level of [REDACTED] Mbps.

### **Latency**

The network has been engineered to provide service to subscribers with latency less than 100ms.

### **Subscriber Take Rate**

Mercury Wireless has engineered the network assuming a take rate of [REDACTED] %.

### **RF Propagation Prediction Model**

Mercury Wireless has used the Longley-Rice model to complete its propagation analysis for the CMIC initiative. The Longley–Rice model is a radio propagation model: a method for predicting the attenuation of radio signals for a telecommunication link in the frequency range of 20 MHz to 20 GHz. Longley-Rice is also known as the irregular terrain model (ITM).

The Longley–Rice model was proposed for frequencies between 20 MHz and 20 GHz for different scenarios and different heights of transmitting and receiving antennas. The model presents a generalization of the received signal power without a detailed characterization of the channel. This model uses statistical resources to compensate for the characterization of the channel, which depends on the variables of each scenario and environment.

The variation of the signal is determined by the prediction model according to the atmospheric changes, topographic profile and free space. These variations are described with the help of statistical estimates which have deviations that contribute to the total attenuation of the signal. The statistical estimates or attenuation variables of this prediction model are I) Situation variability; II) Time variability; III) Location variability. The reference attenuation is determined as a function of the distance, attenuation variables and an urban factor for an area or point-to-point.

Because of this variability, there could be deviations more or less significant to the attenuation of the transmitted signal. The received signal is obtained signal level attenuated in free space attenuated by the sum of the attenuation formed by random variables. If transmitter and receiver are at known points, the location variable has a value of zero.

The reference attenuation defined as a function of distance also features 3 ranges for prediction: I) Line-of-sight; II) Diffraction; III) Scatter. For each of these ranges, there are attenuation coefficients defined according to link geometry. These variables also consider the topography that is defined as terrain irregularity parameter  $\Delta h$  for a reference distance.



Mercury Wireless Indiana, LLC  
6004 Highview Drive, Suite B  
Fort Wayne, IN 46818

**Company Information**

Mercury Wireless Indiana is a limited liability company organized under the laws of the State of Indiana. The Company is currently headquartered at 6004 Highview Dr, Suite B, Fort Wayne, IN 46825 and the Company's telephone number is (800) 354-4915.



August 4, 2019

Michigan Department of Technology, Management, and Budget  
Center for Shared Solutions  
111 South Capitol Avenue  
Lansing, MI 48933

Re: Connecting Michigan Communities Grant

To Whom it May Concern,

I am pleased to support the application by Mercury Wireless for the DTMB Connecting Michigan Communities Grant Program, building upon their successful FCC Connect America Fund Phase II Auction.

I lead efforts at the University of Michigan School of Nursing to advance innovations in health research and clinical care to improve health and wellbeing among rural Michiganders. In May, my research center led a two-day workshop to devise novel interventions to improve access to high-quality care. Throughout the workshop, participants cited broadband access as the most pressing barrier to progress in advancing rural health care across Michigan.

In my conversations with Mercury Wireless leaders, their technology and their geographic target align well with our current partnerships with community and agricultural leaders. Increased high-speed, reliable broadband access in South West Michigan would greatly expand our efforts to test novel telehealth and monitoring solutions devised by our team.

In addition, several members of our team identified broadband access as an emerging social determinant of health. Within this framework, broadband access is a potential solution for long-standing inequities in health and social care among rural residents. Our interdisciplinary team would be interested in advancing some of our work in health literacy and numeracy in developing novel community outreach materials to stress the importance of broadband access for better health and novel teaching strategies to improve broadband literacy.

If awarded, we would look forward to continued discussions with Mercury Wireless to advance applications of their technology to improve health equity across rural Michigan. Thank you for your kind consideration.

Sincerely,

Christopher R. Friese, PhD, RN  
Elizabeth Tone Hosmer Professor  
Director, Center for Improving Patient and Population Health

## Attachment 13 | Demonstration of Customer Interest in Proposed Project Area

### Overview

Gathering evidence of community interest and support was critical to Mercury Wireless' determination of how to structure our proposed service area and details for our grant application. As part of our efforts to determine interest, Mercury Wireless constructed a questionnaire designed to gather feedback from residents, businesses, and community anchor institutions residing in the proposed service area. This questionnaire was posted on our web page, made available to the public, and distributed using targeted advertising campaigns over social media. Additionally, targeted E-mail communication was sent to residential, business, and community anchor institution E-mail addresses. Utilizing these communication methods potential respondents were directed to the questionnaire where they could voluntarily provide information as one method of demonstrating community support. A detailed description of the questionnaire, advertising campaign, and summary of the information can be found in the following sections.

### Questionnaire

The questionnaire was designed to obtain the necessary level of information from survey respondents while also respecting the privacy needs of those filling out the questionnaire. Utilizing several resources including information available at Melissadata.com, internally sourced contact information for community anchor institutions and stakeholder organizations, and targeted social media campaigns, potential respondents were provided with summary information about the project, a brief history of Mercury Wireless and its mission, and links to participate in the feedback initiative.



### Mercury Wireless | Customer Interest Form

Mercury Wireless is evaluating bringing unlimited 100 Mbps Internet to your community! Please answer some basic questions below so we can gauge your communities interest and help us determine where to build first.

Mercury Wireless provides fast, reliable, and unlimited Internet access to connect and empower the communities we serve! Mercury is committed to keeping your data private. More information can be found here: [Legal Policies](#)

Filling out this questionnaire does not commit you to service, it will be used to gauge interest only and help determine where to build first.

Are you interested in faster Internet service? \*

What is your service address? \*

This information will only be used to gauge interest for your area.



The pre-subscription questionnaire located at <https://www3.mercurywireless.com/pre-subscription/> contained 6 questions designed to determine several key pieces of information for residents in Michigan:

- Are you interested in faster Internet? – Designed to establish the basic desire for faster service in the project area.
- What is your service address? – Designed to capture the customer's physical address where they currently have or would be interested in obtaining telecommunications services.
- How fast is your current connection? – Designed to obtain evidence for underserved areas, as well as determining where service is available at different speeds available from a drop-down menu.
- Is this address a residence, business, or farm? – Designed to determine the type of address reported by the respondent, and also as evidence for underserved locations designated as businesses or farms.
- What services are you currently using? Select all that apply. – Designed to determine the types of services, if any, a respondent is currently subscribed to or has available.
- Would you like us to contact you when faster service is available? – Designed to determine not only the desire for faster service, but support from respondents who want to learn more when the Company deploys in the proposed area.

A targeted social media campaign through Facebook and Instagram was the main method of distribution chosen for collecting feedback. Supplemental feedback was obtained through direct E-mail campaigning efforts. The social media campaign advertised the availability of this form and invited residents to contribute voluntarily.

Advertisements were presented on mobile and desktop news feeds for Facebook and Instagram and were limited to a 10-mile radius encompassing all census blocks defined in the project summary. Aside from advertisements posting to accounts reporting an age of 18 years or older, there were no restrictions to age or demographics. Additionally, the invitation to provide feedback was distributed to businesses and community anchor institutions in the proposed service area through a direct E-mail campaign.

The questionnaire generated many responses for the proposed service area, which were then filtered to accommodate more specific information for the services currently available to residents. The information was then focused to evaluate which users within the proposed service area reported Internet availability at less than 10 Mbps.

## Summary of Results

Mercury Wireless is committed to the privacy of survey respondents. In this section we will provide a summary of the campaign, the key points demonstrated by feedback, and a demonstration showing the distribution of specific address locations reporting less than 10 Mbps broadband availability within the proposed service area. Several key pieces of information were determined after evaluating the feedback provided by Michigan residents. Key points to summarize from our findings are:

- There is a clearly demonstrated interest in the proposed service area. All respondents regardless of the information reported communicated the need for improved broadband service being made available in their community.

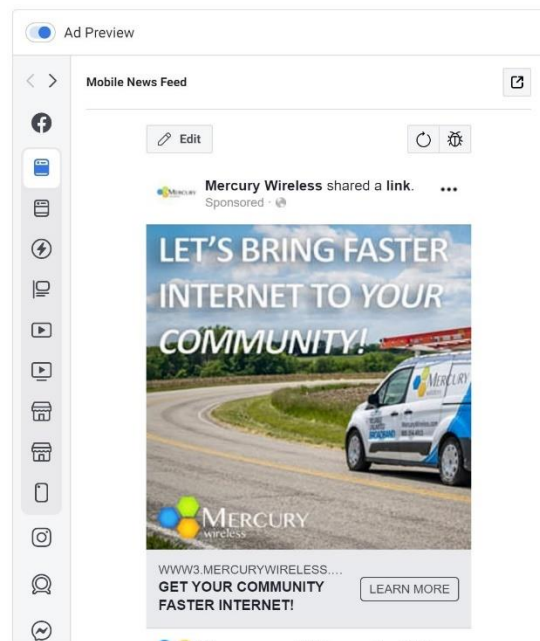

- The need for improved broadband services is strongest among rural residents. There was a strong indication that rural businesses and farms would also benefit from improved broadband coverage.
- The distribution of age ranges presented in the demographics summary below shows the largest portion of feedback coming from the senior community, or those reporting an age of 65+ years. These residents are most directly impacted by the lack of broadband availability, leaving them unable to take advantage of many telehealth and telemedicine services.



Below is a map representing the location of respondents in relation to the census blocks identified as either partially or wholly underserved for the project. Each respondent location is marked with a pink flag. Location data shown on the map below represents only users reporting less than 10 Mbps Internet available at their location.

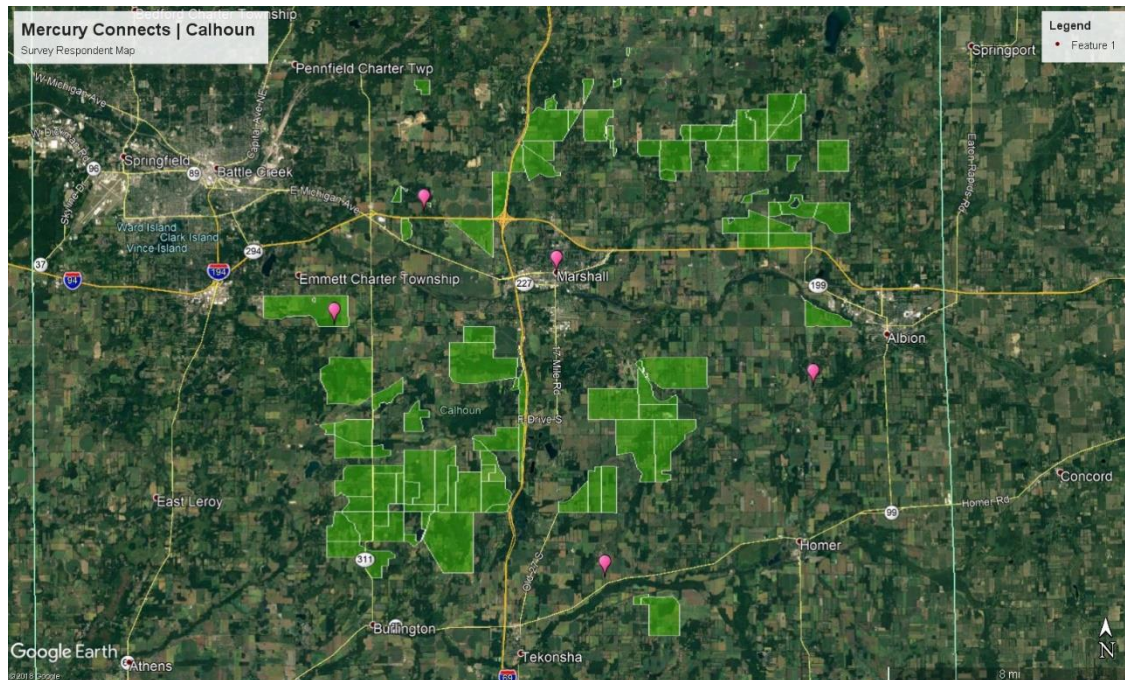

Through direct communication with Michigan residents, survey feedback, and social media, there is clearly demonstrated support for our proposed project across the proposed service area. We hope that in the spirit of conquering the digital divide, the Department of Technology, Management, and Budget will thoughtfully consider this evidence of community support to inform its funding and award decisions.

## **Attachment 14 | Statements of Impact from Community Anchor Institutions**

In sparsely populated rural areas, community anchor institutions (CIAs) are a critical component to connecting residents with their local community and government, businesses and external markets, and the rest of the world. Since copper and fiber infrastructure is prohibitively expensive to build out into rural areas, these institutions often have a difficult time obtaining high-speed broadband connections at affordable rates. Some CIAs benefit from government subsidy programs like USAC's E-rate program however, these options are not available for many institutions putting them at an even greater disadvantage. As the broadband needs of our CIAs continue to grow with the needs of the public, an economic solution is needed to service these last-mile facilities.

### **Broadbands Impact on Schools and Libraries**

It is estimated that rural schools are up to four times less likely to have access to a fiber connection. Additionally, rural schools are more likely to have slower connections and less competition to challenge broadband growth in the area. Broadband networks provide teachers and students access to several resources including web-based curriculum, video, photo, music, and online lessons. This allows traditional and non-traditional students to participate in distance learning opportunities from any location that has a broadband connection. As more curriculum migrates to the cloud and schools continue to use technology as a teaching tool, the bandwidth needs of schools will continue to increase into the foreseeable future.

Nearly half of all public libraries are in rural areas and face similar challenges with the lack of an affordable broadband solution. Rural libraries are a trusted public institution and are often resources heavily utilized by residents. Libraries can serve as both a resource center and often the only method of broadband connectivity in underserved areas. You can frequently observe people in parking lots after hours utilizing faster Wi-Fi connections provided by libraries to file paperwork, check in with friends and relatives, or participate in distance learning opportunities. They can also serve as social meeting places for community organizations or government entities. Connecting these libraries to broadband services helps low-income households gain access to critical services in addition to providing a valuable public service to our underserved communities. Providing these connections to rural residents, educational institutions, and libraries eliminates the distance barriers presented to rural educational systems.

### **Broadbands Impact on Public Safety and Health Care**

The availability of a broadband connection is increasingly important to the interoperability of police, fire, health, and crisis response entities that protect the public from every day and critical situations. Such connections improve the responsiveness of our public safety agents by increasing rapid communication during disasters, promoting communication with early warning systems, providing connections for remote security monitoring, and communication network backup systems. Often these critical communications and backup systems need to move large amounts of data rapidly to preserve effectiveness when deployed. Wireless access helps to close the cost gap for extending broadband services and helps deployments in hard to reach rural areas with little to no broadband infrastructure.

Over the past decade, many rural communities have seen a trend of smaller hospitals and closing. Rural hospital closures are estimated to increase further in the coming years. Immediate care facilities and private practices have helped to fill the void created by this deficiency in our health care system however, these options aren't available to all areas or individuals in remote locations. Distance and travel to these facilities can often be a barrier for citizens seeking access to health care, especially for the elderly population with access to limited financial resources. Broadband access can provide residents the ability to utilize telemedicine and telehealth services. These services include but are not limited to; consultation, counseling, physical and occupational therapy, home health care, and disease monitoring and management. The ability for individuals to participate in one or several of these programs will be critical to the health and safety of our communities, especially those citizens who are challenged with distance being a critical factor in their ability to see a physician.

As part of this attachment, we have included an impact statement from the Center for Improving Patient and Population Health at the University of Michigan. Dr. Christopher Friese has provided Mercury With some insight into some of the rural health care challenges specifically faced by Michiganders. Such challenges include the long distances rural citizens must travel to simply have access to basic health care and the distribution of life saving medications. Access to physicians to obtain these prescriptions is also a unique challenge faced by all rural residents. Broadband access can help close the inequalities of access to affordable health care faced by rural citizens, particularly wireless networks and technologies that can be deployed to almost any location allowing ease of access to telehealth and telemedicine services.

### **Broadbands Impact on Community Participation and Government**

Broadband availability benefits government entities by promoting interaction with its citizens. Open communication, availability of information, and encouraging citizens to interact with their respective government entities help lower costs for these agencies to manage information while at the same time increasing transparency. This is achieved by access to online methods of communication with government entities, sharing of information critical to the public's ability to participate in its local government, and providing resources to citizens so they can make informed decisions about how their government is performing. This serves to create a more engaged public, improving operations, and lowering costs for government entities.

Broadband wireless access networks are the ideal solution for connecting CIAs to affordable broadband connections, and the network proposed as part of Mercury Wireless' project is designed to accomplish this task. Using scalable wireless technologies, and the latest advances in fixed-wireless LTE platforms Mercury Wireless can connect schools, libraries, churches, fire and police agencies, and health care entities to affordable and easily deployable broadband solutions.



August 4, 2019

Michigan Department of Technology, Management, and Budget  
Center for Shared Solutions  
111 South Capitol Avenue  
Lansing, MI 48933

Re: Connecting Michigan Communities Grant

To Whom it May Concern,

I am pleased to support the application by Mercury Wireless for the DTMB Connecting Michigan Communities Grant Program, building upon their successful FCC Connect America Fund Phase II Auction.

I lead efforts at the University of Michigan School of Nursing to advance innovations in health research and clinical care to improve health and wellbeing among rural Michiganders. In May, my research center led a two-day workshop to devise novel interventions to improve access to high-quality care. Throughout the workshop, participants cited broadband access as the most pressing barrier to progress in advancing rural health care across Michigan.

In my conversations with Mercury Wireless leaders, their technology and their geographic target align well with our current partnerships with community and agricultural leaders. Increased high-speed, reliable broadband access in South West Michigan would greatly expand our efforts to test novel telehealth and monitoring solutions devised by our team.

In addition, several members of our team identified broadband access as an emerging social determinant of health. Within this framework, broadband access is a potential solution for long-standing inequities in health and social care among rural residents. Our interdisciplinary team would be interested in advancing some of our work in health literacy and numeracy in developing novel community outreach materials to stress the importance of broadband access for better health and novel teaching strategies to improve broadband literacy.

If awarded, we would look forward to continued discussions with Mercury Wireless to advance applications of their technology to improve health equity across rural Michigan. Thank you for your kind consideration.

Sincerely,

Christopher R. Friese, PhD, RN  
Elizabeth Tone Hosmer Professor  
Director, Center for Improving Patient and Population Health



Mercury Wireless Indiana, LLC  
6004 Highview Drive, STE B  
Fort Wayne, IN 46818

## **Attachment 15 | Evidence of Application for a SPIN, USAC and E-rate Experience, Letters of Recommendation From E-rate Partners**

Mercury Wireless Indiana, LLC's SPIN number is 143051573. Through the USAC Schools and Libraries program the Company has partnered with numerous educational institutions to bring improved connectivity to the communities we serve. From the request for funding process to project completion, the Company has been successfully participating in the USAC E-rate program since 2012. Mercury has completed both small and large-scale deployments including; local area wired and wireless networks (internal connections and managed broadband services), district-wide digital phone system deployments, and long-range backhaul solutions for interconnecting larger district segments and deploying high-speed internet (data transmission services) across numerous districts.

It is estimated that rural schools are up to four times less likely to have access to a fiber connection. Additionally, rural schools are more likely to have slower connections and less competition to challenge broadband growth in the area. Broadband networks provide teachers and students access to several resources including web-based curriculum, video, photo, music, and online lessons. This allows traditional and non-traditional students to participate in distance learning opportunities from any location that has a broadband connection. As more curriculum migrates to the cloud and schools continue to use technology as a teaching tool, the bandwidth needs of schools will continue to increase into the foreseeable future.

Nearly half of all public libraries are in rural areas and face similar challenges with the lack of an affordable broadband solution. Rural libraries are a trusted public institution and are often resources heavily used by the public. Libraries can serve as both a resource center for rural residents and often the only method of broadband connectivity in underserved areas. You can frequently observe people in parking lots after hours utilizing the faster Wi-Fi connections provided by libraries to file paperwork, check in with friends and relatives, or participate in distance learning opportunities. They can also serve as social meeting places for community organizations or government entities. Connecting these libraries to broadband services helps low-income households gain access to critical services in addition to providing a valuable public service to our underserved communities.

Providing these connections to rural residents, educational institutions, and libraries eliminates the distance barriers presented to rural educational systems. The Company has successfully maintained its relationships with schools, libraries, and local communities while working to upgrade network infrastructure as the needs of our students and educators evolve. Included as part of this attachment for consideration by the DTMB and CMIC Grant Program are letters of support from several schools currently connected to our network. As rural communities are struggling to bridge the connectivity gap, Mercury recognizes the importance of providing this critical infrastructure to our communities while striving to be the most cost-effective and efficient solution.



Monday, August 5, 2019

To Whom It May Concern,

I am writing this letter as a recommendation for the services provided by Mercury Wireless. For the past seven years I have worked closely with Mercury Wireless utilizing the USAC E-rate program to assist us with numerous services including broadband Internet and digital phone service. Our districts experience with Mercury has been exemplary as they have always been curious, professional, and timely, making them a reliable partner to USD 

My first engagement was with Blake Wiseman who was instrumental in deploying critical communications services to the district and surrounding communities. Since then we have undertaken several projects with Mercury ranging from infrastructure upgrades, network improvements, and a district wide VoIP deployment. Mercury has consistently been responsive to the needs of the district, and prompt with any requests for assistance or support.

I would recommend that any educational institution partner with Mercury Wireless to deliver fast, reliable, and unlimited Internet and digital phone service to improve the lives of its students and educators.

Sincerely,



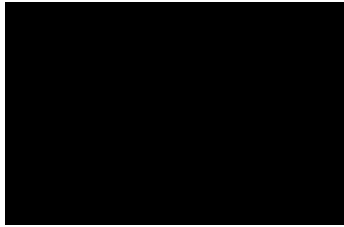

Monday, August 5, 2019

To Whom It May Concern,

I am writing this letter as a recommendation for the services provided by Mercury Wireless. For the past six years I have worked closely with Mercury Wireless utilizing the USAC E-rate program to assist us with numerous services including broadband Internet and digital phone service. Our districts experience with Mercury has been exemplary as they have always been professional, and timely, making them a reliable partner to USD 

My first engagement was with Blake Wiseman who was instrumental in deploying critical communications services to the district and surrounding communities. Since then we have undertaken several projects with Mercury ranging from infrastructure upgrades, network improvements, and most recently the deployment of a district wide VoIP system. Mercury has consistently been responsive to the needs of the district, and prompt with any requests for assistance or support.

I would recommend that any educational institution partner with Mercury Wireless to deliver fast, reliable, and unlimited Internet and digital phone service to improve the lives of its students and educators.

Sincerely,

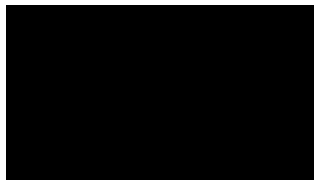



## **Attachment 16 | Statements of Impact for Business, Entrepreneurship, and Rural Economic Development**

Rural businesses face a different set of challenges than urban businesses. Isolation from population centers, difficulty hiring and retaining skilled workers, barriers to capital access, and inadequate broadband Internet service are just several of the unique scenarios business owners face. Entrepreneurs and small businesses represent enormous potential for stimulating economic growth in rural communities, and often a lack of access to fast and affordable broadband can dramatically impact a business's potential for success.

### **Broadbands Impact on Rural Business and Workers**

Rural small business owners are often leaders in the community. As key job creators, these businesses are critical to stimulating economic growth and development. As the access to broadband Internet improves, access to distance learning and continuing education also improves. A more educated workforce will help small businesses hire and retain skilled workers to develop a labor force capable of assisting economic development in the broader community.

Access to electronic services such as E-commerce also dramatically improves a businesses' ability to succeed when faced with the challenges of operating in a rural area. E-commerce represents a growing share of the economic market and broadband provides an opportunity to connect a business to this global market. In 2018 U.S. E-commerce sales grew to 15%, and an estimated 20% of the world's population purchase products or services online. Broadband Internet service empowers businesses to connect with potential buyers, access new markets, create additional revenue, stimulate job creation, and further boost the economic benefits of a business operating within its community.

Broadband also allows people who work from home more access to employment, allowing them to readily live and work in communities they choose without having the challenge of commuting to office locations. As more businesses open opportunities for their employees to work remotely, this can translate into substantial cost savings for the individual, more job opportunities, and higher income potential. Many businesses that can successfully employ residents in rural areas given they have access to a sufficient broadband connection. Call centers, data processing services, graphic arts, and IT work can often be accomplished remotely. Allowing an employee the freedom to operate from a home office is also environmentally responsible for a community, eliminating thousands of pounds of pollutants put into the environment.

### **Broadbands Impact on Entrepreneurship and Economic Development**

Rural development is increasingly linked to entrepreneurship. Starting a new business in a rural area can be a huge risk-taking decision. Concerns over access to skilled labor, capital, and customer markets are determining factors between starting a business in a rural versus urban location. Broadband connectivity helps to eliminate these barriers by providing businesses the ability to



Mercury Wireless Indiana, LLC  
6004 Highview Drive, STE B  
Fort Wayne, IN 46818

access and move large amounts of data in real-time. This allows the orchestration of people, strategies, and technologies to fit an ever-changing business environment.

Rural businesses are also defined in many ways that urban businesses are not. Farming and agriculture are just one example of an industry where rapidly changing technological advances require access to affordable broadband. The USDA estimates that 29% of U.S. farms have no Internet access. This is not only critical for day to day operations, but also the long-term viability and success of the farming community. Medical services need to move large amounts of data in real-time and require access to broadband services to manage patient information and customer records. Retail locations need broadband to process customer orders, financial transactions, and even customer support requests.

An educated workforce with access to employment, income, and resources supported by rural entrepreneurs can often be the catalyst to community revitalization. Encouraging and motivating entrepreneurs is important for supporting our workforce and in turn retaining skilled workers in our communities, increasing income potential for our residents, and keeping wages local. Investments in making affordable broadband access in these communities represent a foundational building block to enabling economic development. Without it the gaps of inequality will continue to grow. Included with this attachment is a letter of impact from the University of Michigan. As both public and private entities continue to focus on the education, health, and safety of our communities, strategic partnerships with community anchor institutions in both the public and private sectors will continue to be critical to improving the lives of Michiganders.



August 4, 2019

Michigan Department of Technology, Management, and Budget  
Center for Shared Solutions  
111 South Capitol Avenue  
Lansing, MI 48933

Re: Connecting Michigan Communities Grant

To Whom it May Concern,

I am pleased to support the application by Mercury Wireless for the DTMB Connecting Michigan Communities Grant Program, building upon their successful FCC Connect America Fund Phase II Auction.

I lead efforts at the University of Michigan School of Nursing to advance innovations in health research and clinical care to improve health and wellbeing among rural Michiganders. In May, my research center led a two-day workshop to devise novel interventions to improve access to high-quality care. Throughout the workshop, participants cited broadband access as the most pressing barrier to progress in advancing rural health care across Michigan.

In my conversations with Mercury Wireless leaders, their technology and their geographic target align well with our current partnerships with community and agricultural leaders. Increased high-speed, reliable broadband access in South West Michigan would greatly expand our efforts to test novel telehealth and monitoring solutions devised by our team.

In addition, several members of our team identified broadband access as an emerging social determinant of health. Within this framework, broadband access is a potential solution for long-standing inequities in health and social care among rural residents. Our interdisciplinary team would be interested in advancing some of our work in health literacy and numeracy in developing novel community outreach materials to stress the importance of broadband access for better health and novel teaching strategies to improve broadband literacy.

If awarded, we would look forward to continued discussions with Mercury Wireless to advance applications of their technology to improve health equity across rural Michigan. Thank you for your kind consideration.

Sincerely,

Christopher R. Friese, PhD, RN  
Elizabeth Tone Hosmer Professor  
Director, Center for Improving Patient and Population Health