

MICHIGAN STRUCTURE INVENTORY AND APPRAISAL CODING GUIDE

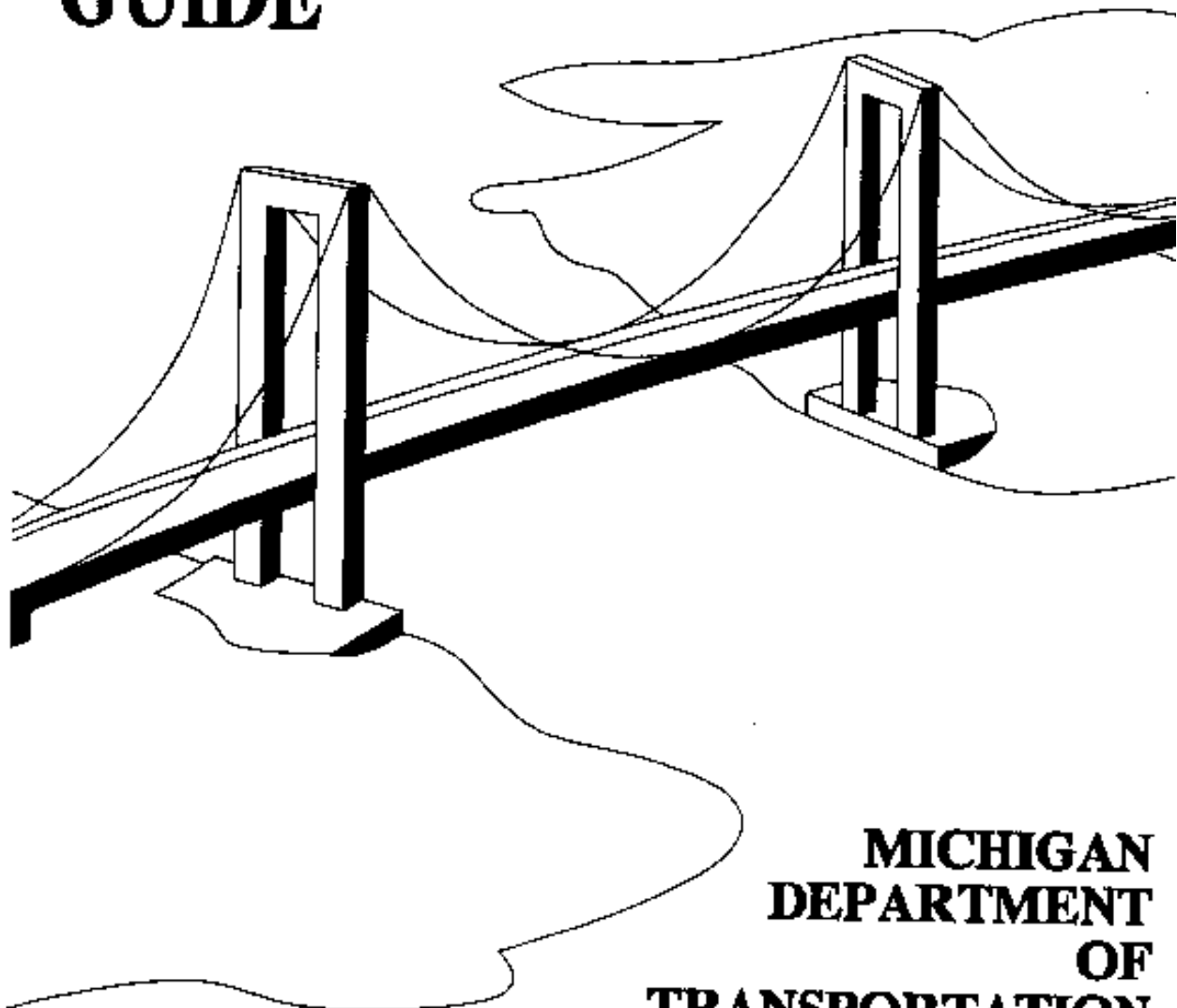

**MICHIGAN
DEPARTMENT
OF
TRANSPORTATION**

MICHIGAN DEPARTMENT OF TRANSPORTATION

MICHIGAN STRUCTURE INVENTORY
AND APPRAISAL CODING GUIDE

April 1, 2013

Prepared by the
Bridge Management Unit
MDOT Design Division

TABLE OF CONTENTS

	Page
Manual Revision History	i
Introduction	ii
Index of Inventory Items	1-3
Structure Inventory Procedures	4-5
Definition of Terms	6
Paper Form Requirements	7
Electronic, "Pontis" data submittal	8
Inventory Coding Item Descriptions	9-103

APPENDIX A Federal-Aid Highway Program Manual (:FHPM 6-7-2-1: National Bridge Inspection Standards)

APPENDIX B Sufficiency Rating Formula and Example
Bridge Safety Inspection Report (BSIR) Rating Definitions
References

MANUAL REVISION HISTORY

August 2009

- Revised general instructions to reflect current practice
- Revised items 60 and 113 as per FHWA memorandum
- Revised index and page numbering due to shortening of introductory section
- Revised items as per FHWA Errata Sheet 03/04
 - Deleted item 6B
 - Made minor text corrections on several items
 - Corrected Item 100
 - Changed allowable frequency for item 92C to 60 months

April 2013

- Revised items 31, 62, 63, 64f, 64MA,B&C,65 & 66 as per draft changes in MDOT Bridge Advisory 2012-01
- Revised contact information on page 4 for addition of new structures to the inventory
- Updated National Bridge Inspection Standards to most current (2012) version

INTRODUCTION

The following pages contain instructions for the Michigan Structure Inventory and Appraisal of Bridges (Coding Guide). This replaces the Coding Guide dated July, 2003. The old guide should be discarded.

The Coding Guide has been revised to reflect the conversion of Measurement based data Items back to the English method of measure.

Forms 1717A and 1717B have been replaced by new form 1717A.

Many of the inventory items previously reported on marked-up SI&A forms are now updated by the bridge owner in MBIS.

INDEX OF INVENTORY ITEMS

<u>Item</u>	<u>Page</u>	
Item 2 - Region		8
Item 3 - County		8
Item 4 - City Code		9
Item 5 - Inventory Route Over		9-11
Item 6 - Features Intersected		12
Item 7 - Facility Carried by Structure		12
Item 8 - Structure Identification		13-17
Item 9 - Location		18
Item 10 - Vert. Clearance Best 10 Feet		18-19
Item 11 - Milepoint		19
Item 12 - Base Highway Network		20
Item 13 - LRS Inventory Route, Subroute Number		20
Item 16 - Latitude		21
Item 17 - Longitude		21
Item 19 - Bypass, Detour Length		22-23
Item 20 - Toll		23
Item 21 - Maintenance Responsibility		24
Item 22 - Owner		24
Item 26 - Functional Classification of Inventory Route		25
Item 27 - Year Built		25
Item 28 - Lanes On and Under the Structure		26-27
Item 29 - Average Daily Traffic		27
Item 30 - Year of Average Daily Traffic		27
Item 31 - Design Load		28
Item 32 - Approach Roadway Width		28-29
Item 32A - Approach Pavement, Type & Width		30
Item 33 - Bridge Median		31
Item 34 - Skew		32
Item 35 - Structure Flared		32
Item 36 - Traffic Safety Features		33-34
Item 37 - Historical Significance		35
Item 38 - Navigation Control		35
Item 39 - Navigation Vertical Clearance		36
Item 40 - Navigation Horizontal Clearance		36
Item 41 - Structure Open, Posted, or Closed to Traffic		37
Item 42 - Type of Service		38
Item 43 - Structure Type, Main		39
Item 44 - Structure Type, Approach Spans		40
Item 45 - Number of Spans in Main Unit		40
Item 46 - Number of Approach Spans		40
Item 47 - Inventory Route, Total Horizontal Clearance		41
Item 48 - Length of Maximum Span		42
Item 49 - Structure Length		42-43
Item 50 - Curb or Sidewalk Widths		44

Item 51 - Bridge Roadway Width, Curb-to-Curb	44-45
Item 52 - Deck Width, Out-to-Out	45
Item 50, 51, 52 Examples	46-47
Item 53 - Minimum Vertical Clearance Over Bridge Roadway	48
Item 54 - Minimum Vertical Underclearance	48-50
Item 55 - Minimum Lateral Underclearance on Right	51-52
Item 56 - Minimum Lateral Underclearance on Left	53
Items 58 through 62 - Indicate the Condition Ratings	53-54
Item 58 - Deck	55
Item 58A - Deck Wearing Surface	56
Item 59 - Superstructure	57
Item 59A - Paint	58
Item 60 - Substructure	59
Item 61 - Channel and Channel Protection	60
Item 62 - Culverts	61-62
Item 63 - Method Used to Determine Operating Rating	62a
Item 64F - Federal Operating Rating	62b
Item 64MA - Michigan Operating Rating Method	62c
Item 64MB - Michigan Operating Rating	62d
Item 64MC - Michigan Operating Vehicle	63
Item 65 - Method Used to Determine Inventory Rating	64
Item 66 - Inventory Rating	65
Items 67, 68, 69, 71, and 72 - Appraisal Ratings	66
Item 67 - Structural Evaluation	67
Item 68 - Deck Geometry	67
Item 69 - Underclearances, Vertical and Horizontal	67
Item 70 - Bridge Posting	68
Item 71 - Waterway Adequacy	69-70
Item 72 - Approach Roadway Alignment	70-71
Item 75 - Type of Work	71-73
Item 76 - Length of Structure Improvement	74-75
Item 77 - Steel Type	76
Item 78 - Paint Type	76
Item 79 - Rail Type	77
Item 80 - Rail Post Code	78
Item 90 - Inspection Date	79
Item 91 - Designated Inspection Frequency	79
Item 92 - Critical Feature Inspection	80
Item 93 - Critical Feature Inspection Date	81
Item 94 - Bridge Improvement Cost	82
Item 95 - Roadway Improvement Cost	83
Item 96 - Total Project Cost	83
Item 97 - Year of Improvement Cost Estimate	83
Item 98 - Border Bridge	84
Item 99 - Border Bridge Structure Number	84
Item 100 - STRAHNET Highway Designation	85
Item 101 - Parallel Structure Designation	86

Item 104 - Highway System of the Inventory Route	88
Item 105 - Federal Lands Highways	88
Item 106 - Year Reconstructed	89
Item 107 - Deck Structure Type	90
Item 108 - Wearing Surface/Protective System	90-91
Item 109 - Average Daily Truck Traffic	91
Item 110 - Designated National Network	92
Item 111 - Pier or Abutment Protection (for Navigation)	92
Item 112 - NBIS Bridge Length	93-94
Item 113 - Scour Critical Bridges	95-97
Item 114 - Future Average Daily Traffic	98
Item 115 - Year of Future Average Daily Traffic	98
Item 116 - Minimum Navigation Vertical Clearance, Vertical Lift Bridge	98
Item 118 - Project ID Other Route	98
Item 119 - Place Code	99
Item 120 - Pedestrian Fence	99
Item 141 - Posted Loading	100
Item 143 - Pin and Hanger Code	100
Item 148 - Number of Pins	100
Item 176 - Under Water Inspection	101
Item 193 - Overload Class	101
Item 194 - Struct. Deficient & Funct. Obsolete Test	102
Item 196 - Federal Sufficiency Ratings	103
Item 202 - Year Painted	103
Item 203 - Year Overlay	103
Item 302 - Main Route Code	103
Item 304 - City Number	103
Item 595 - Footing Type	104
Item 600 - Proposed Paint Color	104

Structure Inventory Procedures

The registered professional engineer updating the inventory database is responsible for the accuracy of all data therein, including the condition ratings and load ratings for the bridge. It is essential that the engineer have a working knowledge of the contents of this manual as well as the current editions of the Michigan Bridge Analysis Guide and the AASHTO Manual for the Bridge Evaluation, as well as other appropriate specialized manuals.

The bridge inventory data must be updated for the following cases:

1- New structures: Data shall be updated no later than **180** days (**60** days for MDOT-owned bridges) from the date the bridge is opened to traffic. Contact MDOT's Bridge Management Unit at **(517) 373-0744** to request structure numbers for new bridges. Blank SI&A forms are on the MDOT Bridge Operations web site.

2- Inspected Bridges: Data shall be updated no later than **30 days** from the date of inspection.

3- Changes in Posting: Data shall be updated no later than **180** days from the date of the change in load capacity.

4- Closed Bridges: For closed structures, photographs of the bridge showing the traffic barricades shall be submitted when first closed and every two years thereafter as long as the structure remains on the inventory to the Bridge Operations Unit with an SI&A form attached.

5- Changes in Dimensions: Whenever changes in dimensions occur due to construction on or under the bridge, the data shall be updated no later than **180** days (**60** days for MDOT-owned bridges) from the end of construction.

6- Non-Highway Bridges: The following inventory items are **required** for non-highway bridges (those bridges that do not carry any roadways): 3, 4, 6-9, 16, 17, 21, 23, 42, 43, 48, 49, 101-103, 110, 117, 147, 200, 204, 211, 219, 226-230, and 309. For new or modified structures (work done on and/or under the bridge), data shall be updated no later than **180** days (**60** days for MDOT-owned bridges) from the end of construction. For bridges that do not carry highway traffic, inspection and reporting of condition ratings is optional. **Multiple Under Records**

When more than one highway passes under a bridge, an under record shall be prepared for each. In this situation, multiple roadway data entry will be required. For each facility under the bridge, code the following items: 3, 4, 6-9, 16, 17, 21, 23, 42, 43, 48, 49, 101-103, 110, 117, 147, 200, 204, 211, 219, 226-230, 309. Contact the Bridge Operations Unit if additional roadway records need to be created.

Definition of Terms

Structure Definition

A bridge is defined as a structure including supports erected over a depression or an obstruction, such as water, highway, pedestrian, or railway and having a track or passageway for carrying traffic or other moving loads, and having an opening measured along the center of the roadway of more than 20 feet between undercopings of abutment or spring lines of arches, or extreme ends of openings for multiple boxes; it may include multiple pipes, where the clear distances between openings is less than half of the smaller contiguous opening. See Item 112 for examples.

Direction of Inventory

Certain inventory fields, for example, Item 11 (Mile Point), require a point of reference and/or a direction. The direction of inventory on the bridge is determined by the direction that the main road is inventoried. The standard direction is from west to east or south to north. The direction of inventory in business loops will be the same as that of the main route.

Data Submittal Requirements

General Requirements

All data must be entered electronically using the Michigan Bridge Inspection System (MBIS) software. See the MBIS section of the MDOT Bridge Operations Unit web site for more information.

Inspection Data

Inspection Data must be entered by a Qualified Team Leader (QTL) using the MBIS application. This inspection data may only be changed by the same QTL up until the time that the next inspection is entered.

Inventory Data

Changes in non inspection-related data (such as load ratings, traffic data, overlay data, etc) may be changed in one of two ways:

- 1) Have the QTL that did the last inspection enter the data using MBIS.
- 2) Send an SI&A form to the MDOT Bridge Operations Unit marked up with the changes in RED. This form should be sent by the bridge owner.

These changes must be sent in or updated within **60** days of the time they become effective.

Non-Updatable Items

Certain items such as the various roadway classifications are non-updatable for the user. Requests for updates to these items should be made by contacting the Bridge Operations Unit.

Jurisdictional Changes

Changes in jurisdiction for a bridge can be made by sending the documentation to the Bridge Operations Unit. No changes can be made without the appropriate documentation.

Photographic Requirements

When a bridge is posted or closed, submit a photograph showing the sign or closure method in place at the bridge site, with corresponding SI&A form attached to the top of each submittal, to the Bridge Operations Unit. The posting on the sign should match the coding for item 141.

Removal of Bridges From Inventory

If a bridge has been closed and should be removed from inventory, send a request to the Bridge Operations Unit on the letterhead of the agency. Bridges which have been closed for over five years will be removed from inventory unless the agency provides documentation of progress being made for the replacement or rehabilitation of the bridge.

Pontis Element Data

The collection of Pontis element data is currently optional for all local agencies. This data may be collected using the MBIS application.

Item 2 - Region

(XX)

The following codes are used to identify the appropriate region for the structure.

- | | |
|----------------|-----------------|
| 01 - Superior | 02 - North |
| 03 - Grand | 04 - Bay |
| 05 - Southwest | 06 - University |
| 07 - Metro | |

(Note: No update by user)

Item 3 - State County

(XX)

Use the appropriate two digit code below to identify the county.

- | | | |
|-------------------|---------------|-----------------|
| 01 Alcona | 29 Gratiot | 57 Missaukee |
| 02 Alger | 30 Hillsdale | 58 Monroe |
| 03 Allegan | 31 Houghton | 59 Montcalm |
| 04 Alpena | 32 Huron | 60 Montmorency |
| 05 Antrim | 33 Ingham | 61 Muskegon |
| 06 Arenac | 34 Ionia | 62 Newaygo |
| 07 Baraga | 35 Iosco | 63 Oakland |
| 08 Barry | 36 Iron | 64 Oceana |
| 09 Bay | 37 Isabella | 65 Ogemaw |
| 10 Benzie | 38 Jackson | 66 Ontonagon |
| 11 Berrien | 39 Kalamazoo | 67 Osceola |
| 12 Branch | 40 Kalkaska | 68 Oscoda |
| 13 Calhoun | 41 Kent | 69 Otsego |
| 14 Cass | 42 Keweenaw | 70 Ottawa |
| 15 Charlevoix | 43 Lake | 71 Presque Isle |
| 16 Cheboygan | 44 Lapeer | 72 Roscommon |
| 17 Chippewa | 45 Leelanau | 73 Saginaw |
| 18 Clare | 46 Lenawee | 74 Sanilac |
| 19 Clinton | 47 Livingston | 75 Schoolcraft |
| 20 Crawford | 48 Luce | 76 Shiawassee |
| 21 Delta | 49 Mackinac | 77 St. Clair |
| 22 Dickinson | 50 Macomb | 78 St. Joseph |
| 23 Eaton | 51 Manistee | 79 Tuscola |
| 24 Emmet | 52 Marquette | 80 Van Buren |
| 25 Genesee | 53 Mason | 81 Washtenaw |
| 26 Gladwin | 54 Mecosta | 82 Wayne |
| 27 Gogebic | 55 Menominee | 83 Wexford |
| 28 Grand Traverse | 56 Midland | |

Item 4 - City Code (XXXX)

Required for city legal systems 4 and 5 only. All other agencies must leave blank.

Record the four digit City number to indicate the municipality that owns the structure. If the structure is not owned by a municipality, leave this item blank.

City numbers are available by contacting the Bridge Management Unit of the Michigan Department of Transportation.

Refer to Item 304, for the city number in which the structure is located.

(Note: No update by user)

Item 5 - Inventory Route

The inventory route over is a 9-digit code composed of 5 segments.

<u>Segment</u>	<u>Description</u>	<u>Length</u>
5A	Record Type / Delete Structure	1 digit
5B	Route Signing Prefix	1 digit
5C	Designated Level of Service	1 digit
5D	Route Number	5 digits
5E	Directional Suffix	1 digit

Segment 5A - Record Type

(X)

There are two types of National Bridge Inventory records: "on" and "under". Code the first digit (left most) using one of the following codes:

<u>Code</u>	<u>Description</u>
1	Route carried "on" the structure
2	Single route goes "under" the structure
A through Z	Multiple routes go "under" the structure

A signifies the first of multiple routes under the structure.
B signifies the second of multiple routes under the structure.
Z signifies 26 routes under the structure.

"On" signifies that the inventory route is carried "on" the structure. Each bridge structure carrying highway traffic must have a record identified with a type code = 1 . All of the NBI data items must be coded, unless specifically excepted, with respect to the structure and the inventory route "on" it.

Item 5A - Record Type (cont'd)

"Under" signifies that the inventory route goes "under" the structure. If an inventory route beneath the structure is a Federal-aid highway, is a STRAHNET route or connector or is otherwise important, a record must be coded to identify it. The type code must be 2 or an alphabetic letter A through Z. Code 2 for a single route under the structure. If 2 or more routes go under a structure on separate roadways, the code of 2 shall not be used. Code A, B, C, D, etc. consecutively for multiple routes on separate roadways under the same structure. STRAHNET routes shall be listed first. When this item is coded 2 or A through Z and no "on" record is recorded only the following items must be coded: Items 3-11, 16, 17, 19, 20, 26-30, 42, 43, 47-49, 100-104, 109 and 110. All other items may remain blank.

It cannot be overemphasized that all route-oriented data must agree with the coding as to whether the inventory route is "on" or "under" the structure.

There are situations of a route "under" a structure, where the structure does not carry a highway, but may carry a railroad, pedestrian traffic, tunnel, or even a building. These are coded the same as any other "under" record and no "on" record shall be coded.

Segment 5B - Route Signing

(X)

This code identifies the route signing prefix for the inventory route using the following codes:

<u>Code</u>	<u>Description</u>
Blank	Non highway over highway
1	Interstate highway
2	U.S. numbered highway
3	State highway
4	County highway
5	City street
6	Federal lands road
7	State lands road
8	Other (include toll roads not otherwise shown or identified)

When two or more routes are concurrent, the highest class of route will be used. The hierarchy is in the order listed above.

Segment 5C - Designated Level of Service

(X)

In the box labeled “DES”, identifies the designated level of service for the inventory route using the following codes.

<u>Code</u>	<u>Description</u>
Blank	Nonhighway over highway
0	None of the below
1	Mainline
2	Alternate
3	Bypass
4	Spur
6	Business
7	Ramp, Wye, Connector, etc.
8	Service and/or unclassified frontage road

Segment 5D - Route Number

(XXXXX)

In the box labeled “ROUTE NUMBER”, using up to 5 digits, record the route number of the inventory route designated in segment 5B.

If concurrent routes are of the same hierarchy level, denoted by the route signing prefix, the lowest numbered route shall be coded. Code 00000 for bridges on roads without route numbers.

Segment 5E - Directional Suffix

(X)

In the box labeled “DIR”, code the directional suffix to the route number of the inventory route when it is part of the route number, using the following codes.

<u>Code</u>	<u>Description</u>
Blank	Non highway over highway
0	Not applicable (Bidirectional)
1	North
2	East
3	South
4	West

Item 5 - Inventory Route

EXAMPLES

Code

	TYP	KND	DES	ROUTE NUMBER	DIR
I-96, on	1	1	1	96	0
M-66, on	1	3	1	66	0
U.S. 31 N Bypass, on	1	2	3	31	1
City street, on	1	5	0	0	0
County Highway 173 under	2	4	1	173	0

Item 6 - Features Intersected

24 CHARACTERS

The information to be recorded for this item shall be the name or names of the features intersected by the structure. Using up to 24 characters, record the feature intersected by the structure. When the feature intersected is another highway, the signed number or name of the highway shall appear first (leftmost) in the field. The names of any other features shall follow, separated by a semicolon or a comma. Parentheses shall be used to provide a second identification of the same feature. Abbreviations may be used where necessary, but an effort shall be made to keep them meaningful.

Item 7 - Facility Carried by Structure

18 CHARACTERS

The information to be recorded for this item shall be the name or names of the facilities carried by the structure. Using up to 18 characters, record the facility carried by the structure. In all situations this item describes the use "on" the structure.

EXAMPLES OF FACILITIES CARRIED:

- COUNTY ROAD 452
- US-131
- MAIN STREET
- CSX RAILROAD
- PEDESTRIAN BRIDGE

Item 8 - Structure Identification, MDOT ID
(Entered by Bridge Management Unit)

23 CHARACTERS

This item identifies the county located in, City number (If legal 4 or 5), legal system, project identification number, structure number, and direction of the route with which the structure is inventoried.

County Michigan County Number 2 digits

City Michigan City Number (If legal 4 or 5) 4 digits

Legal 1 digit

Refer to act 51, Public Acts 1951.

Code to conform to the presently certified legal system:

<u>Code</u>	<u>Description</u>
1	State trunk line highways
2	County primary roads
3	County local roads
4	City major streets
5	City local streets
6	Other

Code according to highest classification of highway involved “on” or “under” structure.

Project Identification

12 digits

A unique code for identifying a highway section in the State Needs Study.

Code as follows:

For State (Legal System 1)

Digits	8-12	Control Section No.
	13-17	Rating Section No.
	18-19	Segment No.

For County Primary (Legal System 2)

Digits.	8-12	(Blank)
	13-17	Project No.
	18-19	Segment No.

For County Local Roads (Legal System 3)

Digits.	8-9	(Blank)
	10-11	Twp. No.
	12	Twp. Suffix Letter*
	13-15	Zeros
	16-17	Project or Group No.
	18-19	Segment No.

Subdivision (Legal System 3)

Digits	8-9	(Blank)
	10-11	Twp. No.
	12	Twp. Suffix Letter*
	13-14	Section No.
	15-16	Project or Group No.
	17	Map No.
	18-19	Segment No.

For City Majors and Locals (Legal Systems 4 & 5)

Digits	8-12	(Blank)
	13-17	Project Number
	18-19	Segment

*Used when more than one Survey Twp. has the same name.

Structure Number

3 Characters

The structure number identifies a particular bridge by indicating the type of service and location. The number is assigned in sequence within project limits. The first position contains a letter indicating the type of facility.

B	Highway over Waterway
C	Highway over Waterway (Culvert)
S	Highway over Highway
R	Highway over Railway
X	Railway over Highway
P	Pedestrian Overpass
Z	Miscellaneous (Plaza, Building etc. . . .)
N	Non-motorized Traffic (Bicycle)
V	Highway over Non-motorized
T	Tunnel, Highway through

The last two positions indicate the sequential number of the structure within the road project, beginning with 01.

EXAMPLES:

B01	Is the first waterway structure
B11	Is the 11th waterway structure in the section
S01	Is the first highway grade separation

When coding for this item and following items, any structure or structures with a closed median should be considered as one structure, not two.

Direction

1 digit

This field is coded only to distinguish between structures whose identifications in digits 1-22 are the same, but whose attributes require the recording of more than one structure.

Code

1	Northbound portion of structure
2	Southbound portion of structure
3	Eastbound portion of structure
4	Westbound portion of structure
5	Secondary Northbound portion or NE Quadrant Ramp
6	Secondary Southbound portion of SW Quadrant Ramp
7	Secondary Eastbound portion or SE Quadrant Ramp
8	Secondary Westbound portion of NW Quadrant Ramp

Normally, this field is blank.

Structure Identification in Michigan

There are several structure identifications available in the database.

National Bridge Inventory Identification Number

15 Characters

Database Location: bridge.brkey

This identifier is that which is submitted to FHWA in the National Bridge Inventory . It consists of 15 characters. These may be decoded as follows:

MDOT bridge example:

82182024000S061

82 (characters 1-2) = Michigan county number
1 (character 3) = legal system
82024 (characters 4-8) = Control Section
000 (characters 9-11) = three zeros for all MDOT bridges
S06 (character 12-14) = structure number
1 (character 15) = Directional suffix (zero if no suffix)

County primary bridge example:

25200007000B010

25 (characters 1-2) = Michigan county number
2 (character 3) = legal system
00007 (characters 4-8) = Project number
000 (characters 9-11) = three zeros for all County bridges
B01 (character 12-14) = structure number
0 (character 15) = Directional suffix (zero if no suffix)

County secondary bridge example:

25302A00007B010

25 (characters 1-2) = Michigan county number
3 (character 3) = legal system
02 (characters 4-5) = township number
A (character 6) = township map suffix (coded "H" if blank in the 23 char. Michigan ID)
00007 (characters 7-11) = Project number
B01 (character 12-14) = structure number
0 (character 15) = Directional suffix (zero if no suffix)
National Bridge Inventory Identification Number examples continued.

City bridge example:

254238800042B01

25 (characters 1-2) = Michigan county number
4 (character 3) = legal system
2338 (characters 4-7) = city number
00042 (characters 8-12) = Project number
B01 (character 13-15) = structure number
NO directional suffix on city bridges

MDOT Bridge Identification Number 23 characters

Control Section / Structure Number 11 characters

Structure Number / Control Section 11 characters

Analysis ID 4 characters

This is a four digit number used in identifying load rating analysis files

EPA ID 12 characters

This is a 12 character string used by the EPA to identify a bridge as a potential hazardous waste generation site.

Old ID 12 characters

This is an identification scheme not currently used, but helpful when cross referencing old plans.

Old ID example:

B01-82-06-12

B01 = structure number

82 = MDOT county number

06 = Township number in county

12 = Roadway number

Item 9 - Location

25 CHARACTERS

Using up to 25 characters, record a narrative description of the bridge location. It is recommended that the location be keyed to a distinguishable feature on an official MDOT map such as road junctions, topographical features, and townships.

EXAMPLES OF LOCATIONS:

8.5 MI N OF GRAYLING
1.0 MI W OF IONIA CO LINE
SMITH TWP SEC 35-36

Item 10 - Inventory Route, Min. Vertical Clearance, Best 10 Feet

LEFT (Ft Ft - In In), RIGHT (Ft Ft - In In)

Code the minimum vertical clearance over the inventory route identified in Item 5, whether the route is "on" the structure or "under" the structure. This item is blank if Item 5 is blank.

For the left and right roadways record the minimum vertical clearance(s) over the inventory route identified in Item 5. The minimum clearance is for a 10 foot width of the pavement or traveled part of the roadway where the clearance is the greatest and shall be recorded using up to 4 digits representing feet and inches. This would be the practical maximum clearance. When no restriction exists or when the restriction is 100 feet or greater, record 99-99.

If multiple facilities are carried by the structure, record the clearance for the facility determined most important, according to the table below. Record clearances for additional facilities in the REMARKS area of the inventory form.

1. Interstate Highway
2. U.S. numbered highway
3. State highway or business route or loop
4. County highway or city street
5. Ramp, wye, or service road
6. Other roads
7. Railroads

For a single two-way roadway situation, record Left as blank and record Right with the clearance.

Item 10 - Vertical Clearance Route Over Best 10 Feet (Continued)

For multiple roadway situations, record clearances for Left and Right openings in their respective boxes.

Left and right openings are determined with respect to the inventory direction.

EXAMPLES:

Clearance		Record	
<u>Left</u>	<u>Right</u>	<u>Left</u>	<u>Right</u>
None	16'- 4"		16 04
14'- 2"	13'-11"	14 02	13 11
no restrictions	(multiple roadways)	99 99	99 99
no restrictions	(two-way roadway)		99 99

Item 11 - Mile Point

(XXXX.XXX)

The Linear Referencing System (LRS) mile point is used to establish the location of the bridge on the Base Highway Network (see Item 12). It must be from the same LRS Inventory Route and mile point system as reported in the Highway Performance Monitoring System (HPMS). The mile point recorded in this item directly relates to Item 13 - LRS Inventory Route, Subroute Number.

This item must be recorded for all structures located on or under passing the Base Highway Network. Using up to 7 digits, record the LRS mile point distance in mile to the nearest thousandth. For structures carrying the LRS Inventory Route, record the mile point at the beginning of the structure (i.e., the lowest mile point on the bridge). When the LRS Inventory Route goes under the structure (Item 5A coded 2 or A-Z), then record the mile point on the under passing route where the structure is first encountered.

Leave blank for all records where mile points are not provided. Mile points may be recorded for bridges that are not on the Base Highway Network. However, Item 12 - Base Highway Network shall be recorded zero for these records.

EXAMPLES:

	<u>Record</u>
mile point is 130.34	130.340
mile point is 9.60	9.600

Item 12 - Base Highway Network

(X)

This item is to be coded for all records in the inventory. The Base Highway Network includes the through lane (mainline) portions of the NHS, rural/urban principal arterial system and rural minor arterial system. Ramps, frontage roads and other roadways are not included in the Base Network. For the inventory route identified in Item 5 - Inventory Route, indicate whether the inventory route is on the Base Highway Network or not on that network. Use the following codes:

<u>Code</u>	<u>Description</u>
0	Inventory Route <u>is not</u> on the Base Network
1	Inventory Route <u>is</u> on the Base Network

Item 13 - LRS Inventory Route, Subroute Number

(XXXXXXXXXX)(XX)

If Item 12 - Base Highway Network has been coded 1, the information to be recorded for this item is inventory route for the State's linear referencing system (LRS). If Item 12 has been coded zero, this entire item should be left blank. This item is a 12-digit code composed of 2 segments.

<u>Segment</u>	<u>Description</u>	<u>Length</u>
13A	LRS Inventory Route	10 digits
13B	Subroute Number	2 digits

The LRS inventory route and subroute number to be reported in this item must correspond to the LRS inventory route and subroute numbers reported by the State for the Highway Performance Monitoring System (HPMS). The LRS inventory route number is coded in the ten positions of segment 13A. The subroute number, if it exists, is coded in the two positions of segment 13B.

The LRS inventory route number can be alphanumeric, but must not contain blanks. The LRS inventory route number is not necessarily the same as that posted along the roadway, but is a number used to uniquely identify a route, within at least a county and perhaps throughout the State.

The subroute number is a number that uniquely identifies portions of an inventory route section where duplicate kilometer points occur. These subroute numbers, if they exist, are identified in the State's HPMS-LRS records. If no subroute number, code 00 in this segment.

EXAMPLES:

	<u>Code</u>
Inventory Route 2775, Subroute Number 0	000000277500
Inventory Route 2775, Subroute Number 3	000000277503

Item 16 - Latitude

(XX° XX' XX.XX")

For bridges on STRAHNET and STRAHNET Connector highways and on the NHS, record the latitude of each in degrees, minutes and seconds to the nearest hundredth of a second. The point of the coordinate may be the beginning of the bridge in the direction of the inventory or any other consistent point of reference on the bridge that is compatible with the LRS. If the bridge is not on a STRAHNET highway or the NHS, leaving this item blank is acceptable, but recording the latitude if available is preferable.

The reason for the increased precision is to facilitate the use of Global Positioning System (GPS) data directly into this item. The increased precision is not currently mandatory and, if GPS readings are not available, the current measuring methods and level of precision may continue to be used. The minimum precision should be to the nearest minute, but the preferred precision is to the nearest hundredth of a second, using GPS methods.

EXAMPLES:

Record

Latitude is	35°27.3'	(current precision)	35°27'18.00"
		(acceptable)	35°27'00.00"
	35°27'18.55"	(GPS reading)	35°27'18.55"

Item 17 - Longitude

(XXX°XX' XX.XX")

For bridges on STRAHNET and STRAHNET Connector highways and on the NHS, record the longitude of each in degrees, minutes and seconds to the nearest hundredth of a second. A leading zero shall be recorded where needed. The point of the coordinate may be the beginning of the bridge in the direction of the inventory or any other consistent point of reference on the bridge that is compatible with the LRS. If the bridge is not on a STRAHNET highway or the NHS, leaving this item blank is acceptable, but recording the longitude if available is preferable.

The reason for the increased precision is to facilitate the use of Global Positioning System (GPS) data directly into this item. The increased precision is not currently mandatory and, if GPS readings are not available, the current measuring methods and level of precision may continue to be used. The minimum precision should be to the nearest minute, but the preferred precision is to the nearest hundredth of a second, using GPS methods.

EXAMPLES:

Record

Longitude is	81°5.8'	(current precision)	081°05'48.00"
		(acceptable)	081°06'00.00"
	81°5'50.65"	(GPS reading)	081°05'50.65"

Item 19 - Bypass, Detour Length

(XXX)

Using up to 3 digits, record the actual length of the detour, to the nearest mile. The detour length should represent the total additional travel for a vehicle, which would result from closing of the bridge. The factor to consider when determining if a bypass is available at the site is the potential for moving vehicles, including military vehicles, around the structure. This is particularly true when the structure is in an interchange. For instance, a bypass likely would be available for diamond interchanges, interchanges where service roads are available, or other interchanges where the positioning and layout of the ramps are such that they could be used without difficulty to get around the structure. If a ground level bypass is available, at the structure site for the inventory route, record the detour length as zero.

If the bridge is one, of twin bridges and is not at an interchange, record as 1 where the other twin bridge can be used as a temporary bypass with a reasonable amount of crossover grading. The detour route will be established following allowable criteria determined by the governing authority. (Some authorities will not allow a designated detour over a road or bridge of lesser "quality.") Record 199 for 199 kilometers (124 miles) or more.

EXAMPLES:

	<u>Record</u>
Diamond interchange, structure is bypassable	0
Cloverleaf, is not bypassable; 18-mile detour	18
Structure over a highway, no interchange, bypassable at ground level	0
Structure on dead end road	199

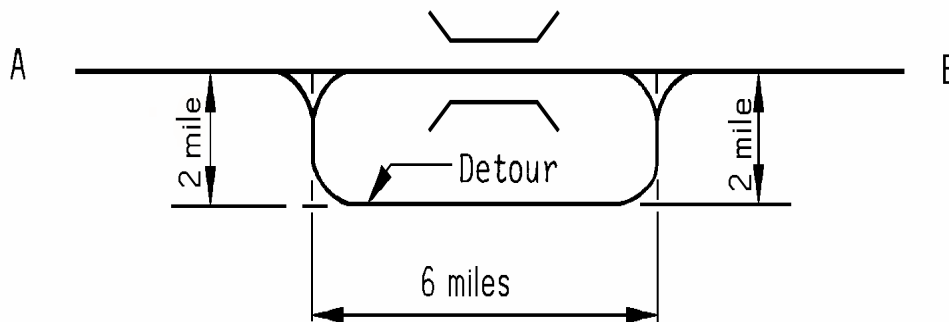

Bypass, Detour Length A to B = 4 miles

Item 19 - Bypass, Detour Length (contd.)

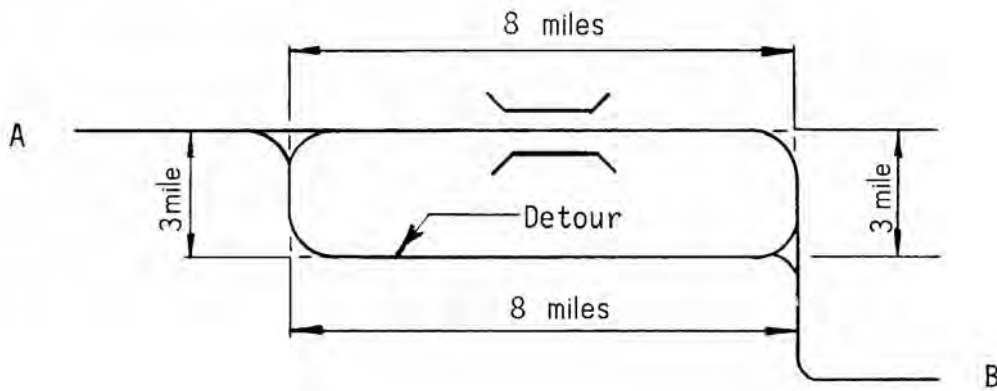

Bypass, Detour Length A to B = 0 miles

Item 20 - Toll

(X)

The toll status of the structure is indicated by this item. Interstate toll segments under Secretarial Agreement (Title 23 - United States Code - Highways Section 129 as amended by 1991 ISTEA and prior legislation) shall be identified separately. Use the following codes:

<u>Code</u>	<u>Description</u>
1	Toll bridge. Tolls are paid specifically to use the structure.
2	On a toll road. The structure carries a toll road, that is, tolls are paid to use the facility, which includes both the highway and the structure.
3	On a free road. The structure is toll-free and carries a toll-free highway.
4	On an Interstate toll segment under Secretarial Agreement. Structure functions as a part of the toll segment.
5	Toll bridge is a segment under Secretarial Agreement. Structure is separate agreement from highway segment.

Item 21 - Maintenance Responsibility

(XX)

The actual name(s) of the agency(s) responsible for the maintenance of the structure shall be recorded on the inspection form. The codes below shall be used to represent the type of agency that has primary responsibility for maintaining the structure. If more than one agency has equal maintenance responsibility, code one agency in the hierarchy of state, federal, county, city, railroad, and other private.

<u>Code</u>	<u>Description</u>
01	Michigan Department of Transportation
02	County Highway Agency
03	Town or Township Highway Agency
04	City or Municipal Highway Agency
11	State Park, Forest, or Reservation Agency
12	Local Park, Forest, or Reservation Agency
21	Other State Agencies
25	Other Local Agencies
26	Private (other than railroad)
27	Railroad
31	State Toll Authority
32	Local Toll Authority
60	Other Federal Agencies (not listed below)
62	Bureau of Indian Affairs
64	U.S. Forest Service
66	National Park Service
68	Bureau of Land Management
69	Bureau of Reclamation
70	Military Reservation/Corps of Engineers
80	Unknown

Item 22 - Owner

(XX)

The owner of the bridge must be recorded on the inventory sheet.

The actual name(s) of the owner(s) of the bridge shall be recorded on the inspection form. The codes used in Item 21 - Maintenance Responsibility shall be used to represent the type of agency that is the primary owner of the structure. If more than one agency has equal ownership, code one agency in the hierarchy of state, federal, county, city, railroad, and other private.

Joint ownership by 2 or more railroads should be coded 27.

Item 26 - Functional Classification of Inventory Route

(XX)

This Item is blank if Item 5 is blank.

For the inventory route identified in item 5, code the functional classification using the following codes:

<u>Code</u>		<u>Description</u>
	<u>Rural</u>	
01		Principal Arterial - Interstate
02		Principal Arterial - Other
06		Minor Arterial
07		Major Collector
08		Minor Collector
09		Local
	<u>Urban</u>	
11		Principal Arterial - Interstate
12		Principal Arterial - Other Freeways or Expressways
14		Other Principal Arterial
16		Minor Arterial
17		Collector
19		Local

The bridge shall be coded as rural if not inside a designated urban area. The urban or rural designation shall be determined by the bridge location and not the character of the roadway.

Refer to Federal-Aid System Atlas for limits of urban areas.

Non-Federal-Aid System routes Functional Classification = 8, 9, 19.

Item 27 - Year Built

(XXXX)

Record the year of construction of the structure. Record all 4 digits of the year in which construction of the structure was completed. If the year built is unknown, provide a best estimate. See also Item 106 - Year Reconstructed.

Complete replacement of the superstructure with a majority of the substructure replaced will be considered a new bridge.

Item 28 - Lanes On and Under the Structure

On (XX), Under (XX)

Record the number of lanes being carried by the structure and being crossed over by the structure.

<u>Segment</u>	<u>Description</u>	<u>Available</u>
28A	Lanes on the structure	2 digits
28B	Lanes under the structure	2 digits

Include all lanes carrying highway traffic (i.e., cars, trucks, buses) which are striped or otherwise operated as a full width traffic lane for the entire length of the structure or under the structure by the owning/maintaining authority. This shall include any full width merge lanes and ramp lanes, and shall be independent of direction of usage (i.e., a 1-lane bridge, carrying 2-directional traffic is still considered to carry only one lane on the structure). It should be noted here that for the purpose of evaluating the Deck Geometry - Item 68, any "1-lane" bridge, not coded as a ramp (Item 5C = 7), which has a Bridge Roadway Width, Curb-to-Curb - Item 51 recorded 16 feet or greater shall be evaluated as 2 lanes.

When the inventory route is "on" the bridge (the first digit of Item 5 - Inventory Route is coded 1), the sum of the total number of lanes on all inventoried routes under the bridge shall be recorded. When the inventory route is "under" the bridge (the first digit of Item 5, Inventory Route is coded 2 or A through Z), only the number of lanes being identified by that "under" record shall be recorded in Item 28B.

When the inventory route is "under" the structure, the obstruction over the inventory route may be other than a highway bridge (railroad, pedestrian, pipeline, etc.). Leave blank for these cases, if no highway lanes on the obstructing structure.

Double deck bridges may be coded as 1 or 2 structures as noted in the examples on the next page. Either method is acceptable, however, all related data must be compatible with the method selected.

The number of lanes on and under, shall be recorded for each segment.

Item 28 - Lanes On and Under the Structure (contd.)

EXAMPLES*:

	<u>28A</u> <u>LANES ON</u>	<u>Record</u> <u>28B</u> <u>LANES UNDER</u>
1 lane on, 0 lanes under	1	0
3 lanes on, 1 lane under	3	1
8 lanes on 2-way, 12 lanes under **	8	12
5 lanes on double deck each direction, 2 lanes under	10	2 ***
5 lanes on double deck each direction, 2 lanes under	5	2 ****
Railroad/pedestrian on, 4 lanes under	0	4

* For the inventory route on the bridge, the first digit of Item 5 - Inventory Route is coded 1.

** This example has 3 inventory routes under the bridge of 6, 4, and 2 lanes of 2-way. When coding an "under" record for each of these inventory routes, the first digit of Item 5 - Inventory Route is coded A, B, and C, Item 28A is recorded as 8 and Item 28B is recorded as 6, 4, and 2 respectively for the 3 required records.

*** Acceptable if coded as 1 bridge. However, other data such as ADT, curb-to-curb width, etc., must be for both decks (preferred method).

**** Acceptable if coded as 2 separate bridges. However, other data such as ADT, curb-to-curb width, etc., must be for a single deck.

Item 29 - Average Daily Traffic

(XXXXXX)

Using up to 6 digits, record the average daily traffic volume (ADT) for the inventory route identified in Item 5. The ADT recorded should be the most recent ADT counts available. Included in this item are the trucks referred to in Item 109 - Average Daily Truck Traffic. If the bridge is closed, record the actual ADT from before the closure occurred.

The ADT must be compatible with the other items coded for the bridge. For example, parallel bridges with an open median are coded as follows: if Item 28A - Lanes On the Structure and Item 51 - Bridge Roadway Width, Curb-to-Curb, are recorded for each bridge separately, then the ADT must be recorded for each bridge separately (not the total ADT for the route).

Item 30 - Year of Average Daily Traffic

(XXXX)

Record the year represented by the ADT in Item 29. Record all four digits of the year so recorded. ADT counts should be updated within a 4 yr. period.

Item 31 - Design Load

Use the codes below to indicate the live load for which the structure was designed. The numerical value of the railroad loading should be recorded on the form. Classify any other loading, when feasible, using the nearest equivalent of the loadings given below.

<u>Code</u>	<u>English</u> <u>Description</u>	or	<u>Metric</u> <u>Description</u>
1	H 10	or	M 9
2	H 15		M 13.5
3	HS 13.5		MS 13.5
4	H 20		M 18
5	HS 20		MS18
6	HS 20+Mod		MS18+Mod
7	Pedestrian		Pedestrian
8	Railroad		Railroad
9	HS 25 or greater		MS 22.5 or greater
0	Unknown		
A	HL93		HL93
B	Greater than HL-93		Greater than HL93
C	Other		Other

Per FHWA Memo Dated February 2, 2011 (<http://www.fhwa.dot.gov/bridge/110202.cfm>): There are two distinct codes for "Unknown" and "Other". Code 0 has only describes "Unknown" situations. This code is to be used where the design live load is unknown due to the absence of plans, design calculations, or other information. Code C is for situations which increase the design load but are not based upon AASHTO design trucks. Code B is to be used only for increased design loads which are based on the HL93 AASHTO design load configuration.

Item 32 - Approach Roadway Width

(XXX.X)

Using up to 4 digits, record the normal width of usable roadway approaching the structure measured to the nearest tenth of a foot. Usable roadway width will include the width of traffic lanes and the widths of shoulders, where shoulders are defined as follows:

Shoulders must be constructed and normally maintained flush with the adjacent traffic lane, and must be structurally adequate for all weather and traffic conditions consistent with the facility carried.

Unstabilized grass or dirt, with no base course, flush with and beside the traffic lane is not to be considered a shoulder for this item.

Item 32 - Approach Roadway Width (contd.)

For structures with medians of any type and double-decked structures, this item should be recorded as the sum of the usable roadway widths for the approach roadways (i.e., all median widths that do not qualify as shoulders should not be included in this dimension). Where there is a variation between the approaches at either end of the structure, record the most restrictive of the approach conditions.

EXAMPLES:

<u>Left Shoulder</u>	<u>Left Roadway</u>	<u>Median Shoulders</u>	<u>Right Roadway</u>	<u>Right Shoulder</u>	<u>Record</u>
4.0	-	-	16.0	6.0	26.0
6.0	-	-	36.0	12.0	54.0
12.0	48.0	30.0	48.0	12.0	150.0
10.0	24.0	16.0	36.0	10.0	96.0

The last example above represents the recording method for a structure in which the most restrictive approach has the cross-section shown below:

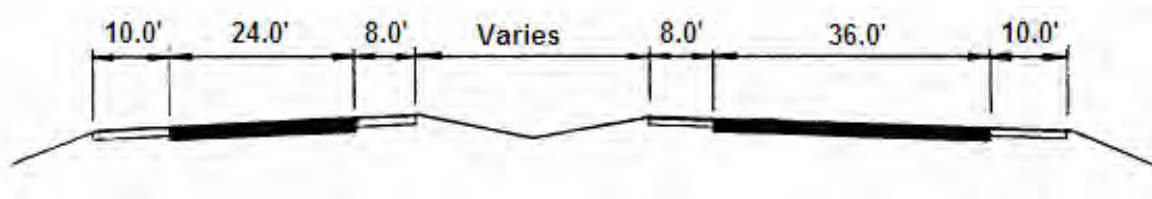

Regardless of whether the median is open or closed, the data recorded must be compatible with the other related route and bridge data (i.e., if Item 51 - Bridge Roadway Width, Curb-to-Curb is for traffic in one direction only, then Items 28A, 29, 32, etc. must be for traffic in one direction only).

If a ramp is adjacent to the through lanes approaching the structure, it shall be included in the approach roadway width. The total approach roadway width for the example below is 96.0 ft

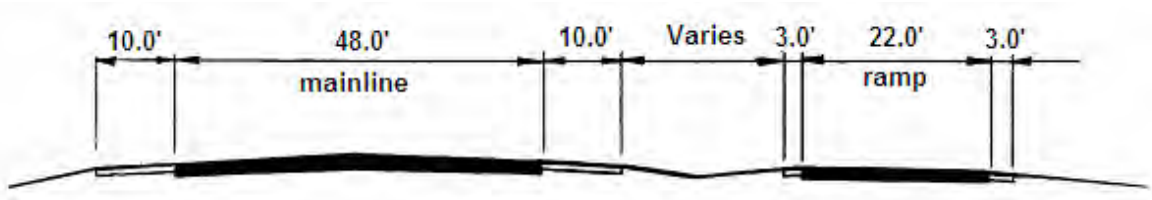

Item 32A - Approach Pavement, Type & Width

(X)(XX.X)

<u>Segment</u>	<u>Description</u>	<u>Length</u>
32AA	Surface Type	1 digit
32AB	Surface Width	3 digits

Surface Type - Choose nearest applicable code

<u>Code</u>	<u>Surface Type</u>
0	Unimproved Earth
1	Graded and Drained Earth
2	Gravel or Similar
3	Bituminous Surface Treated Gravel
4	Mixed Bituminous Surface on Gravel (1" or more)
5	Mixed Bituminous Surface on concrete or brick or black base (1" or more)
6	Concrete
7	Brick
8	Freeway designed Bituminous Concrete on Aggregate Base

Surface Width - Using up to 3 digits, record the predominant width from edge of metal to edge of metal or face to face of curb to the nearest tenth of a foot. This is the width that would be available if parking were removed.

If no highway is on structure leave blank. Code 99.9 if greater than 100'.

EXAMPLES:

<u>Type</u>	<u>Width</u>	<u>Record</u>	
		<u>Type</u>	<u>Width</u>
Gravel	24.0	2	24.0
Concrete	36.0	6	36.0
Brick	144.0	7	99.9

Item 33 - Bridge Median

(X)

Indicate with a 1 digit code if the median is nonexistent, open or closed. The median is closed when the area between the 2 roadways at the structure is bridged over and is capable of supporting traffic. All bridges that carry either, 1-way traffic or 2-way traffic separated only by a centerline will be coded 0 for no median.

<u>Code</u>	<u>Description</u>
0	No median
1	Open median
2	Closed median (no barrier)
3	Closed median with non-mountable barriers

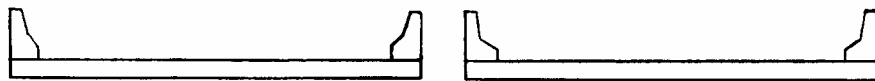

Open Median



Closed Median

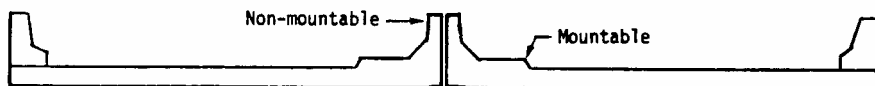

Closed Median with Non-mountable Barrier

Item 34 - Skew

(XX)^o

The skew angle is the angle between the centerline of a pier and a line normal to the roadway centerline. When plans are available, the skew angle can be taken directly from the plans. If no plans are available, the angle is to be field measured if possible. Record the skew angle to the nearest degree. If the skew angle is 0^o, it should be recorded so. When the structure is on a curve or if the skew varies for another reason, the average skew should be recorded, if reasonable. Otherwise, record 99 to indicate a major variation in skews of substructure units.

Item 35 - Structure Flared

(X)

Code this item to indicate if the structure is flared (i.e., the width of the structure varies). Generally, such variances will result from ramps converging with or diverging from the through lanes on the structure, but other causes may exist. Minor flares, at ends of structures should be ignored.

<u>Code</u>	<u>Description</u>
0	No flare
1	Yes, flared

Item 36 - Traffic Safety Features

(X)(X)(X)(X)

Bridge inspection shall include the recording of information on the following traffic safety features so that the evaluation of their adequacy can be made.

- (A) Bridge Railings: Some factors that affect the proper functioning of bridge railing are height, material, strength, and geometric features. Railings must be capable of smoothly redirecting an impacting vehicle. Bridge railings should be evaluated using the current AASHTO Standard Specifications for Highway Bridges, which calls for railings to meet specific geometric criteria and to resist specified static loads without exceeding the allowable stresses in their elements. Bridge railing should be crash tested per FHWA policy. Railings that meet these criteria and loading conditions are considered acceptable. Other railings that have been successfully crash tested are considered acceptable though they may not meet the static loading analysis and geometric requirements. Acceptable guidelines for bridge railing design and testing are also found in the AASHTO Guide Specifications for Bridge Railings 1989. Additional guidance for testing is found in National Cooperative Highway Research Program - Report 350 Recommended Procedures for the Safety Performance Evaluation of Highway Features 1993.
- (B) Transitions: The transition from approach guardrail to bridge railing requires that the approach guardrail be firmly attached to the bridge railing. It also requires that the approach guardrail be gradually stiffened as it comes closer to the bridge railing. The ends of curbs and safety walks need to be gradually tapered out or shielded.
- (C) Approach Guardrail: The structural adequacy and compatibility of approach guardrail with transition designs should be determined. Rarely does the need for a barrier stop at the end of a bridge. Thus, an approach guardrail with adequate length and structural qualities to shield motorists from the hazards at the bridge site needs to be installed. In addition to being capable of safely redirecting an impacting vehicle, the approach guardrail must also facilitate a transition to the bridge railing that will not cause snagging or pocketing of an impacting vehicle. Acceptable guardrail design suggestions are contained in the AASHTO Roadside Design Guide and subsequent FHWA or AASHTO guidelines.
- (D) Approach Guardrail Ends: As with guardrail ends in general, the ends of approach guardrails to bridges should be flared, buried, made breakaway, or shielded. Design treatment of guardrail ends is given in the AASHTO Roadside Design Guide.

Item 36 - Traffic Safety Features (contd.)

The data collected shall apply only to the route on the bridge. Collision damage or deterioration of the elements are not considered when coding this item. Traffic safety features is composed of 4 segments.

<u>Segment</u>	<u>Description</u>	<u>Length</u>
36A	Bridge railings	1 digit
36B	Transitions	1 digit
36C	Approach guardrail	1 digit
36D	Approach guardrail ends (Terminus)	1 digit

The reporting of these features shall be as follows:

<u>Code</u>	<u>Description</u>
0	Inspected feature does not meet currently acceptable or a safety feature is required and none is provided. *
1	Inspected feature meets currently acceptable standards. *
N	Not applicable or a safety feature is not required. *

* For structures on the NHS, national standards are set by regulation. For those not on the NHS, it shall be the responsibility of the highway agency (state, county, local or federal) to set standards.

EXAMPLES:

	<u>Code</u>			
	<u>RL</u>	<u>TR</u>	<u>AP</u>	<u>TM</u>
All features meet currently acceptable standards except transition	1	0	1	1
Railroad over	N	N	N	N

Item 37 - Historical Significance

(X)

The historical significance of a bridge involves a variety of characteristics: the bridge may be a particularly unique example of the history of engineering; the crossing itself might be significant; the bridge might be associated with a historical property or area; historical significance also could be derived from the fact the bridge was associated with significant events or circumstances. Use the following codes:

<u>Code</u>	<u>Description</u>
1	Bridge is on the National Register of Historic Places.
2	Bridge is eligible for the National Register of Historic Places.
3	Bridge is possibly eligible for the National Register of Historic Places or bridge is on a State or local historic register. (Further investigation required before determination can be made.)
4	Historical significance is not determinable at this time.
5	Bridge is not eligible for the National Register of Historic Places.

Item 38 - Navigation Control

(X)

Indicate for this item whether or not navigation control (a bridge permit) is required. Use the following codes:

<u>Code</u>	<u>Description</u>
N	Not applicable, no waterway
0	No navigation control on waterway (bridge permit not required)
1	Navigation control on waterway (bridge permit required)

Determination of whether or not a water course is navigable is made by the U.S. Coast Guard or the U.S. Army Corps of Engineers, whichever is applicable.

Item 39 - Navigation Vertical Clearance

(XXX.X) ft

If Item 38 - Navigation Control has been coded 1, record the minimum vertical clearance imposed at the site as measured above a datum that is specified on a navigation permit issued by a control agency. The measurement shall be recorded using up to a 4 digit number rounded down to the tenth of a foot. This measurement will show the clearance that is allowable for navigational purposes. In the case of a swing or bascule bridge, the vertical clearance shall be measured with the bridge in the closed position (i.e., open to vehicular traffic). The vertical clearance of a vertical lift bridge shall be measured with the bridge in the raised or open position. Also, Item 116 - Minimum Navigation Vertical Clearance Vertical Lift Bridge shall be recorded to provide clearance in a closed position. If Item 38 - Navigation Control has been coded 0 or N, leave blank to indicate not applicable.

Item 40 - Navigation Horizontal Clearance

(XXXX.X) ft

If Item 38 - Navigation Control has been coded 1, record the horizontal clearance measurement imposed at the site shown on the navigation permit. This may be less than the structure geometry allows. If a navigation permit is required but not available, use the minimum horizontal clearance between fenders, if any, or the clear distance between piers or bents. Record the clearance using up to 5 digits rounded down to the tenth of a foot. If Item 38 - Navigation Control has been coded 0 or N, leave blank to indicate not applicable.

Item 41 - Structure Open, Posted, or Closed to Traffic

(X)

This item provides information about the actual operational status of a structure. The field review could show that a structure is posted, but Item 70 - Bridge Posting may indicate that posting is not required. This is possible and acceptable coding since Item 70 is based on the operating stress level and the governing agency's posting procedures may specify posting at some stress level less than the operating rating. Use the following codes.

<u>Code</u>	<u>Description</u>
A	Open, no restriction
B	Open, posting recommended but not legally implemented (all signs not in place or not correctly implemented)
D	Open, would be posted or closed except for temporary shoring, etc. to allow for unrestricted traffic
E	Open, temporary structure in place to carry legal loads while original structure is closed and awaiting replacement or rehabilitation
G	New structure not yet open to traffic
K*	Bridge closed to all traffic
P	Posted for load (may include other restrictions such as temporary bridges which are load posted)
R	Posted for other load-capacity restriction (speed, number of vehicles on bridge, etc.)
S	Scheduled for construction (new bridge)

*Note: This is intended to correspond to a code of "0" or "1" in any one or all of Items 59, 60, 62, or 67.

Note: If this Item coded "B", "D", "E", "P" or "R", Item 91 (Insp. Freq.) should be less than 24 months.

Item 42 - Type of Service

Code the type of service “on” and “under” the bridge in their respective boxes.

<u>Segment</u>	<u>Description</u>	<u>Length</u>
42A	Type of service “on” bridge	1 digit
42B	Type of service “under” bridge	1 digit

Segment 42A - Service Type

(X)

In the box labeled “42A SERV TYPE” indicate the type of service "on" the bridge using the following codes:

<u>Code</u>	<u>Description</u>
1	Highway
2	Railroad
3	Pedestrian-bicycle
4	Highway-railroad
5	Highway-pedestrian
6	Overpass structure at an interchange or second level of a multilevel interchange
7	Third level (Interchange)
8	Fourth level (Interchange)
9	Building or plaza
0	Other (non-highway)

Segment 42B - Service Type

(X)

In the box labeled “42B SERV TYPE” indicate the type of service "under" the bridge using the following codes:

<u>Code</u>	<u>Description</u>
1	Highway, with or without pedestrian
2	Railroad
3	Pedestrian-bicycle
4	Highway-railroad
5	Waterway
6	Highway-waterway
7	Railroad-waterway
8	Highway-waterway-railroad
9	Relief for waterway
0	Other (non-highway)(i.e., recreation trail)

Item 43 - Structure Type, Main

MAT(X), DES(XX)

Record using 2 segments the predominant type of structure for the main span(s).

<u>Segment</u>	<u>Description</u>	<u>Length</u>
43A	Kind of material (MAT)	1 digit
43B	Type of design (DES)	2 digits

Record in segment 43A the code which indicates the kind of material and in segment 43B record the code which indicates the type of design/construction. Use the codes in the table below.

Special Michigan subtypes shown indented with "(" convert to Federal code immediately above it and are for optional use by local agencies.

<u>MAT</u>	<u>DES</u>
1 Concrete	00 Other
2 Concrete continuous	01 Slab
3 Steel, simple or Cantilever.	(71 Slab Timber - Composite)
4 Steel continuous	02 Multi-Stringer, W or I-Beam, Non-composite
5 Prestressed concrete*	(32 Multi-Stringer, W or I-Beam, Composite)
6 Prestressed concrete continuous*	(42 Multi-Stringer, W or I-Beam, Encased)
7 Timber	(52 Multi-Stringer, Plate Girder, Non-composite)
8 Masonry	(62 Multi-Stringer, I-Beam, Jack Arch Floor)
9 Aluminum, W.I. or C.I.	(72 Multi-Stringer, W or I-Beam, Timber Floor)
0 Other	(82 Multi-Stringer, Plate Girder, Composite)
	(92 Multi-Stringer, Plate Girder, Encased)
	03 Girder & Floorbeam - Deck, Non-composite
	(33 Girder & Floorbeam - Composite Girder)
	(25 Girder - Thru (Include conc. Camelbacks))
* Post-tensioned concrete should be coded as prestressed concrete	04 Tee Beam
	05 Box Beam or Girders - Multiple
	06 Box Beam or Girders - Single or spread (segmental)
	07 Frame - Rigid (except frame culverts)
	08 Orthotopic
	09 Truss - Deck
	10 Truss - Thru & Pony
	11 Arch - Deck, Filled Spandrel
	(24 Arch - Deck, Open Spandrel)
	12 Arch - Thru
	13 Suspension
	14 Stayed Girder
	15 Movable - Lift
	16 Movable - Bascule
	17 Movable - Swing
	18 Tunnel
	19 Culvert (Box, Pipe or Pipe Arch)(includes frame culverts)
	20 Mixed types (Note: applicable only to approach span - Item 44)
	21 Segmental Box Girder
	22 Channel Beam (Inverted Channel)

<u>EXAMPLES:</u>	<u>MAT</u>	<u>DES</u>
Masonry Culvert	8	19
Steel Suspension	3	13
Continuous Concrete Multiple Box Girders	2	05

Item 44 - Structure Type, Approach Spans

MAT(X), DES(XX)

Record in 2 segments, the type of structure for the approach spans to a major bridge or for the spans where the structural material is different. The codes are the same as for Item 43 preceding. However, leave blank if this item is not applicable. Use code 20 (Item 44B) when no one type of design and/or construction is predominate for the approach units. If the kind of material (Item 44A) is varied, code the most predominant.

<u>Segment</u>	<u>Description</u>	<u>Length</u>
44A	Kind of material (MAT)	1 digit
44B	Type of design (DES)	2 digits

EXAMPLES:

	<u>Mat</u>	<u>Code</u>	<u>DES</u>
Simple prestress concrete I-Beam	5		02
Continuous concrete T-Beam	2		04
Continuous deck truss	4		09

Item 45 - Number of Spans in Main Unit

(XXX)

Using up to 3 digits, record the number of spans in the main or major unit. This item will include all spans of most bridges, the major unit only of a sizable structure, or a unit of material or design different from that of the approach spans.

Note: Pedestrian bridges with ramps and staircases should show the ramps and stair cases as approach spans.

Item 46 - Number of Approach Spans

(XXXX)

Using up to 4 digits, record the number of spans in the approach spans to the major bridge, or the number of spans of material different from that of the major bridge. Leave blank if not applicable.

Note: Pedestrian bridges with ramps and staircases should show the ramps and stair cases as approach spans.

Item 47 - Inventory Route, Total Horizontal Clearance LEFT(XX.X) ft, RIGHT(XX.X) ft

The total horizontal clearance for the left and right roadways, of the inventory route identified in Item 5 shall be measured and recorded using up to 3 digits rounded down to the nearest tenth of a foot. The clearance should be the available clearance measured between the restrictive features -- curbs, rails, walls or other structural features limiting the roadway (surface and shoulders). When the restriction is 100 feet or greater, record 99.9.

The purpose of this item is to give the largest available clearance for the movement of wide loads. Flush and mountable medians are not considered restrictions. This clearance is defined in 2 ways; use the most applicable:

1. Clear distance between restrictions of the inventory route either “on” or “under” the structure.
2. Roadway surface and shoulders - when there are no restrictions.

If multiple facilities are carried by the structure, record the horizontal clearances in the REMARKS area of the inventory form and record the clearances for only the facility determined most important, according to the following table:

- | | |
|---|---|
| 1 | Interstate Highway |
| 2 | U.S. numbered highway |
| 3 | State highway or business route or loop |
| 4 | County highway or city street |
| 5 | Ramp, wye, or service road |
| 6 | Other roads |
| 7 | Railroads |

For a single two-way roadway situation, record Left as blank and record Right with the clearance.

For multiple roadway situations, record clearances for Left and Right roadways in their respective boxes.

Left and right roadways are determined with respect to the inventory direction.

EXAMPLES:	<u>Clearance</u>		<u>Record</u>	
	<u>Left</u>	<u>Right</u>	<u>Left</u>	<u>Right</u>
	none	89.7		89.7
	129.5	96.4	99.9	96.4
	24.0	34.5	24.0	34.5

Item 48 - Length of Maximum Span

(XXXX.X) ft

The length of the maximum span shall be recorded. It shall be noted whether the measurement is center to center of bearing points or clear open distance between piers, bents, or abutments. The measurement shall be along the centerline of the bridge. Using up to 5 digits, record the measurement to the nearest tenth of a foot.

Item 49 - Structure Length

(XXXXX.X) ft

Using up to 6 digits, record the length of the structure to the nearest tenth of a foot. This shall be the length of roadway supported on the bridge structure. The length should be measured back to back of backwalls of abutments or from paving notch to paving notch.

Culvert lengths should be measured along the center line of roadway regardless of their depth below grade. Measurement should be made between inside faces of exterior walls.

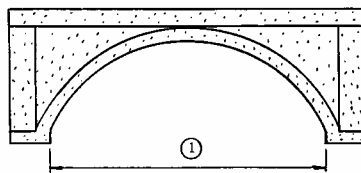
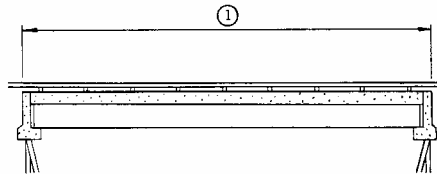
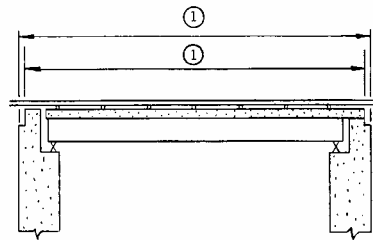

(1) Item 49 -Structure Length

Item 49 - Structure Length (contd.)

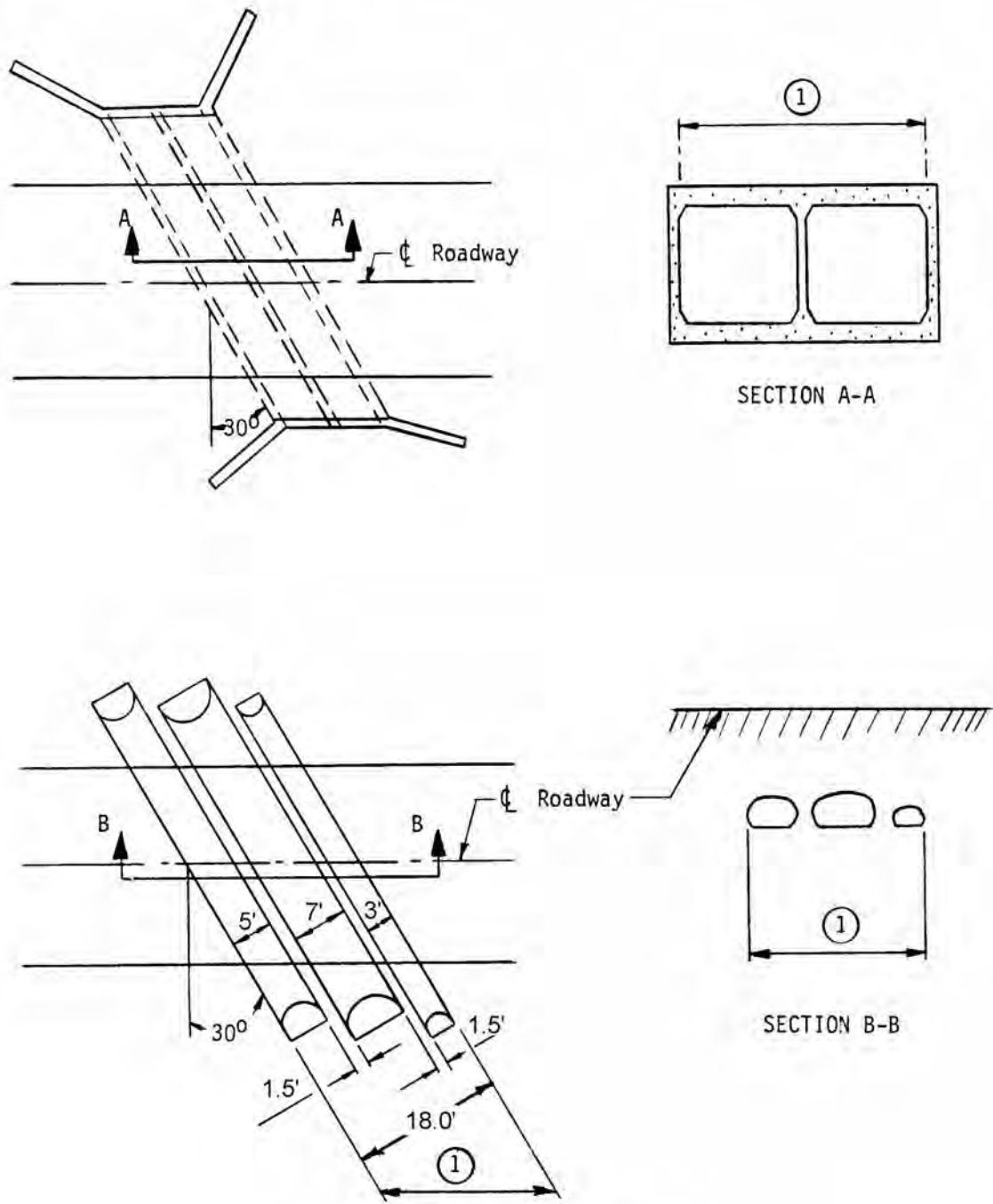

(1) Item 49 - Structure Length = $\frac{18.0'}{\cos 30^\circ} = 20.78'$

Record
20.8

Item 50 - Curb or Sidewalk Widths**LEFT(XX.X) ft, RIGHT(XX.X) ft**

Using up to 3 digits, record to the nearest tenth of a foot the widths of the left and right curbs or sidewalks. "Left" and "Right" should be determined on the basis of direction of the inventory. Leave blank if no sidewalks or curbs are present.

<u>Segment</u>	<u>Description</u>	<u>Length</u>
50A	Left curb or sidewalk width	3 digits
50B	Right curb or sidewalk width	3 digits

EXAMPLES:

	<u>Sidewalks</u>		<u>Record</u>	
	<u>Left Side</u>	<u>Right Side</u>	<u>Left</u>	<u>Right</u>
Curb or sidewalk	None	2.3	0.0	2.3
	6.0	7.1	6.0	7.1
	3.3	None	3.3	0.0
	12.1	11.5	12.1	11.5
	None	None	0.0	0.0
	0.7	0.7	0.7	0.7

See examples on pages 47 and 48.

Item 51 - Bridge Roadway Width, Curb-to-Curb**(XXX.X) ft**

The information to be recorded is the most restrictive minimum distance between curbs or rails on the structure roadway. For structures with closed medians and usually for double decked structures, recorded data will be the sum of the most restrictive minimum distances for all roadways carried by the structure*. The data recorded for this item must be compatible with other related route and bridge data (i.e., Items 28, 29, 32, etc.). The measurement should be exclusive of flared areas for ramps. Using up to 4 digits, record the distance to the nearest tenth of a foot.

See examples on pages 47 and 48.

Record as blank for Pedestrian and Railroad Structures over Highways.

Where traffic runs directly on the top slab (or wearing surface) of a culvert type structure, record the actual roadway width (curb-to-curb or rail-to-rail). This will also apply where the fill is minimal and headwalls or parapets affect the flow of traffic.

Where the roadway is on fill carried across a structure and the headwalls or parapets do not affect the flow of traffic, record as blank. This is considered proper, as a filled section simply maintains the roadway cross-section. However, for sidehill viaduct structures record the actual full curb-to-curb roadway width. See the figure in the Commentary Appendix D.

Item 51 - Bridge Roadway Width, Curb-to-Curb (contd.)

* Raised or non-mountable medians, open medians, and barrier widths are to be excluded from the summation along with barrier-protected bicycle and equestrian lanes.

EXAMPLES:	Bridge Roadway Width	<u>Record</u>
	36.00' feet	36.0
	66.37' feet	66.4
	110.13 feet	110.1

The last example above would be the recorded value for the deck section shown below.

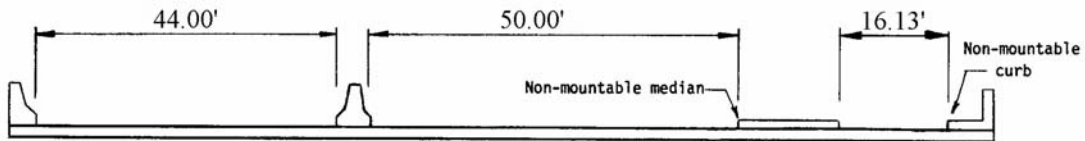

Item 52 - Deck Width, Out-to-Out

(XXX.X) ft

Using up to 4 digits, record the out-to-out width of the deck to the nearest tenth of a foot. If the structure is a through structure, the number to be recorded will represent the lateral clearance between superstructure members. The measurement should be exclusive of flared areas for ramps. See examples on pages 47 and 48.

Where traffic runs directly on the top slab (or wearing surface) of the culvert, record the actual width (out-to-out). This will also apply where the fill is minimal and the culvert headwalls affect the flow of traffic. However, for sidehill viaduct structures record the actual out-to-out structure width. See the figure in the Commentary Appendix D.

Where the roadway is on a fill carried across a pipe or box culvert and the culvert headwalls do not affect the flow of traffic, record as blank. This is considered proper, as a filled section over a culvert simply maintains the roadway cross-section.

Items 50, 51 and 52 Example:

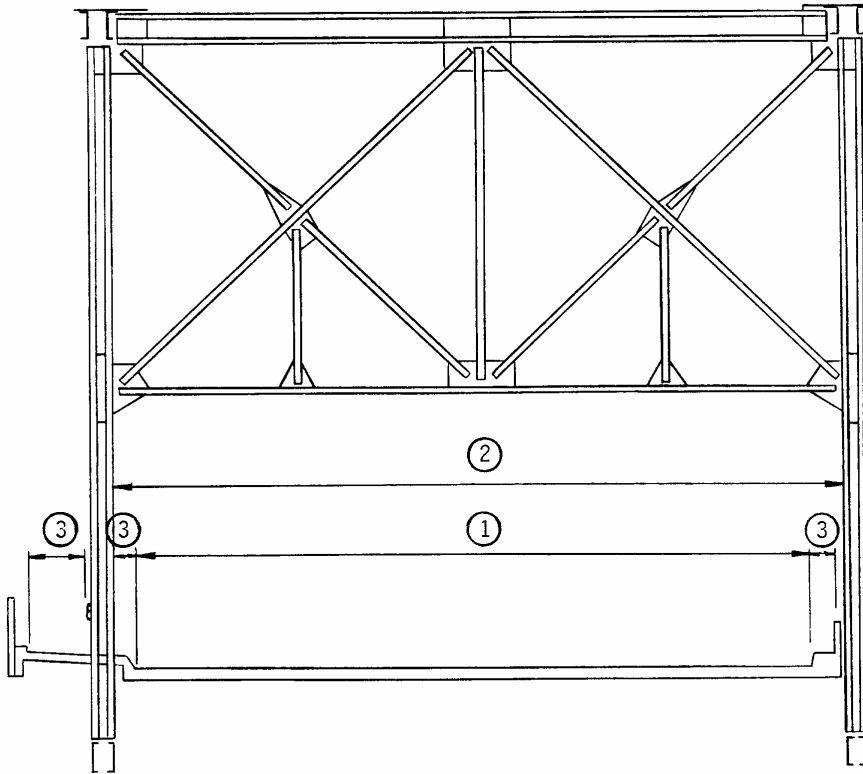

- (1) Item 51 - Bridge Roadway Width, Curb-to-Curb
- (2) Item 52 - Deck Width, Out-to-Out
- (3) Item 50 - Curb or Sidewalk Width

Items 50, 51 and 52 Examples: (contd.)

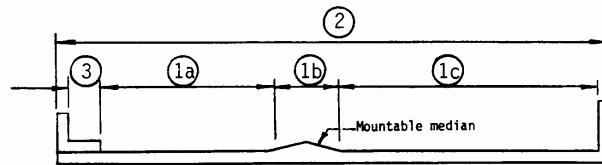
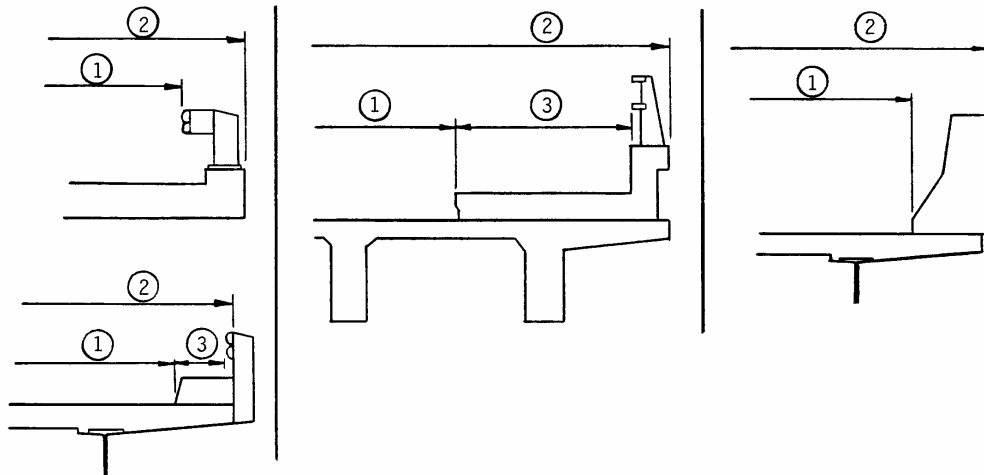

$$① = ①a + ①b + ①c$$

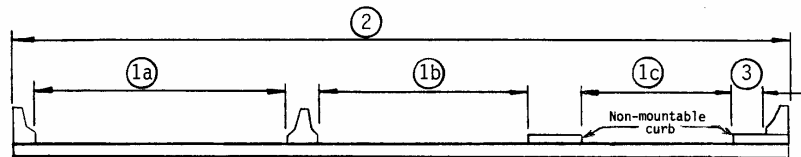

$$① = ①a + ①b + ①c$$

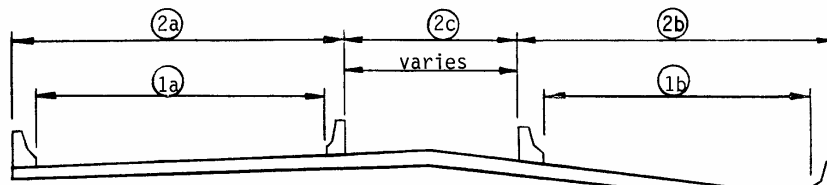

$$① = ①a + ①b$$

$$② = ②a + ②b + ②c$$

- 1) Item 51 - Bridge Roadway Width, Curb-to-Curb
- 2) Item 52 - Deck Width, Out-to-Out
- 3) Item 50 - Curb or Sidewalk Width

Item 53 - Minimum Vertical Clearance Over Bridge Roadway

(Ft Ft-In In)

Record using up to 4 digits representing feet and inches, the actual minimum vertical clearance over the bridge roadway, including shoulders, to any superstructure restriction, rounded down to the nearest inch. For double decked structures record the minimum, regardless whether it is pertaining to the top or bottom deck. When no superstructure restriction exists above the bridge roadway, or when a restriction is 100 feet or greater, record 99-99.

EXAMPLES:

<u>Minimum Vertical Clearance</u>	<u>Record</u>
No restriction	99-99
18'-03"	18-03
14'-04"	14-04
150'-00"	99-99

Item 54 - Minimum Vertical Underclearance

LEFT(X) code, (Ft Ft-In In), RIGHT(X) code, (Ft Ft-In In)

For the left and right openings record the reference feature and the minimum vertical clearance from the roadway (travel lanes only) or railroad track beneath the structure to the underside of the superstructure. (When both a railroad and highway are under the structure, record the most critical dimension.)

<u>Segment</u>	<u>Description</u>	<u>Length</u>
54A	Reference feature	1 digit
54B	Minimum Vertical Underclearance (left)	4 digits
54C	Reference feature	1 digit
54D	Minimum Vertical Underclearance (right)	4 digits

Using the codes below, code the reference feature from which the clearance measurement is taken:

<u>Code</u>	<u>Description</u>
H	Highway beneath structure
R	Railroad beneath structure
N	Feature not a highway or railroad

Item 54 - Minimum Vertical Underclearance (contd.)

Using up to 4 digits representing feet and inches, record the minimum vertical clearance from that feature to the structure, rounded down to the nearest inch. When a restriction is 100 feet or greater, record 99-99. If the feature is not a highway or railroad, leave blank.

Note: In Michigan the minimum underclearance is measured as the difference in elevation from the pavement to lowest overhead obstruction at a point 2 feet off the edge of pavement to compensate for vehicle overhang, unless the underclearance at some point on the pavement is less.

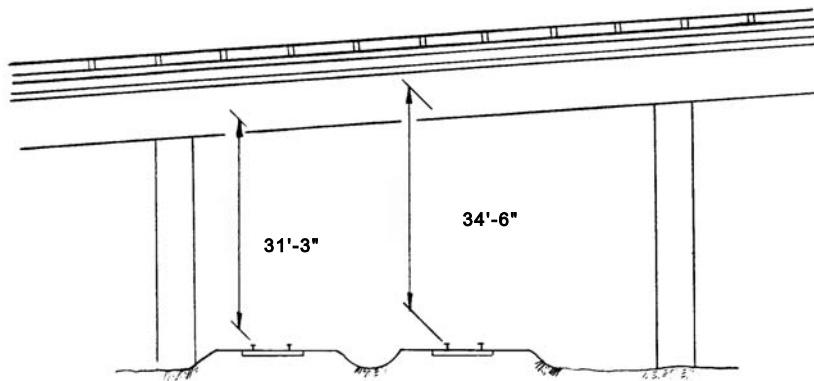

EXAMPLES:

Railroad, 31'-3" & 34'-6" beneath structure	<u>Left</u> R 31-03	<u>Right</u> R 34-06
---	------------------------	-------------------------

Item 54 - Minimum Vertical Underclearance(contd.)

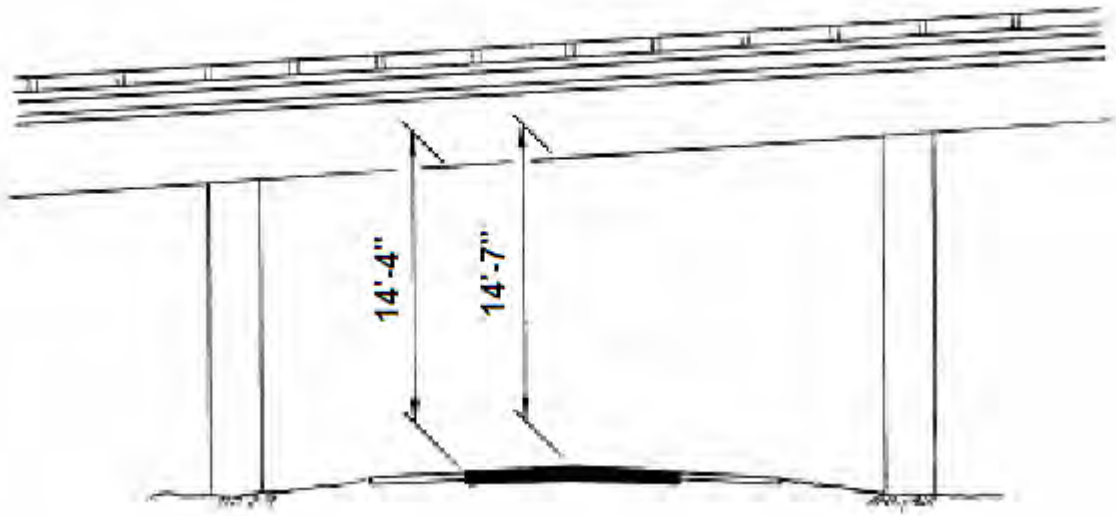

Highway, 14'-4" beneath structure

River, beneath structure

Left
H

Right
H 14-04

N

N

Item 55 - Minimum Lateral Underclearance on Right

(X) code, (XX.X) ft

Record the reference feature and the minimum lateral underclearance on the right. When both a railroad and highway are under the structure, record the most critical dimension (Refer to Item 69 - Underclearances, Horizontal - Table 3B).

<u>Segment</u>	<u>Description</u>	<u>Length</u>
55A	Reference feature	1 digit
55B	Minimum Lateral Underclearance	3 digits

Using the codes below, record in the reference feature from which the clearance measurement is taken:

<u>Code</u>	<u>Description</u>
H	Highway beneath structure
R	Railroad beneath structure
N	Feature not a highway or railroad

Using up to 3 digits, record the minimum lateral underclearance on the right to the nearest tenth of a foot. The lateral clearance should be measured from the right edge of the roadway (excluding shoulders) or from the centerline (between rails) of the right-hand track of a railroad to the nearest substructure unit (pier, abutment, etc.), to a rigid barrier (concrete bridge rail, etc.), or to the toe of slope steeper than 1:3, e.g., 1:1 or 2:1. The clearance measurements to be recorded will be the minimum after measuring the clearance in both directions of travel. For a dual highway this would mean the outside clearances of both roadways should be measured and the smaller distance recorded.

If two related features are below the bridge, measure both and record the lesser of the two. An explanation should be written on the inspection form of what was recorded. When the clearance is 100 feet or greater, record 99.9.

If the feature beneath the structure is not a railroad or highway, record N, and leave measurement blank to indicate not applicable.

The presence of ramps and acceleration or turning lanes is not considered in this item; therefore, the minimum lateral clearance on the right should be measured from the right edge of the through roadway.

EXAMPLES:

	<u>Record</u>
Railroad 20.4', centerline to pier	R 20.4
Highway 53.0', edge of pavement to pier	H 53.0
Creek beneath structure	N

See examples next page:

Item 55 - Minimum Lateral Underclearance on Right (contd.)

EXAMPLES:

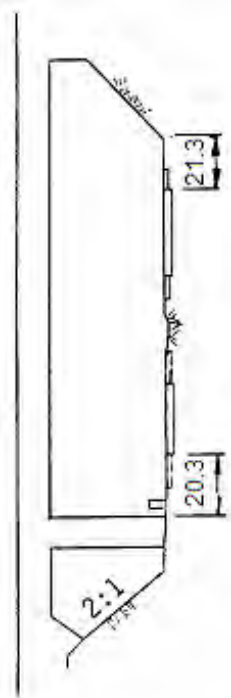

OPEN Lt. 20.3 Rt.

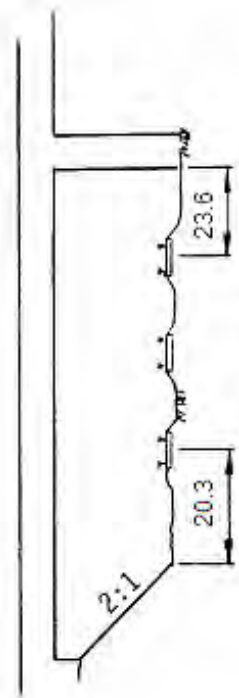

-- Lt. 20.3 Rt.

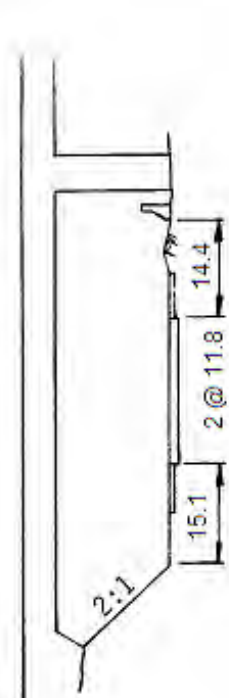

-- Lt. 14.4 Rt. for 2-Way Traffic
15.1 Lt. 14.4 Rt. for 1-Way Traffic

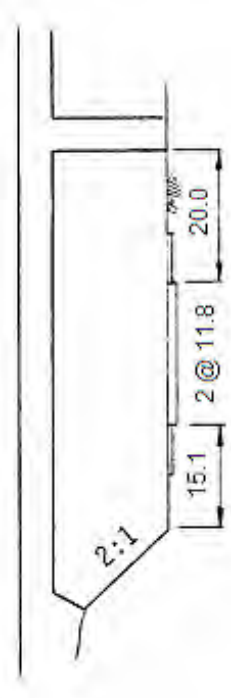

-- Lt. 15.1 Rt. for 2-Way Traffic
15.1 Lt. 20.0 Rt. for 1-Way Traffic

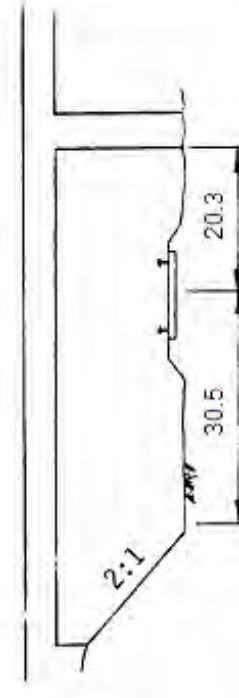

-- Lt. 20.3 Rt.

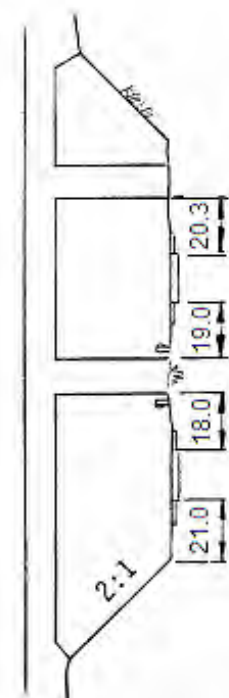

18.0 Lt. 20.3 Rt.

Item 56 - Minimum Lateral Underclearance on Left

(XX.X) ft

Record only for divided highways, 1-way streets, and ramps, not applicable to railroads.

Using up to 3 digits, record the minimum lateral underclearance on the left (median side for divided highways) to the nearest tenth of a foot. The lateral clearance should be measured from the left edge of the roadway (excluding shoulders) to the nearest substructure unit, to a rigid barrier, or to the toe of slope steeper than 1:3. Refer to examples on page 54 under Item 55 - Minimum Lateral Underclearance on Right.

For a dual highway, the median side clearances of both roadways should be measured and the smaller distance recorded. If no obstruction in the median area, a notation of "open" should be recorded and 99.9 should be recorded. For clearances greater than 100 feet, record 99.8. Record as blank to indicate not applicable.

Items 58 through 62 - Indicate the Condition Ratings

To promote uniformity between bridge inspectors, these guidelines will be used to rate and code Items 58, 59, 60, 61, and 62.

Condition ratings are used to describe the existing, in-place bridge as compared with the as-built condition. Evaluation is for the materials related, physical condition of the deck, superstructure, and substructure components of a bridge. The condition evaluation of channels and channel protection and culverts are also included. Condition codes are properly used when they provide an overall characterization of the general condition of the entire component being rated. Conversely, they are improperly used if they attempt to describe localized or nominally occurring instances of deterioration or disrepair. Correct assignment of a condition code must, therefore, consider both, the severity of the deterioration or disrepair and the extent to which it is widespread throughout the component being rated.

The load-carrying capacity will not be used in evaluating condition items. The fact that a bridge was designed for less than current legal loads and may be posted shall have no influence upon condition ratings.

Portions of bridges that are being supported or strengthened by temporary members will be rated based on their actual condition; that is, the temporary members are not considered in the rating of the item. (See Item 103 - Temporary Structure Designation for the definition of a temporary bridge.)

Condition Ratings (contd.)

The following general condition ratings shall be used as a guide in evaluating Items 58, 59, and 60:

<u>Code</u>	<u>Description</u>
N	NOT APPLICABLE
9	EXCELLENT CONDITION
8	VERY GOOD CONDITION - no problems noted.
7	GOOD CONDITION - some minor problems.
6	SATISFACTORY CONDITION - structural elements show some minor deterioration.
5	FAIR CONDITION - all primary structural elements are sound but may have minor section loss, cracking, spalling or scour.
4	POOR CONDITION - advanced section loss, deterioration, spalling or scour.
3	SERIOUS CONDITION - loss of section, deterioration, spalling or scour have seriously affected primary structural components. Local failures are possible. Fatigue cracks in steel or shear cracks in concrete may be present.
2	CRITICAL CONDITION - advanced deterioration of primary structural elements. Fatigue cracks in steel or shear cracks in concrete may be present or scour may have removed substructure support. Unless closely monitored closing the bridge may be necessary until corrective action is taken.
1	"IMMINENT" FAILURE CONDITION - major deterioration or section loss present in critical structural components or obvious vertical or horizontal movement affecting structure stability. Bridge is closed to traffic but corrective action may put back in light service.
0	FAILED CONDITION - out of service - beyond corrective action.

Item 58 - Deck

(X)

This item describes the overall condition rating of the deck. Rate and code the condition in accordance with the above general condition ratings. Code N for culverts and other structures without decks, e.g., filled arch bridge.

Concrete decks should be inspected for cracking, scaling, spalling, leaching, chloride contamination, potholing, delamination, and full or partial depth failures. Steel grid decks should be inspected for broken welds, broken grids, section loss, and growth of filled grids from corrosion. Timber decks should be inspected for splitting, crushing, fastener failure, and deterioration from rot.

The condition of the wearing surface/protective system, joints, expansion devices, curbs, sidewalks, parapets, fascias, bridge rail, and scuppers shall not be considered in the overall deck evaluation. However, their condition should be noted on the inspection form.

Decks integral with the superstructure will be rated as a deck only and not how they may influence the superstructure rating (i.e., rigid frame, slab, deck, girders or T-beams, voided slab, box girders, etc.). Similarly, the superstructure of an integral deck-type bridge will not influence the deck rating.

Item 58A - Deck Wearing Surface

(X)

This item is to evaluate and rate the condition of the deck surface only. The inspector must note in the comment field on the Bridge Safety Inspection Report (BIR) Item 1, if he / she is rating the structural deck surface or a protective wearing surface (ie, thin epoxy, wood, bituminous or, latex overlay). Refer to SI&A item 108 "Wearing Surface / Protective System" for type of wearing surface. If there is no protective wearing surface, rate the condition of the surface of the structure deck.

A concrete or bituminous wearing surface should be inspected for spalling, cracking, scaling, and delamination. Timber wearing surfaces should be inspected for deterioration, splitting, and crushing. Rate and code the condition in accordance with the following ratings.

<u>Code</u>	<u>Description</u>
N	NOT APPLICABLE. Code N for culverts and other structures without decks, e.g., filled arch bridge.
9	NEW CONDITION. No noticeable or noteworthy deficiencies which affect the condition of the surface.
8	GOOD CONDITION. Minor cracking less than 1/32" wide (0.8mm) with no spalling, scaling or delamination.
7	GOOD CONDITION. Open cracks less than 1/16" wide (1.6mm) at a spacing of 10 ft or more, light shallow scaling allowed.
6	FAIR CONDITION. Surface has considerable number of open cracks greater than 1/16" wide (1.6mm) at a spacing of 5 ft or less. Surface area exhibits 2% or less of spalled or delaminated areas, including repaired areas. Medium scaling on the surface is 1/4" to 1/2" (6.4 mm to 13 mm) in depth.
5	FAIR CONDITION. Between 2% and 10% of the surface area is spalled or delaminated. There can be excessive cracking in the surface. Heavy scaling 1/2" to 1" in depth (13 mm to 26 mm) can be present. This includes repaired areas and/or areas in need of corrective action.
4	POOR CONDITION. Large areas of the surface, 10 - 25% is spalled or delaminated. This area includes repaired areas and/or areas in need of corrective action.
3	SERIOUS CONDITION. More than 25% of the surface area is spalled. This area includes repaired areas and/or areas in need of corrective action.
2	CRITICAL CONDITION. Emergency surface repairs required by the crews.
1	IMMINENT FAILURE CONDITION. Bridge is closed to traffic, but corrective action may put the bridge back in service.
0	FAILED CONDITION. Bridge closed.

Item 59 - Superstructure

(X)

This item describes the physical condition of all structural members. Rate and code the condition in accordance with the previously described general condition ratings (see page 55). Code N for all culverts.

The structural members should be inspected for signs of distress which may include cracking, deterioration, section loss, and malfunction and misalignment of bearings.

The condition of bearings, joints, paint system, etc. shall not be included in this rating, except in extreme situations, but should be noted on the inspection form.

On bridges where the deck is integral with the superstructure, the superstructure condition rating may be affected by the deck condition. The resultant superstructure condition rating may be lower than the deck condition rating where the girders have deteriorated or been damaged.

Fracture critical components should receive careful attention because failure could lead to collapse of a span or the bridge.

Item 59A - Paint (Optional for local agencies)

(X)

This item is to evaluate and rate the condition of the paint only. The inspector must note in the comment field on the Bridge Safety Inspection Report (BIR) the type of paint or coating system (such as weathering steel or galvanized beams) and the year that the paint was applied.

<u>Code</u>	<u>Description</u>
N	NOT APPLICABLE. Code N for concrete super-structures, A-588 Weathering Steel super-structures, and galvanized beams.
9	NEW CONDITION. No deficiencies in the coating which will affect its long term performance.
8	GOOD CONDITION. Minor weathering of the coating and/or dirt contamination.
7	GOOD CONDITION. Minor pinhead size failures of the coating in scattered locations or on sharp edges.
6	FAIR CONDITION. Minor coating failures in scattered locations with a total area of less than 1%.
5	FAIR CONDITION. Moderate coating failures between 1% and 5% of the surface area. If areas of paint failure are concentrated under open joints, consideration may be given to zone painting.
4	POOR CONDITION. Large areas of coating failures, between 5% and 15% of the total surface. If areas of paint failure are concentrated under open joints, consideration may be given to zone painting. Otherwise, schedule for complete repainting when coating failure has progressed beyond 15%.
3	SERIOUS CONDITION. More than 15% of the coating has failed. Structure should be scheduled for complete repaint.
2	CRITICAL CONDITION. More than 50% of the coating has failed. Structure should be scheduled for complete repaint.
1	IMMINENT FAILURE CONDITION. Bridge is closed to traffic, but corrective action may put the bridge back in service.
0	FAILED CONDITION. Bridge closed.

Item 60 - Substructure

(X)

This item describes the physical condition of piers, abutments, piles, fenders, footings, or other components. Rate and code the condition in accordance with the previously described general condition ratings. Code N for all culverts.

All substructure elements should be inspected for visible signs of distress including evidence of cracking, section loss, settlement, misalignment, scour, collision damage, and corrosion. The rating factor given to Item 60 should be consistent with the one given to Item 113 whenever a rating factor of 2 or below is determined for Item 113 - Scour Critical Bridges.

The substructure condition rating shall be made independent of the deck and superstructure.

Integral-abutment wingwalls to the first construction or expansion joint shall be included in the evaluation. For non-integral superstructure and substructure units, the substructure shall be considered as the portion below the bearings. For structures where the substructure and superstructure are integral, the substructure shall be considered as the portion below the superstructure.

Item 61 - Channel and Channel Protection

(X)

This item describes the physical conditions associated with the flow of water through the bridge, such as stream stability and the condition of the channel, riprap, slope protection, or stream control devices including spur dikes. The inspector should be particularly concerned with visible signs of excessive water velocity which may effect undermining of slope protection, erosion of banks, and realignment of the stream which may result in immediate or potential problems. Accumulation of drift and debris on the superstructure and substructure should be noted on the inspection form but not included in the condition rating.

Rate and code the condition in accordance with the following descriptive codes:

<u>Code</u>	<u>Description</u>
N	Not applicable. Use when bridge is not over a waterway (channel).
9	No noticeable or noteworthy deficiencies affect the condition of the channel.
8	Banks are protected or well vegetated. River control devices such as spur dikes and embankment protection are not required or are in a stable condition.
7	Bank protection is in need of minor repairs. River control devices and embankment protection have a little minor damage. Banks and/or channel, have minor amounts of drift.
6	Bank is beginning to slump. River control devices and embankment protection have widespread minor damage. Minor stream bed movement is evident. Debris is restricting the channel slightly.
5	Bank protection is being eroded. River control devices and/or embankment have major damage. Trees and brush restrict the channel.
4	Bank and embankment protection is severely undermined. River control devices have severe damage. Large deposits of debris are in the channel.
3	Bank protection has failed. River control devices have been destroyed. Stream bed, aggradation, degradation or lateral movement has changed the channel to threaten the bridge and/or approach roadway now.
2	The channel has changed to the extent the bridge is near a state of collapse.
1	Bridge closed because of channel failure. Corrective action may put back in light service.
0	Bridge closed because of channel failure. Replacement necessary.

Item 62 - Culverts

(X)

This item evaluates the alignment, settlement, joints, structural condition, scour, and other items associated with culverts. The rating code is intended to be an overall condition evaluation of the culvert. Integral wingwalls to the first construction or expansion joint shall be included in the evaluation. For a detailed discussion regarding the inspection and rating of culverts, consult Report No. FHWA-IP-86-2, Culvert Inspection Manual, July 1986.

Item 58 - Deck, Item 59 - Superstructure, Item 59A - Paint and Item 60 - Substructure shall be coded N for all culverts.

Rate and code the condition in accordance with the following descriptive codes:

<u>Code</u>	<u>Description</u>
N	Not applicable. Use if structure is not a culvert.
9	No deficiencies.
8	No noticeable or noteworthy deficiencies which affect the condition of the culvert. Insignificant scrape marks caused by drift.
7	Shrinkage cracks, light scaling, and insignificant spalling which does not expose reinforcing steel. Insignificant damage caused by drift, with no misalignment and not requiring corrective action. Some minor scouring has occurred near curtain walls, wingwalls, or pipes. Metal culverts have a smooth symmetrical curvature with superficial corrosion and no pitting.
6	Deterioration or initial disintegration, minor chloride contamination, cracking with some leaching, or spall on concrete or masonry walls and slabs. Local minor scouring at curtain walls, wingwalls, or pipes. Metal culverts have a smooth curvature, non-symmetrical shape, significant corrosion or moderate pitting.
5	Moderate to major deterioration or disintegration, extensive cracking and leaching, or spall on concrete or masonry walls and slabs. Minor settlement or misalignment. Noticeable scouring or erosion at curtain walls, wingwalls, or pipes. Metal culverts have significant distortion and deflection in one section, significant corrosion or deep pitting.

(codes continued on the next page)

Item 62 - Culverts (contd.)

- 4 Large spall, heavy scaling, wide cracks, considerable efflorescence, or opened construction joint permitting loss of backfill. Considerable settlement or misalignment. Considerable scouring or erosion at curtain walls, wingwalls or pipes. Metal culverts have significant distortion and deflection throughout, extensive corrosion or deep pitting.
- 3 Any condition described in Code 4 but is excessive in scope. Severe movement or differential settlement of the segments, or loss of fill. Holes may exist in walls or slabs. Integral wingwalls nearly severed from culvert. Severe scour or erosion at curtain walls, wingwalls or pipes. Metal culverts have extreme distortion and deflection in one section, extensive corrosion, or deep pitting with scattered perforations.
- 2 Integral wingwalls collapsed, severe settlement of roadway due to loss of fill. Section of culvert may have failed and can no longer support embankment. Complete undermining at curtain walls and pipes. Corrective action required to maintain traffic. Metal culverts have extreme distortion and deflection throughout with extensive perforations due to corrosion.
- 1 Bridge closed. Corrective action may put back in light service.
- 0 Bridge closed. Replacement necessary.

Item 63 - Method Used to Determine Operating Rating

Use the codes below to indicate which load rating method was used to determine the Operating Rating coded in Item 64F for this structure.

Code	Description
0**	Field Evaluation and documented engineering judgment reported in metric tons using MS18 loading.
1	Load Factor Rating (LFR) reported in metric tons using MS18 loading.
2	Allowable Stress Rating (ASR) reported in metric tons using MS18 loading.
3*	Load and Resistant Factor Rating (LRFR) reported in metric tons using equivalent MS18 loading.
4	Load testing reported in metric tons using equivalent MS18 loading.
5**	No rating analysis or evaluation performed.
6	Load Factor Rating (LFR) reported by rating factor method using MS18 loading.
7	Allowable Stress Rating (ASR) reported by rating factor method using MS18 loading.
8	Load and Resistance Factor Rating (LRFR) rating reported by rating factor method using HL-93 loadings
A	Assigned rating based on Load Factor Design (LFD) reported in metric tons
B	Assigned rating based on Allowable Stress Design (ASD) reported in metric tons
C	Assigned rating based on Load and Resistance Factor Design (LRFD) reported in metric tons
D	Assigned rating based on Load Factor Design (LFD) reported by rating factor using MS18 loading
E	Assigned rating based on Allowable Stress Design (ASD) reported by rating factor using MS18 loading
F	Assigned rating based on Load and Resistance Factor Design (LRFD) reported by rating factor using HL93 loading

* per the FHWA Memo Dated October 30, 2006 “The NBI Code of 3 for Items 63 and 65 will no longer be valid for new load ratings of new or existing bridges after October 1, 2010.”

** per the FHWA Memo Dated February 2, 2011 “Existing code 5 is clarified to only be used for bridges that have not been load rated or load rating documentation does not exist. Code 0 has been added for use when the load rating is determined by field evaluation and documented engineering judgment, typically done when plans are not available or severe deterioration exists. Field evaluation and engineering judgment ratings must be documented.

See FHWA memo dated September 29, 2011 (<http://www.fhwa.dot.gov/bridge/110929.cfm>) and for additional information regarding the use of Assigned Ratings.

Item 64F - Federal Operating Rating

(XX.XX) metric tons or rating factor

This capacity rating, referred to as the operating rating, will result in the maximum permissible load level to which the structure may be subjected for the vehicle type used in the rating.

The data entry is dependent upon the method used to determine the operating rating, Item 63. When Item 63 is entered as 0, 1, 2, 3, or 4, A, B, or C, record the operating rating as a 4-digit number to represent the total mass in metric tons of the entire vehicle measured to the nearest hundredth of a metric ton. It should be emphasized that, when recording with metric tons, MS18 loading shall be used to determine the operating rating. This is the metric equivalent of an HS20 loading. The total mass in tons of the entire vehicle should be recorded; that is, MS18 which has a mass of 32.40 metric tons shall be recorded '32.40', and likewise, a MS13.5 shall be recorded '24.30'.

When Item 63 is entered as 6, 7, or 8, D, E, or F record the operating rating as a 4-digit number to the nearest hundredth to represent the rating factor for the appropriate loading (MS18 or HL-93).

The AASHTO Manual for Bridge Evaluation provides a choice of load rating methods, such as the Load and Resistance Factor Rating (LRFR) method, in addition to the traditional Allowable Stress Rating (ASR) and Load Factor Rating (LFR) methods. Of the three rating methods, the LRFR method is the now the national standard chosen by FHWA. However, the methods allowed for use varies depending upon the method of design, the date of design and the NHS status of the structure. Please refer to the FHWA memo dated October 30, 2006 (<http://www.fhwa.dot.gov/bridge/nbis/103006.cfm>) for allowable methods. The highway agencies may elect to use LFR, ASR or LRFR to establish load limits for purposes of load posting.

If the bridge will not carry a minimum of 2.70 metric tons of live load, the operating rating shall be recorded 00.00; and consistent with the direction of the AASHTO Manual, it shall be closed.

The use or presence of a temporary bridge requires special consideration in recording. In such cases, since there is no permanent bridge, Items 64 and 66 should be recorded as 00.00, though the temporary structure is rated for as much as full legal load.

A bridge shored up or repaired on a temporary basis is considered a temporary bridge and the inventory and operating rating shall be recorded as if the temporary shoring were not in place. See Item 103 - Temporary Structure Designation for definition of a temporary bridge.

Record 99.99 for a structure under sufficient fill such that, according to AASHTO design, the live load is insignificant in the structure load capacity.

EXAMPLES:	<u>Record</u>
MS27	48.60
Temporary bridge	00.00
Shored-up bridge	03.00 *
Structure under fill (not affected by live load)	99.99

* load capacity without shoring.

Item 64MA - Michigan Operating Rating Method

(X) Method

Use the codes below to indicate which load rating method was used to determine the Michigan Operating Rating coded in Item 64MB for this structure.

<u>Code</u>	<u>Description</u>
0	Field Evaluation and documented engineering judgment reported by rating factor method using equivalent legal loading.
1*	Load Factor Rating (LFR) reported in U.S. tons.
2*	Allowable Stress Rating (ASR) reported in U.S. tons.
3*	Load and Resistant Factor Rating (LRFR) reported in U.S. tons.
4	Load testing reported in U.S. tons using equivalent legal loading.
5	No rating analysis or evaluation performed.
6	Load Factor Rating (LFR) reported by rating factor method.
7	Allowable Stress Rating (ASR) reported by rating factor method.
8	Load and Resistance Factor Rating (LRFR) rating reported by rating factor method.
A*	Assigned rating based on Load Factor Design (LFD) reported in U.S tons.
B*	Assigned rating based on Allowable Stress Design (ASD) reported in U.S. tons.
C*	Assigned rating based on Load and Resistance Factor Design (LRFD) reported in U.S. tons.
D	Assigned rating based on Load Factor Design (LFD) reported by rating factor using equivalent legal loading
E	Assigned rating based on Allowable Stress Design (ASD) reported by rating factor using equivalent legal loading.
F	Assigned rating based on Load and Resistance Factor Design (LRFD) reported by rating factor using equivalent legal loading.

* Not the preferred methods.

There are multiple configurations of Michigan Legal Loads, as given in the Michigan Bridge Analysis Guide. Due to this, reporting in U.S. tons does not give a clear picture of the posting status of a bridge without investigating which truck is controlling. The vehicle that produces the lowest rating factor is the correct vehicle to use for reporting the

Michigan Operating Rating.

Any accepted methodology (ASR, LFR, LRFR, load test, field evaluation, or assigned) may be used to compute this rating. See the latest edition of the Michigan Bridge Analysis Guide for more information on computing and reporting this item.

See FHWA memo dated September 29, 2011 (<http://www.fhwa.dot.gov/bridge/110929.cfm>) for additional information regarding the use of Assigned Ratings. Please note that the engineer performing the assigned rating is responsible for performing a verification confirming that the design loading exceeds load effects of all legal configurations for the structure.

Item 64MB - Michigan Operating Rating

(XXX.XX) U.S. tons or rating factor

This capacity rating, referred to as the Michigan operating rating, will result in the maximum permissible load level to which the structure may be subjected for the vehicle type used in the rating. This item follows the operating rating as explained in Section 6.0 of the AASHTO Manual for Bridge Evaluation.

The data entry is dependent upon the method used to determine the operating rating, Item 64MA.

- When Item 64MA is entered as 1, 2, 3, 4, A, B, or C record the operating rating as a 5-digit number to represent the total weight in U.S. tons of the entire vehicle measured to the nearest hundredth of a U.S. ton. Methods 1, 2, 3, A, B and C are not the preferred means of coding the Michigan Operating Rating.
- When Item 64MA is entered as 0, 6, 7, 8, D, E, or F record the operating rating as a 5-digit number to represent the rating factor for the appropriate loading to the nearest hundredth (the controlling legal load as indicated in Item 64MC).

The AASHTO Manual for Bridge Evaluation provides a choice of load rating methods, such as the Load and Resistance Factor Rating (LRFR) method, in addition to the traditional Allowable Stress Rating (ASR) and Load Factor Rating (LFR) methods. Of the three rating methods, the LRFR method is now the national standard chosen by FHWA. The highway agencies may elect to use LFR, ASR or LRFR to establish load limits for purposes of load posting.

If the bridge will not carry a minimum of 3.0 U.S. tons of live load, the operating rating shall be recorded 00.00; and consistent with the direction of the AASHTO Manual, it shall be closed. Where the rating factor is less than 1, the bridge shall be posted.

A bridge shored up or repaired on a temporary basis is considered a temporary bridge and the inventory and operating rating shall be recorded as if the temporary shoring were not in place. See Item 103 - Temporary Structure Designation for definition of a temporary bridge.

When Item 64MA is entered as 6, 7, or 8 record 99.99 for a structure under sufficient fill such that, according to AASHTO design, the live load is insignificant in the structure load capacity.

EXAMPLES:	<u>Record</u>
When Item 64MA is entered as 1, 2, 3, 4, A, B or C	
Temporary bridge	00.00
Shored-up bridge	03.00 *
Structure under fill (not affected by live load)	99.99
When Item 64MA is entered as 0, 6, 7 8, D, E, or F	
Temporary bridge	1.00
Shored-up bridge	0.75 *
Structure under fill (not affected by live load)	99.99

* load capacity without shoring.

Item 64MC - Michigan Operating Vehicle

(XX) Legal Vehicle

28 Standard Michigan Legal Loads are identified in Chapter 2 of the Michigan Bridge Analysis Guide. The vehicle that controls may depend upon the span length, the controlling limit state and the type of structure. Chapter 2 of the Michigan Bridge Analysis Guide also provides recommendations for which vehicles are recommended for analysis. The vehicle that produces the lowest rating factor, **NOT** the lowest rating in U.S. tons, should be used to calculate and record Items 64MB and 64MC.

Item 65 - Method Used to Determine Inventory Rating

Use the codes below to indicate which load rating method was used to determine the Inventory Rating coded in Item 66 for this structure.

Code	Description
0**	Field Evaluation and documented engineering judgment reported in metric tons using MS18 loading.
1	Load Factor Rating (LFR) reported in metric tons using MS18 loading.
2	Allowable Stress Rating (ASR) reported in metric tons using MS18 loading.
3*	Load and Resistant Factor Rating (LRFR) reported in metric tons using equivalent MS18 loading.
4	Load testing reported in metric tons using equivalent MS18 loading.
5**	No rating analysis or evaluation performed.
6	Load Factor Rating (LFR) reported by rating factor method using MS18 loading.
7	Allowable Stress Rating (ASR) reported by rating factor method using MS18 loading.
8	Load and Resistance Factor Rating (LRFR) rating reported by rating factor method using HL-93 loadings
A	Assigned rating based on Load Factor Design (LFD) reported in metric tons.
B	Assigned rating based on Allowable Stress Design (ASD) reported in metric tons.
C	Assigned rating based on Load and Resistance Factor Design (LRFD) reported in metric tons.
D	Assigned rating based on Load Factor Design (LFD) reported by rating factor using MS18 loading.
E	Assigned rating based on Allowable Stress Design (ASD) reported by rating factor using MS18 loading.
F	Assigned rating based on Load and Resistance Factor Design (LRFD) reported by rating factor using HL93 loading.

* per the FHWA Memo Dated October 30, 2006 “The NBI Code of 3 for Items 63 and 65 will no longer be valid for new load ratings of new or existing bridges after October 1, 2010.”

** per the FHWA Memo Dated February 2, 2011 “Existing code 5 is clarified to only be used for bridges that have not been load rated or load rating documentation does not exist. Code 0 has been added for use when the load rating is determined by field evaluation and documented engineering judgment, typically done when plans are not available or severe deterioration exists. Field evaluation and engineering judgment ratings must be documented.

See FHWA memo dated September 29, 2011 (<http://www.fhwa.dot.gov/bridge/110929.cfm>) and for additional information regarding the use of Assigned Ratings.

Item 66 - Inventory Rating

(XX.XX) metric tons or rating factor

This capacity rating, referred to as the inventory rating, will result in a load level which can safely utilize an existing structure for an indefinite period of time. Only the MS18 or HL-93 loadings shall be used to determine the inventory rating.

The data entry is dependent upon the method used to determine the operating rating, Item 63. When Item 63 is entered as 0, 1, 2, 3, 4, A, B, or C, record the operating rating as a 4-digit number to represent the total weight in metric tons of the entire vehicle measured to the nearest hundredth of a metric ton. It should be emphasized that, when recording with metric tons, MS18 loading shall be used to determine the operating rating. This is the metric equivalent of an HS20 loading. The total mass in tons of the entire vehicle should be recorded; that is, MS18 which has a mass of 32.40 metric tons shall be recorded '32.4', and likewise, a MS13.5 shall be recorded '24.30'.

When Item 63 is entered as 6, 7, 8, D, E, or F, record the operating rating as a 4-digit number to the nearest hundredth to represent the rating factor for the appropriate loading (MS18 or HL-93).

The statements in Item 64 - Operating Rating, apply to this item also.

Items 67, 68, 69, 71, and 72 - Appraisal Ratings

The items in the Appraisal Section are used to evaluate a bridge in relation to the level of service which it provides on the highway system of which it is a part. The structure will be compared with a new one which is built to current standards for that particular type of road as further defined in this section, except Item 72 - Approach Roadway Alignment. See Item 72 for special criteria for rating that item.

Items 67, 68, 69, 71, and 72 will be coded with a 1 digit code that indicates the appraisal rating for the item. The ratings and codes are as follows:

<u>Code</u>	<u>Description</u>
N	Not applicable
9	Superior to present desirable criteria
8	Equal to present desirable criteria
7	Better than present minimum criteria
6	Equal to present minimum criteria
5	Somewhat better than minimum adequacy to tolerate being left in place as is
4	Meets minimum tolerable limits to be left in place as is
3	Basically intolerable requiring high priority of corrective action
2	Basically intolerable requiring high priority of replacement
1	This value of rating code not used
0	Bridge closed

The FHWA Edit/Update computer program calculates values for Items 67, 68 and 69 and cannot be coded by the bridge inspector. The table for Item 71 shall be used by all evaluators to rate this item. They have been developed to closely match the descriptions for the appraisal evaluation codes of 0 to 9. The tables shall be used in all instances to evaluate the item based on the designated data in the inventory, even if a table value does not appear to match the descriptive codes. For unusual cases where the site data does not exactly agree with the table criteria, use the most appropriate table to evaluate the item. The code of N is not valid for use Item 72.

Completed bridges not yet opened to traffic, if rated, shall be appraised as if open to traffic. Design values, for example ADT, shall be used for the evaluation. The data provided will include a code of G for Item 41 - Structure Open, Posted, or Closed to Traffic.

Item 67 - Structural Evaluation

This item is calculated by the Edit/Update Program and cannot be coded by the bridge inspector.

Item 68 - Deck Geometry

This item is calculated by the Edit/Update Program and need not be coded by the bridge inspector.

Item 69 - Under clearances, Vertical and Horizontal

This item is calculated by the Edit/Update Program and cannot be coded by the bridge inspector.

Item 70 - Bridge Posting

(X)

The National Bridge Inspection Standards require the posting of load limits only if the maximum legal load configurations in the State exceeds the load permitted under the operating rating. If the load capacity at the operating rating is such that posting is required, this item shall be coded 4 or less. If no posting is required at the operating rating, this item shall be coded 5.

This item evaluates the load capacity of a bridge in comparison to the State legal load. It differs from Item 67 - Structural Evaluation in that Item 67 uses Item 66 - Inventory Rating, while the bridge posting requirement is based on Item 64M - Michigan Operating Rating.

Although posting a bridge for load-carrying capacity is required only when the maximum legal load exceeds the operating rating, highway agencies may choose to post at a lower level. This posting practice may appear to produce conflicting coding when Item 41 - Structure Open, Posted or Closed to Traffic is coded to show the bridge as actually posted at the site and Item 70 - Bridge Posting is coded as bridge posting is not required. Since different criteria are used for coding these 2 items, this coding is acceptable and correct when the highway agency elects to post at less than the operating rating. Item 70 shall be coded 4 or less only if the legal load of the State exceeds that permitted under the operating rating.

The use or presence of a temporary bridge affects the coding. The actual operating rating of the temporary bridge should be used to determine this item. However, the highway agency may choose to post at a lower level. This also applies to bridges shored up or repaired on a temporary basis.

<u>Code</u>	<u>Description</u>
4 or less	Posting required
5	No posting required

The degree that the operating rating is less than the maximum legal load level may be used to differentiate between codes. As a guide and for coding purposes only, the following values may be used to code this item. Note: loads are given in **U.S.** tons

Code	77 Ton Mich Vehicle	42 Ton Mich Vehicle	HS Truck
5	≥ 77 tons	≥ 42 tons	≥ 36 tons
4	69.4 - 76.9 tons	37.8 - 41.9 tons	32.4 - 35.9 tons
3	61.7 - 69.3 tons	33.6 - 37.7 tons	28.8 - 32.1 tons
2	54.0 - 61.6 tons	29.4 - 33.5 tons	25.2 - 28.7 tons
1	53.9 - 46.3 tons	25.2 - 29.3 tons	21.6 - 25.1 tons
0	< 46.3 tons	< 25.2 tons	< 21.6 tons

Item 71 - Waterway Adequacy

(X)

This item appraises the waterway opening with respect to passage of flow through the bridge. The following codes shall be used in evaluating waterway adequacy (interpolate where appropriate). Site conditions may warrant somewhat higher or lower ratings than indicated by the table (e.g., flooding of an urban area due to a restricted bridge opening).

Where overtopping frequency information is available, the descriptions given in the table for chance of overtopping mean the following:

- Remote - greater than 100 years
- Slight - 11 to 100 years
- Occasional - 3 to 10 years
- Frequent - less than 3 years

Adjectives describing traffic delays mean the following:

- Insignificant - Minor inconvenience. Highway passable in a matter of hours.
- Significant - Traffic delays of up to several days.
- Severe - Long term delays to traffic with resulting hardship.

Functional Classification

Principal Arterials - Interstates, Freeways, or Expressways	Other Principal and Minor Arterials and Major Collectors	Minor Collectors, Locals	Description
			<u>Code</u>
N	N	N	Bridge not over a waterway.
9	9	9	Bridge deck and roadway approaches above flood water elevations (high water). Chance of overtopping is remote.
8	8	8	Bridge deck above roadway approaches. Slight chance of overtopping roadway approaches.
6	6	7	Slight chance of overtopping bridge deck and roadway approaches.
4	5	6	Bridge deck above roadway approaches. Occasional overtopping of roadway approaches with insignificant traffic delays.

Item 71 - Waterway Adequacy (contd.)

Principal Arterials - Interstates, Freeways, or Expressways	Other Principal and Minor Arterials and Major Collectors	Minor Collectors, Locals	Description Code
3	4	5	Bridge deck above roadway approaches. Occasional overtopping of roadway approaches with significant traffic delays.
2	3	4	Occasional overtopping of bridge deck and roadway approaches with significant traffic delays.
2	2	3	Frequent overtopping of bridge deck and roadway approaches with significant traffic delays.
2	2	2	Occasional or frequent overtopping of bridge deck and roadway approaches with severe traffic delays.
0	0	0	Bridge closed.

Item 72 - Approach Roadway Alignment

(X)

Code the rating based on the adequacy of the approach roadway alignment. This item identifies those bridges which do not function properly or adequately due to the alignment of the approaches. It is not intended that the approach roadway alignment be compared to current standards but rather to the existing highway alignment. This concept differs from other appraisal evaluations. The establishment of set criteria to be used at all bridge sites is not appropriate for this item. The basic criteria is how the alignment of the roadway approaches to the bridge relate to the general highway alignment for the section of highway the bridge is on.

The individual structure shall be rated in accordance with the general appraisal rating guide described on page 67 in lieu of specific design values. The approach roadway alignment will be rated, intolerable (a code of 3 or less) only if the horizontal or vertical curvature requires a substantial reduction in the vehicle operating speed from that on the highway section. A very minor speed reduction will be rated a 6, and when a speed reduction is not required, the appraisal code will be an 8. Additional codes may be selected between these general values.

Item 72 - Approach Roadway Alignment (contd.)

For example, if the highway section requires a substantial speed reduction due to vertical or horizontal alignment, and the roadway approach to the bridge requires only a very minor additional speed reduction at the bridge, the appropriate code would be a 6. This concept shall be used at each bridge site.

Necessary speed reductions, because of structure width and not alignment, shall not be considered in evaluating this item.

Item 75 - Type of Work

Type (XX), Work done by (X)

The information to be coded for this item will be the type of work proposed to be accomplished on the structure to improve it to the point that it will provide the type of service needed and whether the proposed work is to be done by contract or force account. Code a 3-digit number composed of 2 segments.

<u>Segment</u>	<u>Description</u>	<u>Length</u>
75A	Type of Work Proposed	2 digits
75B	Work Done by	1 digit

This item must be coded for bridges eligible for the Highway Bridge Replacement and Rehabilitation Program. To be eligible, a bridge must carry highway traffic, be deficient and have a sufficiency rating of 80.0 or less. This item may be coded for other bridges at the option of the highway agency. Use the following codes to represent the proposed work type. Otherwise, leave blank.

Item 75 - Type of Work (contd.)

<u>Code</u>	<u>Description</u>
31	Replacement of bridge or other structure because of substandard load carrying capacity or substandard bridge roadway geometry.
32	Replacement of bridge or other structure because of relocation of road.
33	Widening of existing bridge or other major structure without deck rehabilitation or replacement; includes culvert lengthening.
34	Widening of existing bridge with deck rehabilitation or replacement.
35	Bridge rehabilitation because of general structure deterioration or inadequate strength.
36	Bridge deck rehabilitation with only incidental widening.
37	Bridge deck replacement with only incidental widening.
38	Other structural work, including hydraulic replacements.

If segment A is blank, leave segment B blank. Otherwise, the third digit shall be coded using the following codes to indicate whether the proposed work is to be done by contract or by force account:

<u>Code</u>	<u>Description</u>
1	Work to be done by contract
2	Work to be done by owner's forces

(Examples on the next page)

Item 75 - Type of Work (contd.)

EXAMPLES:

Code

A bridge is to be replaced by contract because it has deteriorated to the point that it can no longer carry legal loads. The same code should be used if the bridge is replaced because it is now too narrow or the original design was too light to accommodate today's legal loads. 311

A bridge is to be replaced because the roadway must be straightened to eliminate a dangerous curve. The work will be done by contract. 321

A bridge is to be widened to increase shoulder width or the number of traffic lanes. The existing deck is in good condition and will be incorporated as is into the new structure. The work is to be done by contract. 331

A culvert is to be extended by contract to accommodate additional roadway width as part of a reconstruction contract to improve the safety of the adjacent slopes. 331

A deck is to be rehabilitated and the bridge widened to provide a full 12 foot shoulder. The existing shoulder is only 4 feet wide and an extra line of girders with appropriate substructure widening must be added. The work will be done by contract. 341

A bridge superstructure and substructure are to be rehabilitated by State forces to increase the bridge's load capacity. 352

A bridge deck is to be rehabilitated by contract and a safety curb to be removed which results in incidental widening of 2 feet. 361

A bridge deck is to be replaced by contract and the deck cantilever overhang extended 2 feet, which is the maximum that can be done without adding another line of stringers or girders to the superstructure. 371

A bridge which is no longer needed is to be demolished and an at-grade crossing built by State forces. (This code could also be used to designate incidental safety work on a bridge such as bridge-rail upgrading or replacement.) 382

Item 76 - Length of Structure Improvement

(XXXXX.X) ft

Using up to 6 digits, record the length of the proposed bridge improvement to the nearest tenth of a foot. For replacement or rehabilitation of the entire bridge, the length should be back to back of backwalls of abutments or from pavement notch to pavement notch. For replacement or rehabilitation of only part of the structure, use the length of the portion to be improved. Leave blank if Item 73 is recorded "NNNN".

This item must be recorded for bridges eligible for the Highway Bridge Replacement and Rehabilitation Program. It may be recorded for other bridges at the option of the highway agency.

For culvert improvements, use the proposed length measured along the centerline of the barrel regardless of the depth below grade. The measurement should be made between the inside faces of the top parapet or edge-stiffening beam of the top slab.

For substructure or channel work only, record the length of superstructure over, or supported by, the substructure or channel.

Typically, a replacement bridge is longer than the existing bridge. Nationwide averages for the increase in bridge length with replacement as a function of the existing length are given in the following figures. The length-expansion factors represent data for the years 1981 to 1985. Where site-specific data is lacking, these factors are suggested for estimating the length of replacement bridges. For exceedingly long bridges (i.e., 1000 feet or more) the length-expansion factor approaches 1.0.

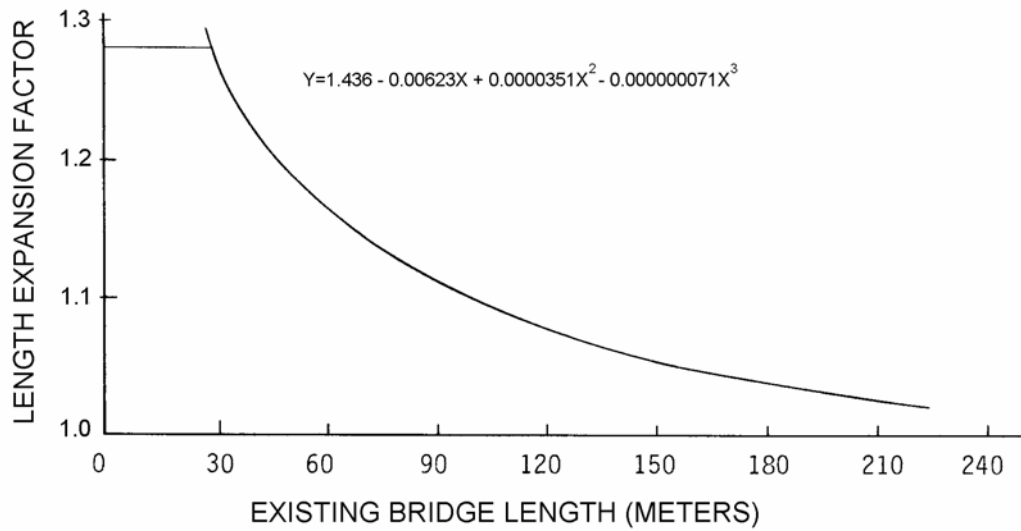
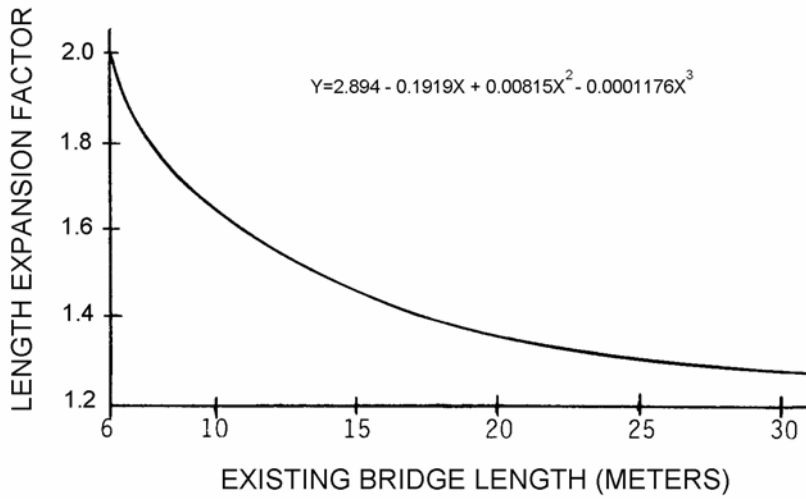

INCREASED LENGTH OF REPLACEMENT BRIDGES

X = EXISTING BRIDGE LENGTH
 Y = LENGTH EXPANSION FACTOR

REPLACEMENT BRIDGE LENGTH = EXISTING BRIDGE LENGTH x LENGTH EXPANSION FACTOR

Item 77 - Steel Type

(X)

Code the predominate type of steel used for the main structural members of the bridge as indicated.

<u>Code</u>	<u>Description</u>
0	Nonsteel structure
1	Carbon steel (A 7)(A 373)
2	Carbon Steel (A 36)
3	Alloy steel (A 441)
4	Alloy-weather (A 588 - A 441 mod.)
5	Alloy (A 572)

Item 78 - Paint Type

(X)

Code the type of paint or coating for the main structural members as shown.

<u>Code</u>	<u>Description</u>
0	Unpainted
1	Lead-base paint
2	Nonlead paint
3	Galvanized
4	Urethane
9	Unknown

Item 79 - Rail Type

(X)

Indicate with a one-digit code the type of railing carried on the structure.

<u>Bridge Railing Code</u>	<u>Railing Type (Michigan Standard No.)</u>
0	No railing or guardrail
1	Steel beam guard rail
2	Concrete or stone balustrades (square or round spindles)
3	Aluminum tubular railing with cast aluminum posts (R10, 2 or 3 tubes) R13 structural aluminum tube.
4	Steel or aluminum fabricated panels with concrete or steel posts (R1 to R9) or similar
5	Concrete girder or solid reinforced concrete panel (1919-35±)
6	Concrete parapet (open) (R11 or R12) or similar
7	Concrete parapet (solid R16) or similar
8	Concrete G.M. barrier (R15) or New Jersey (X17)
9	Other railing type

Item 80 - Rail Post Code (Optional for local agencies)

(X)

Rail type 0 (no rail)		
Rail type 1 (beam guardrail)		
unknown post	=	0
steel post	=	1
wooden post	=	2
Rail type 2 (balustrade rail)		
unknown condition	=	0
sound rail =	=	1
deteriorated rail	=	2
thrie beam ahead of post	=	5
curb riser	=	9
Rail type 3 (aluminum tube rail)		
unknown post	=	0
2 tube	=	2
3 tube	=	3
post 1970 tube	=	4
curb riser	=	9
Rail type 4 (post & panel rail)		
unknown post	=	0
aluminum post=	=	1
cast iron post	=	2
steel post	=	3
concrete post	=	4
thrie beam ahead of post	=	5
curb riser	=	9
Rail type 5 (solid wall)		
unknown treatment	=	0
thrie beam ahead of wall	=	5
curb riser	=	9
Rail type 6 (open parapet rail)		
unknown height	=	0
low height 1'10"	=	1
high height 2'3"	=	2
high height excess spacing	=	3
thrie beam ahead of post	=	5
curb riser	=	9
Rail type 7 (solid parapet rail)		
Rail type 8 (GM & NJ barrier rail)		
unknown	=	0
GM shape	=	1
NJ var. 1	=	2
NJ var. 2	=	3
NJ var. 3	=	4
Rail type 9 (unknown rail)		
unknown condition	=	0
sound rail =	=	1
deteriorated rail	=	2
thrie beam ahead of rail	=	5
curb riser	=	9

Item 90 - Inspection Date

(MMDDYYYY)

Record the month, day and year that the last routine inspection of the structure was performed. This inspection date may be different from those recorded in Item 93 - Critical Feature Inspection Date. Record a 8-digit number to represent the month, day and year. The number of the month should be recorded in the first 2 digits with a leading zero as required, the number of day in the next 2 digits with a leading zero as required and the year recorded in the last four digits of the field.

EXAMPLES:

Record

Inspection date	November 15, 2003	11/15/2003
	March 24, 2004	03/24/2004

Item 91 - Designated Inspection Frequency

(XX)

Using up to 2 digits, record the number of months between designated inspections of the structure. This interval is usually determined by the individual in charge of the inspection program. For posted, under strength bridges, this interval should be substantially less than the 24-month standard. The designated inspection interval could vary, depending on the condition of the bridge at the time of inspection.

If Item 41 is coded "B", "D", "E", "P" or "R" this Item should be less than 24 months.

EXAMPLES:

Record

Posted bridge with heavy truck traffic and questionable structural details which is designated to be inspected each month	1
Bridge is scheduled to be inspected every 24 months	24

It should be noted that bridges will also require special non-scheduled inspections after unusual physical traumas such as floods, earthquakes, fires or collisions. These special inspections may range from a very brief visual examination to a detailed in-depth evaluation depending upon the nature of the trauma. For example, when a substructure pier or abutment is struck by an errant vehicle, in most cases only a visual examination of the bridge is necessary. After major collisions or earthquakes, in-depth inspections may be warranted as directed by the engineer in overall charge of the program. After and during severe floods, the stability of the substructure of bridges may have to be determined by probing, underwater sensors or other appropriate measures. Underwater inspection by divers may be required for some scour critical bridges immediately after floods. See Item 113 - Scour Critical Bridges.

Item 92 - Critical Feature Inspection

(X) Y/N, (XX) months

For each of three segments, denote critical features that need special inspections or special emphasis during inspections and the designated inspection interval in months as determined by the individual in charge of the inspection program. The designated inspection interval could vary, depending on the condition of the bridge at the time of inspection.

<u>Segment</u>	<u>Description</u>	<u>Insp Needed</u>	<u>Insp Length</u>
92A	Fracture Critical Details	1 digit	2 digits
92B	Underwater Inspection	1 digit	2 digits
92C	Other Special Inspection	1 digit	2 digits

For each segment of Item 92A, B, and C, code the first digit Y for special inspection or emphasis needed and code N for not needed. The first digit of Item 92A, B, and C must be coded for all structures to designate either a yes or no answer. Those bridges coded with a Y in Item 92A or B should be the same bridges contained in the Master Lists of fracture critical and special underwater inspection bridges. In the second and third digits of each segment, record a 2-digit number to indicate the number of months between inspections only if the first digit is coded Y. If the first digit is coded N, the second and third digits are left blank.

Current guidelines for the maximum allowable interval between inspections can be summarized as follows:

Fracture Critical Details	24 months
Underwater Inspection	60 months
Other Special Inspections	60 months

EXAMPLES:

	<u>Item</u>	<u>Code</u>
A 2-girder system structure which is being inspected yearly and no other special inspections are required.	92A	Y 12
	92B	N ___
	92C	N ___
A structure where both fracture critical and underwater inspections are being performed on a 1-year interval. Other special inspections are not required.	92A	Y 12
	92B	Y 12
	92C	N ___
A structure has been temporarily shored and is being inspected on a 6-month interval. Other special inspections are not required.	92A	N ___
	92B	N ___
	92C	Y 06

Item 93 - Critical Feature Inspection Date

(MMYY)

Record only if the first digit of Item 92A, B, or C is coded Y for yes. For each of three segments, using 4 digits, record the month and year that the last inspection of the denoted critical feature was performed.

<u>Segment</u>	<u>Description</u>	<u>Length</u>
93A	Fracture Critical Details	4 digits
93B	Underwater Inspection	4 digits
93C	Other Special Inspection	4 digits

The number of the month should be recorded in the first 2 digits with a leading zero as required and the year should be recorded in the last 2 digits of the field. If the first digit of any part of Item 92 is coded N, then the corresponding part of this item shall be blank.

EXAMPLES:

	<u>Item</u>	<u>Record</u>
A structure has fracture critical members which were last inspected in March 1986. It does not require underwater or other special feature inspections.	93A	0386
	93B	(blank)
	93C	(blank)
A structure with no fracture critical details, but requires underwater inspection and has other special features (for example, a temporary support) for which the State requires special inspection. The last underwater inspection was done in April 1986 and the last special feature inspection was done in November 1985.	93A	(blank)
	93B	0486
	93C	1185

Item 94 - Bridge Improvement Cost

(XXXXXX)

Using up to 6 digits, record the estimated cost of the proposed bridge or major structure improvements in thousands of dollars. This cost shall include only bridge construction costs, excluding roadway, right of way, detour, demolition, preliminary engineering, etc. Record the base year for the cost in Item 97 - Year of Improvement Cost Estimate. Do not use this item for estimating maintenance costs.

This item must be recorded for bridges eligible for the Highway Bridge Replacement and Rehabilitation Program. It may be recorded for other bridges at the option of the highway agency. Leave blank if not applicable

EXAMPLES:

		<u>Record</u>
Bridge Improvement Cost	\$ 55,850	56
	250,000	250
	7,451,233	451
	Not Applicable	

Nationally, the deck area of replaced bridges is averaging 2.2 times the deck area before replacement. The deck area of rehabilitated bridges is averaging 1.5 times the deck area before rehabilitation. Widening square meter costs are typically 1.8 times the square meter cost of new bridges with similar spans. For example, if the average cost of a new bridge is \$50 per square foot, the average cost of the widened area would be \$90 per square foot.

Each highway agency is encouraged to use its best available information and established procedures to determine bridge improvement costs. In the absence of these procedures, the highway agency may wish to use the following procedure as a guide in preparing bridge improvement cost estimates.

Apply a construction unit cost to the proposed bridge area developed by using (1) current State deck geometry design standards and (2) proposed bridge length from Item 76 - Length of Structure Improvement.

Contact MDOT Design Division Local Agency Programs for current unit cost.

Item 95 - Roadway Improvement Cost

(XXXXXX)

Using up to 6-digits, record the estimated cost of the proposed roadway improvement in thousands of dollars. This shall include only roadway construction costs, excluding bridge, right-of-way, detour, extensive roadway realignment costs, preliminary engineering, etc. Record the base year for the cost in Item 97 - Year of Improvement Cost Estimate. Do not use this item for estimating maintenance costs. Leave blank if not applicable.

This item must be recorded for bridges eligible for the Highway Bridge Replacement and Rehabilitation Program. It may be recorded for other bridges at the option of the highway agency.

In the absence of a procedure for estimating roadway improvement costs, a guide of 10 percent of the bridge costs is suggested.

Item 96 - Total Project Cost

(XXXXXX)

Using up to 6-digits, record the proposed total project cost in thousands of dollars, including incidental costs not included in Items 94 and 95. This item should include all costs normally associated with the proposed bridge improvement project. The Total Project Cost will therefore usually be greater than the sum of Items 94 and 95. Record the base year for the cost in Item 97 - Year of Improvement Cost Estimate. Do not use this item for recording maintenance costs. Leave blank if not applicable.

This item must be recorded for bridges eligible for the Highway Bridge Replacement and Rehabilitation Program. It may be recorded for other bridges at the option of the highway agency.

In the absence of a procedure for estimating the total project cost, a guide of 150 percent of the bridge cost is suggested.

Item 97 - Year of Improvement Cost Estimate

(XXXX)

Record the year that the costs of work estimated in Item 94 - Bridge Improvement Cost, Item 95 - Roadway Improvement Cost, and Item 96 - Total Project Cost, were based upon. This date and the data provided for Item 94 through Item 96 must be current; that is, Item 97 shall be no more than 8 years old. Record all four digits of the year so recorded. Leave blank if not applicable.

EXAMPLES:

Year of Cost Estimate	1999 costs	<u>Record</u> 1999
	2003 costs	2003

Item 98 - Border Bridge

(XXXXX)

Use this item to indicate structures crossing borders of States. Code a 5-digit number composed of 2 segments specifying the percent responsibility for improvements to the existing structure when it is on a border with a neighboring State. Code the first 3 digits with the neighboring State code using State codes listed in Item 1 - State Code. Code the fourth and fifth digits with the percentage of total deck area of the existing bridge that the neighboring State is responsible for funding.

<u>Segment</u>	<u>Description</u>	<u>Length</u>
98A	Neighboring State Code	3 digits
98B	Percent Responsibility	2 digits

If a neighboring State codes the structure and accepts 100% of the responsibility, but your State still codes a record for the structure, then Item 98B in your State's record should be coded 99 to represent that your State has no responsibility for the structure.

For the special case of a structure on the border with Canada, code the State code value = CAN. If structure is not on a border, leave blank.

EXAMPLES:

	<u>Code</u>
A structure connects Michigan with Wisconsin and Wisconsin is responsible for funding 45 percent of future improvement costs.	55545
A structure connects Michigan with Canada and Canada is not responsible for any funding of future improvement costs.	CAN00

Codes for states bordering Michigan are:

Indiana	185
Ohio	395
Wisconsin	555

Item 99 - Border Bridge Structure Number (Entered by Bridge Management Unit)

Code the neighboring State's 15-digit National Bridge Inventory structure number for any structure noted in Item 98 - Border Bridge. This number must match exactly the neighboring State's submitted NBI structure number. The entire 15-digit field must be accounted for including zeros and blank spaces whether they are leading, trailing, or embedded in the 15-digit field. If Item 98 is blank, this item is blank.

In the above example where Canada (or a neighboring State) has 00% responsibility, and, if there is no NBI Structure Number in that State's inventory file, then the entire 15-digit field shall be coded zeroes.

Item 100 - STRAHNET Highway Designation

(X)

This item shall be coded for all records in the inventory. For the purposes of this item, the STRAHNET Connectors are considered included in the term STRAHNET (See Appendix D). For the inventory route identified in Item 5, indicate STRAHNET highway conditions using the following codes:

<u>Code</u>	<u>Description</u>
0	The inventory route is not a STRAHNET route.
1	The inventory route is on an Interstate STRAHNET route.
2	The inventory route is a non-Interstate STRAHNET route.
3	The inventory route is on a STRAHNET connector route.

Item 101 - Parallel Structure Designation

(X)

Code this item to indicate situations where separate structures carry the inventory route in opposite directions of travel over the same feature. The lateral distance between structures has no bearing on the coding of this item. Use the following codes.

<u>Code</u>	<u>Description</u>
R	The right structure of parallel bridges carrying the roadway in the direction of the inventory. (For a STRAHNET highway, this is west to east and south to north.)
L	The left structure of parallel bridges. This structure carries traffic in the opposite direction.
N	No parallel structure exists.

EXAMPLE:

	<u>Code</u>
Structure #1	R
Structure #2	L

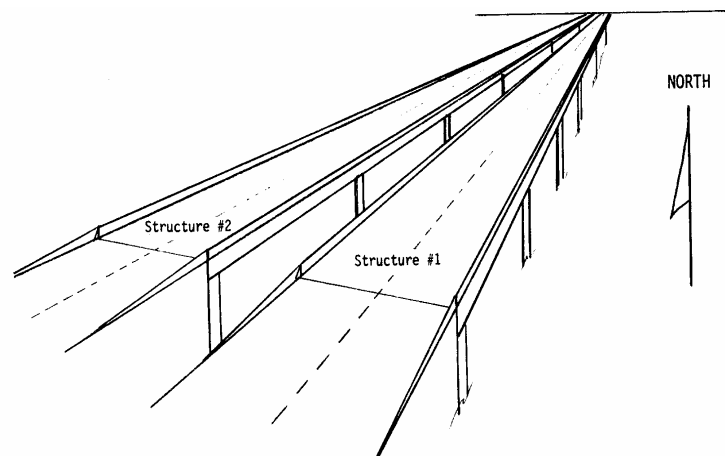

Item 102 - Direction of Traffic

(X)

Code the direction of traffic of the inventory route identified in Item 5 as a 1-digit number using the codes below. This item must be compatible with other traffic-related items such as Item 28A Lanes on the Structure, Item 29 - Average Daily Traffic, Item 47 - Total Horizontal Clearance and Item 51 - Bridge Roadway Width, Curb-to-Curb.

<u>Code</u>	<u>Description</u>
0	Highway traffic not carried
1	1-way traffic
2	2-way traffic
3	One lane bridge for 2-way traffic

Item 103 - Temporary Structure Designation

(X)

Code this item to indicate situations where temporary structures or conditions exist. This item should be blank if not applicable.

<u>Code</u>	<u>Description</u>
T	Temporary structure(s) or conditions exist.

Temporary structure(s) or conditions are those which are required to facilitate traffic flow. This may occur either before or during the modification or replacement of a structure found deficient. Such conditions include the following:

- Bridges shored up, including additional temporary supports.
- Temporary repairs made to keep a bridge open.
- Temporary structures, temporary runarounds or bypasses.
- Other temporary measures, such as barricaded traffic lanes to keep the bridge open.

Any repaired structure or replacement structure which is expected to remain in place without further project activity, other than maintenance, for a significant period of time shall not be considered temporary. Under such conditions, that structure, regardless of its type, shall be considered the minimum adequate to remain in place and evaluated accordingly.

(Continued next page)

Item 103 - Temporary Structure Designation (contd.)

If this item is coded T, then all data recorded for the structure shall be for the condition of the structure without temporary measures, except for the following items which shall be for the temporary structure:

- Item 10 - Inventory Route, Minimum Vertical Clearance
- 41 - Structure Open, Posted, or Closed to Traffic
- 47 - Inventory Route, Total Horizontal Clearance
- 53 - Minimum Vertical Clearance Over Bridge Roadway
- 54 - Minimum Vertical Under clearance
- 55 - Minimum Lateral Under clearance on Right
- 56 - Minimum Lateral Under clearance on Left
- 70 - Bridge Posting

Item 104 - Highway System of the Inventory Route (X)

This item is to be coded for all records in the inventory. For the inventory route identified in Item 5, indicate whether the inventory route is on the National Highway System (NHS) or not on that system. Use the following codes:

<u>Code</u>	<u>Description</u>
0	Inventory Route <u>is not</u> on the NHS
1	Inventory Route <u>is</u> on the NHS

Item 105 - Federal Lands Highways (X)

Structures owned by State and local jurisdictions on roads which lead to and traverse through federal lands sometimes require special coded unique identification because they are eligible to receive funding from the Federal Lands Highway Program. Use the following codes:

<u>Code</u>	<u>Description</u>
0	Not applicable
1	Indian Reservation Road (IRR)
2	Forest Highway (FH)
3	Land Management Highway System (LMHS)
4	Both IRR and FH
5	Both IRR and LMHS
6	Both FH and LMHS
9	Combined IRR, FH and LMHS

Item 106 - Year Reconstructed

(XXXX)

Record the year of most recent reconstruction of the structure. Record all 4 digits of the latest year in which reconstruction of the structure was completed. If there has been no reconstruction leave blank.

For a bridge to be defined as reconstructed, the type of work performed, whether or not it meets current minimum standards, must have been eligible for funding under any of the Federal-aid funding categories. The eligibility criteria would apply to the work performed regardless of whether all State or local funds or Federal-aid funds were used.

Some types of eligible work not to be considered as reconstruction are listed:

- Safety feature replacement or upgrading (for example, bridge rail, approach guardrail or impact attenuators).
- Painting of structural steel.
- Overlay of bridge deck as part of a larger highway surfacing project (for example, overlay carried across bridge deck for surface uniformity without additional bridge work).
- Utility work.
- Emergency repair to restore structural integrity to the previous status following an accident.
- Retrofitting to correct a deficiency which does not substantially alter physical geometry or increase the load-carrying capacity.
- Work performed to keep a bridge operational while plans for complete rehabilitation or replacement are under preparation (for example, adding a substructure element or extra girder).

Item 107 - Deck Structure Type**(X)**

Code the type of deck system on the bridge. If more than one type of deck system is on the bridge, code the most predominant. Code N for a filled culvert or arch with the approach roadway section carried across the structure. Use the following codes:

<u>Code</u>	<u>Description</u>
1	Concrete Cast-in-Place
2	Concrete Precast Panels
3	Open Grating
4	Closed Grating
5	Steel plate (includes orthotropic)
6	Corrugated Steel
7	Aluminum
8	Wood or Timber
9	Other
N	Not applicable

Item 108 - Wearing Surface/Protective System**Wear (X), Mem (X), Deck (X)**

Information on the wearing surface and protective system of the bridge deck shall be coded using a 3-digit code composed of 3 segments.

<u>Segment</u>	<u>Description</u>	<u>Length</u>
108A	Type of Wearing Surface (WEAR)	1 digit
108B	Type of Membrane (MEM)	1 digit
108C	Deck Protection (DECK)	1 digit

WEAR - Type of Wearing Surface (Item 108A):

<u>Code</u>	<u>Description</u>
1	Monolithic Concrete (concurrently placed with structural deck)
2	Integral Concrete (separate non-modified layer of concrete added to structural deck)
3	Latex Concrete or similar additive
4	Low Slump Concrete
5	Epoxy Overlay
6	Bituminous
7	Wood or Timber
8	Gravel
9	Other
0	None (no additional concrete thickness or wearing surface is included in the bridge deck)
N	Not Applicable (applies only to structures with no deck)

Item 108 - Wearing Surface/Protective System (contd.)

MEM - Type of Membrane (Item 108B):

<u>Code</u>	<u>Description</u>
1	Built-up
2	Preformed Fabric
3	Epoxy
8	Unknown
9	Other
0	None
N	Not Applicable (applies only to structures with no deck)

DECK - Deck Protection (Item 108C):

<u>Code</u>	<u>Description</u>
1	Epoxy Coated Reinforcing
2	Galvanized Reinforcing
3	Other Coated Reinforcing
4	Cathodic Protection
6	Polymer Impregnated
7	Internally Sealed
8	Unknown
9	Other
0	None
N	Not Applicable (applies only to structures with no deck)

Item 109 - Average Daily Truck Traffic

(XX)

Using up to 2 digits, record the percentage of Item 29 - Average Daily Traffic that is truck traffic. Do not include vans, pickup trucks and other light delivery trucks in this percentage.

If this information is not available, an estimate which represents the average percentage for the category of road carried by the bridge may be used. Leave blank if Item 29 - Average Daily Traffic is not greater than 100.

Item 110 - Designated National Network

(X)

The national network for trucks includes most of the Interstate System and those portions of Federal-Aid highways identified in the Code of Federal Regulations (23 CFR 658). The national network for trucks is available for use by commercial motor vehicles of the dimensions and configurations described in these regulations. For the inventory route identified in Item 5, indicate conditions using the following codes:

<u>Code</u>	<u>Description</u>
0	The inventory route is not part of the national network for trucks.
1	The inventory route is part of the national network for trucks.

Item 111 - Pier or Abutment Protection (for Navigation)

(X)

If Item 38 - Navigation Control has been coded 1, use the codes below to indicate the presence and adequacy of pier or abutment protection features such as fenders, dolphins, etc. The condition of the protection devices may be a factor in the overall evaluation of Item 60 - Substructure. If Item 38 - Navigation Control has been coded 0 or N, leave blank to indicate not applicable.

<u>Code</u>	<u>Description</u>
1	Navigation protection not required
2	In place and functioning
3	In place but in a deteriorated condition
4	In place but reevaluation of design suggested
5	None present but reevaluation suggested

Item 112 - NBIS Bridge Length

(X)

Does this structure meet or exceed the minimum length specified to be designated as a bridge for National Bridge Inspection Standards purposes? The following definition of a bridge is to be used:

A structure including supports erected over a depression or an obstruction, such as water, highway, or railway, and having a track or passageway for carrying traffic or other moving loads, and having an opening measured along the center of the roadway of more than 20 feet* between undercopings of abutments or spring lines of arches, or extreme ends of openings for multiple boxes; it may also include multiple pipes, where the clear distance between openings is less than half the smaller contiguous opening.

* (6.1 m).

<u>Code</u>	<u>Description</u>
Y	Yes
N	No

EXAMPLES:

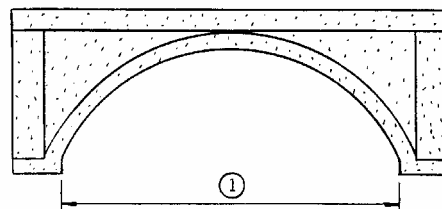
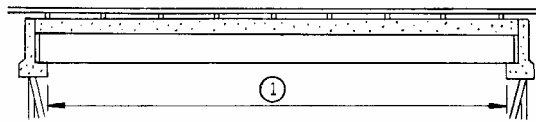
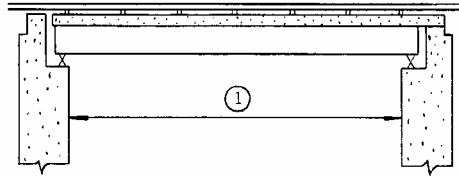

(1) Item 112 - NBIS Bridge Length

Item 112 - NBIS Bridge Length (contd.)

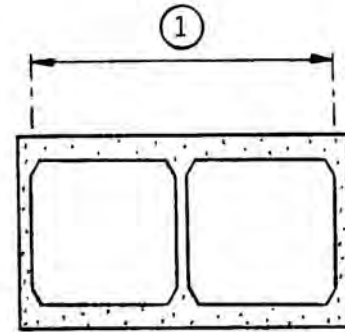
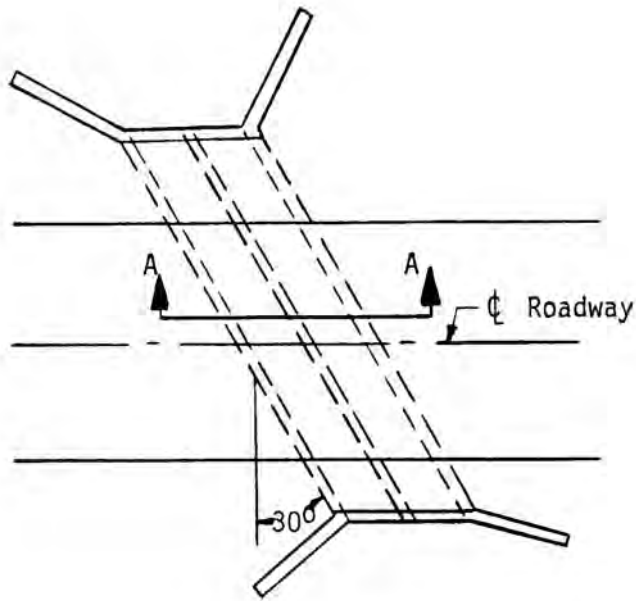

SECTION A-A

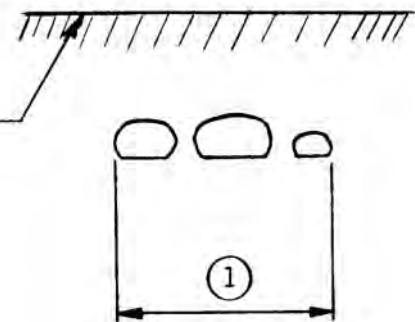
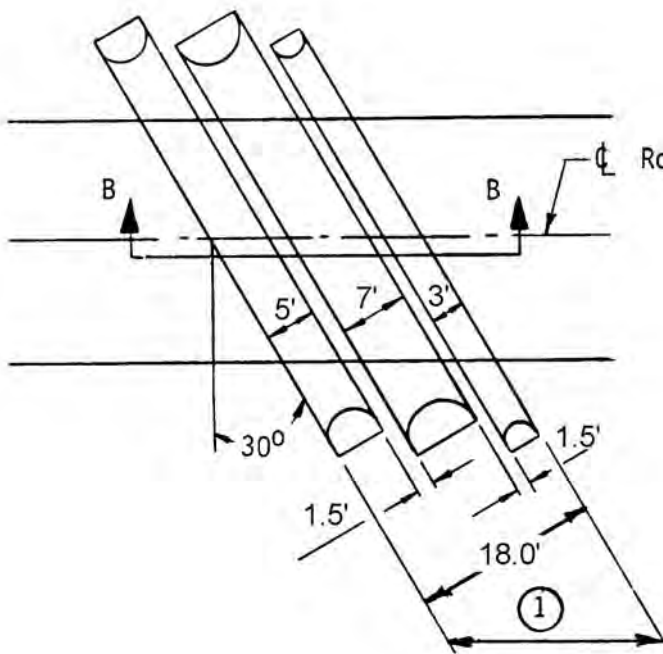

SECTION B-B

EXAMPLES:

- (1) Item 112 - NBIS Bridge Length

Item 113 - Scour Critical Bridges

(X)

Use a single-digit code as indicated below to identify the current status of the bridge regarding its vulnerability to scour. Evaluations shall be made by hydraulic/geotechnical/structural engineers. Guidance on conducting a scour evaluation is included in the FHWA Technical Advisory T 5140.23 titled, "Evaluating Scour at Bridges."¹ Detailed engineering guidance is provided in the Hydraulic Engineering Circular 18 titled "Evaluating Scour at Bridges."² Whenever a rating factor of 2 or below is determined for this item, the rating factor for Item 60 -- Substructure and other affected Items (i.e., load ratings, superstructure rating) should be revised to be consistent with the severity of observed scour and resultant damage to the bridge. A plan of action should be developed for each scour critical bridge (see FHWA Technical Advisory T 5140.23, HEC 18 and HEC 23³). A scour critical bridge is one with abutment or pier foundation rated as unstable due to (1) observed scour at the bridge site (rating factor of 2, 1, or 0) or (2) a scour potential as determined from a scour evaluation study (rating factor of 3). It is assumed that the coding of this Item has been based on an engineering evaluation, which includes consultation of the NBIS field inspection findings.

Code	Description
N	Bridge not over waterway.
U	Bridge with "unknown" foundation that has not been evaluated for scour. Until risk can be determined, a plan of action should be developed and implemented to reduce the risk to users from abridge failure during and immediately after a flood event (see HEC 23).
T	Bridge over "tidal" waters that has not been evaluated for scour, but considered low risk. Bridge will be monitored with regular inspection cycle and with appropriate underwater inspections until an evaluation is performed ("Unknown" foundations in "tidal" waters should be coded U.)
9	Bridge foundations (including piles) on dry land well above flood water elevations.
8	Bridge foundations determined to be stable for the assessed or calculated scour condition. Scour is determined to be above top of footing (Example A) by assessment (i.e., bridge foundations are on rock formations that have been determined to resist scour within the service life of the bridge ⁴), by calculation or by installation of properly designed countermeasures (see HEC 23).
7	Countermeasures have been installed to mitigate an existing problem with scour and to reduce the risk of bridge failure during a flood event. Instructions contained in a plan of action have been implemented to reduce the risk to users from a bridge failure during or immediately after a flood event.

Item 113 - Scour Critical Bridges (contd.)

- 6 Scour calculation/evaluation has not been made. (Use only to describe case where bridge has not yet been evaluated for scour potential.)
- 5 Bridge foundations determined to be stable for assessed or calculated scour condition. Scour is determined to be within the limits of footing or piles (Example B) by assessment (i.e., bridge foundations are on rock formations that have been determined to resist scour within the service life of the bridge), by calculations or by installation of properly designed countermeasures (see HEC 23).
- 4 Bridge foundations determined to be stable for assessed or calculated scour conditions; field review indicates action is required to protect exposed foundations (see HEC 23).
- 3 Bridge is scour critical; bridge foundations determined to be unstable for assessed or calculated scour conditions:
- Scour within limits of footing or piles. (Example B)
 - Scour below spread-footing base or pile tips. (Example C)
- 2 Bridge is scour critical; field review indicates that extensive scour has occurred at bridge foundations, which are determined to be unstable by:
- a comparison of calculated scour and observed scour during the bridge inspection, or
 - an engineering evaluation of the observed scour condition reported by the bridge inspector in Item 60.
- 1 Bridge is scour critical; field review indicates that failure of piers/abutments is imminent. Bridge is closed to traffic. Failure is imminent based on:
- a comparison of calculated and observed scour during the bridge inspection, or
 - an engineering evaluation of the observed scour condition reported by the bridge inspector in Item 60.
- 0 Bridge is scour critical. Bridge has failed and is closed to traffic.

¹ FHWA Technical Advisory T 5140.23, Evaluating Scour at Bridges, dated October 28, 1991.

² HEC 18, Evaluating Scour at Bridges, Fourth Edition.

³ HEC 23, Bridge Scour and Stream Instability Countermeasures, Second Edition.

⁴ FHWA Memorandum "Scourability of Rock Formations," dated July 19, 1991.

Item 113 - Scour Critical Bridges (contd.)

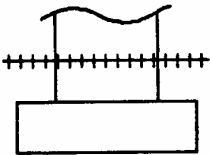
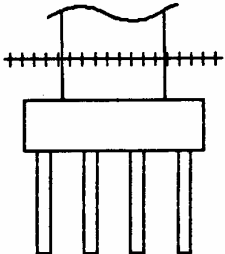
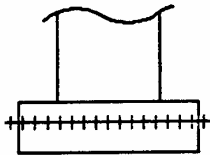
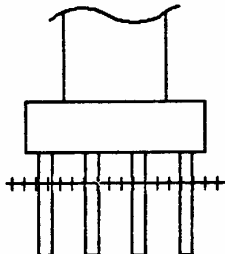
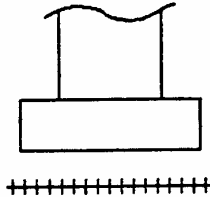
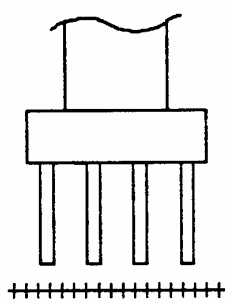
EXAMPLES:	<u>CALCULATED SCOUR DEPTH</u>		<u>ACTION NEEDED</u>
A. Above top of footing			None - indicate rating of 8 for this item
B. Within limits of footing or piles			Conduct foundation structural analysis
C. Below pile tips or spread-footing base			Provide for monitoring and scour countermeasures as necessary
	SPREAD FOOTING (NOT FOUNDED IN ROCK)	PILE FOOTING	

+++++ = Calculated scour depth

Item 114 - Future Average Daily Traffic

(XXXXXX)

Using up to 6 digits, record the forecasted average daily traffic (ADT) for the inventory route identified in Item 5. This shall be projected at least 17 years but no more than 22 years from the year of inspection. The intent is to provide a basis for a 20-year forecast. This item may be updated anytime, but must be updated when the forecast falls below the 17-year limit. If planning data is not available, use the best estimate based on site familiarity.

The future ADT must be compatible with the other items coded for the bridge. For example, parallel bridges with an open median are coded as follows: if Item 28 -Lanes On the Structure and Item 51 - Bridge Roadway Width, Curb-to-Curb are recorded for each bridge separately, then the future ADT must be recorded for each bridge separately (not the total for the route).

Item 115 - Year of Future Average Daily Traffic

(XXXX)

Record the year represented by the future ADT in Item 114. The projected year of future ADT shall be at least 17 years but no more than 22 years from the year of inspection.

**Item 116 - Minimum Navigation Vertical Clearance,
Vertical Lift Bridge**

(XXX.X) ft

Using up to 4 digits, record the minimum vertical clearance imposed at the site, rounded down to the tenth of a foot, as measured above a datum specified on a navigation permit issued by a control agency. Record this item only for vertical lift bridges in the dropped or closed position. Otherwise, leave blank.

EXAMPLES:

Record

Vertical Clearance	20.67 feet	20.6
	24.22 meters	24.2

Item 118 - Project ID Other Route (Entered by Bridge Management Unit)

This item identifies the legal system and project identification number of the route other than the route with which the structure is inventoried.

If a roadway also passes beneath the structure, code this item for the route not included in Item 8. Refer to item 8 (pages 15 & 16) "Legal" and "Project identification" for coding instructions. Note: This Item is for identification of the "other route" which may be either on or under the structure.

Item 119 - Place Code (Entered by Bridge Management Unit)

(XXXXX)

Cities, towns, townships, villages, and other census-designated places shall be identified using the Federal Information Processing Standards (FIPS) codes given in the current version of the Census of Population and Housing - Geographic Identification Code Scheme. If there is no FIPS place code, then code all zeros.

Item 120 - Pedestrian Fence

(X)

Code this item using a one digit code to indicate pedestrian fencing on the structure. Code as follows:

<u>Code</u>	<u>Description</u>
0	None
1	Fence present

Item 141 - Posted Loading (U.S. Tonnage)

(XXXXXX)

Code this item in three segments of two digits each to indicate load posting, as signed on the structure.

NOTE: If Item 41 - Open or Closed to Traffic is not coded "P" or "D" leave this item blank. If Item 64M = less than 3 tons, structure shall be closed, unless temporarily supported.

Option A

The first two digits indicate gross load posting. When coding gross load posting, the last four digits shall be "NNNN".

Option B

The first two digits shall be coded to indicate gross load posting and the third and fourth coded for axle posting. The last two digits shall be "NN".

Option C

Code all six digits to indicate posting by truck type.

For example, assume the analysis of the structure shows a load capacity for a one unit truck to be 35 tons, a two-unit truck to be 60 tons and a three-unit truck to be 68 tons, this Item would be coded 356068

Item 143 - Pin and Hanger Code

(X)

This item shall be coded to indicate cantilever support type.

<u>Code</u>	<u>Description</u>
1	None
2	Pin and hanger
3	Seated Beam
4	Pin and hanger repaired
5	Others with pins

Item 148 - Number of Pins

(XXX)

Using up to 3 digits record the number of pin and hanger assemblies on the structure. Leave blank if not applicable.

Item 176 - Under Water Inspection

(X)

The first segment defines the method of inspection required.

<u>Description</u>	<u>Code</u>
Inspection not required	0
Inspection by wading and probe	1
Inspection by boat and probe	2
Inspection by diver	3

Leave blank if no inspection is required.

Item 193 - Overload Class (Optional for local agencies)

(X), (XXX), (X)

This item consists of three segments.

The first segment is one digit and defines the class of structure. Structure classes shall be A, B, C, or D and is determined by the capacity of the structure for permit overload vehicles greater than legal load. The chart on page 3A of the Michigan Bridge Analysis Guide shall be used for this purpose.

The second segment is a three digit number. This number pertains only to structures with restricted load limits. These structures will appear on the Table of Bridges with Restricted Load Limits list and map.

The numbers 001-199 indicate the location of the structure on the map. Numbers 201-299 are the location on the map of structures with floor beams and 300-399 are the location on the map of structures with girder spacing greater than ten feet.

The third segment is one digit and shall be an S, R, or blank. An S indicates that the slab controls the load capacity and an R indicates that axle loads are restricted to values shown in the chart on page 3A of the Michigan Bridge Analysis Guide for 8 foot base width.

EXAMPLES:

<u>Description</u>	<u>Code</u>
Class A, slab controls load capacity	A ___ S
Class B	B ___ _
Class D, number on load limit map is 91	D O91 _
Class D, number on load limit map is 101R	D 101 R
Class B, structure has floor beams, number on load limit map is 230R	B 230 R
Class A, structure has > 10' girder spacing, number on load limit map is 327R	A 327 R

Item 194 - Structurally Deficient & Functionally Obsolete Test

The terms structurally deficient and functionally obsolete are FHWA terms that are relevant only for structures carrying highway traffic. This item is calculated by the Edit/Update Program and cannot be coded by the bridge inspector.

ITEMS USED

Item 43 = Main structure type	Item 58 = Deck condition
Item 59 = Superstructure condition	Item 60 = Substructure condition
Item 62 = Culvert & retaining wall condition	Item 67 = Structural condition
Item 68 = Deck geometry	Item 69 = Under clearance
Item 71 = Waterway condition	Item 72 = Approach roadway alignment

STRUCTURAL TEST

A bridge is said to be structurally deficient if any one or more of the following statements are true:

- Item 58 < 5
- Item 59 < 5
- Item 60 < 5
- Item 62 < 5
- Item 67 < 3
- Item 71 < 3

FUNCTIONAL TEST

A bridge is said to be functionally obsolete if: (1) it is NOT structurally deficient AND (2) any one or more of the following statements are true:

- Item 67 = 3
- Item 68 < 4
- Item 69 < 4 and grade-crossing
- Item 71 = 3
- Item 72 < 4

Bridges cannot be both structurally deficient and functionally obsolete. Structural deficiency takes precedence over functional obsolescence, therefore if a bridge is classified as structurally deficient, it cannot be classified as functionally obsolete.

This item is generated by the computer and reported as follows:

<u>Description</u>	<u>Code</u>
Bridge is structurally deficient	1
Bridge is functionally obsolete	2
Bridge is not deficient	0

Item 196 - Federal Sufficiency Ratings

This item is calculated by the Edit/Update Program and cannot be coded by the bridge inspector. It is an indicator of the structure's adequacy. The item is on a 0-100 scale where 100 represents a completely sufficient structure and 0 represents a completely insufficient structure. The rating is used to determine eligibility for federal bridge funds. The formula is described in detail in appendix B.

Item 202 - Year Painted (XXXX)

Record the year that the structure was last painted. For new structures record the year built. Leave blank for unpainted A588 steel, concrete or other unpainted structure types.

Item 203 - Year Overlay (XXXX)

Record the year the overlay was applied to the bridge deck. Leave blank if not applicable.

Item 302 - Main Route Code (X)

Code the Item to indicate the control route of the structure. The control route is the route with which the structure was built.

Code

- 0 If no route under the structure or if the structure legal system (Item 08) is not equal to 1.
- 1 If the route on the structure is the control route
- 2 If the route under the structure is the control route.
- 3 If the route on and the route under are not the route with which the structure was built.

Item 304 - City Number (XXXX)

If structure is located in a municipality, code the four digit City number to indicate the municipality in which the structure is located. If the structure is not located within a city, Leave blank.

MDOT city numbers can be found in MDOT Report 230 - Population Listing or are available by contacting the Bridge Management Unit of the Michigan Department of Transportation.

Item 595 - Footing Type (Optional for local agencies)

(X)

Code the footing type using a one digit code from the codes given below. In order of priority when different footing types are present, code the type most susceptible to scour first.

<u>Code</u>	<u>Description</u>
A	Spread Footing on soil
B	Footing/timber piles
C	Footing/steel H piles
D	Footing /steel tube piles
E	Footing on Tremie
F	Pile bents
G	Caisson
H	Curtain wall
I	Spread footing on rock
J	Footing in cofferdam - steel sheet piling left in place
K	Gravity Type on Soil
L	Gravity Type on Timber Piles
M	Gravity Type on Steel H-Piles
N	Gravity Type on Concrete Piles
P	Gravity Type with Tremie
Q	Gravity Type on Rock

Item 600 - Proposed Paint Color (MDOT ONLY)

(X)

Code this item to indicate the paint color proposed for the structure. The proposed paint color will be provided by the Landscape Unit.

<u>Code</u>	<u>Description</u>
1	Gray
2	Blue
3	Tan

APPENDIX A

National Bridge Inspection Standards

§ 650.211

earliest practicable time consistent with good construction and management practices.

(b) Implementation of temporary erosion and sediment control measures and practices shall be coordinated with permanent measures to assure economical, effective, and continuous control throughout construction.

(c) Erosion and sediment control measures and practices shall be monitored and maintained or revised to insure that they are fulfilling their intended function during the construction of the project.

(d) Federal-aid funds shall not be used in erosion and sediment control actions made necessary because of contractor oversight, carelessness, or failure to implement sufficient control measures.

(e) Pollutants used during highway construction or operation and material from sediment traps shall not be stockpiled or disposed of in a manner which makes them susceptible to being washed into any watercourse by runoff or high water. No pollutants shall be deposited or disposed of in watercourses.

§ 650.211 Guidelines.

(a) The FHWA adopts the AASHTO Highway Drainage Guidelines, Volume III, "Erosion and Sediment Control in Highway Construction," 1992,¹ as guidelines to be followed on all construction projects funded under title 23, United States Code. These guidelines are not intended to preempt any requirements made by or under State law if such requirements are more stringent.

(b) Each State highway agency should apply the guidelines referenced in paragraph (a) of this section or apply its own guidelines, if these guidelines are more stringent, to develop standards and practices for the control of erosion and sediment on Federal-aid construction projects. These specific standards and practices may reference

¹This document is available for inspection from the FHWA headquarters and field offices as prescribed by 49 CFR part 7, appendix D. It may be purchased from the American Association of State Highway and Transportation Officials offices at Suite 225, 444 North Capitol Street, NW., Washington, DC 20001.

23 CFR Ch. I (4–1–12 Edition)

available resources, such as the procedures presented in the AASHTO "Model Drainage Manual," 1991.²

(c) Consistent with the requirements of section 6217(g) of the Coastal Zone Act Reauthorization Amendments of 1990 (Pub. L. 101-508, 104 Stat. 1388-299), highway construction projects funded under title 23, United States Code, and located in the coastal zone management areas of States with coastal zone management programs approved by the United States Department of Commerce, National Oceanic and Atmospheric Administration, should utilize "Guidance Specifying Management Measures for Sources of Nonpoint Source Pollution in Coastal Waters," 84-B-92-002, U.S. EPA, January 1993.³ State highway agencies should refer to this Environmental Protection Agency guidance document for the design of projects within coastal zone management areas.

Subpart C—National Bridge Inspection Standards

SOURCE: 69 FR 74436, Dec. 14, 2004, unless otherwise noted.

§ 650.301 Purpose.

This subpart sets the national standards for the proper safety inspection and evaluation of all highway bridges in accordance with 23 U.S.C. 151.

§ 650.303 Applicability.

The National Bridge Inspection Standards (NBIS) in this subpart apply to all structures defined as highway bridges located on all public roads.

§ 650.305 Definitions.

Terms used in this subpart are defined as follows:

American Association of State Highway and Transportation Officials (AASHTO)

²This document is available for inspection from the FHWA headquarters and field offices as prescribed by 49 CFR part 7, appendix D. It may be purchased from the American Association of State Highway and Transportation Officials offices at Suite 225, 444 North Capitol Street, NW., Washington, DC 20001.

³This document is available for inspection and copying as prescribed by 49 CFR part 7, appendix D.

Federal Highway Administration, DOT

§ 650.305

Manual. “The Manual for Bridge Evaluation,” First Edition, 2008, published by the American Association of State Highway and Transportation Officials (incorporated by reference, see §650.317).

Bridge. A structure including supports erected over a depression or an obstruction, such as water, highway, or railway, and having a track or passageway for carrying traffic or other moving loads, and having an opening measured along the center of the roadway of more than 20 feet between undercopings of abutments or spring lines of arches, or extreme ends of openings for multiple boxes; it may also include multiple pipes, where the clear distance between openings is less than half of the smaller contiguous opening.

Bridge inspection experience. Active participation in bridge inspections in accordance with the NBIS, in either a field inspection, supervisory, or management role. A combination of bridge design, bridge maintenance, bridge construction and bridge inspection experience, with the predominant amount in bridge inspection, is acceptable.

Bridge inspection refresher training. The National Highway Institute “Bridge Inspection Refresher Training Course”¹ or other State, local, or federally developed instruction aimed to improve quality of inspections, introduce new techniques, and maintain the consistency of the inspection program.

Bridge Inspector’s Reference Manual (BIRM). A comprehensive FHWA manual on programs, procedures and techniques for inspecting and evaluating a variety of in-service highway bridges. This manual may be purchased from the U.S. Government Printing Office, Washington, DC 20402 and from National Technical Information Service, Springfield, Virginia 22161, and is available at the following URL: <http://www.fhwa.dot.gov/bridge/bripub.htm>.

Complex bridge. Movable, suspension, cable stayed, and other bridges with unusual characteristics.

Comprehensive bridge inspection training. Training that covers all aspects of bridge inspection and enables inspectors to relate conditions observed on a bridge to established criteria (see the Bridge Inspector’s Reference Manual for the recommended material to be covered in a comprehensive training course).

Critical finding. A structural or safety related deficiency that requires immediate follow-up inspection or action.

Damage inspection. This is an unscheduled inspection to assess structural damage resulting from environmental factors or human actions.

Fracture critical member (FCM). A steel member in tension, or with a tension element, whose failure would probably cause a portion of or the entire bridge to collapse.

Fracture critical member inspection. A hands-on inspection of a fracture critical member or member components that may include visual and other non-destructive evaluation.

Hands-on. Inspection within arms length of the component. Inspection uses visual techniques that may be supplemented by nondestructive testing.

Highway. The term “highway” is defined in 23 U.S.C. 101(a)(11).

In-depth inspection. A close-up, inspection of one or more members above or below the water level to identify any deficiencies not readily detectable using routine inspection procedures; hands-on inspection may be necessary at some locations.

Initial inspection. The first inspection of a bridge as it becomes a part of the bridge file to provide all Structure Inventory and Appraisal (SI&A) data and other relevant data and to determine baseline structural conditions.

Legal load. The maximum legal load for each vehicle configuration permitted by law for the State in which the bridge is located.

Load rating. The determination of the live load carrying capacity of a bridge using bridge plans and supplemented by information gathered from a field inspection.

National Institute for Certification in Engineering Technologies (NICET). The NICET provides nationally applicable

¹The National Highway Institute training may be found at the following URL: <http://www.nhi.fhwa.dot.gov/>

§ 650.307

voluntary certification programs covering several broad engineering technology fields and a number of specialized subfields. For information on the NICET program certification contact: National Institute for Certification in Engineering Technologies, 1420 King Street, Alexandria, VA 22314-2794.

Operating rating. The maximum permissible live load to which the structure may be subjected for the load configuration used in the rating.

Professional engineer (PE). An individual, who has fulfilled education and experience requirements and passed rigorous exams that, under State licensure laws, permits them to offer engineering services directly to the public. Engineering licensure laws vary from State to State, but, in general, to become a PE an individual must be a graduate of an engineering program accredited by the Accreditation Board for Engineering and Technology, pass the Fundamentals of Engineering exam, gain four years of experience working under a PE, and pass the Principles of Practice of Engineering exam.

Program manager. The individual in charge of the program, that has been assigned or delegated the duties and responsibilities for bridge inspection, reporting, and inventory. The program manager provides overall leadership and is available to inspection team leaders to provide guidance.

Public road. The term “public road” is defined in 23 U.S.C. 101(a)(27).

Quality assurance (QA). The use of sampling and other measures to assure the adequacy of quality control procedures in order to verify or measure the quality level of the entire bridge inspection and load rating program.

Quality control (QC). Procedures that are intended to maintain the quality of a bridge inspection and load rating at or above a specified level.

Routine inspection. Regularly scheduled inspection consisting of observations and/or measurements needed to determine the physical and functional condition of the bridge, to identify any changes from initial or previously recorded conditions, and to ensure that the structure continues to satisfy present service requirements.

Routine permit load. A live load, which has a gross weight, axle weight or dis-

23 CFR Ch. I (4–1–12 Edition)

tance between axles not conforming with State statutes for legally configured vehicles, authorized for unlimited trips over an extended period of time to move alongside other heavy vehicles on a regular basis.

Scour. Erosion of streambed or bank material due to flowing water; often considered as being localized around piers and abutments of bridges.

Scour critical bridge. A bridge with a foundation element that has been determined to be unstable for the observed or evaluated scour condition.

Special inspection. An inspection scheduled at the discretion of the bridge owner, used to monitor a particular known or suspected deficiency.

State transportation department. The term “State transportation department” is defined in 23 U.S.C. 101(a)(34).

Team leader. Individual in charge of an inspection team responsible for planning, preparing, and performing field inspection of the bridge.

Underwater diver bridge inspection training. Training that covers all aspects of underwater bridge inspection and enables inspectors to relate the conditions of underwater bridge elements to established criteria (see the Bridge Inspector’s Reference Manual section on underwater inspection for the recommended material to be covered in an underwater diver bridge inspection training course).

Underwater inspection. Inspection of the underwater portion of a bridge substructure and the surrounding channel, which cannot be inspected visually at low water by wading or probing, generally requiring diving or other appropriate techniques.

[69 FR 74436, Dec. 14, 2004, as amended at 74 FR 68379, Dec. 24, 2009]

§ 650.307 Bridge inspection organization.

(a) Each State transportation department must inspect, or cause to be inspected, all highway bridges located on public roads that are fully or partially located within the State’s boundaries, except for bridges that are owned by Federal agencies.

(b) Federal agencies must inspect, or cause to be inspected, all highway bridges located on public roads that are

Federal Highway Administration, DOT**§ 650.311**

fully or partially located within the respective agency responsibility or jurisdiction.

(c) Each State transportation department or Federal agency must include a bridge inspection organization that is responsible for the following:

(1) Statewide or Federal agencywide bridge inspection policies and procedures, quality assurance and quality control, and preparation and maintenance of a bridge inventory.

(2) Bridge inspections, reports, load ratings and other requirements of these standards.

(d) Functions identified in paragraphs (c)(1) and (2) of this section may be delegated, but such delegation does not relieve the State transportation department or Federal agency of any of its responsibilities under this subpart.

(e) The State transportation department or Federal agency bridge inspection organization must have a program manager with the qualifications defined in §650.309(a), who has been delegated responsibility for paragraphs (c)(1) and (2) of this section.

§ 650.309 Qualifications of personnel.

(a) A program manager must, at a minimum:

(1) Be a registered professional engineer, or have ten years bridge inspection experience; and

(2) Successfully complete a Federal Highway Administration (FHWA) approved comprehensive bridge inspection training course.

(b) There are five ways to qualify as a team leader. A team leader must, at a minimum:

(1) Have the qualifications specified in paragraph (a) of this section; or

(2) Have five years bridge inspection experience and have successfully completed an FHWA approved comprehensive bridge inspection training course; or

(3) Be certified as a Level III or IV Bridge Safety Inspector under the National Society of Professional Engineer's program for National Certification in Engineering Technologies (NICET) and have successfully completed an FHWA approved comprehensive bridge inspection training course, or

(4) Have all of the following:

(i) A bachelor's degree in engineering from a college or university accredited by or determined as substantially equivalent by the Accreditation Board for Engineering and Technology;

(ii) Successfully passed the National Council of Examiners for Engineering and Surveying Fundamentals of Engineering examination;

(iii) Two years of bridge inspection experience; and

(iv) Successfully completed an FHWA approved comprehensive bridge inspection training course, or

(5) Have all of the following:

(i) An associate's degree in engineering or engineering technology from a college or university accredited by or determined as substantially equivalent by the Accreditation Board for Engineering and Technology;

(ii) Four years of bridge inspection experience; and

(iii) Successfully completed an FHWA approved comprehensive bridge inspection training course.

(c) The individual charged with the overall responsibility for load rating bridges must be a registered professional engineer.

(d) An underwater bridge inspection diver must complete an FHWA approved comprehensive bridge inspection training course or other FHWA approved underwater diver bridge inspection training course.

§ 650.311 Inspection frequency.

(a) *Routine inspections.* (1) Inspect each bridge at regular intervals not to exceed twenty-four months.

(2) Certain bridges require inspection at less than twenty-four-month intervals. Establish criteria to determine the level and frequency to which these bridges are inspected considering such factors as age, traffic characteristics, and known deficiencies.

(3) Certain bridges may be inspected at greater than twenty-four month intervals, not to exceed forty-eight-months, with written FHWA approval. This may be appropriate when past inspection findings and analysis justifies the increased inspection interval.

(b) *Underwater inspections.* (1) Inspect underwater structural elements at regular intervals not to exceed sixty months.

§ 650.313**23 CFR Ch. I (4–1–12 Edition)**

(2) Certain underwater structural elements require inspection at less than sixty-month intervals. Establish criteria to determine the level and frequency to which these members are inspected considering such factors as construction material, environment, age, scour characteristics, condition rating from past inspections and known deficiencies.

(3) Certain underwater structural elements may be inspected at greater than sixty-month intervals, not to exceed seventy-two months, with written FHWA approval. This may be appropriate when past inspection findings and analysis justifies the increased inspection interval.

(c) *Fracture critical member (FCM) inspections.* (1) Inspect FCMs at intervals not to exceed twenty-four months.

(2) Certain FCMs require inspection at less than twenty-four-month intervals. Establish criteria to determine the level and frequency to which these members are inspected considering such factors as age, traffic characteristics, and known deficiencies.

(d) Damage, in-depth, and special inspections. Establish criteria to determine the level and frequency of these inspections.

§ 650.313 Inspection procedures.

(a) Inspect each bridge in accordance with the inspection procedures in the AASHTO Manual (incorporated by reference, *see* § 650.317).

(b) Provide at least one team leader, who meets the minimum qualifications stated in § 650.309, at the bridge at all times during each initial, routine, in-depth, fracture critical member and underwater inspection.

(c) Rate each bridge as to its safe load-carrying capacity in accordance with the AASHTO Manual (incorporated by reference, *see* § 650.317). Post or restrict the bridge in accordance with the AASHTO Manual or in accordance with State law, when the maximum unrestricted legal loads or State routine permit loads exceed that allowed under the operating rating or equivalent rating factor.

(d) Prepare bridge files as described in the AASHTO Manual (incorporated by reference, *see* § 650.317). Maintain reports on the results of bridge inspec-

tions together with notations of any action taken to address the findings of such inspections. Maintain relevant maintenance and inspection data to allow assessment of current bridge condition. Record the findings and results of bridge inspections on standard State or Federal agency forms.

(e) Identify bridges with FCMs, bridges requiring underwater inspection, and bridges that are scour critical.

(1) Bridges with fracture critical members. In the inspection records, identify the location of FCMs and describe the FCM inspection frequency and procedures. Inspect FCMs according to these procedures.

(2) Bridges requiring underwater inspections. Identify the location of underwater elements and include a description of the underwater elements, the inspection frequency and the procedures in the inspection records for each bridge requiring underwater inspection. Inspect those elements requiring underwater inspections according to these procedures.

(3) Bridges that are scour critical. Prepare a plan of action to monitor known and potential deficiencies and to address critical findings. Monitor bridges that are scour critical in accordance with the plan.

(f) *Complex bridges.* Identify specialized inspection procedures, and additional inspector training and experience required to inspect complex bridges. Inspect complex bridges according to those procedures.

(g) *Quality control and quality assurance.* Assure systematic quality control (QC) and quality assurance (QA) procedures are used to maintain a high degree of accuracy and consistency in the inspection program. Include periodic field review of inspection teams, periodic bridge inspection refresher training for program managers and team leaders, and independent review of inspection reports and computations.

(h) *Follow-up on critical findings.* Establish a statewide or Federal agency wide procedure to assure that critical findings are addressed in a timely manner. Periodically notify the FHWA of the actions taken to resolve or monitor critical findings.

Federal Highway Administration, DOT**§ 650.403****§ 650.315 Inventory.**

(a) Each State or Federal agency must prepare and maintain an inventory of all bridges subject to the NBIS. Certain Structure Inventory and Appraisal (SI&A) data must be collected and retained by the State or Federal agency for collection by the FHWA as requested. A tabulation of this data is contained in the SI&A sheet distributed by the FHWA as part of the "Recording and Coding Guide for the Structure Inventory and Appraisal of the Nation's Bridges," (December 1995) together with subsequent interim changes or the most recent version. Report the data using FHWA established procedures as outlined in the "Recording and Coding Guide for the Structure Inventory and Appraisal of the Nation's Bridges."

(b) For routine, in-depth, fracture critical member, underwater, damage and special inspections enter the SI&A data into the State or Federal agency inventory within 90 days of the date of inspection for State or Federal agency bridges and within 180 days of the date of inspection for all other bridges.

(c) For existing bridge modifications that alter previously recorded data and for new bridges, enter the SI&A data into the State or Federal agency inventory within 90 days after the completion of the work for State or Federal agency bridges and within 180 days after the completion of the work for all other bridges.

(d) For changes in load restriction or closure status, enter the SI&A data into the State or Federal agency inventory within 90 days after the change in status of the structure for State or Federal agency bridges and within 180 days after the change in status of the structure for all other bridges.

§ 650.317 Reference manuals.

(a) The materials listed in this subpart are incorporated by reference in the corresponding sections noted. These incorporations by reference were approved by the Director of the Federal Register in accordance with 5 U.S.C. 552(a) and 1 CFR part 51. These materials are incorporated as they exist on the date of the approval, and notice of any change in these documents will be published in the FEDERAL REGISTER.

The materials are available for purchase at the address listed below, and are available for inspection at the National Archives and Records Administration (NARA). These materials may also be reviewed at the Department of Transportation Library, 1200 New Jersey Avenue, SE., Washington, DC 20590, (202) 366-0761. For information on the availability of these materials at NARA call (202) 741-6030, or go to the following URL: http://www.archives.gov/federal_register/code_of_federal_regulations/ibr_locations.htm. In the event there is a conflict between the standards in this subpart and any of these materials, the standards in this subpart will apply.

(b) The following materials are available for purchase from the American Association of State Highway and Transportation Officials, Suite 249, 444 N. Capitol Street, NW., Washington, DC 20001, (202) 624-5800. The materials may also be ordered via the AASHTO bookstore located at the following URL: <http://www.transportation.org>.

(1) The Manual for Bridge Evaluation, First Edition, 2008, AASHTO, incorporation by reference approved for §§ 650.305 and 650.313.

(2) [Reserved]

[74 FR 68379, Dec. 24, 2009]

Subpart D—Highway Bridge Replacement and Rehabilitation Program

SOURCE: 44 FR 15665, Mar. 15, 1979, unless otherwise noted.

§ 650.401 Purpose.

The purpose of this regulation is to prescribe policies and outline procedures for administering the Highway Bridge Replacement and Rehabilitation Program in accordance with 23 U.S.C. 144.

§ 650.403 Definition of terms.

As used in this regulation:

(a) *Bridge*. A structure, including supports, erected over a depression or an obstruction, such as water, a highway, or a railway, having a track or passageway for carrying traffic or other moving loads, and having an opening

APPENDIX B

Sufficiency Rating Formula and Example

The sufficiency rating formula described herein is a method of evaluating highway bridge data by calculating four separate factors to obtain a numeric value which is indicative of bridge sufficiency to remain in service. The result of this method is a percentage in which 100 percent would represent an entirely sufficient bridge and zero percent would represent an entirely insufficient or deficient bridge.

An asterisk prefix is used to identify a sufficiency rating that was calculated even though some essential data was missing or coded incorrectly. The Edit/Update Program will substitute a value for the unusable data (which will not lower the rating) and calculate the sufficiency rating. The asterisk is dropped when the unusable data is corrected. It is normal that all culverts with Bridge Roadway Width, Curb-to-Curb - Item 51 coded '0000' will have an asterisk prefixed sufficiency.

Figure 1. Summary of Sufficiency Rating Factors

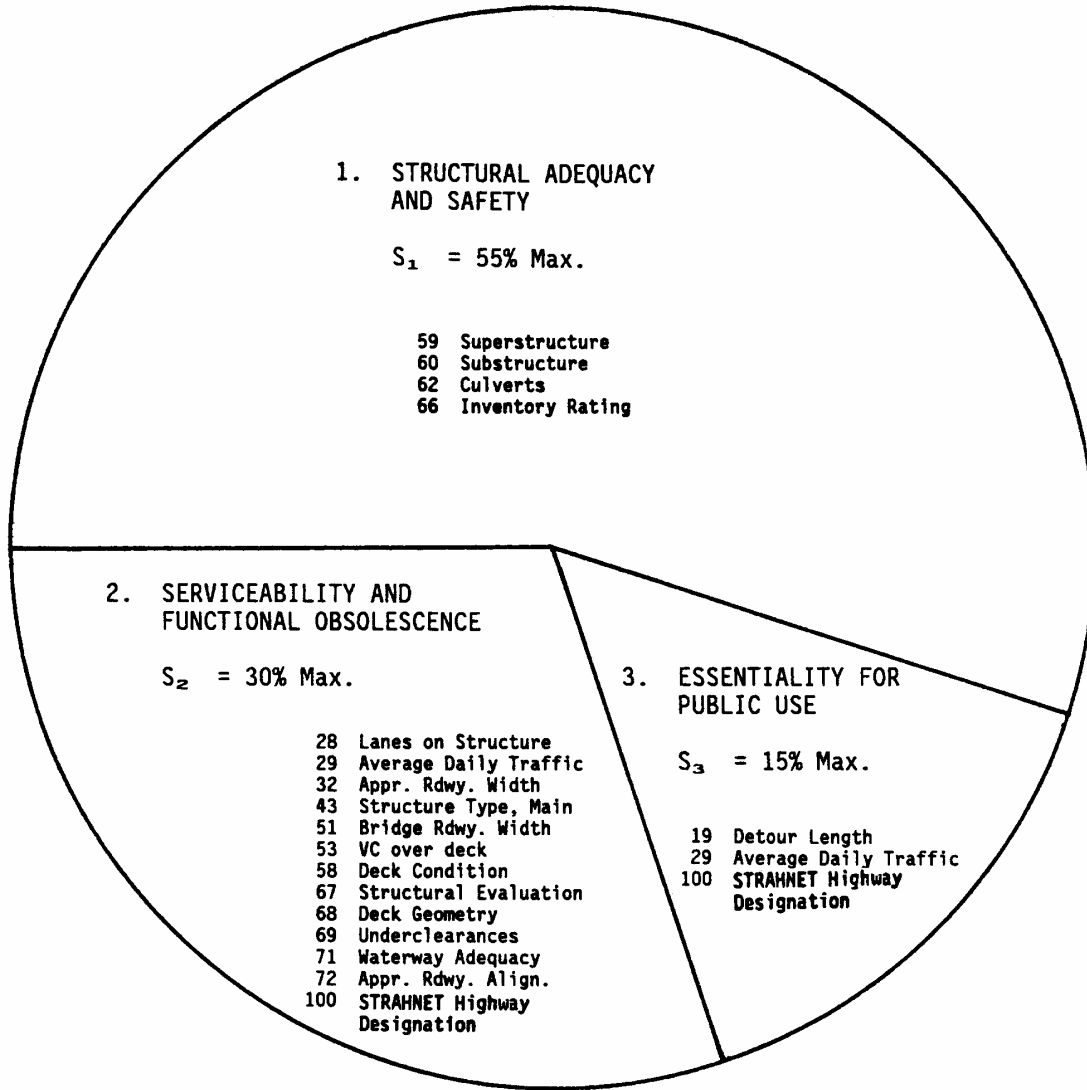

4. SPECIAL REDUCTIONS
 $S_4 = 13\% \text{ Max.}$
 19 Detour Length
 36 Traffic Safety Features
 43 Structure Type, Main

SUFFICIENCY RATING = $S_1 + S_2 + S_3 - S_4$
 Sufficiency Rating shall not be less than 0% nor greater than 100%

Sufficiency Rating Formula

1. Structural Adequacy and Safety (55% maximum)

a. Only the lowest rating code of Item 59, 60, or 62 applies.

If Item 59 (Superstructure Rating) or Item 60 (Substructure Rating) is	≤ 2	then	A = 55%
= 3			A = 40%
= 4			A = 25%
= 5			A = 10%

If Item 59 and Item 60 = N and Item 62 (Culvert Rating) is	≤ 2	then	A = 55%
= 3			A = 40%
= 4			A = 25%
= 5			A = 10%

b. Reduction for Load Capacity:

Calculate using the following formulas where
IR is the Inventory Rating (MS Loading) in tons
or use Figure 2:

$$B = (32.4 - IR)^{1.5} \times 0.3254$$

or

$$\text{If } (32.4 - IR) \leq 0, \text{ then } B = 0$$

"B" shall not be less than 0% nor greater than 55%.

$$S_1 = 55 - (A + B)$$

S_1 shall not be less than 0% nor greater than 55%.

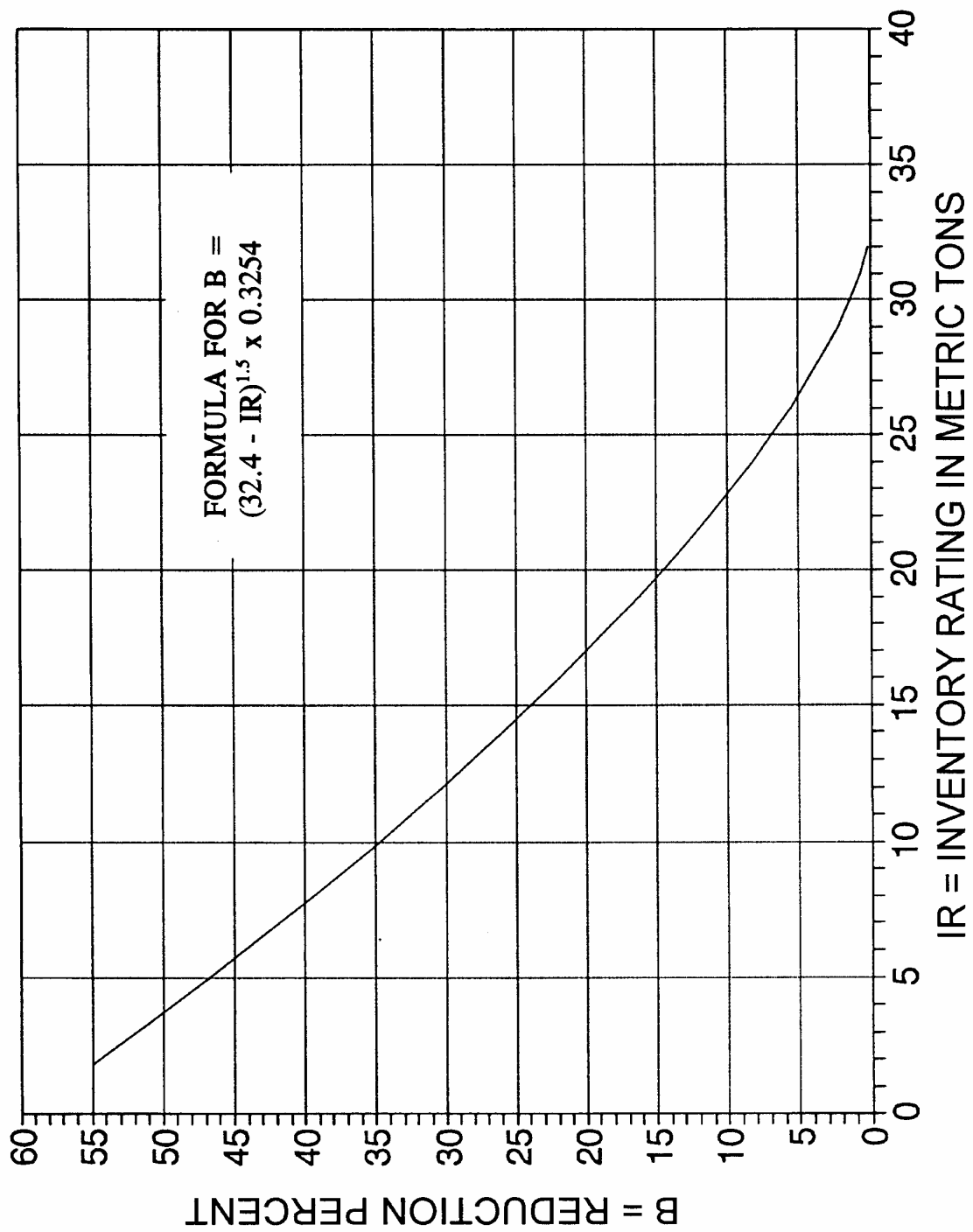

Figure 2. Reduction for Load Capacity

2. Serviceability and Functional Obsolescence (30% maximum)

a. Rating Reductions (13% maximum)

If #58 (Deck Condition) is ≤ 3 then A = 5%
 = 4 A = 3%
 = 5 A = 1%

If #67 (Structural Evaluation) is ≤ 3 then B = 4%
 = 4 B = 2%
 = 5 B = 1%

If #68 (Deck Geometry) is ≤ 3 then C = 4%
 = 4 C = 2%
 = 5 C = 1%

If #69 (Underclearances) is ≤ 3 then D = 4%
 = 4 D = 2%
 = 5 D = 1%

If #71 (Waterway Adequacy) is ≤ 3 then E = 4%
 = 4 E = 2%
 = 5 E = 1%

If #72 (Approach Road Alignment) is ≤ 3 then F = 4%
 = 4 F = 2%
 = 5 F = 1%

$$J = (A + B + C + D + E + F)$$

J shall not be less than 0% nor greater than 13%.

b. Width of Roadway Insufficiency (15% maximum)

Use the sections that apply:

- (1) applies to all bridges;
- (2) applies to 1-lane bridges only;
- (3) applies to 2 or more lane bridges;
- (4) applies to all except 1-lane bridges.

Also determine X and Y:

$$X (ADT / Lane) = \frac{Item29(ADT)}{first\ 2\ digits\ of\ \#28(Lanes)}$$

$$Y (Width / Lane) = \frac{Item51(Bridge\ Roadway\ Width)}{first\ 2\ digits\ of\ \#28(Lanes)}$$

- (1) Use when the last 2 digits of #43 (Structure Type) are not equal to 19 (Culvert):

$$\text{If } (\#51 + 0.6 \text{ meters}) < \#32 \text{ (Approach Roadway Width)} \quad G = 5\%$$

- (2) For 1-lane bridges only, use Figure 3 or the following:

If the first 2 digits of #28 (Lanes) are equal to 01 and

$$Y < 4.3 \quad \text{then} \quad H = 15\%$$

$$Y \geq 4.3 < 5.5 \quad H = 15 \left[\frac{5.5 - Y}{1.2} \right] \%$$

$$Y \geq 5.5 \quad H = 0\%$$

- (3) For 2 or more lane bridges. If these limits apply, do not continue on to (4) as no lane width reductions are allowed.

$$\text{If the first 2 digits of } \#28 = 02 \text{ and } Y \geq 4.9, \quad H = 0\%$$

$$\text{If the first 2 digits of } \#28 = 03 \text{ and } Y \geq 4.6, \quad H = 0\%$$

$$\text{If the first 2 digits of } \#28 = 04 \text{ and } Y \geq 4.3, \quad H = 0\%$$

$$\text{If the first 2 digits of } \#28 \geq 05 \text{ and } Y \geq 3.7 \quad H = 0\%$$

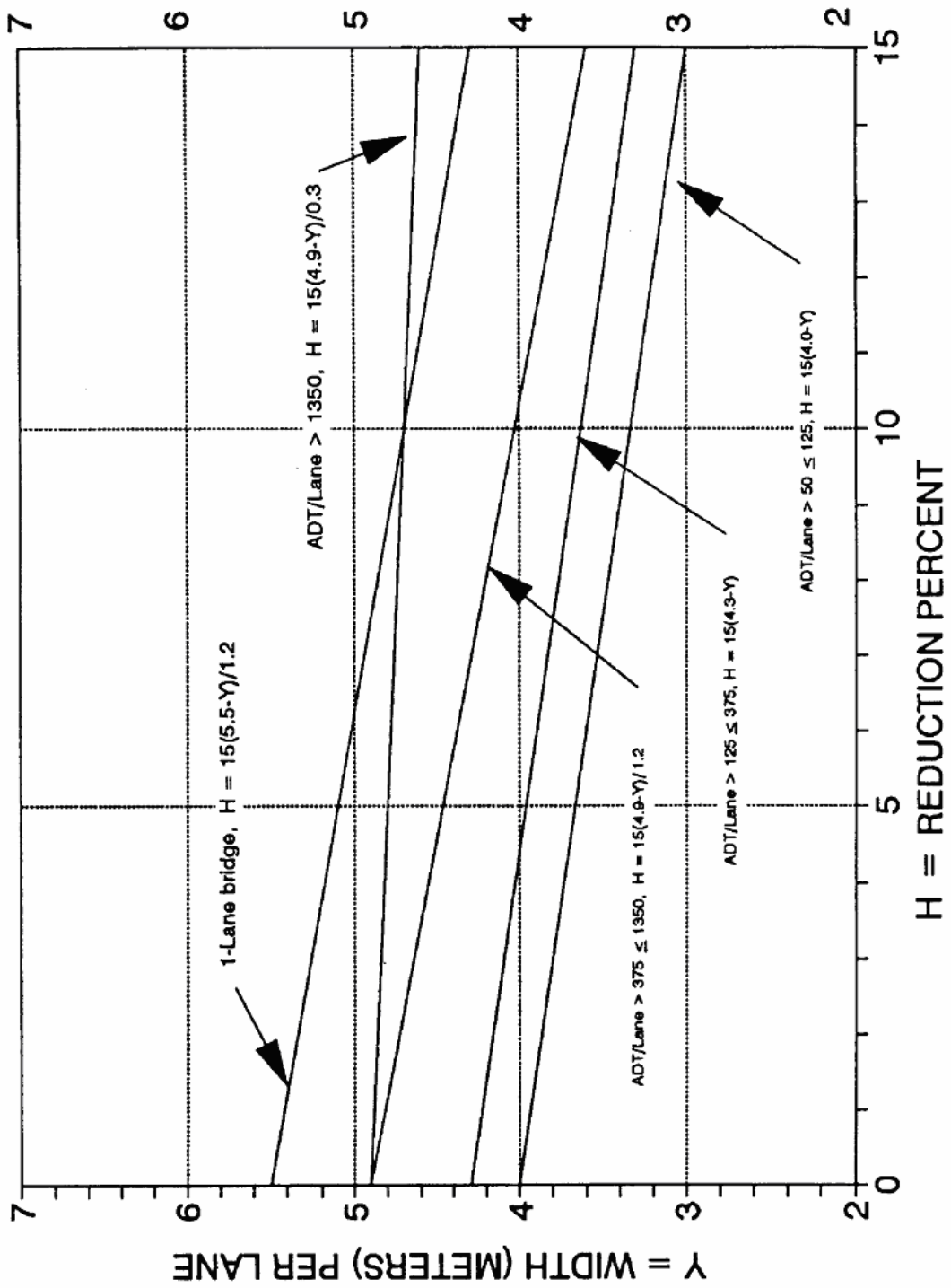

Figure 3- Width of Roadway Insufficiency

(4) For all except 1-lane bridges, use Figure 3 or the following:

$$Y < 2.7 \text{ and } X > 50 \quad \text{then} \quad H = 15\%$$

$$Y < 2.7 \text{ and } X \leq 50 \quad \text{then} \quad H = 7.5\%$$

$$Y \geq 2.7 \text{ and } X \leq 50 \quad \text{then} \quad H = 0\%$$

If $X > 50$ but ≤ 125 and

$$Y < 3.0 \quad \text{then} \quad H = 15\%$$

$$Y \geq 3.0 < 4.0 \quad \text{then} \quad H = 15 (4 - Y) \%$$

$$Y \geq 4.0 \quad \text{then} \quad H = 0\%$$

If $X > 125$ but ≤ 375 and

$$Y < 3.4 \quad \text{then} \quad H = 15\%$$

$$Y \geq 3.4 < 4.3 \quad \text{then} \quad H = 15 (4.3 - Y) \%$$

$$Y \geq 4.3 \quad \text{then} \quad H = 0\%$$

If $X > 375$ but ≤ 1350 and

$$Y < 3.7 \quad \text{then} \quad H = 15\%$$

$$Y \geq 3.7 < 4.9 \quad \text{then} \quad H = 15 \left[\frac{4.9 - Y}{1.2} \right] \%$$

$$Y \geq 4.9 \quad \text{then} \quad H = 0\%$$

If $X > 1350$ and

$$Y < 4.6 \quad \text{then} \quad H = 15\%$$

$$Y \geq 4.6 < 4.9 \quad \text{then} \quad H = 15 \left[\frac{4.9 - Y}{0.3} \right] \%$$

$$Y \geq 4.9 \quad \text{then} \quad H = 0\%$$

G + H shall not be less than 0% nor greater than 15%.

c. Vertical Clearance Insufficiency - (2% maximum)

If #100 (STRAHNET Highway Designation) > 0 and

#53 (VC over Deck) ≥ 4.87 then I = 0%

#53 < 4.87 I = 2%

If #100 = 0 and

#53 ≥ 4.26 then I = 0%

#53 < 4.26 I = 2%

$$S_2 = 30 - [J + (G + H) + I]$$

S₂ shall not be less than 0% nor greater than 30%.

3. Essentiality for Public Use (15% maximum)

a. Determine:
$$K = \frac{S_1 + S_2}{85}$$

b. Calculate:
$$A = \left[\frac{\#29 \times \#19 (DetourLength)}{320,000 \times K} \right]$$

"A" shall not be less than 0% nor greater than 15%.

c. STRAHNET Highway Designation:

If #100 is > 0 then B = 2%

If #100 = 0 then B = 0%

$$S_3 = 15 - (A + B)$$

S₃ shall not be less than 0% nor greater than 15%.

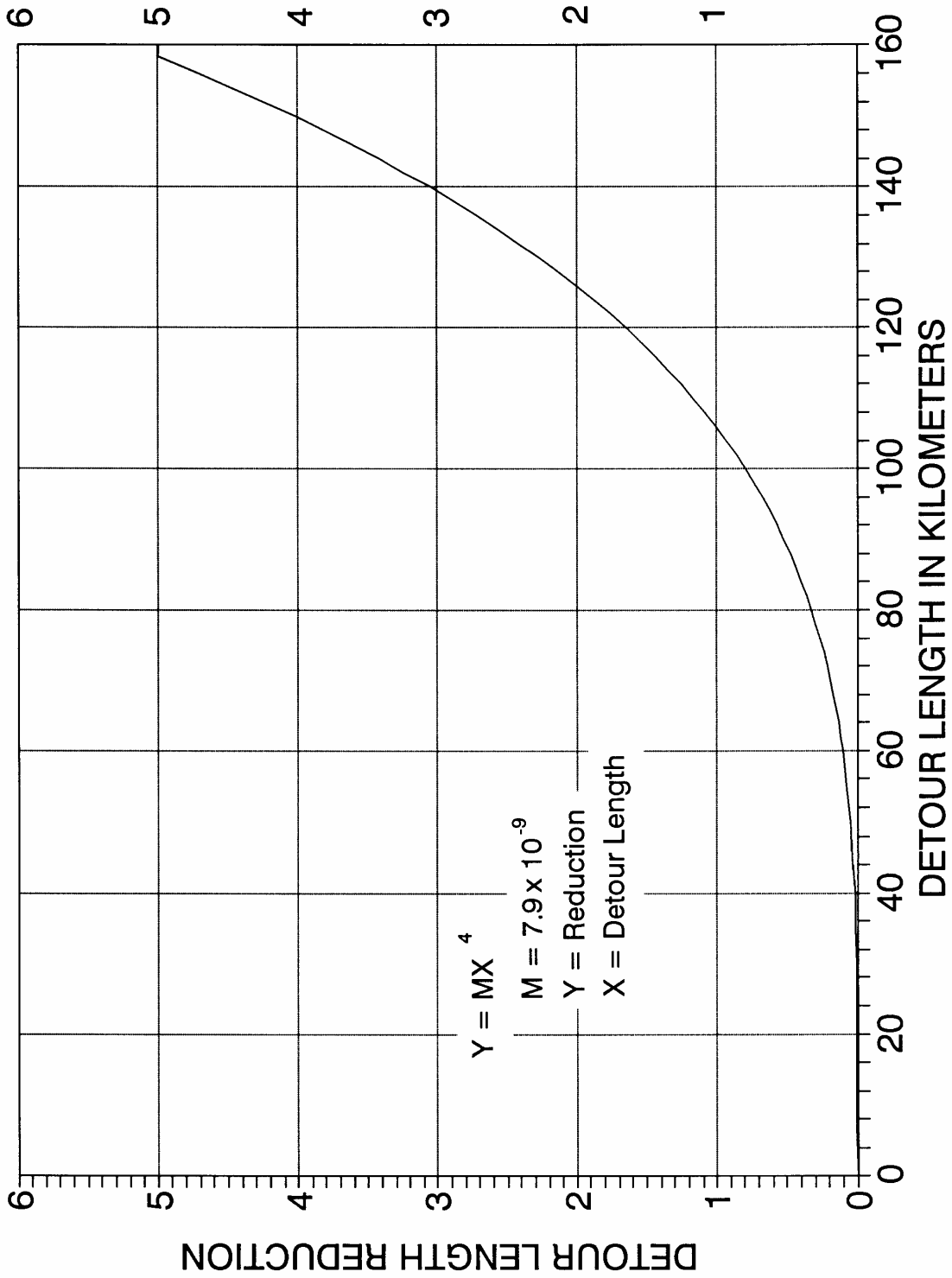

Figure 4. Special Reduction for Detour Length

EXAMPLE

Calculation of Sufficiency Rating

1. Structural Adequacy and Safety

$$A = 10\%$$

$$B = [32.4 - (19.8 \text{ metric tons})]^{1.5} \times 0.3254 = 14.6$$

$$\mathbf{S_1 = 55 - (10 + 14.6) = 30.4}$$

2. Serviceability and Functional Obsolescence

$$A = 3\%, B = 1\%, C = 4\%, D = \text{NA}, E = \text{NA}, F = \text{NA}$$

$$J = (3 + 1 + 4) = 8\%$$

$$X = \frac{18500}{2^2} = 9250 \quad Y = \frac{7.9 \text{ m}}{2} = 3.95$$

$$(1) \text{ If } (7.9 + 0.6) < 12.2 \text{ then } G = 5$$

$$(2) \text{ Not Applicable}$$

$$(3) \text{ Not Applicable}$$

$$(4) \text{ If } X = 9250 \text{ and } Y = 3.95 \text{ then } H = 15$$

$$G + H = 5 + 15 = 20 \text{ (however, maximum allowable} = 15)$$

$$I = 0$$

$$\mathbf{S_2 = 30 - [8 + (15) + 0] = 7.0}$$

3. Essentiality For Public Use

$$K = \frac{30.4 + 7.0}{85} = 0.44$$

$$A = \frac{18500 \times 12.8 \text{ km}}{320,000 \times 0.44} = 25.2 \quad \text{(however, maximum allowable} = 15)$$

$$B = 0$$

$$\mathbf{S_3 = 15 - (15 + 0) = 0}$$

Special Reductions

$$S_1 + S_2 + S_3 = (30.4 + 7.0 + 0.0) = 37.4 < 50$$

S₄ = NA

SUFFICIENCY RATING = 30.4 + 7.0 + 0.0 = 37.4
