



MICHIGAN'S 2018 Roads & Bridges ANNUAL REPORT



Michigan
Transportation Asset
Management Council

ACRONYMS AND ABBREVIATIONS

Any reference to Act 51 in this document refers to Public Act 51 of 1951, as amended.

ADARS: Act-51 Distribution and Reporting System

BCFS: Bridge Condition Forecasting System

CPM: Capital Preventive Maintenance

CRA: County Road Association (of Michigan)

CSS: Center for Shared Solutions (DTMB)

CTT: Center for Training and Technology (MTU)

DTMB: Department of Technology, Management and Budget

FHWA: Federal Highway Administration

FAST: Fixing America's Surface Transportation Act

IRT: Investment Reporting Tool

MAC: Michigan Association of Counties

MAR: Michigan Association of Regions

MDNR: Michigan Department of Natural Resources

MDOT: Michigan Department of Transportation

MIC: Michigan Infrastructure Council

MML: Michigan Municipal League

MPO: Metropolitan Planning Organization

MTA: Michigan Township Association

MTPA: Michigan Transportation Planning Association

MTU: Michigan Technological University

NBI: National Bridge Inventory

NFC: National Functional Classification

NHS: National Highway System

PASER: Pavement Surface Evaluation and Rating

RPA: Regional Planning Agency

STP: State Transportation Program

TAMC: Transportation Asset Management Council

WAMC: Water Asset Management Council

The Michigan Transportation Asset Management Council acts as a resource for independent objective data on the condition of Michigan's roads and bridges and a resource for implementing the concepts of asset management.

TRANSPORTATION ASSET MANAGEMENT COUNCIL (TAMC)

TAMC members for 2018 and the organizations they represent:

Joanna Johnson (TAMC Chair), County Road Association of Michigan

William McEntee (TAMC Vice-Chair), County Road Association of Michigan

Derek Bradshaw, Michigan Association of Regions

Christopher Bolt, P.E., Michigan Association of Counties

Gary Mekjian, P.E., Michigan Municipal League

Bob D. Slattery Jr., Michigan Municipal League

Jonathan R. Start, Michigan Transportation Planning Association

Rob Surber, Michigan Department of Technology, Management
and Budget (Non-Voting)

Jennifer Tubbs, Michigan Townships Association

Brad Wieferich, P.E., Michigan Department of Transportation

Todd White, Michigan Department of Transportation

For added background on the TAMC, its members and its related
legislation, please visit the *About Us* section on the TAMC website at:

www.Michigan.gov/TAMC



To Develop and Support Excellence in Managing Michigan's Transportation Assets by:

- Advising the Legislature, the Michigan Infrastructure Council (MIC), State Transportation Commission, and transportation committees
- Promote asset management principles
- Provide tools and practices for road agencies
- Collaborate and coordinate with the Water Asset Management Council (WAMC)

Team Members

Niles Annelin	John Clark	Beckie Curtis	Jeri Kaminski
Roger Belknap	Tim Colling	Charlie Jarvis	Polly Kent
Gil Chesbro	Clint Crick	Dave Jennett	Gloria Strong

INTRODUCTION

2018 was a very active year, from continued collection of Road and Bridge data to new efforts tied to the Michigan Local Agency Culvert Inventory Pilot. Also, TAMC has a new role with the MIC and WAMC for development of asset management planning and coordination among other infrastructure assets.

Major takeaways from 2018:

- **Roads** – Poor pavements continue to increase. Paved federal-aid roads in poor condition now surpasses the number of miles in fair condition. *(See 2018 Road Condition)*
- **Bridges** – Fair condition Bridges continue to increase. These represent a need for preservation to prevent a further increase of poor bridges. *(See 2018 Bridge Condition)*

Paved Federal-Aid Road Condition

2016/17 vs 2017/18 Percent Lane Miles

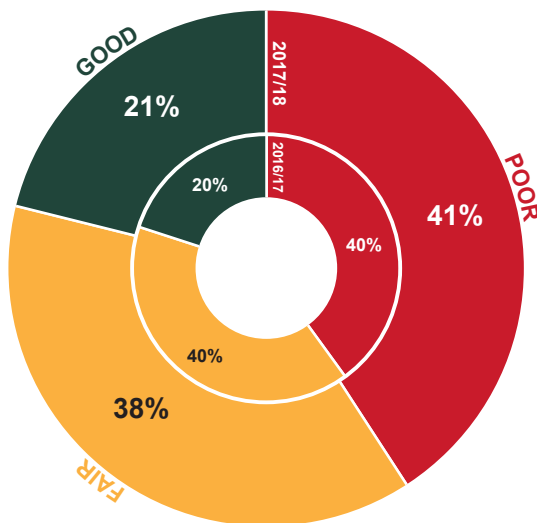

Encouraging news:

- **Investment Data** – With added years of investment data, new types of analysis are becoming available. *(See Investment Reporting)*
- **Pilot Programs** – Culvert data collection and asset management workshops continue to expand asset inventory collection tools and efforts. *(See 2018 Year in Review)*

Local Agency Culvert Condition

Estimated

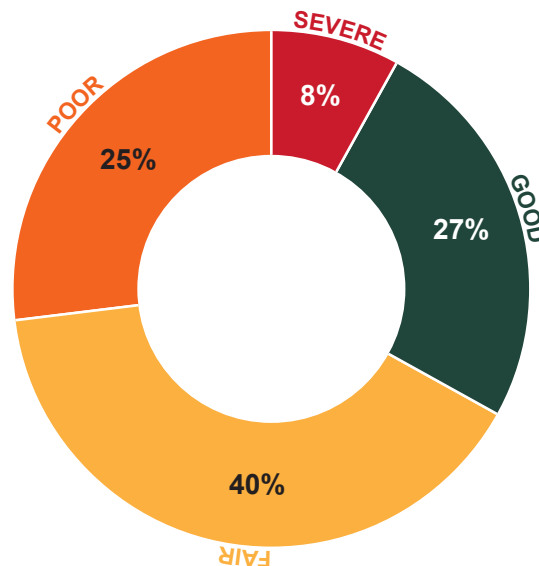

TABLE OF CONTENTS



2018 Year in Review	1
TAMC Highlights and Accomplishments	
2018 Michigan Local Agency Culvert Inventory Pilot	
TAMC Website, Interactive Map and Dashboards	
2018 Road Condition	15
Analysis of Paved Federal-Aid Roads	
Pavement Cycle of Life	
Functional Class	
Quality Management	
Analysis of Paved Non-Federal-Aid Roads	
Condition Forecast	
2018 Bridge Condition	27
Bridge Condition Forecast	
Bridge Cycle of Life	
Investment Reporting	37
Act 51 Compliance Reporting	
Road Projects Details	
Bridge Projects Details	
Ongoing Analysis: A Window into a Statewide Asset Management	
Asset Management Plans and Process Survey	
Saving the 5's	
Looking Into 2019	45
TAMC Takes a Look at Forecasting	49

2018 YEAR IN REVIEW



TAMC Highlights and Accomplishments

In 2018 the TAMC continued and expanded on its core function to develop tools to assist transportation agency data collection and transparency by improving its tools such as the Investment Reporting Tool (IRT), Interactive Map, and Dashboards along with its online resources. The TAMC also continues to provide valuable training and education opportunities to facilitate effective, comprehensive, and standardized data collection.

TAMC Members Thanked for Their Service

The TAMC would like to sincerely thank the following members whose terms ended in 2018, for their service, commitment and dedication to the TAMC and its various committees.

Don Disselkoen,
(County Commissioner, Ottawa County)
representing the Michigan Association of
Counties (MAC) served the TAMC from
October 2008 through December 2018.

Dave Wresinski,
(Bureau of Transportation Planning
Director, Michigan Department of
Transportation (MDOT)) representing the
MDOT served the TAMC from September
2011 through December 2018.



Photo: Joanna Johnson and Don Disselkoen



Photo: Brad Wieferich, Bill McEntee,
Dave Wresinski and Roger Belknap



TAMC Work Program

TAMC operates on a three-year program of both ongoing and new activities designed to promote asset management practices and assist road owning agencies in their asset management efforts. A TAMC strategic planning session in 2018 was part of the 2017-2019 TAMC Work Plan. Among TAMC's accomplishments over the course of the three year plan was the development and delivery of new types of training, improvements to technology, development of mobile applications for TAMC reporting, and upgrading the format of the annual report.

A copy of the current work plan can be found on our website at: www.Michigan.gov/Documents/TAMC/TAMC_2017-2019_Work_Program_TAMC_Website_635948_7.pdf

TAMC Members Receive Governor's Acknowledgement Award

In the fall of 2018 the TAMC was recognized by Governor Snyder for its steady contribution and ongoing commitment to asset management as it impacts the state and nationwide.

Culvert Pilot Project

In 2018, the TAMC Bridge Committee teamed up with Michigan Technological University's Center for Technology & Training (CTT) to initiate, launch and complete a statewide culvert data collection pilot project in less than one year. Please see the separate section "2018 Michigan Local Agency Culvert Inventory Pilot" for greater detail on this accomplishment.



TAMC Investment

TAMC received an increase in its appropriated budget for FY 2018. The TAMC had been operating on the same funding since 2003 and has used the additional resources in 2018 to expand data collection to include unpaved roads (Inventory Based Rating (IBR)), expanded data collection on paved non-federal-aid roads, and to assist road agencies in the preparation of asset management plans. The added funding was also dedicated to expanding training and technology efforts. TAMC's annual budget increased from \$1,626,400 (FY2002 through 2017) to \$1,876,400 (FY2018).

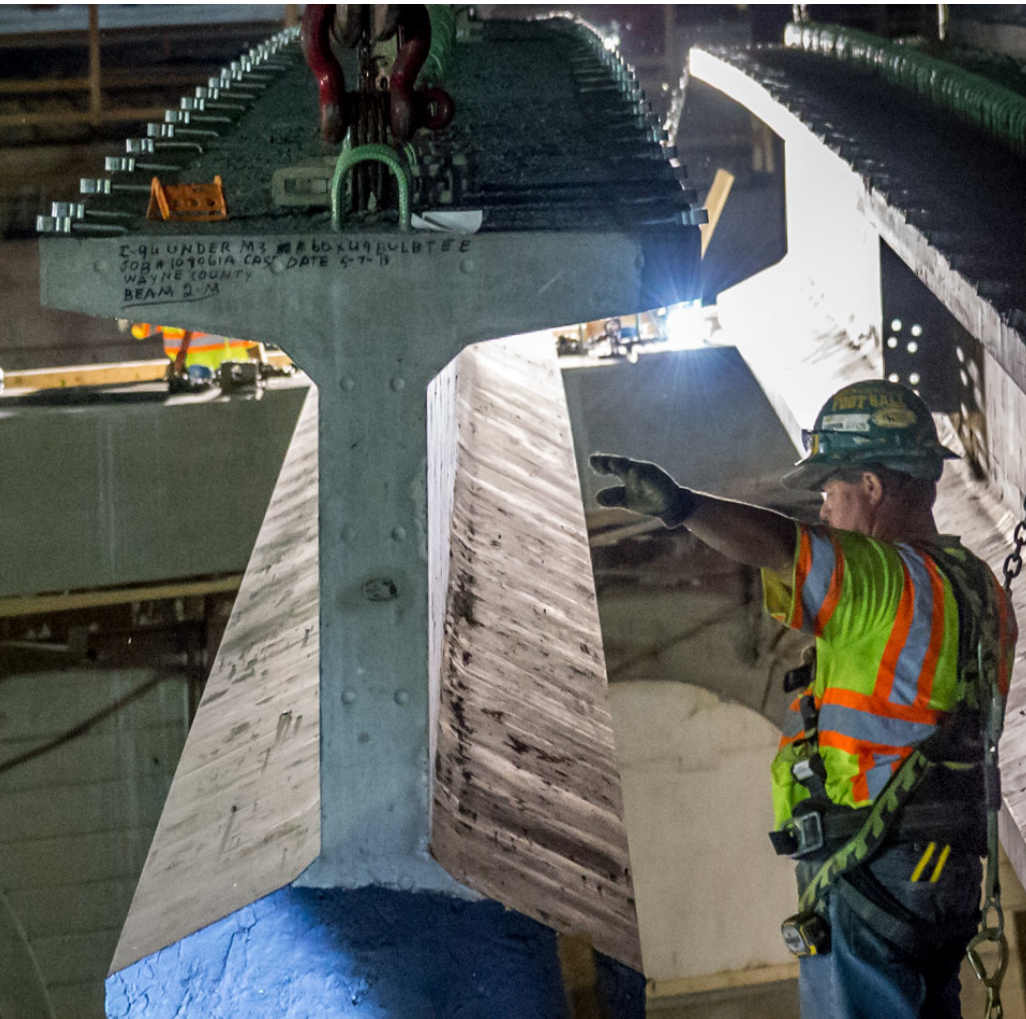

FY2018 Budget Overview		
	Regional Program and Data Collection	\$1,116,400
	Central Data Agency and Technology	\$380,000
	Training and Educational Activities	\$350,000
	Council Expenses	\$30,000
<i>Funding Source: Michigan Transportation Fund</i>		Total: \$1,876,400

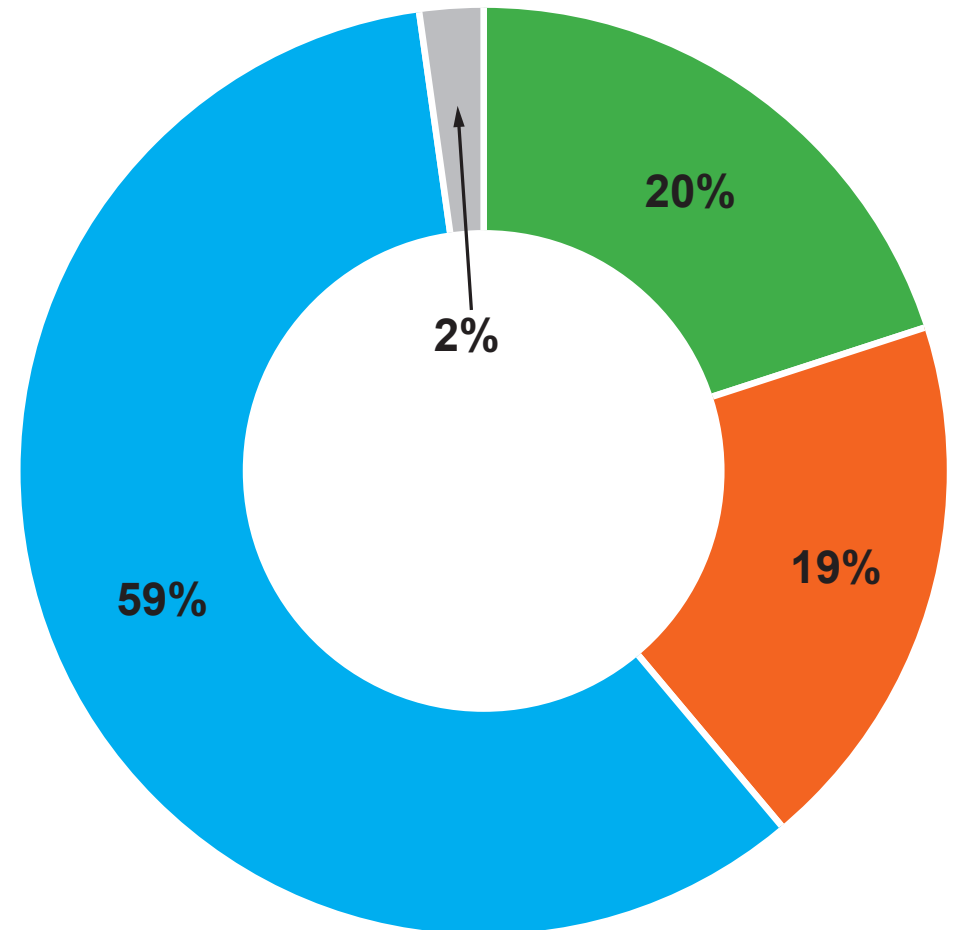



Added TAMC Resources

TAMC strives to use the data it gathers to provide additional resources that can assist those interested in asset management. Two major reports were created in 2018 based on investment reporting data provided by Michigan road agencies:

2018 Michigan Local Agency Pavement Treatment Life Study

www.Michigan.gov/Documents/TAMC/2018_ESL_Report_Final_646677_7.pdf

Analysis of TAMC Investment Reporting Data for Network Level Modeling on the Locally Owned Road System in Michigan

www.Michigan.gov/Documents/TAMC/2018_IRT_Treatment_Report_Final_646678_7.pdf

See the Support section on the TAMC website for a listing of additional resources.

TAMC Conferences, Training and Education

TAMC sponsors two educational conferences to share information and review best practices on an annual basis. Both conferences were well attended and received positive feedback. In 2018, TAMC decided to partner with the American Public Works Association (APWA) for the spring conference held in Traverse City, to provide members

with more opportunity for networking and education. This event was so successful that TAMC and APWA decided to partner again in 2019.

In addition to the annual conference, TAMC works with Michigan Technological University (MTU) to provide training for data collection and asset management.

Training Program	Number of Training Events	Total Participants
PASER Training	10 onsite + 5 webinars	530
Asset Management for Elected Local Officials	5 onsite	48
Asset Management Workshop	2 onsite	37
Bridge Asset Management Workshop	3 onsite + 4 webinars	15
Inventory Based Rating (IBR) Training	1 onsite + 4 webinars	252
Paved Asset Management Plan Workshop Pilot	4 onsite	53
Asset Management Conferences	2 onsite	133
Culvert Inventory Pilot	5 webinars	195
Total:	27 onsite + 18 webinars	1263

Figures provided by
MTU's 2018 Training Report

Investment Reporting Tool (IRT)

Every year agencies must report annual road and bridge investment projects to the TAMC using the IRT. In 2017 a major revision was performed, while in 2018 many new features and enhancements were performed. Some of these enhancements include additional reports, increased quality control, guidance tips, customized treatment options and further search and data management options.

One of the major improvements was a feature added to improve data quality control. In the past, agencies would submit their PASER files, but any issues with their data often would not be discovered until well after submission. With the 2018 IRT enhancement,



Regional Planning Agencies can submit and validate their own PASER files immediately with feedback tables and visual map confirmation. This greatly improved the overall process and improved the efficiency of statewide data aggregation for the annual report. The TAMC appreciates the feedback by local agencies and all its partners as it works to improve its technology tools so they can provide value and are intuitive to use.

TAMC worked with the Department of Technology, Management and Budget's Center for Shared Solutions (CSS) to provide training for the IRT through onsite classes and webinars. In 2018, three webinars were held, as well as five on-site trainings at locations throughout the state, attracting a total of 142 participants.

To learn more about the IRT and view a summary of investment reporting, please visit the ***Investment Reporting Section***.

2017 IRT Training Summary	Participants
Total for On-site	64
Total Webinar	78
Total for 2018	142

Creation of the Michigan Infrastructure Council (MIC) and the Water Asset Management Council (WAMC)

Public Acts (PA) 323, 324, and primarily 325, were enacted in July 2018. They established two new councils: the Michigan Infrastructure Council (MIC) and the Water Asset Management Council (WAMC). PA 325 also modified the scope of the TAMC. Together these support the recommendations of the 21st Century Infrastructure Commission and the Asset Management Infrastructure Pilots to coordinate across all types of investment assets. Both the TAMC and WAMC now report to the MIC. The MIC is housed in the Michigan Department of Treasury. The WAMC is established under the Michigan Department of Environmental Quality (MDEQ). The WAMC is intended to mirror for water and sewer infrastructure the efforts accomplished over the past 17 years by the TAMC. The TAMC remains housed within MDOT.

To learn more about the MIC/WAMC please visit the MIC website: ***www.Michigan.gov/MIC***

2018 Michigan Local Agency Culvert Inventory Pilot

In 2018, the TAMC tasked its Bridge Committee with managing a work plan for a pilot project for the collection of data and the evaluation of culverts owned by local transportation agencies within Michigan. The work was funded through House Bill 4320 (S-3) - Supplemental Appropriation Adjustments, which added \$2 million to the fiscal year 2018 budget from the state restricted Michigan Infrastructure Fund.



TAMC reached out to the Center for Technology and Training (CTT) at Michigan Technological University to assist with managing and facilitating the project. Based on the budget established by the TAMC Bridge Committee, the CTT assembled a work program to guide the project from information gathering to final reporting. Drawing from information gathered during the literature review, CTT staff developed recommendations for data collection procedures, data elements to collect, equipment recommendations for field data collection, assessment methods for evaluating the condition of culverts, and the necessary field log forms for tracking the effort needed to complete the work. The CTT then established a training program for guidance on the data collection operation.

Project Goals and Results

The intent of the culvert data collection pilot project was to collect data on Public Act 51 Certified Roads in Michigan at a statewide level for the following goals:

1. Estimate the total number of culverts in the state: *CTT calculated the estimated number of statewide local agency culverts to be between 178,939 and 213,649.*

2. Estimate the overall condition of culverts in the state using similar inspection components and rating. Culverts were rated:
 - a. 27% were rated “Good”
 - b. 40% were rated as “Fair”
 - c. 25% were rated as “Poor”
 - d. 8% were rate as “Critical”
3. Determine the range of physical characteristics (inventory information) of culverts, such as material, size, and depth, that may impact the cost to maintain or replace the asset. Findings were:
 - a. 69% were corrugated steel pipe
 - b. 21% were concrete
 - c. 5% were plastic
 - d. A majority of reported culverts – 88% – were circular in shape
 - e. 90% were 48 inches or less in span
4. Benchmark estimates of agency labor (time and materials) necessary to find and collect inventory data for culverts on a dollar per mile or other production rate basis: the average culvert data collection labor cost is estimated to be \$39.02 per mile for county road agencies and \$69.17 per mile for cities and villages.

Participants and Outcomes

The TAMC and CTT worked with forty-nine local agencies that successfully located nearly 50,000 culverts in the 13-week data collection window (April 30 – July 30). This is an impressive level of coordination and cooperation between the TAMC, CTT, and local agencies. TAMC and MDOT staff coordinated reimbursement to the local agencies through the existing Unified Work Program contracts with Michigan's Planning Regions and Metropolitan Planning Agencies. This increased the level of participation from TAMC, CTT, CSS and the 49 local agencies to include all 14 regional planning agencies and two metropolitan planning organizations. It is noteworthy to mention that the project included participants representing every planning region in Michigan. Therefore,

information gathered in this pilot contains data from both urban and rural areas of the state, as well as large road agencies and small villages.

Key Findings from Pilot

1. The tools, training, business processes, and relationship building that the TAMC initiated for the collection of PASER road condition data has created a strong framework for the rapid collection of other asset data on the local agency road system.
2. The repeating five-year costs associated with training and data collection for a culvert inventory and condition evaluation program are estimated at \$10.5 million to \$11.25 million (\$2.1 million to \$2.5 million annually). These estimates do not include costs

associated with development and implementation of asset management programs for culverts.

3. A post-pilot survey showed participant interest in continuing to collect inventory and condition evaluation data on the culverts beyond the pilot timeframe.
4. Inventory data from culverts revealed that the majority (approximately 73%) of local agency-owned culverts are small (24 inches in diameter or less), made from corrugated steel, and are circular culverts that are located less than 6 feet from the surface. Larger and more deeply buried culverts are of specific interest because they present a larger consequence of failure in terms of risk to the public and expenditure of funds for repair.
5. Condition data indicates that the local agency-owned culverts are in serviceable shape, with 27% of the rated culverts holding condition ratings of eight or better, and 67.2% of the rated culverts holding conditions of six or better.
6. It is estimated that it will take approximately \$10 million and more than 131,000 collection team hours to complete the initial data collection of local agency culverts.





Conclusion

This pilot project revealed that the tools, business processes, and relationship building that the TAMC initiated for the collection of PASER road condition data has created a strong framework for the rapid collection of other asset data on the public road system. This is apparent from the significant capabilities that pilot participants demonstrated with their

ability to collect a large volume of high-quality asset inventory and condition data in a little over three months. This data was assembled and analyzed using existing business processes and resources. The majority of local agencies used their own forces for collection of data which indicates a domestic capacity to complete this type of activity.

- 49 participating local road agencies
- 13 week data collection window
- 49,644 culverts inventoried
- 90% of local agencies reported using Roadsoft
- 73% of local agency culverts are 24 inches in span or less, 90% are less than 48 inches in span
- 85% are buried 6 feet or less
- 67.2% of rated local agency culverts were 6 or higher out of 10
- Estimated local agency culverts in state – 196,000
- Estimated cost for initial data collection – \$10 million

Local Agency Culvert Condition

Estimated

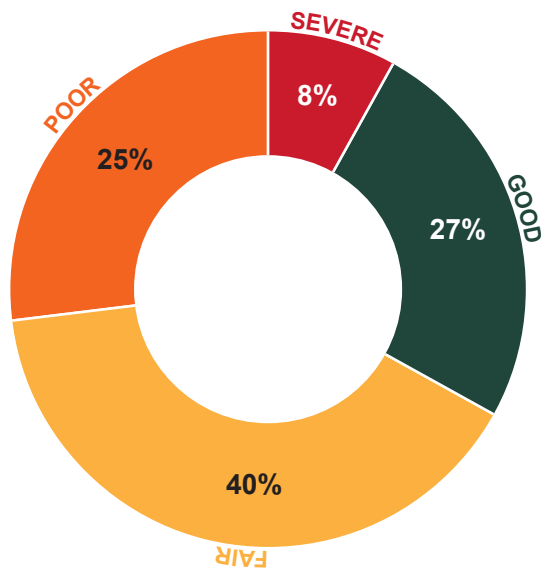

Reported Culverts

by Span or Diameter

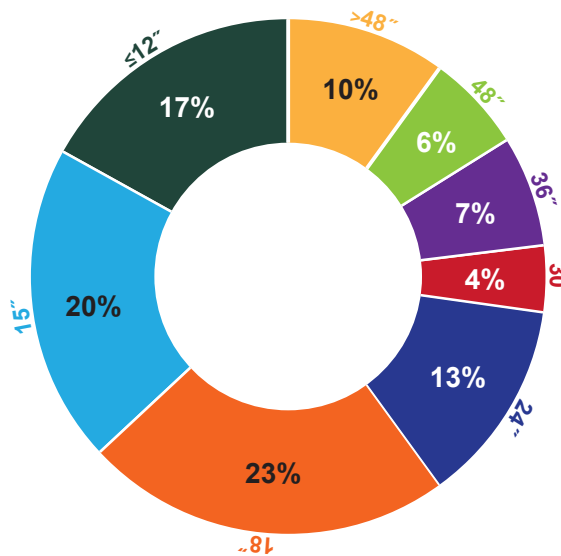

Project Report

A final report of the pilot project was provided to the Michigan Legislature, Governor Rick Snyder and the Michigan Infrastructure Council on October 1, 2018. The report included background, methods, observations and recommendations for continuing the effort to collect, assess and manage culvert data into the future. The full report, summary and appendices are available on the “Support” page of the TAMC website: www.Michigan.gov/TAMC.

Participating Local Road Agencies:

Allegan County	Huron County
Antrim County	Kalamazoo County
Baraga County	Kalkaska County
Barry County	Kent County
Bay County	Lake County
Benzie County	Lapeer County
Cass County	Leelanau County
City of Benton Harbor	Marquette County
City of Big Rapids	Mecosta County
City of Cadillac	Midland County
City of Coldwater	Montcalm County
City of East Tawas	Muskegon County
City of Farmington Hills	Oceana County
City of Fenton	Oscoda County
City of Munising	Ottawa County
City of Muskegon	Roscommon County
Heights	Saginaw County
City of Rochester Hills	St. Clair County
City of Tecumseh	Tuscola County
City of West Branch	Van Buren County
Clinton County	Village of Caledonia
Dickinson County	Village of Daggett
Grand Traverse County	Village of Lennon
Hillsdale County	Village of Newberry
Houghton County	Village of Walkerville

Regional Coordination Assistance:

Central Upper Peninsula Planning and Development Regional Commission
 East Michigan Council of Governments
 Eastern Upper Peninsula Regional Planning and Development Commission
 Genesee-Lapeer-Shiawassee Region V Planning and Development Commission
 Grand Valley Metropolitan Council
 Kalamazoo Area Transportation Study
 Northeast Michigan Council of Governments
 Networks Northwest
 Region 2 Planning Commission
 Southcentral Michigan Planning Council
 Southeast Michigan Council of Governments
 Southwest Michigan Planning Commission
 Tri-County Regional Planning Commission
 West Michigan Regional Planning Commission
 West Michigan Shoreline Regional Development Commission
 Western Upper Peninsula Planning and Development Regional Commission

Participating Agencies and Locations of Inventoried Culverts

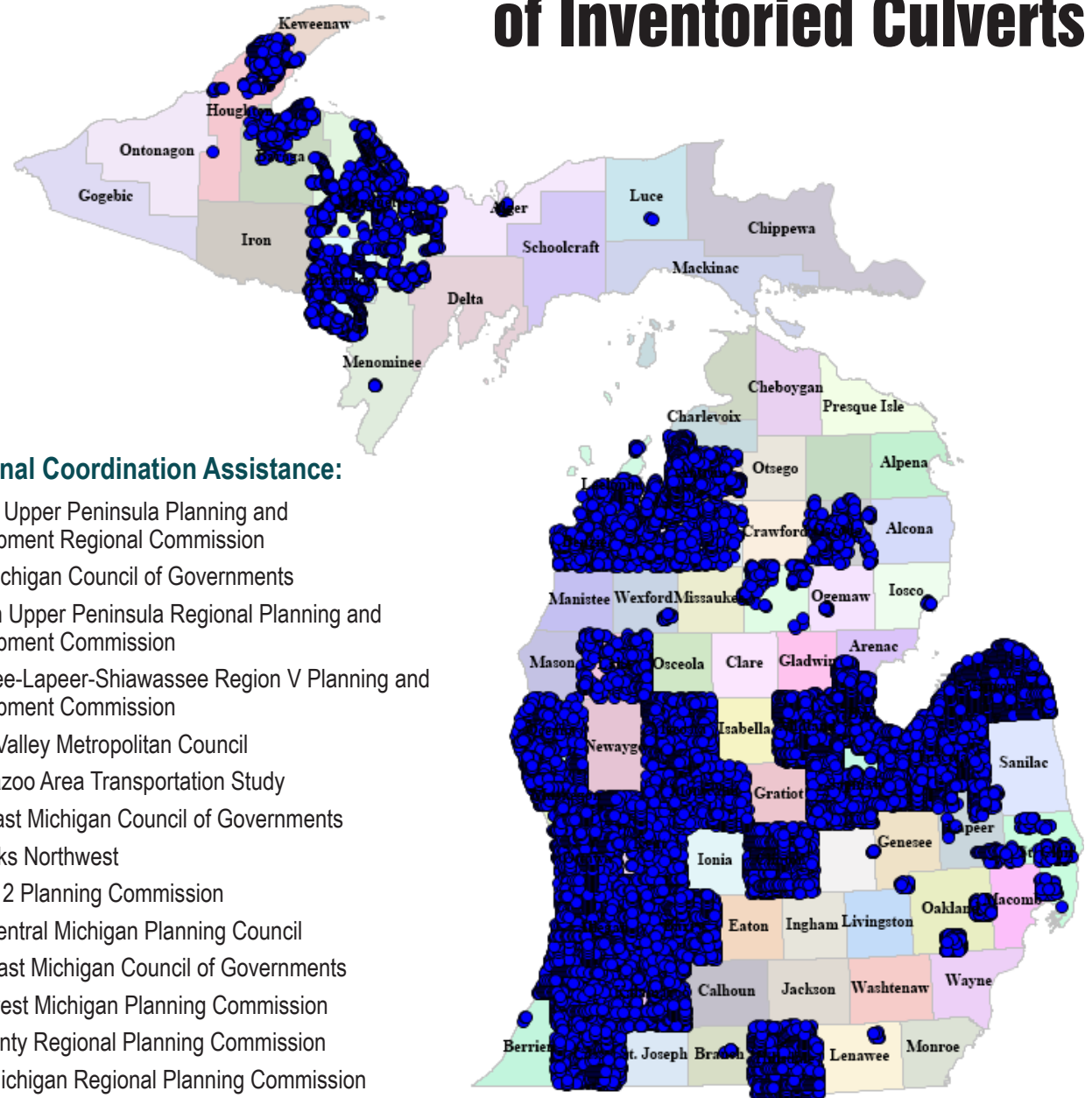

Figure 16
 Source: TAMC October 2018

TAMC Website, Interactive Map and Dashboards

Website

The TAMC continues to maintain and improve its website, which serves as a valuable resource for agencies and the public looking for information on the condition of the road and bridge system. The website provides intuitive

access to all the data collected, training opportunities, meetings, and policies. Additional resources can be found under the support area for different studies, asset management, pilot

projects and related new legislative developments. Please check out the site at www.Michigan.gov/TAMC and sign up for the **Gov Delivery** to stay connected to any future updates.

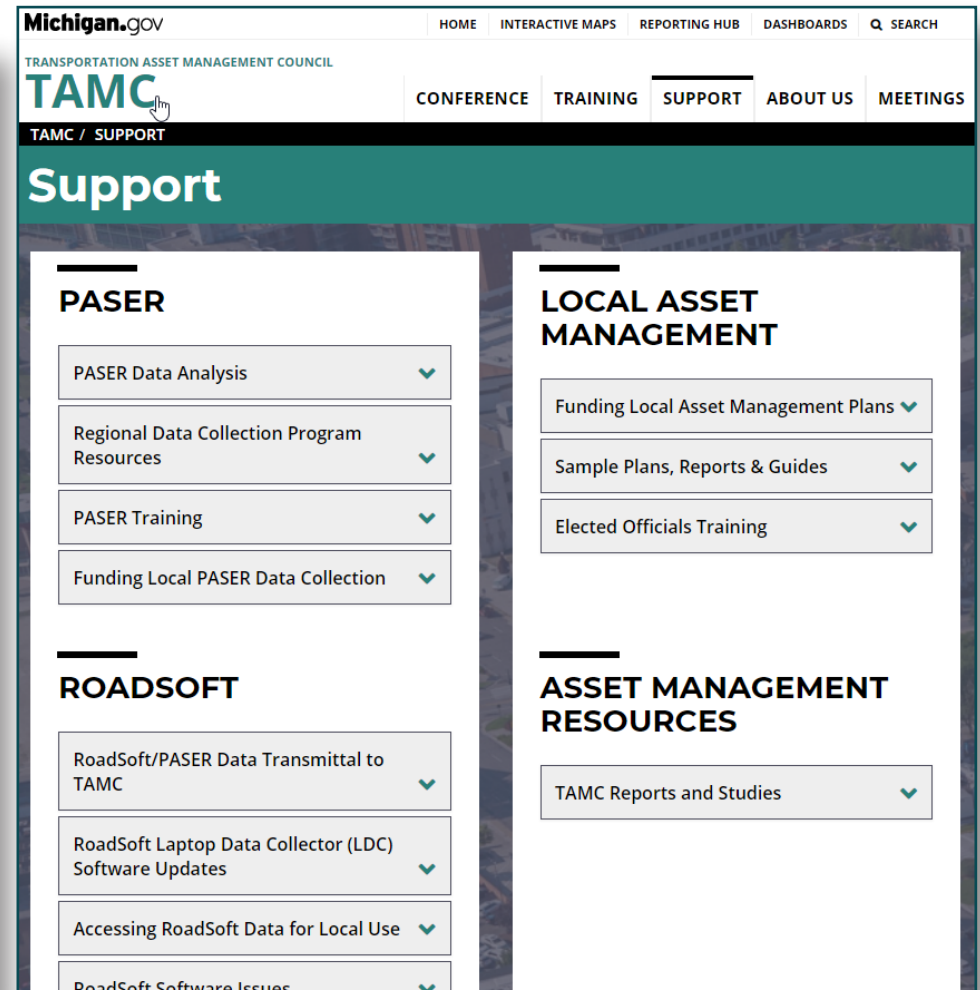
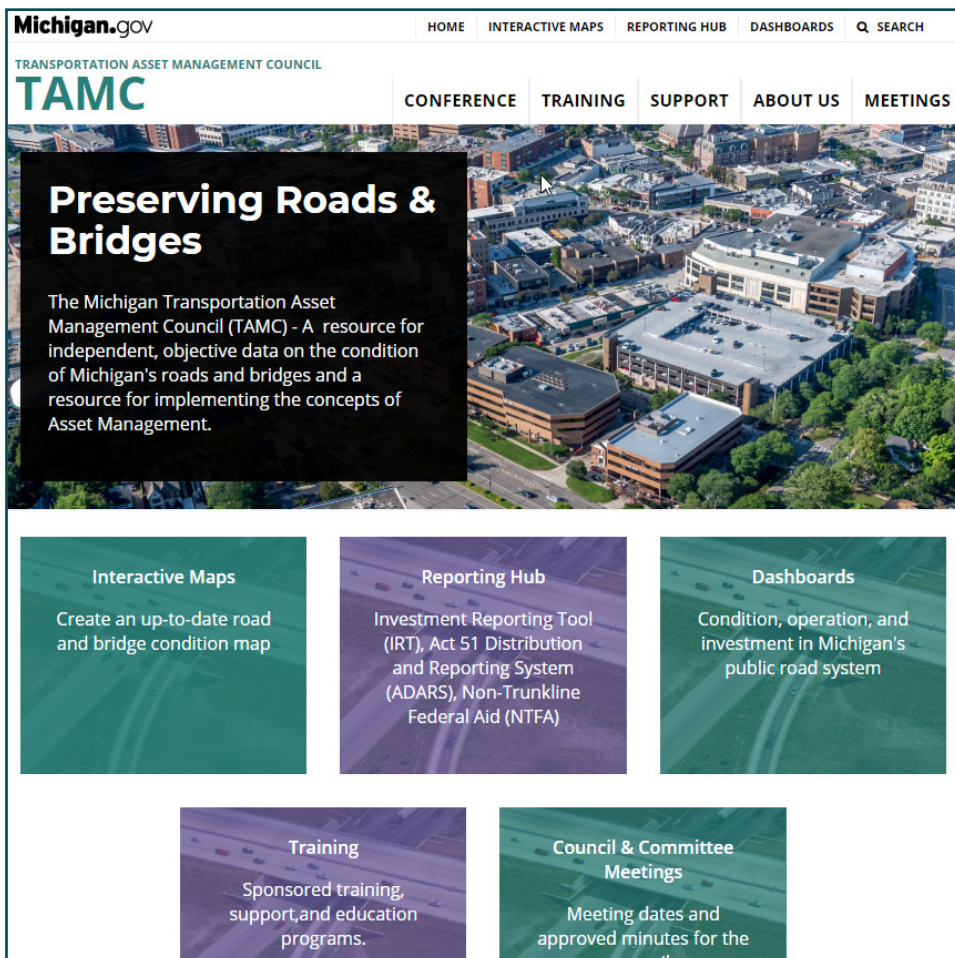

Interactive Map

The TAMC maintains a public interactive map that includes historical and current PASER condition ratings and National Bridge Inventory (NBI) bridge condition information. It also provides information on different traffic elements and locations of both regional municipal planning and prosperity regions. With the added focus on infrastructure coordination, the interactive map is staged for future expansion to increase transparency efforts. The interactive map is fully mobile and offers navigation and ease of use similar to Google maps or other commonly used websites.

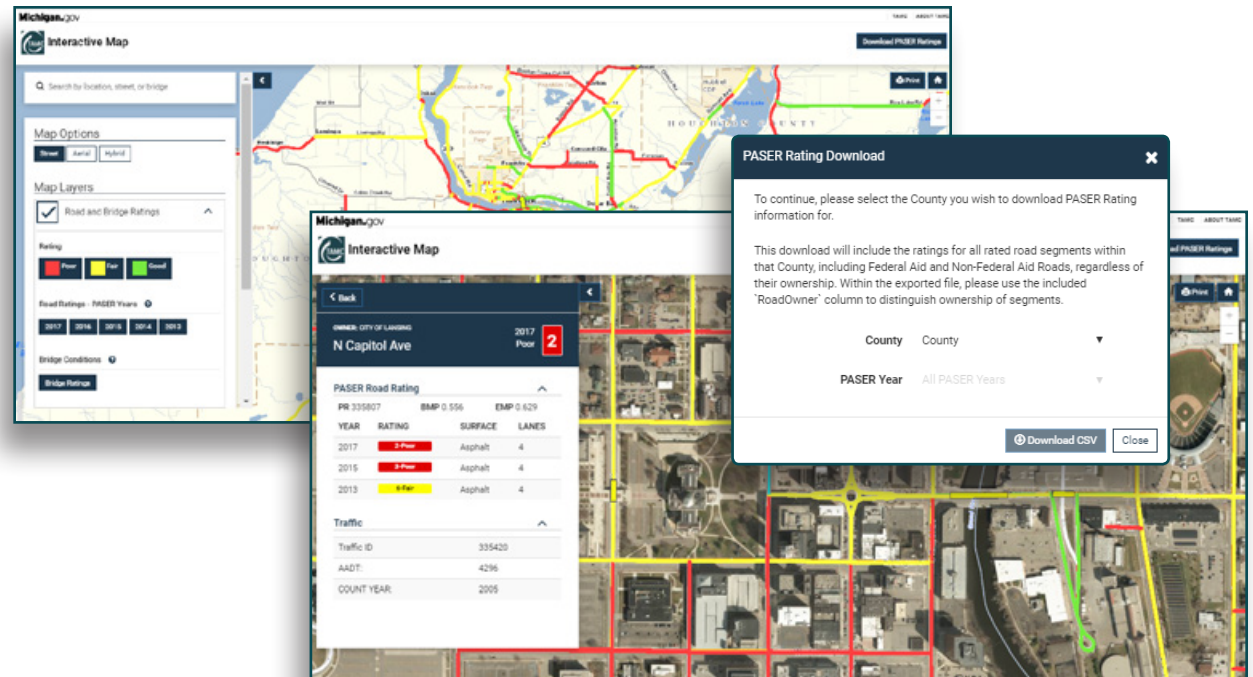

Performance Measure Dashboards

The TAMC has developed and improved upon several Performance Measure Dashboards that show the condition, operation, and investment in Michigan's road and bridge system. These dashboards were upgraded completely in 2018 using new technology. The IRT, interactive map and dashboards now all have layouts and navigation that fully support the mobile community. This new technology has more secure features enabling member agencies to more readily incorporate the dashboards into their own websites. Click on each graphic below for hyperlinks to the Performance Measure Dashboards.

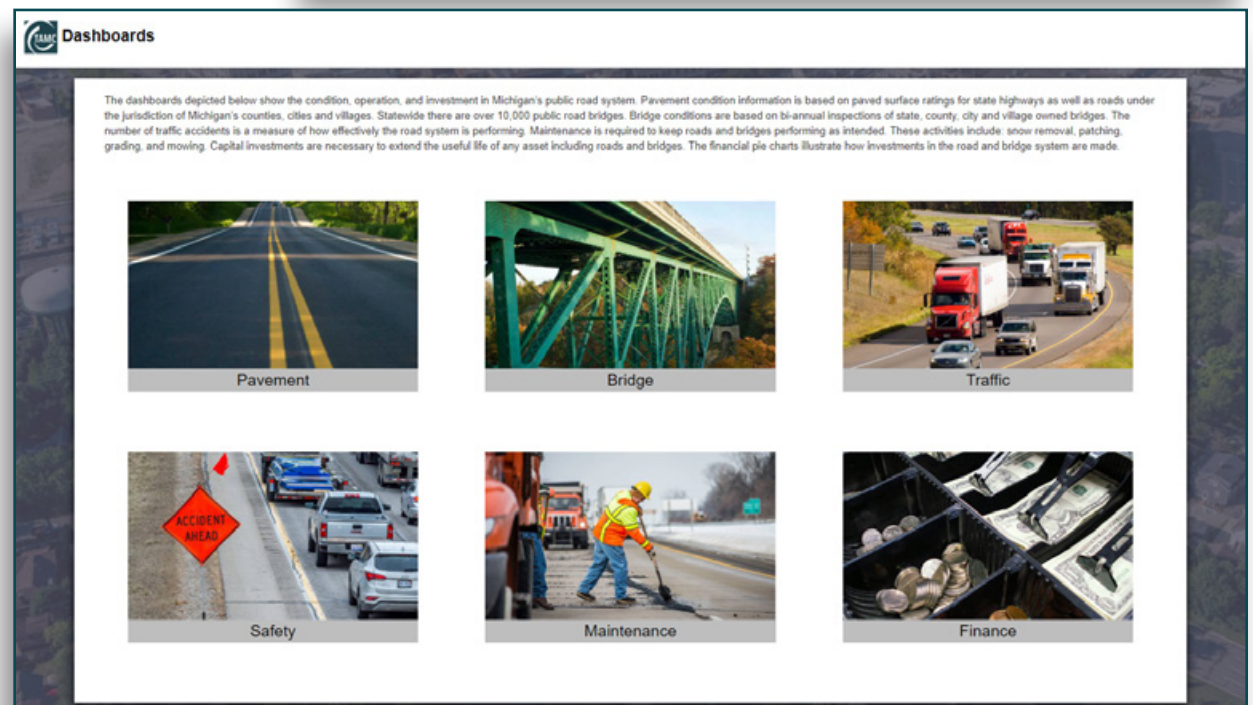

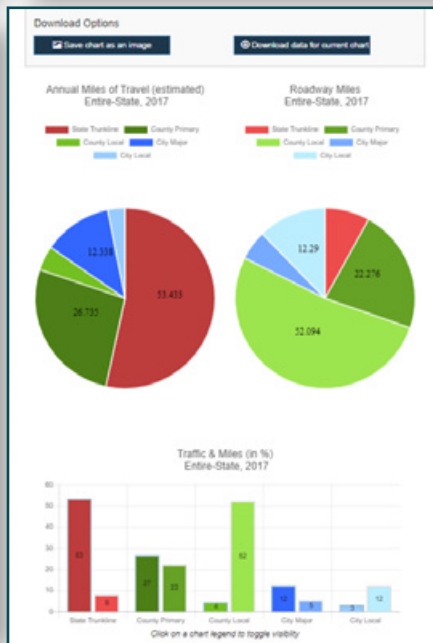
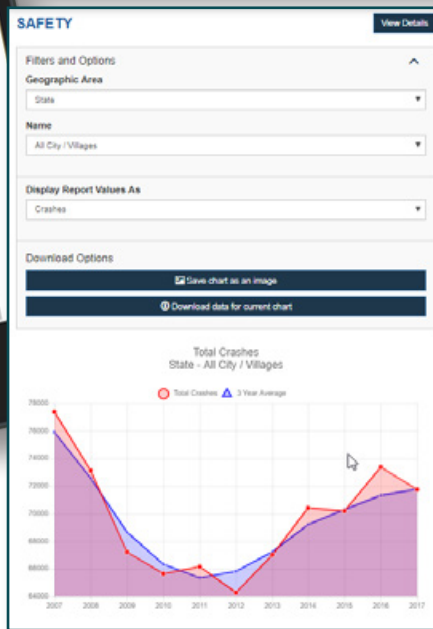
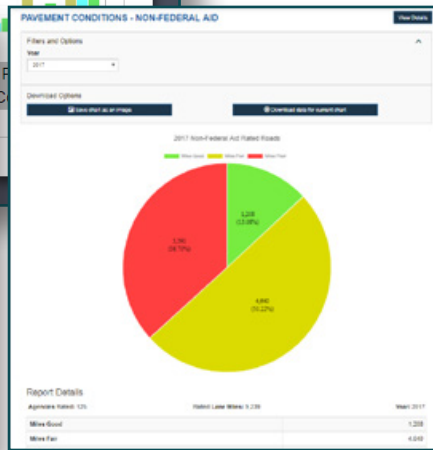
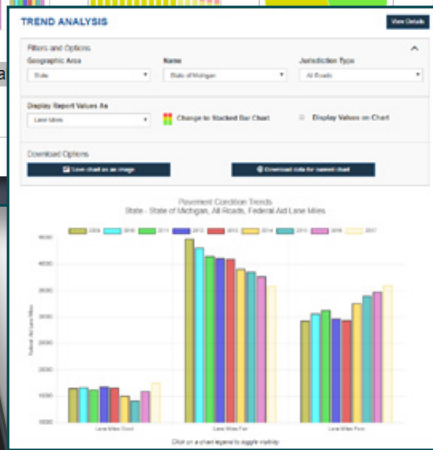
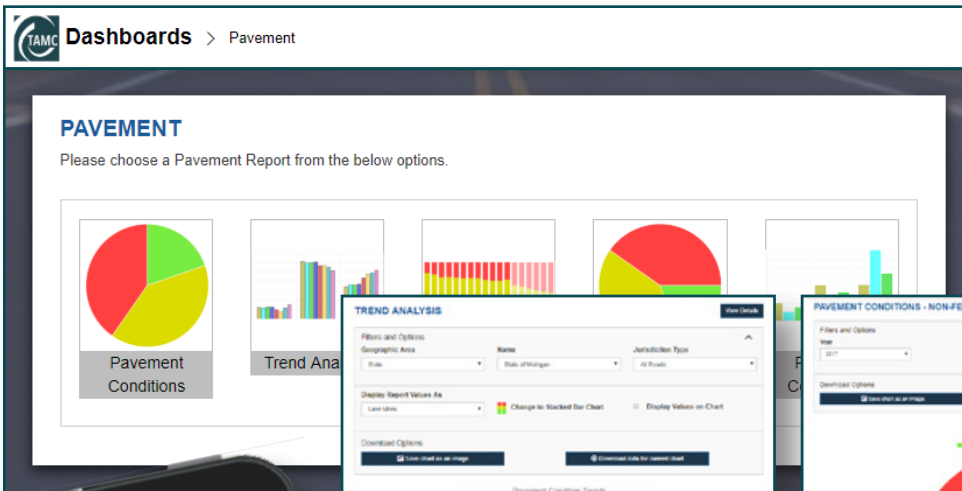

Pavement Condition and Comparison Dashboards

These two dashboards are based on PASER ratings for all paved federal-aid eligible roads in the state. This includes all state trunklines as well as roads under the jurisdiction of Michigan's counties, cities and villages. These dashboards illustrate both the current pavement condition and the trend over the past 8 years. The Pavement Comparison Dashboard provides the user with the ability to compare recent system performance for up to eight road owning agencies at one time.

Bridge Condition and Comparison Dashboards

Bridge conditions are based on bi-annual inspections of over 10,000 state, county, city and village owned bridges. These two dashboards illustrate bridge conditions and trends and provides the user with the ability to compare system performance for up to eight bridge-owning agencies at one time.

Traffic Dashboard

Traffic volumes are a measure of both road use and how effectively the road system is performing. This dashboard shows estimated annual miles of travel on Michigan's roads by type and owner of road used, as well as a comparison of the relative sizes (in centerline miles) of portions of Michigan's road network.

Safety Dashboard

The rate of crashes (fatalities, serious injuries) is a measure of how effectively the road system is performing in safety.

Maintenance Dashboard

This dashboard provides a county by county comparison of winter maintenance expenses that are necessary to keep roads and bridges performing during winter maintenance operations.

Finance Dashboard

Capital investments are necessary to extend the useful life of any asset including roads and bridges. This dashboard illustrates how Michigan's road-owning agencies are investing Michigan Transportation Fund aid into the roads and bridges they own, and the revenues received annually by each agency. All agencies may freely link to these dashboards to provide transparency rather than creating their own. Act 51 requires that each county road agency maintain a searchable website that includes a financial-performance dashboard with information on revenues, expenditures and unfunded liabilities. Adding a link to the TAMC website meets those requirements.

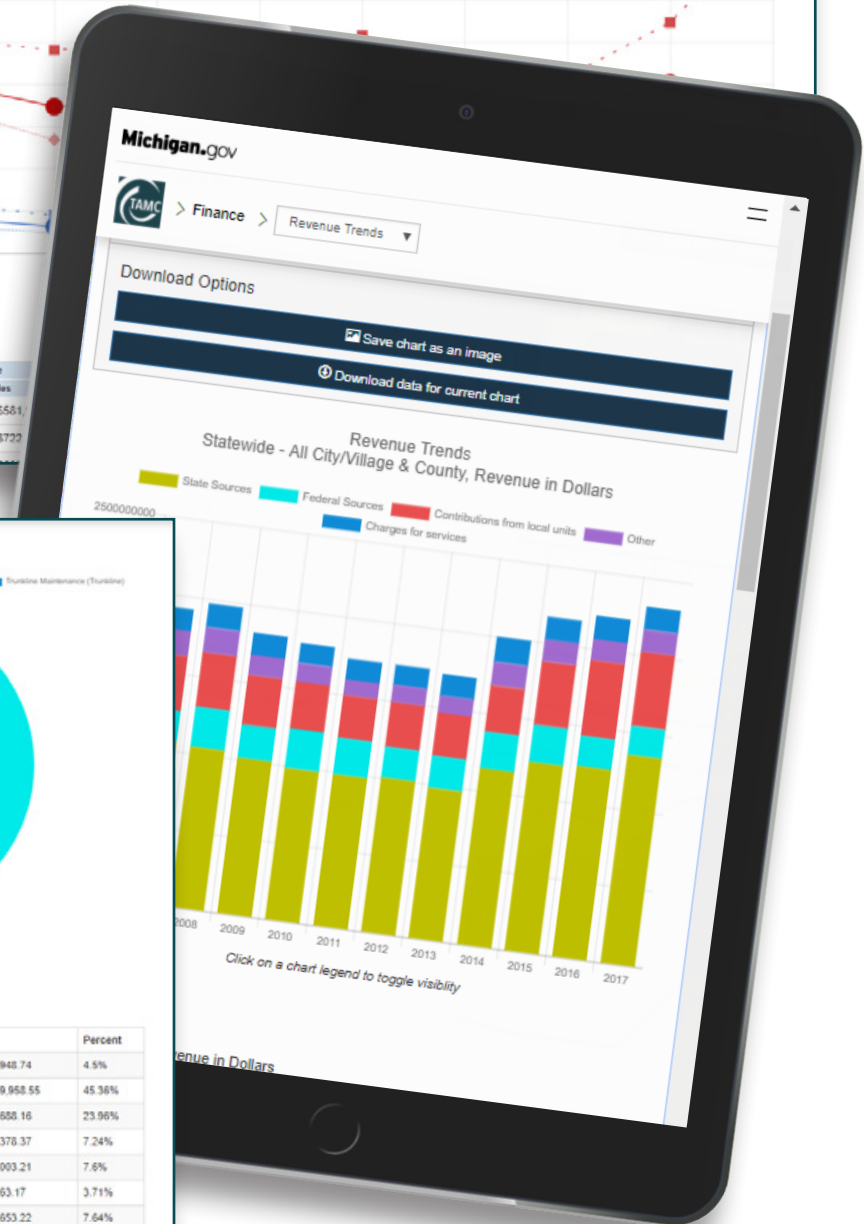
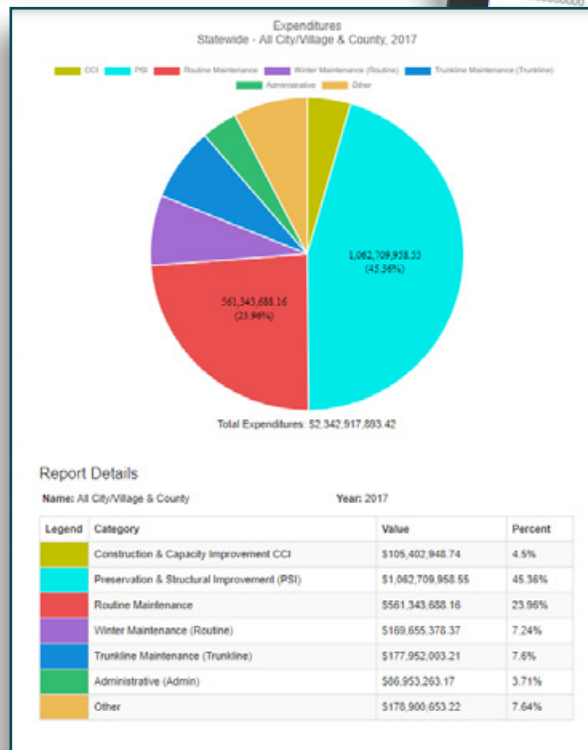
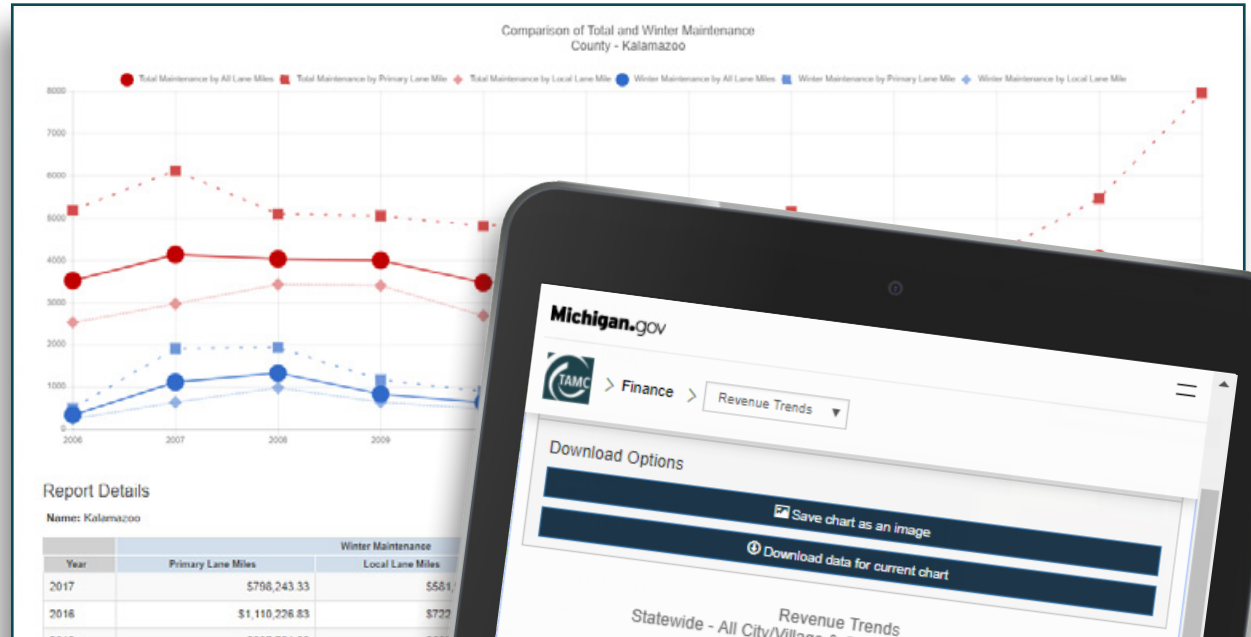

2018 ROAD CONDITION



As of 2018, over 36,000 lane miles are in poor condition, or 41% of all paved federal-aid roads (see Figure 1). Twelve years ago, 25% were in poor condition. Given the current rate of road deterioration and given the anticipated funding levels for road preservation and repair, the percentage of roads in poor condition will remain above 40% for the foreseeable future.

Paved Federal-Aid Road Condition

2007-2018

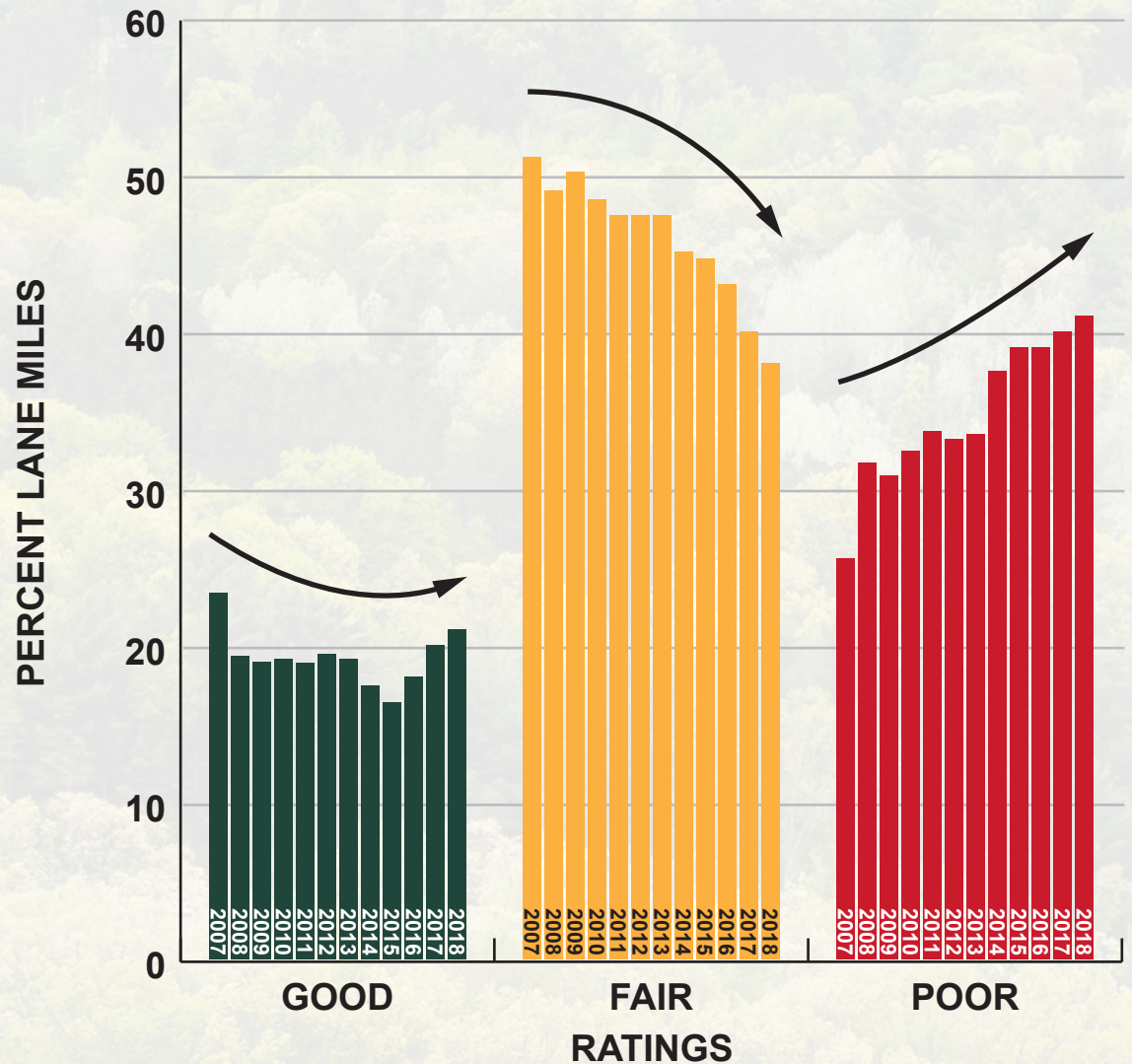

Figure 1
Source: 2007-2018 PASER Data Collection



In 2003, MDOT, county, regional, and metropolitan planning agencies joined together to determine the condition of Michigan's paved federal-aid roads. Only about 1/3 of Michigan's roads are eligible for federal-aid. Not all eligible roads are paved. Under

the direction of the TAMC, PASER was the tool chosen to measure the condition of pavements. Road raters evaluated surface condition and placed each segment of road into one of ten categories which were then consolidated into three categories:

good, fair, and poor. Agencies drove the roads in the late spring, summer and fall months. By mid-December, their rating data were loaded into a central database. What follows is an analysis of those data.

Analysis of Paved Federal-Aid Roads

Road agencies report on the condition of all paved federal-aid roads over the course of two years. Some agencies rate and report 50% of roads each year; some report on 100% every other year; and some chose to report on all their roads every year. Figure 2 is a map showing roads that were rated in 2017 and 2018. About 66% of the roughly 88,000 lane miles of paved federal-aid roads were rated in 2018. For the full statewide coverage, the remaining 34% was taken from ratings performed in 2017.

Paved Federal-Aid Roads

Rated in 2017 and 2018



Figure 2
Source: 2017-2018 PASER Data Collection

2016/17 vs 2017/18 Paved Federal-Aid Road Condition

Percent Lane Miles

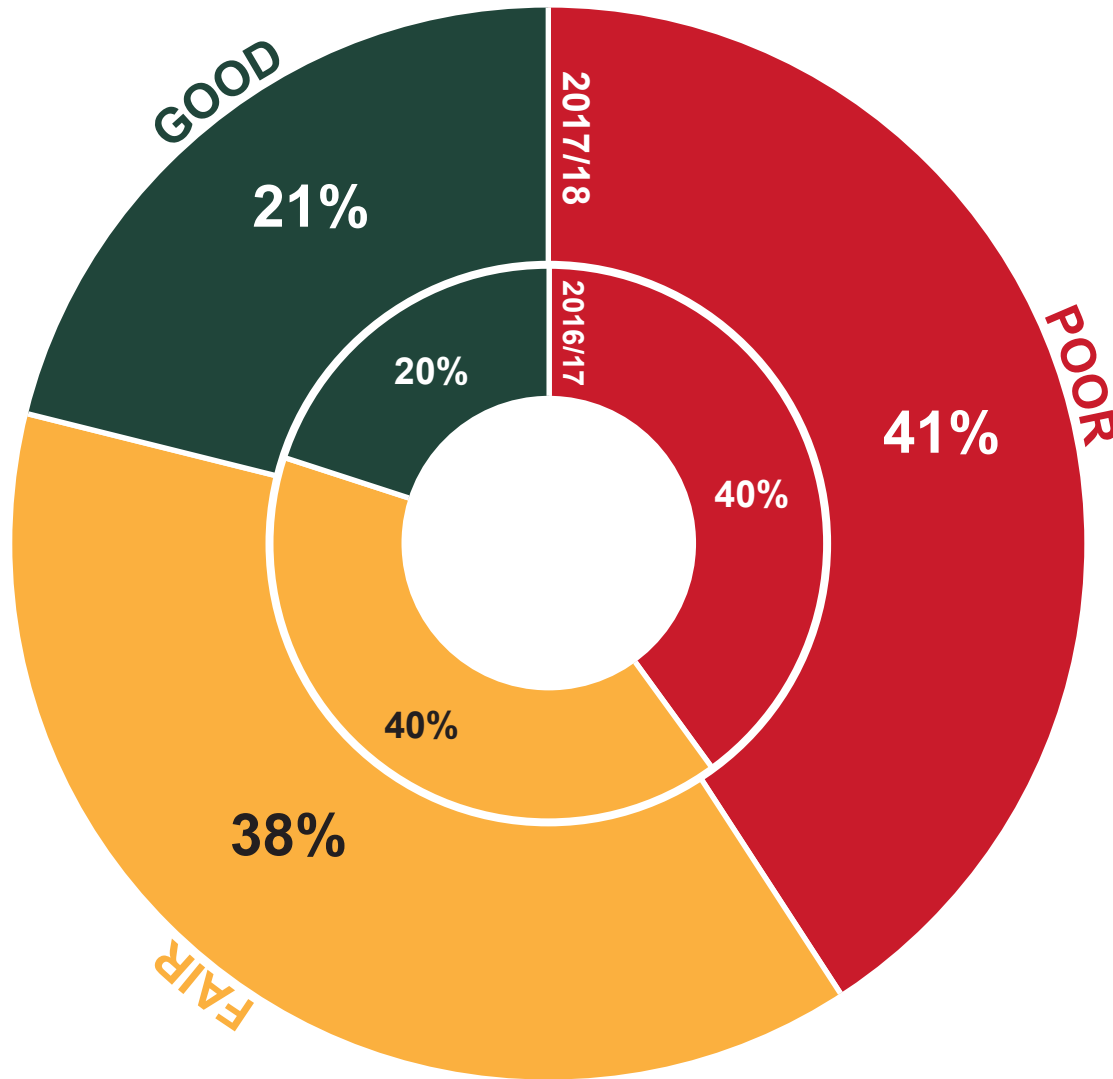

Figure 3

Source: 2016-2018 PASER Data Collection

As seen in Figure 3, the number of lane miles in good and fair condition decreased from 60% to 59% between 2016/17 and 2017/18. This 1% decline represents an additional 880 lane miles that are now in poor condition.



Pavement Cycle of Life

Every year, analysts examine the pavement data to determine the extent to which roads are improved or deteriorate over time. Figure 4, known as the "Pavement Cycle of Life," shows the results of this analysis. For well over a decade, more roads have deteriorated than have been improved. This has happened every year since 2005, and 2018 was not an exception. This trend must be reversed if Michigan's roads are to improve.



Michigan Pavement Cycle of Life

2015-2018

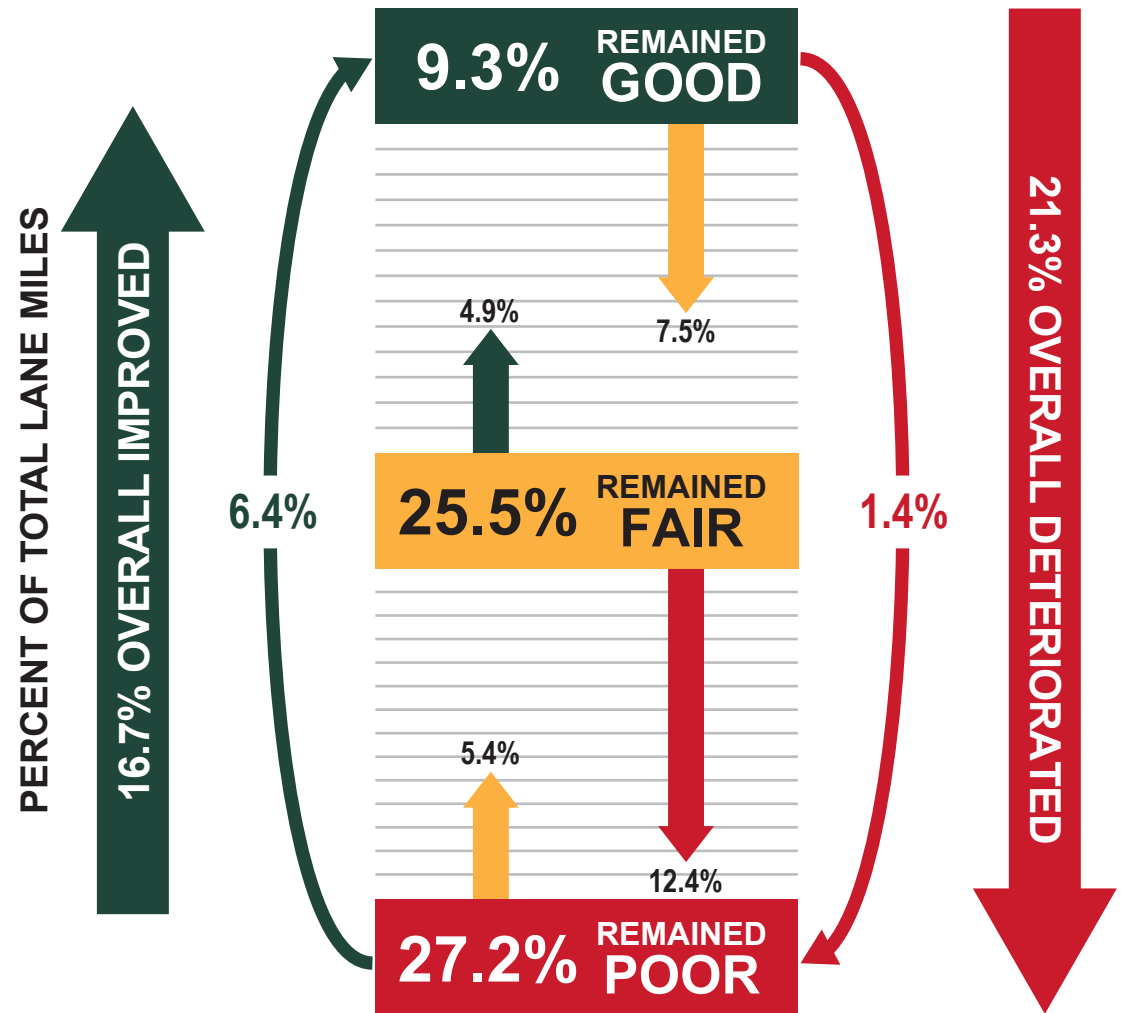

Figure 4
Source: 2015-2018 PASER Data Collection

Paved Federal-Aid Roads

By Functional Class

Functional Class

National Functional Class (NFC) are federally defined categories used to describe the “particular role of a roadway.” Freeways, arterials, minor arterials, and major collectors are all federal-aid eligible roads. Freeways carry the highest volume of passenger and commercial traffic. Arterials also carry large volumes of traffic and, together with freeways, comprise the federal National Highway System in Michigan. Minor arterials and major collectors primarily serve to connect traffic from local roads to the arterial and freeway systems. Figure 5 shows the condition of paved federal-aid roads in each category. As the exhibit shows, there is a direct correlation between category and condition, as agencies work to keep the most highly used roads in the best condition.

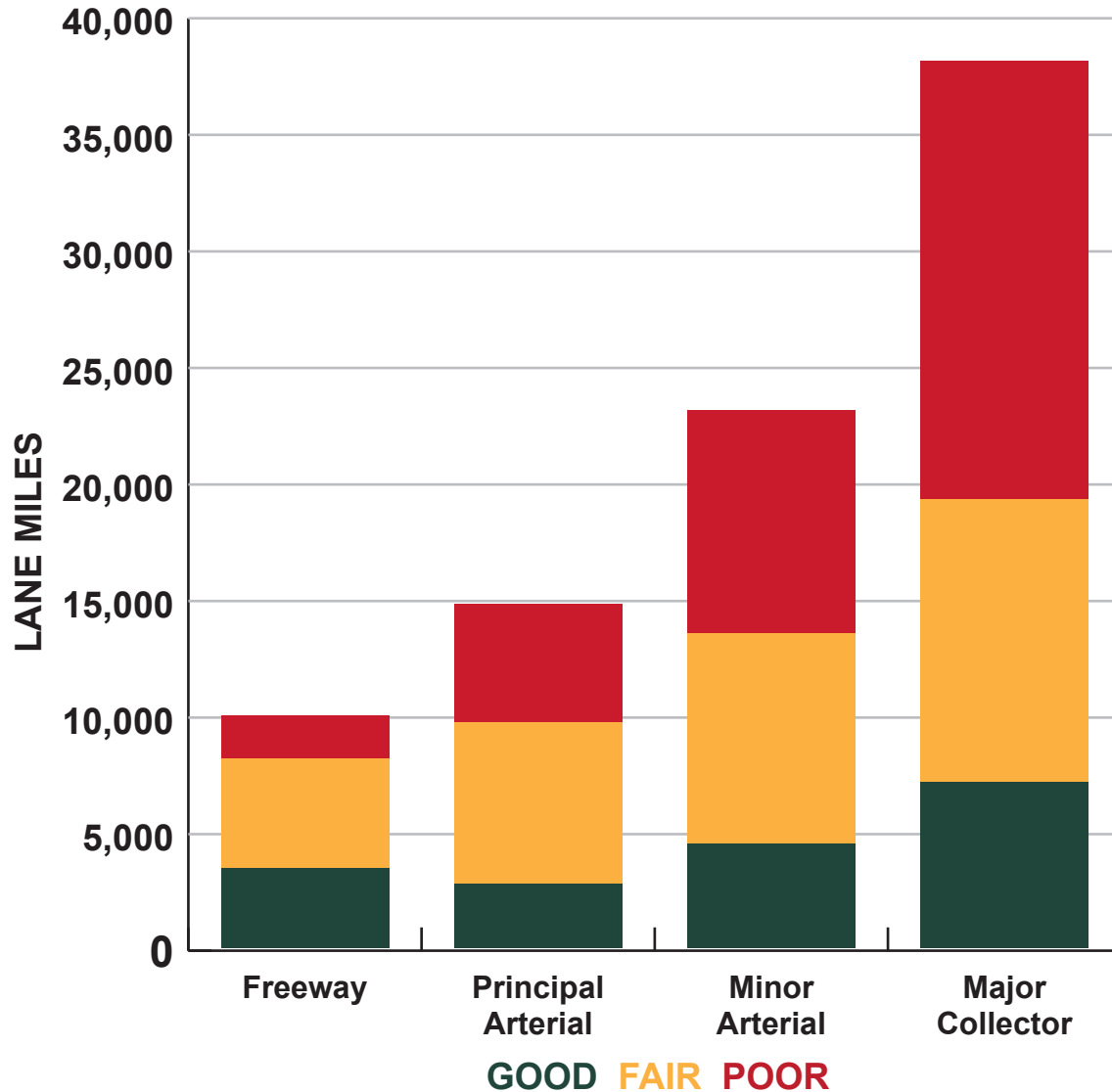

Figure 5

Source: 2017-2018 PASER Data Collection



Quality Management

Quality management of road rating data is conducted every fall. A single pavement technician surveys 1,200 lane miles of paved federal-aid roads and assigns PASER ratings to them. These roads act as samples. Every county in the state contains sample miles. At the close of each year, these samples are compared to the road agencies' ratings. The results of this comparison are shown as a bell curve, seen in Figure 6. On average, the road agencies rated their sample roads about $\frac{2}{5}$ of a rating higher than the pavement technician did. Much of this small difference can be attributed to the road agencies rating the samples in the fall, near the end of the construction season, after some of the sample roads have been improved.



2018 Team Ratings Minus Quality Ratings

Weighted by Lane Miles

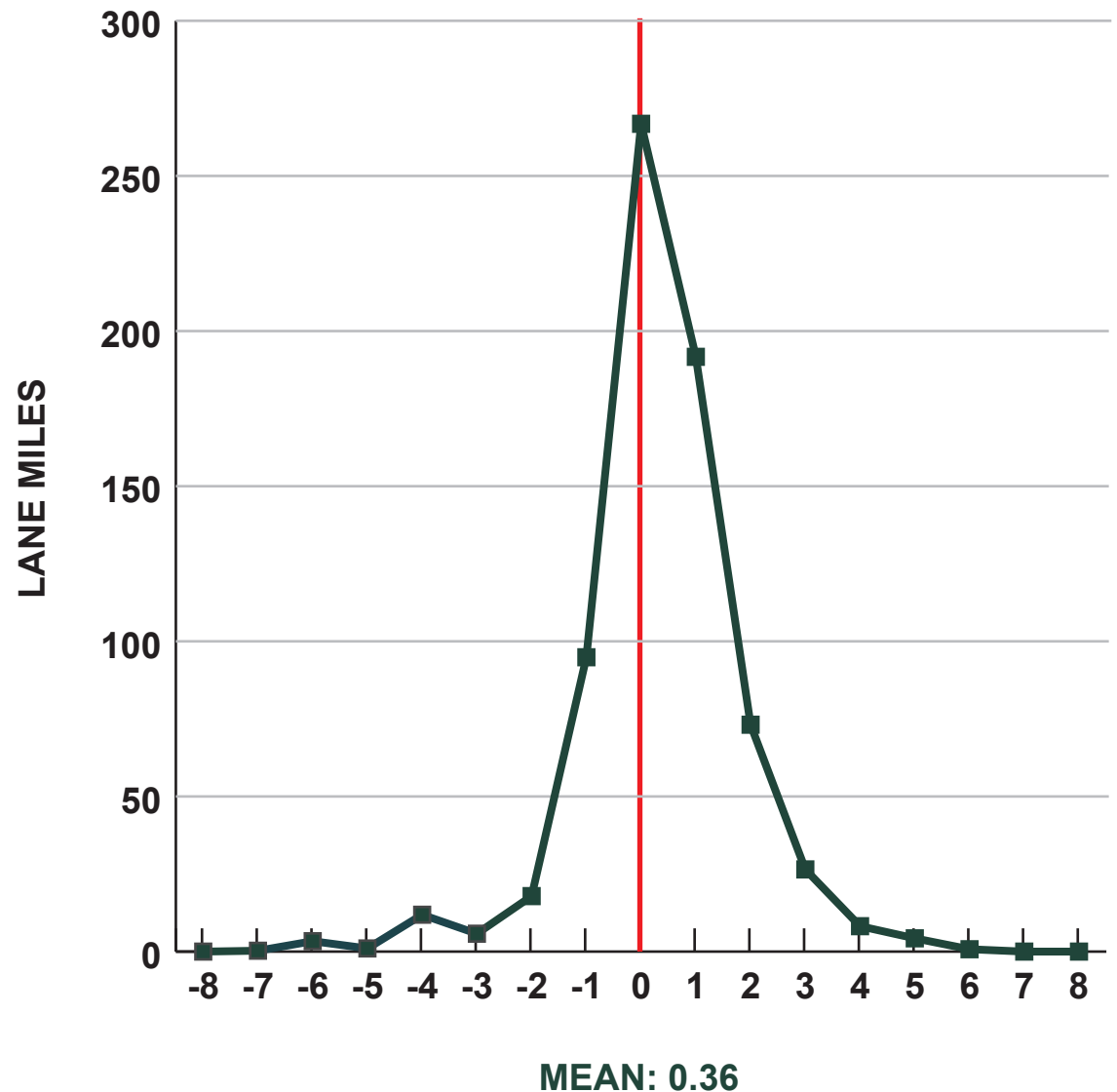

Figure 6

Source: 2018 PASER Data Collection

2018 Paved Non-Federal-Aid Road Condition

Percent Lane Miles

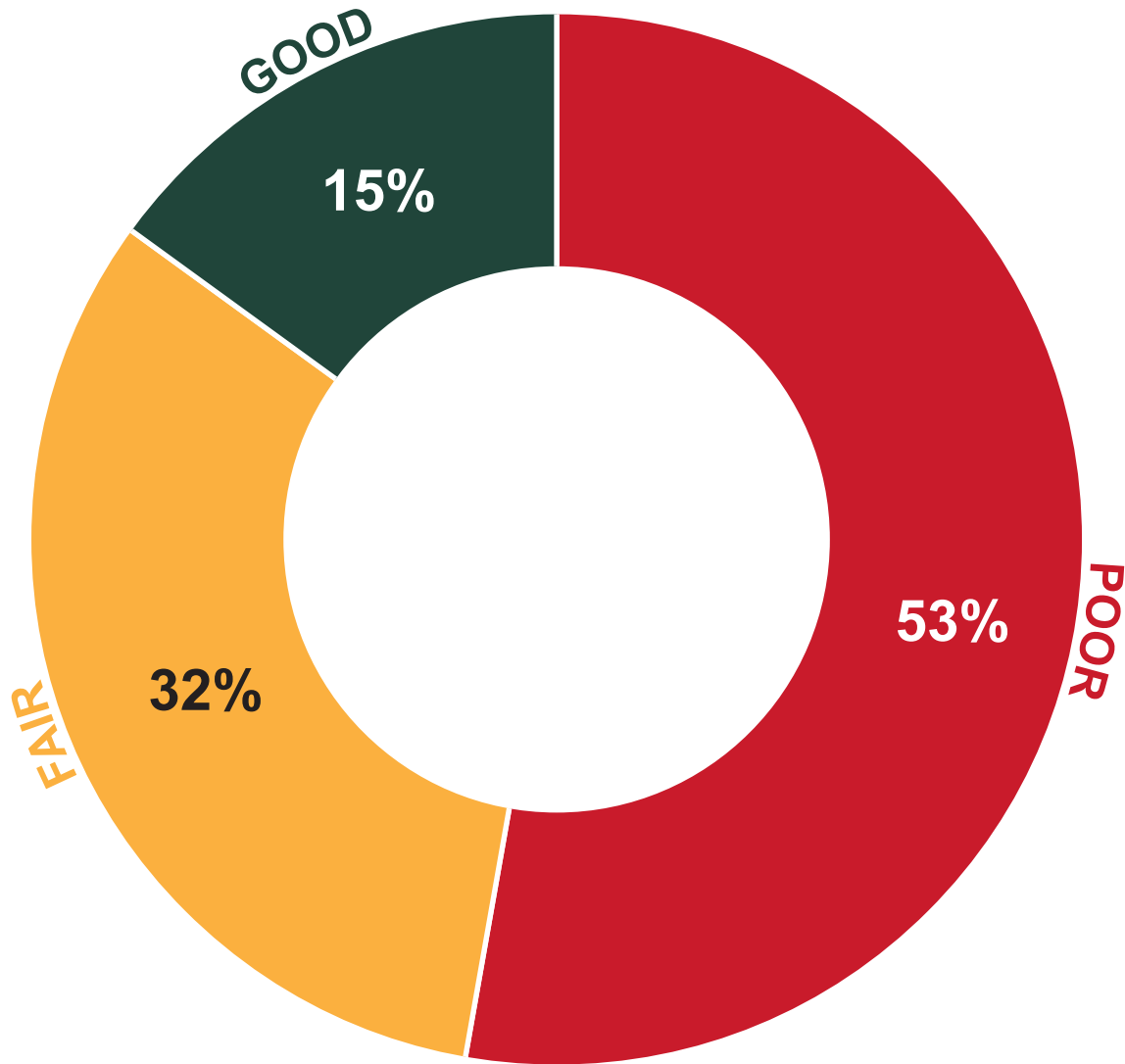
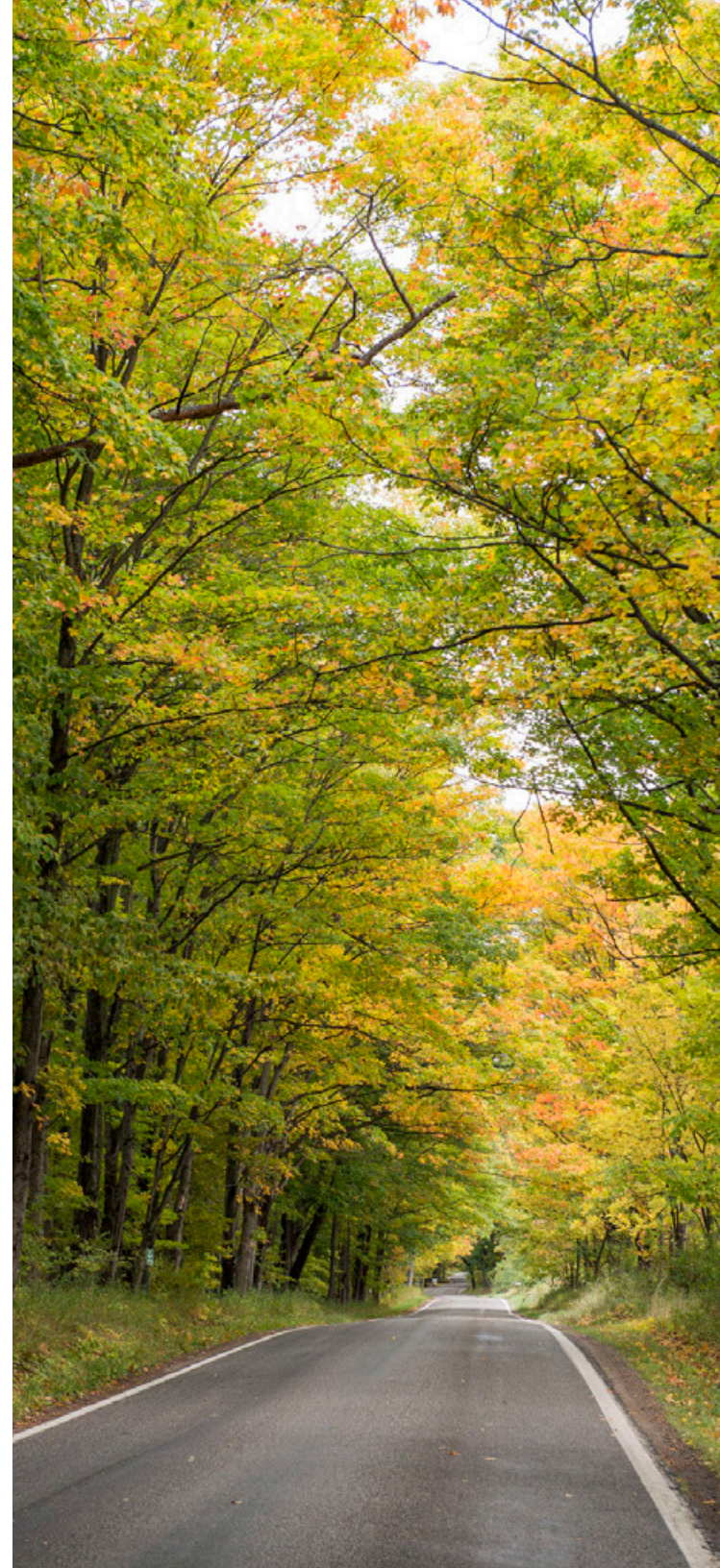

Figure 7

Source: 2018 PASER Data Collection



Analysis of Paved Non-Federal-Aid Roads

There are over 165,000 lane miles of non-federal-aid roads in Michigan. The federal government classifies these roads as being “Local Roads.” Each year, several road agencies choose to rate some or all of their paved non-federal-aid roads. Figure 8 shows in 2018, 79 agencies submitted ratings for 16,968 lane miles of these roads. Over 50% of these roads were found to be in poor condition as seen in Figure 7. Although it is not known if the roads that were rated represent a valid statistical sample, it is probably safe to assume that, as a class, non-federal-aid roads are in worse condition than federal-aid roads.

Paved Non-Federal-Aid Roads

Rated in 2018 – 16,968 Lane Miles

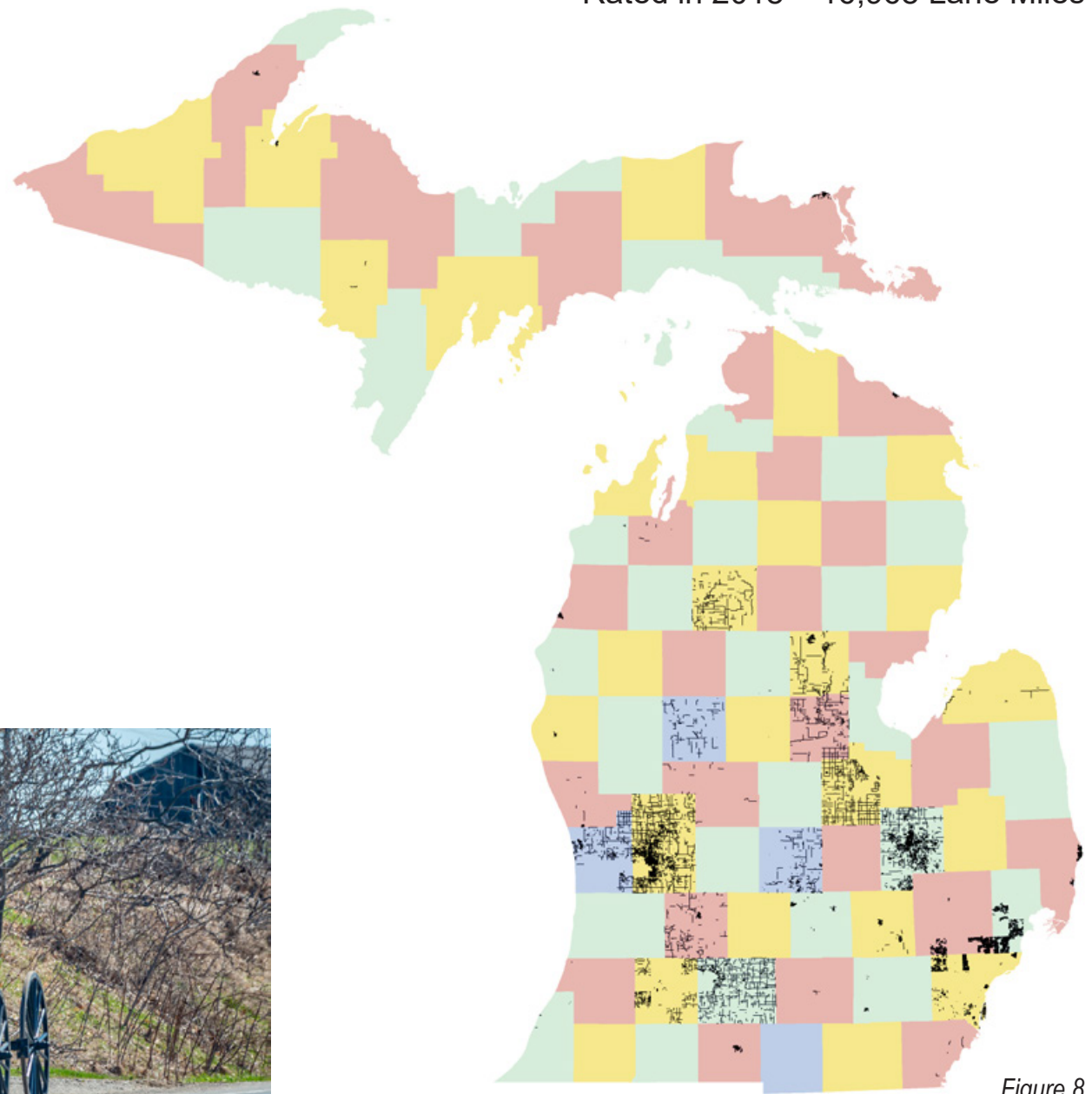

Figure 8

Source: 2018 PASER Data Collection



2020-2030 Forecast of Pavement Condition

All Paved Federal-Aid Roads

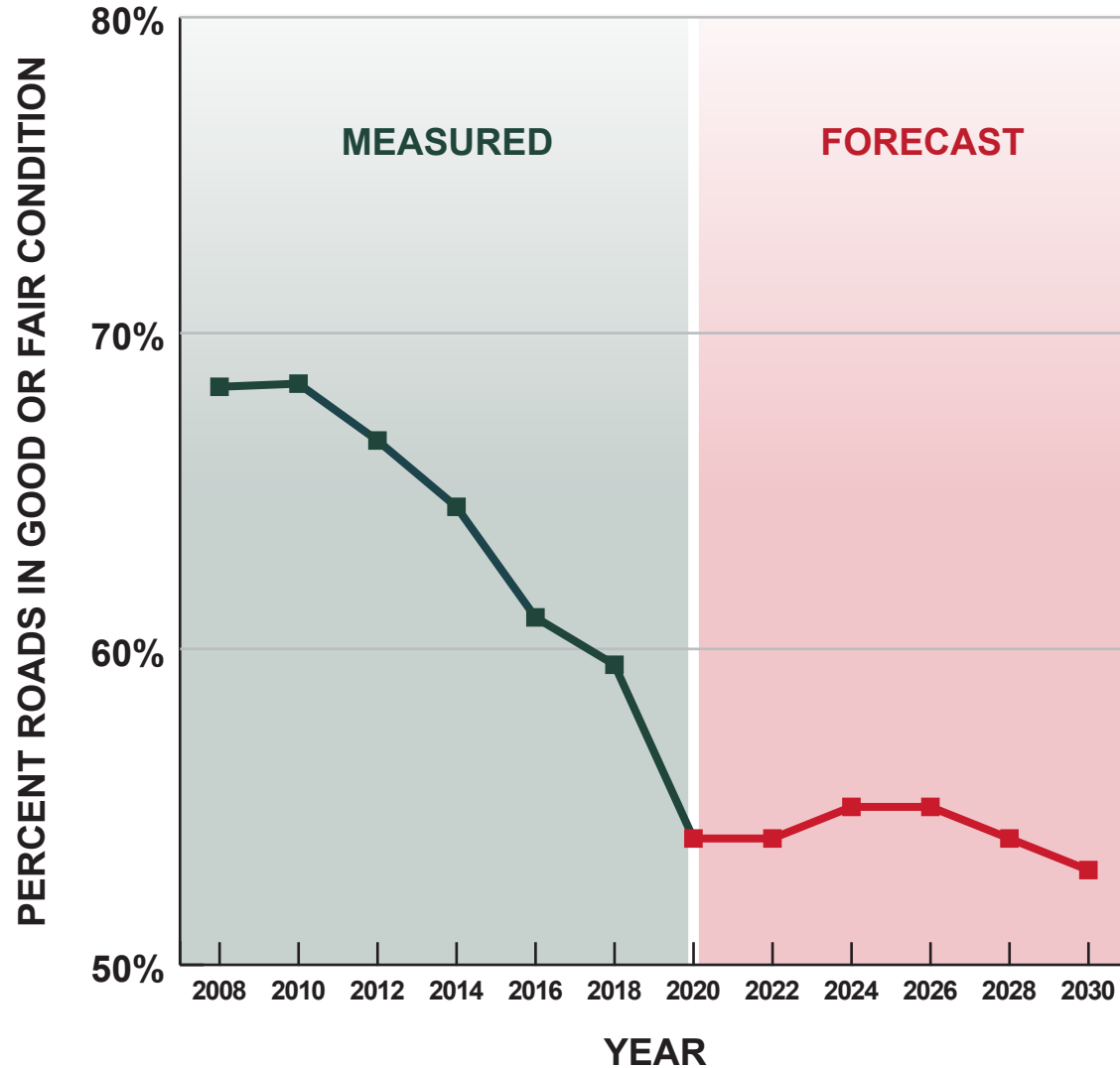
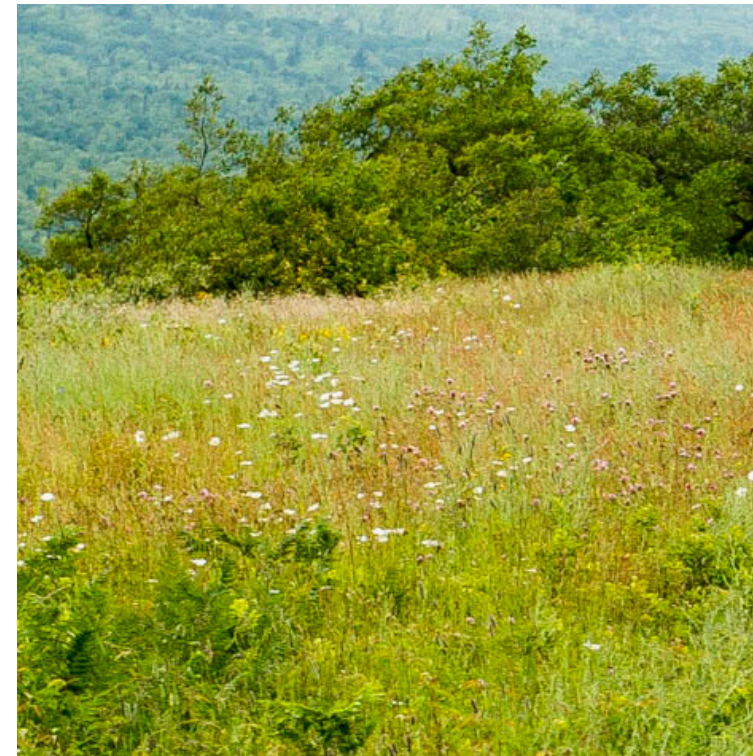

Figure 9
Source: TAMC April 2019

Condition Forecast

Over the next 12 years, the condition of the paved federal-aid roads can be expected to remain about the same. In November of 2015, the Michigan legislature passed a transportation funding package that will incrementally increase road funding. The additional funding began in 2017. The increases will continue until 2021 and then increase with inflation. A portion of that funding will come from Michigan income taxes. The expected increase in funding will halt the steady decline in pavement condition as seen in Figure 9. But no appreciable improvement can be expected. Any future changes in funding will affect the forecast.





2018 BRIDGE CONDITION



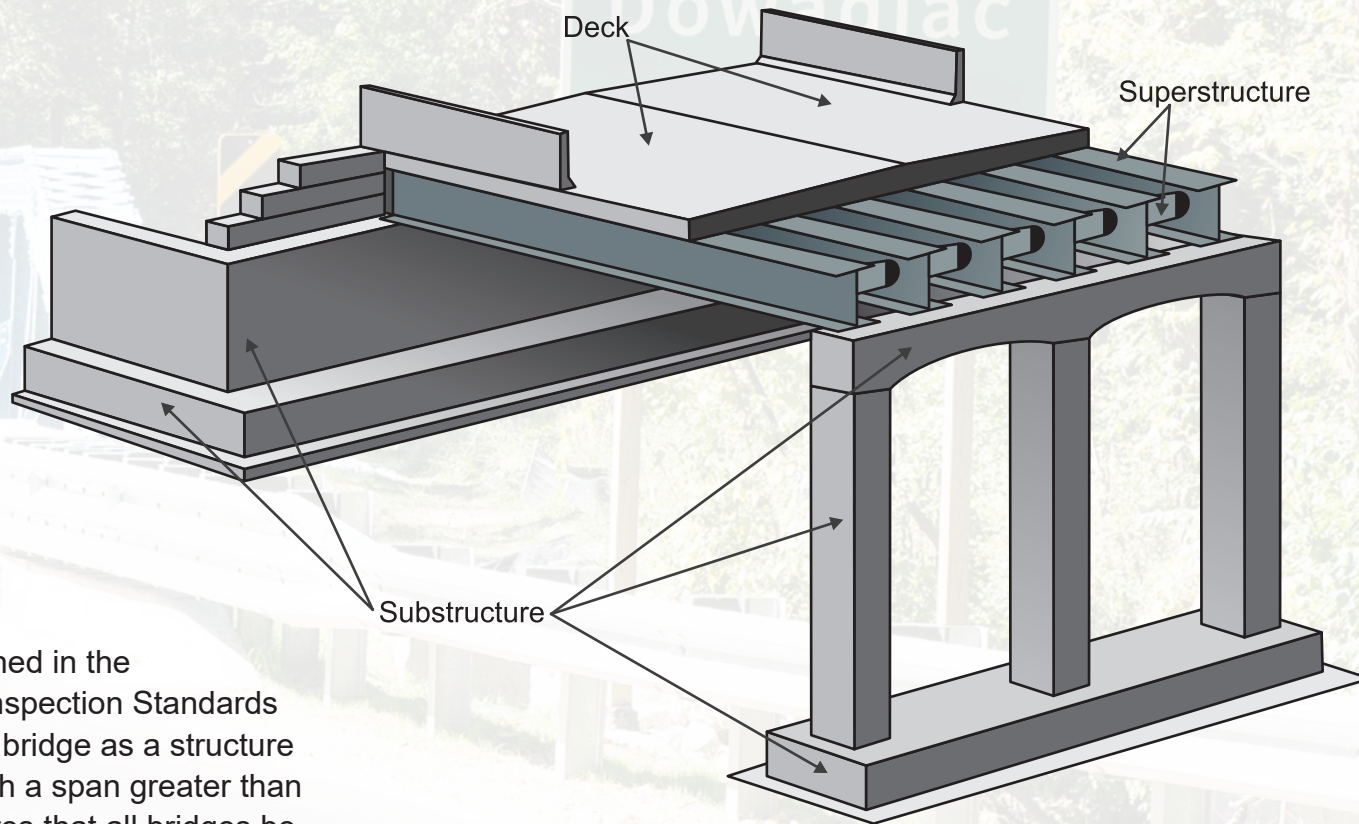

Federal law, outlined in the National Bridge Inspection Standards (NBIS), defines a bridge as a structure carrying traffic with a span greater than 20 feet and requires that all bridges be inspected every two years to monitor and report condition ratings. The FHWA requires that for each applicable bridge, the performance measures for determining condition be based on the minimum values for substructure, superstructure, deck, and culverts.



Condition ratings are based on a 0-9 scale and assigned for each culvert, or the deck, superstructure, and substructure of each bridge. These ratings are recorded in the NBI database. Condition ratings are an important tool for transportation asset management, as they are used to identify preventative maintenance needs, and to determine rehabilitation and replacement projects that require funding.

An analysis of bridge conditions in Michigan shows that bridge-owning agencies and decision makers are losing ground due to an aging inventory, rising costs and revenue challenges. From 2004 to 2018, the network of bridges in the state saw a steady reduction in the number of poor bridges.

However, from 2011 to 2018 the reduction in poor bridges has slowed while the number of fair bridges has increased. These fair bridges represent a large need for preservation or there is a risk for increasing the number of poor bridges. This can be attributed to:

1. Progress being made initially in reducing the number of structurally deficient bridges in the state.
2. More bridge owning agencies are implementing preventive maintenance “mix of fixes” strategies on bridges that they own, leading to bridges remaining in fair condition for longer periods of time.
3. Rising costs and an increasing inventory of fair bridges creates a preservation need that exceeds available funding.

NBI Condition Ratings		
7-9	Good Condition	Routine maintenance candidate.
5-6	Fair Condition	Preventative maintenance and minor rehabilitation candidate.
4	Poor Condition	Poor Major rehabilitation or replacement candidate.
2-3		Serious or Critical Emergency repair or high priority major rehabilitation or replacement candidate. Unless closely monitored it may be necessary to close until corrective action can be taken.
0-1		Imminent Failure or Failed Major rehabilitation or replacement candidate. Bridge is closed to traffic.



Comparing Michigan's progress toward reducing poor bridges with the rest of the nation, and with our neighboring states, highlights the need for continued concern regarding Michigan's ability to preserve its strategic bridge assets. Figure 10 indicates that Michigan has a significantly higher percentage of poor bridges than other Great Lakes states. Nationally the data shows Michigan among the bottom 10 states. An analysis of the 2018 NBI data shows that 5.5% of MDOT bridges and 14.1% of county, city and village bridges were in poor condition, resulting in Michigan having 10.7% of all highway bridges in poor condition.



2018 Percent Poor Bridges

All Highway Bridges (Great Lakes States)

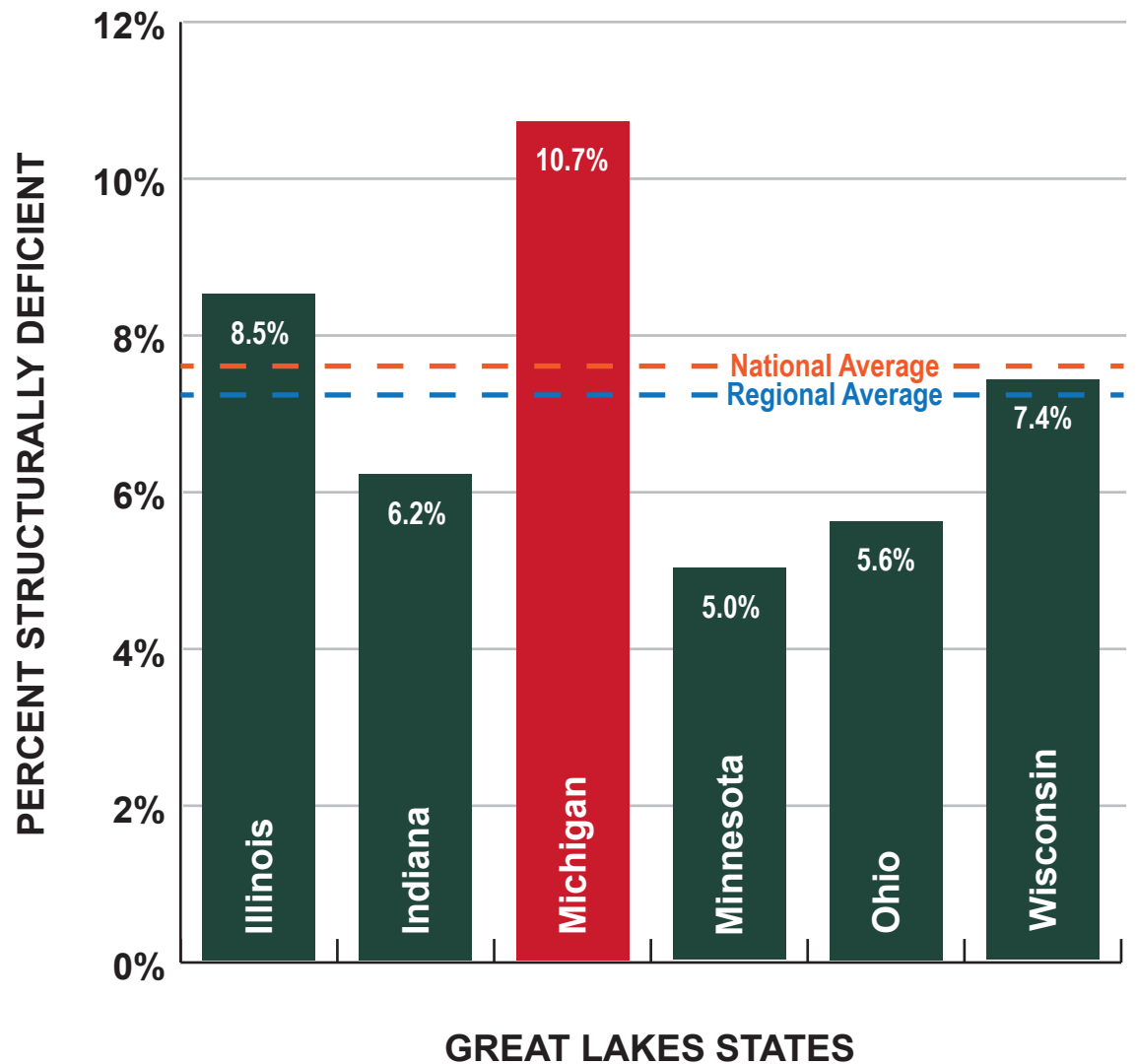

Figure 10

Source: 2018 Federal Data Executive Summaries

2010-2018 Bridge Condition

All Roadway Bridges

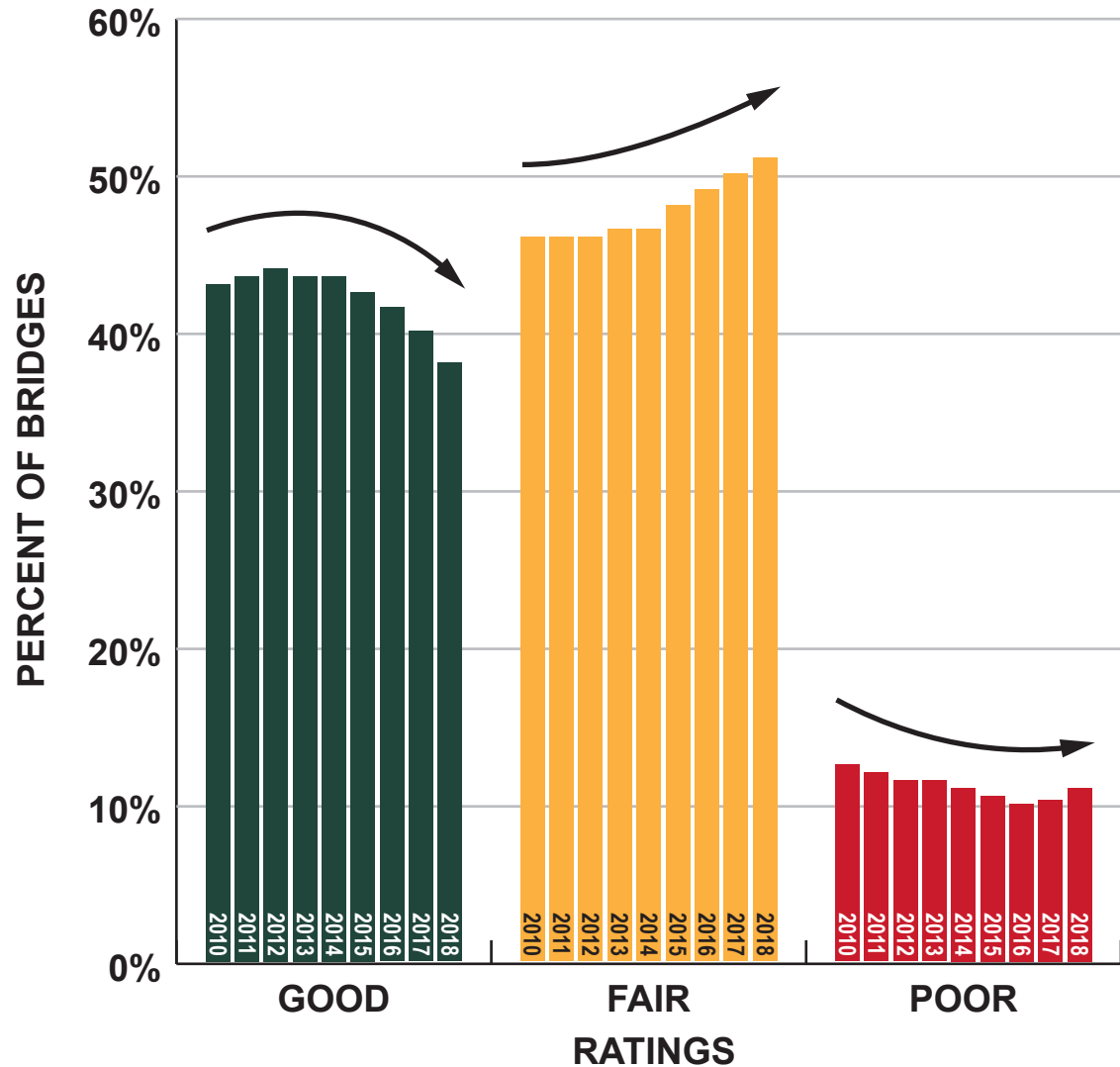

Figure 11

Source: MDOT, 2010-18 Michigan Bridge Inventory

Figure 11 summarizes the percentage of Michigan bridges in good, fair, and poor condition for the years 2010-2018. Michigan bridge owners and decision makers have reduced the percentage of bridges in poor condition, while the number of fair bridges has increased and the number of good bridges has decreased. Although the trend-line for the poor category was decreasing, in the past two years it has begun to increase, and shows a concerning trend. Without continued implementation of effective preventive maintenance strategies and additional funding directed toward bridge maintenance, those fair to poor borderline bridges are in danger of dropping into the poor category.

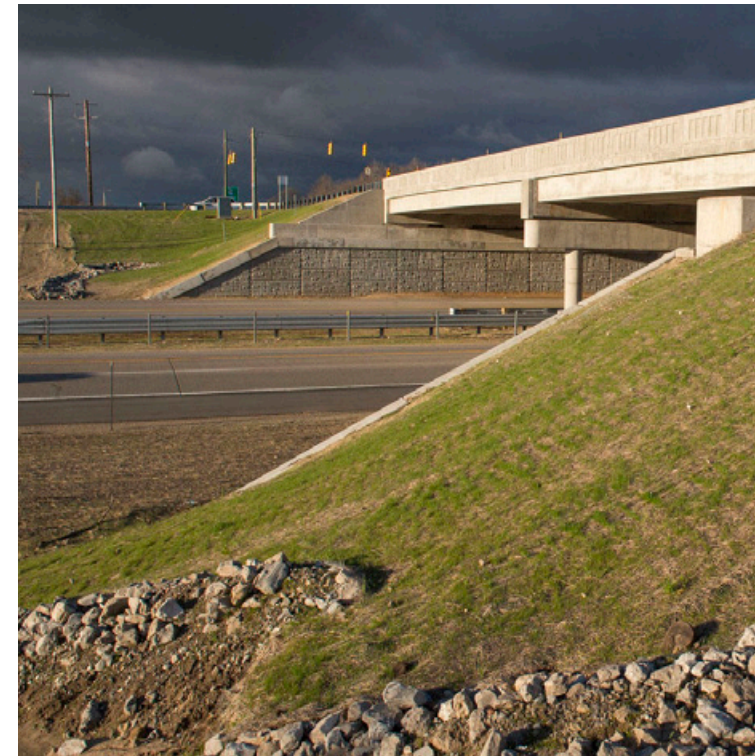

Figure 12 shows that local bridge owners have maintained the number of poor bridges, but the number of poor bridges is starting to increase. The number of good bridges has decreased, and the number of fair bridges has increased. It is important that bridge-owning agencies apply strategic preventive maintenance strategies to maintain or reduce the number of bridges in fair condition (NBI Ratings of 5 or 6) to prevent them from dropping into the poor category (NBI Rating <5) where more expensive repairs are necessary.



2015-2018 Local Bridge Condition Trend

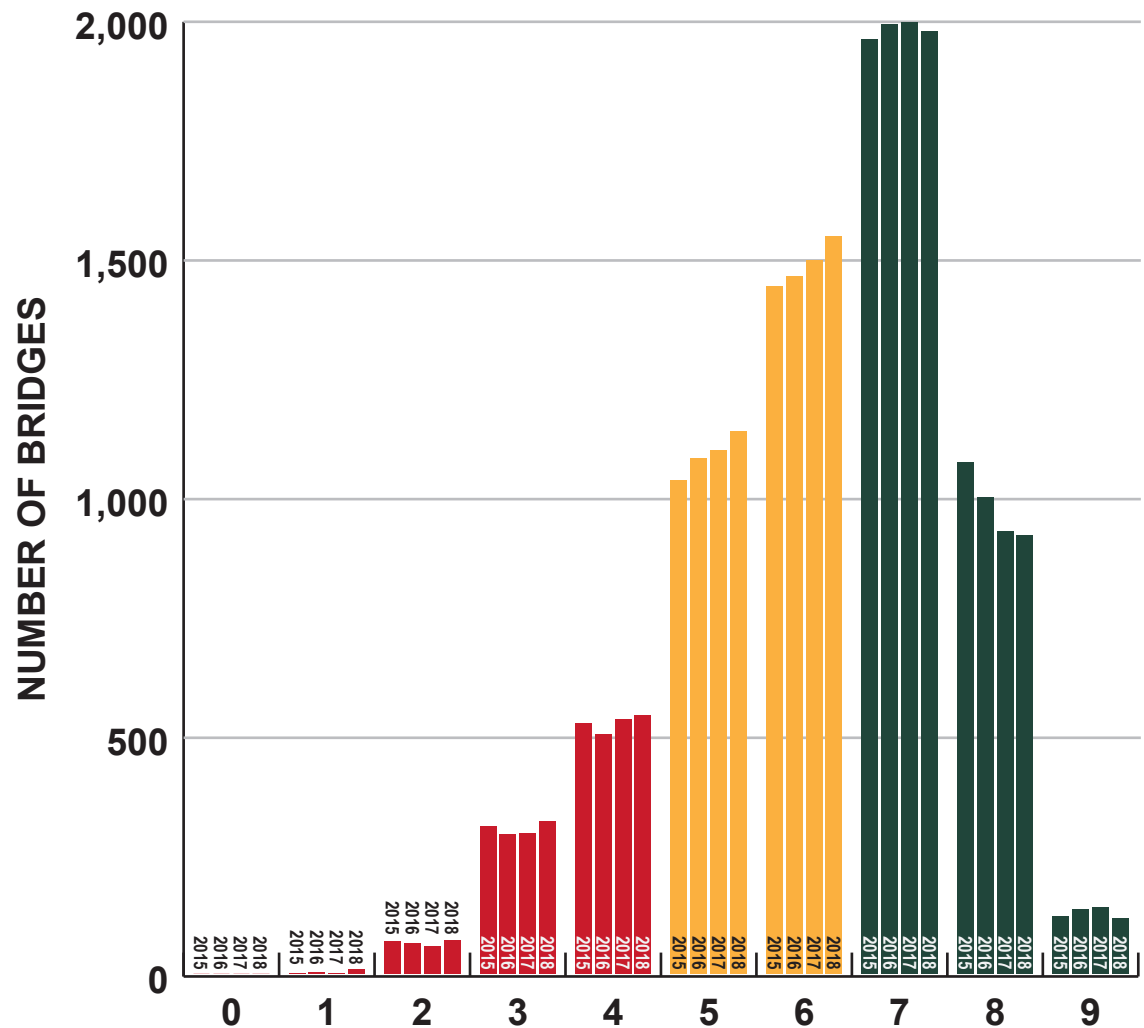

Figure 12

Source: MDOT, 2015-2018 Michigan Bridge Inventory

2015-2018 Trunkline Bridge Condition Trend

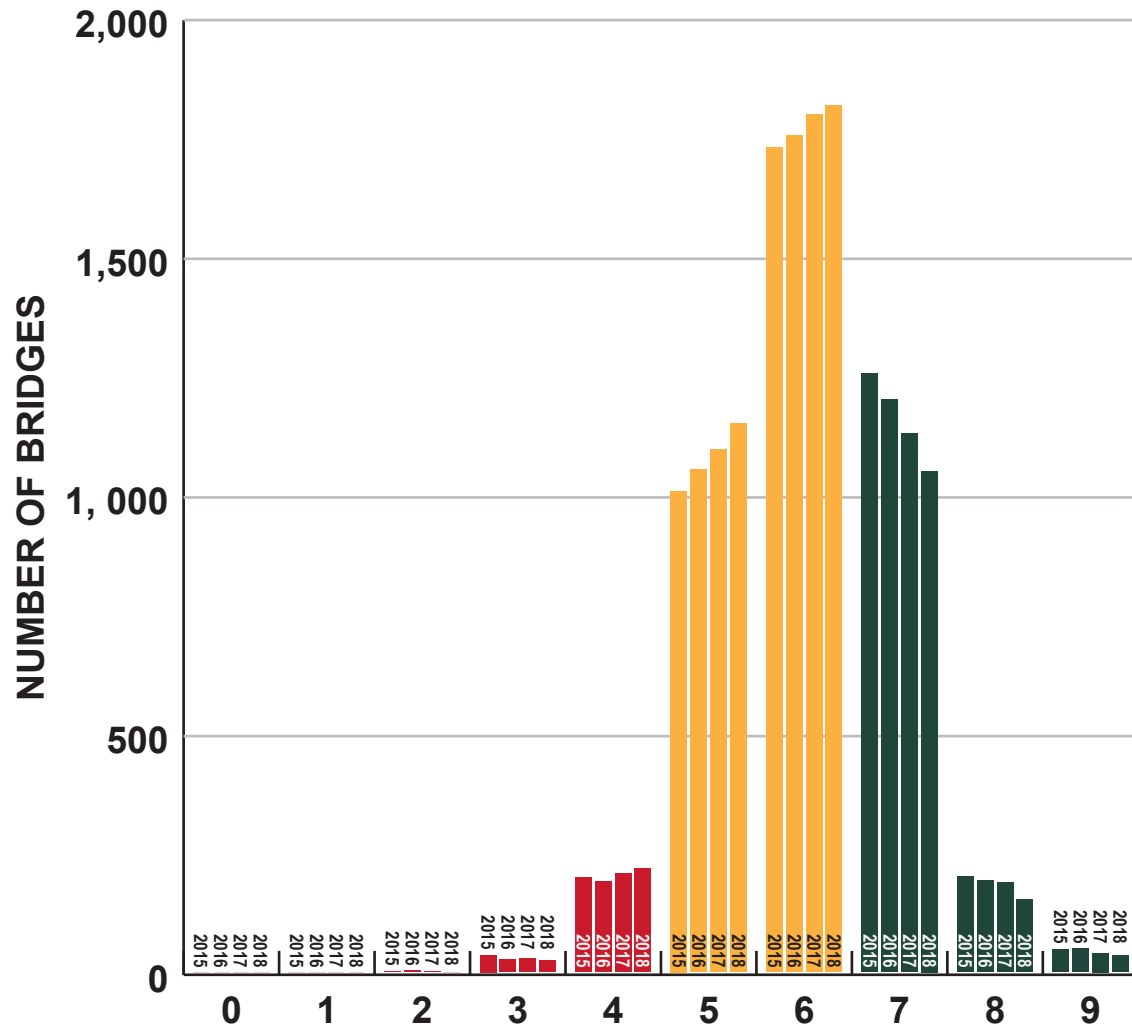

Figure 13

Source: MDOT, 2015-18 Michigan Bridge Inventory

Figure 13 shows that MDOT's progress in reducing the number of poor bridges on state-owned roads has also slowed over the last four years. Until recently, MDOT has been able to maintain the number of fair bridges before they reach the poor category, while increasing the number of good and fair bridges. An aging infrastructure and rising costs have reversed some of that progress. The number of fair bridges has increased, and in both 2017 and 2018, the number of poor bridges increased slightly as preservation needs exceed available revenues. Maintaining or improving the bridges rated in good or fair condition is imperative to prevent the number of bridges in the poor category from increasing further.



Bridge Condition Forecast

Working from current bridge condition information (NBI), bridge deterioration rate, project costs, expected inflation, and fix strategies, the Bridge Condition Forecasting System (BCFS) estimates future condition of bridges. Figure 14 indicates the combined overall bridge condition of all Michigan's bridges is expected to continue to decline after 2018. By 2028, nearly all of the progress made toward improving bridge condition since 2004 could be lost.

While additional highway funding was approved at both the state and federal level, no new funds were earmarked specifically for local bridge programs. Therefore, this forecast assumes no additional spending on bridges beyond those funds already designated for that purpose.



2019-2027 Bridge Condition Forecast

All Roadway Bridges (MDOT and Local Agency)

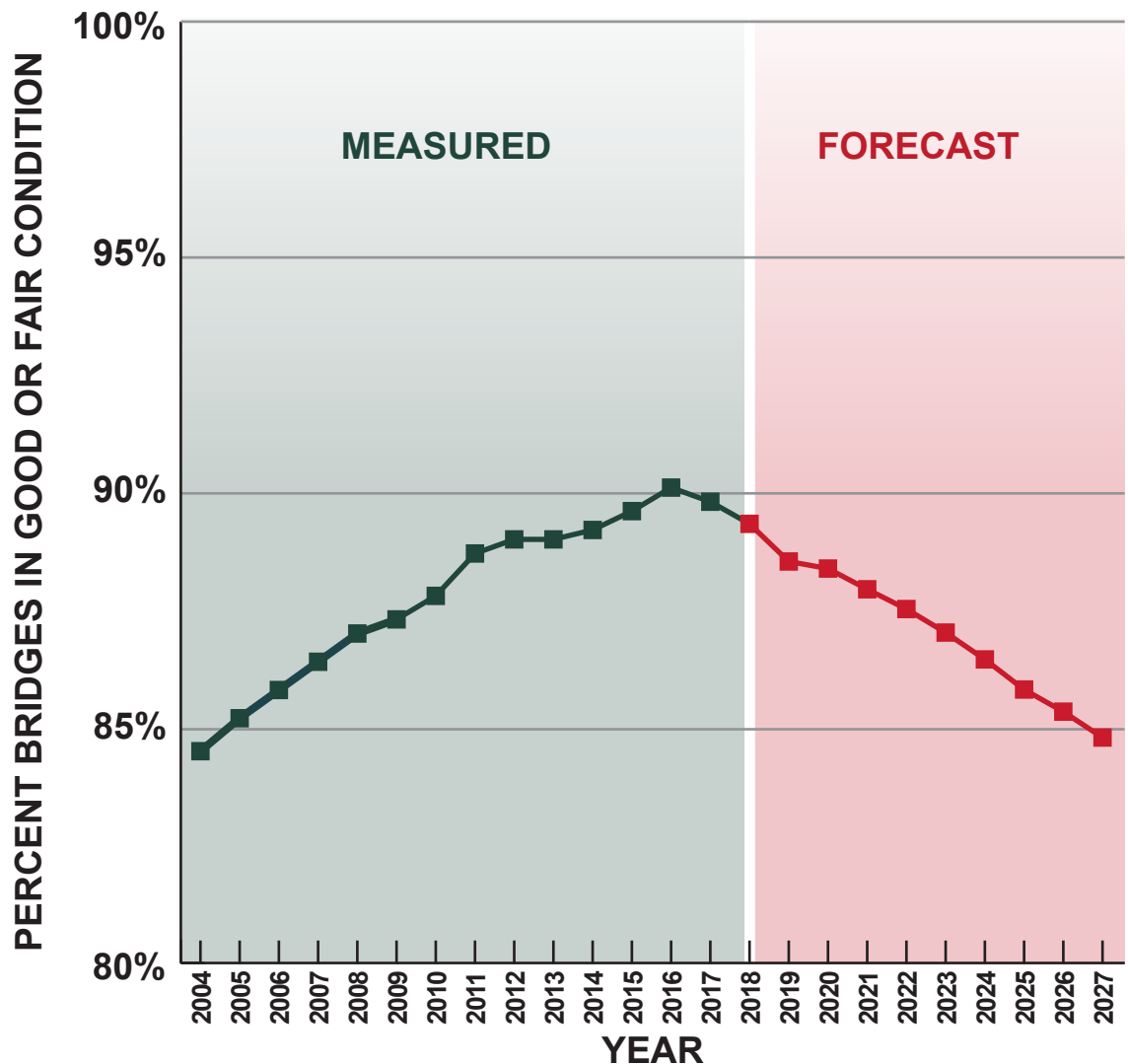
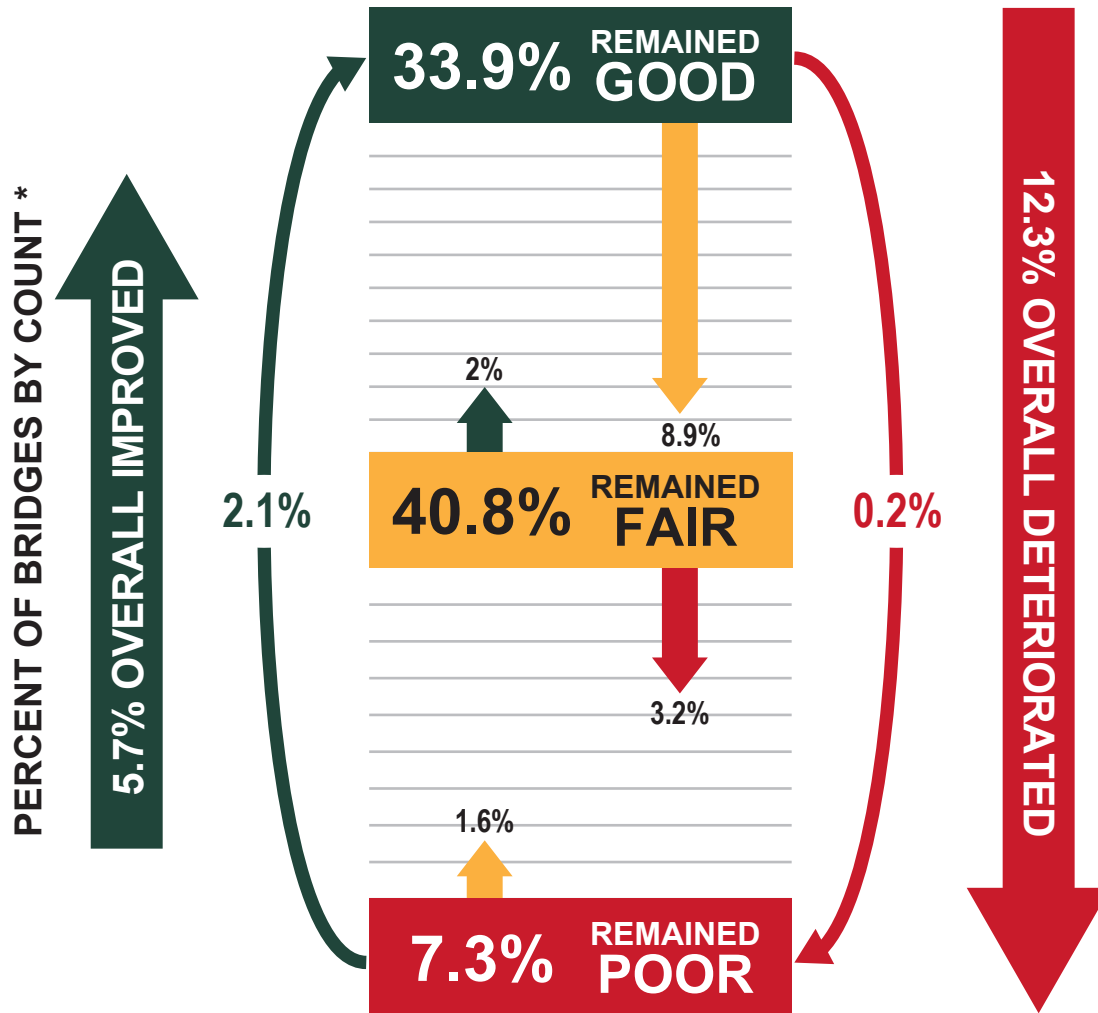

Figure 14
Source: MDOT March 2019

Michigan Bridges Cycle of Life

2015-2018



* Does not include bridges added or removed in this time period

Figure 15
Source: MDOT March 2019

Bridge Cycle of Life

Bridges, similar to roads, deteriorate through a cycle of life starting from good condition, to fair and ultimately to poor. There are many places where performing some Capital Preventive Maintenance (CPM) at a lower cost compared to a reconstruction or deck replacement can prolong the life of a bridge for many years.

Figure 15 shows the percentage of bridges that have improved or deteriorated into each of the major condition categories over the last four years (2015 – 2018). Michigan’s overall goal is to reduce the number of poor bridges, but unfortunately over this time span, 12.3% of Michigan’s bridges have worsened while only 5.7% of the bridges were improved.





INVESTMENT REPORTING



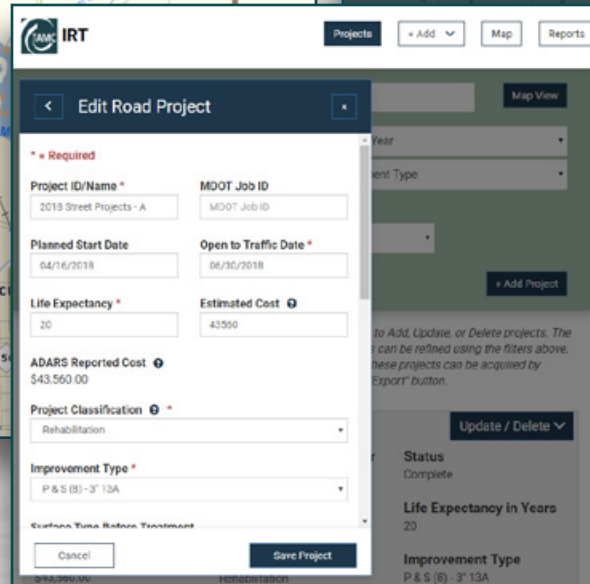
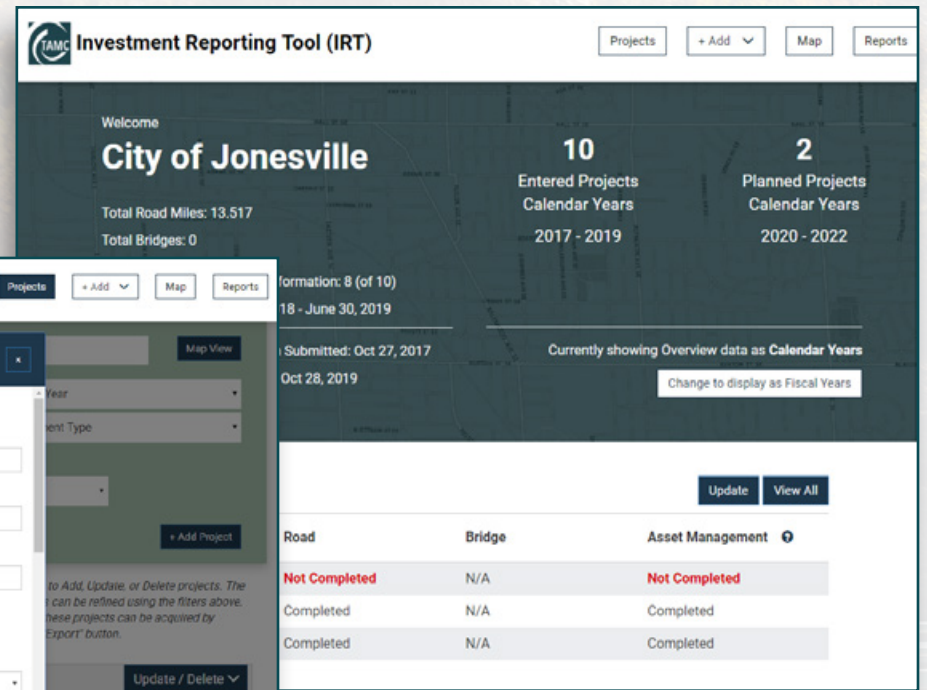
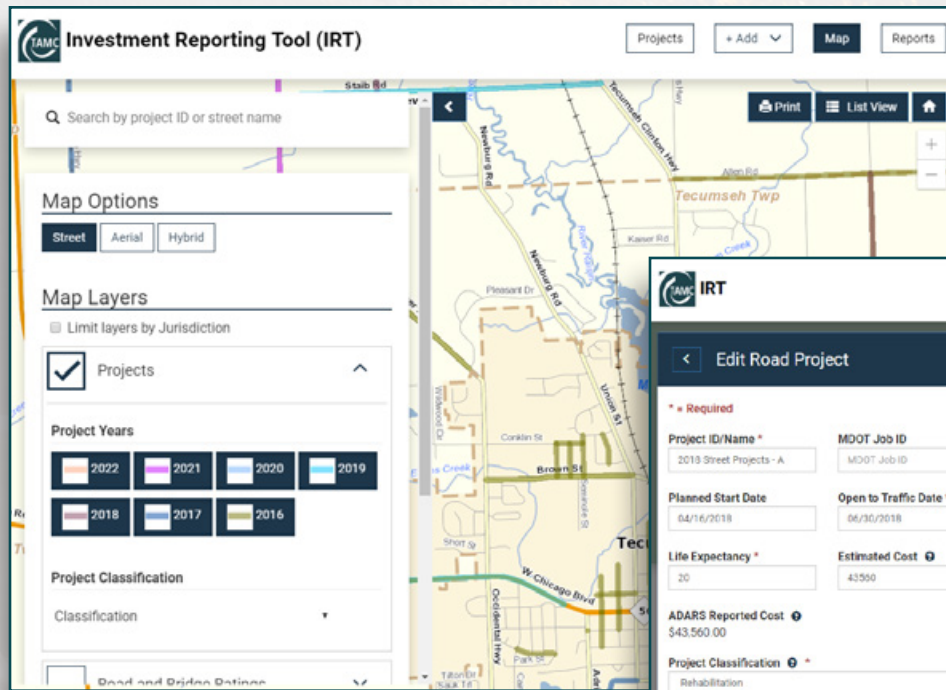

The IRT was developed by the TAMC to allow all Michigan road agencies to satisfy the requirements of Act 51. The basic requirements are that road-owning agencies report on projects they have completed and projects which are planned in the next three years. In October 2014, the reporting requirements were made mandatory and are based on an agency's fiscal year end date. The TAMC provides training and a help desk to assist agencies in satisfying this reporting requirement.

Since its initial inception in 2005, the IRT has been refined and updated, reflecting customer feedback. In 2017, the IRT was fully redesigned and continues to be improved with new enhancements on a quarterly basis. In addition to reporting requirements, it is also a tool to manage road and bridge assets.

The IRT offers an initial summary of an agency's entered projects and status of its compliance reporting. One of the main features of the IRT is a map view that shows the location of road projects reported by the road agency. Recent upgrades to the IRT allow agencies to print customized maps and reports specific to their respective agency. Both completed and planned projects can be displayed in newly-designed reports.

Project data can be entered graphically or in tabular format. A survey of asset management information has also been included, which is also part of the reporting requirement. This allows agencies to voluntarily submit written asset management plans and describe the asset management process they use. A summary of the survey responses follows later in this section.

Act 51 Compliance Reporting

The IRT has been linked to Michigan’s Act 51 Distribution and Reporting System (ADARS). Both IRT data and ADARS data must be submitted within 120 days of an agency’s fiscal year end date. However, this does pose some reporting challenges at the statewide level as project data is received throughout the year versus a common annual deadline.

2016 was the first complete year of road and bridge project investment data reporting. Data for calendar year 2017 includes projects submitted by more than 600 agencies and includes over 16,000 miles of road projects and nearly 250 bridge projects. The total investment reported exceeds \$1.2 billion dollars.

Data for 2018 projects is currently being submitted. As of April 2019, over 5,000 road and bridge projects have been received by the TAMC. In addition, nearly 3,600 planned road and bridge projects with over 14,100 lane miles have been entered by local agencies for FY 2019-2021.



Road Projects Details

Agencies are required to report road projects based on four project work types. The work types are Light Capital Preventive Maintenance (Light CPM), Heavy CPM,

Rehabilitation, and Reconstruction. The following table presents the number of projects, level of investment and miles of projects by these work types.

2017 Road Projects Details			
Type of Projects	Count	Cost	Lane Miles
Light CPM	994	\$46,620,855	4,891
Heavy CPM	1,690	\$274,014,963	7,402
Rehabilitation	1,355	\$331,849,682	3,004
Reconstruction	642	\$408,458,923	1,234
Total Number of Road Projects:	4,681	\$1,060,944,424	16,531

Bridge Projects Details

The following table presents the number bridge projects and level of investment by the five work types. The chart shows the breakdown of the projects performed by ownership, whether it be city/village, county or a state owned and maintained bridge structure.

Bridge projects are reported based on four project work types. The work types are Maintenance, Capital Preventative Maintenance (CPM), Rehabilitation, and Replacement.

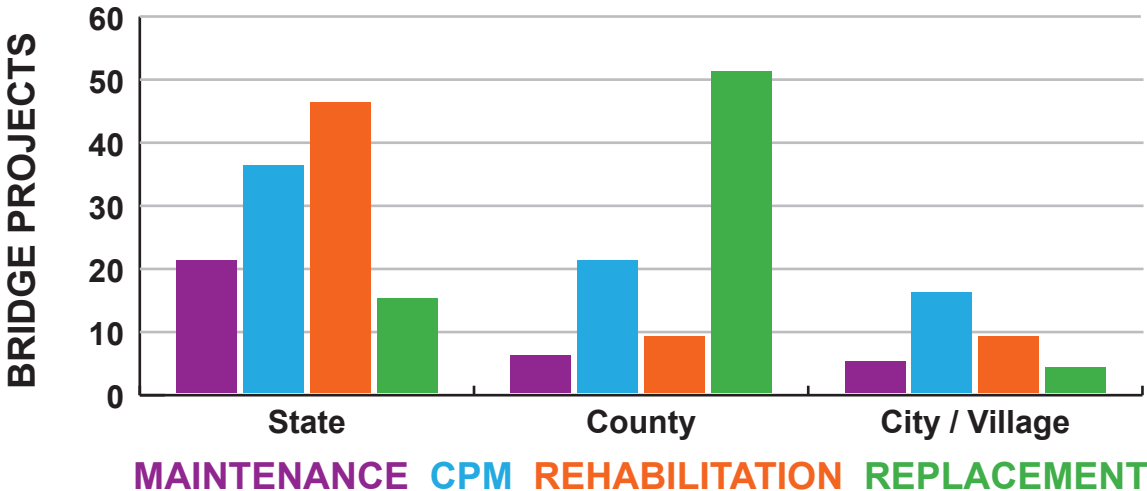

2017 Bridge Projects Details		
Type of Projects	Count	Cost
Maintenance	32	\$2,587,322
Capital Preventive Maintenance	73	\$27,818,329
Rehabilitation	64	\$43,082,214
Replacement	70	\$97,112,781
Total Number of Bridge Projects:	239	\$170,600,646



2017 Road Projects in Lane Miles

by Functional Class

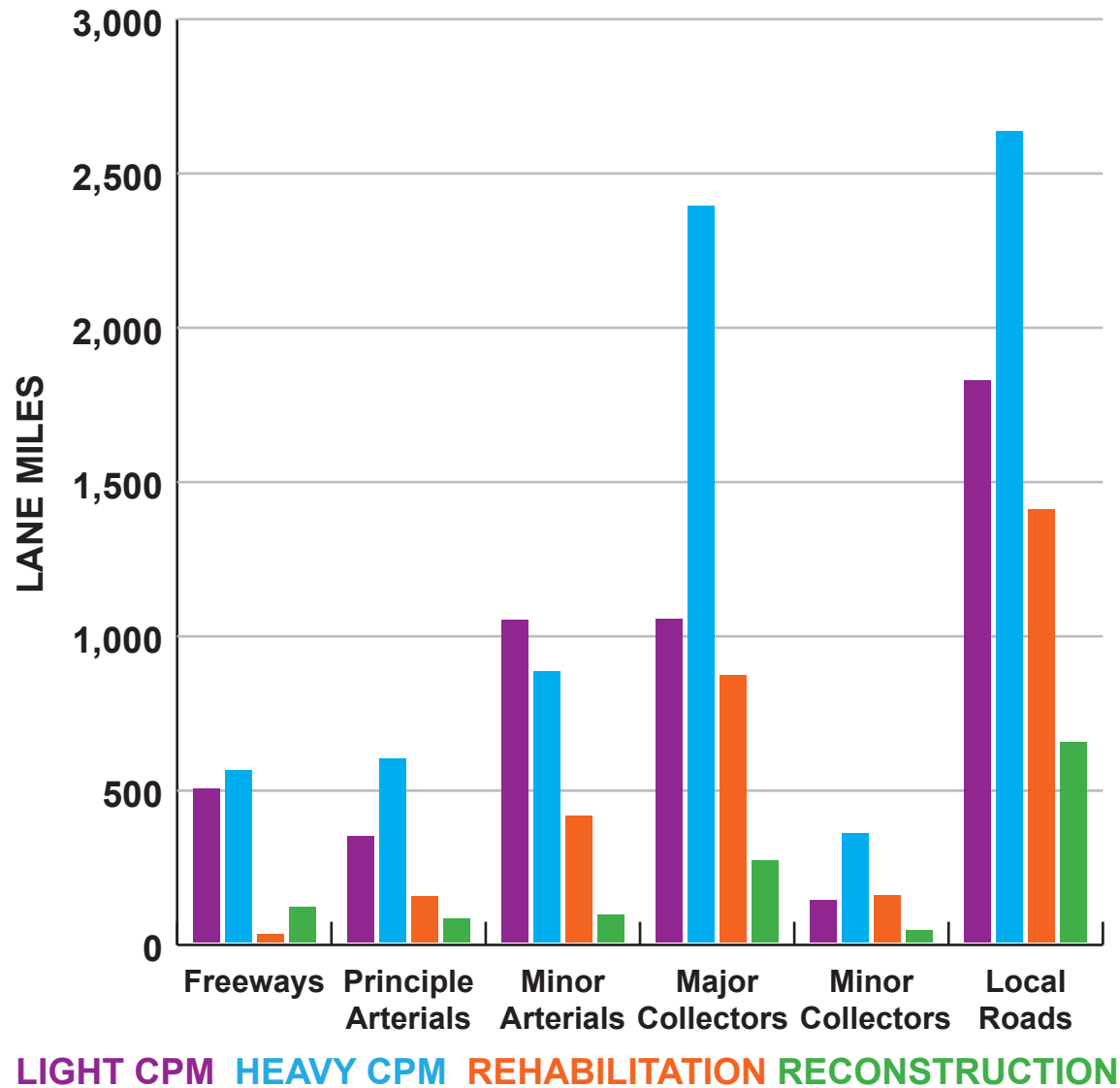
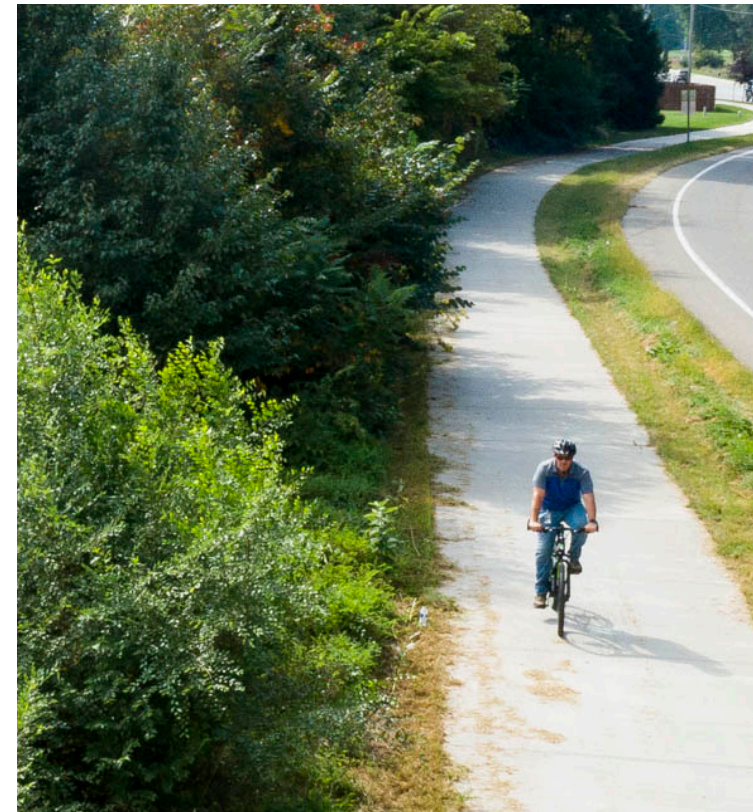

Figure 17

Source: TAMC March 2019

Ongoing Analysis: A Window into a Statewide Asset Management Strategy

These tables are examples of ongoing analysis of data reported in the IRT. The tables reflect the statewide strategy for investing in the public road system according to NFC or the role of the roadway. Figure 17 shows the breakout of IRT project types applied to the different



road classes by number of lane miles, while Figure 18 shows this by investment. Heavy CPM projects account for nearly half of the lane miles of work performed with most of this occurring in the major collectors and local roads. Reconstruction type projects account for a significant portion of the overall investment with the highest amounts being split between both the freeway system and local road network. A term commonly used in asset management is “mix of fixes.” The tables reflect the mix of fixes applied by over 600 agencies.



2017 Road Projects Investment

by Functional Class

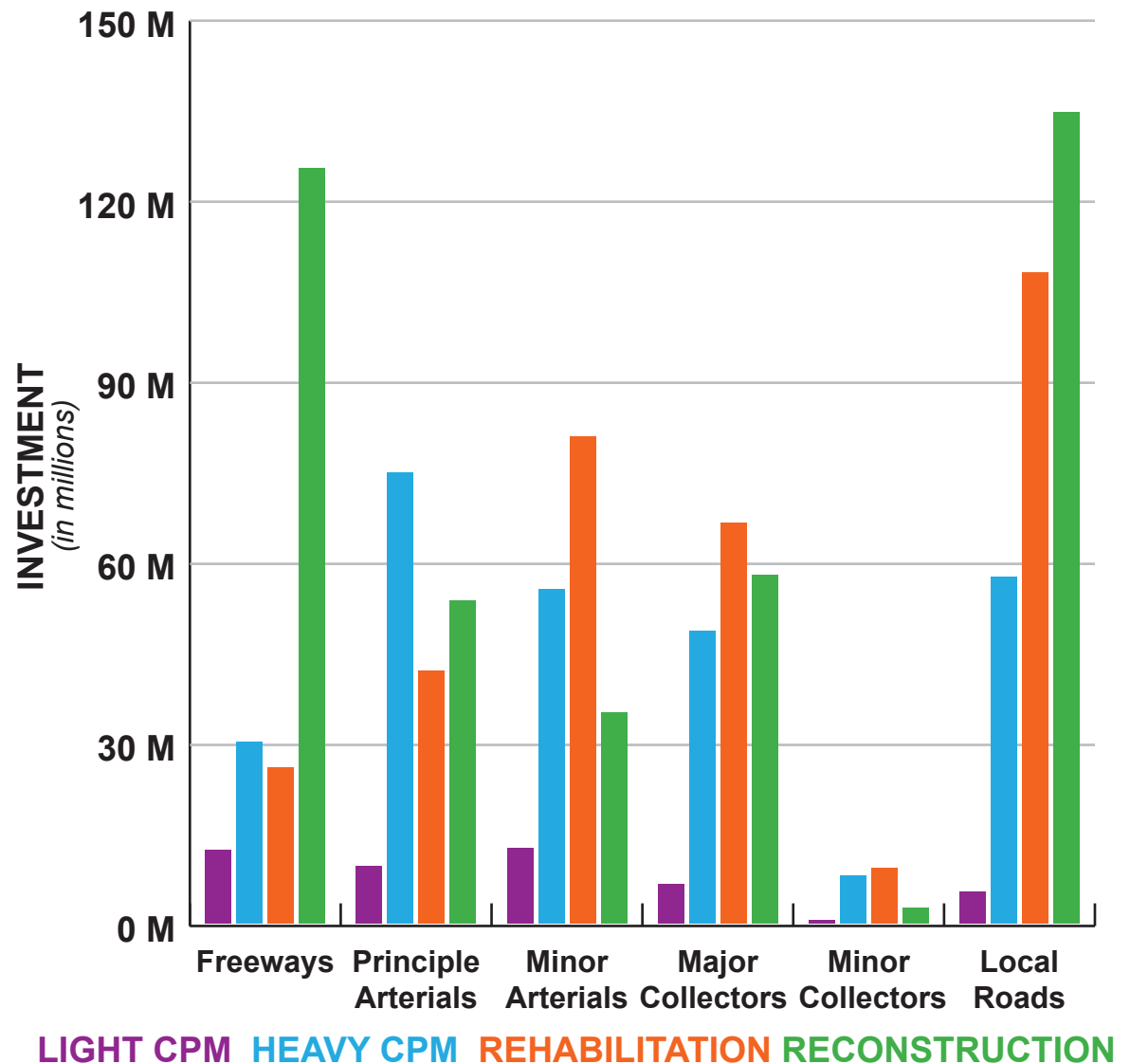

Figure 18
Source: TAMC March 2019

Asset Management Plans and Process Survey

Future PA 51 changes will require asset management plans for many agencies. The IRT asset management tool survey provides information on how agencies manage their road and bridge assets.

This survey also allows agencies to upload an asset management plan or documents that have assisted in their asset management process. Below are the number of agencies responding

positively to these questions. Responses for all questions significantly increased over the past year, reflecting agencies' use of asset management.

IRT Asset Management Process Survey Questions and Positive Responses (617 total agencies)	
1. Does your agency have a written Asset Management Plan?	159
2. Does your agency use an asset management process?	313
3. Does your agency have separate plans or condition goals for the Primary Road/Major Street versus the Local Road / Street networks?	254
4. Does your agency use pavement management software or tools to identify and prioritize future road projects?	231
5. Does your agency use a variety of preventive maintenance and rehabilitation treatments for roads?	420
6. Does your agency plan road projects 3 or more years in advance?	323

Note: Question 1 is the only question requiring a response

Saving the 5's

One of the benefits of gathering the IRT project data is the cross analysis between PASER condition data and IRT road investments. A PASER rating of 5 is generally considered the point in a pavement life cycle where lower cost improvements such as heavy CPM and rehabilitation prevent deterioration, which would lead to much more expensive reconstruction. This strategy is sometimes called saving the 5's. The table below reflects the type of projects applied to roads rated 5 in 2016 and 2017.

Breakdown of Road Projects Applied to PASER 5	
Light CPM	43%
Heavy CPM	35%
Rehabilitation	16%
Reconstruction	5%





LOOKING INTO 2019



Growing and Collaborating Together: MIC, WAMC and TAMC

In 2018, Michigan took an active leadership role in coordinating its public infrastructure, beyond roads and highways. Building on the success of the 21st Century Infrastructure Pilot and Regional Asset Management Pilot Project, the Michigan legislature committed to expanding the principles of asset management for drinking water systems, public wastewater systems,

and other important utilities. Using TAMC as a model, Public Act 324 of 2018 created the WAMC and Public Act 323 established the MIC.

Looking ahead into 2019 and beyond, MIC will work to educate a variety of new stakeholders and institutions on the topic of Michigan's critical infrastructure and asset management. Acting as a

champion for collaboration, coordination, education, and investment, MIC will call upon TAMC and WAMC to participate in the statewide discussion and creation of resources. 2019 will also be a year for the WAMC to create its work programs and resources. This offers an opportunity for MIC, WAMC, and TAMC to partner and collaborate at the council and committee levels.



Impacts of Public Act 51 Amendments

Starting in 2020, agencies with 100 or more miles of certified roads will need to submit asset management plans. It's important to know when each agency's first asset management plan is due. Agencies will be required to have asset management plans that contain multiple items including an asset inventory, performance goals and performance outcomes. These may be new requirements for many agencies and the TAMC will be available to provide guidance through training and a new template for plan development.



Culvert Inventory and Next Steps

The TAMC is working to capitalize on the success of the 2018 Culvert Pilot Project effort. The pilot summary report suggested some possible next steps, such as adding transparency or expanding the inventory beyond the pilot participants. Many agencies have substantial inventory data sets that the TAMC hopes to add to future dashboards and interactive maps; the report also suggests that refining the inventory process could encourage additional agencies to participate. By expanding participants in culvert data collection, participating agencies will have a more complete picture of a critical piece of Michigan's infrastructure.



Conference Partners

For its 2019 Spring Conference, TAMC continues its coordination with the Michigan Chapter of the American Public Works Association (APWA). The two groups will be hosting conferences together in Gaylord. TAMC is excited to continue to partner with APWA and share information on asset management efforts. The TAMC culvert pilot project will receive recognition during the APWA awards ceremony.

2019 SPRING ASSET MANAGEMENT CONFERENCE PROGRAM
 WEDNESDAY, MAY 22, 2019 - GAYLORD, MICHIGAN

The Transportation Asset Management Council and the Michigan Chapter of the American Public Works Association are holding a joint Spring 2019 Conference on the Pringle Resort, 2942 Williams Road & Gaylord, MI. Additional lodging for TAMC members will be a welcome reception and golf outing (Pringle is reserved for this event). On Tuesday, May 21, 2019, there will be a welcome reception for all attendees. On May 22, 2019, APWA will host APWA specific sessions only. Additional details for this event can be found on the 2019 APWA Great Lakes Expo website at <http://www.apwa.org/2019-2020>

7:30 - 8:00 AM: Registration & Breakfast
Networking Session 8:00 AM - 12:00 PM
Welcome and Opening Comments & Introductions - TAMC Event
 TAMC Update - TAMC Council
Reporting of 2018 Michigan Road Conditions and Forecast - TAMC Support Staff
Networking Break
Reporting of 2018 Michigan Bridge Conditions and Forecast - TAMC Bridge Committee
 James Cochran, Berrien County and David Januszewski, PE, The Berrien Group, Inc.
TAMC Award Presentations
12:00 PM - 1:00 PM: Lunch with APWA
Aftersession Session 1:00 PM - 4:00 PM
New Culvert Inventorying and Assessment Can Make Michigan Better - Christopher Gilbertson PhD, PE and Scott Borling, PE, Michigan Technology University's Center for Technology and Training
Michigan Infrastructure Council & Water Asset Management Council - Jenise May, Michigan Infrastructure Council
Networking Break
Panel Conversation: Strategies for Preserving Your Roads - Move Forward!
 Al Larson, Michigan Road Preservation Association and Pringle Industry Professionals
How Five? A Strategy for Extending the Service Life of Roadways - Brad Linking, PE, Berry County Road Commission
To Register:
 Contact the Michigan Level Technical Training and Training at www.tamc.org or call 1-800-457-7422
<http://www.apwa.org/2019-2020>
<http://www.michiganinfrastructure.org>
<http://www.waterassetmanagement.org>

Silver Sponsors: MRPA, MTPA, HNTB, HRC, MAR, GWP, Preins/Newhof

Bronze Sponsors: CMAA, Michigan Road Preservation Association, Michigan Infrastructure Council, Michigan Technology University's Center for Technology and Training

Adding Value by Improving Technology

Improving the user experience is a goal of TAMC. As more data sets are created or expanded, there are more opportunities to provide users with valuable information. The IRT, dashboards and interactive map are now fully mobile and features are added on a regular basis. An upcoming review feature will provide agencies with a simple tool to improve their IRT data and reduce their effort with a “clean slate” approach. This will help agencies better manage planned projects that may not have been completed as scheduled. The TAMC also added reports and new viewing capabilities to assist RPA/MPOs meet Public Act 51 requirements.

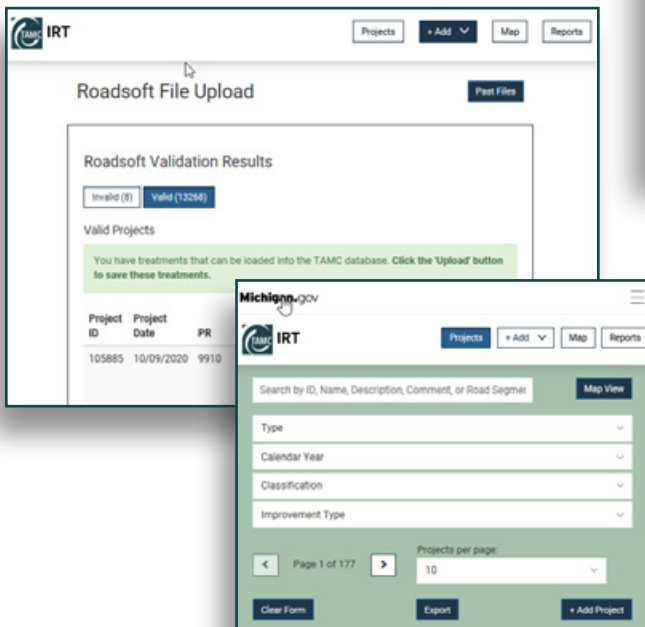

Expanding IRT Analysis

With two years of statewide road and bridge projects submitted, the IRT has become a key resource used to forecast modeling for both road and bridge conditions with more accurate costs and the types of projects that agencies are using. In 2019, there will be a greater focus on improving the level of detail for planned projects. Greater insight into these types of projects will greatly assist the overall coordination of asset management efforts across varying infrastructure assets.

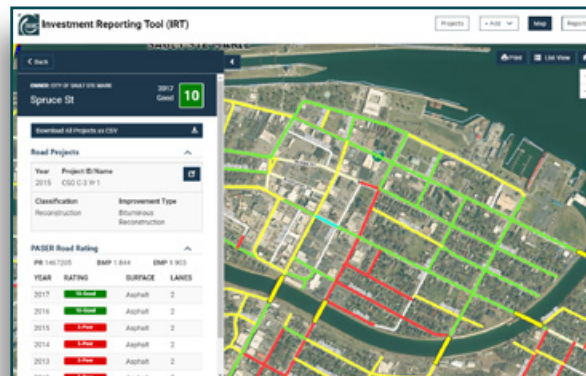

Traffic Signals

Another key asset under consideration for inclusion in TAMC data is traffic signals. The TAMC plans to use the success of the culvert pilot and past road and bridge rating efforts as a model for eventually collecting traffic signal data. Discussion on what to include in an inventory that will answer key statewide questions of overall investment and maintain value to individual agencies is underway.

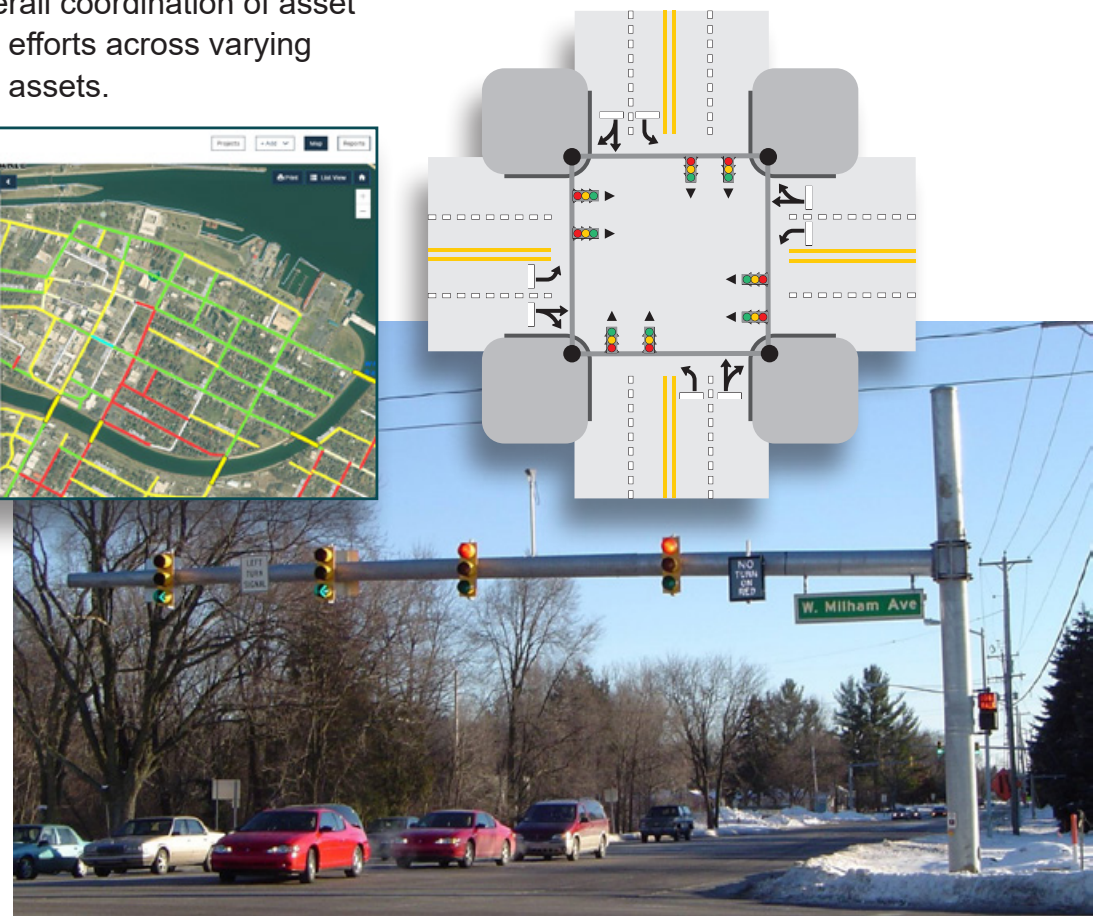

2018 Pavement PASER Condition Forecast

All Paved Federal-Aid Eligible Roads 2020-2030

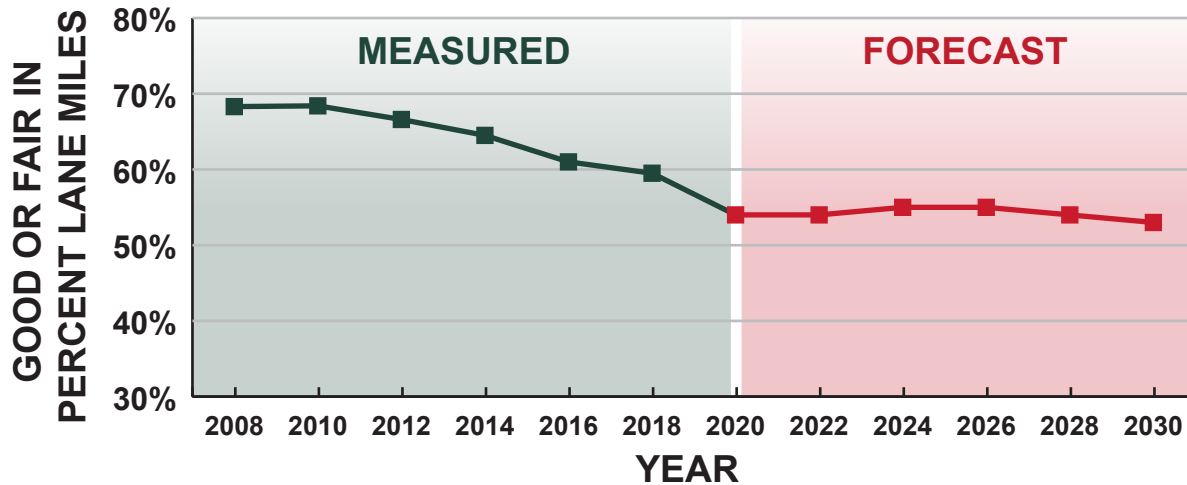

TAMC Takes a Look at Forecasting

The key inputs to TAMC’s pavement condition forecasting model are project costs, investment strategies, revenue, and pavement condition trends. Using those inputs, the model is able to forecast potential pavement condition outcomes. Each of these areas have their own degree of variability that in turn can impact the forecast from year to year. Along these lines, as of April 2019, the 2016 forecast has been updated.

2017 Pavement PASER Condition Forecast

All Paved Federal-Aid Eligible Roads 2019-2029

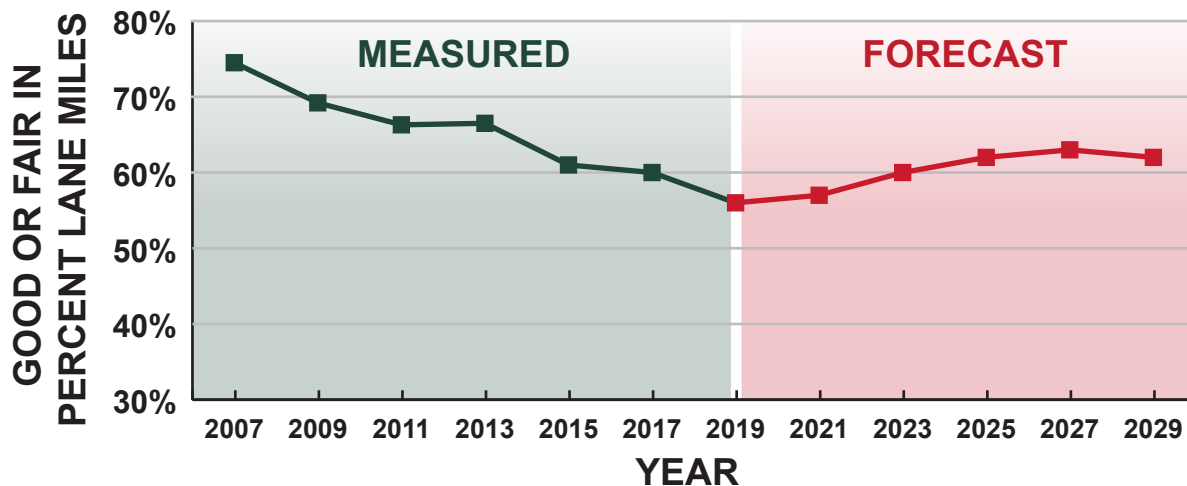

Some Key Points That Impacted the 2016 Forecast

Drivers to the 2016 forecast downward trend:

- The severe winter during 2013/2014 hastened the deterioration of road pavements.
- Over twice the average number of roads with the highest good rating fell to poor condition. These changes were compounded over time that reinforced the downward trend in the 2016 forecast.

The forecasts in this report now include past conditions. Even though pavement deterioration may have stabilized for the near future, this helps show how far the condition of the roads has declined over the past 10 years. TAMC will continue to work to improve its data and its forecasts in the years to come.



2016 Pavement PASER Condition Forecast

All Paved Federal-Aid Eligible Roads 2018-2028

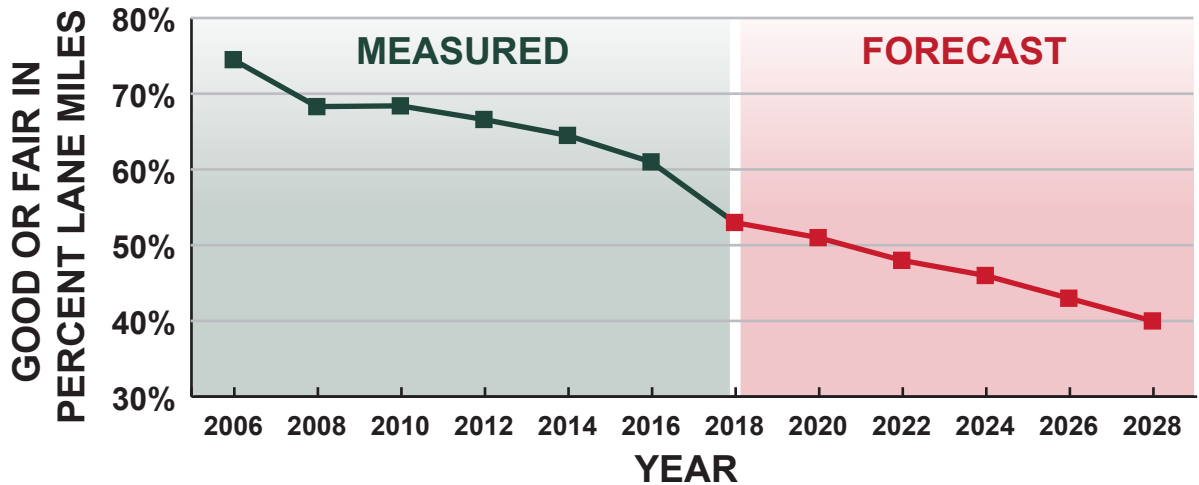

2015 Pavement PASER Condition Forecast

All Paved Federal-Aid Eligible Roads 2017-2023

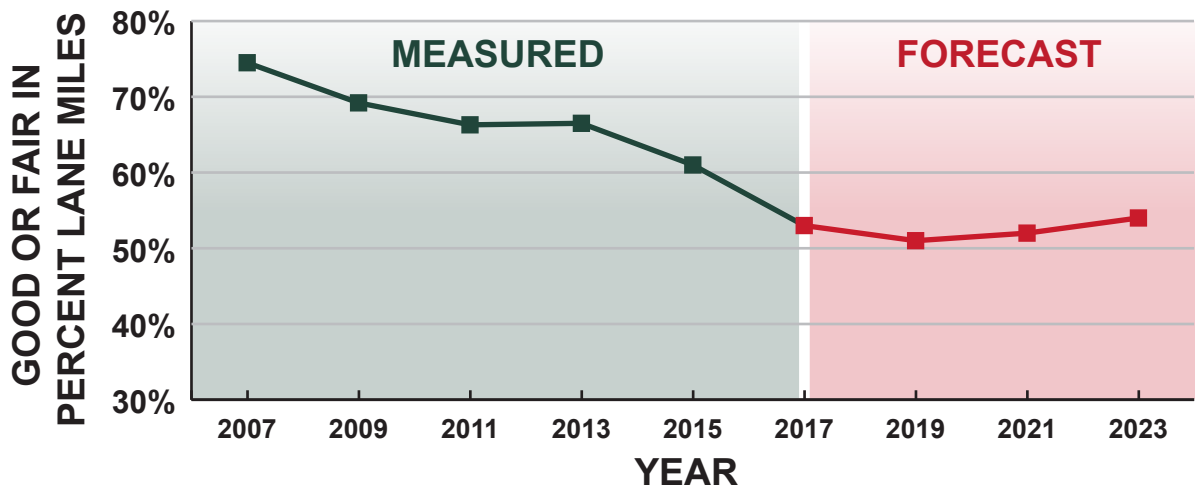

**“All public roads in Michigan will be managed
using the principles of asset management”**

- Public Act (PA) 499 of 2002 created the TAMC

www.Michigan.gov/TAMC