

State of Michigan  
Department of Environmental Quality

# ACTIVATED SLUDGE PROCESS CONTROL

TRAINING MANUAL FOR WASTEWATER  
TREATMENT PLANT OPERATORS



Water Resources Division

---

Rick Snyder, Governor  
Dan Wyant, Director  
[www.michigan.gov/deq](http://www.michigan.gov/deq)  
800-662-9278 Environmental Assistance Center

This Activated Sludge Training Manual was prepared by the Michigan Department of Environmental Quality, Operator Training staff. It is intended to be used as an aid in the presentation of the MDEQ Activated Sludge Process Control Training Course, along with numerous handouts, class discussion, and an abundance of slides.

The manual is not intended to be an exhaustive reference, nor a design manual. The student is encouraged to seek more detailed information from manufacturer's literature and the facility operation and maintenance manual. References to specific equipment or manufacturers do not indicate endorsement or preference by the State of Michigan. Although there are many suppliers of related equipment, those that are most often used to treat wastewater in Michigan are discussed in more detail than those that are not as common.

The manual is generally organized to follow the topics discussed in the training course, although some deviation is to be expected. The first section of the manual (and the first day of the course) reviews the basic principles of the activated sludge process. This is followed with information more specific to operating the activated sludge process, including nutrient removal, and troubleshooting.

It is hoped that participants in the Activated Sludge Process Control Course will find this manual helpful as they follow class discussions and as they review the information presented in class.

**A.S.  
BASICS**

# Activated Sludge Manual

## I. Background Stuff

### Wastewater Sources and Quantities

Wastewater may be described as water that is used to convey pollutants away from a source of pollution. It originates in homes, businesses, schools, hospitals, prisons, and industries, and is ultimately discharged back into the environment. Depending upon the collection system, wastewater may become diluted with groundwater or surface water as it passes from the source to the point of treatment. Infiltration into sewage collection systems may account for large increases in the amount of wastewater that requires treatment. Although typical quantities of domestic wastewater generation are somewhat predictable, industrial contributions are more varied. While many industries treat wastewater on-site, it is not unusual for a publicly owned wastewater treatment plant (POTW) in an industrialized city to treat wastewater comprised of up to 40 % industrial wastewater.

| Typical Water Use  |                                       |
|--------------------|---------------------------------------|
| <b>Residential</b> | <b>100 gal per day per person</b>     |
| <b>Offices</b>     | <b>40-50 gal per day per person</b>   |
| <b>Hotels</b>      | <b>400 - 500 gal per day per room</b> |
| <b>Hospitals</b>   | <b>200 gal per day per bed</b>        |
| <b>Schools</b>     | <b>200 - 300 gal per day per room</b> |

### Wastewater Characteristics

#### Solids

Components in wastewater may be generally classified in several different ways. One might refer to the pollutants in wastewater as being either **inorganic** or **organic**. Inorganic materials include sand, grit, minerals and metals, and are not biodegradable. Organic materials can be thought of as those which contain carbon, originate from living plants and animals, and are usable as a food source by living organisms. Obviously that is an over-simplification, since organic substances may be synthesized commercially, many compounds of which may not be biodegradable. Contributors of organic pollutants include animal wastes, food processing, household wastes, and oil and grease.

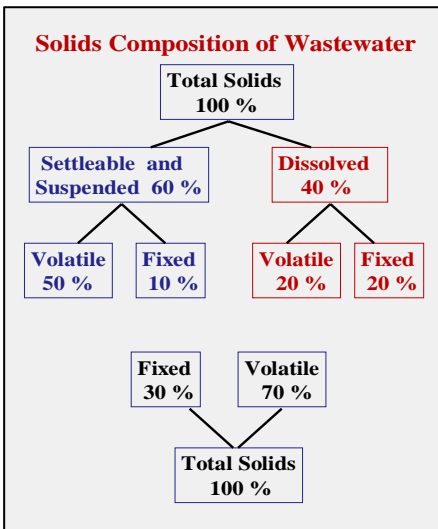

Solids are present in nearly every wastewater, may be very detrimental environmentally, and so are very often regulated in discharges of wastewater. Solids increase the amount of sedimentation in aquatic systems, choking off plants and animals and limiting the use of the receiving water. The term “solids” actually includes several possible components. The term “**suspended solids**” refers to particles which may be visible, add turbidity, and may be filtered out. “**Dissolved solids**” are those which pass through a filter and are not seen. Only when the water is evaporated from a sample is the amount of dissolved material apparent. So “**total solids**” refers to the amount of material that would be recovered if the water was evaporated from a sample, including particulates and dissolved materials.

The term “**settleable solids**” refers to those particulates which will settle within a defined period of time under quiescent conditions. Although no longer typically used for wastewater discharge monitoring, the settleability test is often used in controlling biological wastewater treatment plant operations, especially the activated sludge process. Another solids term that is often used is “**colloidal solids**”. This refers to particles which are so finely divided that they are microscopic in size and will not settle. These may pass through a filter paper and give the water a hazy appearance.

Solids may be organic or inorganic. For example, table salt in water would be an inorganic, dissolved solid. Pepper in water would be an organic, suspended solid. The fraction of organic solids is often estimated by burning the material. Organic materials will burn or “volatilize” at a temperature of 550°C, while inorganic materials will remain as a residue and are referred to as “fixed”. The table on the right indicates typical solids composition of domestic wastewater. Overall, the amount of solids donated to a domestic wastewater is estimated at about **0.20 - 0.25 lbs/d/capita**.

It is important to note that the fraction of organic solids which are dissolved in wastewater may change. As the table on the right indicates, when wastewater goes from fresh to stale, particulate size is reduced, the percentage of particulate organics drops and the percentage of dissolved (soluble) organic solids increases. Stale wastewater is more difficult to treat, requiring longer detention times and reducing the efficiency of a biological wastewater treatment process. Thus, it is important to limit detention time of the sewage in the collection system, equalization tanks, primary clarifiers, etc.

| Domestic Sewage Organics   |           |       |
|----------------------------|-----------|-------|
|                            | Fresh     | Stale |
| <b>Soluble</b>             | 15 - 25 % | 50 %  |
| <b>Colloidal Suspended</b> | 75 - 85 % | 50 %  |

**As Wastewater Becomes Stale,  
More of the Suspended Organics  
Become Dissolved**

**Biochemical Oxygen Demand**

Another characteristic of wastewater that is closely regulated is the “**Biochemical Oxygen Demand**” (BOD). As the term implies, many of the components of wastewater cause an oxygen demand to occur on a wastewater treatment system or on a receiving stream. This demand occurs as microorganisms, mainly bacteria, feed on the pollutants in the wastewater. As bacteria metabolize the pollutants they require oxygen, and dissolved oxygen is taken from the stream. As the pollutant load on the stream increases, the amount of oxygen required to consume the pollutants increases. Also as the term “**Biochemical Oxygen Demand**” implies, most of the demand occurs as a result of biological (organic) pollutants, but some inorganic pollutants, for the most part ammonia, can also contribute to the oxygen demand. As ammonia is biologically oxidized to nitrate (nitrification), oxygen is used up. So **Total BOD** is the sum of the **carbonaceous oxygen demand (CBOD)** and the **nitrogenous oxygen demand (NOD)**.

In the laboratory, the BOD of a wastewater is determined by diluting a portion of the wastewater sample with nutrient-rich, pH buffered dilution water in a 300 mL BOD bottle. The initial dissolved oxygen (D.O.) concentration of the diluted sample is determined and the bottle is incubated at 20°C for 5 days. The final D.O. in the bottle is determined and the BOD of the sample is calculated based on the oxygen depletion and the amount of sample dilution. If only the CBOD of the wastewater is to be determined, a **nitrification inhibitor** is added to the BOD bottle during dilution.



**Bio  
Chemical  
Oxygen  
Demand**

**Carbonaceous BOD**  
+ **Nitrogenous BOD**

---

**Total Biochemical  
Oxygen Demand**

**Total BOD<sub>5</sub> = CBOD + NOD**

**0.17 - 0.22 lbs/d/capita**

The environmental impact of BOD on a receiving stream may be illustrated with the chart below. On the left hand side of the chart, clean stream conditions are indicated by a relatively high D.O. concentration, maybe in the range of 5 – 7 mg/L and little sediment.

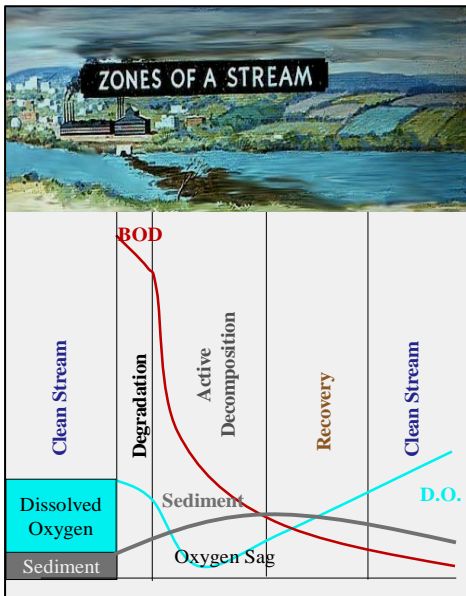

When a pollutant load is discharged into the stream (Zone of Degradation) the BOD concentration increases as the bacteria naturally present in the stream find a ready source of food. The bacteria become acclimated to the food supply and the population quickly increases in the Zone of Active Decomposition. In this zone oxygen consumption peaks, and the D.O. of the stream sags. Sediment increases as the pollutant is converted to bacterial mass which accumulates on the stream bottom.

As the pollutant is consumed the food supply for the bacteria becomes limited. Oxygen transfer from the atmosphere overtakes

oxygen consumption and the D.O. of the stream begins to increase in the Zone of Recovery. Eventually, as the BOD drops to minimal levels, the stream is returned to Clean Stream conditions (with some additional sediment).

Since the biology of a stream is related to the D.O. available, the types of organism expected in each of these zones will change. In a clean stream with high D.O. one could expect to find organisms which can not tolerate pollution. This would include a large variety of organisms, but relatively low overall population. In the zones of degradation and active decomposition organisms which thrive at low D.O. conditions have the advantage and their population

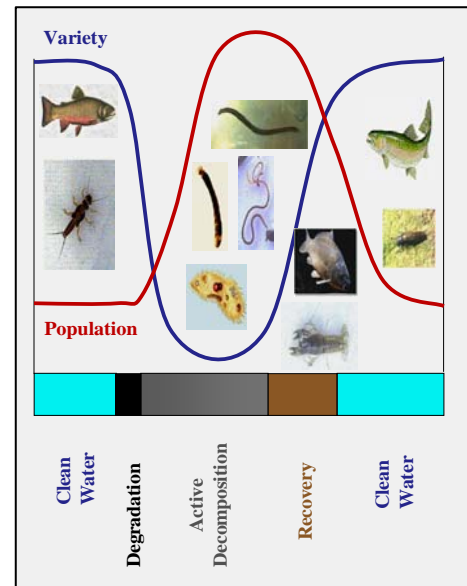

increases greatly, but biological diversity is reduced as the less tolerant organisms decline.

So a stream can purify itself as long as the pollutant load is not so large that the system becomes stuck in the process of active decomposition. In considering the environmental impact of a particular pollutant on a stream, though must be given to the numerous other possible pollutant loads. Non-point source pollution such as agricultural run-off and storm-water discharges, as well as other point-source discharges such as combined sewer overflows add significant pollutant loads to streams. If the total oxygen demand on the stream exceeds its capacity to recover, fish kills, objectionable odors, and very limited water use will result.

**Nutrients**

Nitrogen and phosphorus are nutrients that are required by every living organism, becoming a component of every cell. Domestic wastes, animal wastes, food processing wastes, and many industrial wastes will contain these nutrients. If these are discharged into a stream or lake they act as fertilizer, increasing the growth rate of aquatic plants. As this growth rate increases the lake may become choked with weeds and the amount of sediment increases. Over time, the lake begins to fill in with sediment.

**Eutrophication** is the term used to describe the aging process that lakes undergo as they gradually fill in with sediment, forming a bog or swamp. Careful control of the nutrient load discharged into the environment helps to slow that process. More detailed information on the impacts of nutrients and their treatment/removal will be included later.

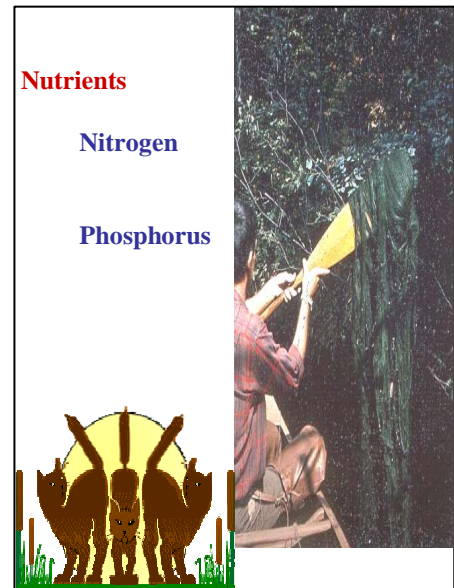

**Human Health Hazards and Toxins**

Wastewater may contain an untold variety of components that may be hazardous to humans. Domestic wastes always present the possibility of containing infectious microorganisms, or pathogens. Wastewater treatment plant workers exposed to these may contract any of several waterborne diseases. One of the most critical aspects of wastewater treatment is to prevent the discharge of these organisms into the environment where others may also be at risk.

|   |  |
|---|--|
| <p><b>Human Health Hazards</b><br/>                 Pathogens<br/>                 Nitrate<br/>                 Toxic Materials</p>   |  |
| <p><b>Materials Toxic to Biota</b><br/>                 Metals<br/>                 Ammonia<br/>                 Pesticides,<br/>                 Herbicides<br/>                 Chlorine<br/>                 Acids/Bases</p> |  |

Materials toxic to humans or aquatic organisms may enter the wastewater collection system from agricultural, industrial, or domestic sources. Metal solutions, pesticides, herbicides, acids and bases, and chlorine used to disinfect wastewater flows are included in the list of potentially toxic materials.

Though the field of wastewater treatment has progressed by leaps and bounds in the past one hundred years, it must still be realized that the

wastewater treatment plant operator has a very difficult task. Wastewater received by the treatment facility is a complex mixture of largely unknown substances which must not be released into the environment. It may include solids, oxygen demanding substances, nutrients, pathogens, and toxins. The operator should always try to bear in mind the importance of this position in the protection of natural resources and the protection of public health.

## II. Wastewater Treatment Processes

### Typical Wastewater Treatment Plant Schematic

Wastewater treatment processes may be grouped into two general categories, the first being **physical/chemical**. This category includes screening, sedimentation, filtration, precipitation, and chemical destruct systems. The second category, **biological**, includes processes which rely on living organisms to remove pollutants from the wastewater. This includes processes such as waste stabilization lagoons, trickling filters, rotating biological contactors, and activated sludge.

In most cases wastewater treatment is accomplished through the use of a combination of physical/chemical and biological treatment processes. For instance, a typical treatment plant might include preliminary treatment (physical) to remove large debris and grit, primary treatment (physical) to remove settleable suspended solids, secondary treatment (biological) to remove the remaining particulates and dissolved organic material, chemical precipitation to remove nutrients, tertiary filtration (physical) to remove remaining fine particulates, and chemical or ultraviolet light disinfection.

### Preliminary Treatment

Preliminary treatment is intended to protect downstream processes by removing large debris that might plug or jam equipment. This often involves bar screens to remove large particulates such as sticks, rocks, rags, etc. Coarse bar screens are usually inclined in the flow with the bars spaced about 1½ inches apart. The screen may be manually cleaned in smaller facilities or mechanically cleaned automatically in larger facilities. Fine bar screens have found increased use in the past several years. Often these screens are designed to remove particles as small as ¼ inch, obviously removing a larger amount of material from the wastewater flow, and providing increased protection for downstream processes.

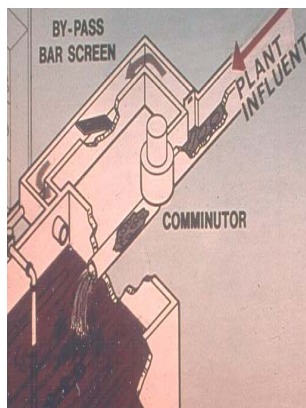

Grinding and shredding mechanisms such as comminutors have been used for many years to reduce the size of large debris, sending the shredded debris further into the treatment process. Although more modern equipment may be more efficient and less maintenance intensive than the older comminutors, they still deposit the debris back into the wastewater flow where it must be treated again later (possibly an advantage that the fine screen has over grinders).

Screening or grinding is usually followed by grit removal. Grit includes mainly the heavy inorganic materials such as sand, gravel, etc. that are abrasive to pumps, accumulating in



primary and secondary treatment processes, and adding unwanted inorganic content to sludge.

There are several options for grit removal, but two general methods are gravity grit separators and aerated grit separators. Gravity separators simply slow the flow velocity to a point at which the grit will settle out of the flow, but the organic material will remain suspended; this targeted velocity is generally taken as 1 foot per second. The simplest of the gravity separators is a channel in which the velocity is controlled, with the grit being removed manually. Another type of gravity separator is the detritor process, a settling tank (often rectangular) with a revolving plow which directs the grit to a sump where it is removed from the tank.

Aerated grit chambers operate along the same principle as the gravity separators, except that rather than adjusting the flow velocity through a channel, air is injected near the floor of the separator. The air causes enough turbulence in the tank to keep the organics in suspension while allowing the grit to settle. Often air lift pumps are used to remove the grit from the separator.

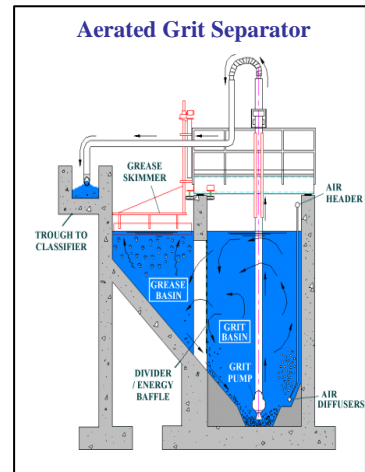

Flow monitoring is typically included in the preliminary part of the process. This may involve a closed pipe flow measurement system, but probably more often flow is directed through a Parshall flume where a flow level detecting device (such as an ultrasonic sensor) relates liquid level in the flume to the flow rate through the flume.

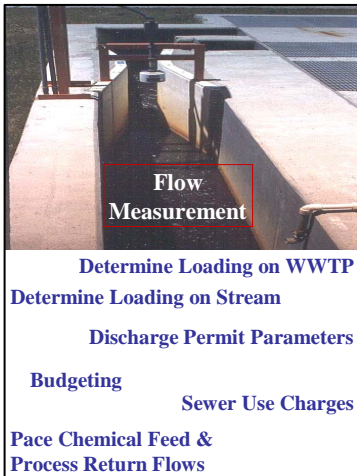

Flow measurement is important for many reasons, budgetary, operationally, and compliance-wise. Sewer use charges are usually based on flow, hydraulic and organic loading rates on plant processes require flow data, in-plant return flows and chemical feed rates are often paced relative to the influent flow measurement, and reporting plant flow information is almost always required in discharge monitoring reports. It is obvious that the flow measuring equipment must be periodically calibrated and serviced. It is recommended that this maintenance be performed by a qualified technician at least once per year.

While the preliminary part of the treatment process may not be the most glamorous area of the plant in which to work, it is important that this equipment be kept maintained in good working order. If the operator observes large debris or grit accumulating in down-stream processes, the preliminary treatment processes should be closely examined for areas that should be better maintained or operated. If this situation is allowed to exist, the overall treatment efficiency and operability of the plant will be reduced.

### Primary Treatment

Most, but not all, activated sludge facilities include a primary treatment step ahead of the secondary process. Primary clarification is a sedimentation process which is intended to

remove heavy settleable organic material. This removes a portion of the organic load before the secondary process, allowing the solids to be removed more economically as primary sludge rather than more dilute and harder to dewater secondary biomass.

Primary clarifiers may be designed as either rectangular or circular tanks with a minimum depth of about 10 feet. Tank dimensions vary according to the expected hydraulic load, but generally allow for a detention time of approximately 2 hours and a surface overflow rate of 400 – 600 gallons per day per square foot at average daily flow. Whether rectangular or circular, provision is made for collecting and removing the settled sludge, skimming and removing grease and other floating material, and discharging the clarified primary effluent to the secondary process.

The graphs below show the expected removal efficiency for solids and for BOD in a primary clarifier. Note that removal efficiency increases with time until a detention time of about 2 hours; after that little additional removal occurs. As discussed previously, removal rates for BOD may actually begin to decrease as degradation begins to occur in the clarifier. Solids begin to be broken down into smaller particles, and eventually are resolubilized, increasing the organic load on the secondary process and producing organic acids and other byproducts which are difficult to treat. It is therefore important that the primary treatment system be operated properly. Sludge must be removed from the clarifier before decomposition begins, and hydraulic detention time must be allowed to become excessive. Either situation will decrease performance of both the primary and the secondary treatment systems.

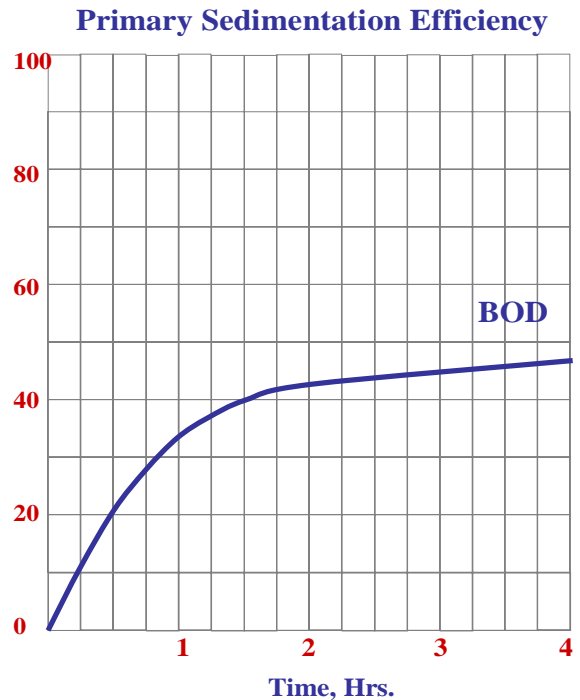
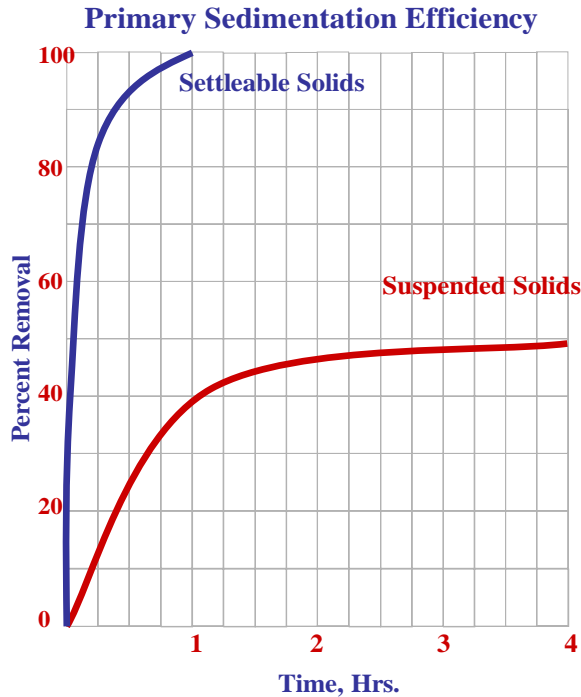

## Activated Sludge Basics

The Activated Sludge Process is a biological wastewater treatment process. This means that treatment occurs as pollutants are used as a food source by many different types of microorganisms. It is a suspended growth process, since the organisms are suspended in the wastewater rather than attached to a media as in the trickling filter or rotating biological contactor processes.

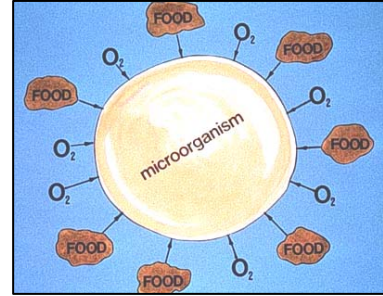

Since this is a biological process, understanding some basic biology will be needed. Some terms that will be used in this discussion and definitions follow:

|               |  |
|---------------|--|
| Anaerobic     | Organisms that need no D.O. or nitrate (NO <sub>3</sub> ) oxygen     |
| Aerobic       | Organisms that must have D.O.  |
| Facultative   | Organisms that can exist with or without D.O.                        |
|               |  |
| Heterotrophic | Organisms which consume organics in the wastewater                   |
| Autotrophic   | Organisms which are able to use inorganic compounds as a food source |

The activated sludge process relies on the cultivation of a population of millions of microorganisms of many different types, mostly aerobic and facultative heterotrophic bacteria suspended in the wastewater, as it passes through a reactor (aeration tank).

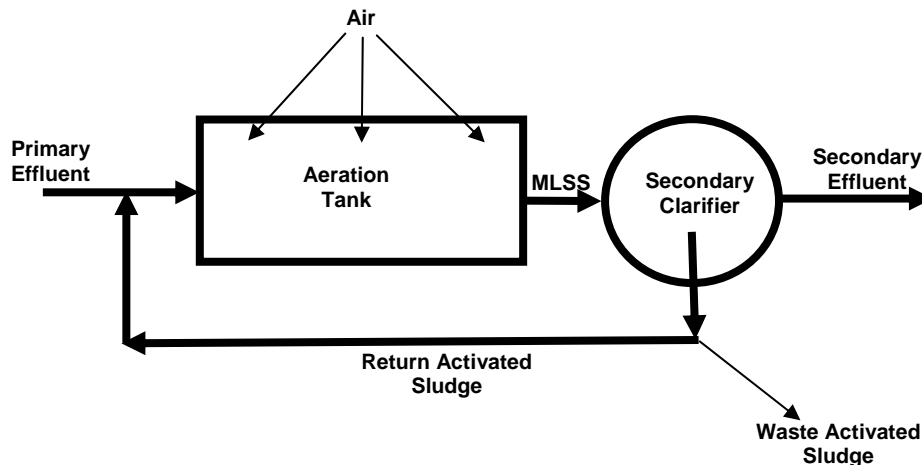

This suspension, referred to as **mixed liquor** (or **Mixed Liquor Suspended Solids, MLSS**), is supplied with oxygen and kept mixed by bubbling air through it. These are naturally occurring organisms; there is no need to supply them from an external source. As the organisms feed on the organic pollutants in the wastewater, the pollutants are converted to more organisms (biomass) and some byproducts. The amount of biomass produced is often estimated as about 0.7 pounds for each pound of BOD removed in the secondary process. While an individual bacterium is not visible to the eye, they stick to one another to form a biological mass which may be easily seen as a brown colored floc.

Following an adequate amount of treatment time the mixed liquor flows from the aeration tank to a secondary clarifier where the biomass is allowed to settle out of the wastewater

and the effluent passes to the next treatment step. The settled biomass is returned to the treatment process to provide organisms which will continue removing pollutants. This returned biomass is referred to as **Return Activated Sludge (RAS)**.

Since this is a living and growing process, it will continue to build biomass to the point of having too much. The amount of biomass in the process is controlled by removing (wasting) a portion of it each day. This excess biomass removed from the secondary system is known as **Waste Activated Sludge (WAS)**.

### Bacterial Cells

It is helpful to understand a little about the bacterial cell if we wish to know how it is able to remove pollutants. The diagram at the right shows a typical cell. The inside of the cell contains reproductive information, food storage mechanisms, etc. Surrounding the cell is a membrane which keeps the organism together, and through which dissolved food may pass. The cell wall is coated with a slime layer which is used to trap particles.

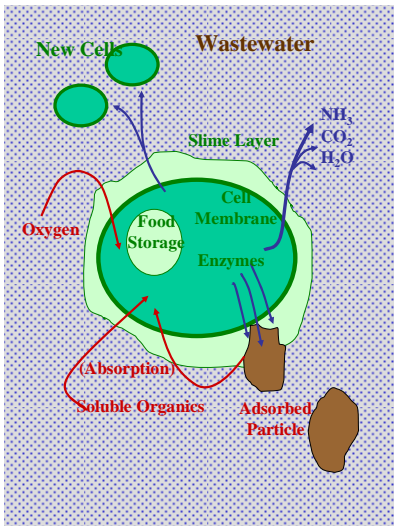
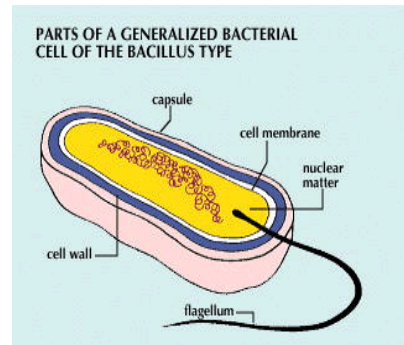

The diagram at the left shows a bacterial cell suspended in wastewater containing both soluble and particulate organic pollutants. Soluble organic pollutants pass through the cell membrane (**absorption**) and are used as a direct food source. Particulate organics cannot pass through the membrane, but stick to the slime layer (**adsorption**). The organism begins to produce enzymes which are secreted through the membrane and solubilize the particulate, allowing it to pass through the membrane where it too is used as food. In this way the organism is able to remove both soluble and particulate organics from the wastewater.

Also indicated in the diagram, oxygen must be supplied to the organisms as they metabolize the organics, and new bacterial cells are produced. Byproducts to this metabolism include ammonia ( $\text{NH}_3$ ), carbon dioxide ( $\text{CO}_2$ ), and water ( $\text{H}_2\text{O}$ ).

### Three Steps of Biological Treatment

Biological wastewater treatment is often described as occurring in three steps. In step one, **Transfer**, food from the wastewater is transferred to the cell. Adequate mixing and detention time are needed to assure that the organism comes into contact with the food source.

Step two, **Conversion**, occurs as the organism metabolizes the food supply, converting it to new cells. In order for this to occur the food supply must be a usable type and in a usable form. Some compounds are easily degraded by the bacteria, while others are metabolized more slowly. Some pollutants may not be metabolized until the organisms become acclimated to it, producing the right kinds of enzymes. A proper D.O. environment must be present; aerobic organisms will not efficiently remove pollutants in an anaerobic environment. The nutrient balance must be proper for conversion to take

place. Like other life forms, the organism needs nitrogen and phosphorus, among other minor nutrients, in order to metabolize food and build new cells. **The ratio of carbon to nitrogen to phosphorus** is generally taken as **100:5:1**.

In the third step of treatment, **Flocculation and Separation**, the microorganisms stick together to form large particles that will settle out of the purified wastewater in the secondary clarifier. Flocculation occurs when mixing allows the organisms to contact one another, but does not cause conditions so turbulent that the flocculated material is torn apart. Settleability and compaction of the floc particles depends on the density, size and shape of the particles as well as the efficiency of the clarifier. Settleability is affected by the abundance of **filamentous bacteria**, those that form strings as they grow rather than forming floc. An excessive growth rate of these bacteria may cause a **bulking** condition in which the mixed liquor does not compact well, taking up much more volume in the clarifier. This condition may be caused by many factors, among which are improper D.O. environment and nutrient imbalance, and may result in solids loss in the clarifier effluent. More about bulking and control of filamentous organisms later.

### III. Activated Sludge Control Factors and Calculations

#### Control Factors Overview

Proper operation of an activated sludge plant will require knowledge of biological and physical factors that influence the efficiency of the process. These factors include:

- organic and hydraulic loading on the aeration tank
- dissolved oxygen in the aeration tank
- biosolids wasting rate
- return activated sludge rate
- clarifier loading
- solids settling and compaction characteristics

#### Organic Loading

Organic loading refers to the number of pounds per day of BOD entering the process. In most activated sludge plants this is based on the primary effluent, but in plants without primary clarifiers it would be based on the plant influent flow. Pounds per day of BOD loading may be easily calculated using the **Pounds Formula**.

Multiplying the flow rate in million gallons per day by the weight of a gallon of water (8.34 Lbs/Gallon) and times the concentration in milligrams per liter of BOD in the flow yields the number of pounds per day of BOD in that flow.

It may be advantageous to calculate the organic loading as a five-day or seven-day **moving average**. This helps to average out day to day loading fluctuations, allowing more consistent control of the operation. A seven day moving average would be calculated by averaging the pounds of BOD for a particular day with values for the six days previous.

| Pounds Formula   |  |
|--|--|
| $\frac{\text{Lbs}}{\text{D}} = \frac{\text{MG}}{\text{D}} \times 8.34 \frac{\text{Lbs}}{\text{Gal}} \times \text{Conc.} \frac{\text{mg}}{\text{L}}$                        |  |
| $\frac{\text{Lbs}}{\text{D}} = \frac{\cancel{\text{MG}}}{\text{D}} \times 8.34 \frac{\text{Lbs}}{\cancel{\text{Gal}}} \times \frac{\text{Parts}}{\cancel{\text{M Parts}}}$ |  |
| Use to Determine the Pounds per Day of a Material in a Given Flow at a Given Concentration   |  |
| note:  |  |
| •Flow Must Be In Million Gallons/Day   |  |
| •8.34 Lbs is the Weight of a Gallon of Water   |  |
| •Conc Must be in Part per Million Terms  |  |

## Quantity of Microorganisms

Determination of Mixed Liquor Suspended Solids (MLSS) and Mixed Liquor Volatile Suspended Solids (MLVSS)



The concentration of mixed liquor (MLSS) is determined by suspended solids analysis of the suspension in the aeration tank. Since this suspension includes biological mass as well as inorganic material present in the wastewater, the amount of biological mass is estimated by determining the organic content of the MLSS. Mixed Liquor Volatile Suspended Solids (MLVSS) is determined by igniting a sample of the dried MLSS in a muffle furnace at 550°C. The material that burns at that temperature is considered to be organic, and therefore estimates the biological mass. The material that remains (non-volatile, or fixed) estimates the inorganic fraction of the MLSS. So in process control calculations where all of the solids must be considered, MLSS is used in the calculation. In calculations where just the active biological population should be considered, MLVSS is used.

The quantity of microorganisms available for treatment is also calculated using the pounds formula. Since the microorganisms are in the aeration tank, pounds of microorganisms are calculated by multiplying the volume of the aeration tank(s) in millions of gallons times the weight of a gallon of water (8.34 lb/gal) times the MLVSS concentration in milligrams per liter.

### Food to Microorganism Ratio

Food to Microorganism Ratio (F:M) is one of the primary controls used in activated sludge plants. This helps the operator to maintain a balance between the quantity of food available, with the quantity of microorganisms in the aeration tanks. Since the food available to the microorganisms is represented by the BOD of the wastewater, the F:M ratio is calculated by dividing the number of pounds of BOD entering the secondary treatment system by the number of pounds of MLVSS in the aeration tanks.

While best treatment may not occur at the same F:M ratio in different plants, the range for **Conventional** activated sludge plants is often given as 0.25 to 0.45. Activated sludge plants that operate in the **Extended Aeration** mode typically operate with F:M in the 0.05 to 0.15 range.

Since the operator usually has no control over the number of pounds of BOD entering the wastewater treatment plant, F:M is adjusted by adjusting the number of pounds of MLVSS in the secondary system. If more

### F:M Calculations

**Problem A:**

How many pounds of MLVSS should be maintained in an aeration tank with a volume of 0.105 MG receiving primary effluent BOD of 630 lbs/d ? The desired F:M is 0.3.

$$\frac{F}{M} = M = \frac{630 \text{ lbs/d}}{0.3} = 2100 \text{ lbs MLVSS}$$

**Problem B:**

What will be the MLVSS concentration in mg/L ?

$$2100 \text{ lbs} = \text{Conc} \times 0.105 \text{ MG} \times 8.34 \text{ lbs/gal}$$

$$\frac{2100 \text{ lbs}}{0.105 \text{ MG} \times 8.34 \text{ lbs/gal}} = 2398 \text{ mg/L}$$

biomass is needed (raising MLVSS) the amount of biomass wasted must be reduced, and if less biomass is needed (lowering MLVSS) the wasting rate must be increased until the necessary pounds of biomass is achieved. A couple of things that must be remembered regarding making operational changes: 1) biological systems react slowly to these types of control changes; give the system time to adapt to a change before making another adjustment, and 2) consistency is often the key to successful operation; use a moving average to calculate pounds of BOD, and make few adjustments; only when necessary.

F:M is most useful as an operational tool when the operator sets a target F:M, and based on the average BOD loading calculates the pounds of MLVSS needed to achieve that F:M. Divide the pounds of BOD by the target F:M to calculate the pounds of MLVSS needed. The concentration of MLVSS in the aeration tank can then be calculated by dividing the pounds of MLVSS by the aeration tank volume in million gallons and by 8.34 lbs/gallon.



### Cell Residence Time

**Cell Residence Time (CRT)**, also known as **Sludge Age (SA)** or **Solids Retention Time (SRT)**, may be defined as the average length of time in days that an organism remains in the secondary treatment system.

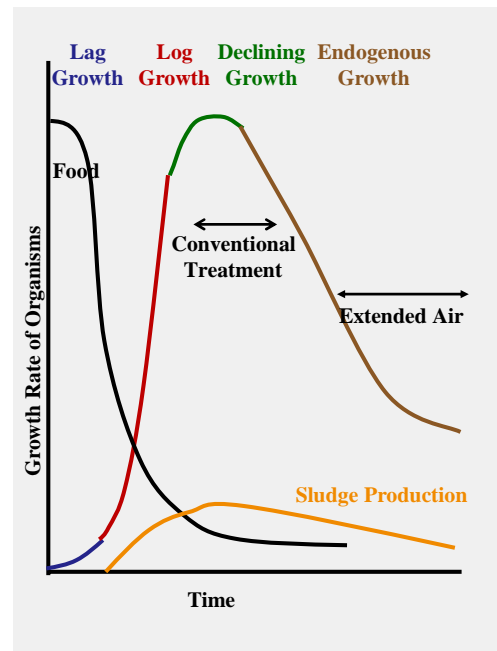
The graph on the right illustrates the growth phases in a biological system and how the growth rate of microorganisms changes with increased CRT. When a food supply is introduced into a biological treatment plant that is in start-up, there is an abundance of food but very few organisms. The organisms are said to be in **Lag Phase** as they begin to acclimate to the waste, producing the needed enzymes, and the population begins to increase. Once the organisms have acclimated, the growth rate increases rapidly in the **Log Growth Phase**. At this point the food supply is not a limiting factor as BOD is converted to biological mass, producing large amounts of sludge. In the **Declining Growth Phase** the population has grown to the point that the available food supply begins to limit the production of new cells and organisms begin to compete for food. As the population ages (CRT 5 days or greater), larger and more complex organisms which are able to compete for the remaining food are more numerous, and predatory organisms begin to feed on smaller ones as a food chain develops. In the **Endogenous Phase** the food supply has been depleted and as the age of the population increases (CRT is now up to >15 days), the organism growth rate continues to decline. Food which the organisms have stored is metabolized and the organisms feed on one another in **Endogenous Respiration**. Although the concentration of organisms is large, sludge production is lower.



Considering the objectives and the expense of wastewater treatment, there are obvious advantages in operating an activated sludge system in the extended aeration mode. BOD will be almost completely gone, producing a high quality effluent, and sludge production will be at its lowest. Nitrification (the oxidation of ammonia) is almost certain. Because of the large organism population and large aeration tanks used the system is more resistant to upset, with day to day operation being typically very consistent. These plants are usually designed without primary clarifiers, since organic loading on the secondary system is fairly light. Biosolids wasted from the secondary system is often digested and concentrated by means of aerobic digestion, followed by disposal on agricultural land. The popularity of the extended aeration mode is evidenced by the large number of oxidation ditch and sequencing batch reactor facilities (both are typically operated in the extended air mode) built in Michigan in recent years.

|   |              |
|---|--------------|
| <b>Conventional Activated Sludge</b>  |              |
| Aerator Detention Time  | 4 - 8 Hrs.   |
| F:M   | 0.25 - 0.45  |
| CRT   | 4 - 6 Days   |
|  |              |
| <b>Extended Aeration Activated Sludge</b>   |              |
| Aerator Detention Time  | 16 - 24 Hrs. |
| F:M   | 0.05 - 0.15  |
| CRT   | 15 - 25 Days |
|  |              |

But it is not practical to build an extended aeration process for many municipalities and industries. Extended air plants must be capable of long detention times in the aeration basin, usually in the range of about 24 hours. They must also be capable of maintaining large microorganism populations; MLSS is often in the 5000 mg/L range. In situations where the wastewater flow rate or the BOD loading is large, constructing an extended air plant would be too expensive, requiring very large aeration tanks and secondary clarifiers.

Most of the larger activated sludge plants in Michigan (> 5 MGD) operate in the conventional mode. Primary clarifiers remove a large portion of the organic loading before the wastewater is treated in the secondary system. Primary sludge and biomass wasted from the secondary system may be thickened followed by anaerobic digestion, lime stabilization, or incineration. Effluent quality is typically high; nitrification may or may not occur, depending largely on organic and hydraulic loading.

Cell Residence Time

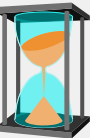

Cell Residence Time, CRT  
Sludge Age, SA  
Mean Cell Residence Time, MCRT

The Average Length of Time in Days  
that an Organism Remains in  
the Secondary Treatment System

**CRT, days =  $\frac{\text{Total MLVSS, lbs}}{\text{Total MLVSS Wasted, lbs/d}}$**

**Example Problem:**

MLVSS = 6681 lbs      **CRT =  $\frac{6681 \text{ lbs}}{835 \text{ lbs/d}}$**

MLVSS Wasted = 835 lbs/d

Calculate the CRT.      **CRT = 8.0 Days**

Cell residence time is calculated by dividing the total pounds of MLVSS in the aeration system by the number of pounds of biomass wasted per day. Note the use of the volatile portion of the biomass in the CRT formula (MLVSS). Actually the formula will work with either total or volatile solids as long as it is consistent on both the top and bottom. But since we are again interested in the biological portion of the solids, we will avoid confusion by using volatile solids.

In plants with a number of secondary clarifiers, a significant quantity of the total amount of biomass may be held in the clarifiers. In this situation the operator may include these solids in the calculation; the total quantity of biomass in the aeration tank and secondary clarifiers



divided by the quantity of biomass wasted per day is the Mean Cell Residence Time (MCRT). Sometimes in calculating the MCRT the quantity of solids lost in the effluent is added to the quantity of biomass wasted per day. But for most facilities, calculation of the CRT is appropriate. Like F:M, the most efficient CRT at which a plant will operate is best determined by experience.

One tool which many activated sludge operators utilize is the microscope. A more detailed discussion of the use of the microscope will be given later, but it will be helpful at this point to discuss the use of **indicator organisms** in controlling the process. As the CRT increases, the types of organisms in the mixed liquor become larger and more complex. While the operator is not able to see most bacteria even with the use of a microscope, the larger, more complex organisms are more easily identified. Since the size and complexity of the organisms increase as the CRT increases, the types of organisms **predominating** in the Mixed Liquor give an indication as to the age of the sludge.

At low CRT (< about 4 days) the simpler life forms are present. This includes **amoebas** and **flagellates**. As the sludge age increases (> about 4 days), more complex organisms such as the **free swimming ciliates** and **stalked ciliates** appear. And at high CRT, multi-celled animals such as the **rotifers** and **nematodes** may be found. Again, a more detailed discussion will come later, but at this point it should be recognized that as the CRT increases, complexity and size of organisms increase, allowing the operator who is skilled in the basic use of the microscope to determine the quality of the biomass in the treatment plant.

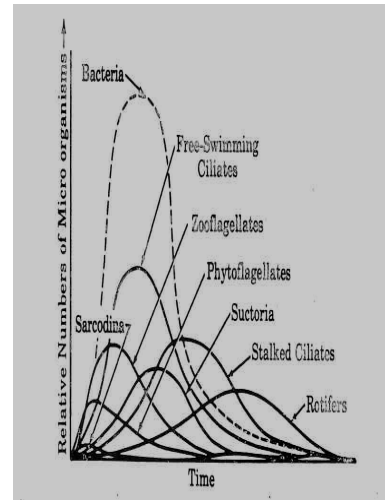

Operational problems may often be linked to inappropriate CRT. Young sludge (low CRT) may be related to an inadequate microorganism population or an excessive BOD load (high F:M) which causes a log growth situation. The cells become dispersed rather than flocculated, settleability is poor, and the effluent becomes turbid. In this condition oxygen is used up quickly due to the high metabolism rate, and sludge production is high. One tell-tale sign of this condition is the production of huge amounts of a billowing white foam.

At the other extreme, an old sludge (high CRT) may be related to operating with an excessive microorganism population. All of the influent BOD has been used up and the organisms are now in endogenous respiration (low F:M). Oxygen use is lower as metabolism and sludge production declines. Mixed liquor settles rapidly due to the dense, compact floc that forms. Effluent may be generally clear, with some **straggler floc** left behind. Plants operating with an old sludge often experience **slurp**, a dense, greasy, brown foam which accumulates on the aeration tanks and sometimes on the secondary clarifiers. Although it is not uncommon to see some slurp on plants operated in the

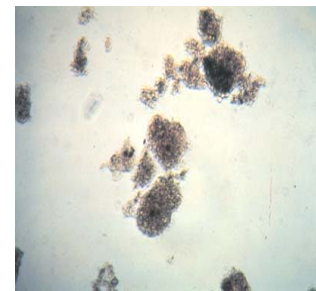

extended air mode, an excessive amount of slurr is not only unsightly, but may cause walkways to become dangerously slippery. In cold temperatures slurr in aeration tanks and clarifiers may freeze, causing operational difficulties and possibly mechanical failure.

Slurr is caused by the growth of a highly branched filamentous organism (usually **Nocardia**). As the filaments float to the surface they entrap other particles and air bubbles to form a scum which is very resistant to just about any effort to eliminate it. The best solution is usually to reduce CRT, being careful not to remove too much biomass, and with time the amount of slurr may diminish. As a short term solution, it may be necessary to physically remove the slurr by means of a vacuum truck or pump.



### Wasting Rates

CRT was defined earlier in this discussion as the average length of time in days that an organism remains in the secondary treatment system. The operator determines the operating CRT for the facility and maintains it through wasting the appropriate amount of excess biomass (**Waste Activated Sludge, WAS**) from the secondary system. In other words, the amount of biomass (MLSS) in the secondary system is controlled and maintained through solids wasting.

In nearly all activated sludge plants, wasting is accomplished by directing a portion of the Return Sludge to the solids handling facility. Wasting Return Sludge rather than Mixed Liquor minimizes the volume of water that must be processed by the sludge thickening/dewatering equipment.

While it may be best to waste these solids continuously to achieve maximum system stability, this is often not possible due to plumbing and time constraints. If intermittent wasting is practiced, it is usually best to waste over as long a time period as practical, and when the loading on the secondary system is at the low point of the day. Drastic changes should not be made in wasting rates from one day to the next; allow the biological system time to acclimate to a change before another change is made. Consistency is a key element in successful activated sludge plant operation.

Many activated sludge plants were originally designed to waste secondary solids into the primary clarifiers. The reasoning was that as the less dense biological solids co-settle with the heavier primary solids the combined sludge density would be increased. The problem which often results from this arrangement is that much of the biological solids do not settle in the primary clarifier and end up back in the aeration tank, increasing CRT and often causing operational problems. A more efficient operation will result if the WAS is wasted directly to a solids handling process and not allowed to return to the treatment system. It is crucial that adequate solids concentrating equipment and solids storage capability are part of any plans for building or expanding an activated sludge plant.

Secondary sludge wasting is one of the most important controls available to the operator because it controls the most important aspect of treatment, biomass population. Unfortunately, control of wasting is limited in some facilities by poor design. Inability to return sludge and waste at the same time, WAS piping being too large or too small, and inadequate or non-existent WAS flow metering capability add to the level of difficulty in operating some plants. Again, it is very important that system design include adequate

WAS control and metering equipment. A good WAS control situation is one that allows the operator to set a totalizer which determines the maximum number of gallons wasted in a particular day and also allows the operator to control and monitor the WAS flow rate.

In determining an appropriate WAS rate, we need to return to the CRT relationship:

$$\text{CRT(days)} = \frac{\text{Lbs of MLVSS in aerators}}{\text{Lbs/day WAS VSS}}$$

Determining a wasting rate first involves deciding upon a target CRT. For instance, the CRT for a conventional activated sludge plant may be set at 8 days, or for an extended air plant the CRT may be set at 20 days. Assuming that the plant has an established biomass concentration based on F:M, the target CRT will be used to establish a wasting rate that will provide a stable biomass population.

Since we already know the target CRT, the relationship may be rearranged to solve for the number of pounds of WAS:

$$\frac{\text{Lbs WAS VSS}}{\text{day}} = \frac{\text{Lbs of MLVSS in aerators}}{\text{CRT (days)}}$$

While the above calculation gives the number of pounds of biomass that must be wasted each day, the operator is usually interested in calculating the number of gallons of that material that must be wasted per day. If the concentration of the WAS is known (same as RAS VSS), this can be done by rearranging the pounds formula to solve for MGD:

$$\text{WAS (MGD)} = \frac{\text{lbs/day WAS VSS}}{\text{RAS VSS (mg/L)} \times 8.34 \frac{\text{lbs}}{\text{gal}}}$$

Keep in mind that the end result of this calculation is the flow in MGD, and since waste flow rates are not large, the calculated MGD is typically a small number. Convert this to gallons per day from MGD:

$$\text{MGD} \times 1,000,000 = \text{gallons per day}$$

If wasting is to be done over a 24 hr. period:

$$\text{WAS (gpm)} = \frac{\text{gallons/day}}{1440 \text{ minutes/day}}$$

If wasting is to be done over a shorter period of time:

$$\text{WAS (gpm)} = \frac{\text{gallons/day}}{\text{min wasting to be done/day}}$$

### Return Activated Sludge

Return Activated Sludge (RAS) refers to the biological solids (mixed liquor solids) that settle in the secondary clarifier and are continuously returned back to the aeration tank. There are two important reasons for returning these organisms. First, if they were not

continuously drawn from the clarifier it would quickly fill up with solids and they would be lost in the effluent. Second, these organisms are the major component of the treatment system. If they were not returned the biomass population could not be sustained and the treatment system would quickly fail. RAS brings active, hungry microorganisms back into the aeration tank where they can again feed on incoming wastes.

There are a couple of fairly common misconceptions regarding RAS. Some mistakenly think that RAS returns food back into the aeration tank for the microorganisms in the tank. Keep in mind that the food (BOD) should be completely gone at this point. The object is to return microorganisms to sustain the biological population in the aeration tank. Another misunderstanding is that RAS controls the MLSS concentration in the system. RAS can only change the MLSS concentration on a short term basis, and only when the solids in the system are not in balance. The operational parameter which controls the biomass concentration in the system is WAS; if more biomass is needed WAS is reduced, and if less biomass is needed WAS is increased.

Return sludge is drawn continually from the secondary clarifiers. Operators typically try to control the RAS so that the sludge blanket in the clarifier is maintained between 1 and 3 feet deep. It is important not to allow the blanket to get too deep, so that a safe distance is maintained between the top of the sludge blanket and the surface of the water in the clarifier, assuring that solids will not be lost as the flow rate through the clarifier fluctuates. It is usually desirable to maintain some solids in the clarifier; this helps to provide a thicker return sludge and will minimize the number of gallons of material that must be wasted.

The RAS rate in most plants is electronically controlled through metering and automatic valves. In many plants the rate may be set to track with the influent flow rate; as the influent flow rate increases the RAS rate increases. So a 40 % RAS rate means that if the plant influent flow rate is 1 MGD, the RAS rate would be 0.4 MGD. Typical RAS rates range from about 30 % to about 125 %. RAS controllers often provide both percent of influent flow and MGD indicators. Tracking the RAS flow rate with the influent flow rate helps to avoid solids build-up in the secondary clarifiers during high flow periods and avoids pumping all of the solids from the clarifier during low flow periods.

While electronic flow meters are needed to determine RAS rates, a simpler approach may be best for determining the depth of sludge in the secondary clarifier and making RAS adjustments. Many operators use a device known as a “**sludge judge**” for this purpose. This is a clear plastic tube marked in 1 foot increments, about 1 inch in diameter, in lengths that thread together to allow the operator to reach from the clarifier bridge to the bottom of the clarifier. The bottom section of the tube has a check valve which allows the tube to fill as it is lowered into the clarifier, but seats when the operator draws the tube up. The operator then is able to actually see the depth of sludge in the tank, and the RAS rate increased or decreased according to the desired blanket depth. An alternate approach to sludge blanket measurement is to use one of the many electronic devices on the market for determining the sludge/water interface. Regardless of the method of measurement, this determination should be made at least once per shift on each clarifier, with increased frequency if changes in the RAS rate are being made or if reduced settleability has become a problem.



The RAS rate may be calculated using a mass balance approach around the secondary clarifier.

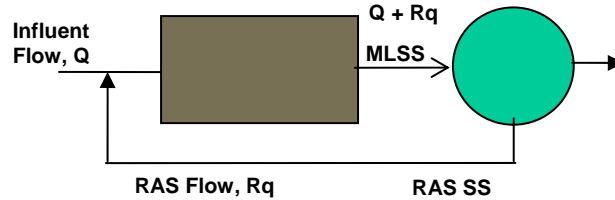

Basically, this approach is centered on the thought that in a secondary clarifier the pounds of solids drawn from the clarifier (RAS) must be equal to the pounds of material entering the clarifier (MLSS).

Without detailing all of the algebra involved, using the pounds formula to express pounds of material going into the clarifier, setting that equal to the pounds of material drawn from the clarifier, and solving for the RAS flow rate ( $Rq$ ) yields the formula:

$$Rq = \frac{Q \times MLSS}{RAS\ SS - MLSS}$$

In this formula  $Rq$  is the calculated Return Sludge flow rate,  $Q$  is the influent flow rate,  $RAS\ SS$  is the RAS suspended solids concentration in milligrams per liter, and  $MLSS$  is the Mixed Liquor suspended solids concentration in milligrams per liter.

Note that the flow units for  $Rq$  will match the units used for influent flow  $Q$ ; if  $Q$  is given in MGD,  $Rq$  will be in MGD. If the operator needs to calculate  $Rq$  in terms of percent of influent flow, just use 100 % for  $Q$ .

$$Rq, \% = \frac{100\ \% \times MLSS}{RAS - MLSS}$$

Also note that total suspended solids rather than volatile solids are used in the RAS formula for both RAS and MLSS. This makes sense, since we are concerned with the total amount of sludge in the clarifier rather than just with the biological mass. Keep in mind while using the RAS formula that while this calculation may provide a good starting point or a check for the RAS rate, the most practical means of controlling the RAS rate is by actual sludge blanket measurement.

RAS metering and control is another area in which the operator needs to be vigilant when a new facility is being designed, or an existing plant expanded. The additional capital costs associated with meters and valves is usually money well spent when the operational difficulties existing at some facilities is considered.

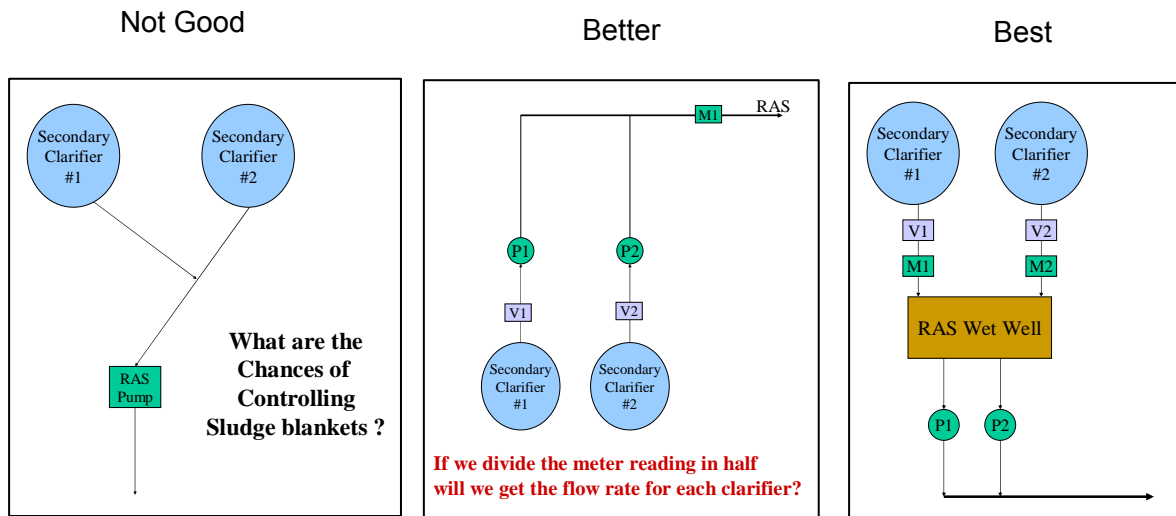

Consider RAS control in the schematics above. In the first example the RAS lines from the two clarifiers are tied into a common pipe to the RAS pump. There is no provision for controlling flow or metering flow from either of the clarifiers; sludge blankets would be very difficult to control.

In the second diagram each clarifier has its own RAS flow control valve and pump. The two pumps discharge into a common pipe where the flow is metered. This is a better situation, allowing the operator to vary the amount of RAS from each clarifier, but since the meter only measures the total flow from the two clarifiers, it will be very difficult to balance the RAS flow. Even with equally sized pumps and with the control valves set the same, the RAS pumped from the two clarifiers will not be the same, since the hydraulic head pumped against will be different for each pump. Installing a meter on the pipe from each clarifier rather than on the combined flow would provide better control, but adjusting the flow from one clarifier would still affect the flow from the other.

The third diagram represents the best approach. RAS from each clarifier flows through a control valve and flow meter to a wet well, where a set of pumps draws from the wet well. This arrangement allows the operator to make adjustments to the RAS flow from each clarifier as needed.

#### IV. Biomass Settleability

Earlier we discussed the three steps of biological wastewater treatment which includes Transfer, Conversion, and Flocculation and Separation. Even though the first two steps may take place effectively, without the ability to separate the biomass from the wastewater the process will not function. The organisms must combine into properly sized particles that have sufficient density to allow them to sink to the floor of the secondary clarifier. The biomass must compact well enough that the sludge blanket does not occupy an excessive amount of space in the clarifier or solids may be lost in the effluent.

A simple procedure called the **Settleometer Test** is used to determine the settling characteristics of mixed liquor. The test requires a settleometer, which is typically a clear plastic cylinder with a capacity of 2 liters. Graduations on the cylinder range from 100 to 1000 cubic centimeters (or milliliters) of settled sludge per liter.

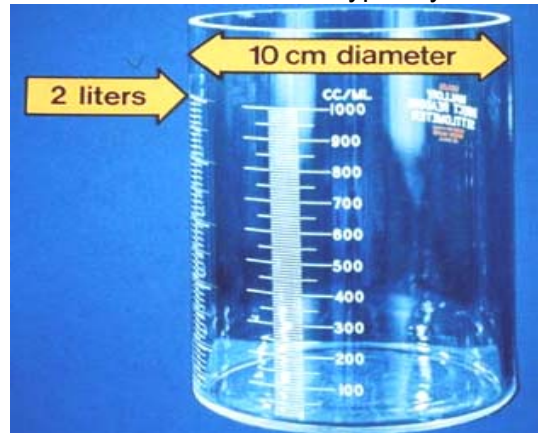

A sample of mixed liquor should be obtained from the discharge end of the aeration tank, being careful not to include scum in the sampling container. Do not allow the sample to set for more than a few minutes before the settling test is performed. Determine the MLSS concentration in milligrams per liter on a portion of this sample.

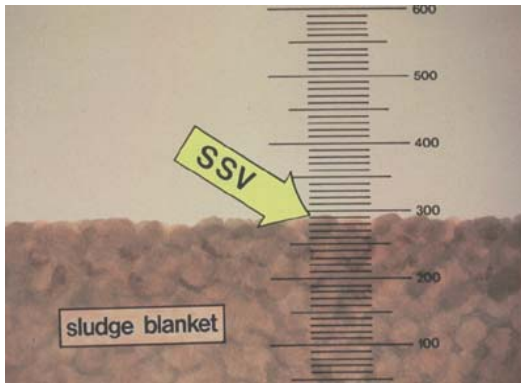

Mix the sample well, and fill the settleometer to the 1000 graduation. Immediately start a timer and at the end of 30 minutes record the settled sludge volume in the settleometer.

It is a good idea to occasionally record the settled sludge volume every 5 minutes while the solids are settling and prepare a graph of settled sludge volume versus minutes. This allows the operator to see whether the solids are settling too quickly or slowly. Solids that settle too quickly may be an indication of an

old sludge that will probably leave straggler floc in the effluent, while solids that settle too slowly or do not compact well may be washed out of the clarifier during times of high hydraulic load.

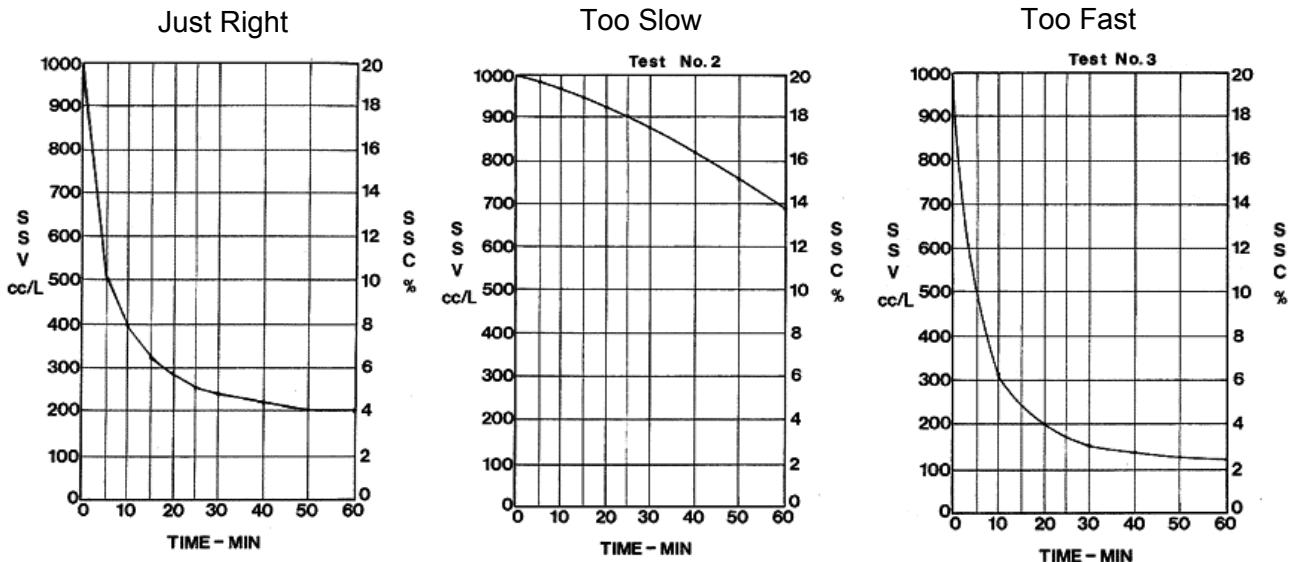

It is also a good practice to allow the sample to set in the settleometer for an additional 30 to 60 minutes after the settling test. Watch for tiny bubbles which form in the settled sludge. These nitrogen bubbles form as nitrate is reduced to nitrogen gas (denitrification) under anoxic conditions. As the bubbles rise they attach themselves to floc particles and float them to the surface. A small amount of denitrification occurring in the secondary clarifier will cause a scum to form on the surface, while a large amount of denitrification may float a significant portion of the biomass to the top of the clarifier. The settleometer test may give the operator the first warning that this may become a problem.

Two main factors determine the settled sludge volume in the settleometer at the end of the 30 minutes. The first, solids compaction indicates how much volume the biomass will occupy. But the operator must recognize the influence of the second factor, MLSS concentration, in settled sludge volume. As long as the MLSS doesn't change, settleometer test results can be compared from one day to the next. But as the MLSS increases, the settled sludge volume in the settleometer will increase. Since we use the settleometer test mainly to indicate how well the mixed liquor compacts, we must account for the concentration of the biomass in the settleometer. This allows the operator to track changes in sludge quality even though the MLSS concentration changes.

### Sludge Volume Index (SVI)

SVI is used by operators to determine and compare mixed liquor settleability. It mathematically relates settled sludge volume in the settleometer to MLSS concentration. The definition for SVI is: **The volume in milliliters occupied by one gram of activated sludge which has settled for 30 minutes.** Note that SVI relates sludge volume in milliliters to MLSS concentration in grams per liter. A simple formula for SVI is:

$$\text{SVI} = \frac{\text{mls Settled in 30 min}}{\text{MLSS Conc, grams/L}} \quad \text{or} \quad \text{SVI} = \frac{\text{mls Settled}}{\text{MLSS, mg/l} / 1000}$$

Consider an example where a settleometer is filled to the mark with mixed liquor which has a concentration of 2400 mg/L, and after 30 minutes the settled sludge volume is 260 ml. The SVI is calculated as follows:

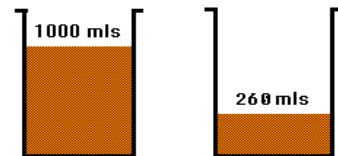

$$\text{SVI} = \frac{\text{mls Settled}}{\text{MLSS, mg/L} / 1000} = \frac{260 \text{ ml}}{2400 \text{ mg/L} / 1000} = \frac{260}{2.4} = 108$$

The SVI of 108 indicates that each gram of settled sludge will occupy a volume of 108 milliliters. The SVI is typically given without units. Keep in mind that as the SVI increases, the sludge is less compact, occupying more volume (the sludge blanket in the clarifier increases). A perfect situation is considered to be that in which 1 gram of sludge will occupy a volume of 100 ml (SVI = 100/1.0 = 1.0). SVI in a range of 80 to 120 indicates good settleability.



**Sludge Density Index (SDI)**

SDI is another way to express sludge compaction, makes use of the same information as SVI, but expresses it as sludge density (weight per volume rather than volume per weight). The definition for SDI is: **The grams of activated sludge which occupies a volume of 100 ml after 30 minutes of settling.** The formula for SDI is:

$$\text{SDI} = \frac{\text{grams/L of MLSS}}{\text{mls settled in 30 min} / 100} \quad \text{or} \quad \frac{\text{MLSS, mg/L} / 1000}{\text{mls settled in 30 min} / 100}$$

Consider the example given above where MLSS is 2400 mg/L and after 30 minutes of settling the sludge occupies a volume of 260 ml. The SDI is calculated as follows:

$$\text{SDI} = \frac{2400 \text{ mg/l} / 1000}{260 \text{ ml} / 100} = \frac{2.4}{2.6} = 0.92$$

The SDI of 0.92 indicates that each 0.92 grams of sludge will occupy a volume of 100 ml. As the SDI increases compaction increases, and the volume that the sludge blanket occupies decreases. Like SVI, a perfect situation is taken as one where 1 gram of sludge occupies a volume of 100 ml (SDI = 1.0 / 100/100 = 1.0). The range of good settleability when using SDI is 0.8 to 1.2; again the SDI is typically given without units.

**SVI / SDI Relationship**

Operators do not typically use both SVI and SDI, since both are indicators of sludge compaction, but usually use the one that they are most comfortable with. For those not wishing to try to remember both formulas there is a simple conversion between the two: divide the one that you have into 100 and you get the other.

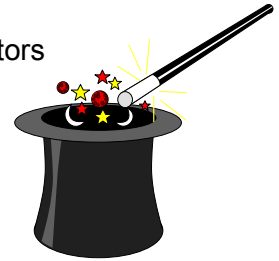

$$\text{SDI} = 100 / \text{SVI} \quad \text{SVI} = 100 / \text{SDI}$$

For instance, if the SVI is 133, the SDI is  $100 / 133 = 0.75$ . If the SDI is 0.6, the SVI is  $100 / 0.6 = 167$ .

**Relationship of SDI to RAS Concentration**

The settleometer test is used to approximate conditions in the secondary clarifier. This means that the concentration of the settled sludge in the settleometer should be approximately the same as the concentration of the settled sludge in the clarifier, which is the Return Sludge.

Consider the mathematical definition of SDI:

$$\text{SDI} = \frac{\text{grams/L of MLSS}}{\text{mls settled in 30 min} / 100}$$

An SDI of 1.0 means that 1 gram of sludge occupies a volume of 100 ml:

$$\text{SDI } 1.0 = \frac{1 \text{ gram} / \text{Liter}}{100 \text{ ml} / 100}$$

So the concentration of the settled sludge in the settleometer (and the RAS from the clarifier) would be 1 gram / 100 ml, or 10 grams per liter. Since water (and most sludge)

weighs 1 gram per milliliter, we can express the relationship as 1 gram of sludge per 100 grams of water, which is the same as a 1 % solution by weight:

$$\text{SDI} = 1.0 = \frac{1 \text{ gram solids}}{100 \text{ ml water}} = \frac{1 \text{ gram solids}}{100 \text{ grams water}} = 1 \% \text{ RAS Concentration}$$

Or we can express the concentration of the settled sludge (RAS) in terms of mg/L:

$$\text{SDI} = 1.0 = \frac{1 \text{ gram solids}}{100 \text{ ml water}} = \frac{1000 \text{ mg solids}}{100 \text{ ml water}} = \frac{10,000 \text{ mg solids}}{1000 \text{ ml water}} = 10,000 \text{ mg/L RAS}$$

So if the SDI is 1.0, the RAS concentration would be expected to be 1%, or 10,000 mg/L.

**Relationship of F:M to Settleability**

The graph at the right illustrates the impact that F:M has on mixed liquor settleability. Starting on the right hand side of the graph and moving to the left, one can see that as the F:M drops from a starting point of 1.2, the SVI increases drastically and then drops again to within a controllable area at an F:M range of 0.25 – 0.45. If the F:M continues to decrease, the SVI again rises sharply and then drops to another controllable area at F:M less than 0.20.

Operationally, this indicates that there are three areas where settleability should be good, defined by F:M range as High Rate, Conventional, and Extended Air. While the High Rate mode of operation is not practical for most, many Activated Sludge facilities operate in the Conventional mode and many operate in the Extended Air mode. The graph also indicates the potential consequences of allowing conditions to wander too far from these F:M ranges.

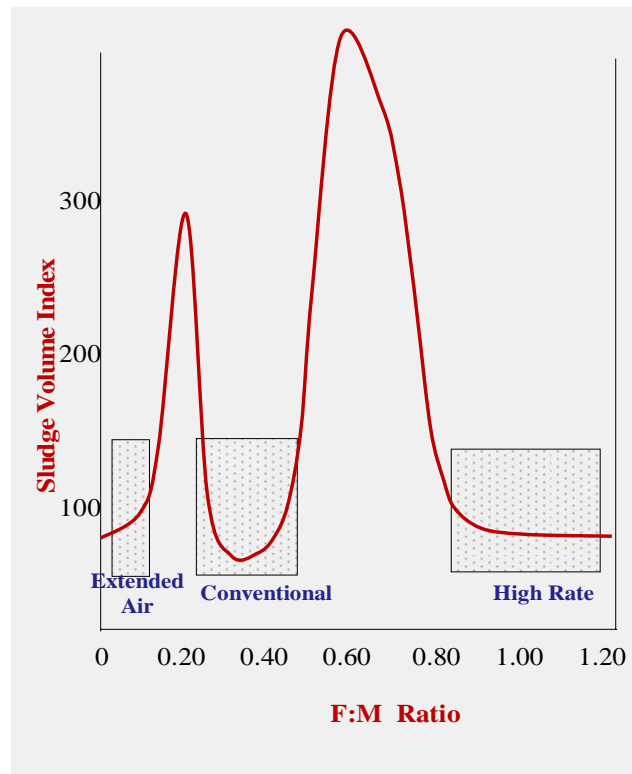

# AERATION

## V. Aeration Requirements and Equipment

### Aeration Requirements

Aeration of the contents of the activated sludge reactor accomplishes two important requirements. Mixing must occur in order to provide contact between the biomass and the incoming pollutants; assuring that the entire contents of the aeration tank are kept in suspension. Dead zones in the tank may allow settling to occur and mixed liquor will accumulate on the floor of the tank. As this settled material begins to decompose an area of low dissolved oxygen is created, forming conditions conducive to the growth of filamentous bacteria. These filaments bridge between floc particles, reducing the density of the mixed liquor and causing settling problems in the secondary clarifier. In facilities where aeration equipment does not provide adequate mixing, supplemental mixing may be required.

Aeration must also provide oxygen to the huge population of aerobic and facultative bacteria and other organisms in the mixed liquor. Operators typically control the aeration rate to assure a concentration of 2 – 3 mg/L of dissolved oxygen (D.O.) at the discharge end of the aeration tank. Higher D.O. concentrations waste power, while low D.O. (<1 mg/L) may encourage the growth of filamentous bacteria.

The amount of air that must be supplied to the aeration tank to achieve the required D.O. concentration depends on several factors. As BOD (biochemical **oxygen demand**) loading increases the organisms will require more oxygen to metabolize the waste and more air must be supplied to keep the D.O. concentration within the desired range. Likewise, as the number of pounds of biomass in the system increases the air supply must be increased; each organism will use the amount of oxygen needed to sustain itself. Treatment objectives such as **Nitrification and Denitrification** are also factors which determine how much air must be supplied. While it takes 1.0 to 1.5 pounds of oxygen to degrade 1 pound of BOD, it takes 4.5 pounds of oxygen to convert 1 pound of ammonia to nitrate (nitrification).

The **Oxygen Transfer Efficiency** of the aeration equipment plays a large role in determining how much oxygen is supplied to the organisms with each cubic foot of air delivered to the aeration tank. Not all of the oxygen supplied to the aeration tank is dissolved into the water; most of it remains in gaseous form, bubbles to the surface, and is lost to the atmosphere.

The Standard Oxygen Transfer Efficiency (SOTE) for various aeration equipment ranges from about 10% up to about 40% in clean water and at 15 feet of submergence (diffused aeration). Oxygen Transfer may also be given as Standard Oxygen Transfer Rate (SOTR), given in units of pounds of oxygen transferred per horsepower hour.

The Actual Oxygen Transfer Efficiency (AOTE) or Actual Oxygen Transfer Rate (AOTR) in wastewater will be considerably less than the SOTE or the SOTR. Oxygen transfer is affected by many factors, including the type of equipment utilized (and how well it is maintained), air temperature, chemical characteristics of the water, and the rate at which the organisms use the oxygen (**oxygen uptake rate**). For instance, while the SOTR for a particular aeration device may range as high as 6.5 pounds of oxygen per horsepower hour, the AOTR may be expected to be in the range of 2.5 pounds of oxygen per horsepower hour.

**Aeration Equipment – Mechanical Aeration**

Air may be supplied to the aeration tank using either **mechanical aerators** or a **diffused aeration system**. Mechanical aerators splash the mixed liquor into the air, causing oxygen to dissolve into the water. There are many types of mechanical aerators, including vertical and horizontal designs. Vertical aerators may pump mixed liquor from near the bottom of the tank and discharge it against a deflector, or may function as large impellers, spinning partially submerged in the mixed liquor near the



surface of the aeration tank. Adjustment of the depth of submergence changes the amount of aeration and mixing that occurs.

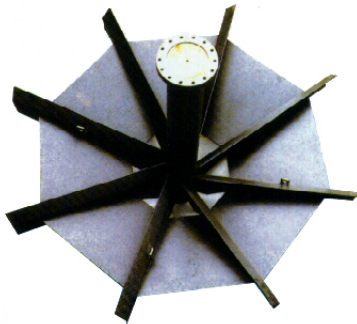

Horizontal mechanical aerators, or rotors, are commonly seen in oxidation ditch facilities in which a long horizontal shaft is suspended just above the surface of the aeration tank. Metal brushes or plastic discs attached to the shaft

rotate partially submerged in the mixed liquor, providing aeration and imparting velocity to the mixed liquor which keeps the biomass in suspension. Again, the aeration rate may be changed by adjusting the depth of liquid in the tank, thus raising or lowering the submergence of the rotor.



Actual Oxygen Transfer Rates for mechanical aerators range from about 1.8 to 2.5 pounds of oxygen per horsepower hour.

**Aeration Equipment – Diffused Aeration**

The most commonly used method of aeration in conventional activated sludge plants is the diffused aeration system. In this system a blower (compressor) is used to supply air at low pressure into a piping arrangement with air diffusers submerged near the floor of the aeration tank. The diffusers break the air flow into small bubbles from which oxygen is transferred to the liquid as the bubbles rise to the surface. Increasing the amount of time the bubble is in contact with the liquid increases the oxygen transfer efficiency. Aeration tanks are typically designed deep enough (often about 15 – 18 feet) to maximize the travel time of the bubble to the surface, but not so deep as to create so much head (pressure) against the blower that it operates beyond its range of maximum efficiency. Aeration tanks are also sometimes configured to cause a rolling motion of the liquid in the tank, again to keep the air bubbles in contact with the mixed liquor for as long a time as possible.

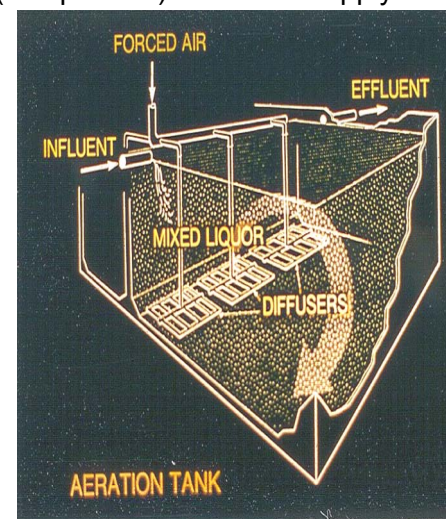

Blowers may be classified as either **positive displacement** or **centrifugal**.

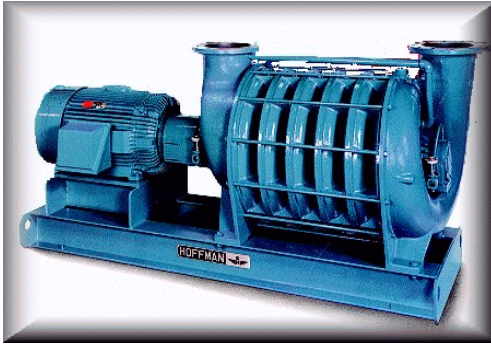

Centrifugal blowers are used in nearly all medium to large activated sludge plants. These operate as high rpm turbines, with air outputs of 20,000 - 150,000 CFM. The volume of air pumped is variable within a range, adjusted by controlling an Inlet Guide Vane (throttling valve on the suction side of the blower).



Positive displacement blowers are often referred to as rotary lobe blowers. As the rotating lobes rotate, a fixed volume of air is displaced each time the lobes come together. These blowers operate at lower rpm than centrifugal blowers and generally produce less than 20,000 CFM of air. Unlike centrifugal blowers, the air output of positive

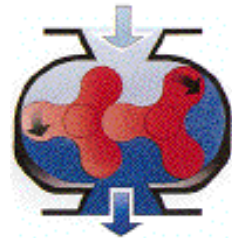

displacement blowers cannot be varied by use of throttling valves. Air output may only be changed by changing the speed at which the blower operates, for instance by changing pulley size on blower or motor.

### Blower Maintenance

Whether centrifugal or positive displacement, blowers are difficult and expensive to repair, largely due to the fact that they operate at high speed and are machined to very close tolerance. Wastewater treatment plant shops are seldom equipped to perform major repairs on this type of equipment, and usually contract for this work to be done. Heat, vibration, and dust are often causes of premature wear and blower failure. Improperly maintained air filters which results in suction side air restrictions, or leaks which allow dust to enter the blower are damaging to either type of blower. Lubrication and other preventive maintenance must be done in accordance with the manufacturer's specifications.

### Piping

Piping which connects the blower to the air diffusion system at the aeration tank may be either a simple drop pipe extending from the deck of the aeration tank to the floor of the tank, or may be a swing type system. The advantage of the swing system is that hinges in the piping allow the operator to retrieve a bank of aerators out of the tank using a crane on the deck of the tank when diffuser maintenance is needed. Needless to say, this operation requires an adequate crew and careful observance of all safety considerations.

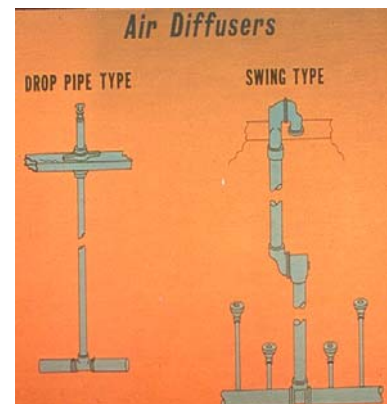

### Diffusion Equipment

Air diffusers have been designed in many shapes and sizes through the years; some have been more successful than others. Air diffusers may be generally classified as either coarse bubble or fine bubble.



**Coarse bubble diffusers** have been used for many years in activated sludge plants. As pressurized air from the blower flows from the air header through a small orifice in the diffuser the air is broken up into small bubbles. The diffusers are generally made of plastic or stainless steel and provide good mixing and aeration with minimal head loss. These diffusers are resistant to plugging and may operate for long periods of time with minimal maintenance. Reported

Standard Oxygen Transfer Efficiency in clean water for coarse bubble diffusers varies from 9% to 13% at 15 feet of submergence. Actual Oxygen Transfer Rates range from about 1 to 2 pounds of oxygen per horsepower hour, depending on the type of diffuser and the configuration of the aeration tank.

**Fine bubble diffusers** began gaining popularity in the 1970's as energy costs increased and discharge permit limits became more stringent. Given that power costs to operate the aeration system in an activated sludge plant make up a very large part of the annual budget for the facility, the need to maximize the efficiency of aeration systems is obvious. Reported Standard Oxygen Transfer Efficiency varies widely depending on the type of diffuser, ranging from 13% to 40% in clean water at 15 feet of submergence. Again, it should be noted that actual transfer efficiency in wastewater will be lower than in clean water, especially as the system ages. Actual Oxygen Transfer Rates vary from about 1.3 to 2.5 pounds of oxygen per horsepower hour.

Early fine bubble diffusers included porous socks that were tied over coarse bubble diffusers. These met with limited success, as it was not unusual for the operator to find many of the socks floating in the aeration tank a short time after installation. Porous plate diffusers were also developed which significantly improved oxygen transfer, but often plugged and became maintenance intensive.

Currently there are several suppliers of fine bubble diffusers on the market, and many activated sludge plants around Michigan have converted coarse bubble systems to fine bubble systems. Modern fine bubble diffusers have reduced energy consumption in activated sludge plants and are less susceptible to plugging.

Fine bubble diffusers are available in several configurations, including among others:



**Ceramic Dome Diffusers**



**Porous Flexible Membrane Diffusers**



**Ceramic Disc Diffusers**

Diffuser plugging is still a concern with fine bubble diffusion systems; fouling may occur either from the air side of the diffuser or from the water side. Air side fouling may be caused by dust and dirt that is drawn into the blower and deposited on the inside of the diffuser, oil from the blower or piping, and pipe scale and rust.

Water side fouling may occur as a result of power failures, where pressure is lost on the diffuser and solids begin to accumulate on and in the diffusion material. Poor air distribution may allow contaminants to build up on diffusers where the air supply is lower. Other causes of water side fouling include excessive amounts of oil and grease in the wastewater, high organic load on the aeration tank, precipitation of inorganic materials on the diffuser, and bioslime growth on the diffuser.

Facilities which utilize ceramic fine bubble systems are sometimes designed with a **gas cleaning system** in which hydrogen chloride gas is injected into the diffusion system periodically. This gas will form acidic conditions at the diffuser, killing biological slime growths and dissolving inorganic precipitates. This may be performed by staff at the facility or may be contracted to a firm that is more familiar with handling this type of equipment. Although originally thought to be needed about every six months, many facilities have found that cleaning is not required that frequently.

## VI. Factors Affecting Biological Activity

### Effect of Temperature on Activated Sludge

As is true of any biological system, the activity and efficiency of the biomass in an activated sludge facility is dependant to a fairly large extent on the temperature of the wastewater. It has been demonstrated that each 10 deg C drop in water temperature in the aeration tank reduces biomass activity by about 50%. This means that as the water temperature drops, organism growth rate slows down. BOD removal will occur more slowly, and the system will require a longer recovery after upset.

Wastewater temperature is usually more stable in cities using ground water as the drinking water supply. Influent sewage in these cities usually stays pretty consistently in the 50-55 degree F range. Facilities in cities that use lake or river water as the drinking water source may experience a wider range of wastewater temperatures. Often the biggest changes in wastewater temperature occur following a rapid snow melt and after rainfall.

As indicated in the graph above, biological activity increases to a maximum at a temperature of about 100 degrees F. Increased temperature beyond that point would be expected to result in a sudden die-off of the biomass.

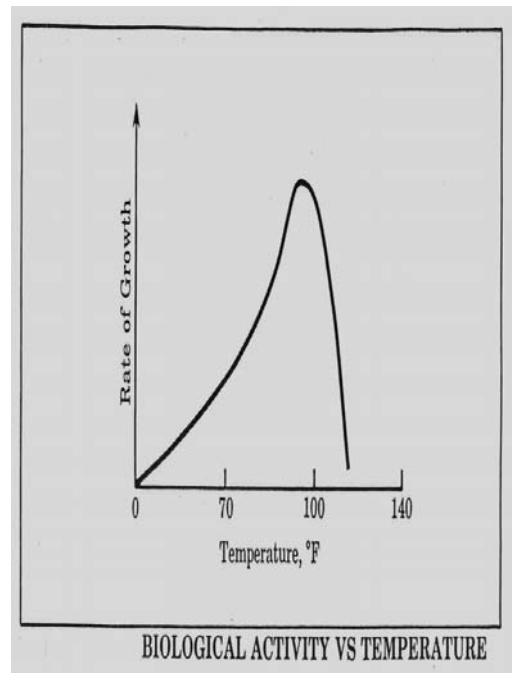



### Effect of pH on Activated Sludge

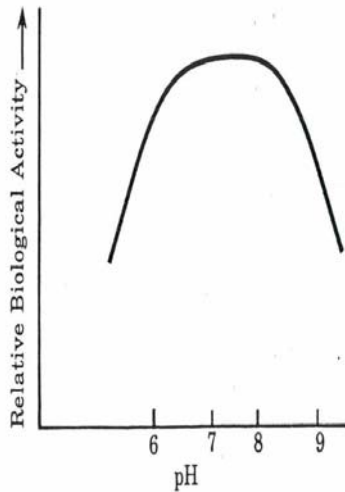

As shown in the graph at the left, biological activity in an activated sludge plant is best in a pH range of about 6.5 to 8.5. Growth may occur outside of that range, but at a reduced rate, and may result in the filamentous bacteria, especially at low pH values. Oxygen uptake is thought to be optimum between pH 7.0 and 7.4. Generally pH values below 7 are more detrimental than those above 7. Sudden changes and frequent fluctuations in pH are most damaging.

Although pH may be controlled at the wastewater treatment plant by acid or base addition before the aeration tanks, this is expensive, and not practical at most municipal facilities and large industrial plants. The

best means of controlling influent pH is to control the source of acids and bases discharged into the collection system.

### Toxicity in Activated Sludge Facilities

A wide range of organic and inorganic compounds are known to be toxic to activated sludge biomass. Many of the heavy metals such as cadmium, chrome, nickel, and lead are toxic above about 1 mg/L. Silver, and arsenic, and mercury are toxic at concentrations much less than 1 mg/L. Cyanide, herbicides, and pesticides are toxic to this biological system as they are to any other.

Toxicity often first becomes apparent as a rise in D.O. concentration in the aeration tank. As organisms become impaired or destroyed by the toxic material, the rate of oxygen uptake decreases, so the D.O. concentration in the aeration tank increases. This may be followed by **deflocculation**, where floc particles are no longer able to maintain their structure and come apart to leave a very turbid effluent. Settleability in the secondary clarifier is often impaired, and if the facility has been nitrifying a sudden increase in effluent ammonia will usually occur as the nitrifying organisms are killed. Higher effluent BOD may occur, as heterotrophic bacteria and other organisms are impaired or killed.

Organisms may acclimate to some extent to low concentrations of a toxic material, so long as the concentration is fairly consistent. Activated sludge plants have been known to remove significant amounts of heavy metals from wastewater flows after acclimation. Sudden increases or long periods of time between dosages will produce toxic effects.

A problem which may result from the removal of toxic materials (especially metals) by the biomass is that this material often concentrates in the sludge wasted from the secondary system. This in turn causes problems for the facility that intends to dispose of this sludge on agricultural land. The best solution to this problem is to control toxic materials at their source, not allowing them into the collection system.

### VI. Oxygen Uptake Rate (OUR)

The rate at which the biomass uses oxygen in the metabolism of pollutants in wastewater is dependant on several factors. The amount and age of the biomass,

water temperature, amount of food available, and the health of the biomass all affect how quickly wastes are metabolized, and therefore how quickly oxygen is used. Determination of the OUR may be used by the operator as a control tool, especially in monitoring the system for toxic materials in the wastewater. A lower than normal OUR in a system that has plenty of food and microorganisms is usually an indication that the biomass has been impacted by toxicity; a higher than normal OUR may indicate an organic overload. A high OUR that returns to normal within a short time may indicate a shock or slug load.

While OUR must be determined on a fresh sample from the aeration tank, sample collection point will be an important consideration. Samples should be collected at the head of the tank where return sludge mixes with influent wastewater. OUR should be at it's highest at this point in the aeration tank and will give a good indication of metabolism under high food conditions; probably the best sampling point to monitor for toxicity. Samples collected near the discharge end of the aeration tank should indicate that metabolism is nearly complete before passing to the secondary clarifier. A high OUR at the discharge end of the aeration tank may be an indication of inadequate detention time in the aeration tank or of an organic overload. It would be wise for the operator to collect samples at both ends of the aeration tank and at the midpoint to have an overall indication of how metabolism progresses through the tank.

The OUR test is simple and quickly performed with equipment already on hand in the WWTP laboratory. Equipment needed includes a D.O. meter with BOD bottle probe and a timer. OUR simply measures the amount of oxygen used up in a BOD bottle over a 10 minute time period, with the results reported as milligrams per liter of oxygen used per hour.

The test can be modified to eliminate the variable due to the amount of biomass in the sample by dividing the OUR by the grams per liter of MLSS. In this case the result is reported as the Specific Oxygen Uptake Rate (SOUR), in units of milligrams oxygen used per hour per gram MLSS. SOUR may also be referred to as the Respiration Rate (RR).

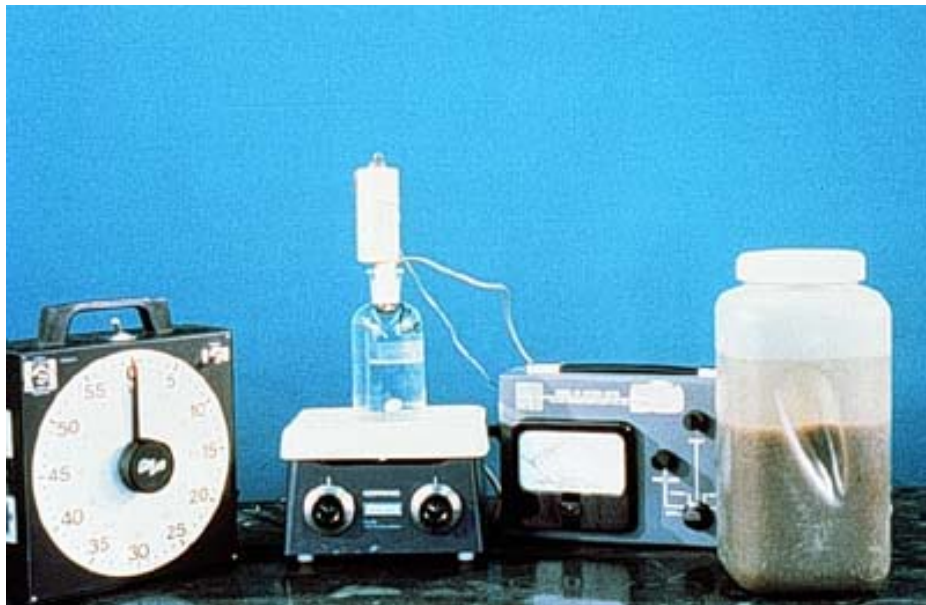

**SPECIFIC OXYGEN UPTAKE RATE  
(Respiration Rate)**

1. Obtain a fresh sample of mixed liquor from the aeration tank.
2. Determine the concentration (Grams / Liter) of MLSS.
3. Saturate the sample with dissolved oxygen by shaking in a partially filled container for at least 45 seconds (or use compressed air with an air stone).
4. Completely fill a 300 ml BOD bottle and insert a calibrated D.O. probe. Use stirrer on probe or a magnetic mixer and stir bar.
5. Wait for about a minute while the D.O. meter stabilizes.
6. Record mg/L D.O. decrease over a 10 minute interval.
7. Calculate SOUR, mg O<sub>2</sub>/hr/G

$$\text{SOUR, mg O}_2\text{/hr/gram} = \frac{\text{OUR, mg O}_2\text{/L/hr}}{\text{MLSS, grams/L}}$$

**Example:**

**Determine the SOUR of a Mixed Liquor Sample Given the Following Data:**

**MLSS = 2500 mg/L Initial D.O. = 8.3 mg/L**

**Final D.O. = 2.4 mg/L**

**The oxygen depletion was recorded over 10 min.**

$$\frac{\frac{8.3 \text{ mg/L} - 2.4 \text{ mg/L}}{10 \text{ min}} \times \frac{60 \text{ min}}{\text{hr}}}{2.5 \text{ G/L}} = \text{SOUR} = 14.16 \text{ mg O}_2\text{/hr/G}$$

In some situations, it may be advantageous to determine the SOUR on a “Fed” sample; in other words on a sample into which a source of food is added, typically a sugar solution. If the SOUR is still low on a mixed liquor sample after the addition of the sugar solution, the presence of a toxic or inhibitory substance is probably indicated.

The SOUR test can also be used to help determine whether a waste is biodegradable. Substitute the supernatant from a settled mixed liquor sample with the wastewater in question. If the SOUR is high, the waste is treatable in the biological process; if the SOUR is low either the waste contributes little food, or a toxic effect may be indicated. Again, the addition of sugar into the test would probably help to determine if the waste is toxic.

An online respirometer, which monitors oxygen uptake continuously, may be helpful in some facilities. Although expensive and fairly maintenance intensive, this instrumentation may be warranted where influent loading characteristics may change significantly and suddenly or where influent toxicity is a frequent concern.

# MICROSCOPIC EXAMINATION

## VI. Microscopic Examination of Activated Sludge

Microscopic examination of the MLSS can be a significant aid in the evaluation of the activated sludge process. Although the heterotrophic and autotrophic bacteria which are mainly responsible for purifying the wastewater are too small to be easily observed, the presence of several other microorganisms within the sludge floc may give an indication of treatment conditions and efficiency. The most important of these indicator microorganisms are the protozoa and the rotifers. These higher life forms also play an important role in clarifying the wastewater, consuming bacteria and small particulates, and improving biomass settleability.

A predominance of ciliates and rotifers in the MLSS is a sign of good sludge quality. Treatment under these conditions, with proper RAS, WAS and aeration rates, can be expected to produce a high quality effluent. Inversely, a predominance of filamentous organisms and a limited number of ciliates is characteristic of a poor quality activated sludge. This condition is commonly associated with a sludge that settles poorly. The sludge floc is usually light and fluffy because it has a low density. There are many other organisms such as nematodes (worms) and waterborne insect larvae which may be found; however, these typically do not significantly affect the quality of treatment.

The microorganisms which are important to the operator are the protozoa and rotifers. As discussed previously, the protozoa eat the bacteria and help to provide a clear effluent. Basically, the operator should be concerned with three groups of protozoa, each of which have significance in the treatment of wastewater. These groups include the following:

- 1) Amoeboids
- 2) Flagellates
- 3) Ciliates

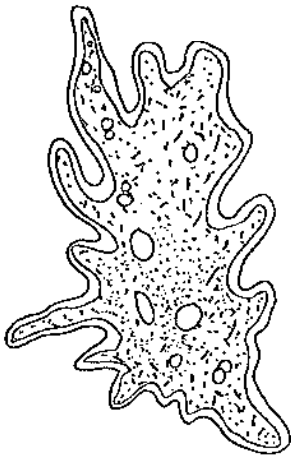

### Amoeboids

The cell membranes of Amoeboids are extremely flexible; and the mobility of these organisms is created by the movement of protoplasm within the cell. Food matter is ingested by absorption through the cell membrane. Amoeboids may predominate in the MLSS floc during start-up periods of the activated sludge process or when the process is recovering from an upset condition.

### Flagellates

These organisms are characterized by the tail (Flagella) which extends from their round or elliptical cell configuration. Their mobility is created by a whipping



motion of the tail, which allows them to move with somewhat of a corkscrew motion. Flagellate predominance may be associated with a light-dispersed MLSS floc, a low population of bacteria, and a high organic load (BOD). As a more dense sludge floc develops, the flagellate predominance will decrease with an increase of bacteria. When the flagellates no longer are able to successfully compete for the available food supply, their population decreases to the point of insignificance.

## Ciliates

These organisms are characterized by the rotating hair-like membrane (cilia) which cover all or part of their cell membrane. Their mobility is created by the movement of the cilia, and the cilia around the gullet are utilized for the intake of food. Ciliates may predominate during the period of fair to good settling of the activated sludge.

They are considerably larger than flagellates and for the purposes of microscopic examination may be classified into two basic groups, which are the free swimming and the stalked ciliates.

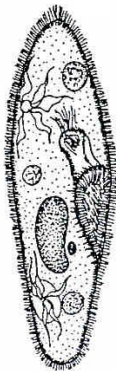

### Free Swimming Ciliates

Free swimming ciliates are usually apparent when there are a large number of bacteria in the activated sludge. These organisms feed or graze on the bacteria and clarify the effluent. Therefore, their presence is generally indicative of a treatment process that is approaching an optimum degree of treatment. A relative predominance of flagellates indicates decreased treatment efficiency and the MCRT of the system should be increased to maintain a relative predominance of free swimmers, stalked ciliates and higher forms of organisms such as rotifers.

### Stalked Ciliates

These organisms are frequently present when the free swimmers are unable to compete for the available food. A relative predominance of these organisms along with rotifers will indicate a stable and efficiently operating process.

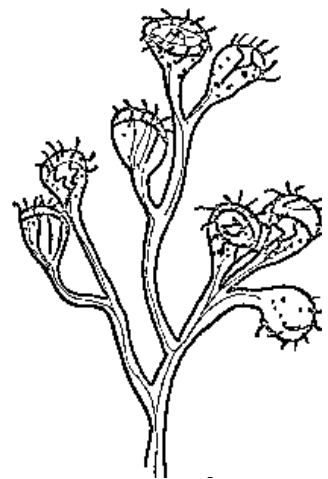

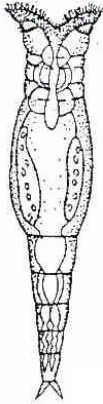

## Rotifers

Although large in comparison with most other activated sludge organisms, rotifers are a group of the smallest multi-cellular microorganisms. They are strictly aerobic, existing only where dissolved oxygen is plentiful. Rotifers may attach to floc particles by use of a forked tail or may swim freely in the wastewater, grazing on bacteria, algae, protozoa, and small particulate matter in the waste. At their anterior end they possess cilia which are rotated to gather food as well as to propel the organism through the water. Rotifers are more abundant at higher cell residence times and are an indication of a high level of treatment.

## MLSS Evaluation by Microscopic Examination

Observation of microorganism activity and predominance in the activated sludge can provide guidance in making process control adjustments. The Worksheet for Microscopic Examination for Activated Sludge can assist the operator in deciding whether to increase or decrease the MCRT based on the relative predominance of the organisms found in the MLSS. The decline of ciliates and rotifers is frequently indicative of a poorly settling sludge. These observations may make it possible to detect a change in organic loading or cell residence time before an upset occurs. These changes can be correlated with observations of the settling characteristics of the MLSS in the 30-minute settling test, and by calculation of the F/M. If the other tests confirm these observations, adjustments to the MLSS should be made to alleviate the problem.

In summary, relative predominance of ciliates and rotifers are an indication of process stability. This predominance is associated with the efficiency of treatment under various loading conditions. An increase or decrease in the predominance of these organisms may be indicative of process upset before there is a major effect on process performance.

### Selection of a Microscope

Features which should be considered the minimum when selecting a microscope to be used for routine operational use include the following:

- 1) Built-in illumination or an external system which allows variations of light intensity.
- 2) A condenser system.
- 3) A movable stage. Stage should be controlled by coaxial handle rather than a manual push-pull.
- 4) 10X and 40X objectives.
- 5) 10X eyepiece.

Auxiliary equipment should include

- 6) Light blue filter (daylight type)
- 7) Slides
- 8) Coverslips
- 9) Several small dropping pipettes



## Optical and Mechanical Features of THE MICROSCOPE

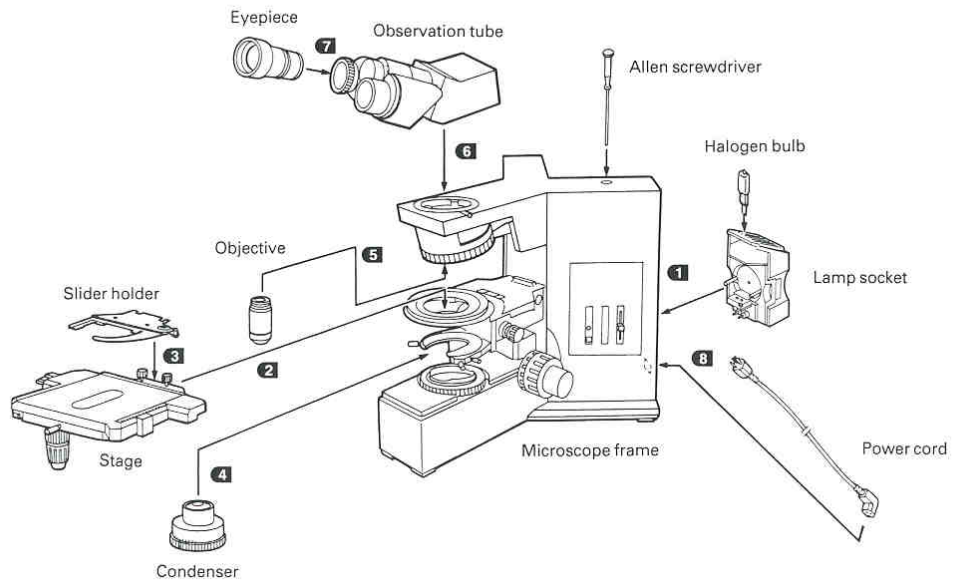
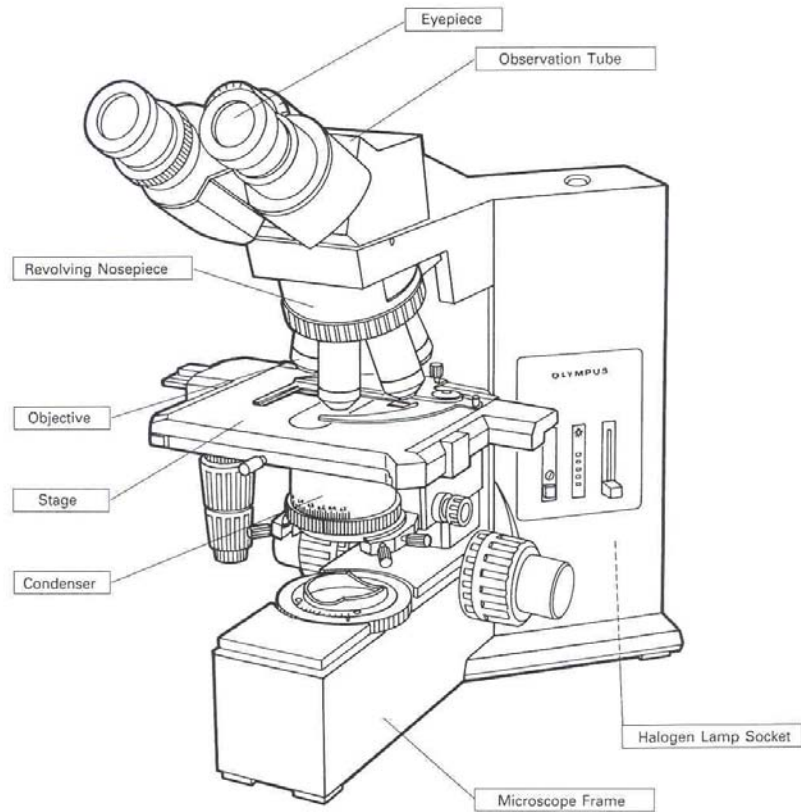

## Use of the Microscope

Procedures for preparing slides and using the microscope include the following:

- 1) Select a clean cover slip and slide.
- 2) Use a pipette or a long tipped medicine dropper to transfer one drop of the mixed liquor sample onto the center of the glass slide.
- 3) Carefully pick up the cover slip by two corners. Do not touch the clean area.
- 4) Pull cover slip along glass slide towards drop of sludge.
- 5) As soon as cover slip touches drop of sludge, allow cover slip to fall onto glass slide.
- 6) Place slide on microscope stage.
- 7) Move stage up to within approximately 1/8 inch of objective. Look at glass slide through the eyepiece of the microscope.
- 8) Use the coarse adjustment on the microscope to bring the sludge into the field of focus.
- 9) Use fine adjustment to refine focus to suit your eyes.
- 10) Identify organisms in the sludge.

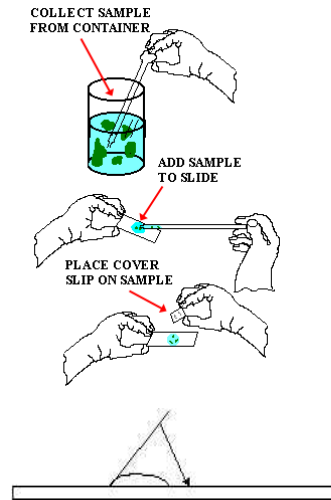

## Procedures for Examination

When performing a microscopic examination of activated sludge, a sheet of paper should be kept handy to sketch the types observed. In the event that unknown varieties of microorganisms are made, the operator may identify these later. The objective of the examination is to determine relative predominance of microorganisms. This may be accomplished by the procedures outlined below and utilizing a worksheet as illustrated in the attached.

Examination Procedures:

- 1) Record the date, time, temperature, and location of the sample on the worksheet.
- 2) A minimum of three slides per sample should be examined.
- 3) Scan each slide and count the number of microorganisms in each group.
- 4) Provide a mark for each microorganism counted in the appropriate group space on the worksheet.
- 5) After completing the examination of the three slides, total the number of organisms counted in each group.
- 6) The three higher totals are interpreted as the predominating organisms.

**WORKSHEET FOR  
MICROSCOPIC EXAMINATION OF  
ACTIVATED SLUDGE**

Date: \_\_\_\_\_ Time: \_\_\_\_\_ AM  
 PM  
 BY: \_\_\_\_\_ Temp: \_\_\_\_\_ °C  
 Sample Location: \_\_\_\_\_

| Microorganism Group    | Slide No. 1 | Slide No. 2 | Slide No. 3 | TOTAL |
|------------------------|-------------|-------------|-------------|-------|
| Amoeboids              |             |             |             |       |
| Flagellates            |             |             |             |       |
| Free Swimming Ciliates |             |             |             |       |
| Stalked Ciliates       |             |             |             |       |
| Rotifers               |             |             |             |       |
| Worms                  |             |             |             |       |

Relative Predominance:

- 1.
- 2.
- 3.

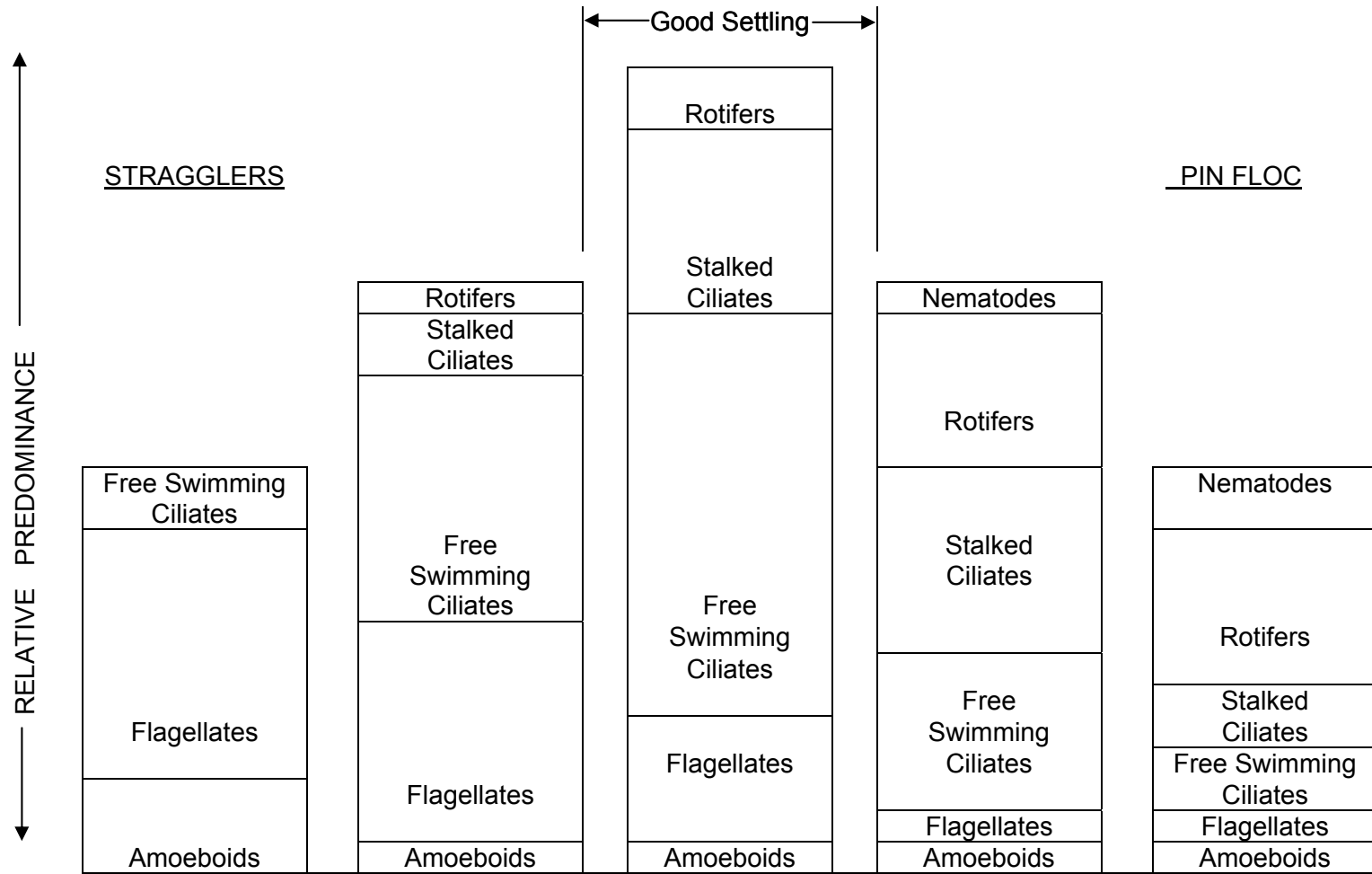

RELATIVE NUMBER OF MICROORGANISMS VS. SLUDGE QUALITY

## CLARIFIERS

## VII. Clarifiers

### Purpose and principle

Clarifiers may be referred to as sedimentation basins or settling tanks. All three terms describe the function of clarifiers, to provide a quiescent area which will result in the separation of settleable solids from the wastewater flow.

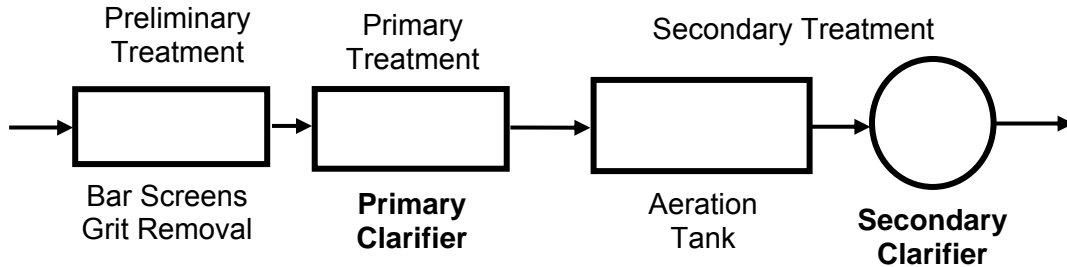

**Primary clarifiers** may be used following preliminary treatment to separate the heavy organic solids from wastewater before the flow continues to the secondary (activated sludge) process. Design detention time is typically about 2 hours. Primary clarifiers remove a large part (up to about 40%) of the solids and BOD load which would otherwise have to be treated in the secondary process, allowing smaller secondary process design and improved efficiency. Primary clarification is typically not used in extended aeration activated sludge systems, since the secondary treatment system in these facilities is much larger than in conventional activated sludge plants.

Solids that accumulate in the primary clarifiers are commonly referred to as primary sludge or raw sludge. This sludge is usually not pumped from the clarifier continuously, but is pumped on a periodic basis, typically once or twice per shift. Since there is little dissolved oxygen in this part of the process and the sludge is unstable, primary sludge must be frequently removed from the clarifier to prevent anaerobic decomposition. Sludge that is not removed often enough may cause excessive odors and floating sludge as gasses (carbon dioxide and methane) are released from the decomposing organics.

Floatable material such as oil and grease is skimmed from the surface of the clarifier. In many facilities this is pumped directly to the solids handling process, while some plants have a separate system for concentrating the waste before disposal.

Primary clarifier effluent will contain the particulates which are not readily settleable as well as all of the dissolved solids in the influent wastewater. This flow then passes on to the secondary portion of the treatment process.

**Secondary clarifiers** follow a secondary biological treatment process. In the activated sludge process secondary clarifiers separate the biomass (mixed liquor) from the flow, concentrating it in the bottom of the clarifier. These solids are then pumped from the bottom of the clarifier back to the head of the aeration tank as return sludge.

Although secondary sludge is usually more stable than primary sludge, it is important to keep the sludge blanket level under control. Secondary sludge is typically lighter than primary sludge and may be carried out of the clarifier if the sludge blanket level gets too

high. Secondary sludge is also susceptible to filamentous bulking and to floating sludge due to denitrification.

The sludge blanket in the secondary clarifier should be maintained in the range of 1 to 2 feet thick. This will provide enough clear water on top of the sludge to avoid losing solids from the clarifier. Keeping some sludge in the clarifier allows the solids to concentrate so that fewer gallons of material must be wasted and return sludge flows may be lower.

**General Clarifier Considerations**

Clarifiers, in general, are designed around **Stoke’s Law**. This mathematical model relates the factors which determine the settling rate of particles in water.

$$VF = \frac{2(p - p_o)g}{9n} (d/2)^2$$

|                            |  |
|----------------------------|--|
| <b>VF</b>                  | <b>Fall Velocity</b>                                     |
| <b>(p - p<sub>o</sub>)</b> | <b>Density difference between the particle and water</b> |
| <b>n</b>                   | <b>viscosity of water</b>                                |
| <b>g</b>                   | <b>gravitational acceleration constant</b>               |
| <b>d</b>                   | <b>diameter of the particle</b>                          |

Stoke’s Law indicates that the vertical drop (settling rate) of particles in water is directly related to the difference in density between the particles and water and the size of the particle. The settling rate is inversely related to the viscosity of water. So as the density and size of the particle increase the settling rate increases. As the density and viscosity of water increase the settling rate decreases.

The temperature of the water in the clarifier is related to both the density, and to a less extent, the viscosity of water. As the temperature of water drops its density increases (until 4°C). This means that as water becomes colder, its density becomes closer to the density of the particles that are trying to settle, and the settling rate decreases.

The efficiency of the clarifier in removing solids is also related to the physical aspects of the clarifier. Generally, as surface area increases the more efficient the clarifier. Depth must be adequate to prevent scouring solids from the sludge blanket into the effluent. The size of the clarifier as it relates to the quantity of flow through it (hydraulic loading), the size of the clarifier as it relates to the quantity of solids (solids loading), the shape of the clarifier, influent/effluent design, the solids removal mechanism, and operation and maintenance of the clarifier all affect efficiency.

Flow characteristics in the clarifier are a big factor in determining its ability to settle solids. The flow must be dispersed as evenly as possible throughout the clarifier so that solids are not carried out by areas of high flow velocity. **Short circuiting** in clarifiers may be defined as a situation in which the flow in part of the clarifier is higher than in the rest of the clarifier. This condition may be caused by several factors including:

- Missing or poor influent baffling
- Uneven effluent weirs
- Plant growths or accumulations of trash in the effluent weirs

- Temperature stratification due to very cold or very warm influent wastewater

### Types of Clarifiers

While there are many differences among the various manufacturers of clarifiers, they can be generally grouped into rectangular, circular, or inclined plate.

**Inclined plate** (Lamella) clarifiers have increased surface area available for settling due to a series of plates (or in some cases tubes) inclined in the clarifier. This type of clarifier works well for many industrial applications, but has limited use in biological treatment plants. Slime growths accumulate on the plates causing short circuiting and plugging and become very maintenance intensive.

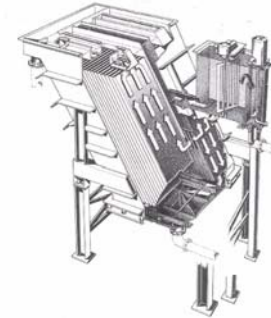

**Rectangular clarifiers** are often used as primary clarifiers in activated sludge plants, and are sometimes used as secondary clarifiers.

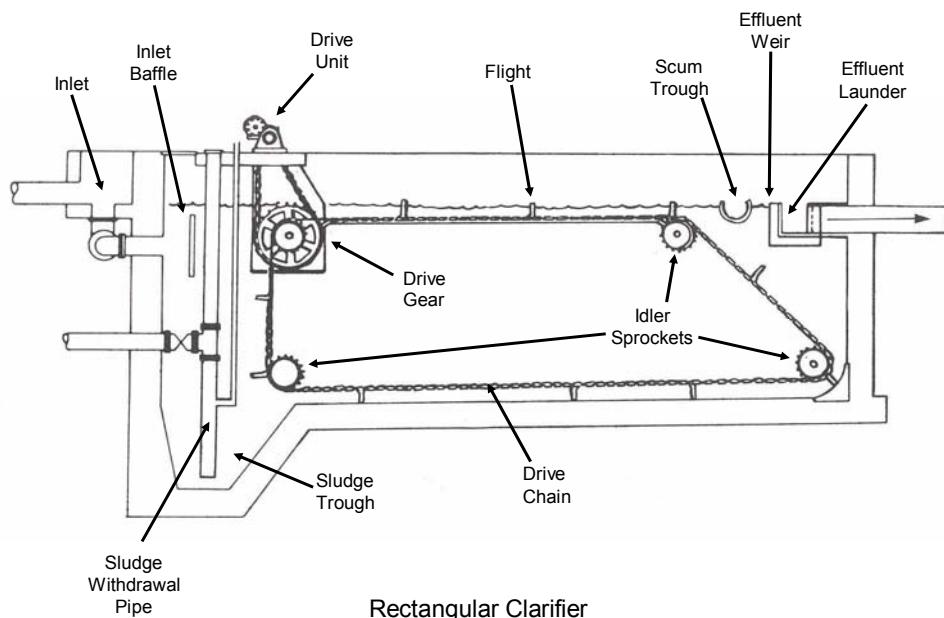

Influent wastewater is dispersed throughout the tank by an inlet baffle. This baffle may be a vertical plate, an inlet "T", or a series of gate valves. As the flow passes through the tank solids settle to the bottom and the clarified water flows over an effluent weir and into the discharge launder.

Solids that settle to the bottom are scraped into a sludge hopper at the influent end of the clarifier by a set of wooden or fiberglass flights. These flights are nearly as long as the clarifier is wide and are attached to a steel or plastic chain driven by an electric motor and sprocket. In most plants where rectangular clarifiers are used as primary treatment the flights do not run continuously, but are turned on an hour or so before sludge pumping begins and are shut off when pumping is completed.



As the flights are drawn along the surface of the clarifier they move floating material toward a scum removal trough. This is generally a manually operated pipe which is slotted. As the operator turns the slot into the water the surface is skimmed and scum is discharged to solids handling or scum handling processes.

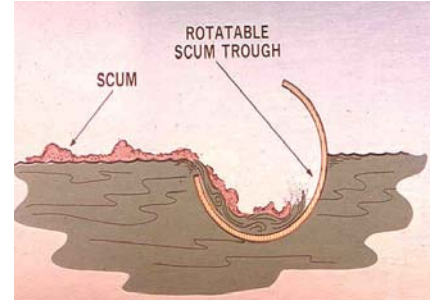

Effluent weirs are usually of the “V notched” or “saw toothed” design. This helps to keep flow velocity constant as the flow rate over the weir increases. It also tends to clear particles which tend to become trapped behind the weir.



In a rectangular clarifier there may be one weir or several weirs. In general, as the number of linear feet of weir increases, the more efficient the clarifier will be. The weirs may be straight, or may be serpentine (S-shaped). Serpentine weirs increase the overall length of weir in the clarifier.

**Circular Clarifiers** are used mainly as secondary clarifiers, but may be used as primary clarifiers.

In the most common circular clarifier configuration, influent enters in the center of the

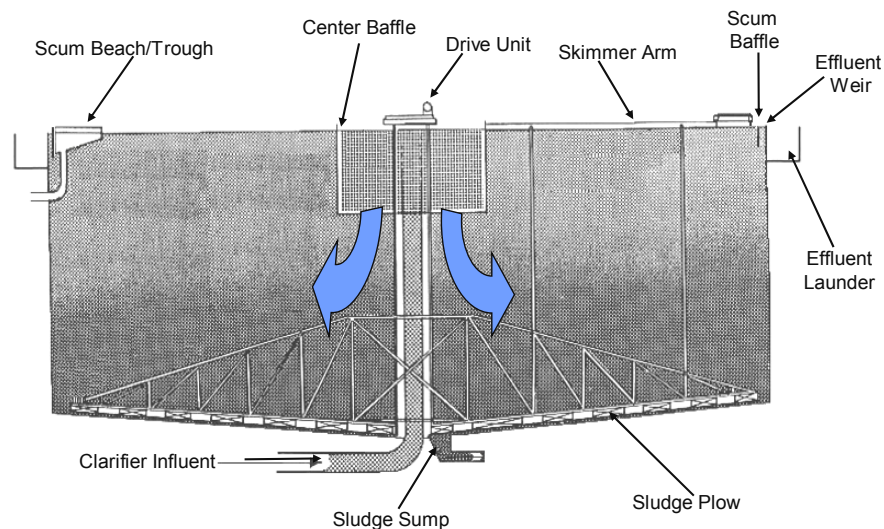

Circular Clarifier

tank into the center well. A circular baffle prevents the solids from being carried by the flow directly to the effluent weir, directing them toward the floor of tank. Solids settle to the floor of the tank where they are scraped to a sludge sump in the center.

In activated sludge plants, the sludge is pumped continuously (return activated sludge) back to the influent end of the aeration tank. The sludge collection mechanism consists

of a rotating frame with plows attached to it. The plows are set at an angle so that as the sludge collector rotates the sludge is moved to the sludge sump. Adjustment of the clearance between the plows and the floor of the tank may be necessary periodically to prevent contact between the plows and the floor, and also to avoid leaving an excess of solids in the tank.

The mechanism which drives the sludge collection system also drives a skimmer at the surface of the clarifier. As the skimmer rotates, floating material is directed onto a scum beach and into the scum trough. Just before the skimmer arm reaches the scum beach an underwater lever is activated, allowing a flow of flushing water through the scum trough. The scum is then directed to the solids handling or scum handling process.

Around the perimeter of the tank, clarified water passes under a scum baffle and over the effluent weir into the discharge launder. The launder and weir may be attached directly to the outer wall of the clarifier (1), may be attached to the inner wall (2), or the launder and weirs may be suspended in the clarifier (3). As in primary clarifiers, V-notched weirs are generally used.

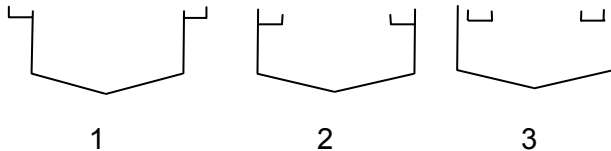
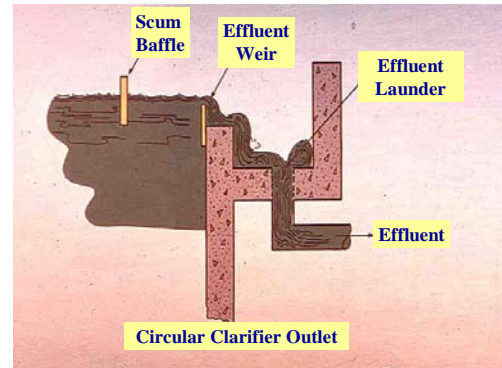

A problem that is commonly experienced with the design shown in diagram #2 above, is that the launder may contribute to a current in the tank which contributes to the loss of solids over the effluent weir. To minimize this some newer clarifier designs include a baffle which extends down from the inside corner of the launder at an angle. This directs the current back toward the center and bottom of the clarifier.

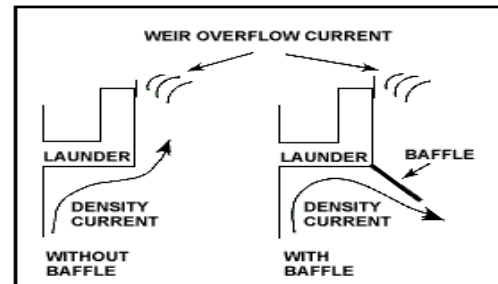

The design shown in diagram number three may also be prone to solids loss, especially between the outside edge of the launder and the clarifier wall. Careful consideration of the placement of the launder (not too close to the clarifier wall) and proper baffling is especially necessary when building this type of clarifier.

### Clarifier Variations

Through the years many alternative clarifier designs have been used, some successfully and some not so successfully. The following discussion lists a few of the more often used alternative designs.



One design which has seen some use in Michigan is a cross between the rectangular and circular clarifiers. It is a square clarifier with a circular sludge collection and skimming mechanism. This design is commonly referred to as the **Squirclarifier**. The advantage that this design might have over a rectangular clarifier is the effluent weir on all four sides of the square rather than on just one end.

It also has a surface area advantage over the circular clarifier.

One potential disadvantage of this design is that the sludge collection mechanism must be designed to collect the solids in the corners and along the sides of the square tank. The sludge collector has a section which flips out to plow the sludge in the tank corners, and then retracts back up into position after it has passed the corner. This has been a maintenance concern in some plants with these clarifiers.

Some clarifiers are designed as **Peripheral feed**, rather than center feed. The wastewater enters a baffled area around the perimeter and then passes through slots in the bottom of the baffle into the bottom of the clarifier. The sludge blanket in the clarifier is intended to filter fine particles out of the wastewater flow as it passes up through the blanket. The picture at the right shows a peripheral feed clarifier with radial discharge launders.



Radial Discharge

Peripheral Feed



Peripheral feed, center discharge



The peripheral feed, center discharge design shown above is used in several facilities in Michigan, and seems to be very successful. In this particular design, the baffle extends almost to the floor of the tank, with a continuous slot along the bottom. Wastewater passes through the slot, up into the clarifier, and travels to the discharge weirs at the center. Scum is collect between the baffle and the clarifier wall.

There are also variations in the way that sludge is removed from the clarifier. Rather than plowing the sludge to a sump in the center of the clarifier, in some designs the



sludge collection mechanism sucks the sludge into pipes which rotate along with triangular shaped sludge plows. The operator can control the sludge flow through each pipe by adjustment of the telescoping valves pictured above at the far right.



In a somewhat similar design, the clarifier pictured at the left, draws the sludge into a rotating horizontal tube. Sludge collection systems using the vacuum approach may have the sludge collector connected directly to a sludge pump, or may rely on hydraulic pressure to draw the sludge into the collector.

### Clarifier Operation

Good clarifier operation begins with routine inspection and maintenance. Drive mechanisms need to be lubricated and maintained as required by the manufacturer. At least a couple of times each shift clarifiers should be observed for proper operation. At least once each shift sludge depths should be determined in each clarifier.

In rectangular clarifiers the operator should watch for smooth operation of the sludge collection system. Erratic movement may indicate broken flights, worn chains or sprockets, or large debris in the tank. Floating sludge may indicate worn or broken components. Tripped breakers or sheared pins on the drive mechanism are also indications of excessive wear, improper alignment, or large debris jamming the equipment.

In circular clarifiers the operator should check to see that the skimmer/sludge collector operates smoothly. Also check to make sure that the scum trough is not plugged.

Solids tend to collect in the center baffle, along the weirs, and in the launder of circular clarifiers, requiring frequent cleaning. Algae and water weeds grow quickly in summer months when the water is warm and there is plenty of sunlight. Cleaning can be accomplished in several ways, but most often involves an operator with a broom. Care must be taken to not get into a situation where safety is compromised. Hosing the slime growths off is probably safer and faster but may not be as effective.

Some facilities have installed hoses and nozzles along the weir and launder through which they spray chlorinated water to control slime growths. This may be effective, but care must be taken to avoid causing a chlorine residual in the effluent that exceeds the limit in the discharge permit.

Some facilities have installed brushes on the skimmer arms of circular clarifier. As the skimmer arm rotates, the brushes clean the weir and launder. This has proven to be effective and certainly much easier than manually cleaning the clarifier. Usually the brushes are spring loaded, and can be disengaged so that the operator can control whether or not they contact the clarifier surfaces, minimizing wear on the brushes. These systems are commercially available, but some facilities have designed and installed their own cleaning brushes.



A few facilities have installed covers over the clarifier weirs and launders. This blocks the sunlight and limits plant growth. This is a fairly simple and effective method, but it does limit access when the need for cleaning or maintenance arises.

Many plants have installed aluminum or fiberglass covers on the secondary clarifiers. These also help to minimize algae by minimizing light. The covers allow easy access to the clarifiers and provide a much more comfortable working situation when working on the clarifier in cold weather.



### **Clarifier Loading**

Clarifiers, like most wastewater treatment processes, are designed to treat a given amount of wastewater. Flows in excess of that design value will result in loss of efficiency and solids in the clarifier effluent. Clarifier loading may be expressed in terms of hydraulic or solids loading. Hydraulic loading refers to the number of gallons going into the clarifier as it relates to the size of the clarifier.

**Detention time** is an expression of hydraulic loading, indicating how long it will take the water to pass from clarifier influent to effluent. This is typically expressed in hours, with a design value usually between 2 and 3 hours.

$$\text{DT, hrs} = \frac{\text{Tank Volume, MG} \times 24}{\text{Flow into Tank, MGD}}$$

Be careful to make sure that the tank volume units and flow units match; if volume is given in millions of gallons use units of million gallons per day for the flow. If the volume is given in gallons, use gallons per day as the flow. The “24” in the equation converts from units of “day” to units of “hours”.

**Surface Overflow Rate (SOR)**, a very commonly used expression of hydraulic loading relates the number of gallons per day of water overflowing the clarifier, to its surface area in square feet. Design values for average flow conditions are usually in the range of 400 to 800 gallons per day per square foot.

$$\text{SOR, gpd/ft}^2 = \frac{\text{Flow, gallons/day}}{\text{Surface Area, ft}^2}$$

**Weir Overflow Rate (WOR)** is also often used to express hydraulic loading. WOR relates the number of gallons per day overflowing the clarifier weirs to the number of linear feet of weir. The design value for WOR is typically in the range of 10,000 gallons per day per foot of weir.

$$\text{WOR, gal/d/ft} = \frac{\text{Flow, gallons/day}}{\text{Length of Weir, ft}}$$

**Solids Loading Rate (SLR)** relates the number of pounds of solids per day entering the clarifier to its surface area in square feet. The design value for SLR is usually about 25 to 30 pounds per day per square foot.

$$\text{SLR, lbs/d/ft}^2 = \frac{\text{Solids, lbs/day}}{\text{Surface Area, ft}^2}$$

By becoming familiar with these clarifier loading calculations, the operator may be able to troubleshoot settling problems. If clarifier effluent suspended solids are excessive, a settleability test on the solids will help to determine whether they should have settled in the clarifier. If the solids settle in a settleometer but not in the clarifier, determination of hydraulic and solids loading on the clarifier may help to explain the problem.



## VIII. Nitrogen

### The Nitrogen Cycle

Nitrogen may be a concern for environmental reasons as well as for public health reasons, depending on the form or compound that the nitrogen is in. For instance, **ammonia (NH<sub>3</sub>)** is often limited in discharge permits due to its toxicity to aquatic organisms, and because it causes an oxygen demand in water. Ammonia, **nitrite (NO<sub>2</sub><sup>-</sup>)** and **nitrate (NO<sub>3</sub><sup>-</sup>)** are fertilizers, increasing the growth rate of weeds in rivers and lakes. Nitrite and nitrate are limited in discharges to groundwater because of they interfere with the respiration process in infants, causing a condition known as “blue baby syndrome” or methemoglobinemia. Nitrite is a concern in the operation of wastewater treatment plants in which chlorine is used as a disinfectant in that the nitrite causes a large chlorine demand.

Nitrogen exists in many forms which transform continually in the environment and in wastewater treatment plants. The Nitrogen Cycle diagram below illustrates these forms and the various transformations that occur. Understanding the nitrogen cycle will be important for wastewater treatment plant operators, especially when working with facilities where nitrification and/or denitrification are required.

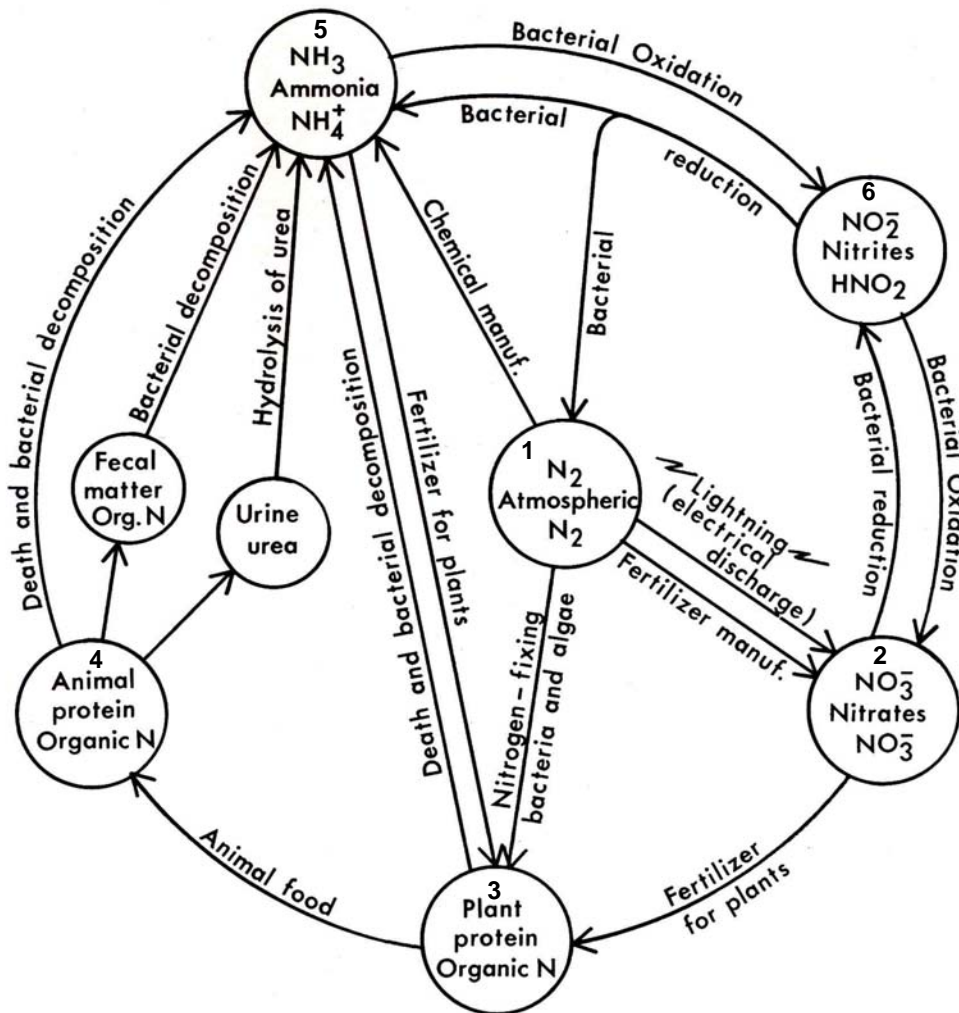



Starting at the center-right of the diagram (1), atmospheric nitrogen makes up about 79% of the air that we breathe. Lightning oxidizes this nitrogen gas to nitrate which becomes fertilizer for plants. Fertilizer manufacturers also convert nitrogen gas to nitrate (2) and to ammonia (5). Nitrate and ammonia in water and soil are used by plants as fertilizer, and some plants take up (fix) nitrogen directly from the air (3). As plants take up nitrogen and as animals consume plants (4), nitrogen becomes an essential component of every cell of every living plant and animal; it is one of the key elements required for survival, being used to build proteins and other complex organic molecules. When plants die, bacterial decomposition of these organic nitrogen compounds releases nitrogen in the forms of ammonia gas ( $\text{NH}_3$ ) and ammonium dissolved in water as an ion ( $\text{NH}_4^+$ ) (5). As animals metabolize food, and when the animal dies and decomposes, byproducts also decompose to release ammonia. From the diagram this far, atmospheric nitrogen has become part of plants and animals to form organic nitrogen compounds. When these compounds decompose ammonia is released. It is obvious that the influent to every wastewater treatment plant treating domestic wastes will contain nitrogen in two main forms, organic nitrogen and ammonia/ammonium. The sum of organic nitrogen and ammonia nitrogen is analytically termed **Total Kjeldahl Nitrogen (TKN)**. This is an important term, since it is a measurement of the nitrogen in wastewater that will be available to the biomass.

Continuing around the diagram in a clockwise direction from  $\text{NH}_3$ , some types of bacteria (autotrophic bacteria) are able to oxidize ammonia first to  $\text{NO}_2$  (6) and then to  $\text{NO}_3$  (2); this is the process of **nitrification**. Also notice that this process can be reversed, with  $\text{NO}_3$  being reduced back to  $\text{NO}_2$  (6) and then to  $\text{N}_2$  (1); this is the process of **denitrification**. At this point the cycle has been completed; nitrogen gas originating in the atmosphere has been returned to the atmosphere.

### Nitrification

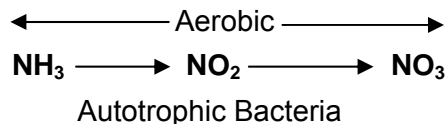

The nitrification process is important in wastewater treatment due to the concern for ammonia toxicity and nitrogenous oxygen demand in effluents. It is not unusual for National Pollutant Discharge Elimination System (NPDES) permits for facilities discharging to surface water to limit the concentration of ammonia in the effluent. Depending on several factors, the limit may be less than 1 mg/L. With a typical influent ammonia concentration of 15 – 20 mg/L, the facility must be capable of nitrification, converting nearly all of the ammonia to nitrate before discharge. Nitrate is not generally regulated in surface water discharges since it is not considered toxic and exerts no oxygen demand.

Keep in mind that as organic pollutants are broken down by heterotrophic bacteria in the activated sludge biomass, nitrogen is released in the form of ammonia. At the same time the biomass is growing and taking up nitrogen; although the biomass typically does not remove enough nitrogen to meet discharge permit limits for ammonia, biomass uptake does account for a significant amount of nitrogen removal.

Nitrification is also a biological process, but involves autotrophic bacteria. These bacteria are able to utilize inorganic compounds (like ammonia) as an energy source, using carbon dioxide (or bicarbonate) as a carbon source to build cells.

Two types of autotrophic bacteria are involved in the nitrification process: Nitrosomonas oxidize ammonia (released by heterotrophic bacteria) to nitrite, and then Nitrobacter oxidize nitrite to nitrate.

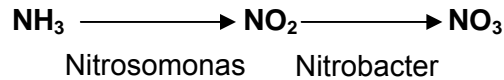

In facilities where nitrification is required to reduce the concentration of ammonia in the effluent, the objective is to provide conditions in the activated sludge system which will encourage the accumulation of these autotrophic bacteria. In some plants this occurs almost automatically due to system design (extended aeration), while it may be more of a challenge at others.

Several factors must be considered to trying to achieve nitrification in an activated sludge plant:

1. As indicated in the equation, nitrification is an oxygen consuming process, requiring about 4.6 milligrams of oxygen for each milligram of ammonia oxidized to nitrate. Nearly twice as much oxygen is required to nitrify as to remove CBOD. Dissolved oxygen must be maintained at a higher concentration than for just CBOD removal. Although nitrification may begin at D.O. as low as 0.5 mg/L, typically D.O. in the aeration tank should be increased to 3 – 5 mg/L to assure efficient nitrification.
2. Nitrifying organisms do not compete well with heterotrophic bacteria and are inhibited by soluble carbonaceous BOD. Detention time in the aeration tank must be long enough (> 5 hours) to achieve nearly complete removal of CBOD before the nitrification process can begin. Nitrification is best at low organic loading and low F:M (< 0.25).

In-plant return flows, such as from solids handling processes are usually high in soluble BOD and ammonia and can cause loss of nitrification or exceed nitrification capability if not carefully controlled. It is important that these high-strength wastes are returned through the plant slowly, in low quantity, and at times when loading on the system is at its lowest.

3. Nitrifiers grow more slowly than heterotrophic bacteria. Nitrification may begin at a CRT of 4 or 5 days, but is best if over 8 days.
4. Temperature is an important factor in the nitrification process. As wastewater temperature decreases, nitrifier growth rate decreases, resulting in reduced nitrification. Below a wastewater temperature of 50 °F nitrification becomes very difficult, requiring long detention time and high CRT. If the nitrification process becomes upset in cold weather, recovery may be nearly impossible until wastewater temperatures rise. Low temperature especially impacts the nitrobacter; this may result in an accumulation of nitrite, causing a disinfection problem if using chlorine.

Higher MLSS concentrations may help to compensate for cold weather nitrification problems, but this approach is limited by the amount of biomass that can be maintained in the system. Oxygen transfer must be adequate to support the quantity of biomass in the system, the secondary clarifier must be capable of settling all of the biomass, and high CRT problems (slurp, straggler floc) may result.

5. Autotrophic bacteria are pH sensitive, with best nitrification occurring between pH 8.0 – 8.5. The nitrification process consumes alkalinity according to the following formula:



This indicates that ammonium bicarbonate (bicarbonate alkalinity) is being used up, and that nitric acid, water, and carbon dioxide are being produced. Recall that the alkalinity of a solution provides buffering capacity (resistance to change in pH). In the nitrification process buffering capacity is being consumed, and nitric acid is being produced. If enough alkalinity is consumed and enough nitric acid is produced the pH of the solution will drop, inhibiting the autotrophic bacteria and the nitrification process.

For every pound of  $\text{NH}_3$  Oxidized, 7 pounds of alkalinity are destroyed. And there may be additional reactions occurring that consume alkalinity; chemicals added for phosphorus removal also destroy alkalinity:

5.3 - 13.5 lbs Alkalinity per lb Fe Added

6.0 - 9.0 lbs Alkalinity per lb Al Added

Wastewater and sludge that is allowed to become septic in the collection system, primary clarifiers, sludge thickeners, or other solids handling processes also generate acid which consumes alkalinity. All of these factors should be considered when troubleshooting nitrification problems.

Reduction of pH due to insufficient alkalinity is not typically a problem in activated sludge plants treating domestic wastes, especially where groundwater is used as the drinking water source. Domestic wastewater generally does not contain an excessive amount of ammonia, and groundwater is typically fairly hard, containing sufficient alkalinity to nitrify without a depression of the pH. This may be more of a concern in situations where the influent ammonia concentration is high and surface water or softened water is used as a drinking water supply.

In general, if the influent total alkalinity is at least 150 mg/L there is sufficient alkalinity for nitrification of ammonia in domestic wastewater treatment. If total alkalinity of the effluent is at least 50 mg/L pH depression should not occur. If low alkalinity is found to be the cause of nitrification problems, sodium bicarbonate, sodium hydroxide, or lime may be added to the aeration tank to increase pH and add buffering capacity.

One reason for continued success of extended aeration activated sludge systems such as sequencing batch reactors and oxidation ditches is that they are designed with long detention time in the aerator (24 hours), high CRT (20 days), and low F:M (0.05 – 0.15). These conditions nearly assure nitrification to very low levels of effluent ammonia, given

sufficient alkalinity, high enough wastewater temperature, and careful operator attention when returning flows from solids handling processes back into the wastewater stream.

**Denitrification**

Denitrification is the reduction of nitrate to nitrite, and then to nitrogen gas by heterotrophic (BOD consuming) bacteria.

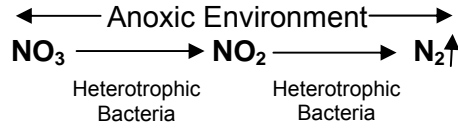

As indicated by the equation above, in an anoxic environment (no dissolved oxygen, but nitrate is present) heterotrophic bacteria are able to use oxygen from nitrate and nitrite, releasing nitrogen gas.

Nitrogen gas released during denitrification sometimes presents an operational problem in wwtp's that are nitrifying. As mixed liquor enters the secondary clarifier, the solids settle to the bottom. If the solids remain in the clarifier too long the D.O. may begin to drop, creating an anoxic condition. Nitrate becomes denitrified, releasing nitrogen gas in the form of very small bubbles which rise to the surface of the clarifier, bringing some of the settled biomass with it. This may result in globs of biomass floating on the surface, or it may result in a substantial amount of the sludge mass rising to the surface. If this problem is suspected the operator should watch for nitrogen gas bubbles when performing a settleability test. If bubbles are observed or if the biomass floats to the top of the settleometer within a 1 hour settling time, care must be taken to keep the sludge blanket in the secondary clarifier at minimal levels. Return sludge rates should be adjusted to assure that the biomass does not remain in the clarifier long enough for denitrification to occur.

Denitrification is required where nitrate or nitrite in the discharge is a concern. In situations in which the wastewater treatment plant discharges effluent into groundwater, a groundwater discharge permit is required. This permit usually limits the Total Inorganic Nitrogen (TIN) ( $\text{NH}_3\text{-N} + \text{NO}_2\text{-N} + \text{NO}_3\text{-N}$ ) in the discharge to 5 mg/L. The facility must be capable of first nitrifying the ammonia to nitrate, and then denitrifying the nitrate to nitrogen gas.

The diagram below illustrates a typical flow schematic for a WWTP that is designed for denitrification. BOD is reduced, and ammonia is nitrified to nitrate as the wastewater passes through the first aerobic (oxic) reactor. The mixed liquor then flows into an anoxic (zero D.O.) environment and is supplied with a food source. As bacteria in the

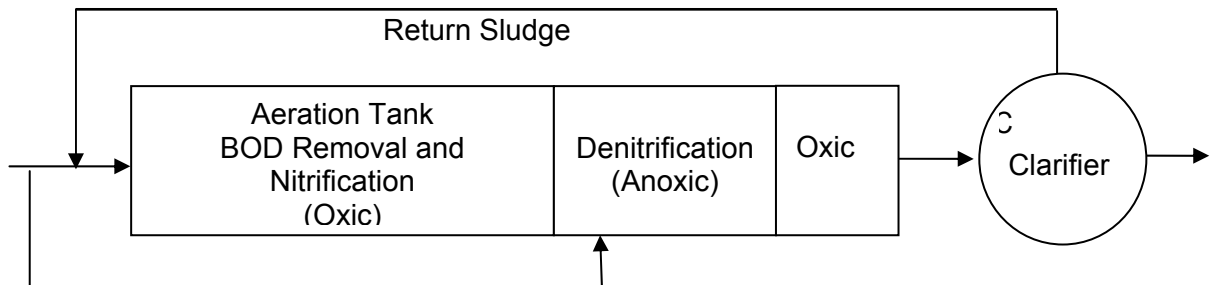

mixed liquor metabolize the BOD in the absence of D.O., they utilize the oxygen from the nitrate molecule, releasing nitrogen into the atmosphere. To prevent these nitrogen gas bubbles from causing a rising sludge problem in the secondary clarifier, the mixed liquor flows from the anoxic zone into another aerobic zone where the nitrogen as is stripped from the mixed liquor by the air bubbling through it.

Denitrification is also required in nitrifying facilities which remove phosphorus biologically. Nitrate is a source of oxygen and would interfere with the ability to attain the anaerobic condition necessary in this process.

Other modifications of the activated sludge process that are usually designed to nitrify and denitrify include the Sequencing Batch Reactor and the Concentric Ring Oxidation Ditch.

Probably the most often encountered problem when trying to achieve denitrification is that of controlling dissolved oxygen. When wastewater treatment plants are newly constructed the organic load is usually lower than design and aeration capability greatly exceeds demand. This results in an excess of D.O. in the aerobic stage that impairs the ability to achieve anoxic conditions where necessary. The effluent contains low ammonia but high nitrate, which does not meet the 5 mg/L TIN groundwater discharge permit limit. Designers and operators must assure flexibility in facility design that will allow very close control of organic loading (number and size of reactors) and D.O. control (number and size of aeration blowers) where denitrification is required.

There are benefits to denitrification in addition to discharge permit compliance. Zero D.O. conditions may help to control the growth of filamentous bacteria, denitrification recovers oxygen by forcing the bacteria to utilize oxygen that was required in the nitrification process, and denitrification recovers alkalinity that was consumed in the nitrification process.

**3.57 mg Alkalinity (OH<sup>-</sup>) Produced per mg NO<sub>3</sub> Reduced**



**Nitrite and Disinfection Problems**

Nitrite (NO<sub>2</sub><sup>-</sup>) can cause disinfection problems in wastewater treatment plants that use chlorine. This is due to the fact that nitrite is unstable, and is easily oxidized to nitrate (NO<sub>3</sub><sup>-</sup>) by the chlorine. Nitrite is sometimes referred to as a chlorine “sponge” because of its affinity for chlorine. The chlorine reacts with nitrite instead of disinfecting, leaving the plant with increased fecal coliform in the effluent.

WWTP’s that typically nitrify most often experience this during the months of February and March. WWTP’s that do not typically nitrify may see this problem later in the Spring and in early Winter.

When chlorine is added to water, hydrogen chloride and hypochlorous acid are formed (equation 1). Hypochlorous acid ionizes to hydrogen ion and hypochlorite ion (equation 2). The hypochlorite ion ( $\text{OCl}^-$ ) is a strong oxidizer and will react with nitrite to form nitrate and chloride (equation 3).

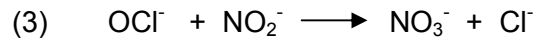
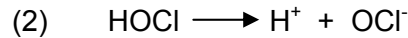
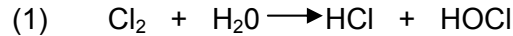

Since chloride has no disinfecting properties, disinfection will be impaired. The amount of chlorine consumption by nitrite may be estimated as 5 milligrams of chlorine per milligram of nitrite.

### Cold Water $\text{NO}_2$ Problem

At wastewater temperatures above  $63^\circ\text{F}$  ( $17^\circ\text{C}$ ) the conversion of ammonia to nitrite is the slowest step in the nitrification process, with the conversion of nitrite to nitrate occurring rapidly. This results in low concentrations of ammonia, low concentrations of nitrite ( $< 1 - 2 \text{ mg/L NO}_2$ ), and high concentrations of nitrate in the effluent.

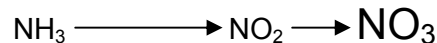

When wastewater temperatures drop to between  $54$  and  $57^\circ\text{F}$  ( $12$  and  $14^\circ\text{C}$ ) the first reaction step becomes the fastest. Ammonia is oxidized to nitrite, but the conversion of nitrite to nitrate takes longer.

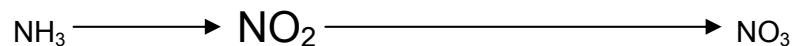

This causes an accumulation of nitrite ( $\text{NO}_2$  can reach  $15 \text{ mg/L}$ ) in the effluent. With each milligram of nitrite using up 5 milligrams of chlorine, it may be nearly impossible to supply enough chlorine to disinfect the flow.

### Warm Water $\text{NO}_2$ Problem

Nitrite consumption of chlorine is not only a cold weather problem, but may also occur in wastewater treatment plants that are nitrifying in warm water. In the process of denitrification, nitrates are biologically reduced first to nitrite and then to nitrogen gas which is released into the air. Denitrification occurs in an anoxic (low D.O.) environment and requires that a food source be present for the heterotrophic bacteria. In the absence of D.O. and with a food source present, the bacteria utilize nitrate oxygen as they metabolize food, releasing nitrogen gas.

The reduction of nitrate to nitrite occurs quickly, while the reduction of nitrite to nitrogen gas is a slower process.

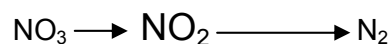

If a food source is present both steps occur rapidly enough that nitrite accumulation is minimal. If a food source is not available during denitrification, the second step takes

place so slowly that nitrites accumulate and chlorine intended for disinfection is consumed in oxidizing the nitrite back to nitrate.

Facilities that do not intentionally denitrify must be careful to keep the entire system aerobic, and to be sure that return sludge rates are sufficient to prevent denitrification of the secondary sludge in the clarifier. Facilities that intentionally denitrify should try to assure that the organisms have a sufficient supply of BOD in the denitrifying part of the process.

**Toxicity and the NO<sub>2</sub> Problem**

Nitrifiers are usually more affected by toxic wastes than other types of bacteria. Toxicity may result in the over-all loss of nitrification, with increased ammonia in the effluent. Some toxins affect the Nitrobacter more than the Nitrosomonas. This means that the conversion of ammonia to nitrite may occur, while the conversion of nitrite to nitrate may be inhibited, with a corresponding accumulation of nitrite in the effluent. Fuels such as kerosene, jet fuel, gasoline, and diesel oil are some of the materials known to be toxic to Nitrobacter.

**Effect of Ammonia on the NO<sub>2</sub> Problem**

When chlorine is dissolved in water that does not contain ammonia, the chlorine reacts as “free chlorine”. While this provides disinfection, free chlorine also reacts very quickly with nitrite to oxidize it to nitrate. So in wastewater treatment plants that are very low in effluent ammonia but there is an accumulation of nitrite, disinfection problems are very likely to occur.

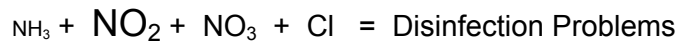

If NH<sub>3</sub> is present, free chlorine reacts with the ammonia to form chloramines.

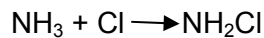

While not as strong a disinfectant as free chlorine, chloramines (such as monochloramine, NH<sub>2</sub>Cl) are more stable in water and do not react quickly with the nitrite. This allows disinfection to continue even in the presence of nitrite.

# PHOSPHORUS



## IX. Phosphorus

### Importance of Controlling Phosphorus

Phosphorus (P) is regulated in wastewater discharged to surface water due to its properties as a fertilizer. Like nitrogen, phosphorus is taken up by living organisms approximately according to the 100C:5N:1P ratio. It is one of the essential nutrients needed to build cells and sustain life. Plants do not grow where there is not an adequate supply of P. This is true in agriculture where P is added to soil to encourage the growth of crops, but is also true in aquatic systems where limiting plant growth is desired.

Plant growth in lakes is related to the state of **eutrophication** of the lake. Lakes that are cold and deep, with minimal plant growth and very low nutrient concentration are classified as **Oligotrophic** (oligo = few, trophic = nutrient). Lakes that are in a changing state with regard to nutrient load are classified as Mesotrophic (meso = middle), while lakes that are shallow, warm, and receive high nutrient loading are classified as Eutrophic (eu = well, eutrophication = well nourished).



Controlling the eutrophication rate of lakes involves controlling plant growth rate. This can be accomplished by controlling the nutrient load into the lake. While nitrogen and phosphorus are both nutrients needed by plants, nitrogen is too available naturally to be used as a practical control method. Phosphorus on the other hand, is only available to lakes as minerals containing phosphorus dissolve, or as fertilizers are discharged to the lake from point source discharges such as wastewater treatment plants or from non-point sources such as agricultural run-off. Controlling phosphorus loading into lakes is a practical method of limiting the growth rate of plants and the rate of eutrophication.

Phosphorus limits in Michigan have been established for most surface water dischargers at 1.0 mg/L. However, this permit limit is determined by the quantity of flow to be discharged, the characteristics of the receiving water, and current nutrient loading. In addition to a concentration limit, many facilities are also limited as to the number of pounds of phosphorus that can be discharged over a period of time. As the population grows and development continues, phosphorus limits have become more restrictive in some areas. This is especially true in areas near lakes where rapid development has occurred and there are many sources of phosphorus contributing to the environment.

### Forms of Phosphorus in Wastewater

The influent concentration of Total P for most municipal wastewater treatment plants ranges from about 2.5 mg/L up to about 6 mg/L, depending largely on the amount of inflow / infiltration into the collection system and industrial contributions. Total P includes three common forms of P: **Organic-P**, **Poly (condensed) P**, and **Ortho-P**. All three forms would be expected to occur in municipal wastewater influent.

Organic-P includes P that is a part of organic compounds; food scraps and human and animal wastes contribute this form of P to the waste stream. Organic-P compounds may be soluble (dissolved) in the wastewater, but are often associated with particulate material. Poly-P is in the form of a long chain, consisting of many linked  $\text{PO}_4$  molecules. Poly-P is soluble, found in many detergents, and is often added to public drinking water

supplies to sequester (tie up) the iron which would otherwise cause scaling and staining problems. Ortho-P may be thought of as the  $\text{PO}_4$  molecule; often referred to as “simple phosphates”. This form of phosphorus is soluble, and is common in many detergents and cleaning agents, especially industrial cleaners. For instance, milk producers and other food processing facilities often use phosphoric acid ( $\text{H}_3\text{PO}_4$ ) solutions for cleaning, and may discharge high concentrations of Ortho-P.

### Phosphorus Removal – Sedimentation and Biomass Uptake

Since much of the Organic-P is associated with particulate material in raw wastewater, some P removal will occur when settleable solids are removed in the primary clarifier. Primary sedimentation may account for between 5 - 15% removal of the Total-P coming into the WWTP.

Phosphorus will also be taken up by the developing biomass in a biological WWTP in about the ratio of 100C:5N:1P. A facility with a primary clarifier followed by a trickling filter may remove 20 - 30% of the total influent P. A facility with a primary clarifier followed by activated sludge may remove 30 - 50% of the total influent P. While this is fairly substantial P removal, it is obvious that even 50% removal will not meet a 1 mg/L P permit limit given a typical influent P concentration of 5 mg/L. The WWTP with a P permit limit of 1 mg/L must usually include a process designed specifically for P removal.

### Phosphorus Removal – Chemical Precipitation

The most commonly used method of P removal is by precipitation with a metal salt. In this process a chemical is added which will combine with the P to form a particle which will settle. The chemical sludge is then removed along with other solids which settle in the clarifier.

The dosage point for the metal salt is important, considering the various forms of P in the influent. Metal salts most effectively remove Ortho-P. Since Organic-P and Poly-P are converted to Ortho-P as they pass through biological wastewater treatment systems, the most effective dosage point will be after this conversion has taken place. In the activated sludge process, the metal salt solution is usually added near the discharge end of the aeration tank or just before the secondary clarifier.

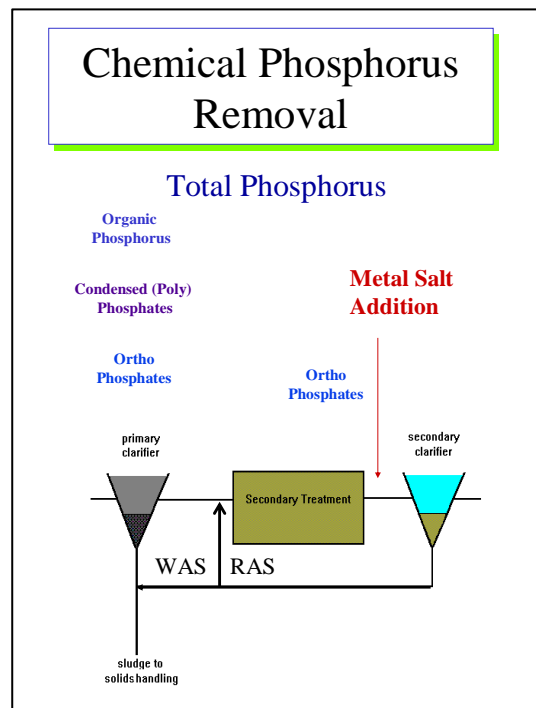

**Iron salt solutions** have been used to effectively remove P for many years. Iron may be added in its divalent state as **Ferrous Chloride ( $\text{FeCl}_2$ )**, or in its trivalent state as **Ferric Chloride ( $\text{FeCl}_3$ )**. Both solutions are acidic, corrosive, and stain everything that they contact with an orange color. Appropriate safety precautions must be observed.

$\text{FeCl}_2$  is purchased from suppliers who obtain this as a byproduct of steel pickling (it is sometimes referred to as “pickle liquor”), where hydrochloric acid solution is used to

clean steel parts before further processing. This solution is usually less expensive than other options, but care must be taken to assure that “tramp metals” which also dissolve into the acid during the pickling operation are not excessive. The operator should also make sure that the purchased solution has been filtered by the supplier to remove particulates which would otherwise form sludge in storage tanks, and cause plugging problems in solution feed pumps, pipes, and valves. Ferric Chloride ( $FeCl_3$ ) is typically a cleaner product with a higher percentage of iron in solution, but is more expensive. Book values for dosage are about 5.2 lbs  $FeCl_3$  per lb P.

**Aluminum salts solutions** are also often used for P removal in many facilities. The most commonly used salt is aluminum sulfate ( $Al_2(SO_4)_3 \cdot 14H_2O$ , referred to as alum. While still an acidic solution, this is not as hazardous as the iron salt solutions and does not stain. The main disadvantage with alum is that the dosage is about double that of iron salt solutions, and the cost may be higher. Book values for dosage are about 9.6 lbs Alum per lb P.

**Phosphorus Removal – Enhanced Biological Uptake**

During the late 1960’s and early 1970’s it was discovered that some activated sludge plants around the country removed more P than the 100C:5N:1P ratio indicated without chemical addition. Theories as to why this occurred centered on type of aeration and wastewater chemistry. Eventually it was found that in these plants the MLSS cycled from an anaerobic to an aerobic environment. This fairly simple concept is the basis for Enhanced Biological Phosphorus Removal in activated sludge plants.

Research has found that in situations where the MLSS cycles through anaerobic followed by aerobic conditions a type of bacteria (**Acinetobacter**) begins to accumulate in the biomass that uses P as an energy storage mechanism.

In the anaerobic reactor fermentation occurs as heterotrophic bacteria begin to break down organic material in the waste, releasing volatile acids (acetic acid) into the solution. These easily biodegraded organic acids become the food supply for the Acinetobacter. As these bacteria consume the organic acids they release P into the solution to produce energy needed for metabolism. The Ortho-P concentration in this reactor will be much higher than that of the influent P.

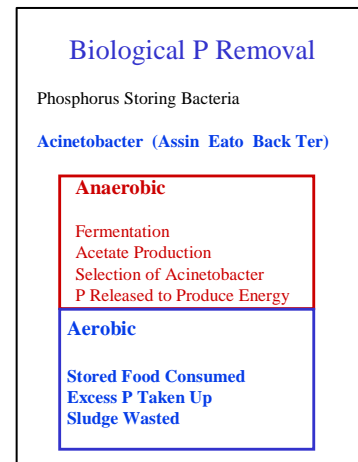

When the MLSS passes into the aerobic reactor the Acinetobacter consume stored food, and incorporate an excess amount of phosphorus into the biomass (often termed “Luxury Uptake”). Secondary sludge is wasted while the organisms are aerobic, thus removing P from the system.

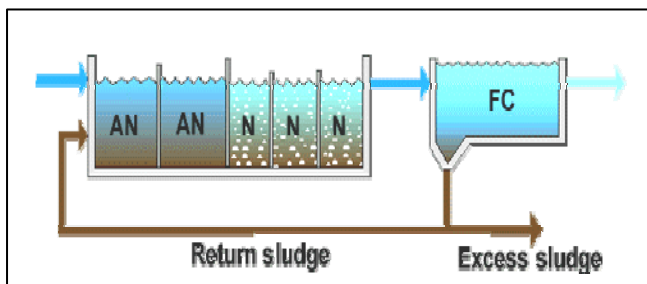

Many different designs have risen through the years in an effort to maximize the quantity of P removed by the biomass. The **A/O** (Anaerobic / Oxic) process was one of the earliest of the biological phosphorus removal processes. Though the A/O process had been

used successfully in the southern U.S., it was not known initially how the system would respond in colder climates. A demonstration project was initiated in 1984 in Pontiac, Michigan where one half of the East Boulevard Wastewater Treatment Plant was retrofitted to the A/O process. This project evaluated the effect of cold wastewater temperatures, the ability of the plant to nitrify while removing phosphorus biologically, and studied the effect of returning anaerobic digester supernatant to the process. The final report for the project published in 1991 indicated that the process was able to effectively remove phosphorus to less than 1 mg/L consistently, even in low temperature (40 – 50°F). It was also found that nitrification continued and that digester supernatant recycle was not detrimental to the A/O process.

Since the demonstration project was begun at Pontiac, many municipal facilities have been retrofitted to the A/O process in Michigan with good success, and some new facilities have been designed as A/O plants. It should be noted that in nearly all cases they are able to achieve permit limit concentrations for phosphorus almost always, but for as yet unexplained reasons, there are times in nearly every facility when biological P removal is not adequate and metal salts are added to remove the excess.

Other Bio-P removal processes have been used in Michigan besides A/O; the City of Adrian was retrofitted to the **Phostrip** process. A portion of the return sludge is diverted to an anaerobic stripper tank, and the released P is elutriated to a precipitation tank. Lime is then added to precipitate the phosphorus. After operating the Phostrip process for several years the City reverted back to conventional activated sludge with chemical phosphorus removal due to operational and mechanical difficulties.

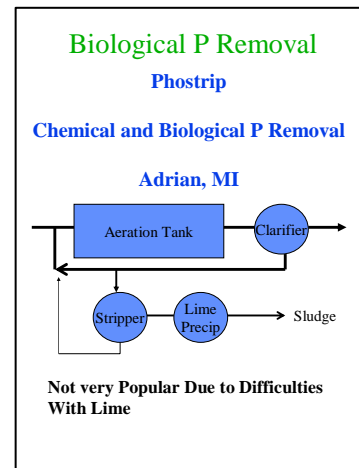

The **A<sup>2</sup>O** (Anaerobic, Anoxic, Oxidic) process is similar to

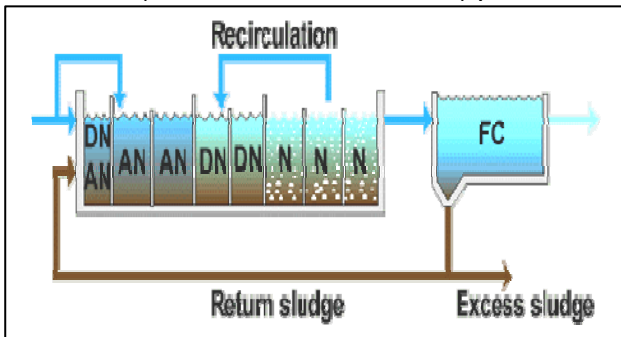

the A/O process, but an added process in the aeration tank recirculates nitrified mixed liquor into an anoxic zone where denitrification occurs. This minimizes the nitrate concentration that would otherwise be recirculated to the anaerobic zone, causing a potential interference.

The **Concentric Ring Oxidation Ditch** is a modification of the activated sludge process which also usually removes phosphorus biologically. The biological mechanism is the same as described earlier, but treatment is achieved using a different tank configuration. Designed as three aeration tanks in concentric rings, influent wastewater enters the first ring which is operated in an anaerobic condition. Mixed liquor then passes into the inner two rings, both typically being aerobic. As the mixed liquor passes through the anaerobic ring phosphorus release occurs, followed by phosphorus uptake in the inner two rings. Some of the aerobic bio-solids

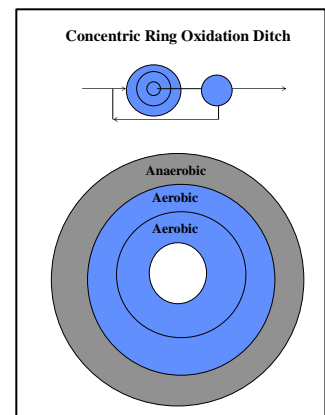

are then wasted, removing phosphorus from the waste stream.

Another activated sludge modification which typically removes phosphorus biologically is the **Sequencing Batch Reactor (SBR)**. This fill-and-draw system begins with an anaerobic Fill Phase during which phosphorus release occurs and is followed by an

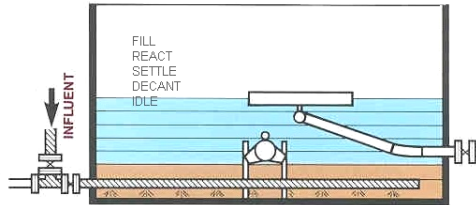

aerobic React Phase during which phosphorus is taken up by the biomass. During the Settle Phase the biomass settles

to the bottom, and clear water is drawn from the top of the reactor and discharged during the Decant Phase. Excess biomass is usually wasted during either the Decant or Idle Phase, which also removes phosphorus from the system.

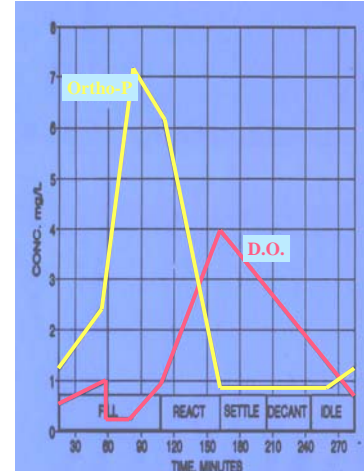

### Biological Phosphorus Removal Considerations

Regardless of facility configuration, there are some important considerations in trying to determine whether a particular waste stream or activated sludge facility should be able to remove phosphorus biologically.

- Bio-P removal is most effective where there is an **adequate influent BOD** concentration. Weak, diluted wastes may not supply enough oxygen demand to easily achieve the anaerobic environment needed. The amount of BOD needed is often expressed as a ratio of BOD to Phosphorus (BOD:P), with a ratio of about 15-20:1 usually being preferable.
- There must be an adequate amount of **anaerobic detention time**, without being so long as to promote reduction of sulfate to sulfide (septicity). Optimum anaerobic detention time depends to a large extent on the BOD:P ratio, but is generally in the 1-3 hour range.
- **Aerobic detention time** must be long enough to provide adequate BOD removal as well as nitrification if necessary. A typical minimum would be 4-5 hours.
- The facility must be capable of producing an **effluent Low in Suspended Solids** (Below 20 mg/L). Mixed liquor solids lost in the secondary effluent will contain much more phosphorus (about 8% by weight) than mixed liquor solids in a conventional activated sludge plant (about 2% by weight). It is possible for a Bio-P removal facility to be out of compliance with the discharge permit limit on phosphorus due to solids loss even though suspended solids are within the permit limit.
- **Nitrification** (nitrate) may interfere if provision is not made for denitrification. Nitrate becomes an oxygen source for bacteria when D.O. is not available, so cannot be allowed to enter the anaerobic zone.
- Supernatant from **solids handling** processes must be carefully controlled to avoid overloading the Bio-P removal system with phosphorus. Aerobic digesters

would be expected to release P into the supernatant if allowed to become anaerobic.

### **Benefits of Bio-P Removal**

As stated earlier, many activated sludge facilities in Michigan are being retrofitted to take advantages of the Bio-P removal process. These advantages include reduced need for chemical feed resulting in reduced amount of chemical sludge produced, lower cost, the process is safer, the possibility of tramp metal contamination of sludge is reduced, and cycling the biomass through alternating anaerobic / aerobic environments helps to inhibit the growth of filamentous bacteria.

### **Special Considerations of Bio-P Removal**

While the benefits outweigh the drawbacks of Bio-P removal, the operator must keep in mind that there are some special factors to consider with this process:

1. There will be periods of time when chemical addition will be needed to supplement Bio-P removal; a back-up chemical feed system will be required.
2. The D.O. environment needed for P release opposes that needed for nitrification. In facilities where effluent ammonia is regulated by permit the operator must be aware of the conditions needed for each process to occur and current conditions in the plant. In trying to resolve problems, keep in mind that nitrification can only take place biologically, whereas phosphorus removal can be achieved chemically if necessary.
3. Solids handling considerations and supernatant recycle are more critical.
4. Controlling the effluent solids concentration is more critical.
5. Laboratory and process control testing may be increased:
  - P in anaerobic and aerobic zones
  - D.O. in anaerobic and aerobic zones
6. When retrofitting a facility to the Bio-P removal process, determine whether the changes in question will require consideration of patent rights currently in effect.

## **TROUBLE SHOOTING**

## **IX. Troubleshooting**

### **Troubleshooting Tools**

Probably one of the most common temptations for the operator, when troubleshooting activated sludge problems, is to overlook obvious sources and solutions in favor of the strange and unusual. Although situations sometimes do arise that are difficult to determine and explain, the first approach should usually be to start with the most basic information about the problem. Look for in-plant operational or mechanical causes first, and then only if those can be eliminated, expand the search to the collection system and changes in influent wastewater characteristics.

Begin by characterizing the problem; excessive odor, mixed liquor settleability, high effluent BOD, Suspended Solids, Ammonia, TIN, P. Try to assure that information that is available is reliable. Occasionally, much effort is expended in tracking down a supposed problem only to discover that metering or laboratory data was not accurate. Don't assume that the laboratory data is faulty, but be sure that it is accurate.

Review operational records, starting with several months before the problem began. Watch for correlation of operational problems with control changes, operational functions such as digester supernating, or changes in chemical feed rates or solutions used. Look for trends in the data that indicate cyclic problems. These might be cycles that occur in the plant or in a contributor to the collection system.

Establish a log in which operators record general conditions in the plant and make note of conditions that seem unusual. Spend time learning what the plant looks, sounds, and smells like when operating well; this will help to make earlier and easier troubleshooting decisions when problems occur.

Make operational changes affecting the biomass gradually; biological systems need time to acclimate to changing conditions. Avoid the urge to make several changes at the same time.

The following troubleshooting outline may provide some direction in trying to resolve some of the more common activated sludge problems.



## Activated Sludge Troubleshooting Outline

### A. High Secondary Clarifier Sludge Blanket

Use the Settleometer Test and the microscope to help determine the cause of this condition. Calculate SVI or SDI to establish whether the problem is caused by poor compaction or just too much biomass in the system.

#### 1. High SVI, Low SDI

Microscopic Examination of MLSS - floc size, shape, structure, indicator organisms, filaments

Filamentous Bulking

##### a. Possible Causes:

- Low Dissolved Oxygen
- Low Organic Loading Rate  
(F:M < 0.05) (High CRT)
- High Organic Loading Rate
- Nutrient Deficiency (N or P)
- 100 parts C to 5 parts N to 1 part P
- Septic Wastes / Sulfides
- Low pH (< pH 6.0)
- High Carbohydrate Load (Sugars, Syrup, etc.)

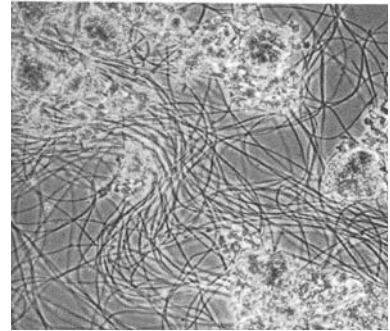

##### b. Possible Cures:

Long Term – Try to eliminate or control the cause of the problem

Short Term – Control settleability with Chlorine (Cl<sub>2</sub>)

- Add to Return Sludge Before Mixing With Wastewater
- Feed Chlorine as :
  - Solid - HTH
  - Liquid - Bleach
  - Gas
- Lbs Cl = 0.0000834 X SVI X F X W  
 F = RAS MGD  
 W = RAS TSS, mg/L
- Enough Cl<sub>2</sub> must be dosed to kill the filaments; start with the amount calculated by the formula above, increase if settleability does not improve within one day. Discontinue Cl<sub>2</sub> feed when settleability is under control.

#### 2. Normal SVI, SDI

##### a. Excessive amount of Biomass

- Recalculate CRT, Wasting Rate
- Inadequate Sludge Storage – make sure that maximum sludge storage capacity is available before winter to assure adequate WAS ability
- High SS, BOD in supernatant from sludge handling
- WAS solids being carried through Primary Clarifiers

- b. Inadequate Return Sludge Rate
  - RAS Pump Control Settings
  - Mechanical Condition of RAS Pumps, Meters, Valves
  - Clarifier Sludge Sump blocked with debris
  - Sludge collector mechanical problem
- c. Excessive Hydraulic or Solids Load on Clarifier
  - Determine Surface Overflow Rate (SOR)

**B. Scum and Foam**

- 1. White Billowing Foam
  - A.S. Plant Start-Up
  - Low CRT, High F:M
  - Organic Overload or Shock Load
  - Loss of Biomass – Over-wasting
  - Recovering from Toxicity



- 2. Dark, Scummy Brown Foam, Slurp
  - Some is normal in Extended Air
  - Excessive CRT
  - MLSS in Primary Effluent
  - Excessive Oil and Grease
  - Short Term Control
    - Manually Remove
  - Long Term Control
    - Increase Wasting

Slurp is caused by filamentous bacteria which have low specific gravity (they float) and trap air to form foam. Although there are two types of bacteria which may cause slurp, *Microthrix parvcella* and *Nocardia*, of these *Nocardia* seems to be the cause most often in Michigan. It is easily identified by microscopic examination of the foam as a highly branched, short filament which stains gram positive.

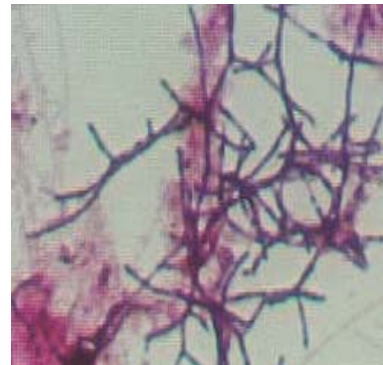

**C. High Effluent BOD**

- 1. If Total BOD is reported, also analyze the effluent for CBOD to determine if nitrification is causing the increased BOD. If this is the case and there is no ammonia limit in the discharge permit, try to get the plant out of nitrification, or call the DEQ district office and explain the problem.

2. If effluent CBOD is high:
  - a. Determine whether the CBOD is dissolved or particulate. If it is particulate, improve settling in the secondary clarifier or improve tertiary filtration.
  - b. Look for organic overload – High F:M, possibly shock loading of high strength organic waste, from within plant or from collection system.
  - c. Determine if CBOD is coming from a process downstream from the aeration tanks, such as from tertiary filters, effluent equalization, polishing pond, etc.
  - d. Assure adequate detention time in the aeration tanks, look for short circuiting.
  - e. Determine nutrient balance going into A.S. system. Don't remove phosphorus before aeration tanks.
  - f. Recalculate F:M and CRT to assure operation is in typical range.

#### D. Nitrogen

1. Excessive Effluent Ammonia
  - a. Assure that processes downstream from aeration tanks (such as polishing ponds) are not contributing ammonia directly to the effluent.
  - b. Carefully control supernatant from sludge handling, digestion, and storage units. This recycled flow typically contains very high ammonia concentration and is very often the cause of ammonia violations of the discharge permit.
  - c. Recalculate CRT and F:M to make sure that they are in the nitrification range. Avoid over-wasting or slug loading the biomass.
  - d. Analyze influent and effluent for total alkalinity. Influent should be at least 150 mg/L and effluent should be at least 50 mg/L. Add sodium bicarbonate or other form of alkalinity to aeration tanks if needed.
  - e. Increase aerator detention time if possible by putting more aeration tanks on line. Avoid taking aeration tanks out of service or other situations that would result in a loss of biomass or reduced aerator detention time, especially in cold weather.
  - f. Assure adequate D.O. (3-5 mg/L) at the discharge end of the aeration tank.
  - g. Check for toxicity entering the WWTP.
2. Excessive Total Inorganic Nitrogen (TIN)
  - a. Analyze for ammonia, nitrite, and nitrate.
  - b. If ammonia is high, refer to the previous troubleshooting section on ammonia.
  - c. If nitrite and nitrate are high, encourage denitrification.
    - Reduce excess D.O. in aerobic reactor
    - Avoid excessive detention time in aerobic reactor
    - Add carbon source (influent wastewater, methanol) to anoxic reactor
3. Denitrification causing floating solids in secondary clarifier
  - a. Verify denitrification with settling test; watch for formation of small nitrogen gas bubbles in MLSS during test.
  - b. Maintain a lower sludge blanket in secondary clarifier; increase return rate to remove solids before denitrification occurs.
  - c. In facility is capable of denitrification, assure purging of nitrogen gas before the mixed liquor enters the secondary clarifier.



4. Nitrite & Disinfection – refer to nitrogen section in manual.

## E. Phosphorus

### 1. Chemical P Removal

- a. Make sure that Ferric or Alum solution concentration (specific gravity and % solution) are as specified and have not been unexpectedly diluted.
- b. Check chemical feed rate at pump discharge; use calibration tube on system or container of known volume and stop-watch.
- c. Evaluate chemical feed point(s). Chemical should be fed after biological system and before sedimentation. Adequate mixing is important.
- d. Perform jar test to verify appropriate dosage.
- e. Analyze for Total P as well as Dissolved P to determine whether effluent P is soluble (dissolved) or is particulate.
  - If it is soluble, it should have reacted with the chemical to form a solid which settled in the secondary clarifier. Check chemical feed as outline above.
  - If it is particulate, it should have settled in the secondary clarifier. Improve settling conditions in the clarifier. Use polymer if necessary.
- f. Filter a sample and determine Total P and Ortho P on the filtrate.
  - If Ortho-P is high, it should have reacted with the chemical. Check chemical feed.
  - If Ortho-P is low in the filtrate, but Total P is high, the biomass is not converting the P to the Ortho form. Either conditions in the aeration tank are not appropriate for this conversion to occur, or the form of P cannot be converted by the biomass.
    - Look for an industry using a Phosphite ( $\text{PO}_3$ ) compound such as a metal finisher with an electroless nickel plating process.
    - If Phosphite is verified, it must be controlled at the source.

### 2. Biological P Removal

- a. Verify anaerobic followed by aerobic conditions. Oxidation / Reduction Potential (ORP) may be helpful in assessing this. The ORP in the anaerobic reactor should be less than about -200 mV, and in the aerobic reactor greater than about +50mV.
- b. Monitor Ortho-P in MLSS supernatant. A P release should be observed in the anaerobic reactor with resulting high Ortho-P in the liquid, followed by P uptake in the aerobic reactor resulting in low Ortho-P in the liquid.
- c. High amounts of inflow / infiltration may inhibit P removal by diluting the influent wastewater and adding D.O. to the anaerobic reactor.
- d. Control RAS from the secondary clarifier to avoid an excessive sludge blanket depth that may result in a P release.
- e. Avoid an excessive RAS flow from the secondary clarifier, especially in plants that are nitrifying. This dilutes the influent flow, and also adds nitrate to the head of the plant that can inhibit the release of P in the anaerobic reactor.

## **F. Toxicity**

1. While not always an indication of a problem, sometimes unusual odor, color change, or foam in the influent wastewater accompany a toxicity problem.
2. Monitor aeration tank D.O. continually if possible. If BOD load, blower output, and MLSS have remained fairly constant, a sudden increase in aeration tank D.O. may be an indication of reduced biological activity due to toxicity.
3. Use the microscope to observe indicator organisms in the mixed liquor. Watch for inactivity among normally active organisms, and for disrupted cells.
4. Monitor Respiration Rate of the biomass. This will be most helpful if there is sufficient past data for comparison. If the respiration rate on a fed sample (sugar added) is lower than normal, toxicity is a definite possibility.
5. Be aware of potential contributors of toxicity to the collection system. This may or may not be due to an industrial discharge. Several municipal wastewater treatment plants have experienced severe toxicity problems following the use of root killers in the collection system by sewer cleaning companies.
6. Deflocculation of the biomass is often the result of toxicity. The effluent becomes turbid and settleability is suddenly poor as the biological floc comes apart, releasing small particulates into the wastewater.
7. White billowing foam resembling soap suds may occur on the aeration tank as the biomass begins to recover from a toxic waste.
8. Remember that toxicity due to heavy metals as well as some organic compounds may result in contamination of the sludge. Pumping this into an anaerobic or aerobic digester may compound the problem in the plant by inhibiting the sludge stabilization process and interfering with the ability to dewater the solids. It may also result in inability to dispose of the sludge by land application onto agricultural land.
9. While effluent BOD will probably increase following a toxicity problem, increased effluent ammonia will usually be more immediately apparent.
10. The list of materials potentially toxic to activated sludge biomass would be too long to list, but includes pesticides, herbicides, disinfectants, many heavy metals, cyanide, degreasing agents, and high concentrations of ammonia or sulfide. If there is some question as to the treatability of a waste, the oxygen uptake rate test may be used to help make this determination.

## MODIFICATIONS

**X. Modifications of the Activated Sludge Process**

The activated sludge process has been modified in many ways through the years for several purposes. Modifications have occurred as a result of trying to improve treatment for specific types of wastes or to achieve more complete removal of a certain component of the waste. In some situations economics may be the overriding factor in the development of an activated sludge modification, and in others the ability to treat high wastewater flow rates or high strength organic wastes may be the objective. Some modifications have been very successful and are used extensively, while others have not been used to a large extent.

**A. Conventional**

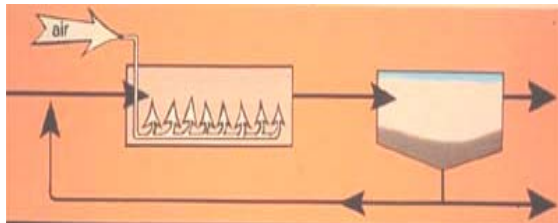

|            |             |
|------------|-------------|
| F:M        | 0.25 – 0.45 |
| CRT        | 5 – 8 days  |
| Aerator DT | 5 hours     |

**B. A/O and A2/O**

The A/O process is an activated sludge modification that is designed to provide biological P removal. The MLSS passes through an anaerobic zone is followed by an aerobic zone.

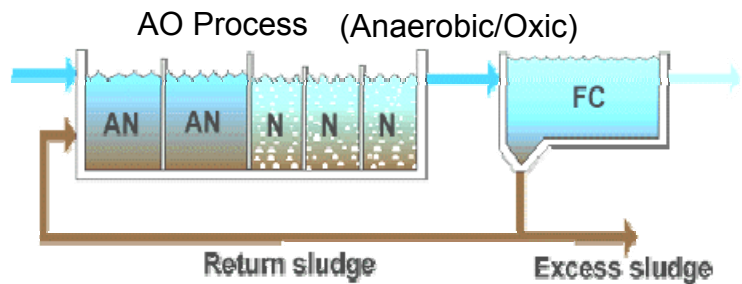

**A2/O (Anaerobic/Anoxic/Oxic)**

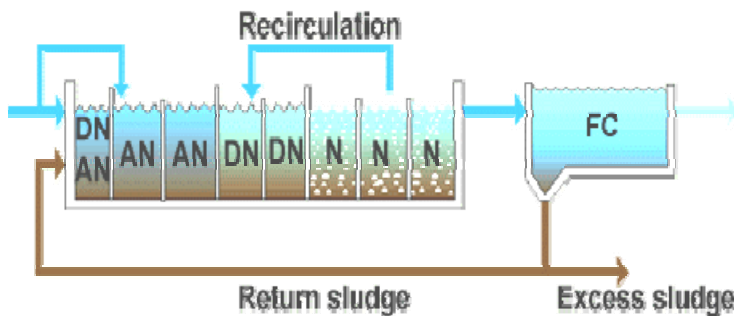

The A2/O process is like the A/O process with an added internal recirculation of MLSS through an anoxic zone. This provides denitrification and prevents NO<sub>3</sub> from interfering with biological P removal.

**C. Contact stabilization**

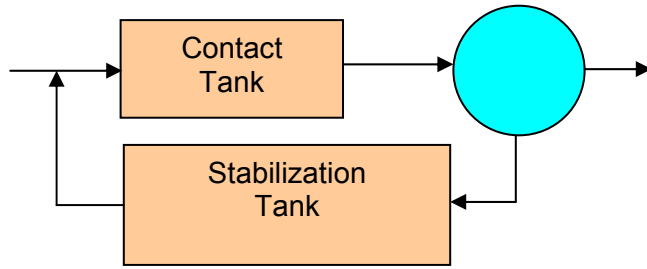

This process takes advantage of the adsorptive capability of activated sludge. Particulates are adsorbed by the biomass in a Contact Tank with a short detention time (about 2 hrs). Return sludge is directed to a Stabilization Tank where the

organisms metabolize the adsorbed material. This process works well for wastewaters high in particulate material, but is not very effective for high soluble / low particulate wastes due to the short detention time in the Contact Tank. An added benefit is the large reserve of MLSS in the Stabilization Tank that can be utilized in case of wash-out.

**D. Tapered aeration**

Amount of Air Added is tapered from Aeration Tank influent to effluent. More air is added where organic load and biological activity is greatest.

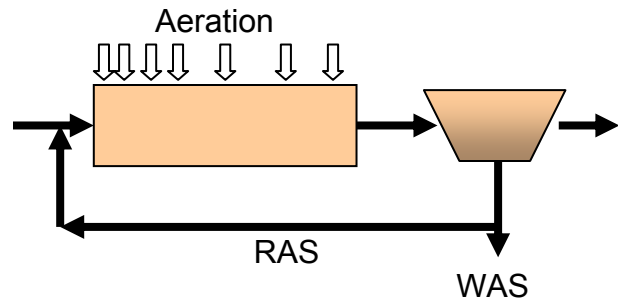

**E. Step aeration**

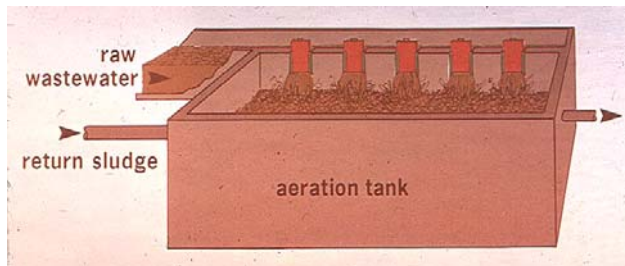

Return Sludge Enters Head of Aeration Tank; Wastewater is added at various points along length of tank. Intended to distribute the wastewater throughout the Aeration Tank. Avoids areas of low and high D.O. in Aeration Tank.

**F. Step feed**

Return Sludge and wastewater are added at various points along length of tank. Intended to avoid high and low areas of loading and D.O. Approximates Complete Mix.

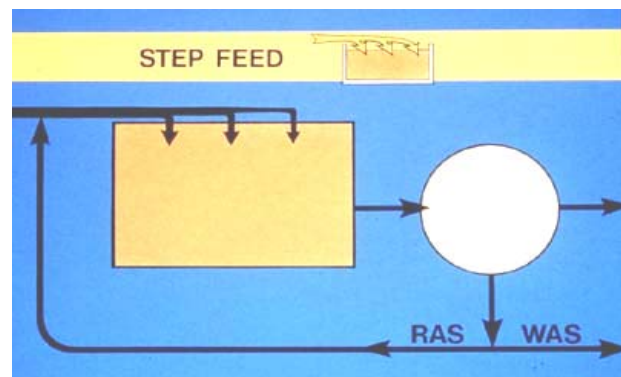



### G. Complete Mix

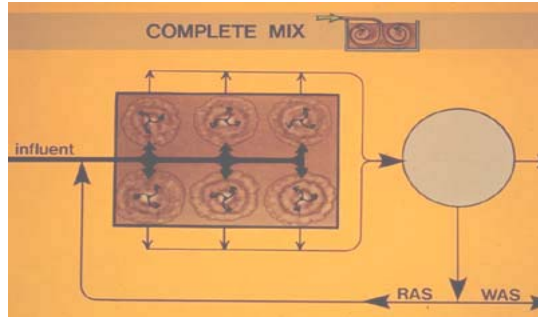

Return Sludge and influent waste are distributed throughout the aeration tank. Mixed liquor exits the reactor around the tank perimeter. Treatment is uniform in the reactor. Shock Loads are immediately diluted. Generally smaller tanks are more completely mixed than large ones. May be more susceptible to filamentous bulking.

### H. Pure oxygen

High quality Oxygen is generated on-site to be used rather than air in the aeration tank. Aeration system is covered to minimize loss of O<sub>2</sub>. Operated at high F:M Ratio. Designed to reduce area needed to treat large or high strength flows.

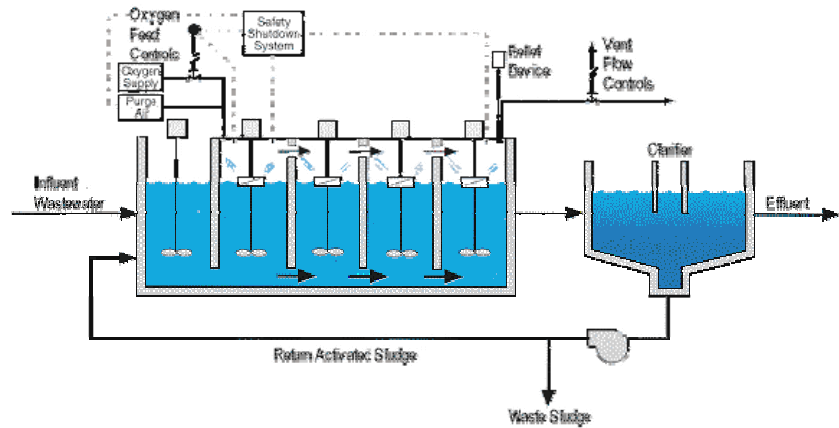

City of Detroit    City of Wyandotte  
 City of Holland    French Paper Company

### I. Plug Flow

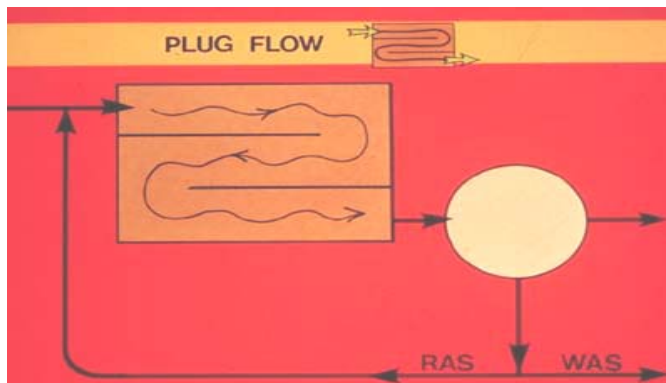

Wastewater and Return Sludge enter head of Aeration Tank and travel as a "Plug" through the tank. Minimizes short-circuiting. D.O. at head of tank may be low due to localized introduction of entire BOD load and increases as ML travels to outlet.

**I. Extended Aeration**

Long Detention Time  
 High MLSS  
 High CRT  
 Low F:M  
 High Quality Effluent  
 Nitrification is very likely. Resists upset due to large biomass population and long detention time.

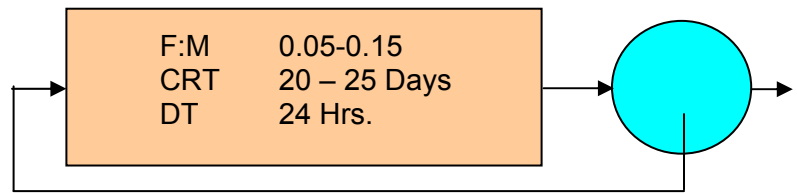

**J. Oxidation ditch**

**1. Racetrack Ditch**

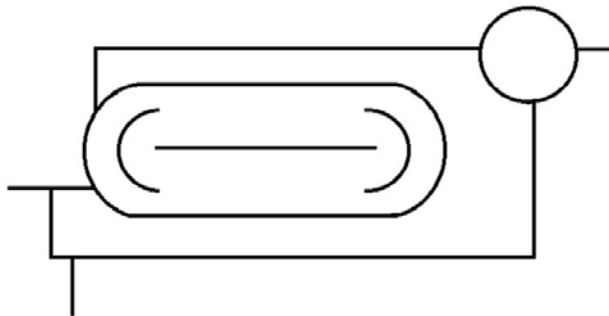

Usually operated as Extended Aeration. Typically uses Mechanical Aeration called “rotors” that aerate and mix. D.O. Approximates Plug Flow Due to varying D.O. environment in ditch. Mixing Approximates Complete Mix (ML stays in ditch through many revolutions).

**2. Concentric Ring Oxidation Ditch**

Usually Extended Aeration. Nitrification, Denitrification, and biological P removal is often attained. RAS and influent enter first ring which is operated in anaerobic condition. MLSS passes into inner two rings which are aerobic.



**K. Sequencing Batch Reactor**

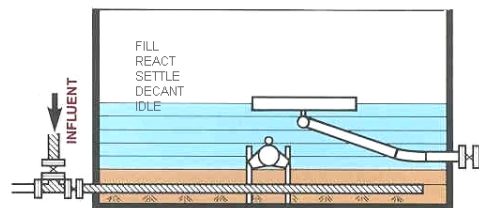

The SBR is an activated sludge modification in which treatment occurs in batches rather than continuous flow. Treatment takes place in 5 phases in the reactor; each phase is computer controlled. The biomass stays in the reactor with a portion being wasted each treatment cycle.

There are no secondary clarifiers, no RAS, and usually no primary treatment. The SBR process is typically operated in the Extended Aeration mode, with nitrification usually occurring. Because the D.O. environment changes from anaerobic during the fill phase to aerobic during the react phase, the system is capable of denitrification, as well as biological P removal.

**L. Bio-Lac**

The Bio-Lac system was developed by the Parkson Corporation. It is an extended aeration system, often designed as a large rectangular basin with sloping sides. Fine bubble aeration tubes are suspended from air headers which float on the surface of the basin. This arrangement helps to eliminate dead spots in the basin, ensuring even air distribution. This process is being used in some municipal wastewater treatment plants in Michigan.

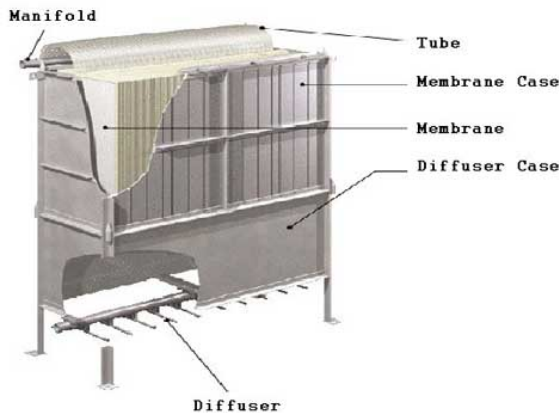

**M. Membrane Bio-Reactor (MBR)**

The MBR process is an activated sludge process in which the secondary clarifiers are replaced by filtration units which are submerged in the mixed liquor. Offered by several manufacturers, MBR plants are currently in operation at Traverse City and at Dundee. The filtration units are designed either as tubes or hollow fibers (Zenon), or as cassettes of flat plates (Kubota). Advantages include high biomass concentration in the reactor (>10,000 mg/L), biomass settleability is not a concern, and the ability to remove very fine particulates.

**N. Aero-Mod Sequox**

The Sequox system by Aero-Mod is a flow through activated sludge process designed for biological nutrient removal. An anaerobic selector ahead of the aeration system provides filament control and encourages biological P removal. Alternating aerobic/anoxic reactors following first stage aeration provide denitrification. This is a compact design, utilizing air lifts for most of the pumping requirements. One of these facilities is in operation at Kingsley.

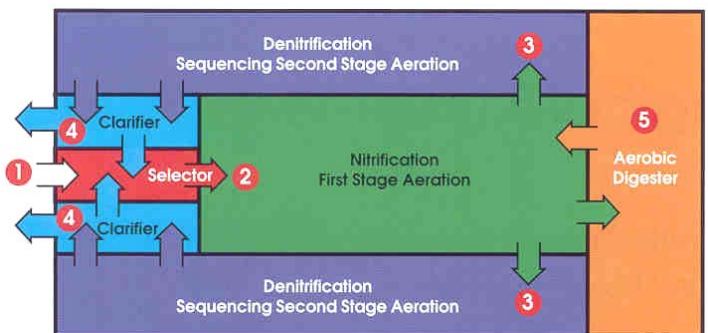

**BENCH SHEET**

ACTIVATED SLUDGE BENCHSHEET

DATE

| SAMPLE                            | MLSS #1       | MLSS #2 | RAS #1  | RAS #2  |
|-----------------------------------|---------------|---------|---------|---------|
|                                   | a. mls Sample |         |         |         |
| b. Filter Paper + Dry, grams      |               |         |         |         |
| c. Filter Paper, grams            |               |         |         |         |
| d. Dry Solids, grams (b - c)      |               |         |         |         |
| e. Suspended Solids, mg/L         |               |         |         |         |
| f. Percent Solids                 |               |         |         |         |
|                                   |               |         |         |         |
|                                   | MLVSS         | MLVSS   | RAS VSS | RAS VSS |
| g. Dish + Ash, grams              |               |         |         |         |
| h. Dish, grams                    |               |         |         |         |
| i. Ash, grams                     |               |         |         |         |
| j. Volatile Solids, grams (d - i) |               |         |         |         |
| k. Volatile Solids, mg/L          |               |         |         |         |
| l. % Volatile Solids              |               |         |         |         |

| D.O., mg/L | A.T. #1 | A.T. #2 |
|------------|---------|---------|
| Time       |         |         |
|            |         |         |
|            |         |         |
|            |         |         |
|            |         |         |

| SETTLABILITY |             |
|--------------|-------------|
| Time         | mLs Settled |
| 5 min        |             |
| 10 min       |             |
| 15 min       |             |
| 20 min       |             |
| 30 min       |             |
| SVI          |             |

| Sludge Blanket Depth, ft |         |         | RAS Flow % Influent |         |
|--------------------------|---------|---------|---------------------|---------|
| Time                     | Clar #1 | Clar #2 | Clar #1             | Clar #2 |
|                          |         |         |                     |         |
|                          |         |         |                     |         |
|                          |         |         |                     |         |
|                          |         |         |                     |         |

| WAS gallons |
|-------------|
|             |



# Interpretation of Oxygen Uptake Test Results

## Overview

Respiration rate test results are very dependent on environmental conditions and concentration of microorganisms. The example values given here are very general. The actual results that you get will be very specific to the biological system you are monitoring.

---

### Units:

Values for oxygen uptake rates (OUR) are given in mg DO/l/min. Values for specific oxygen uptake rates (SOUR) are given in mg/hr/gram of MLSS.

---

### UNFED Values:

An unfed OUR is defined as a sample of return activated sludge plus secondary effluent. This mixture's concentration is designed to imitate the MLSS concentration in the aeration tank. For MLSS concentration between 2500 and 3500 mg/L, the unfed OUR will range between 0.3 and 0.7 mg/l/min.

Please pay attention to the MLSS concentration. The higher the MLSS concentration, the higher the number of "bugs" that are breathing. This means a MLSS of 2,500 mg/L may show a higher OUR value than a MLSS of 1,500 mg/L on the same sample. The lower MLSS concentration would normally create a younger sludge which might result in a higher rate of respiration per gram. The OUR test results would make the higher MLSS concentration "look like" a younger sludge. This problem is solved when you calculate the SOUR.

Low UNFED Values: < 0.3 mg/l/min

The lower the value the older the sludge. You should also see other indications of older sludge in the plant, fast settling floc, pin floc, etc..

High UNFED Values: > 0.8 mg/l/min

The higher the value the faster growing , younger the sludge is. A high unfed OUR indicates an under-oxidized sludge, slower settling, low compaction, etc..

---

### FED Values:

A fed OUR is defined as a sample of return activated sludge plus primary effluent or raw influent. This mixture's concentration is designed to imitate the MLSS concentration in the aeration tank. For MLSS concentration between 2500 and 3500 mg/L, the fed OUR will range between 2 to 5 times the unfed rate. Example: 0.6 to 3.5 mg/l/min. Most aeration systems should be able to handle a range of 2.0 to 2.5 mg/l/min.

Note: these numbers are example for MLSS concentrations between 2500 and 3500 mg/L. If your system is running at 1500 to 2500 mg/L, your average values would be different.

Low FED Values: < 0.6 mg/l/min

A low fed OUR could indicate a number of conditions: low BOD load and/or too high of a MLSS concentration, food type cannot be used easily by the microorganisms or a toxic waste that is inhibiting the growth of the bacteria.

High FED Values: > 3.5 mg/l/min

High fed OUR numbers indicates a high food load on the system. Question about adequate air supply and mixing must be answered. A move to step-feed may be required.

### Specific Oxygen Uptake Rate

Converting your OUR values into SOUR values is a common practice. OUR is converted into SOUR by dividing the OUR by the MLSS or MLVSS (MLVSS is preferred) and multiplying by 1,000 mg/gram and multiplying by 60 min/hour. The resulting unit is mg oxygen per hour per gram of MLSS (mg/hr/gr). This removes the variable of changing MLSS concentrations. If respiration rate numbers are given in a common unit of "one gram of MLSS", SOUR values can be compared from plant to plant.

$$\text{SOUR} = \frac{(\text{OUR mg/L/min})(60 \text{ min/hr})(1000 \text{ mg/gram})}{(\text{MLVSS mg/L})}$$

For example, A fed sample OUR = 1.4 mg/L/min. The MLVSS of this sample is 2100 mg/L. The SOUR would be calculated by the following:

$$\frac{(1.4 \text{ mg/L/min})(60 \text{ min/hr})(1000 \text{ mg/gram})}{(2100 \text{ mg/L})}$$

$$\text{SOUR} = \underline{\underline{40 \text{ mg/hr/gram}}}$$

If this same example has the same OUR but a MLVSS of 3500 mg/L, the SOUR would be:

$$\frac{(1.4 \text{ mg/L/min})(60 \text{ min/hr})(1000 \text{ mg/gram})}{(3500 \text{ mg/L})}$$

$$\text{SOUR} = \underline{\underline{24 \text{ mg/hr/gram}}}$$

In this example you can see that for the same value of OUR, the SOUR values are changed significantly based on the MLVSS concentration. Based on the SOUR values, the higher MLVSS actually has a smaller respiration rate per gram of active solids (VSS).



---

**Load Factor**

Another calculation is sometimes used to interpret the fed and unfed numbers. Load factor or load index is a ratio between the fed and unfed values (the fed number is divided by the unfed number). This value indicates activity before and after feeding.

$$\text{Load Factor} = \frac{\text{FED mg/L/min}}{\text{UNFED mg/L/min}}$$

1. LF < 1.0 - inhibitory or toxic load
  2. LF > 1.0 but < 2.0 - dilute or stabilized load
  3. LF > 2.0 but < 5.0 - acceptable loading
  4. LF > 5.0 - possible oxygen supply problems
-

# NUTRIENT ADDITION

## Nutrient Requirements for Activated Sludge

For every 100 lbs. (or mg/L) of organic carbon ( $BOD_5$ ) entering the aeration system, a minimum of 5 lbs. (or mg/L) of nitrogen, 1 lb. (or mg/L) of phosphorus, and 0.5 lbs. (or mg/L) of iron is required.

$$100 BOD_5 : 5 N : 1 P : 0.5 Fe$$

A nutrient deficiency of any of these essential requirements may cause excessive growth of filamentous organisms resulting in poor settling of the activated sludge. These filamentous growths can not be successfully controlled by chlorination, hydrogen peroxide, or polymers. If the nutrient deficiency is severe, the ability of the microorganisms to remove soluble organic matter will be impaired, resulting in treatment failure.

The above ratio is useful for detecting nutrient deficient wastes and supplemental feeding of nutrients. Major factors that should be considered when feeding nutrients include:

1. Both ammonia and nitrate are available as nitrogen sources, as well as organic nitrogen (urea). However, if organically bound nitrogen is used and the waste contains a carbon source that is easily metabolized (simple sugars and organic acids), the nitrogen may not be available rapidly enough during the metabolism of these wastes.
2. If the organic loading varies, the nutrient supply should vary with the loading.
3. Since each wastewater has its own particular nutrient demand, measurement of effluent concentrations for orthophosphate, ammonia, and nitrate should be performed. Concentrations of total inorganic nitrogen ( $NH_3$ ,  $NO_2$ , and  $NO_3$ ) of at least 0.2 to 0.3 mg/L and soluble Orthophosphate of 0.2 mg/L should be maintained. Phosphorus measurements should be made on effluent samples filtered through 0.45  $\mu m$  filter paper.

Supplemental nutrient feed is calculated based on the number of pounds of BOD coming into the secondary process, the amount of nutrients already present in the incoming waste, and the properties of the commercial chemical that will be used to supply the nutrient. Take a step-by-step approach to make the calculation more understandable.

Start out by determining how much (mg/L) of each nutrient is required to supply the amount indicated by the 100 C : 5 N : 1 P : 0.5 Fe ratio.

Next, determine how much (mg/L) nutrient is needed in addition to that already in the waste.

Using the pounds formula, calculate how many pounds of each nutrient must be added.

Based on the properties of the commercial chemical that will be used to supply the nutrient, calculate the pounds of the chemical must be used.

If the commercial chemical is a liquid, determine the number of gallons of the solution that must be fed each day.

## Example Calculation of Nutrient Addition

|                                     |          |
|-------------------------------------|----------|
| Average Flow                        | 4.5 MGD  |
| Secondary Influent BOD <sub>5</sub> | 150 mg/L |
| Secondary Influent TKN              | 2.5 mg/L |
| Secondary Influent P                | 1.0 mg/L |
| Secondary Influent Fe               | 1.0 mg/L |

Commercial Chemicals to be Used:

Anhydrous Ammonia (NH<sub>3</sub>) = 80 % NH<sub>3</sub> by Weight

Phosphoric Acid (H<sub>3</sub>PO<sub>4</sub>) = 50 % H<sub>3</sub>PO<sub>4</sub> Solution by Weight  
Specific Gravity 1.335

Target Ratio by Weight 100 BOD : 5 N : 1 P : 0.5 Fe

- Determine the mg/L of each nutrient required to satisfy the ratio:

$$\text{N Required, mg/L} = \frac{\text{BOD, mg/L}}{\text{Ratio BOD:N}}$$

$$= \frac{150 \text{ mg/L}}{100/5}$$

$$= \frac{150}{20}$$

$$= 7.5 \text{ mg/L N}$$

$$\text{P Required, mg/L} = \frac{\text{BOD, mg/L}}{\text{Ratio BOD:P}}$$

$$= \frac{150 \text{ mg/L}}{100/1} = \frac{150}{100}$$

$$= 1.5 \text{ mg/L P}$$

$$\text{Fe Required, mg/L} = \frac{\text{BOD, mg/L}}{\text{Ratio BOD:Fe}}$$

$$= \frac{150 \text{ mg/L}}{100 / 0.5} = \frac{150}{200}$$

$$= 0.75 \text{ mg/L Fe}$$

2. Determine how many additional mg/L of each nutrient is needed:

$$\begin{aligned}
 \text{N Additional, mg/L} &= 7.5 \text{ mg/L N} - 2.5 \text{ mg/L N} \\
 &= 5.0 \text{ mg/L N additional needed} \\
 \\
 \text{P Additional, mg/L} &= 1.5 \text{ mg/L P} - 1.0 \text{ mg/L P} \\
 &= 0.5 \text{ mg/L P additional needed} \\
 \\
 \text{Fe Additional, mg/L} &= 0.75 \text{ mg/L Fe} - 1.0 \text{ mg/L Fe} \\
 &= -0.25 \text{ mg/L Fe (have excess, none needed)}
 \end{aligned}$$

3. Determine how many additional pounds of each nutrient are needed:

$$\begin{aligned}
 \text{N addition, lbs/day} &= \text{Flow, MGD} \times \text{N Addition, mg/L} \times 8.34 \text{ lbs/gal} \\
 &= 4.5 \text{ MGD} \times 5 \text{ mg/L} \times 8.34 \text{ lbs/gal} \\
 &= 188 \text{ lbs / day additional N needed} \\
 \\
 \text{P addition, lbs/day} &= \text{Flow, MGD} \times \text{P Addition, mg/L} \times 8.34 \text{ lbs/gal} \\
 &= 4.5 \text{ MGD} \times 0.5 \text{ mg/L} \times 8.34 \text{ lbs/gal} \\
 &= 18.8 \text{ lbs/day additional P needed}
 \end{aligned}$$

4. Determine how many pounds per day of each commercial chemical will be needed to supply the required pounds of nutrient:

$$\text{Commercial Chemical, lbs/day} = \frac{\text{Nutrient Addition, lbs/day}}{\text{Decimal \% of Nutrient} \times \text{Decimal \% of Pure Commercial Chemical}}$$

A. Determine lbs of Anhydrous Ammonia to be Fed Per Day:

$$\text{Decimal \% of N in Anhydrous Ammonia (NH}_3\text{)} = \frac{\text{Atomic Wt. of N}}{\text{Molecular Wt. of NH}_3}$$

$$\begin{aligned}
 \text{N} &= 14 \times 1 = 14 \\
 \text{H} &= 1 \times 3 = \underline{3} \\
 \text{NH}_3 &= \underline{17}
 \end{aligned}$$

$$\text{Decimal \% of N in Anhydrous Ammonia} = 14 / 17 = 0.8235$$

$$\text{Lbs/day of NH}_3 \text{ Needed} = \frac{188 \text{ lbs/d N Needed}}{0.8235} = 228 \text{ lbs/day}$$

$$\text{Lbs/day of 80\% Anhydrous Needed} = \frac{228 \text{ lbs/day}}{0.80} = 285 \text{ lbs/day}$$

B. Determine Pounds of Phosphoric Acid Solution (H<sub>3</sub>PO<sub>4</sub>) to be Fed Per Day:

$$\text{Decimal \% of P in H}_3\text{PO}_4 = \frac{\text{Atomic Wt. of P}}{\text{Molecular Wt. of H}_3\text{PO}_4}$$

$$\begin{array}{rcl} \text{H} & = & 1 \times 3 = 3 \\ \text{P} & = & 31 \times 1 = 31 \\ \text{O} & = & 16 \times 4 = 64 \\ \text{H}_3\text{PO}_4 & = & \underline{98} \end{array}$$

$$\text{Decimal \% of P in H}_3\text{PO}_4 = 31 / 98 = 0.3163$$

$$\text{Lbs/day of H}_3\text{PO}_4 \text{ Needed} = \frac{18.8 \text{ lbs/d P Needed}}{0.3163} = 59 \text{ lbs/day}$$

5. Determine Gallons of 50 % Phosphoric Acid Solution Needed Per Day:

$$\begin{aligned} \text{Lbs/day of 50\% H}_3\text{PO}_4 \text{ Solution Needed} &= \frac{59 \text{ lbs/day H}_3\text{PO}_4 \text{ Needed}}{0.50 \times 1.335 \times 8.34 \text{ lbs/gal}} \\ &= 10.6 \text{ gallons/day needed} \end{aligned}$$

## A.S. HISTORY

# THE GENESIS AND EVOLUTION OF ACTIVATED SLUDGE TECHNOLOGY

James E. Alleman, *Professor*

School of Civil Engineering

West Lafayette, IN 47907-1284

[[alleman@ecn.ecn.purdue.edu](mailto:alleman@ecn.ecn.purdue.edu)]

[PH: 765-494-7705]

[FX: 765-496-1107]

## INTRODUCTION

The design and operation of activated sludge systems represents one of the key topics covered during any environmental engineer's education. Our courses and textbooks thoroughly examine the topic, shedding light and wisdom on a process whose finer details have been mastered to a point likely more advanced than that of any other wastewater treatment technology.

However, should you happen to ask any one of our student's what they know about the formative history of the concept, let alone the names and backgrounds of the responsible engineers, you'll quickly find that their corresponding knowledge ranges from bare to nil. In large measure, the technical roots for activated sludge have largely been ignored within our current texts and classes, such that most students likely share a common misconception that activated sludge has forever been the preeminent option for wastewater purification.

Most practicing engineers, though, belatedly develop an appreciation for the 'art' of their applied technology, transcending their textbook's wisdom about kinetics and microbiology with a personal, human interest in the '*who, what, when, and why*' of the affiliated history. This article will consequently examine the yesteryear circumstances under which activated sludge was devised, and the early developments which largely shaped its subsequent use.

Admittedly, there have been many articles written about this singular topic. The following chronology provides a summarial overview of these prior 'review' publications: *Porter, 1917; Ardern, 1917; Porter, 1921; Martin, 1927; Clark, 1930; Mohlman, 1938; Greeley, 1945; Sawyer, 1965; and Alleman, 1984.*



These works have progressively provided informative reviews and updates on the ever-expanding history of activated sludge treatment. Porter's two works alone, respectively written in 1917 and 1921, are certainly indicative of the explosive interest which this technology first drew. Barely six years after the idea had originally been published, the associated literature had already grown in number to nearly 800 articles. The paper at-hand will, therefore, unavoidably retrace technical developments thoroughly documented by these preceding activated sludge historians. This latest review will, however, attempt to provide yet another slant on the topic, with new insights regarding the personal and scientific motivations which catalyzed the original concept.

## **FLEDGLING CONCERNS ABOUT WASTEWATER MANAGEMENT:**

### Mid-to Late-19<sup>th</sup> Century

In order to understand the impact which activated sludge had on wastewater treatment technology, one must first appreciate the relative infancy of the 'sanitary' field which existed during the mid- to late-1800's. Midway through the 19<sup>th</sup> century, barely a handful of European cities had any sort of organized approach to handling their daily wastewater problem. While the Industrial Revolution had produced a manifold range of technical blessings, these new industries also added a considerable increase in the magnitude and strength of local waste output, heavily befouling their already burdened environment.

Installing sewers would prove to be the first step in the sequential process of waste management, but very few cities had yet made this effort. The necessary technology had been established nearly two millennia earlier by Greek and Roman planners, but for most industrialized 19<sup>th</sup> century towns the notion of intentionally conveying these wastes streams beyond their municipal borders was still in its infancy...and effectively beyond their technical capabilities. For this matter, the delivery of clean water itself had hardly become a commonplace practice.

Lacking any means of collecting and removing these wastewaters, therefore, the convenient solution was either one of direct discharge from chamber pot to street or, for those more affluent homes, to rely on a central cesspit. However, John Snow's investigation in the 1850's of yet another cholera outbreak caused by one such cesspit failure (i.e., near London's Broad Street area) provided a frightfully compelling motivation to find suitable solutions for the public's intertwined water/wastewater problems.

Over the next several decades there was a consequent move to install pumping and supply systems for delivering clean water, followed shortly thereafter by complementary sewer networks with which this incoming water could then be removed to some distant point of discharge. The science of sewer design, though, was anything but a mature technology. As implied by the classic 2858 'Punch' poem, "*Slow But Sewer*," there was considerable argument about the notion of co-mingling rain waters to flush and dilute these streams, but the problems created by inadequately sloped sewers eventually led to widespread adoption of the combined designs.

At this point, the solution of downstream ‘dilution’ had become civilization’s best strategy for dealing with wastes. However, with these wastes now being funneled to discrete outfalls, the idea evolved that these streams might actually be used for beneficial gain as a convenient, and free, source of fertilizing nutrients. Punch’s poem briefly captures this mood, and Victor Hugh’s classic, "*Les Miserables*," offered an even more convincing argument for reusing what he aptly described as the ‘*detritus of capital*’:

*"A great city is the most powerful of stercoraries. To employ the city to enrich the plain would be a sure success. If our gold in filth, then our filth is gold....these fetid streams of subterranean slime which the pavement hides from you, do you know what all this is? It is the flowering meadow, it is the green grass, it is marjoram and thyme and sage, it is game, it is cattle, it is the satisfied low of huge oxen at evening, it is perfumed hay, it is golden corn, it is bread on your table, it is warm blood in your veins, it is health, it is joy, it is life."*

These newly devised waste conduits were subsequently recognized as a prime commodity for entrepreneurial gain, and a cottage industry of wastewater alchemists quickly emerged intent on extracting the nutrient essence of sewage for monetary gain. The Native Guano Company eventually dominated this ‘manure’ market in England, franchised and licensed to cities with the lofty expectation that they could transform their foul wastes into a profitable ‘artificial fertilizer.’ In retrospect, therefore, these original treatment plants were frankly not built for environmental or sanitary gain. Instead, the prime goal for this company’s patented technology, known as the "ABC Process,’ was considerably more focused on nutrient recovery (nitrogen and phosphorus).

In retrospect, though, the ABC Process started a sanitary revolution whose technical prodigy would eventually lead us to full-fledged wastewater treatment facilities. This original procedure, using alum, blood, and clay (i.e., "ABC") to optimistically promote a sort of natural ‘coagulation,’ no doubt qualifies as the seminal prototype for physical-chemical sewage treatment. Undoubtedly, this scheme was a malodorous first step, but the precedent had been established against which future engineers could measure their success.

**EARLY BIOLOGICAL WASTEWATER TECHNOLOGY:**

1870's -> 1900's

Biological treatment was unquestionably a primitive science in the late 1800's, having only recently been elucidated through progressive European (i.e. Mueller, Frankland, Bailey-Denton, Dibdin) and American (i.e. Mills, Hazen, Drown and Sedgwick of the Lawrence Experimental Station situated in Lawrence, Massachusetts) filtration research. (Peters & Alleman, 1982) The basic derivatives of their work included intermittent filters, contact beds and trickling filters.

Septic tanks were also popular during this era, at least until Cameron obtained a restrictive patent in 1896 and began to enforce substantial royalty charges despite bitter public criticism. Although the popularity of septic tanks subsequently faded, alternative anaerobic systems were soon available, including both the classic Imhoff Tank and its predecessor, the Travis 'Colloider' or 'Hydrolytic' Tank. (Peters & Alleman, 1982) Imhoff also patented his unit, but the associated royalty charges were considerably lower.

**PRELIMINARY 'BLOWING-AIR' RESEARCH:**

1880's -> 1910's

Searching for an improvement in sewage treatment, and with an intuitive inclination that aerobic conditions would avoid undesirable, malodorous anaerobic results, several researchers began to explore blowing air into sewage tanks. Dr. Angus Smith's work in 1882 is commonly referenced as the original study, followed by Dibdin and Dupre, Hartland and Kaye-Parry, Drown, and Mason and Hine. (Martin, 1927; Pearse, 1938) For the most part, these early pioneers felt that oxygen presence '*per se*' would provide the desired oxidation of wastewater contaminants. Experimental results, though, were nominal at best. Although putrescence was typically delayed, the effort and expense of aeration seemed to lack significant compensation in terms of improved treatment.

Somewhat greater success was obtained, however, in studies of artificially aerated contact filter beds conducted both by Col. George Waring and the Lawrence Experimental Station. (Martin, 1927; Pearse, 1938; Peters & Alleman, 1982) In hindsight, it is evident that these latter fixed-film units were receptive to the stimulus of aeration because of their existing biomass, whereas the earlier aeration tanks lacked a recycled biological population.

Over the course of the next few years, the importance of a suspended precipitant for enhanced biological treatment became more accepted. Studies conducted by Mather and Platt in 1893 indicated that precipitated impurities which accumulated at the bottom of aeration tanks provided a marked enhancement of available treatment. (Martin, 1927) In his presentation to the Royal Commission in 1905, Adeney reinforced this belief that collected humus matters would accelerate the treatment capacity. (Martin, 1927; Pearse, 1938) Fowler's experiments on sewage aeration in 1897 also yielded a clear effluent with rapid settling deposits of particulate matter. (Martin, 1938) However, Fowler conversely

viewed the enhanced deposition as a failure since he personally believed that sewage impurities were to be rendered soluble or gasified for optimal treatment.

By 1910, the merits of aerating sewage in the presence of biological humus or slime were beginning to find widespread acknowledgement. In their classic full-scale New York study, Black and Phelps decided to abandon coarse rock media in favor of closely spaced, wooden laths in order to achieve a higher surface area for desired slime accumulation. (Black & Phelps, 1914) In essence, their unit was an aerated version of the prior Travis 'Colloider' or 'Hydrolytic' Tank (which had also used wood laths, but in an anaerobic contact chamber).

Clark and Gage also initiated similar laboratory studies at Lawrence in 1912, comparing aerated treatment efficiencies of bottles inoculated with algal suspensions against that obtained in packed slate beds. (Martin, 1927; Pearse, 1938) The slate bed concept should, however, be attributed to Dibdin. (Dibdin, 1913) Having been unsuccessful at simple aeration in 1884, Dibdin had successively studied intermittent filtration, contact beds and serial contact beds before coming full circle to the notion of combining aeration with biological treatment in a slate bed contactor.

#### **INITIAL GENESIS OF THE ACTIVATED SLUDGE CONCEPT:**

1912 -> 1914

Giving these latter studies at New York and Lawrence, it was, therefore, serendipitous that the eminent Englishman, Sir Gilbert John Fowler, was called to the United States to review the New York Harbor pollution problem. (Martin, 1927; Pearse, 1938; Arden & Lockett, 1914a) In conjunction with this trip, Fowler had an opportunity to witness first-hand Clark and Gage's ongoing experiments on Lawrence in 1912. Fowler subsequently credited this visit as the impetus for his "*illuminating idea*" regarding activated sludge, referring to Lawrence as the "*Mecca of sewage purification.*"

Although disappointed with his prior aeration experiments, Fowler quickly seized upon the concept of employing a suspended biomass culture and initiated several related experiments upon returning to Manchester, England. One year after the Lawrence tour, Fowler and one of his graduate students, Mrs. Mumford, published their successful results covering a suspended-culture aeration system inoculated with iron salts and an special 'M-7' iron bacterium. (Fowler & Mumford, 1913) Their treatment scheme sequentially employed a 'blowing tank' and clarifier. However, their system had two shortcomings. First, since it did not have a means of recycling solids, the unit required continuous inoculation with their mysterious M-7 organisms. Secondly, Fowler at this point was laboring under the misconception that his special 'iron' bacteria played a major role in the overall efficacy of the process. To some extent, this misunderstanding might have been linked to the use of coagulating, iron-rich blood started fifty years earlier with the ABC Process. This misunderstanding about the role of iron and iron-bacteria, though, would then persist for more than a decade (Wolman, 1927).

At this point, 31 years had elapsed since Dr. Smith first examined the aeration of sewage. However, the seemingly simplistic notion of accumulating a suspended biomass through solids recycle was still unknown. Hence, the revelation by Fowler's students, Ardern and Lockett, in May 1914 that these humus solids should be saved rather than discarded proved to be an unqualified "*bombshell*" (using Fowler's description, provided during an audience reply following presentation of Ardern and Lockett's paper).

Ever sensitive to the fiscal realities of academic research, Ardern and Lockett acknowledged their gracious appreciation for the monetary support which had been provided by the 'Worshipful Company of Grocers.' (Ardern & Lockett, 1914b) In retrospect, the fact that 'grocers' would have been interested in this sort of research topic does seem rather odd. However, upon reading the audience comments following their presentation, it is readily evident that they genuinely thought this system's waste sludge would yield a marketable product given its nutrient content. Here again, as with the prior 'ABC' process, they were optimistically interested in recovering nitrogen and phosphorus which otherwise was in critically short supply as a raw fertilizer feedstock. Rather ironically, though, their ever-present shortage of fixed nitrogen would shortly have an even more dramatic impact relative to its necessity for manufacturing the munitions which would be needed for World War 1. Germany's acute awareness of this problem led them (i.e., via Fritz Haber's Nobel-winning research) to develop industrial processes for synthesizing ammonia and nitrates...at which point the opportunity or need for recovering nitrogen from sewage largely became a moot issue.

Using fill-and-draw cycling, these latter authors had provided the premier demonstration and pronouncement of activated sludge treatment. Even with viewed in the context of our contemporary operations, their initial experiments were remarkably advanced. Indeed, their presentation addressed such topics such as energy conservation, sludge handling, and the sensitivity of nitrifying organisms to temperature and pH, all of which are still debated in our contemporary literature. Perhaps more importantly, the audience of Ardern and Lockett's presentation immediately recognized the monumental value of their discovery.

## **LAB TO FIELD TRANSFORMATION OF THE ACTIVATED SLUDGE PROCESS:**

1914 -> 1920's

Ardern and Lockett subsequently presented two further papers in 1914 (b) and 1915 which touched on a range of practical issues, including: performance capabilities during continuous-flow and fill-and-draw operation, the detrimental impact of trade wastes, aeration levels using plain tubes and porous tiles, required aeration intensities, and biomass acclimation. The startling fact that it could reliably produce clear, non-odorous effluents had extreme appeal for municipalities long frustrated with their aesthetically unattractive options. Even as Fowler's pioneering research continued, therefore, the process was already being tested on full-scale basis. In fact, at the same 1914 meeting that Ardern and Lockett presented their second paper, Melling (1914) announced that he had successfully applied activated sludge treatment to an 80,000 gallon per day flow at Salford, England.

In quick succession, several full-scale English installations were placed into operation. The following listing provides a chronological summary of these facilities: Salford, 1914, Davyhulme, 1915; Worcester, 1916; Sheffield, 1916; 1917; Stamford, 1917; Tunstall, 1920; Sheffield, 1920; Davyhulme, 1921; and Bury, 1921. In the United States, progression of the activated sludge process moved with similarly amazing speed. Edward Bartow, a Professor at the University of Illinois, visited Fowler's group in Manchester in August of 1914 and subsequently began his own bench-and pilot-scale experiments along the lines established by Fowler's group. Within a period of several months, numerous other American researchers initiated similar studies, including those by Hammond, Hendrick, Hurd, Frank, Mohlman, Hatton, and Pearse. (Maring, 1927; Pearse, 1938; Metcalf & Eddy, 1916;

Babbitt, 1926) Full-scale U.S. installations began to appear to 1916, and by 1927 there were nearly ten full-scale systems spread throughout the country, including: San Marcos (TX), 1916; Milwaukee (WI), 1916; Cleveland (OH), 1916; Houston (TX), 1917 & 1918 (2 each); Des Plaines (IL), 1922; Calumet (IN), 1922; Milwaukee (WI), 1925; and Indianapolis (IN), 1927.

#### **ENTREPRENEURIAL TRANSFORMATION OF ACTIVATED SLUDGE:**

1913 -> 1940's

Within less than a decade, this rudimentary, bench-scale concept had been installed at numerous multi-MGD facilities. Based on its rapid growth during these first few years, it would seem that activated sludge would have become the preeminent wastewater treatment process virtually overnight. However, despite this initial intensity, activated sludge did not truly find widespread application for several decades.

The cause for this delay is quite simple; namely, patent litigation curtailed most of the technical momentum. Whereas Ardern and Lockett presented their research findings in May of 1914, another pair of wastewater entrepreneurs (i.e., Jones and Attwood, Ltd.) had actually beaten them to the punch by nearly a full year, filing four separate patent applications dealing with "Improvements in Apparatus for the Purification of Sewage or other Impure Waters" (UK patents #19915 at 1913; #22952 at 1913; #729 at 1914; and #19916 at 1914). (Jones &

Attwood, 1913ab; 1914; 1915) Of these four, none actually employed the term 'activated sludge'. No. 729 clearly included the basics of the process though, particularly because of its specific reference to solid recycle. Furthermore, the reactor figures provided by this latter patent bear a striking similarity to contemporary looped designs marketed by several proprietors.

Jones and Attwood must also be credited with much of the preliminary work towards establishing the practical application of activated sludge. Several of the original full-scale facilities (e.g. Worcester and Stamford) were, in fact, solely constructed at their expense

and risk as a means to demonstrate its pragmatic merit. In fact, the Worcester system was designed and installed under a performance-based contract based on effluent quality.

The patent situation for activated sludge became even more complex in 1915 when Leslie Frank, a U.S. Public Health Officer, obtained an American Patent (#1,139,024) which covered much the same material as the Jones and Attwood claims. (Frank, 1915) Frank, however, dedicated his patent for "activated sludge" (the misspelling reflects Frank's terminology) to all U.S. citizens. Hence, at this point, there were two different patent entities dealing with activated sludge. Aside from these legal claims, Fowler's own standing as the originator of activated sludge was also being disputed by Clark at Lawrence. (Clark, 1915; Mohlman 1938; Greeley, 1945) However, despite this confusion regarding the legal status and origination of activated sludge, the American engineering community pushed ahead with its technical application.

In late 1914, Jones and Attwood, Ltd. Warned American engineers and cities that they should use caution regarding patent infringements. (Hatton, 1916) And when American engineers took credit for certain innovations which transgressed into their (i.e. Jones and Attwood, Ltd) patented procedures (e.g., Clarence Hurd's announcement of the spiral-flow aeration pattern being used at Indianapolis), they were quickly rebuffed by the Jones and Attwood group. (Hurd, 1929; Sandford, 1929) But as more and more plants were built, municipal concerns about patent problems and complications diminished.

This mood quickly changed, though, with a suit filed by Activated Sludge, Ltd. (the licensed patentee for Jones and Attwood, Ltd.) against Chicago in the late 1920's. (Anonymous, 1933) Additional suits against Milwaukee, Cleveland, Indianapolis, and several smaller cities soon followed. Legal rulings on all of these cases took several years, during which time the sanitary engineering profession seriously reassessed the prospects for near-term activated sludge utilization. In 1933, District Judge Geiger ruled that Milwaukee had, indeed, violated patents held by Activated Sludge, Ltd. (Anonymous, 1934a,b) An appeal was submitted, but in October, 1934 the Supreme Court declined to rule against this decision.

In reflecting upon this outcome, Bloodgood (1982) indicated a belief that the District Judge ruled against Milwaukee more so because of their outspoken lawyer than the involved legal details. Whatever the case, the infringement ruling immediately rippled throughout the country. Several existing plants quickly shut down to avoid monetary fines, including the original San Marcos, Texas facility. (Otts, 1982) Many others chose to continue their use of the activated sludge process based on a royalty fee of 25 cents per capita. Amongst the 203 plants, Kappe (1938) reported that 150 were licensed by Activated Sludge, Ltd. (Kappe, 1938) As for the large number of communities planning to install new activated sludge plants, most simply elected either to build an alternative system (oftentimes a trickling filter) or to wait until the applicable patents expired (e.g. Washington, D.C. was a prime example).

Milwaukee and Chicago appear to have suffered the largest losses with each being fined just under one million dollars (Activated Sludge, Inc., 1946) In Milwaukee's case, these

monies were secured from the proceeds on a relatively new (i.e. since 1926) sludge product, Milorganite, whose annual sales in 1934 were estimated at 3 million dollars. In retrospect, Chicago probably wishes it had accepted the terms of an out-of-court settlement offered by Activated Sludge, Ltd. (Activated Sludge, Inc., 1946) Rather than paying for the imposed fine and several years of legal involvement, the case could have been settled with a \$90,000 settlement.

### **ACTIVATED SLUDGE SUPREMACY:**

1950's -> present

Once the business of building wastewater treatment plants hit its peak in the United States following World War II, the activated sludge process quickly became the dominant design approach for secondary systems...and this 'supremacy' remains in effect to this day. Had it not been for the litigation stemming from its original British patents, this transition from fixed film processes would probably have moved even faster. At this point in time, though, activated sludge has proven itself to be durable technology in an era where most engineering methods lapse into obsolescence only decades, if not years, after their original development.

### **SUMMARY**

Sixteen years ago Frank Schaumburg published this 'Figure' as a stand-alone paper with the *Journal of the Water Pollution Control Federation* (**NOTE:** Even today, it is still considered to be one of the most succinct publications ever carried on the topic of activated sludge!). Entitled, "65 Years of Efficiency Progress in Activated Sludge," the late Professor Schaumburg's goal was to visually (and probably sarcastically) demonstrate - the fact that the performance levels achieved with activated sludge (i.e., BOD removal efficiencies) have changed extremely little over the decades in spite of considerable research and publication on the topic! It worked well when first developed, it works about the same today, and it should serve our needs for many more years. Ironically, though, the problem of handling the resultant sludge, which Melling cited as their "*greatest bugabear*" while commenting on the landmark paper in 1914, still remains a distinct challenge!

### **ACKNOWLEDGMENTS**

The figures included within this text were respectively scanned from the following sources:

**-Pg. 1, *Punch*, pg. 41,31 July 1858;**



**-Pg. 2, top**, Reyburn, W. (1989). "*Flushed with Pride*," Pavilion Books Limited, London, UK;

**-Pg. 2, bottom**, *Punch*, pg. 71, 14 August 1858;

**-Pg. 3**, Minutes of Evidence, Royal Commission on Metropolitan Sewage Discharge, Vol. III,

From May 1884 to October 1884 (1885);

**-Pg. 4**, Ardern, E. and Lockett, W.T. (1914). "Experiments on the Oxidation of Sewage Without the

Aid of Filters." *Journal of the Society of Chemical Industry*, 33, pg. 524, 30 May;

**-Pg. 7**, Schaumburg, F. and Marsh, B.E. (1980), "65 Years of Efficiency Progress in Activated

Sludge," *Journal of the Water Pollution Control Federation*, 51, pg.1.