



Residential Fall Protection

Presented By:

Consultation Education and Training (CET) Division
Michigan Occupational Safety and Health Administration
Michigan Department of Labor and Economic Opportunity

www.michigan.gov/miosha

517-284-7720

Table of Contents

| | |
|--|----|
| PowerPoint Presentation | 1 |
| Fall Protection Standard – Part 45 | 25 |
| Enforcement Policy | 67 |
| Sample Fall Protection Plan for Residential Construction Work..... | 73 |
| MIOSHA Fact Sheets | |
| Highlights of the Fall Protection Standard | 79 |
| Falls – Unprotected Sides, Wall Openings, and Floor Holes..... | 80 |

PowerPoint Presentation



Fall Protection in Residential Construction

Consultation Education and Training (CET) Division
Michigan Occupational Safety and Health Administration
www.michigan.gov/miosha
(517) 284-7720



1

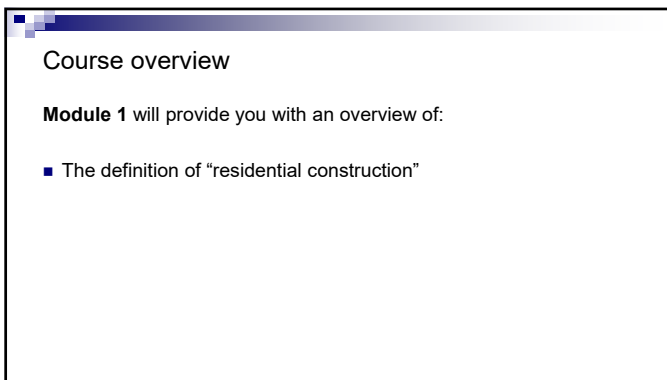

Course overview

Module 1 will provide you with an overview of:

- The definition of "residential construction"

2

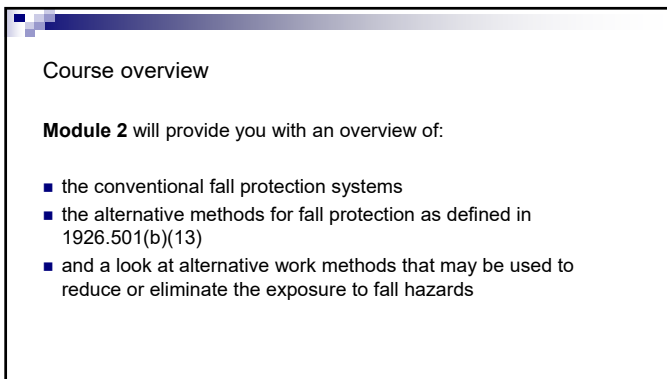

Course overview

Module 2 will provide you with an overview of:

- the conventional fall protection systems
- the alternative methods for fall protection as defined in 1926.501(b)(13)
- and a look at alternative work methods that may be used to reduce or eliminate the exposure to fall hazards

3

Course overview

Module 3 will provide you with an overview of:

- when it is appropriate to implement and use a Fall Protection Plan
- MIOSHA's stance on feasibility
- the key components of a Fall Protection Plan
- the job hazard analysis (JHA)
- the definitions of a Qualified Person and a Competent Person

4

Attention:

Employers must know that the:

- examples of fall protection shown in the photographs contained in this presentation do not represent all possible work methods that can be used in residential construction
- examples of fall protection in the photographs in this presentation may not be suitable in all situations
- employer is responsible for ensuring compliance with all applicable MIOSHA requirements

5

**Module 1:
Defining Residential Construction**

6

Construction is dangerous: Total fatalities

- 5190 Total fatal injuries in the workplace in the USA in 2021*
- 986 Construction fatalities
- 390 Construction fatal falls
- 99 Roofer fatal falls

*Bureau of Labor Statistics 2021 fatal occupational injuries tables.
Note: Due to incomplete reporting it is impossible to know how many or what percentage were residential versus non-residential.

7

Construction is dangerous: Rate of fatalities

Rate of fatal workplace injuries in the workplace in the USA in 2021 per 100,000 workers*

- 3.6 All Industries
- 12.3 All construction
- 59.0 Roofers
- 22.9 Construction "helpers"
- 17.1 Construction supervisors
- 11.9 Equipment operators
- 11.6 Painters

If you are in construction you are nearly 4 times more likely to get killed on the job!

If you are a roofer, you are 16 times more likely to get killed on the job!

8

MIOSHA Construction Safety and Health Standard Part 45. Fall Protection

Rule 1926.501(b)(13): Residential Construction

- Each employee engaged in residential construction activities **6 feet or more above lower levels** shall be protected by guardrail systems, safety net systems, or personal fall arrest system unless another provision in paragraph (b) of this section provides for an alternative fall protection measure.
- Plain language: If you can fall 6 feet or more, you need fall protection to keep that from happening.

9

MIOSHA Part 45. Fall Protection

Rule 1926.501(b)(13): Residential Construction

- Exception: When the employer can demonstrate that it is infeasible or creates a greater hazard to use these systems, the employer shall develop and implement a fall protection plan which meets the requirements of paragraph (k) of 1926.502.
- However, MIOSHA presumes it is feasible and you must demonstrate in writing that it is infeasible.

10

How is "residential" construction defined?

MIOSHA Construction Safety and Health Division Instruction COM 04-1R3 (01/22/2020) defines residential construction as meeting these two requirements:

- 1) the end-use of the structure is required to be a home or dwelling
- 2) and the building in question must be constructed using traditional wood frame construction materials and methods

11

Residential construction definition

Cold-formed metal studs will be considered within the bounds of traditional wood frame construction materials and methods.



12

Residential construction definition



The use of masonry **brick or block** in exterior walls will be treated as falling within the scope of traditional wood frame construction materials and methods.

13

Residential construction definition

Nursing Homes, apartments, and hotels typically involves the use of the following materials in the framework of the structure and would be excluded from the definition as a result.

- Steel I-beams
- Precast Concrete
- Rebar
- Poured Concrete



14

Summary

In this module we looked at the:

- The high frequency of fatalities and serious injuries from falls
- The definition of residential construction

15

Module 2:
What are the acceptable fall protection systems?

16

Objectives

Module 2 will provide you with an overview of:

- the conventional fall protection systems
- the alternative methods for fall protection as defined in 1926.501(b)(13)
- and a look at alternative work methods that may be used to reduce or eliminate the exposure to fall hazards

17

Acceptable fall protection systems

- Guardrail systems
- Safety net systems
- Personal fall arrest systems
- Fall restraint / work positioning systems
- Hole Covers

18

Guardrails



Top rail @ 42" (1' or 2")
Mid-rail @ 21"
Toeboard 3 1/2"

19

Guardrails

- Must support at least 200 pounds.
- This guardrail is not acceptable. The span between supports is too far.



20

Guardrails

- This is safe and in compliance.



21

Guardrails



- Not just safer, but more functional.
- Using the yellow engineered boot allows the drywall to be finished and the walls to be painted



22

Guardrails



- These guardrails can be used while sheathing and roofing
- Limited to lower pitch roofs



23

Guardrails

- Another guardrail option for roofs



24

Safety nets

- Safety nets are not a commonly used option in residential construction
- Perhaps an efficient and cost-effective safety net will be developed as residential contractors and safety equipment manufacturers continue to solve fall protection challenges.

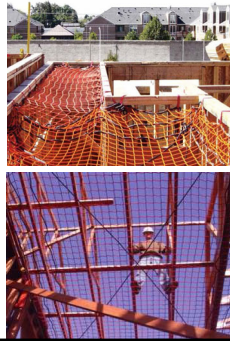

25

Personal fall arrest



26

PFAS: Anchor points

- Must be capable of supporting 5000 pounds

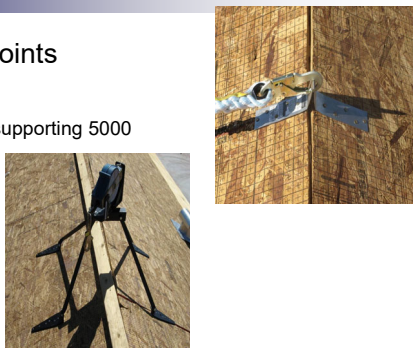

27

PFAS: Anchor points

- So many options



28

PFAS: Anchor points

- There is something for nearly every situation
- Call your MIOSHA CET Consultant or your local Fall Protection vendor if you need ideas



Door jam anchor

Ground-based anchor

29

PFAS: Anchor points

- Choose the location of anchor points to keep yourself in a safe position
- Keep a fairly straight line between the anchor point and the edge
- Do not allow a swing to let you hit the ground or swing into something



Swing Fall Hazard

30

PFAS: Body harness

- Purchase the proper size. One size does not fit all
- D-ring between the shoulder blades
- Leg straps tight
- Inspect it before each shift



31

PFAS: Deceleration device

- Commonly called a "shock absorber"
- Reduces the force applied to your body when you fall to less than 1800 pounds
- Usually reduces the force to under 1000 pounds
- On a lanyard, the shock absorber end should be attached to your harness
- As it deploys, it will extend the distance of your fall by up to 3 ½ feet

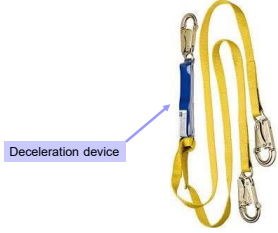

Deceleration device

32

PFAS: Devices to give you working range



Vertical lifeline with ropegrab

Retractable lifeline

Horizontal lifeline

Lanyard

33

PFAS: Fall restraint vs fall arrest



- Fall restraint means you can not fall off the edge
- Use fall restraint when possible
- In this example, keeping the rope grab far enough up the rope makes a fall impossible



34

Hole covers

- Must be able to support twice the intended load
- Must be marked "hole" or "cover"
- Must be secured to prevent accidental displacement
- Used to cover holes greater than 2" in their least dimension



35

Other options for working at heights

- Ladders
- Scaffolding
- Aerial lifts
- Project Planning

36

Work from ladders



37

Work from scaffolding



38

Ladder jacks



- Notice the use of a vertical lifeline and rope grab as fall protection

39

Pump jack scaffolding



- The green end bracket functions as guardrail on the ends of the pick
- The waist level pick and midrail function as guardrail on the back of the scaffold

40

Work from personnel platform on rough terrain fork lift



41

Perform the work from the ground

- These trusses were braced together on the ground then lifted as a single unit
- This limits the amount of work at heights



42

How will this affect your work?

- Any work 6 feet or more above lower levels will require some type of fall protection
- Examples:
 - Foundation form work
 - Installing floor trusses and sheathing
 - Building second floor walls
 - Wall openings, stairs and holes
 - Installing roof trusses and sheathing
 - Roofing (tear-off and installing new shingles)

43

Foundation form work



44

Building second floor walls



45

Installing roof trusses and sheathing



46



47



48



49



50

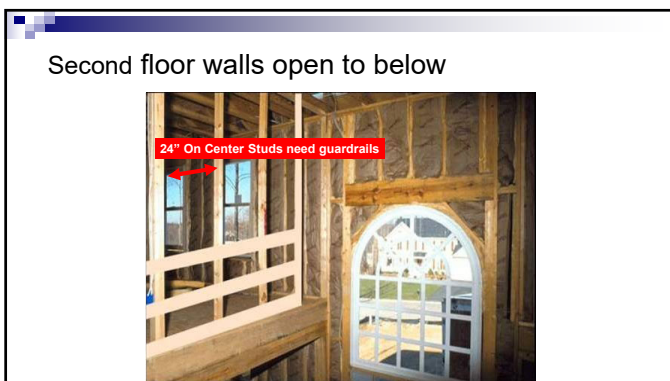

51

Low sill windows (less than 39")



52

Second floor exterior doors

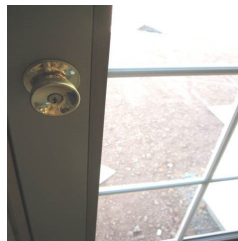
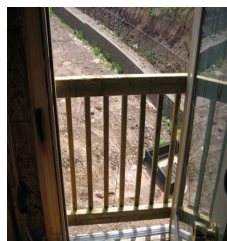

53

Balconies and catwalks



54

Summary

In this module we looked at the:

- the conventional fall protection systems
- the alternative methods for fall protection as defined in 1926.501(b)(13)
- and a look at alternative work methods that may be used to reduce or eliminate the exposure to fall hazards

55

Module 3:
When is it appropriate to use a Fall Protection Plan?

56

Objectives

- Discuss when it is appropriate to implement a fall protection plan
- Discuss MIOSHA's stance on feasibility
- Review the required components of the fall protection plan
- Discuss the Job Hazard Analysis
- Look at the definitions for a qualified person and a competent person

57

Fall Protection Plan

1926.501(b)(13) states an employer may develop and implement a fall protection plan when:

- they can demonstrate that fall protection or other safe methods are infeasible

or

- that it creates a greater hazard to implement one of the systems outlined in 1926.501(b)

58

MIOSHA's Stance

- It is presumed that it is feasible and will not create a greater hazard to implement at least one of the fall protection measures outlined in 1926.501(b)
- The employer has the burden of establishing that it is appropriate to implement a fall protection plan that is compliant with 1926.502(k) for a particular workplace situation

59

Establishing infeasibility or greater hazard

- Do your homework
 - Conduct a Job Hazard Analysis
 - Explore all options
 - Speak with industry experts
 - Consult with MIOSHA
- Last resort
 - Develop and implement a written and site specific fall protection plan meeting the requirements of 1926.502(k)

60

Fall Protection Plan

- Written document
- Developed by a qualified person
- Site specific
- Implemented by a competent person
- Kept up-to-date and available on-site
- Employees trained on the specific plan

61

Fall Protection Plan

- A written document prepared by a qualified person and developed specifically for the site where the residential construction work is being performed
- Changes to the plan must be approved by the qualified person
- A copy of the plan with all approved changes shall be maintained at the job site.

62

Developed by a Qualified Person

Qualified Person:

- A person who by possession of a recognized degree or certificate of professional standing

or

- who, by extensive knowledge, training, and experience, has successfully demonstrated the ability to solve or resolve problems relating to the subject matter and work

63

Fall protection plan

- Site specific
 - A Job Hazard Analysis may be used to meet the site specific requirement when done for each site
 - A written plan developed for the repetitive use for a particular style/model home would be considered **site-specific** with respect to a particular site only if it fully addresses all issues related to fall protection at that site.

64

What is a Job Hazard Analysis?

It is a template that is customized to the job to identify:

- The overall job
- Specific tasks or steps
- Potential hazards for each task or step
- Controls and means for protection
- Sign-off by the workers

65

Fall protection plan

- Written plan must include
 - Reasons why fall protection or alternate work methods are infeasible or pose a greater hazard
 - Alternative measures used to reduce or eliminate fall hazards
 - Specific locations where these alternative measures will be implemented

66

Fall protection plan

- Locations where conventional fall protection cannot be used shall be designated as **Controlled Access Zones** in compliance with 1926.502(g)
- Employees designated to work in a CAZ must be identified in the plan

67

Fall protection plan

- The implementation of the fall protection plan shall be under the supervision of a competent person

Competent Person:

- A person who is experienced and capable of identifying an existing or potential hazard in surroundings, or under working conditions
- and**
- has the authority and knowledge to take prompt corrective measures to eliminate hazards

68

Summary

In this module we:

- Discussed when it is appropriate to implement a fall protection plan
- Discussed MIOSHA's stance on feasibility
- Reviewed the required components of the fall protection plan
- Discussed the job hazard analysis (JHA)
- Looked at the definitions for a qualified person and a competent person

69

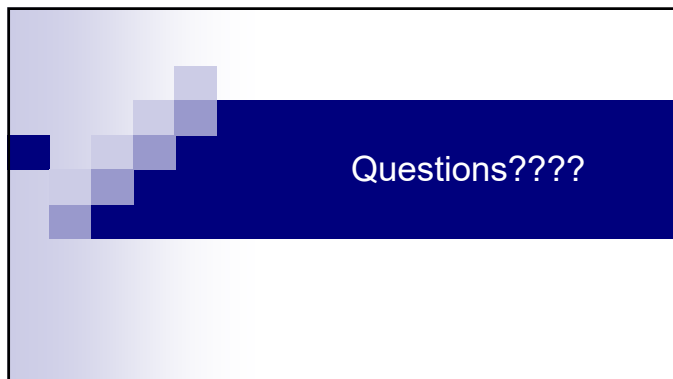

70

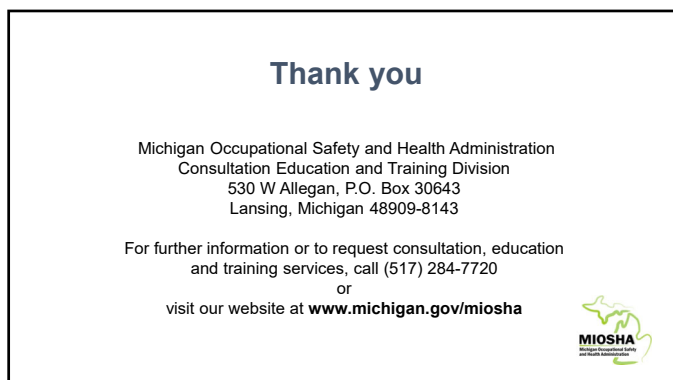

71

Fall Protection Standard Part 45



DEPARTMENT OF LABOR AND ECONOMIC OPPORTUNITY
CONSTRUCTION STANDARD

Filed with the Secretary of State on September 3, 1996 (as amended April 6, 2015)

These rules become effective immediately upon filing with the Secretary of State unless adopted under section 33, 44, or 45a(6) of 1969 PA 306.

Rules adopted under these sections become effective 7 days after filing with the Secretary of State.

(By authority conferred on the director of the department of licensing and regulatory affairs by sections 19 and 21 of 1974 PA 154, MCL 408.1019 and 408.1021, and Executive Reorganization Order Nos. 1996-2, 2003-1, 2008-4, and 2011-4, MCL 445.2001, 445.2011, 445.2025, and 445.2030)

R 408.44501 and R 408.44502 of the Michigan Administrative Code are amended, as follows:

PART 45. FALL PROTECTION

Table of Contents:

R 408.44501 Scope 1
R 408.44502 Adopted and referenced standards..... 2

OSHA FALL PROTECTION

1926.500 Scope, Application, and Definitions
 Applicable to this Subpart..... 4
1926.501 Duty to have Fall Protection..... 7
1926.502 Fall Protection Systems Criteria and
 Practices 9
1926.503 Training Requirements 16

Appendix A - Determining Roof Widths..... 17
Appendix B - Guardrail Systems 22
Appendix C - Personal Fall Arrest Systems 23
Appendix D - Positioning Device Systems 28
Appendix E - Sample Fall Protection Plan 29

R 408.44501 Scope

Rule 4501. (1) The rules in this part set forth the minimum requirements and criteria for fall protection in construction workplaces, their applications, and definitions that are applicable to these rules.

(2) These rules do not apply where an employee is making an inspection, an investigation, or an assessment of workplace conditions before the actual start of construction work or after all construction work has been completed.

(3) The following provisions of the occupational safety and health administration (OSHA) regulations, except as amended in these rules, are adopted by reference in these rules:

(a) 29 C.F.R. § 1926.500 "Scope, Application, and definitions applicable to this subpart."

(b) 29 C.F.R. § 1926.501 "Duty to have fall protection."

(c) 29 C.F.R. § 1926.502 "Fall protection systems criteria and practices."

(d) 29 C.F.R. § 1926.503 "Training requirements."

(4) All of the following provisions are amendments to the OSHA regulations adopted by reference in these rules and are referenced in R 408.44502:

(a) Additional performance requirements for personal climbing equipment, lineman's body belts, safety straps, and lanyards are contained in Construction Safety Standard Part 16. "Power Transmission and Distribution."

(b) The specifications for fall protection requirements for an employee working on certain types of derricks are contained in Construction Safety Standard Part 10. "Lifting and Digging Equipment," and Construction Safety Standard Part 32. "Aerial Work Platforms."

(c) The specifications for fall protection requirements for an employee working on ladders and the performance requirements for stairways, stair rail systems, and handrails are contained in Construction Safety Standard Part 11. "Fixed and Portable Ladders" and Construction Safety Standard Part 21 "Guarding of Walking and Working Areas."

(d) The specifications for fall protection requirements for an employee working on a scaffold; performance requirements for a guardrail system; or for the performance requirements for falling object protection used on scaffolds are contained in Construction Safety Standard Part 12. "Scaffolds and Scaffold Platforms."

(e) The specifications for fall protection requirements for an employee working on or in certain types of equipment used in tunneling operations are contained in Construction Safety Standard Part 14. "Tunnels, Shafts, Caissons, and Cofferdams."

(f) The specifications for fall protection requirements for an employee working from aerial lifts, on poles, towers, or similar structures while engaged in the construction of electric transmission or distribution lines or equipment are contained in Construction Safety Standard Part 32. "Aerial Work Platforms."

(g) The specifications for fall protection requirements for an employee performing steel erection work on buildings are contained in Construction Safety Standard Part 26. "Steel Erection."

R 408.44502 Adopted and referenced standards.

Rule 4502. (1) The following federal occupational safety and health administration (OSHA) regulations are adopted by reference in these rules:

(a) 29 C.F.R. § 1926.500 "Scope, Application, and definitions applicable to this subpart," effective July 10, 2014.

(b) 29 C.F.R. § 1926.501 "Duty to have fall protection," effective January 26, 1995.

(c) 29 C.F.R. § 1926.502 "Fall protection systems criteria and practices," effective January 26, 1995.

(d) 29 C.F.R. § 1926.503 "Training requirements," effective January 26, 1995.

(2) The standards adopted in subrule (1) of this rule are available from the United States Department of Labor, Occupational Safety and Health Administration website: www.osha.gov, at no charge as of the time of adoption of these rules.

(3) The standards adopted in these rules are available for inspection at the Department of Licensing and Regulatory Affairs, MIOSHA Regulatory Services Section, 7150 Harris Drive, Lansing, Michigan, 48909-8143.

(4) The standards adopted in these rules may be obtained from the publisher or may be obtained from the Department of Licensing and Regulatory Affairs, MIOSHA Regulatory Services Section, 7150 Harris Drive, P.O. Box 30643, Lansing, Michigan, 48909-8143, plus \$20.00 for shipping and handling.

(5) The following Michigan occupational safety and health (MIOSHA) standards are referenced in these rules. Up to 5 copies of these standards may be obtained at no charge from the Michigan Department of Licensing and Regulatory Affairs, MIOSHA Regulatory Services Section, 7150 Harris Drive, P.O. Box 30643, Lansing, Michigan, 48909-8143 or via the internet at website: www.michigan.gov/mioshastandards. For quantities greater than 5, the cost, as of the time of adoption of these rules, is 4 cents per page.

(a) Construction Safety Standard Part 10. "Lifting and Digging Equipment," R 408.41001 to R 408.41099a.

(b) Construction Safety Standard Part 11. "Fixed and Portable Ladders," R 408.41101 to R 408.41140.

(c) Construction Safety Standard Part 12. "Scaffolds and Scaffold Platforms," R 408.41201 to R 408.41264.

(d) Construction Safety Standard Part 14. "Tunnels, Shafts, Caissons, and Cofferdams," R 408.41401 to R 408.41483.

(e) Construction Safety Standard Part 16. "Power Transmission and Distribution," R 408.41601 to R 408.41658.

(f) Construction Safety Standard Part 21. "Guarding of Walking and Working Areas," R 408.42101 to R 408.42160.

(g) Construction Safety Standard Part 26. "Steel Erection," R 408.42601 to R 408.42656.

(h) Construction Safety Standard Part 32. "Aerial Work Platforms," R 408.43201 to R 408.43220.

Table of Contents for Adopted OSHA Rules:

| | |
|---|----|
| OSHA FALL PROTECTION | 4 |
| 1926.500 SCOPE, APPLICATION, AND DEFINITIONS APPLICABLE TO THIS SUBPART | 4 |
| 1926.500(a) Scope and application..... | 4 |
| 1926.500(b) Definitions. | 4 |
| 1926.501 DUTY TO HAVE FALL PROTECTION | 7 |
| 1926.501(a) "General." | 7 |
| 1926.501(b) | 7 |
| 1926.501(c) "Protection from falling objects." | 8 |
| 1926.502 FALL PROTECTION SYSTEMS CRITERIA AND PRACTICES | 9 |
| 1926.502(a) "General." | 9 |
| 1926.502(b) "Guardrail systems." | 9 |
| 1926.502(c) "Safety net systems." | 10 |
| 1926.502(d) "Personal fall arrest systems." | 10 |
| 1926.502(e) "Positioning device systems." | 12 |
| 1926.502(f) "Warning line systems." | 12 |
| 1926.502(g) "Controlled access zones." | 13 |
| 1926.502(h) "Safety monitoring systems." | 14 |
| 1926.502(i) "Covers." | 14 |
| 1926.502(j) "Protection from falling objects." | 14 |
| 1926.502(k) "Fall protection plan." | 15 |
| 1926.503 TRAINING REQUIREMENTS | 16 |
| 1926.503(a) "Training Program." | 16 |
| 1926.503(b) "Certification of training." | 16 |
| 1926.503(c) "Retraining." | 16 |
| | |
| APPENDIX A - DETERMINING ROOF WIDTHS | |
| NON-MANDATORY GUIDELINES FOR COMPLYING WITH 1926.501(B)(10) | 17 |
| Example A - Rectangular Shaped Roofs | 17 |
| Example B - Sloped Rectangular Shaped Roofs | 17 |
| Example C - Irregularly Shaped Roofs With Rectangular Shaped Sections | 18 |
| Example D - Separate, Non-Contiguous Roof Areas..... | 19 |
| Example E - Roofs With Penthouses, Open Courtyards, Additional Floors, Etc. | 20 |
| Example F - Irregular, Non-Rectangular Shaped Roofs | 21 |
| APPENDIX B - GUARDRAIL SYSTEMS | |
| NON-MANDATORY GUIDELINES FOR COMPLYING WITH 1926.502(B) | 22 |
| (1) For wood railings | 22 |
| (2) For pipe railings | 22 |
| (3) For structural steel railings | 22 |
| APPENDIX C - PERSONAL FALL ARREST SYSTEMS | |
| NON-MANDATORY GUIDELINES FOR COMPLYING WITH 1926.502(D) | 23 |
| I. Test methods for personal fall arrest systems and positioning device systems..... | 23 |
| II. Additional non-mandatory guidelines for personal fall arrest systems. | 24 |
| APPENDIX D - POSITIONING DEVICE SYSTEMS | |
| NON-MANDATORY GUIDELINES FOR COMPLYING WITH 1926.502(E) | 28 |
| I. Testing Methods For Positioning Device Systems. | 28 |
| II. Inspection Considerations. | 28 |
| APPENDIX E SAMPLE FALL PROTECTION PLAN | |
| NON-MANDATORY GUIDELINES FOR COMPLYING WITH 1926.502(K) | 29 |
| I. Statement of Company Policy..... | 29 |
| II. Fall Protection Systems to Be Used on This Project | 30 |
| III. Implementation of Fall Protection Plan | 32 |
| IV. Conventional Fall Protection Considered for the Point of Erection or Leading Edge Erection Operations | 33 |
| V. Other Fall Protection Measures Considered for This Job | 38 |
| VI. Enforcement | 38 |
| VII. Accident Investigations | 38 |
| VIII. Changes to Plan | 38 |
| IV. Accident Investigations | 41 |
| V. Changes to Plan | 41 |

OSHA FALL PROTECTION

1926.500

SCOPE, APPLICATION, AND DEFINITIONS APPLICABLE TO THIS SUBPART

1926.500(a) Scope and application.

- 1926.500(a)(1) This subpart sets forth requirements and criteria for fall protection in construction workplaces covered under 29 CFR part 1926. Exception: The provisions of this subpart do not apply when employees are making an inspection, investigation, or assessment of workplace conditions prior to the actual start of construction work or after all construction work has been completed.
- 1926.500(a)(2) Section 1926.501 sets forth those workplaces, conditions, operations, and circumstances for which fall protection shall be provided except as follows:
- 1926.500(a)(2)(i) Requirements relating to fall protection for employees working on scaffolds are provided in subpart L of this part.
- 1926.500(a)(2)(ii) Requirements relating to fall protection for employees working on cranes and derricks are provided in subpart CC of this part.
- 1926.500(a)(2)(iii) Fall protection requirements for employees performing steel erection work (except for towers and tanks) are provided in subpart R of this part.
- 1926.500(a)(2)(iv) Requirements relating to fall protection for employees working on certain types of equipment used in tunneling operations are provided in subpart S of this part.
- 1926.500(a)(2)(v) Requirements relating to fall protection for employees engaged in the erection of tanks and communication and broadcast towers are provided in § 1926.105.
- 1926.500(a)(2)(vi) Subpart V of this part provides requirements relating to fall protection for employees working from aerial lifts or on poles, towers, or similar structures while engaged in the construction of electric transmission or distribution lines or equipment.
- 1926.500(a)(2)(vii) Requirements relating to fall protection for employees working on stairways and ladders are provided in subpart X of this part.
- 1926.500(a)(3) Section 1926.502 sets forth the requirements for the installation, construction, and proper use of fall protection required by part 1926, except as follows:
- 1926.500(a)(3)(i) Performance requirements for guardrail systems used on scaffolds and performance requirements for falling object protection used on scaffolds are provided in subpart L of this part.
- 1926.500(a)(3)(ii) Performance requirements for stairways, stairrail systems, and handrails are provided in subpart X of this part.
- 1926.500(a)(3)(iii) Additional performance requirements for fall arrest and workpositioning equipment are provided in Subpart V of this part.
- 1926.500(a)(3)(iv) Section 1926.502 does not apply to the erection of tanks and communication and broadcast towers. (Note: Section 1926.104 sets the criteria for body belts, lanyards and lifelines used for fall protection during tank and communication and broadcast tower erection. Paragraphs (b), (c) and (f) of § 1926.107 provide definitions for the pertinent terms.) 1926.500(a)(3)(v) Criteria for steps, handholds, ladders, and grabrails/guardrails/railings required by subpart CC are provided in subpart CC. Sections 1926.502(a), (c) through (e), and (i) apply to activities covered under subpart CC unless otherwise stated in subpart CC. No other paragraphs of § 1926.502 apply to subpart CC.
- 1926.500(a)(4) Section 1926.503 sets forth requirements for training in the installation and use of fall protection systems, except in relation to steel erection activities and the use of equipment covered by subpart CC.

1926.500(b) Definitions.

Anchorage means a secure point of attachment for lifelines, lanyards or deceleration devices.

Body belt (safety belt) means a strap with means both for securing it about the waist and for attaching it to a lanyard, lifeline, or deceleration device.

Body harness means straps which may be secured about the employee in a manner that will distribute the fall arrest forces over at least the thighs, pelvis, waist, chest and shoulders with means for attaching it to other components of a personal fall arrest system.

Buckle means any device for holding the body belt or body harness closed around the employee's body.

Connector means a device which is used to couple (connect) parts of the personal fall arrest system and positioning device systems together. It may be an independent component of the system, such as a carabiner, or it may be an integral component of part of the system (such as a buckle or dee-ring sewn into a body belt or body harness, or a snap-hook spliced or sewn to a lanyard or self-retracting lanyard).

Controlled access zone (CAZ) means an area in which certain work (e.g., overhand bricklaying) may take place without the use of guardrail systems, personal fall arrest systems, or safety net systems and access to the zone is controlled.

- Dangerous equipment* means equipment (such as pickling or galvanizing tanks, degreasing units, machinery, electrical equipment, and other units) which, as a result of form or function, may be hazardous to employees who fall onto or into such equipment.
- Deceleration device* means any mechanism, such as a rope grab, rip-stitch lanyard, specially-woven lanyard, tearing or deforming lanyards, automatic self-retracting lifelines/lanyards, etc., which serves to dissipate a substantial amount of energy during a fall arrest, or otherwise limit the energy imposed on an employee during fall arrest.
- Deceleration distance* means the additional vertical distance a falling employee travels, excluding lifeline elongation and free fall distance, before stopping, from the point at which the deceleration device begins to operate. It is measured as the distance between the location of an employee's body belt or body harness attachment point at the moment of activation (at the onset of fall arrest forces) of the deceleration device during a fall, and the location of that attachment point after the employee comes to a full stop.
- Equivalent* means alternative designs, materials, or methods to protect against a hazard which the employer can demonstrate will provide an equal or greater degree of safety for employees than the methods, materials or designs specified in the standard.
- Failure* means load refusal, breakage, or separation of component parts. Load refusal is the point where the ultimate strength is exceeded.
- Free fall* means the act of falling before a personal fall arrest system begins to apply force to arrest the fall.
- Free fall distance* means the vertical displacement of the fall arrest attachment point on the employee's body belt or body harness between onset of the fall and just before the system begins to apply force to arrest the fall. This distance excludes deceleration distance, and lifeline/lanyard elongation, but includes any deceleration device slide distance or self-retracting lifeline/lanyard extension before they operate and fall arrest forces occur.
- Guardrail system* means a barrier erected to prevent employees from falling to lower levels.
- Hole* means a gap or void 2 inches (5.1 cm) or more in its least dimension, in a floor, roof, or other walking/working surface.
- Infeasible* means that it is impossible to perform the construction work using a conventional fall protection system (i.e., guardrail system, safety net system, or personal fall arrest system) or that it is technologically impossible to use any one of these systems to provide fall protection.
- Lanyard* means a flexible line of rope, wire rope, or strap which generally has a connector at each end for connecting the body belt or body harness to a deceleration device, lifeline, or anchorage.
- Leading edge* means the edge of a floor, roof, or formwork for a floor or other walking/working surface (such as the deck) which changes location as additional floor, roof, decking, or formwork sections are placed, formed, or constructed. A leading edge is considered to be an "unprotected side and edge" during periods when it is not actively and continuously under construction.
- Lifeline* means a component consisting of a flexible line for connection to an anchorage at one end to hang vertically (vertical lifeline), or for connection to anchorages at both ends to stretch horizontally (horizontal lifeline), and which serves as a means for connecting other components of a personal fall arrest system to the anchorage.
- Low-slope roof* means a roof having a slope less than or equal to 4 in 12 (vertical to horizontal).
- Lower levels* means those areas or surfaces to which an employee can fall. Such areas or surfaces include, but are not limited to, ground levels, floors, platforms, ramps, runways, excavations, pits, tanks, material, water, equipment, structures, or portions thereof.
- Mechanical equipment* means all motor or human propelled wheeled equipment used for roofing work, except wheelbarrows and mopcars.
- Opening* means a gap or void 30 inches (76 cm) or more high and 18 inches (48 cm) or more wide, in a wall or partition, through which employees can fall to a lower level.
- Overhand bricklaying and related work* means the process of laying bricks and masonry units such that the surface of the wall to be jointed is on the opposite side of the wall from the mason, requiring the mason to lean over the wall to complete the work. Related work includes mason tending and electrical installation incorporated into the brick wall during the overhand bricklaying process.
- Personal fall arrest system* means a system used to arrest an employee in a fall from a working level. It consists of an anchorage, connectors, a body belt or body harness and may include a lanyard, deceleration device, lifeline, or suitable combinations of these. As of January 1, 1998, the use of a body belt for fall arrest is prohibited.
- Positioning device system* means a body belt or body harness system rigged to allow an employee to be supported on an elevated vertical surface, such as a wall, and work with both hands free while leaning.
- Rope grab* means a deceleration device which travels on a lifeline and automatically, by friction, engages the lifeline and locks so as to arrest the fall of an employee. A rope grab usually employs the principle of inertial locking, cam/level locking, or both.
- Roof* means the exterior surface on the top of a building. This does not include floors or formwork which, because a building has not been completed, temporarily become the top surface of a building.
- Roofing work* means the hoisting, storage, application, and removal of roofing materials and equipment, including related insulation, sheet metal, and vapor barrier work, but not including the construction of the roof deck.

Safety-monitoring system means a safety system in which a competent person is responsible for recognizing and warning employees of fall hazards.

Self-retracting lifeline/lanyard means a deceleration device containing a drum-wound line which can be slowly extracted from, or retracted onto, the drum under slight tension during normal employee movement, and which, after onset of a fall, automatically locks the drum and arrests the fall.

Snaphook means a connector comprised of a hook-shaped member with a normally closed keeper, or similar arrangement, which may be opened to permit the hook to receive an object and, when released, automatically closes to retain the object. Snaphooks are generally one of two types:

1926.500(b)(1) The locking type with a self-closing, self-locking keeper which remains closed and locked until unlocked and pressed open for connection or disconnection; or

1926.500(b)(2) The non-locking type with a self-closing keeper which remains closed until pressed open for connection or disconnection. As of January 1, 1998, the use of a non-locking snaphook as part of personal fall arrest systems and positioning device systems is prohibited.

Steep roof means a roof having a slope greater than 4 in 12 (vertical to horizontal).

Toeboard means a low protective barrier that will prevent the fall of materials and equipment to lower levels and provide protection from falls for personnel.

Unprotected sides and edges means any side or edge (except at entrances to points of access) of a walking/working surface, e.g., floor, roof, ramp, or runway where there is no wall or guardrail system at least 39 inches (1.0 m) high.

Walking/working surface means any surface, whether horizontal or vertical on which an employee walks or works, including, but not limited to, floors, roofs, ramps, bridges, runways, formwork and concrete reinforcing steel but not including ladders, vehicles, or trailers, on which employees must be located in order to perform their job duties.

Warning line system means a barrier erected on a roof to warn employees that they are approaching an unprotected roof side or edge, and which designates an area in which roofing work may take place without the use of guardrail, body belt, or safety net systems to protect employees in the area.

Work area means that portion of a walking/working surface where job duties are being performed.

[44 FR 8577, Feb. 9, 1979; 44 FR 20940, Apr. 6, 1979, as amended at 45 FR 75625, Nov. 14, 1980; 55 FR 47687, Nov. 14, 1990; 59 FR 40730, Aug. 9, 1994; 60 FR 5131, Jan. 26, 1995; 60 FR 39254, Aug. 2, 1995; 66 FR 5265, Jan. 18, 2001; 75 FR 48133, Aug. 9, 2010; 79 FR 20696, July 10, 2014]

1926.501 DUTY TO HAVE FALL PROTECTION

1926.501(a) "General."

1926.501(a)(1) This section sets forth requirements for employers to provide fall protection systems. All fall protection required by this section shall conform to the criteria set forth in 1926.502 of this subpart.

1926.501(a)(2) The employer shall determine if the walking/working surfaces on which its employees are to work have the strength and structural integrity to support employees safely. Employees shall be allowed to work on those surfaces only when the surfaces have the requisite strength and structural integrity.

1926.501(b)

1926.501(b)(1) "Unprotected sides and edges." Each employee on a walking/working surface (horizontal and vertical surface) with an unprotected side or edge which is 6 feet (1.8 m) or more above a lower level shall be protected from falling by the use of guardrail systems, safety net systems, or personal fall arrest systems.

1926.501(b)(2) "Leading edges."

1926.501(b)(2)(i) Each employee who is constructing a leading edge 6 feet (1.8 m) or more above lower levels shall be protected from falling by guardrail systems, safety net systems, or personal fall arrest systems. Exception: When the employer can demonstrate that it is infeasible or creates a greater hazard to use these systems, the employer shall develop and implement a fall protection plan which meets the requirements of paragraph (k) of 1926.502.

Note: There is a presumption that it is feasible and will not create a greater hazard to implement at least one of the above-listed fall protection systems. Accordingly, the employer has the burden of establishing that it is appropriate to implement a fall protection plan which complies with 1926.502(k) for a particular workplace situation, in lieu of implementing any of those systems.

1926.501(b)(2)(ii) Each employee on a walking/working surface 6 feet (1.8 m) or more above a lower level where leading edges are under construction, but who is not engaged in the leading-edge work, shall be protected from falling by a guardrail system, safety net system, or personal fall arrest system. If a guardrail system is chosen to provide the fall protection, and a controlled access zone has already been established for leading edge work, the control line may be used in lieu of a guardrail along the edge that parallels the leading edge.

1926.501(b)(3) "Hoist areas." Each employee in a hoist area shall be protected from falling 6 feet (1.8 m) or more to lower levels by guardrail systems or personal fall arrest systems. If guardrail systems, [or chain, gate, or guardrail] or portions thereof, are removed to facilitate the hoisting operation (e.g., during landing of materials), and an employee must lean through the access opening or out over the edge of the access opening (to receive or guide equipment and materials, for example), that employee shall be protected from fall hazards by a personal fall arrest system.

1926.501(b)(4) "Holes."

1926.501(b)(4)(i) Each employee on walking/working surfaces shall be protected from falling through holes (including skylights) more than 6 feet (1.8 m) above lower levels, by personal fall arrest systems, covers, or guardrail systems erected around such holes.

1926.501(b)(4)(ii) Each employee on a walking/working surface shall be protected from tripping in or stepping into or through holes (including skylights) by covers.

1926.501(b)(4)(iii) Each employee on a walking/working surface shall be protected from objects falling through holes (including skylights) by covers.

1926.501(b)(5) "Formwork and reinforcing steel." Each employee on the face of formwork or reinforcing steel shall be protected from falling 6 feet (1.8 m) or more to lower levels by personal fall arrest systems, safety net systems, or positioning device systems.

1926.501(b)(6) "Ramps, runways, and other walkways." Each employee on ramps, runways, and other walkways shall be protected from falling 6 feet (1.8 m) or more to lower levels by guardrail systems.

1926.501(b)(7) "Excavations."

1926.501(b)(7)(i) Each employee at the edge of an excavation 6 feet (1.8 m) or more in depth shall be protected from falling by guardrail systems, fences, or barricades when the excavations are not readily seen because of plant growth or other visual barrier;

1926.501(b)(7)(ii) Each employee at the edge of a well, pit, shaft, and similar excavation 6 feet (1.8 m) or more in depth shall be protected from falling by guardrail systems, fences, barricades, or covers.

1926.501(b)(8) "Dangerous equipment."

1926.501(b)(8)(i) Each employee less than 6 feet (1.8 m) above dangerous equipment shall be protected from falling into or onto the dangerous equipment by guardrail systems or by equipment guards.

1926.501(b)(8)(ii) Each employee 6 feet (1.8 m) or more above dangerous equipment shall be protected from fall hazards by guardrail systems, personal fall arrest systems, or safety net systems.

1926.501(b)(9) "Overhand bricklaying and related work."

1926.501(b)(9)(i) Except as otherwise provided in paragraph (b) of this section, each employee performing overhand bricklaying and related work 6 feet (1.8 m) or more above lower levels, shall be protected from falling by guardrail systems, safety net systems, personal fall arrest systems, or shall work in a controlled access zone.

1926.501(b)(9)(ii) Each employee reaching more than 10 inches (25 cm) below the level of the walking/working surface on which they are working, shall be protected from falling by a guardrail system, safety net system, or personal fall arrest system.

Note: Bricklaying operations performed on scaffolds are regulated by subpart L - Scaffolds of this part.

1926.501(b)(10) "Roofing work on Low-slope roofs." Except as otherwise provided in paragraph (b) of this section, each employee engaged in roofing activities on low-slope roofs, with unprotected sides and edges 6 feet (1.8 m) or more above lower levels shall be protected from falling by guardrail systems, safety net systems, personal fall arrest systems, or a combination of warning line system and guardrail system, warning line system and safety net system, or warning line system and personal fall arrest system, or warning line system and safety monitoring system. Or, on roofs 50-feet (15.25 m) or less in width (see Appendix A to subpart M of this part), the use of a safety monitoring system alone [i.e. without the warning line system] is permitted.

1926.501(b)(11) "Steep roofs." Each employee on a steep roof with unprotected sides and edges 6 feet (1.8 m) or more above lower levels shall be protected from falling by guardrail systems with toeboards, safety net systems, or personal fall arrest systems.

1926.501(b)(12) "Precast concrete erection." Each employee engaged in the erection of precast concrete members (including, but not limited to the erection of wall panels, columns, beams, and floor and roof "tees") and related operations such as grouting of precast concrete members, who is 6 feet (1.8 m) or more above lower levels shall be protected from falling by guardrail systems, safety net systems, or personal fall arrest systems, unless another provision in paragraph (b) of this section provides for an alternative fall protection measure. Exception: When the employer can demonstrate that it is infeasible or creates a greater hazard to use these systems, the employer shall develop and implement a fall protection plan which meets the requirements of paragraph (k) of 1926.502.

Note: There is a presumption that it is feasible and will not create a greater hazard to implement at least one of the above-listed fall protection systems. Accordingly, the employer has the burden of establishing that it is appropriate to implement a fall protection plan which complies with 1926.502(k) for a particular workplace situation, in lieu of implementing any of those systems.

1926.501(b)(13) "Residential construction." Each employee engaged in residential construction activities 6 feet (1.8 m) or more above lower levels shall be protected by guardrail systems, safety net system, or personal fall arrest system unless another provision in paragraph (b) of this section provides for an alternative fall protection measure. Exception: When the employer can demonstrate that it is infeasible or creates a greater hazard to use these systems, the employer shall develop and implement a fall protection plan which meets the requirements of paragraph (k) of 1926.502.

Note: There is a presumption that it is feasible and will not create a greater hazard to implement at least one of the above-listed fall protection systems. Accordingly, the employer has the burden of establishing that it is appropriate to implement a fall protection plan which complies with 1926.502(k) for a particular workplace situation, in lieu of implementing any of those systems.

1926.501(b)(14) "Wall openings." Each employee working on, at, above, or near wall openings (including those with chutes attached) where the outside bottom edge of the wall opening is 6 feet (1.8 m) or more above lower levels and the inside bottom edge of the wall opening is less than 39 inches (1.0 m) above the walking/working surface, shall be protected from falling by the use of a guardrail system, a safety net system, or a personal fall arrest system.

1926.501(b)(15) "Walking/working surfaces not otherwise addressed." Except as provided in 1926.500(a)(2) or in 1926.501 (b)(1) through (b)(14), each employee on a walking/working surface 6 feet (1.8 m) or more above lower levels shall be protected from falling by a guardrail system, safety net system, or personal fall arrest system.

1926.501(c) "Protection from falling objects."

When an employee is exposed to falling objects, the employer shall have each employee wear a hard hat and shall implement one of the following measures:

1926.501(c)(1) Erect toeboards, screens, or guardrail systems to prevent objects from falling from higher levels; or,

1926.501(c)(2) Erect a canopy structure and keep potential fall objects far enough from the edge of the higher level so that those objects would not go over the edge if they were accidentally displaced; or,

1926.501(c)(3) Barricade the area to which objects could fall, prohibit employees from entering the barricaded area, and keep objects that may fall far enough away from the edge of a higher level so that those objects would not go over the edge if they were accidentally displaced.

[59 FR 40732, Aug. 9, 1994; 60 FR 5131, Jan. 26, 1995]

1926.502 FALL PROTECTION SYSTEMS CRITERIA AND PRACTICES

1926.502(a) "General."

- 1926.502(a)(1) Fall protection systems required by this part shall comply with the applicable provisions of this section.
- 1926.502(a)(2) Employers shall provide and install all fall protection systems required by this subpart for an employee, and shall comply with all other pertinent requirements of this subpart before that employee begins the work that necessitates the fall protection.

1926.502(b) "Guardrail systems."

Guardrail systems and their use shall comply with the following provisions:

- 1926.502(b)(1) Top edge height of top rails, or equivalent guardrail system members, shall be 42 inches (1.1 m) plus or minus 3 inches (8 cm) above the walking/working level. When conditions warrant, the height of the top edge may exceed the 45-inch height, provided the guardrail system meets all other criteria of this paragraph.
- Note: When employees are using stilts, the top edge height of the top rail, or equivalent member, shall be increased an amount equal to the height of the stilts.
- 1926.502(b)(2) Midrails, screens, mesh, intermediate vertical members, or equivalent intermediate structural members shall be installed between the top edge of the guardrail system and the walking/working surface when there is no wall or parapet wall at least 21 inches (53 cm) high.
- 1926.502(b)(2)(i) Midrails, when used, shall be installed at a height midway between the top edge of the guardrail system and the walking/working level.
- 1926.502(b)(2)(ii) Screens and mesh, when used, shall extend from the top rail to the walking/working level and along the entire opening between top rail supports.
- 1926.502(b)(2)(iii) Intermediate members (such as balusters), when used between posts, shall be not more than 19 inches (48 cm) apart.
- 1926.502(b)(2)(iv) Other structural members (such as additional midrails and architectural panels) shall be installed such that there are no openings in the guardrail system that are more than 19 inches (.5 m) wide.
- 1926.502(b)(3) Guardrail systems shall be capable of withstanding, without failure, a force of at least 200 pounds (890 N) applied within 2 inches (5.1 cm) of the top edge, in any outward or downward direction, at any point along the top edge.
- 1926.502(b)(4) When the 200-pound (890 N) test load specified in paragraph (b)(3) of this section is applied in a downward direction, the top edge of the guardrail shall not deflect to a height less than 39 inches (1.0 m) above the walking/working level. Guardrail system components selected and constructed in accordance with the Appendix B to subpart M of this part will be deemed to meet this requirement.
- 1926.502(b)(5) Midrails, screens, mesh, intermediate vertical members, solid panels, and equivalent structural members shall be capable of withstanding, without failure, a force of at least 150 pounds (666 N) applied in any downward or outward direction at any point along the midrail or other member.
- 1926.502(b)(6) Guardrail systems shall be so surfaced as to prevent injury to an employee from punctures or lacerations, and to prevent snagging of clothing.
- 1926.502(b)(7) The ends of all top rails and midrails shall not overhang the terminal posts, except where such overhang does not constitute a projection hazard.
- 1926.502(b)(8) Steel banding and plastic banding shall not be used as top rails or midrails.
- 1926.502(b)(9) Top rails and midrails shall be at least one-quarter inch (0.6 cm) nominal diameter or thickness to prevent cuts and lacerations. If wire rope is used for top rails, it shall be flagged at not more than 6-foot intervals with high-visibility material.
- 1926.502(b)(10) When guardrail systems are used at hoisting areas, a chain, gate or removable guardrail section shall be placed across the access opening between guardrail sections when hoisting operations are not taking place.
- 1926.502(b)(11) When guardrail systems are used at holes, they shall be erected on all unprotected sides or edges of the hole.
- 1926.502(b)(12) When guardrail systems are used around holes used for the passage of materials, the hole shall have not more than two sides provided with removable guardrail sections to allow the passage of materials. When the hole is not in use, it shall be closed over with a cover, or a guardrail system shall be provided along all unprotected sides or edges.
- 1926.502(b)(13) When guardrail systems are used around holes which are used as points of access (such as ladderways), they shall be provided with a gate, or be so offset that a person cannot walk directly into the hole.
- 1926.502(b)(14) Guardrail systems used on ramps and runways shall be erected along each unprotected side or edge.

1926.502(b)(15) Manila, plastic or synthetic rope being used for top rails or midrails shall be inspected as frequently as necessary to ensure that it continues to meet the strength requirements of paragraph (b)(3) of this section.

1926.502(c) "Safety net systems."

Safety net systems and their use shall comply with the following provisions:

1926.502(c)(1) Safety nets shall be installed as close as practicable under the walking/working surface on which employees are working, but in no case more than 30 feet (9.1 m) below such level. When nets are used on bridges, the potential fall area from the walking/working surface to the net shall be unobstructed.

1926.502(c)(2) Safety nets shall extend outward from the outermost projection of the work surface as follows:

| Vertical distance from working level to horizontal plane of net | Minimum required horizontal distance of outer edge of net from the edge of the working surface |
|---|--|
| Up to 5 feet | 8 feet |
| More than 5 feet up to 10 feet | 10 feet |
| More than 10 feet | 13 feet |

1926.502(c)(3) Safety nets shall be installed with sufficient clearance under them to prevent contact with the surface or structures below when subjected to an impact force equal to the drop test specified in paragraph (c)(4) of this section.

1926.502(c)(4) Safety nets and their installations shall be capable of absorbing an impact force equal to that produced by the drop test specified in paragraph (c)(4)(i) of this section.

1926.502(c)(4)(i) Except as provided in paragraph (c)(4)(ii) of this section, safety nets and safety net installations shall be drop-tested at the jobsite after initial installation and before being used as a fall protection system, whenever relocated, after major repair, and at 6-month intervals if left in one place. The drop-test shall consist of a 400-pound (180 kg) bag of sand 30 + or - 2 inches (76 + or - 5 cm) in diameter dropped into the net from the highest walking/working surface at which employees are exposed to fall hazards, but not from less than 42 inches (1.1 m) above that level.

1926.502(c)(4)(ii) When the employer can demonstrate that it is unreasonable to perform the drop-test required by paragraph (c)(4)(i) of this section, the employer (or a designated competent person) shall certify that the net and net installation is in compliance with the provisions of paragraphs (c)(3) and (c)(4)(i) of this section by preparing a certification record prior to the net being used as a fall protection system. The certification record must include an identification of the net and net installation for which the certification record is being prepared; the date that it was determined that the identified net and net installation were in compliance with paragraph (c)(3) of this section and the signature of the person making the determination and certification. The most recent certification record for each net and net installation shall be available at the jobsite for inspection.

1926.502(c)(5) Defective nets shall not be used. Safety nets shall be inspected at least once a week for wear, damage, and other deterioration. Defective components shall be removed from service. Safety nets shall also be inspected after any occurrence which could affect the integrity of the safety net system.

1926.502(c)(6) Materials, scrap pieces, equipment, and tools which have fallen into the safety net shall be removed as soon as possible from the net and at least before the next work shift.

1926.502(c)(7) The maximum size of each safety net mesh opening shall not exceed 36 square inches (230 cm) nor be longer than 6 inches (15 cm) on any side, and the opening, measured center-to-center of mesh ropes or webbing, shall not be longer than 6 inches (15 cm). All mesh crossings shall be secured to prevent enlargement of the mesh opening.

1926.502(c)(8) Each safety net (or section of it) shall have a border rope for webbing with a minimum breaking strength of 5,000 pounds (22.2 kN).

1926.502(c)(9) Connections between safety net panels shall be as strong as integral net components and shall be spaced not more than 6 inches (15 cm) apart.

1926.502(d) "Personal fall arrest systems."

Personal fall arrest systems and their use shall comply with the provisions set forth below. Effective January 1, 1998, body belts are not acceptable as part of a personal fall arrest system. Note: The use of a body belt in a positioning device system is acceptable and is regulated under paragraph (e) of this section.

1926.502(d)(1) Connectors shall be drop forged, pressed or formed steel, or made of equivalent materials.

1926.502(d)(2) Connectors shall have a corrosion-resistant finish, and all surfaces and edges shall be smooth to prevent damage to interfacing parts of the system.

1926.502(d)(3) Dee-rings and snaphooks shall have a minimum tensile strength of 5,000 pounds (22.2 kN).

- 1926.502(d)(4) Dee-rings and snaphooks shall be proof-tested to a minimum tensile load of 3,600 pounds (16 kN) without cracking, breaking, or taking permanent deformation.
- 1926.502(d)(5) Snaphooks shall be sized to be compatible with the member to which they are connected to prevent unintentional disengagement of the snaphook by depression of the snaphook keeper by the connected member, or shall be a locking type snaphook designed and used to prevent disengagement of the snaphook by the contact of the snaphook keeper by the connected member. Effective January 1, 1998, only locking type snaphooks shall be used.
- 1926.502(d)(6) Unless the snaphook is a locking type and designed for the following connections, snaphooks shall not be engaged:
- 1926.502(d)(6)(i) directly to webbing, rope or wire rope;
 - 1926.502(d)(6)(ii) to each other;
 - 1926.502(d)(6)(iii) to a dee-ring to which another snaphook or other connector is attached;
 - 1926.502(d)(6)(iv) to a horizontal lifeline; or
 - 1926.502(d)(6)(v) to any object which is incompatibly shaped or dimensioned in relation to the snaphook such that unintentional disengagement could occur by the connected object being able to depress the snaphook keeper and release itself.
- 1926.502(d)(7) On suspended scaffolds or similar work platforms with horizontal lifelines which may become vertical lifelines, the devices used to connect to a horizontal lifeline shall be capable of locking in both directions on the lifeline.
- 1926.502(d)(8) Horizontal lifelines shall be designed, installed, and used, under the supervision of a qualified person, as part of a complete personal fall arrest system, which maintains a safety factor of at least two.
- 1926.502(d)(9) Lanyards and vertical lifelines shall have a minimum breaking strength of 5,000 pounds (22.2 kN).
- 1926.502(d)(10)
- 1926.502(d)(10)(i) Except as provided in paragraph (d)(10)(ii) of this section, when vertical lifelines are used, each employee shall be attached to a separate lifeline.
 - 1926.502(d)(10)(ii) During the construction of elevator shafts, two employees may be attached to the same lifeline in the hoistway, provided both employees are working atop a false car that is equipped with guardrails; the strength of the lifeline is 10,000 pounds [5,000 pounds per employee attached] (44.4 kN); and all other criteria specified in this paragraph for lifelines have been met.
- 1926.502(d)(11) Lifelines shall be protected against being cut or abraded.
- 1926.502(d)(12) Self-retracting lifelines and lanyards which automatically limit free fall distance to 2 feet (0.61 m) or less shall be capable of sustaining a minimum tensile load of 3,000 pounds (13.3 kN) applied to the device with the lifeline or lanyard in the fully extended position.
- 1926.502(d)(13) Self-retracting lifelines and lanyards which do not limit free fall distance to 2 feet (0.61 m) or less, ripstitch lanyards, and tearing and deforming lanyards shall be capable of sustaining a minimum tensile load of 5,000 pounds (22.2 kN) applied to the device with the lifeline or lanyard in the fully extended position.
- 1926.502(d)(14) Ropes and straps (webbing) used in lanyards, lifelines, and strength components of body belts and body harnesses shall be made from synthetic fibers.
- 1926.502(d)(15) Anchorages used for attachment of personal fall arrest equipment shall be independent of any anchorage being used to support or suspend platforms and capable of supporting at least 5,000 pounds (22.2 kN) per employee attached, or shall be designed, installed, and used as follows:
- 1926.502(d)(15)(i) as part of a complete personal fall arrest system which maintains a safety factor of at least two; and
- 1926.502(d)(15)(ii) under the supervision of a qualified person.
- 1926.502(d)(16) Personal fall arrest systems, when stopping a fall, shall:
- 1926.502(d)(16)(i) limit maximum arresting force on an employee to 900 pounds (4 kN) when used with a body belt;
 - 1926.502(d)(16)(ii) limit maximum arresting force on an employee to 1,800 pounds (8 kN) when used with a body harness;
 - 1926.502(d)(16)(iii) be rigged such that an employee can neither free fall more than 6 feet (1.8 m), nor contact any lower level;
 - 1926.502(d)(16)(iv) bring an employee to a complete stop and limit maximum deceleration distance an employee travels to 3.5 feet (1.07 m); and,
 - 1926.502(d)(16)(v) have sufficient strength to withstand twice the potential impact energy of an employee free falling a distance of 6 feet (1.8 m), or the free fall distance permitted by the system, whichever is less.
- Note: If the personal fall arrest system meets the criteria and protocols contained in Appendix C to subpart M, and if the system is being used by an employee having a combined person and tool weight of less than 310 pounds (140 kg), the system will be considered to be in compliance with the provisions of paragraph (d)(16) of this section. If the system is used by an employee having a combined tool and body weight of 310 pounds (140 kg) or more, then the employer must appropriately modify the criteria and protocols of the Appendix to provide proper protection for such heavier weights, or the system will not be deemed to be in compliance with the requirements of paragraph (d)(16) of this section.

- 1926.502(d)(17) The attachment point of the body belt shall be located in the center of the wearer's back. The attachment point of the body harness shall be located in the center of the wearer's back near shoulder level, or above the wearer's head.
- 1926.502(d)(18) Body belts, harnesses, and components shall be used only for employee protection (as part of a personal fall arrest system or positioning device system) and not to hoist materials.
- 1926.502(d)(19) Personal fall arrest systems and components subjected to impact loading shall be immediately removed from service and shall not be used again for employee protection until inspected and determined by a competent person to be undamaged and suitable for reuse.
- 1926.502(d)(20) The employer shall provide for prompt rescue of employees in the event of a fall or shall assure that employees are able to rescue themselves.
- 1926.502(d)(21) Personal fall arrest systems shall be inspected prior to each use for wear, damage and other deterioration, and defective components shall be removed from service.
- 1926.502(d)(22) Body belts shall be at least one and five-eighths (1 5/8) inches (4.1 cm) wide.
- 1926.502(d)(23) Personal fall arrest systems shall not be attached to guardrail systems, nor shall they be attached to hoists except as specified in other subparts of this Part.
- 1926.502(d)(24) When a personal fall arrest system is used at hoist areas, it shall be rigged to allow the movement of the employee only as far as the edge of the walking/working surface.

1926.502(e) "Positioning device systems."

Positioning device systems and their use shall conform to the following provisions:

- 1926.502(e)(1) Positioning devices shall be rigged such that an employee cannot free fall more than 2 feet (.6m).
- 1926.502(e)(2) Positioning devices shall be secured to an anchorage capable of supporting at least twice the potential impact load of an employee's fall or 3,000 pounds (13.3 kN), whichever is greater.
- 1926.502(e)(3) Connectors shall be drop forged, pressed or formed steel, or made of equivalent materials.
- 1926.502(e)(4) Connectors shall have a corrosion-resistant finish, and all surfaces and edges shall be smooth to prevent damage to interfacing parts of this system.
- 1926.502(e)(5) Connecting assemblies shall have a minimum tensile strength of 5,000 pounds (22.2 kN)
- 1926.502(e)(6) Dee-rings and snaphooks shall be proof-tested to a minimum tensile load of 3,600 pounds (16 kN) without cracking, breaking, or taking permanent deformation.
- 1926.502(e)(7) Snaphooks shall be sized to be compatible with the member to which they are connected to prevent unintentional disengagement of the snaphook by depression of the snaphook keeper by the connected member, or shall be a locking type snaphook designed and used to prevent disengagement of the snaphook by the contact of the snaphook keeper by the connected member. As of January 1, 1998, only locking type snaphooks shall be used.
- 1926.502(e)(8) Unless the snaphook is a locking type and designed for the following connections, snaphooks shall not be engaged:
- 1926.502(e)(8)(i) directly to webbing, rope or wire rope;
 - 1926.502(e)(8)(ii) to each other;
 - 1926.502(e)(8)(iii) to a dee-ring to which another snaphook or other connector is attached;
 - 1926.502(e)(8)(iv) to a horizontal lifeline; or
 - 1926.502(e)(8)(v) to any object which is incompatibly shaped or dimensioned in relation to the snaphook such that unintentional disengagement could occur by the connected object being able to depress the snaphook keeper and release itself.
- 1926.502(e)(9) Positioning device systems shall be inspected prior to each use for wear, damage, and other deterioration, and defective components shall be removed from service.
- 1926.502(e)(10) Body belts, harnesses, and components shall be used only for employee protection (as part of a personal fall arrest system or positioning device system) and not to hoist materials.

1926.502(f) "Warning line systems."

Warning line systems [See 1926.501(b)(10)] and their use shall comply with the following provisions:

- 1926.502(f)(1) The warning line shall be erected around all sides of the roof work area.
- 1926.502(f)(1)(i) When mechanical equipment is not being used, the warning line shall be erected not less than 6 feet (1.8 m) from the roof edge.
- 1926.502(f)(1)(ii) When mechanical equipment is being used, the warning line shall be erected not less than 6 feet (1.8 m) from the roof edge which is parallel to the direction of mechanical equipment operation, and not less than 10 feet (3.1 m) from the roof edge which is perpendicular to the direction of mechanical equipment operation.
- 1926.502(f)(1)(iii) Points of access, materials handling areas, storage areas, and hoisting areas shall be connected to the work area by an access path formed by two warning lines.

- 1926.502(f)(1)(iv) When the path to a point of access is not in use, a rope, wire, chain, or other barricade, equivalent in strength and height to the warning line, shall be placed across the path at the point where the path intersects the warning line erected around the work area, or the path shall be offset such that a person cannot walk directly into the work area.
- 1926.502(f)(2) Warning lines shall consist of ropes, wires, or chains, and supporting stanchions erected as follows:
- 1926.502(f)(2)(i) The rope, wire, or chain shall be flagged at not more than 6-foot (1.8 m) intervals with high-visibility material;
- 1926.502(f)(2)(ii) The rope, wire, or chain shall be rigged and supported in such a way that its lowest point (including sag) is no less than 34 inches (.9 m) from the walking/working surface and its highest point is no more than 39 inches (1.0 m) from the walking/working surface;
- 1926.502(f)(2)(iii) After being erected, with the rope, wire, or chain attached, stanchions shall be capable of resisting, without tipping over, a force of at least 16 pounds (71 N) applied horizontally against the stanchion, 30 inches (.8 m) above the walking/working surface, perpendicular to the warning line, and in the direction of the floor, roof, or platform edge;
- 1926.502(f)(2)(iv) The rope, wire, or chain shall have a minimum tensile strength of 500 pounds (2.22 kN), and after being attached to the stanchions, shall be capable of supporting, without breaking, the loads applied to the stanchions as prescribed in paragraph (f)(2)(iii) of this section; and
- 1926.502(f)(2)(v) The line shall be attached at each stanchion in such a way that pulling on one section of the line between stanchions will not result in slack being taken up in adjacent sections before the stanchion tips over.
- 1926.502(f)(3) No employee shall be allowed in the area between a roof edge and a warning line unless the employee is performing roofing work in that area.
- 1926.502(f)(4) Mechanical equipment on roofs shall be used or stored only in areas where employees are protected by a warning line system, guardrail system, or personal fall arrest system.

1926.502(g) "Controlled access zones."

Controlled access zones [See 1926.501(b)(9) and 1926.502(k)] and their use shall conform to the following provisions.

- 1926.502(g)(1) When used to control access to areas where leading edge and other operations are taking place the controlled access zone shall be defined by a control line or by any other means that restricts access.
- 1926.502(g)(1)(i) When control lines are used, they shall be erected not less than 6 feet (1.8 m) nor more than 25 feet (7.7 m) from the unprotected or leading edge, except when erecting precast concrete members.
- 1926.502(g)(1)(ii) When erecting precast concrete members, the control line shall be erected not less than 6 feet (1.8 m) nor more than 60 feet (18 m) or half the length of the member being erected, whichever is less, from the leading edge.
- 1926.502(g)(1)(iii) The control line shall extend along the entire length of the unprotected or leading edge and shall be approximately parallel to the unprotected or leading edge.
- 1926.502(g)(1)(iv) The control line shall be connected on each side to a guardrail system or wall.
- 1926.502(g)(2) When used to control access to areas where overhand bricklaying and related work are taking place:
- 1926.502(g)(2)(i) The controlled access zone shall be defined by a control line erected not less than 10 feet (3.1 m) nor more than 15 feet (4.5 m) from the working edge.
- 1926.502(g)(2)(ii) The control line shall extend for a distance sufficient for the controlled access zone to enclose all employees performing overhand bricklaying and related work at the working edge and shall be approximately parallel to the working edge.
- 1926.502(g)(2)(iii) Additional control lines shall be erected at each end to enclose the controlled access zone.
- 1926.502(g)(2)(iv) Only employees engaged in overhand bricklaying or related work shall be permitted in the controlled access zone.
- 1926.502(g)(3) Control lines shall consist of ropes, wires, tapes, or equivalent materials, and supporting stanchions as follows:
- 1926.502(g)(3)(i) Each line shall be flagged or otherwise clearly marked at not more than 6-foot (1.8 m) intervals with high-visibility material.
- 1926.502(g)(3)(ii) Each line shall be rigged and supported in such a way that its lowest point (including sag) is not less than 39 inches (1 m) from the walking/working surface and its highest point is not more than 45 inches (1.3 m) [50 inches (1.3 m) when overhand bricklaying operations are being performed] from the walking/working surface.
- 1926.502(g)(3)(iii) Each line shall have a minimum breaking strength of 200 pounds (.88 kN).
- 1926.502(g)(4) On floors and roofs where guardrail systems are not in place prior to the beginning of overhand bricklaying operations, controlled access zones shall be enlarged, as necessary, to enclose all points of access, material handling areas, and storage areas.
- 1926.502(g)(5) On floors and roofs where guardrail systems are in place, but need to be removed to allow overhand bricklaying work or leading-edge work to take place, only that portion of the guardrail necessary to accomplish that day's work shall be removed.

1926.502(h) "Safety monitoring systems."

Safety monitoring systems [See 1926.501(b)(10) and 1926.502(k)] and their use shall comply with the following provisions:

- 1926.502(h)(1) The employer shall designate a competent person to monitor the safety of other employees and the employer shall ensure that the safety monitor complies with the following requirements:
 - 1926.502(h)(1)(i) The safety monitor shall be competent to recognize fall hazards;
 - 1926.502(h)(1)(ii) The safety monitor shall warn the employee when it appears that the employee is unaware of a fall hazard or is acting in an unsafe manner;
 - 1926.502(h)(1)(iii) The safety monitor shall be on the same walking/working surface and within visual sighting distance of the employee being monitored;
 - 1926.502(h)(1)(iv) The safety monitor shall be close enough to communicate orally with the employee; and
 - 1926.502(h)(1)(v) The safety monitor shall not have other responsibilities which could take the monitor's attention from the monitoring function.
- 1926.502(h)(2) Mechanical equipment shall not be used or stored in areas where safety monitoring systems are being used to monitor employees engaged in roofing operations on low-slope roofs.
- 1926.502(h)(3) No employee, other than an employee engaged in roofing work [on low-sloped roofs] or an employee covered by a fall protection plan, shall be allowed in an area where an employee is being protected by a safety monitoring system.
- 1926.502(h)(4) Each employee working in a controlled access zone shall be directed to comply promptly with fall hazard warnings from safety monitors.

1926.502(i) "Covers."

Covers for holes in floors, roofs, and other walking/working surfaces shall meet the following requirements:

- 1926.502(i)(1) Covers located in roadways and vehicular aisles shall be capable of supporting, without failure, at least twice the maximum axle load of the largest vehicle expected to cross over the cover.
- 1926.502(i)(2) All other covers shall be capable of supporting, without failure, at least twice the weight of employees, equipment, and materials that may be imposed on the cover at any one time.
- 1926.502(i)(3) All covers shall be secured when installed so as to prevent accidental displacement by the wind, equipment, or employees.
- 1926.502(i)(4) All covers shall be color coded or they shall be marked with the word "HOLE" or "COVER" to provide warning of the hazard.

Note: This provision does not apply to cast iron manhole covers or steel grates used on streets or roadways.

1926.502(j) "Protection from falling objects."

Falling object protection shall comply with the following provisions:

- 1926.502(j)(1) Toeboards, when used as falling object protection, shall be erected along the edge of the overhead walking/working surface for a distance sufficient to protect employees below.
- 1926.502(j)(2) Toeboards shall be capable of withstanding, without failure, a force of at least 50 pounds (222 N) applied in any downward or outward direction at any point along the toeboard.
- 1926.502(j)(3) Toeboards shall be a minimum of 3 1/2 inches (9 cm) in vertical height from their top edge to the level of the walking/working surface. They shall have not more than 1/4-inch (0.6 cm) clearance above the walking/working surface. They shall be solid or have openings not over 1 inch (2.5 cm) in greatest dimension.
- 1926.502(j)(4) Where tools, equipment, or materials are piled higher than the top edge of a toeboard, paneling or screening shall be erected from the walking/working surface or toeboard to the top of a guardrail system's top rail or midrail, for a distance sufficient to protect employees below.
- 1926.502(j)(5) Guardrail systems, when used as falling object protection, shall have all openings small enough to prevent passage of potential falling objects.
- 1926.502(j)(6) During the performance of overhand bricklaying and related work:
 - 1926.502(j)(6)(i) No materials or equipment except masonry and mortar shall be stored within 4 feet (1.2 m) of the working edge.
 - 1926.502(j)(6)(ii) Excess mortar, broken or scattered masonry units, and all other materials and debris shall be kept clear from the work area by removal at regular intervals.
- 1926.502(j)(7) During the performance of roofing work:
 - 1926.502(j)(7)(i) Materials and equipment shall not be stored within 6 feet (1.8 m) of a roof edge unless guardrails are erected at the edge.
 - 1926.502(j)(7)(ii) Materials which are piled, grouped, or stacked near a roof edge shall be stable and self-supporting.
- 1926.502(j)(8) Canopies, when used as falling object protection, shall be strong enough to prevent collapse and to prevent penetration by any objects which may fall onto the canopy.

1926.502(k) "Fall protection plan."

This option is available only to employees engaged in leading edge work, precast concrete erection work, or residential construction work (See 1926.501(b)(2), (b)(12), and (b)(13)) who can demonstrate that it is infeasible, or it creates a greater hazard to use conventional fall protection equipment. The fall protection plan must conform to the following provisions.

- 1926.502(k)(1) The fall protection plan shall be prepared by a qualified person and developed specifically for the site where the leading-edge work, precast concrete work, or residential construction work is being performed and the plan must be maintained up to date.
- 1926.502(k)(2) Any changes to the fall protection plan shall be approved by a qualified person.
- 1926.502(k)(3) A copy of the fall protection plan with all approved changes shall be maintained at the job site.
- 1926.502(k)(4) The implementation of the fall protection plan shall be under the supervision of a competent person.
- 1926.502(k)(5) The fall protection plan shall document the reasons why the use of conventional fall protection systems (guardrail systems, personal fall arrest systems, or safety nets systems) are infeasible or why their use would create a greater hazard.
- 1926.502(k)(6) The fall protection plan shall include a written discussion of other measures that will be taken to reduce or eliminate the fall hazard for workers who cannot be provided with protection from the conventional fall protection systems. For example, the employer shall discuss the extent to which scaffolds, ladders, or vehicle mounted work platforms can be used to provide a safer working surface and thereby reduce the hazard of falling.
- 1926.502(k)(7) The fall protection plan shall identify each location where conventional fall protection methods cannot be used. These locations shall then be classified as controlled access zones and the employer must comply with the criteria in paragraph (g) of this section.
- 1926.502(k)(8) Where no other alternative measure has been implemented, the employer shall implement a safety monitoring system in conformance with 1926.502(h).
- 1926.502(k)(9) The fall protection plan must include a statement which provides the name or other method of identification for each employee who is designated to work in controlled access zones. No other employees may enter controlled access zones.
- 1926.502(k)(10) In the event an employee falls, or some other related, serious incident occurs, (e.g., a near miss) the employer shall investigate the circumstances of the fall or other incident to determine if the fall protection plan needs to be changed (e.g. new practices, procedures, or training) and shall implement those changes to prevent similar types of falls or incidents.

[44 FR 8577, Feb. 9, 1979; 44 FR 20940, Apr. 6, 1979, as amended at 45 FR 75626, Nov. 14, 1980; 55 FR 47687, Nov. 14, 1990; 59 FR 40733, Aug. 9, 1994; 60 FR 5131, Jan. 26, 1995]

1926.503 TRAINING REQUIREMENTS

The following training provisions supplement and clarify the requirements of 1926.21 regarding the hazards addressed in subpart M of this part.

1926.503(a) "Training Program."

1926.503(a)(1) The employer shall provide a training program for each employee who might be exposed to fall hazards. The program shall enable each employee to recognize the hazards of falling and shall train each employee in the procedures to be followed in order to minimize these hazards.

1926.503(a)(2) The employer shall assure that each employee has been trained, as necessary, by a competent person qualified in the following areas:

1926.503(a)(2)(i) The nature of fall hazards in the work area;

1926.503(a)(2)(ii) The correct procedures for erecting, maintaining, disassembling, and inspecting the fall protection systems to be used;

1926.503(a)(2)(iii) The use and operation of guardrail systems, personal fall arrest systems, safety net systems, warning line systems, safety monitoring systems, controlled access zones, and other protection to be used;

1926.503(a)(2)(iv) The role of each employee in the safety monitoring system when this system is used;

1926.503(a)(2)(v) The limitations on the use of mechanical equipment during the performance of roofing work on low-sloped roofs;

1926.503(a)(2)(vi) The correct procedures for the handling and storage of equipment and materials and the erection of overhead protection; and

1926.503(a)(2)(vii) The role of employees in fall protection plans;

1926.503(a)(2)(viii) The standards contained in this subpart.

1926.503(b) "Certification of training."

1926.503(b)(1) The employer shall verify compliance with paragraph (a) of this section by preparing a written certification record. The written certification record shall contain the name or other identity of the employee trained, the date(s) of the training, and the signature of the person who conducted the training or the signature of the employer. If the employer relies on training conducted by another employer or completed prior to the effective date of this section, the certification record shall indicate the date the employer determined the prior training was adequate rather than the date of actual training.

1926.503(b)(2) The latest training certification shall be maintained.

1926.503(c) "Retraining."

When the employer has reason to believe that any affected employee who has already been trained does not have the understanding and skill required by paragraph (a) of this section, the employer shall retrain each such employee. Circumstances where retraining is required include, but are not limited to, situations where:

1926.503(c)(1) Changes in the workplace render previous training obsolete; or

1926.503(c)(2) Changes in the types of fall protection systems or equipment to be used render previous training obsolete; or

1926.503(c)(3) Inadequacies in an affected employee's knowledge or use of fall protection systems or equipment indicate that the employee has not retained the requisite understanding or skill.

Note: The following appendices to subpart M of this part serve as non-mandatory guidelines to assist employers in complying with the appropriate requirements of subpart M of this part.

[59 FR 40738, Aug. 9, 1994; 60 FR 5131, Jan. 26, 1995]

**APPENDIX A
DETERMINING ROOF WIDTHS
NON-MANDATORY GUIDELINES FOR COMPLYING WITH 1926.501(B)(10)**

- (1) This Appendix serves as a guideline to assist employers complying with the requirements of 1926.501(b)(10). Section 1910.501(b)(10) allows the use of a safety monitoring system alone as a means of providing fall protection during the performance of roofing operations on low-sloped roofs 50 feet (15.25 m) or less in width. Each example in the appendix shows a roof plan or plans and indicates where each roof or roof area is to be measured to determine its width. Section views or elevation views are shown where appropriate. Some examples show "correct" and "incorrect" subdivisions of irregularly shaped roofs divided into smaller, regularly shaped areas. In all examples, the dimension selected to be the width of an area is the lesser of the two primary dimensions of the area, as viewed from above. Example A shows that on a simple rectangular roof, width is the lesser of the two primary overall dimensions. This is also the case with roofs which are sloped toward or away from the roof center, as shown in Example B.
- (2) Many roofs are not simple rectangles. Such roofs may be broken down into subareas as shown in Example C. The process of dividing a roof area can produce many different configurations. Example C gives the general rule of using dividing lines of minimum length to minimize the size and number of the areas which are potentially less than 50 feet (15.25 m) wide. The intent is to minimize the number of roof areas where safety monitoring systems alone are sufficient protection.
- (3) Roofs which are comprised of several separate, non-contiguous roof areas, as in Example D, may be considered as a series of individual roofs. Some roofs have penthouses, additional floors, courtyard openings, or similar architectural features; Example E shows how the rule for dividing roofs into subareas is applied to such configurations. Irregular, non-rectangular roofs must be considered on an individual basis, as shown in Example F.

**Example A
Rectangular Shaped Roofs**

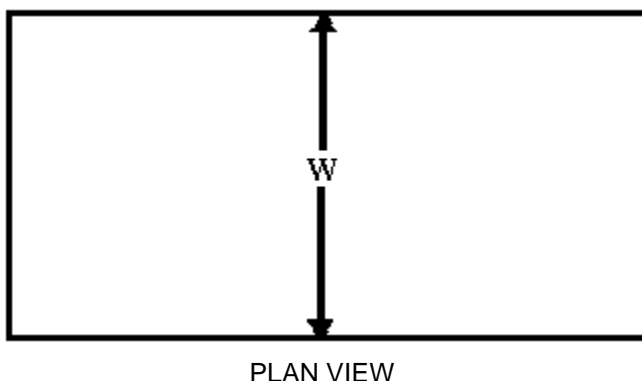

**Example B
Sloped Rectangular Shaped Roofs**

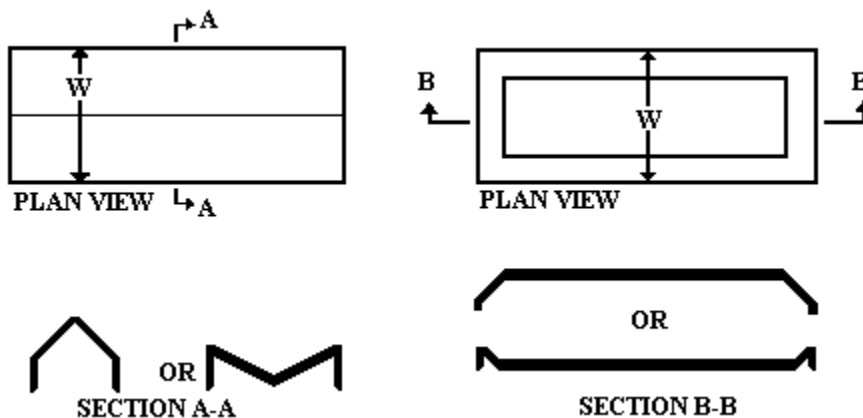

Example C Irregularly Shaped Roofs With Rectangular Shaped Sections

Such roofs are to be divided into sub-areas by using dividing lines of minimum length to minimize the size and number of the areas which are potentially less than or equal to 50 feet (15.25 meters) in width, in order to limit the size of roof areas where the safety monitoring system alone can be used [1926.502(b)(10)]. Dotted lines are used in the examples to show the location of dividing lines. *W* denotes incorrect measurements of width.

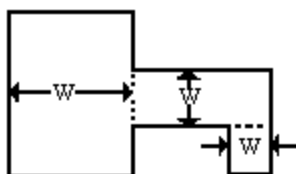

CORRECT

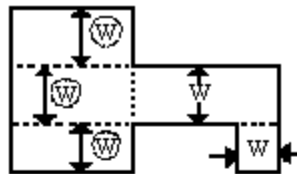

INCORRECT

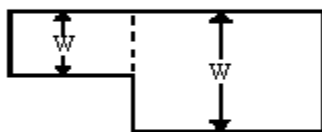

CORRECT

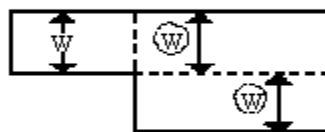

INCORRECT

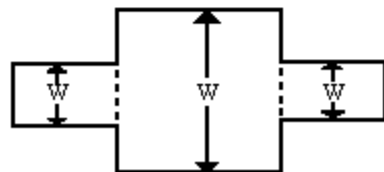

CORRECT

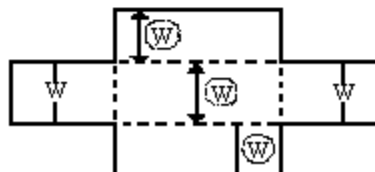

INCORRECT

Example D
Separate, Non-Contiguous Roof Areas

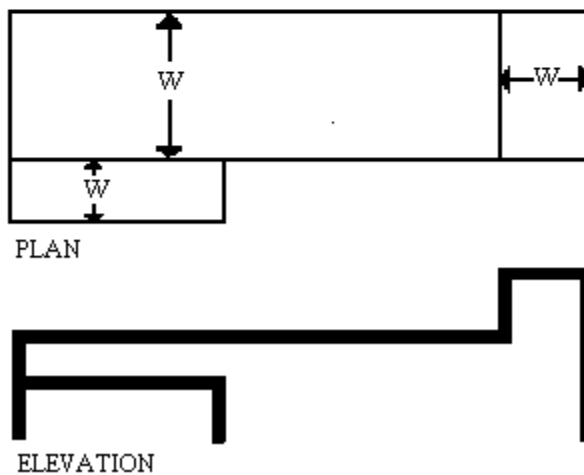
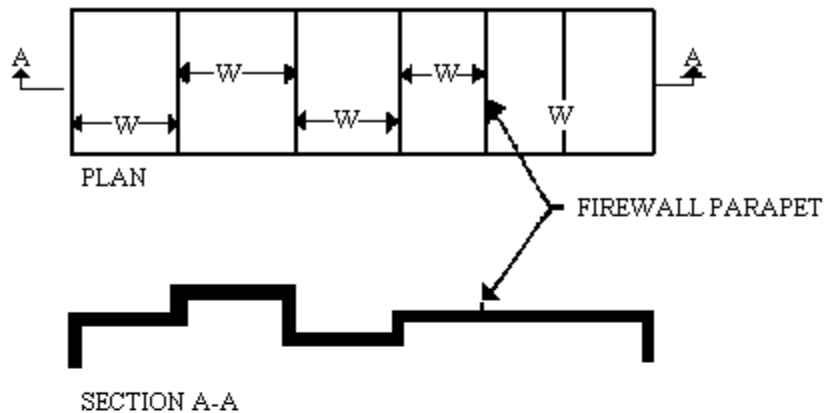

Example E
Roofs With Penthouses, Open Courtyards, Additional Floors, Etc.

Such roofs are to be divided into sub-areas by using dividing lines of minimum length to minimize the size and number of the areas which are potentially less than or equal to 50 feet (15.25 meters) in width, in order to limit the size of roof areas where the safety monitoring system alone can be used [1926.502(b)(10)]. Dotted lines are used in the examples to show the location of dividing lines. *W* denotes incorrect measurements of width.

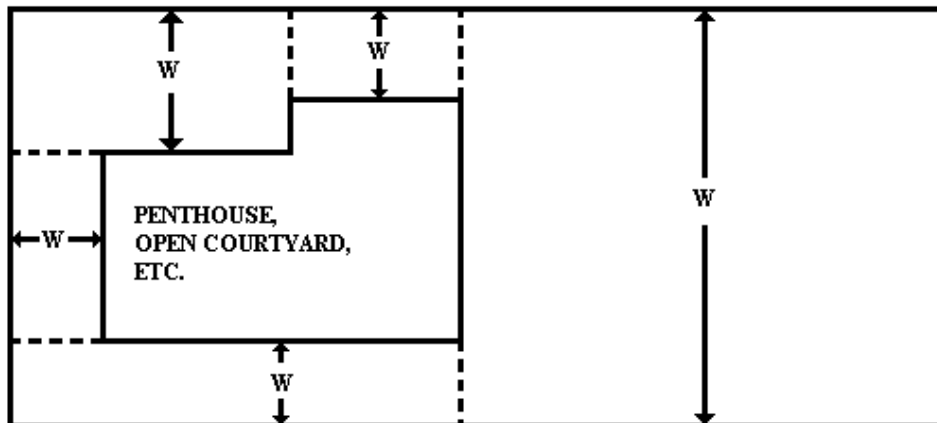

Correct

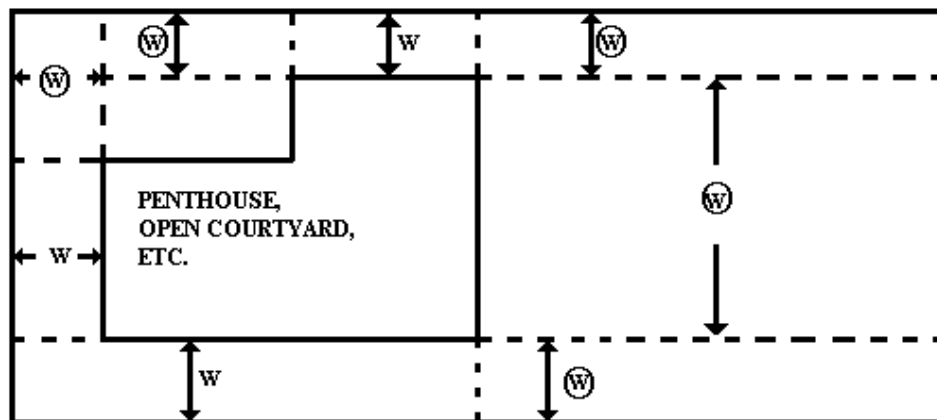

Incorrect

Example F
Irregular, Non-Rectangular Shaped Roofs

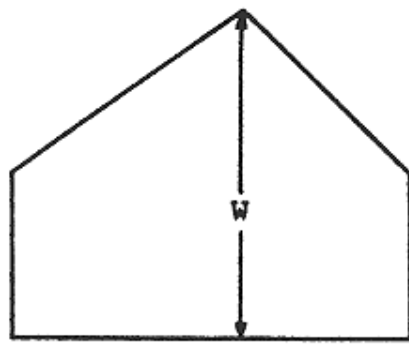

PLAN

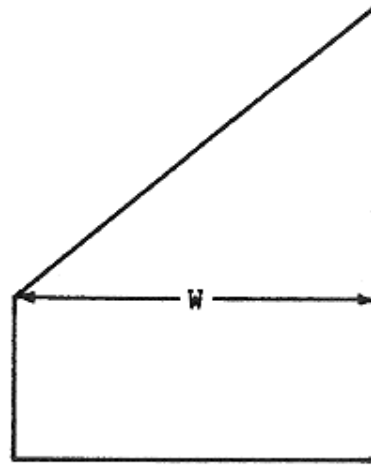

PLAN

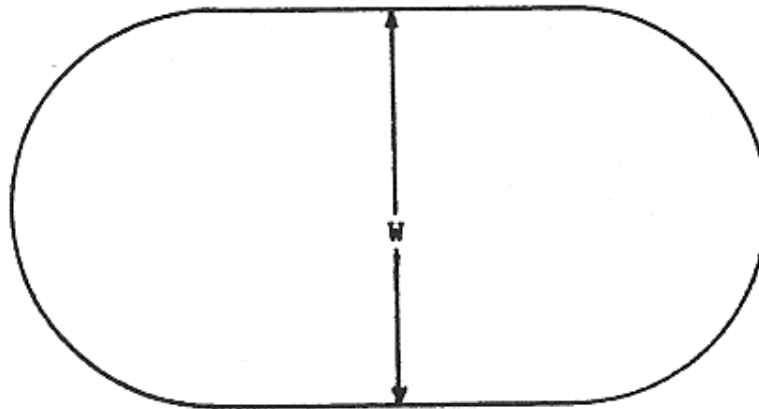

PLAN

[59 FR 40738, Aug. 9, 1994; 60 FR 5131, Jan. 26, 1995]

APPENDIX B
GUARDRAIL SYSTEMS
NON-MANDATORY GUIDELINES FOR COMPLYING WITH 1926.502(B)

The standard requires guardrail systems and components to be designed and built to meet the requirements of 1926.502(b)(3), (4), and (5). This Appendix serves as a non-mandatory guideline to assist employers in complying with these requirements. An employer may use these guidelines as a starting point for designing guardrail systems. However, the guidelines do not provide all the information necessary to build a complete system, and the employer is still responsible for designing and assembling these components in such a way that the completed system will meet the requirements of 1926.502(b)(3), (4), and (5). Components for which no specific guidelines are given in this Appendix (e.g., joints, base connections, components made with other materials, and components with other dimensions) must also be designed and constructed in such a way that the completed system meets the requirements of 1926.502.

(1) For wood railings:

Wood components shall be minimum 1500 lb-ft/in² fiber (stress grade) construction grade lumber; the posts shall be at least 2-inch by 4-inch (5 cm x 10 cm) lumber spaced not more than 8 feet (2.4 m) apart on centers; the top rail shall be at least 2-inch by 4-inch (5 cm x 10 cm) lumber, the intermediate rail shall be at least 1-inch by 6-inch (2.5 cm x 15 cm) lumber. All lumber dimensions are nominal sizes as provided by the American Softwood Lumber Standards, dated January 1970.

(2) For pipe railings:

posts, top rails, and intermediate railings shall be at least one and one-half inches nominal diameter (schedule 40 pipe) with posts spaced not more than 8 feet (2.4 m) apart on centers.

(3) For structural steel railings:

posts, top rails, and intermediate rails shall be at least 2-inch by 2-inch (5 cm x 10 cm) by 3/8-inch (1.1 cm) angles, with posts spaced not more than 8 feet (2.4 m) apart on centers.

[59 FR 40743, Aug. 9, 1994; 60 FR 5131, Jan. 26, 1995]

APPENDIX C
PERSONAL FALL ARREST SYSTEMS
NON-MANDATORY GUIDELINES FOR COMPLYING WITH 1926.502(D)

I. Test methods for personal fall arrest systems and positioning device systems

(a) "General."

This appendix serves as a non-mandatory guideline to assist employers comply with the requirements in 1926.502(d). Paragraphs (b), (c), (d) and (e) of this Appendix describe test procedures which may be used to determine compliance with the requirements in 1926.502 (d)(16). As noted in Appendix D of this subpart, the test methods listed here in Appendix C can also be used to assist employers comply with the requirements in 1926.502(e) (3) and (4) for positioning device systems.

(b) "General conditions for all tests in the Appendix to 1926.502(d)."

- (1) Lifelines, lanyards and deceleration devices should be attached to an anchorage and connected to the body-belt or body harness in the same manner as they would be when used to protect employees.
- (2) The anchorage should be rigid, and should not have a deflection greater than 0.04 inches (1 mm) when a force of 2,250 pounds (10 kN) is applied.
- (3) The frequency response of the load measuring instrumentation should be 500 Hz.
- (4) The test weight used in the strength and force tests should be a rigid, metal, cylindrical or torso-shaped object with a girth of 38 inches plus or minus 4 inches (96 cm plus or minus 10 cm).
- (5) The lanyard or lifeline used to create the free fall distance should be supplied with the system, or in its absence, the least elastic lanyard or lifeline available to be used with the system.
- (6) The test weight for each test should be hoisted to the required level and should be quickly released without having any appreciable motion imparted to it.
- (7) The system's performance should be evaluated taking into account the range of environmental conditions for which it is designed to be used. (8) Following the test, the system need not be capable of further operation.

(c) "Strength test."

- (1) During the testing of all systems, a test weight of 300 pounds plus or minus 5 pounds (135 kg plus or minus 2.5 kg) should be used. (See paragraph (b)(4) of this section.)
- (2) The test consists of dropping the test weight once. A new unused system should be used for each test.
- (3) For lanyard systems, the lanyard length should be 6 feet plus or minus 2 inches (1.83 m plus or minus 5 cm) as measured from the fixed anchorage to the attachment on the body belt or body harness.
- (4) For rope-grab-type deceleration systems, the length of the lifeline above the centerline of the grabbing mechanism to the lifeline's anchorage point should not exceed 2 feet (0.61 m).
- (5) For lanyard systems, for systems with deceleration devices which do not automatically limit free fall distance to 2 feet (0.61 m) or less, and for systems with deceleration devices which have a connection distance in excess of 1 foot (0.3 m) (measured between the centerline of the lifeline and the attachment point to the body belt or harness), the test weight should be rigged to free fall a distance of 7.5 feet (2.3 m) from a point that is 1.5 feet (.46 m) above the anchorage point, to its hanging location (6 feet below the anchorage). The test weight should fall without interference, obstruction, or hitting the floor or ground during the test. In some cases, a non-elastic wire lanyard of sufficient length may need to be added to the system (for test purposes) to create the necessary free fall distance.
- (6) For deceleration device systems with integral lifelines or lanyards which automatically limit free fall distance to 2 feet (0.61 m) or less, the test weight should be rigged to free fall a distance of 4 feet (1.22 m).
- (7) Any weight which detaches from the belt or harness has failed the strength test.

(d) "Force test"

- (1) "General." The test consists of dropping the respective test weight once as specified in paragraph (d)(2)(i) or (d)(3)(i) of this section. A new, unused system should be used for each test.
- (2) "For lanyard systems."
 - (i) A test weight of 220 pounds plus or minus 3 pounds (100 kg plus or minus 1.6 kg) should be used. (See paragraph (b)(4) of this appendix).
 - (ii) Lanyard length should be 6 feet plus or minus two inches (1.83 m plus or minus 5 cm) as measured from the fixed anchorage to the attachment on the body belt or body harness.
 - (iii) The test weight should fall free from the anchorage level to its hanging location (a total of 6 feet (1.83 m) free fall distance) without interference, obstruction, or hitting the floor or ground during the test.

- (3) "For all other systems."
 - (i) A test weight of 220 pounds plus or minus 3 pounds (100 kg plus or minus 1.6 kg) should be used. (See paragraph (b)(4) of this appendix)
 - (ii) The free fall distance to be used in the test should be the maximum fall distance physically permitted by the system during normal use conditions, up to a maximum free fall distance for the test weight of 6 feet (1.83 m), except as follows:
 - (A) For deceleration systems which have a connection link or lanyard, the test weight should free fall a distance equal to the connection distance (measured between the centerline of the lifeline and the attachment point to the body belt or harness).
 - (B) For deceleration device systems with integral lifelines or lanyards which automatically limit free fall distance to 2 feet (0.61 m) or less, the test weight should free fall a distance equal to that permitted by the system in normal use. (For example, to test a system with a self-retracting lifeline or lanyard, the test weight should be supported, and the system allowed to retract the lifeline or lanyard as it would in normal use. The test weight would then be released, and the force and deceleration distance measured).
- (4) A system fails the force test if the recorded maximum arresting force exceeds 1,260 pounds (5.6 kN) when using a body belt, and/or exceeds 2,520 pounds (11.2 kN) when using a body harness.
- (5) The maximum elongation and deceleration distance should be recorded during the force test.

(e) "Deceleration device tests."

- (1) "General." The device should be evaluated or tested under the environmental conditions, (such as rain, ice, grease, dirt, type of lifeline, etc.), for which the device is designed.
- (2) "Rope-grab-type deceleration devices."
 - (i) Devices should be moved on a lifeline 1,000 times over the same length of line a distance of not less than 1 foot (30.5 cm), and the mechanism should lock each time.
 - (ii) Unless the device is permanently marked to indicate the type(s) of lifeline which must be used, several types (different diameters and different materials), of lifelines should be used to test the device.
- (3) "Other self-activating-type deceleration devices." The locking mechanisms of other self-activating-type deceleration devices designed for more than one arrest should lock each of 1,000 times as they would in normal service.

II. Additional non-mandatory guidelines for personal fall arrest systems.

The following information constitutes additional guidelines for use in complying with requirements for a personal fall arrest system.

(a) "Selection and use considerations."

- (1) The kind of personal fall arrest system selected should match the particular work situation, and any possible free fall distance should be kept to a minimum. Consideration should be given to the particular work environment. For example, the presence of acids, dirt, moisture, oil, grease, etc., and their effect on the system, should be evaluated. Hot or cold environments may also have an adverse effect on the system. Wire rope should not be used where an electrical hazard is anticipated. As required by the standard, the employer must plan to have means available to promptly rescue an employee should a fall occur, since the suspended employee may not be able to reach a work level independently.
- (2) Where lanyards, connectors, and lifelines are subject to damage by work operations such as welding, chemical cleaning, and sandblasting, the component should be protected, or other securing systems should be used. The employer should fully evaluate the work conditions and environment (including seasonal weather changes) before selecting the appropriate personal fall protection system. Once in use, the system's effectiveness should be monitored. In some cases, a program for cleaning and maintenance of the system may be necessary.

(b) "Testing considerations."

Before purchasing or putting into use a personal fall arrest system, an employer should obtain from the supplier information about the system based on its performance during testing so that the employer can know if the system meets this standard. Testing should be done using recognized test methods. This Appendix contains test methods recognized for evaluating the performance of fall arrest systems. Not all systems may need to be individually tested; the performance of some systems may be based on data and calculations derived from testing of similar systems, provided that enough information is available to demonstrate similarity of function and design.

(c) "Component compatibility considerations."

Ideally, a personal fall arrest system is designed, tested, and supplied as a complete system. However, it is common practice for lanyards, connectors, lifelines, deceleration devices, body belts and body harnesses to be interchanged since some components wear out before others. The employer and employee should realize that not all components are interchangeable. For instance, a lanyard should not be connected between a body belt (or harness) and a deceleration device of the self-retracting type since this can result in additional free fall for which the system was not designed. Any substitution or change to a personal fall arrest system should be fully evaluated or tested by a competent person to determine that it meets the standard, before the modified system is put in use.

(d) "Employee training considerations."

Thorough employee training in the selection and use of personal fall arrest systems is imperative. Employees must be trained in the safe use of the system. This should include the following: application limits; proper anchoring and tie-off techniques; estimation of free fall distance, including determination of deceleration distance, and total fall distance to prevent striking a lower level; methods of use; and inspection and storage of the system. Careless or improper use of the equipment can result in serious injury or death. Employers and employees should become familiar with the material in this Appendix, as well as manufacturer's recommendations, before a system is used. Of uppermost importance is the reduction in strength caused by certain tie-offs (such as using knots, tying around sharp edges, etc.) and maximum permitted free fall distance. Also, to be stressed are the importance of inspections prior to use, the limitations of the equipment, and unique conditions at the worksite which may be important in determining the type of system to use.

(e) "Instruction considerations."

Employers should obtain comprehensive instructions from the supplier as to the system's proper use and application, including, where applicable:

- (1) The force measured during the sample force test;
- (2) The maximum elongation measured for lanyards during the force test;
- (3) The deceleration distance measured for deceleration devices during the force test;
- (4) Caution statements on critical use limitations;
- (5) Application limits;
- (6) Proper hook-up, anchoring and tie-off techniques, including the proper dee-ring or other attachment point to use on the body belt and harness for fall arrest;
- (7) Proper climbing techniques;
- (8) Methods of inspection, use, cleaning, and storage; and
- (9) Specific lifelines which may be used.

This information should be provided to employees during training.

(f) "Rescue considerations."

As required by 1926.502(d)(20), when personal fall arrest systems are used, the employer must assure that employees can be promptly rescued or can rescue themselves should a fall occur. The availability of rescue personnel, ladders or other rescue equipment should be evaluated. In some situations, equipment which allows employees to rescue themselves after the fall has been arrested may be desirable, such as devices which have descent capability.

(g) "Inspection considerations."

As required by 1926.502(d)(21), personal fall arrest systems must be regularly inspected. Any component with any significant defect, such as cuts, tears, abrasions, mold, or undue stretching; alterations or additions which might affect its efficiency; damage due to deterioration; contact with fire, acids, or other corrosives; distorted hooks or faulty hook springs; tongues unfitted to the shoulder of buckles; loose or damaged mountings; non-functioning parts; or wearing or internal deterioration in the ropes must be withdrawn from service immediately, and should be tagged or marked as unusable, or destroyed.

(h) "Tie-off considerations."

- (1) One of the most important aspects of personal fall protection systems is fully planning the system before it is put into use. Probably the most overlooked component is planning for suitable anchorage points. Such planning should ideally be done before the structure or building is constructed so that anchorage points can be incorporated during construction for use later for window cleaning or other building maintenance. If properly planned, these anchorage points may be used during construction, as well as afterwards.
 - (i) Properly planned anchorages should be used if they are available. In some cases, anchorages must be installed immediately prior to use. In such cases, a registered professional engineer with experience in designing fall protection systems, or another qualified person with appropriate education and experience should design an anchor point to be installed.

- (ii) In other cases, the Agency recognizes that there will be a need to devise an anchor point from existing structures. Examples of what might be appropriate anchor points are steel members or I-beams if an acceptable strap is available for the connection (do not use a lanyard with a snaphook clipped onto itself); large eye-bolts made of an appropriate grade steel; guardrails or railings if they have been designed for use as an anchor point; or masonry or wood members only if the attachment point is substantial and precautions have been taken to assure that bolts or other connectors will not pull through. A qualified person should be used to evaluate the suitability of these "make shift" anchorages with a focus on proper strength.
- (2) Employers and employees should at all times be aware that the strength of a personal fall arrest system is based on its being attached to an anchoring system which does not reduce the strength of the system (such as a properly dimensioned eye-bolt/snap-hook anchorage). Therefore, if a means of attachment is used that will reduce the strength of the system, that component should be replaced by a stronger one, but one that will also maintain the appropriate maximum arrest force characteristics.
- (3) Tie-off using a knot in a rope lanyard or lifeline (at any location) can reduce the lifeline or lanyard strength by 50 percent or more. Therefore, a stronger lanyard or lifeline should be used to compensate for the weakening effect of the knot, or the lanyard length should be reduced (or the tie-off location raised) to minimize free fall distance, or the lanyard or lifeline should be replaced by one which has an appropriately incorporated connector to eliminate the need for a knot.
- (4) Tie-off of a rope lanyard or lifeline around an "H" or "I" beam or similar support can reduce its strength as much as 70 percent due to the cutting action of the beam edges. Therefore, use should be made of a webbing lanyard or wire core lifeline around the beam; or the lanyard or lifeline should be protected from the edge; or free fall distance should be greatly minimized.
- (5) Tie-off where the line passes over or around rough or sharp surfaces reduces strength drastically. Such a tie-off should be avoided or an alternative tie-off rigging should be used. Such alternatives may include use of a snap-hook/dee ring connection, wire rope tie-off, an effective padding of the surfaces, or an abrasion-resistance strap around or over the problem surface.
- (6) Horizontal lifelines may, depending on their geometry and angle of sag, be subjected to greater loads than the impact load imposed by an attached component. When the angle of horizontal lifeline sag is less than 30 degrees, the impact force imparted to the lifeline by an attached lanyard is greatly amplified. For example, with a sag angle of 15 degrees, the force amplification is about 2:1 and at 5 degrees sag, it is about 6:1. Depending on the angle of sag, and the line's elasticity, the strength of the horizontal lifeline and the anchorages to which it is attached should be increased a number of times over that of the lanyard. Extreme care should be taken in considering a horizontal lifeline for multiple tie-offs. The reason for this is that in multiple tie-offs to a horizontal lifeline, if one employee falls, the movement of the falling employee and the horizontal lifeline during arrest of the fall may cause other employees to fall also. Horizontal lifeline and anchorage strength should be increased for each additional employee to be tied off. For these and other reasons, the design of systems using horizontal lifelines must only be done by qualified persons. Testing of installed lifelines and anchors prior to use is recommended.
- (7) The strength of an eye-bolt is rated along the axis of the bolt and its strength is greatly reduced if the force is applied at an angle to this axis (in the direction of shear). Also, care should be exercised in selecting the proper diameter of the eye to avoid accidental disengagement of snap-hooks not designed to be compatible for the connection.
- (8) Due to the significant reduction in the strength of the lifeline/lanyard (in some cases, as much as a 70 percent reduction), the sliding hitch knot (prusik) should not be used for lifeline/lanyard connections except in emergency situations where no other available system is practical. The "one-and-one" sliding hitch knot should never be used because it is unreliable in stopping a fall. The "two-and-two," or "three-and-three" knot (preferable) may be used in emergency situations; however, care should be taken to limit free fall distance to a minimum because of reduced lifeline/lanyard strength.

(i) "Vertical lifeline considerations."

As required by the standard, each employee must have a separate lifeline [except employees engaged in constructing elevator shafts who are permitted to have two employees on one lifeline] when the lifeline is vertical. The reason for this is that in multiple tie-offs to a single lifeline, if one employee falls, the movement of the lifeline during the arrest of the fall may pull other employees' lanyards, causing them to fall as well.

(j) "Snap-hook considerations."

- (1) Although not required by this standard for all connections until January 1, 1998, locking snaphooks designed for connection to suitable objects (of sufficient strength) are highly recommended in lieu of the nonlocking type. Locking snaphooks incorporate a positive locking mechanism in addition to the spring-loaded keeper, which will not allow the keeper to open under moderate pressure without someone first releasing the mechanism. Such a feature, properly designed, effectively prevents roll-out from occurring.
- (2) As required by 1926.502(d)(6), the following connections must be avoided (unless properly designed locking snaphooks are used) because they are conditions which can result in roll-out when a nonlocking snaphook is used:
 - (i) Direct connection of a snaphook to a horizontal lifeline.
 - (ii) Two (or more) snaphooks connected to one dee-ring.
 - (iii) Two snaphooks connected to each other.
 - (iv) A snaphook connected back on its integral lanyard.
 - (v) A snaphook connected to a webbing loop or webbing lanyard.
 - (vi) Improper dimensions of the dee-ring, rebar, or other connection point in relation to the snaphook dimensions which would allow the snaphook keeper to be depressed by a turning motion of the snaphook.

(k) "Free fall considerations."

The employer and employee should at all times be aware that a system's maximum arresting force is evaluated under normal use conditions established by the manufacturer, and in no case using a free fall distance in excess of 6 feet (1.8 m). A few extra feet of free fall can significantly increase the arresting force on the employee, possibly to the point of causing injury. Because of this, the free fall distance should be kept at a minimum, and, as required by the standard, in no case greater than 6 feet (1.8 m). To help assure this, the tie-off attachment point to the lifeline or anchor should be located at or above the connection point of the fall arrest equipment to belt or harness. (Since otherwise additional free fall distance is added to the length of the connecting means (i.e. lanyard)). Attaching to the working surface will often result in a free fall greater than 6 feet (1.8 m). For instance, if a 6-foot (1.8 m) lanyard is used, the total free fall distance will be the distance from the working level to the body belt (or harness) attachment point plus the 6 feet (1.8 m) of lanyard length. Another important consideration is that the arresting force which the fall system must withstand also goes up with greater distances of free fall, possibly exceeding the strength of the system.

(l) "Elongation and deceleration distance considerations."

Other factors involved in a proper tie-off are elongation and deceleration distance. During the arresting of a fall, a lanyard will experience a length of stretching or elongation, whereas activation of a deceleration device will result in a certain stopping distance. These distances should be available with the lanyard or device's instructions and must be added to the free fall distance to arrive at the total fall distance before an employee is fully stopped. The additional stopping distance may be very significant if the lanyard or deceleration device is attached near or at the end of a long lifeline, which may itself add considerable distance due to its own elongation. As required by the standard, sufficient distance to allow for all of these factors must also be maintained between the employee and obstructions below, to prevent an injury due to impact before the system fully arrests the fall. In addition, a minimum of 12 feet (3.7 m) of lifeline should be allowed below the securing point of a rope grab type deceleration device, and the end terminated to prevent the device from sliding off the lifeline. Alternatively, the lifeline should extend to the ground or the next working level below. These measures are suggested to prevent the worker from inadvertently moving past the end of the lifeline and having the rope grab become disengaged from the lifeline.

(m) "Obstruction considerations."

The location of the tie-off should also consider the hazard of obstructions in the potential fall path of the employee. Tie-offs which minimize the possibilities of exaggerated swinging should be considered. In addition, when a body belt is used, the employee's body will go through a horizontal position to a jack-knifed position during the arrest of all falls. Thus, obstructions which might interfere with this motion should be avoided or a severe injury could occur.

(n) "Other considerations."

Because of the design of some personal fall arrest systems, additional considerations may be required for proper tie-off. For example, heavy deceleration devices of the self-retracting type should be secured overhead in order to avoid the weight of the device having to be supported by the employee. Also, if self-retracting equipment is connected to a horizontal lifeline, the sag in the lifeline should be minimized to prevent the device from sliding down the lifeline to a position which creates a swing hazard during fall arrest. In all cases, manufacturer's instructions should be followed.

[59 FR 40743, Aug. 9, 1994; 60 FR 5131, Jan. 26, 1995]

APPENDIX D
POSITIONING DEVICE SYSTEMS
NON-MANDATORY GUIDELINES FOR COMPLYING WITH 1926.502(E)

I. Testing Methods For Positioning Device Systems.

This appendix serves as a non-mandatory guideline to assist employers comply with the requirements for positioning device systems in 1926.502(e). Paragraphs (b), (c), (d) and (e) of Appendix C of subpart M relating to 1926.502(d) - Personal Fall Arrest Systems - set forth test procedures which may be used, along with the procedures listed below, to determine compliance with the requirements for positioning device systems in 1926.502(e)(3) and (4) of Subpart M.

(a) "General."

- (1) Single strap positioning devices shall have one end attached to a fixed anchorage and the other end connected to a body belt or harness in the same manner as they would be used to protect employees. Double strap positioning devices, similar to window cleaner's belts, shall have one end of the strap attached to a fixed anchorage and the other end shall hang free. The body belt or harness shall be attached to the strap in the same manner as it would be used to protect employees. The two strap ends shall be adjusted to their maximum span.
- (2) The fixed anchorage shall be rigid, and shall not have a deflection greater than .04 inches (1 mm) when a force of 2,250 pounds (10 kN) is applied.
- (3) During the testing of all systems, a test weight of 250 pounds plus or minus 3 pounds (113 kg plus or minus 1.6 kg) shall be used. The weight shall be a rigid object with a girth of 38 inches plus or minus 4 inches (96 cm plus or minus 10 cm).
- (4) Each test shall consist of dropping the specified weight one time without failure of the system being tested. A new system shall be used for each test.
- (5) The test weight for each test shall be hoisted exactly 4 feet (1.2 m above its "at rest" position), and shall be dropped so as to permit a vertical free fall of 4 feet (1.2 m).
- (6) The test is failed whenever any breakage or slippage occurs which permits the weight to fall free of the system.
- (7) Following the test, the system need not be capable of further operation; however, all such incapacities shall be readily apparent.

II. Inspection Considerations.

As required in 1926.502 (e)(5), positioning device systems must be regularly inspected. Any component with any significant defect, such as cuts, tears, abrasions, mold, or undue stretching; alterations or additions which might affect its efficiency; damage due to deterioration; contact with fire, acids, or other corrosives; distorted hooks or faulty hook springs; tongues unfitted to the shoulder of buckles; loose or damaged mountings; non-functioning parts; or wearing or internal deterioration in the ropes must be withdrawn from service immediately, and should be tagged or marked as unusable, or destroyed.

[59 FR 40746, Aug. 9, 1994; 60 FR 5131, Jan. 26, 1995]

APPENDIX E
SAMPLE FALL PROTECTION PLAN
NON-MANDATORY GUIDELINES FOR COMPLYING WITH 1926.502(K)

Employers engaged in leading edge work, precast concrete construction work and residential construction work who can demonstrate that it is infeasible or creates a greater hazard to use conventional fall protection systems must develop and follow a fall protection plan. Below are sample fall protection plans developed for precast concrete construction and residential work that could be tailored to be site specific for other precast concrete or residential jobsite. This sample plan can be modified to be used for other work involving leading edge work. The sample plan outlines the elements that must be addressed in any fall protection plan. The reasons outlined in this sample fall protection plan are for illustrative purposes only and are not necessarily a valid, acceptable rationale (unless the conditions at the job site are the same as those covered by these sample plans) for not using conventional fall protection systems for a particular precast concrete or residential construction worksite. However, the sample plans provide guidance to employers on the type of information that is required to be discussed in fall protection plans.

SAMPLE FALL PROTECTION PLANS

Fall Protection Plan For Precast/Prestress Concrete Structures
 This Fall Protection Plan is specific for the following project:

| |
|--------------------------------|
| Location of Job |
| Erecting Company |
| Date Plan Prepared or Modified |
| Plan Prepared By |
| Plan Approved By |
| Plan Supervised By |

The following Fall Protection Plan is a sample program prepared for the prevention of injuries associated with falls. A Fall Protection Plan must be developed and evaluated on a site by site basis. It is recommended that erectors discuss the written Fall Protection Plan with their OSHA Area Office prior to going on a jobsite.

I. Statement of Company Policy

(Company Name) is dedicated to the protection of its employees from on-the-job injuries. All employees of (Company Name) have the responsibility to work safely on the job. The purpose of this plan is: (a) To supplement our standard safety policy by providing safety standards specifically designed to cover fall protection on this job and; (b) to ensure that each employee is trained and made aware of the safety provisions which are to be implemented by this plan prior to the start of erection.

This Fall Protection Plan addresses the use of other than conventional fall protection at a number of areas on the project, as well as identifying specific activities that require non-conventional means of fall protection. These areas include:

- a. Connecting activity (point of erection).
- b. Leading edge work.
- c. Unprotected sides or edge.
- d. Grouting.

This plan is designed to enable employers and employees to recognize the fall hazards on this job and to establish the procedures that are to be followed in order to prevent falls to lower levels or through holes and openings in walking/working surfaces. Each employee will be trained in these procedures and strictly adhere to them except when doing so would expose the employee to a greater hazard. If, in the employee's opinion, this is the case, the employee is to notify the foreman of the concern and the concern addressed before proceeding.

Safety policy and procedure on any one project cannot be administered, implemented, monitored and enforced by any one individual. The total objective of a safe, accident free work environment can only be accomplished by a dedicated, concerted effort by every individual involved with the project from management down to the last employee.

Each employee must understand their value to the company; the costs of accidents, both monetary, physical, and emotional; the objective of the safety policy and procedures; the safety rules that apply to the safety policy and procedures; and what their individual role is in administering, implementing, monitoring, and compliance of their safety policy and procedures. This allows for a more personal approach to compliance through planning, training, understanding and cooperative effort, rather than by strict enforcement. If for any reason an unsafe act persists, strict enforcement will be implemented.

It is the responsibility of (name of competent person) to implement this Fall Protection Plan. (Name of Competent Person) is responsible for continual observational safety checks of their work operations and to enforce the safety policy and procedures. The foreman also is responsible to correct any unsafe acts or conditions immediately. It is the responsibility of the employee to understand and adhere to the procedures of this plan and to follow the instructions of the foreman. It is also the responsibility of the employee to bring to management's attention any unsafe or hazardous conditions or acts that may cause injury to either themselves or any other employees. Any changes to this Fall Protection Plan must be approved by (name of Qualified Person).

II. Fall Protection Systems to Be Used on This Project

Where conventional fall protection is infeasible or creates a greater hazard at the leading edge and during initial connecting activity, we plan to do this work using a safety monitoring system and expose only a minimum number of employees for the time necessary to actually accomplish the job. The maximum number of workers to be monitored by one safety monitor is six (6). We are designating the following trained employees as designated erectors and they are permitted to enter the controlled access zones and work without the use of conventional fall protection.

| |
|---------------------|
| Safety monitor: |
| Designated erector: |
| Designated erector: |
| Designated erector: |
| Designated erector: |
| Designated erector: |
| Designated erector: |

The safety monitor shall be identified by wearing an orange hard hat. The designated erectors will be identified by one of the following methods:

1. They will wear a blue colored arm band, or
2. They will wear a blue colored hard hat, or
3. They will wear a blue colored vest.

Only individuals with the appropriate experience, skills, and training will be authorized as designated erectors. All employees that will be working as designated erectors under the safety monitoring system shall have been trained and instructed in the following areas:

1. Recognition of the fall hazards in the work area (at the leading edge and when making initial connections-point of erection).
2. Avoidance of fall hazards using established work practices which have been made known to the employees.
3. Recognition of unsafe practices or working conditions that could lead to a fall, such as windy conditions.
4. The function, use, and operation of safety monitoring systems, guardrail systems, body belt/harness systems, control zones and other protection to be used.
5. The correct procedure for erecting, maintaining, disassembling and inspecting the system(s) to be used.
6. Knowledge of construction sequence or the erection plan.

A conference will take place prior to starting work involving all members of the erection crew, crane crew and supervisors of any other concerned contractors. This conference will be conducted by the precast concrete erection supervisor in charge of the project. During the pre-work conference, erection procedures and sequences pertinent to this job will be thoroughly discussed and safety practices to be used throughout the project will be specified. Further, all personnel will be informed that the controlled access zones are off limits to all personnel other than those designated erectors specifically trained to work in that area.

Safety Monitoring System

A safety monitoring system means a fall protection system in which a competent person is responsible for recognizing and warning employees of fall hazards. The duties of the safety monitor are to:

1. Warn by voice when approaching the open edge in an unsafe manner.
2. Warn by voice if there is a dangerous situation developing which cannot be seen by another person involved with product placement, such as a member getting out of control.
3. Make the designated erectors aware they are in a dangerous area.
4. Be competent in recognizing fall hazards.
5. Warn employees when they appear to be unaware of a fall hazard or are acting in an unsafe manner.
6. Be on the same walking/working surface as the monitored employees and within visual sighting distance of the monitored employees.
7. Be close enough to communicate orally with the employees.
8. Not allow other responsibilities to encumber monitoring. If the safety monitor becomes too encumbered with other responsibilities, the monitor shall (1) stop the erection process; and (2) turn over other responsibilities to a designated erector; or (3) turn over the safety monitoring function to another designated, competent person. The safety monitoring system shall not be used when the wind is strong enough to cause loads with large surface areas to swing out of radius, or result in loss of control of the load, or when weather conditions cause the walking-working surfaces to become icy or slippery.

Control Zone System

A controlled access zone means an area designated and clearly marked, in which leading edge work may take place without the use of guardrail, safety net or personal fall arrest systems to protect the employees in the area. Control zone systems shall comply with the following provisions:

1. When used to control access to areas where leading edge and other operations are taking place the controlled access zone shall be defined by a control line or by any other means that restricts access. When control lines are used, they shall be erected not less than 6 feet (1.8 m) nor more than 60 feet (18 m) or half the length of the member being erected, whichever is less, from the leading edge.
2. The control line shall extend along the entire length of the unprotected or leading edge and shall be approximately parallel to the unprotected or leading edge.
3. The control line shall be connected on each side to a guardrail system or wall.
4. Control lines shall consist of ropes, wires, tapes, or equivalent materials, and supporting stanchions as follows:
5. Each line shall be flagged or otherwise clearly marked at not more than 6-foot (1.8 m) intervals with high-visibility material.
6. Each line shall be rigged and supported in such a way that its lowest point (including sag) is not less than 39 inches (1 m) from the walking/working surface and its highest point is not more than 45 inches (1.3 m) from the walking/working surface.
7. Each line shall have a minimum breaking strength of 200 pounds (.88 kN).

Holes

All openings greater than 12 in. x 12 in. will have perimeter guarding or covering. All predetermined holes will have the plywood covers made in the precasters' yard and shipped with the member to the jobsite. Prior to cutting holes on the job, proper protection for the hole must be provided to protect the workers. Perimeter guarding or covers will not be removed without the approval of the erection foreman.

Precast concrete column erection through the existing deck requires that many holes be provided through this deck. These are to be covered and protected. Except for the opening being currently used to erect a column, all opening protection is to be left undisturbed. The opening being uncovered to erect a column will become part of the point of erection and will be addressed as part of this Fall Protection Plan. This uncovering is to be done at the erection foreman's direction and will only occur immediately prior to "feeding" the column through the opening. Once the end of the column is through the slab opening, there will no longer exist a fall hazard at this location.

III. Implementation of Fall Protection Plan

The structure being erected is a multistory total precast concrete building consisting of columns, beams, wall panels and hollow core slabs and double tee floor and roof members.

The following is a list of the products and erection situations on this job:

Columns

For columns 10 ft to 36 ft long, employees disconnecting crane hooks from columns will work from a ladder and wear a body belt/harness with lanyard and be tied off when both hands are needed to disconnect. For tying off, a vertical lifeline will be connected to the lifting eye at the top of the column, prior to lifting, to be used with a manually operated or mobile rope grab. For columns too high for the use of a ladder, 36 ft and higher, an added cable will be used to reduce the height of the disconnecting point so that a ladder can be used. This cable will be left in place until a point in erection that it can be removed safely. In some cases, columns will be unhooked from the crane by using an erection tube or shackle with a pull pin which is released from the ground after the column is stabilized.

The column will be adequately connected and/or braced to safely support the weight of a ladder with an employee on it.

Inverted Tee Beams

Employees erecting inverted tee beams, at a height of 6 to 40 ft, will erect the beam, make initial connections, and final alignment from a ladder. If the employee needs to reach over the side of the beam to bar or make an adjustment to the alignment of the beam, they will mount the beam and be tied off to the lifting device in the beam after ensuring the load has been stabilized on its bearing. To disconnect the crane from the beam an employee will stand a ladder against the beam. Because the use of ladders is not practical at heights above 40 ft, beams will be initially placed with the use of tag lines and their final alignment made by a person on a manlift or similar employee positioning systems.

Spandrel Beams

Spandrel beams at the exterior of the building will be aligned as closely as possible with the use of tag lines with the final placement of the spandrel beam made from a ladder at the open end of the structure. A ladder will be used to make the initial connections and a ladder will be used to disconnect the crane. The other end of the beam will be placed by the designated erector from the double tee deck under the observation of the safety monitor.

The beams will be adequately connected and/or braced to safely support the weight of a ladder with an employee on it.

Floor and Roof Members

During installation of the precast concrete floor and/or roof members, the work deck continuously increases in area as more and more units are being erected and positioned. Thus, the unprotected floor/roof perimeter is constantly modified with the leading edge changing location as each member is installed. The fall protection for workers at the leading edge shall be assured by properly constructed and maintained control zone lines not more than 60 ft away from the leading edge supplemented by a safety monitoring system to ensure the safety of all designated erectors working within the area defined by the control zone lines.

The hollow core slabs erected on the masonry portion of the building will be erected and grouted using the safety monitoring system. Grout will be placed in the space between the end of the slab and face shell of the concrete masonry by dumping from a wheelbarrow. The grout in the keyways between the slabs will be dumped from a wheelbarrow and then spread with long handled tools, allowing the worker to stand erect facing toward the unprotected edge and back from any work deck edge.

Whenever possible, the designated erectors will approach the incoming member at the leading edge only after it is below waist height so that the member itself provides protection against falls.

Except for the situations described below, when the arriving floor or roof member is within 2 to 3 inches of its final position, the designated erectors can then proceed to their position of erection at each end of the member under the control of the safety monitor. Crane hooks will be unhooked from double tee members by designated erectors under the direction and supervision of the safety monitor.

Designated erectors, while waiting for the next floor or roof member, will be constantly under the control of the safety monitor for fall protection and are directed to stay a minimum of six (6) ft from the edge. In the event a designated erector must move from one end of a member, which has just been placed at the leading edge, they must first move away from the leading edge a minimum of six (6) ft and then progress to the other end while maintaining the minimum distance of six (6) ft at all times.

Erection of double tees, where conditions require bearing of one end into a closed pocket and the other end on a beam ledge, restricting the tee legs from going directly into the pockets, require special considerations. The tee legs that are to bear in the closed pocket must hang lower than those at the beam bearing. The double tee will be "two-lined" in order to elevate one end higher than the other to allow for the low end to be ducked into the closed pocket using the following procedure.

The double tee will be rigged with a standard four-way spreader off of the main load line. An additional choker will be attached to the married point of the two-legged spreader at the end of the tee that is to be elevated. The double tee will be hoisted with the main load line and swung into a position as close as possible to the tee's final bearing elevation. When the tee is in this position and stabilized, the whip line load block will be lowered to just above the tee deck. At this time, two erectors will walk out on the suspended tee deck at midspan of the tee member and pull the load block to the end of the tee to be elevated and attach the additional choker to the load block. The possibility of entanglement with the crane lines and other obstacles during this two-lining process while raising and lowering the crane block on that second line could be hazardous to an encumbered employee. Therefore, the designated erectors will not tie off during any part of this process. While the designated erectors are on the double tee, the safety monitoring system will be used. After attaching the choker, the two erectors then step back on the previously erected tee deck and signal the crane operator to hoist the load with the whip line to the elevation that will allow for enough clearance to let the low-end tee legs slide into the pockets when the main load line is lowered. The erector, who is handling the lowered end of the tee at the closed pocket bearing, will step out on the suspended tee. An erection bar will then be placed between the end of the tee leg and the inside face of the pocketed spandrel member. The tee is barred away from the pocketed member to reduce the friction and lateral force against the pocketed member. As the tee is being lowered, the other erector remains on the tee which was previously erected to handle the other end. At this point the tee is slowly lowered by the crane to a point where the tee legs can freely slide into the pockets. The erector working the lowered end of the tee must keep pressure on the bar between the tee and the face of the pocketed spandrel member to very gradually let the tee legs slide into the pocket to its proper bearing dimension. The tee is then slowly lowered into its final erected position.

The designated erector should be allowed onto the suspended double tee, otherwise there is no control over the horizontal movement of the double tee and this movement could knock the spandrel off of its bearing or the column out of plumb. The control necessary to prevent hitting the spandrel can only be done safely from the top of the double tee being erected.

Loadbearing Wall Panels: The erection of the loadbearing wall panels on the elevated decks requires the use of a safety monitor and a controlled access zone that is a minimum of 25 ft and a maximum of 1/2 the length of the wall panels away from the unprotected edge, so that designated erectors can move freely and unencumbered when receiving the panels. Bracing, if required for stability, will be installed by ladder. After the braces are secured, the crane will be disconnected from the wall by using a ladder. The wall to wall connections will also be performed from a ladder.

Non-Loadbearing Panels (Cladding): The locating of survey lines, panel layout and other installation prerequisites (prewelding, etc.) for non-loadbearing panels (cladding) will not commence until floor perimeter and floor openings have been protected. In some areas, it is necessary because of panel configuration to remove the perimeter protection as the cladding is being installed. Removal of perimeter protection will be performed on a bay to bay basis, just ahead of cladding erection to minimize temporarily unprotected floor edges. Those workers within 6 ft of the edge, receiving and positioning the cladding when the perimeter protection is removed shall be tied off.

Detailing

Employees exposed to falls of six (6) feet or more to lower levels, who are not actively engaged in leading edge work or connecting activity, such as welding, bolting, cutting, bracing, guying, patching, painting or other operations, and who are working less than six (6) ft from an unprotected edge will be tied off at all times or guardrails will be installed. Employees engaged in these activities but who are more than six (6) ft from an unprotected edge as defined by the control zone lines, do not require fall protection but a warning line or control lines must be erected to remind employees they are approaching an area where fall protection is required.

IV. Conventional Fall Protection Considered for the Point of Erection or Leading-Edge Erection Operations

A. Personal Fall Arrest Systems

In this particular erection sequence and procedure, personal fall arrest systems requiring body belt/harness systems, lifelines and lanyards will not reduce possible hazards to workers and will create offsetting hazards during their usage at the leading edge of precast/prestressed concrete construction.

Leading edge erection and initial connections are conducted by employees who are specifically trained to do this type of work and are trained to recognize the fall hazards. The nature of such work normally exposes the employee to the fall hazard for a short period of time and installation of fall protection systems for a short duration is not feasible because it exposes the installers of the system to the same fall hazard, but for a longer period of time.

1. It is necessary that the employee be able to move freely without encumbrance in order to guide the sections of precast concrete into their final position without having lifelines attached which will restrict the employee's ability to move about at the point of erection.
2. A typical procedure requires 2 or more workers to maneuver around each other as a concrete member is positioned to fit into the structure. If they are each attached to a lifeline, part of their attention must be diverted from their main task of positioning a member weighing several tons to the task of avoiding entanglements of their lifelines or avoiding tripping over lanyards.

Therefore, if these workers are attached to lanyards, more fall potential would result than from not using such a device. In this specific erection sequence and procedure, retractable lifelines do not solve the problem of two workers becoming tangled. In fact, such a tangle could prevent the lifeline from retracting as the worker moved, thus potentially exposing the worker to a fall greater than 6 ft. Also, a worker crossing over the lifeline of another worker can create a hazard because the movement of one person can unbalance the other. In the event of a fall by one person there is a likelihood that the other person will be caused to fall as well. In addition, if contamination such as grout (during hollow core grouting) enters the retractable housing it can cause excessive wear and damage to the device and could clog the retracting mechanism as the lanyard is dragged across the deck. Obstructing the cable orifice can defeat the device's shock absorbing function, produce cable slack and damage, and adversely affect cable extraction and retraction.

3. Employees tied to a lifeline can be trapped and crushed by moving structural members if the employee becomes restrained by the lanyard or retractable lifeline and cannot get out of the path of the moving load. The sudden movement of a precast concrete member being raised by a crane can be caused by a number of factors. When this happens, a connector may immediately have to move a considerable distance to avoid injury. If a tied off body belt/harness is being used, the connector could be trapped. Therefore, there is a greater risk of injury if the connector is tied to the structure for this specific erection sequence and procedure.

When necessary to move away from a retractable device, the worker cannot move at a rate greater than the device locking speed typically 3.5 to 4.5 ft/sec. When moving toward the device it is necessary to move at a rate which does not permit cable slack to build up. This slack may cause cable retraction acceleration and cause a worker to lose their balance by applying a higher than normal jerking force on the body when the cable suddenly becomes taut after building up momentum. This slack can also cause damage to the internal spring-loaded drum, uneven coiling of cable on the drum, and possible cable damage.

The factors causing sudden movements for this location include:

- (a) Cranes
 - (1) Operator error.
 - (2) Site conditions (soft or unstable ground).
 - (3) Mechanical failure.
 - (4) Structural failure.
 - (5) Rigging failure.
 - (6) Crane signal/radio communication failure.
- (b) Weather Conditions
 - (1) Wind (strong wind/sudden gusting) - particularly a problem with the large surface areas of precast concrete members.
 - (2) Snow/rain (visibility).
 - (3) Fog (visibility).
 - (4) Cold - causing slowed reactions or mechanical problems.
- (c) Structure/Product Conditions.
 - (1) Lifting Eye failure.
 - (2) Bearing failure or slippage.
 - (3) Structure shifting.
 - (4) Bracing failure.
 - (5) Product failure.
- (d) Human Error.
 - (1) Incorrect tag line procedure.
 - (2) Tag line hang-up.
 - (3) Incorrect or misunderstood crane signals.
 - (4) Misjudged elevation of member.
 - (5) Misjudged speed of member.
 - (6) Misjudged angle of member.

4. Anchorages or special attachment points could be cast into the precast concrete members if sufficient preplanning and consideration of erectors' position is done before the members are cast. Any hole or other attachment must be approved by the engineer who designed the member. It is possible that some design restrictions will not allow a member to be weakened by an additional hole; however, it is anticipated that such situations would be the exception, not the rule. Attachment points, other than on the deck surface, will require removal and/or patching. In order to remove and/or patch these points, requires the employee to be exposed to an additional fall hazard at an unprotected perimeter. The fact that attachment points could be available anywhere on the structure does not eliminate the hazards of using these points for tying off as discussed above. A logical point for tying off on double tees would be using the lifting loops, except that they must be cut off to eliminate a tripping hazard at an appropriate time.
5. Providing attachment at a point above the walking/working surface would also create fall exposures for employees installing their devices. Final positioning of a precast concrete member requires it to be moved in such a way that it must pass through the area that would be occupied by the lifeline and the lanyards attached to the point above. Resulting entanglements of lifelines and lanyards on a moving member could pull employees from the work surface. Also, the structure is being created and, in most cases, there is no structure above the members being placed.
 - (a) Temporary structural supports, installed to provide attaching points for lifelines limit the space which is essential for orderly positioning, alignment and placement of the precast concrete members. To keep the lanyards a reasonable and manageable length, lifeline supports would necessarily need to be in proximity to the positioning process. A sudden shift of the precast concrete member being positioned because of wind pressure or crane movement could make it strike the temporary supporting structure, moving it suddenly and causing tied off employees to fall.
 - (b) The time in manhours which would be expended in placing and maintaining temporary structural supports for lifeline attaching points could exceed the expended manhours involved in placing the precast concrete members. No protection could be provided for the employees erecting the temporary structural supports and these supports would have to be moved for each successive step in the construction process, thus greatly increasing the employee's exposure to the fall hazard.
 - (c) The use of a cable strung horizontally between two columns to provide tie off lines for erecting or walking a beam for connecting work is not feasible and creates a greater hazard on this multi-story building for the following reasons:
 - (1) If a connector is to use such a line, it must be installed between the two columns. To perform this installation requires an erector to have more fall exposure time attaching the cable to the columns than would be spent to make the beam to column connection itself.
 - (2) If such a line is to be installed so that an erector can walk along a beam, it must be overhead or below him. For example, if a connector must walk along a 24 in. wide beam, the presence of a line next to the connector at waist level, attached directly to the columns, would prevent the connector from centering their weight over the beam and balancing themselves. Installing the line above the connector might be possible on the first level of a two-story column; however, the column may extend only a few feet above the floor level at the second level or be flush with the floor level. Attaching the line to the side of the beam could be a solution; however, it would require the connector to attach the lanyard below foot level which would most likely extend a fall farther than 6 ft.
 - (3) When lines are strung over every beam, it becomes more and more difficult for the crane operator to lower a precast concrete member into position without the member becoming fouled. Should the member become entangled, it could easily dislodge the line from a column. If a worker is tied to it at the time, a fall could be caused.
6. The ANSI A10.14-1991 American National Standard for Construction and Demolition Operations - Requirements for Safety Belts, Harnesses, Lanyards and Lifelines for Construction and Demolition Use, states that the anchor point of a lanyard or deceleration device should, if possible, be located above the wearer's belt or harness attachment. ANSI A10.14 also states that a suitable anchorage point is one which is located as high as possible to prevent contact with an obstruction below should the worker fall. Most manufacturers also warn in the user's handbook that the safety block/retractable lifeline must be positioned above the D-ring (above the work space of the intended user) and OSHA recommends that fall arrest and restraint equipment be used in accordance with the manufacturer's instructions.

Attachment of a retractable device to a horizontal cable near floor level or using the inserts in the floor or roof members may result in increased free fall due to the dorsal D-ring of the full-body harness riding higher than the attachment point of the snaphook to the cable or insert (e.g., 6 foot tall worker with a dorsal D-ring at 5 feet above the floor or surface, reduces the working length to only one foot, by placing the anchorage five feet away from the fall hazard). In addition, impact loads may exceed maximum fall arrest forces (MAF) because the fall arrest D-ring would be 4 to 5 feet higher than the safety block/retractable lifeline anchored to the walking-working surface; and the potential for swing hazards is increased. Manufacturers also require that workers not work at a level where the point of snaphook attachment to the body harness is above the device because this will increase the free fall distance and the deceleration distance and will cause higher forces on the body in the event of an accidental fall.

Manufacturers recommend an anchorage for the retractable lifeline which is immovably fixed in space and is independent of the user's support systems. A moveable anchorage is one which can be moved around (such as equipment or wheeled vehicles) or which can deflect substantially under shock loading (such as a horizontal cable or very flexible beam). In the case of a very flexible anchorage, a shock load applied to the anchorage during fall arrest can cause oscillation of the flexible anchorage such that the retractable brake mechanism may undergo one or more cycles of locking/unlocking/locking (ratchet effect) until the anchorage deflection is dampened. Therefore, use of a moveable anchorage involves critical engineering and safety factors and should only be considered after fixed anchorage has been determined to be not feasible.

Horizontal cables used as an anchorage present an additional hazard due to amplification of the horizontal component of maximum arrest force (of a fall) transmitted to the points where the horizontal cable is attached to the structure. This amplification is due to the angle of sag of a horizontal cable and is most severe for small angles of sag. For a cable sag angle of 2 degrees the horizontal force on the points of cable attachment can be amplified by a factor of 15.

It is also necessary to install the retractable device vertically overhead to minimize swing falls. If an object is in the worker's swing path (or that of the cable) hazardous situations exist:

- (1) due to the swing, horizontal speed of the user may be high enough to cause injury when an obstacle in the swing fall path is struck by either the user or the cable;
- (2) the total vertical fall distance of the user may be much greater than if the user had fallen only vertically without a swing fall path.

With retractable lines, overconfidence may cause the worker to engage in inappropriate behavior, such as approaching the perimeter of a floor or roof at a distance appreciably greater than the shortest distance between the anchorage point and the leading edge. Though the retractable lifeline may arrest a worker's fall before he or she has fallen a few feet, the lifeline may drag along the edge of the floor or beam and swing the worker like a pendulum until the line has moved to a position where the distance between the anchorage point and floor edge is the shortest distance between those two points. Accompanying this pendulum swing is a lowering of the worker, with the attendant danger that he or she may violently impact the floor or some obstruction below.

The risk of a cable breaking is increased if a lifeline is dragged sideways across the rough surface or edge of a concrete member at the same moment that the lifeline is being subjected to a maximum impact loading during a fall. The typical 3/16 in. cable in a retractable lifeline has a breaking strength of from 3000 to 3700 lbs.

7. The competent person, who can take into account the specialized operations being performed on this project, should determine when and where a designated erector cannot use a personal fall arrest system.

B. Safety Net Systems

The nature of this particular precast concrete erection worksite precludes the safe use of safety nets where point of erection or leading-edge work must take place.

1. To install safety nets in the interior high bay of the single-story portion of the building poses rigging attachment problems. Structural members do not exist to which supporting devices for nets can be attached in the area where protection is required. As the erection operation advances, the location of point of erection or leading-edge work changes constantly as each member is attached to the structure. Due to this constant change it is not feasible to set net sections and build separate structures to support the nets.
2. The nature of the erection process for the precast concrete members is such that an installed net would protect workers as they position and secure only one structural member. After each member is stabilized the net would have to be moved to a new location (this could mean a move of 8 to 10 ft or the possibility of a move to a different level or area of the structure) to protect workers placing the next piece in the construction sequence. The result would be the installation and dismantling of safety nets repeatedly throughout the normal work day. As the time necessary to install a net, test, and remove it is significantly greater than the time necessary to position and secure a precast concrete member, the exposure time for the worker installing the safety net would be far longer than for the workers whom the net is intended to protect. The time exposure repeats itself each time the nets and supporting hardware must be moved laterally or upward to provide protection at the point of erection or leading edge.

3. Strict interpretation of 1926.502(c) requires that operations shall not be undertaken until the net is in place and has been tested. With the point of erection constantly changing, the time necessary to install and test a safety net significantly exceeds the time necessary to position and secure the concrete member.
4. Use of safety nets on exposed perimeter wall openings and opensided floors, causes attachment points to be left in architectural concrete which must be patched and filled with matching material after the net supporting hardware is removed. In order to patch these openings, additional numbers of employees must be suspended by swing stages, boatswain chairs or other devices, thereby increasing the amount of fall exposure time to employees.
5. Installed safety nets pose an additional hazard at the perimeter of the erected structure where limited space is available in which members can be turned after being lifted from the ground by the crane. There would be a high probability that the member being lifted could become entangled in net hardware, cables, etc.
6. The use of safety nets where structural wall panels are being erected would prevent movement of panels to point of installation. To be effective, nets would necessarily have to provide protection across the area where structural supporting wall panels would be set and plumbed before roof units could be placed.
7. Use of a tower crane for the erection of the high-rise portion of the structure poses a particular hazard in that the crane operator cannot see or judge the proximity of the load in relation to the structure or nets. If the signaler is looking through nets and supporting structural devices while giving instructions to the crane operator, it is not possible to judge precise relationships between the load and the structure itself or to nets and supporting structural devices. This could cause the load to become entangled in the net or hit the structure causing potential damage.

C. Guardrail Systems

On this particular worksite, guardrails, barricades, ropes, cables or other perimeter guarding devices or methods on the erection floor will pose problems to safe erection procedures. Typically, a floor or roof is erected by placing 4 to 10 ft wide structural members next to one another and welding or grouting them together. The perimeter of a floor and roof changes each time a new member is placed into position. It is unreasonable and virtually impossible to erect guardrails and toe boards at the ever-changing leading edge of a floor or roof.

1. To position a member safely it is necessary to remove all obstructions extending above the floor level near the point of erection. Such a procedure allows workers to swing a new member across the erected surface as necessary to position it properly without worrying about knocking material off of this surface.

Hollow core slab erection on the masonry wall requires installation of the perimeter protection where the masonry wall has to be constructed. This means the guardrail is installed then subsequently removed to continue the masonry construction. The erector will be exposed to a fall hazard for a longer period of time while installing and removing perimeter protection than while erecting the slabs.

In hollow core work, as in other precast concrete erection, others are not typically on the work deck until the precast concrete erection is complete. The deck is not complete until the leveling, aligning, and grouting of the joints is done. It is normal practice to keep others off the deck until at least the next day after the installation is complete to allow the grout to harden.

2. There is no permanent boundary until all structural members have been placed in the floor or roof. At the leading edge, workers are operating at the temporary edge of the structure as they work to position the next member in the sequence. Compliance with the standard would require a guardrail and toe board be installed along this edge. However, the presence of such a device would prevent a new member from being swung over the erected surface low enough to allow workers to control it safely during the positioning process. Further, these employees would have to work through the guardrail to align the new member and connect it to the structure. The guardrail would not protect an employee who must lean through it to do the necessary work, rather it would hinder the employee to such a degree that a greater hazard is created than if the guardrail were absent.
3. Guardrail requirements pose a hazard at the leading edge of installed floor or roof sections by creating the possibility of employees being caught between guardrails and suspended loads. The lack of a clear work area in which to guide the suspended load into position for placement and welding of members into the existing structure creates still further hazards.
4. Where erection processes require precast concrete stairways or openings to be installed as an integral part of the overall erection process, it must also be recognized that guardrails or handrails must not project above the surface of the erection floor. Such guardrails should be terminated at the level of the erection floor to avoid placing hazardous obstacles in the path of a member being positioned.

V. Other Fall Protection Measures Considered for This Job

The following is a list and explanation of other fall protection measures available and an explanation of limitations for use on this particular jobsite. If during the course of erecting the building the employee sees an area that could be erected more safely by the use of these fall protection measures, the foreman should be notified.

A. Scaffolds are not used because:

1. The leading edge of the building is constantly changing, and the scaffolding would have to be moved at very frequent intervals. Employees erecting and dismantling the scaffolding would be exposed to fall hazards for a greater length of time than they would by merely erecting the precast concrete member.
2. A scaffold tower could interfere with the safe swinging of a load by the crane.
3. Power lines, terrain and site do not allow for the safe use of scaffolding.

B. Vehicle mounted platforms are not used because:

1. A vehicle mounted platform will not reach areas on the deck that are erected over other levels.
2. The leading edge of the building is usually over a lower level of the building and this lower level will not support the weight of a vehicle mounted platform.
3. A vehicle mounted platform could interfere with the safe swinging of a load by the crane, either by the crane swinging the load over or into the equipment.
4. Power lines and surrounding site work do not allow for the safe use of a vehicle mounted platform.

C. Crane suspended personnel platforms are not used because:

1. A second crane close enough to suspend any employee in the working and erecting area could interfere with the safe swinging of a load by the crane hoisting the product to be erected.
2. Power lines and surrounding site work do not allow for the safe use of a second crane on the job.

VI. Enforcement

Constant awareness of and respect for fall hazards, and compliance with all safety rules are considered conditions of employment. The jobsite Superintendent, as well as individuals in the Safety and Personnel Department, reserve the right to issue disciplinary warnings to employees, up to and including termination, for failure to follow the guidelines of this program.

VII. Accident Investigations

All accidents that result in injury to workers, regardless of their nature, shall be investigated and reported. It is an integral part of any safety program that documentation take place as soon as possible so that the cause and means of prevention can be identified to prevent a reoccurrence.

In the event that an employee falls or there is some other related, serious incident occurring, this plan shall be reviewed to determine if additional practices, procedures, or training need to be implemented to prevent similar types of falls or incidents from occurring.

VIII. Changes to Plan

Any changes to the plan will be approved by (name of the qualified person). This plan shall be reviewed by a qualified person as the job progresses to determine if additional practices, procedures or training needs to be implemented by the competent person to improve or provide additional fall protection. Workers shall be notified and trained, if necessary, in the new procedures. A copy of this plan and all approved changes shall be maintained at the jobsite.

| |
|--|
| Sample Fall Protection Plan for Residential Construction (Insert Company Name) |
| This Fall Protection Plan Is Specific For The Following Project: |
| Location of Job |
| Date Plan Prepared or Modified |
| Plan Prepared By |
| Plan Approved By |
| Plan Supervised By |

The following Fall Protection Plan is a sample program prepared for the prevention of injuries associated with falls. A Fall Protection Plan must be developed and evaluated on a site by site basis. It is recommended that builders discuss the written Fall Protection Plan with their OSHA Area Office prior to going on a jobsite.

I. Statement of Company Policy

(Your company name here) is dedicated to the protection of its employees from on-the-job injuries. All employees of (Your company name here) have the responsibility to work safely on the job. The purpose of the plan is to supplement our existing safety and health program and to ensure that every employee who works for (Your company name here) recognizes workplace fall hazards and takes the appropriate measures to address those hazards.

This Fall Protection Plan addresses the use of conventional fall protection at a number of areas on the project, as well as identifies specific activities that require non-conventional means of fall protection. During the construction of residential buildings under 48 feet in height, it is sometimes infeasible, or it creates a greater hazard to use conventional fall protection systems at specific areas or for specific tasks. The areas or tasks may include, but are not limited to:

- a. Setting and bracing of roof trusses and rafters;
- b. Installation of floor sheathing and joists;
- c. Roof sheathing operations; and
- d. Erecting exterior walls.

In these cases, conventional fall protection systems may not be the safest choice for builders. This plan is designed to enable employers and employees to recognize the fall hazards associated with this job and to establish the safest procedures that are to be followed in order to prevent falls to lower levels or through holes and openings in walking/working surfaces.

Each employee will be trained in these procedures and will strictly adhere to them except when doing so would expose the employee to a greater hazard. If, in the employee's opinion, this is the case, the employee is to notify the competent person of their concern and have the concern addressed before proceeding.

It is the responsibility of (name of competent person) to implement this Fall Protection Plan. Continual observational safety checks of work operations and the enforcement of the safety policy and procedures shall be regularly enforced. The crew supervisor or foreman (insert name) is responsible for correcting any unsafe practices or conditions immediately.

It is the responsibility of the employer to ensure that all employees understand and adhere to the procedures of this plan and to follow the instructions of the crew supervisor. It is also the responsibility of the employee to bring to management's attention any unsafe or hazardous conditions or practices that may cause injury to either themselves or any other employees. Any changes to the Fall Protection Plan must be approved by (name of qualified person).

II. Fall Protection Systems To Be Used on This Job

Installation of roof trusses/rafters, exterior wall erection, roof sheathing, floor sheathing and joist/truss activities will be conducted by employees who are specifically trained to do this type of work and are trained to recognize the fall hazards. The nature of such work normally exposes the employee to the fall hazard for a short period of time. This Plan details how (Your company name here) will minimize these hazards.

Controlled Access Zones

When using the Plan to implement the fall protection options available, workers must be protected through limited access to high hazard locations. Before any non-conventional fall protection systems are used as part of the work plan, a controlled access zone (CAZ) shall be clearly defined by the competent person as an area where a recognized hazard exists. The demarcation of the CAZ shall be communicated by the competent person in a recognized manner, either through signs, wires, tapes, ropes or chains.

(Your company name here) shall take the following steps to ensure that the CAZ is clearly marked or controlled by the competent person:

All access to the CAZ must be restricted to authorized entrants;

All workers who are permitted in the CAZ shall be listed in the appropriate sections of the Plan (or be visibly identifiable by the competent person) prior to implementation;

The competent person shall ensure that all protective elements of the CAZ be implemented prior to the beginning of work.

Installation Procedures for Roof Truss and Rafter Erection

During the erection and bracing of roof trusses/rafters, conventional fall protection may present a greater hazard to workers. On this job, safety nets, guardrails and personal fall arrest systems will not provide adequate fall protection because the nets will cause the walls to collapse, while there are no suitable attachment or anchorage points for guardrails or personal fall arrest systems.

On this job, requiring workers to use a ladder for the entire installation process will cause a greater hazard because the worker must stand on the ladder with his back or side to the front of the ladder. While erecting the truss or rafter the worker will need both hands to maneuver the truss and therefore cannot hold onto the ladder. In addition, ladders cannot be adequately protected from movement while trusses are being maneuvered into place. Many workers may experience additional fatigue because of the increase in overhead work with heavy materials, which can also lead to a greater hazard.

Exterior scaffolds cannot be utilized on this job because the ground, after recent backfilling, cannot support the scaffolding. In most cases, the erection and dismantling of the scaffold would expose workers to a greater fall hazard than erection of the trusses/rafters.

On all walls eight feet or less, workers will install interior scaffolds along the interior wall below the location where the trusses/rafters will be erected. "Sawhorse" scaffolds constructed of 46-inch sawhorses and 2x10 planks will often allow workers to be elevated high enough to allow for the erection of trusses and rafters without working on the top plate of the wall.

In structures that have walls higher than eight feet and where the use of scaffolds and ladders would create a greater hazard, safe working procedures will be utilized when working on the top plate and will be monitored by the crew supervisor. During all stages of truss/rafter erection the stability of the trusses/rafters will be ensured at all times.

(Your company name here) shall take the following steps to protect workers who are exposed to fall hazards while working from the top plate installing trusses/rafters:

Only the following trained workers will be allowed to work on the top plate during roof truss or rafter installation:

Workers shall have no other duties to perform during truss/rafter erection procedures;

All trusses/rafters will be adequately braced before any worker can use the truss/rafter as a support;

Workers will remain on the top plate using the previously stabilized truss/rafter as a support while other trusses/rafters are being erected;

Workers will leave the area of the secured trusses only when it is necessary to secure another truss/rafter;

The first two trusses/rafters will be set from ladders leaning on side walls at points where the walls can support the weight of the ladder; and

A worker will climb onto the interior top plate via a ladder to secure the peaks of the first two trusses/rafters being set.

The workers responsible for detaching trusses from cranes and/or securing trusses at the peaks traditionally are positioned at the peak of the trusses/rafters. There are also situations where workers securing rafters to ridge beams will be positioned on top of the ridge beam.

(Your company name here) shall take the following steps to protect workers who are exposed to fall hazards while securing trusses/rafters at the peak of the trusses/ridge beam:

Only the following trained workers will be allowed to work at the peak during roof truss or rafter installation:

Once truss or rafter installation begins, workers not involved in that activity shall not stand or walk below or adjacent to the roof opening or exterior walls in any area where they could be struck by falling objects;

Workers shall have no other duties than securing/bracing the trusses/ridge beam;

Workers positioned at the peaks or in the webs of trusses or on top of the ridge beam shall work from a stable position, either by sitting on a "ridge seat" or other equivalent surface that provides additional stability or by positioning themselves in previously stabilized trusses/rafters and leaning into and reaching through the trusses/rafters;

Workers shall not remain on or in the peak/ridge any longer than necessary to safely complete the task.

Roof Sheathing Operations

Workers typically install roof sheathing after all trusses/rafters and any permanent truss bracing is in place. Roof structures are unstable until some sheathing is installed, so workers installing roof sheathing cannot be protected from fall hazards by conventional fall protection systems until it is determined that the roofing system can be used as an anchorage point. At that point, employees shall be protected by a personal fall arrest system.

Trusses/rafters are subject to collapse if a worker falls while attached to a single truss with a belt/harness. Nets could also cause collapse, and there is no place to attach guardrails.

All workers will ensure that they have secure footing before they attempt to walk on the sheathing, including cleaning shoes/boots of mud or other slip hazards.

To minimize the time workers must be exposed to a fall hazard, materials will be staged to allow for the quickest installation of sheathing.

(Your company name here) shall take the following steps to protect workers who are exposed to fall hazards while installing roof sheathing:

Once roof sheathing installation begins, workers not involved in that activity shall not stand or walk below or adjacent to the roof opening or exterior walls in any area where they could be struck by falling objects;

The competent person shall determine the limits of this area, which shall be clearly communicated to workers prior to placement of the first piece of roof sheathing;

The competent person may order work on the roof to be suspended for brief periods as necessary to allow other workers to pass through such areas when this would not create a greater hazard;

Only qualified workers shall install roof sheathing;

The bottom row of roof sheathing may be installed by workers standing in truss webs;

After the bottom row of roof sheathing is installed, a slide guard extending the width of the roof shall be securely attached to the roof. Slide guards are to be constructed of no less than nominal 4" height capable of limiting the uncontrolled slide of workers. Workers should install the slide guard while standing in truss webs and leaning over the sheathing;

Additional rows of roof sheathing may be installed by workers positioned on previously installed rows of sheathing. A slide guard can be used to assist workers in retaining their footing during successive sheathing operations; and

Additional slide guards shall be securely attached to the roof at intervals not to exceed 13 feet as successive rows of sheathing are installed. For roofs with pitches in excess of 9-in-12, slide guards will be installed at four-foot intervals.

When wet weather (rain, snow, or sleet) are present, roof sheathing operations shall be suspended unless safe footing can be assured for those workers installing sheathing.

When strong winds (above 40 miles per hour) are present, roof sheathing operations are to be suspended unless wind breakers are erected. Installation of Floor Joists and Sheathing During the installation of floor sheathing/joists (leading edge construction), the following steps shall be taken to protect workers:

Only the following trained workers will be allowed to install floor joists or sheathing:

Materials for the operations shall be conveniently staged to allow for easy access to workers;

The first-floor joists or trusses will be rolled into position and secured either from the ground, ladders or sawhorse scaffolds;

Each successive floor joist or truss will be rolled into place and secured from a platform created from a sheet of plywood laid over the previously secured floor joists or trusses;

Except for the first row of sheathing which will be installed from ladders or the ground, workers shall work from the established deck; and

Any workers not assisting in the leading-edge construction while leading edges still exist (e.g. cutting the decking for the installers) shall not be permitted within six feet of the leading edge under construction.

Erection of Exterior Walls

During the construction and erection of exterior walls, employers shall take the following steps to protect workers:

Only the following trained workers will be allowed to erect exterior walls:

A painted line six feet from the perimeter will be clearly marked prior to any wall erection activities to warn of the approaching unprotected edge;

Materials for operations shall be conveniently staged to minimize fall hazards; and

Workers constructing exterior walls shall complete as much cutting of materials and other preparation as possible away from the edge of the deck.

III. Enforcement

Constant awareness of and respect for fall hazards, and compliance with all safety rules are considered conditions of employment. The crew supervisor or foreman, as well as individuals in the Safety and Personnel Department, reserve the right to issue disciplinary warnings to employees, up to and including termination, for failure to follow the guidelines of this program.

IV. Accident Investigations

All accidents that result in injury to workers, regardless of their nature, shall be investigated and reported. It is an integral part of any safety program that documentation take place as soon as possible so that the cause and means of prevention can be identified to prevent a reoccurrence.

In the event that an employee falls or there is some other related, serious incident occurring, this plan shall be reviewed to determine if additional practices, procedures, or training need to be implemented to prevent similar types of falls or incidents from occurring.

V. Changes to Plan

Any changes to the plan will be approved by (name of the qualified person). This plan shall be reviewed by a qualified person as the job progresses to determine if additional practices, procedures or training needs to be implemented by the competent person to improve or provide additional fall protection. Workers shall be notified and trained, if necessary, in the new procedures. A copy of this plan and all approved changes shall be maintained at the jobsite.

[59 FR 40746, Aug. 9, 1994; 60 FR 5131, Jan. 26, 1995]



Michigan Occupational Safety and Health Administration
PO Box 30643
Lansing, Michigan 48909-8143
For technical questions of this standard – Ph: 517-284-7680 (CSHD) or 517-284-7720 (CETD)
To order copies of this standard – Ph: 517-284-7740

The Department of Labor and Economic Opportunity will not discriminate against any individual or group because of race, sex, religion, age, national origin, color, marital status, disability, or political beliefs. Auxiliary aids, services and other reasonable accommodations are available upon request to individuals with disabilities.

Enforcement Policy

MIOSHA

Construction Safety and Health Division
 Michigan Occupational Safety and Health Administration
 Department of Labor and Economic Opportunity (LEO)

DIVISION INSTRUCTION

DOCUMENT IDENTIFIER:
 CSHD-COM-04-1R3

DATE:
 January 22, 2020

SUBJECT: Residential Fall Protection Compliance Criteria

- I. Purpose. This instruction establishes MIOSHA enforcement policy on fall protection for residential construction activities.
- II. Scope. This instruction applies to the Construction Safety and Health Division.
- III. References.
 - A. MIOSHA Construction Safety Standard Part 11. /R408.41101 et seq., [Fixed and Portable Ladders.](#)
 - B. MIOSHA Construction Safety Standard Part 12. /R408.41201 et seq., [Scaffolds and Scaffold Platforms.](#)
 - C. MIOSHA Construction Safety Standard Part 32. /R408.43201 et seq., [Aerial Work Platforms.](#)
 - D. MIOSHA Construction Safety Standard Part 45. /R408.44501 et seq., [Fall Protection.](#)
 - E. Occupational Safety and Health Administration (OSHA) Instruction STD 03-11-002, December 16, 2010, [Compliance Guidelines for Residential Construction.](#)
 - F. OSHA 29 CFR Part 1926-Subpart M, [Fall Protection.](#)
- IV. Distribution. MIOSHA Staff; Federal OSHA; S-drive Accessible; MIOSHA Messenger; and Internet Accessible.
- V. Cancellations. All previous versions of this division instruction.
- VI. Next Review Date. This instruction will be reviewed in five years from date of issuance.
- VII. History. History of previous versions include:
 - CSHD-COM-04-1R2, March 30, 2015
 - CSHD-COM-04-1R1, March 25, 2011
 - CSHD-COM-04-1, June 25, 2004
- VIII. Contact. [Lawrence Hidalgo, Jr.](#), Director, Construction Safety and Health Division
- IX. Originator: Lawrence Hidalgo, Jr., Director
- X. Background. The fall protection requirements for residential construction are located in Construction Safety and Health Standard [Part 45. Fall Protection, Rule 1926.501\(b\)\(13\)](#) which requires fall protection (usually conventional fall protection; e.g., guardrail systems, safety net systems, or personal fall arrest systems) for work six feet or more

CSHD-COM-04-1R3

January 22, 2020

Residential Fall Protection Compliance Criteria

above lower levels, except where employers can demonstrate that such fall protection systems are infeasible or would create a greater hazard. Although the standard does not mention personal fall restraint systems, MIOSHA does accept a properly utilized fall restraint system in lieu of a personal fall arrest system when the restraint system is rigged in such a way that the worker is not exposed to the fall hazard.

Under 1926.501(b)(13), the employer is not required to use conventional fall protection if they can demonstrate that doing so is infeasible or would pose a greater hazard. Instead, in that situation, the employer must develop and implement a written site-specific fall protection plan meeting the requirements of [1926.502\(k\)](#).

Flexible language was included in 1926.501(b)(13) because of concerns expressed by some commenters during rulemaking about the feasibility and safety of using conventional fall protection for residential construction. As a result, the Construction Safety and Health Division issued the initial instruction of Residential Fall Protection Compliance Criteria on June 24, 2004, which permitted employers engaged in certain residential construction activities to use alternative fall protection measures instead of conventional fall protection. These alternative measures could be used without showing infeasibility or greater hazard and without a written site-specific fall protection plan. This instruction was an interim policy and was never intended to remain as the final policy on fall protection for residential construction activities.

This instruction defined “residential construction” as “structures where the working environment and the construction materials, methods, and procedures employed were essentially the same as those used for typical house (single-family dwelling) and townhouse construction. The instruction stated that “discrete parts of a large commercial structure . . . could come within the scope of the directive (for example, a shingled entranceway to a mall), but . . . that did not mean that the entire structure thereby came within the terms of the directive.” This definition of “residential construction” is not clear and has created confusion for the residential industry and inconsistency in enforcement.

In summary, following the original intent of 1926.501(b)(13) would eliminate confusion in the residential construction industry as to what fall protection methods and systems must be used to be in compliance with MIOSHA fall protection requirements.

- XI. Action Required. Rationale for Revising the initial instruction, dated June 24, 2004. There continues to be high numbers of fall-related fatalities in residential construction. With OSHA’s decision to rescind STD 03-00-001, Plain Language Revision of OSHA Instruction STD 3.1, Interim Fall Protection Compliance for Residential Construction, MIOSHA is required to be “as effective as OSHA.” Many different fall protection options are available to employers that can be used for almost all residential construction operations. This provides separate and independent grounds for MIOSHA's decision to revise this instruction.

There may be isolated situations in which it is infeasible or creates a greater hazard to use conventional fall protection in residential construction and 1926.501(b)(13) provides sufficient flexibility to accommodate employers in these situations. Any employer engaged in residential construction who can demonstrate that the use of conventional fall

CSHD-COM-04-1R3

January 22, 2020

Residential Fall Protection Compliance Criteria

protection is infeasible or creates a greater hazard may use a fall protection plan and alternative fall protection measures in accordance with Part 45 Fall Protection 1926.502(k). Employers also have the option of having workers work from scaffolds (in compliance with Part 12), ladders (in compliance with Part 11) or aerial lifts (in compliance with Part 32) instead of complying with 1926.501(b)(13). Additional methods of fall protection can be found in [Appendix A](#). Revising this instruction and enforcing the original intent of 1926.501(b)(13) for fall protection for residential construction will provide appropriate protection for workers and sufficient compliance flexibility for employers. For these reasons, the Agency is hereby revising this instruction.

XII. Significant Change. Added new Section XIV. Additional Information.

XIII. Residential Construction. For purposes of determining the applicability of section 1926.501(b)(13), the term "residential construction" is interpreted as covering construction work that satisfies the following elements:

- A. The end-use of the structure is required to be a home or dwelling. This comports with the plain meaning of the term "residential" in the text of 1926.501(b)(13) and is consistent with its original intent.
- B. The building in question must be constructed using traditional wood frame construction materials and methods. The term "residential construction" in 1926.501(b)(13) was designed to apply only to the construction of homes using traditional wood frame construction materials and methods. This includes the construction of otherwise covered residences if there is limited use of structural steel in a predominantly wood-framed home, such as a steel I-beam to support wood framing.

Accordingly, it is acceptable within the bounds of "traditional wood frame construction materials and methods" to use cold-formed sheet metal studs in framing.

Many homes and townhouses are built using traditional wood frame construction throughout the structure except for the exterior walls, which are often built with masonry brick or block. The same fall protection methods are likely to be used in the construction of homes built with wood framed and masonry brick or block exterior walls and are consistent with the original intent of 1926.501(b)(13); thus allowing the construction of residences using masonry brick or block for the exterior walls as residential construction.

In accordance with the discussion above, and for purposes of the interpretation of "residential construction" adopted herein, "traditional wood frame construction materials and methods" will be characterized by:

1. Framing materials: Wood (or equivalent cold-formed sheet metal stud) framing, not steel or concrete; wooden floor joists and roof structures.
2. Exterior wall structure: Wood (or equivalent cold-formed sheet metal stud) framing or masonry brick or block.

CSHD-COM-04-1R3

January 22, 2020

Residential Fall Protection Compliance Criteria

3. Methods: Traditional wood frame construction techniques.
- C. Nursing homes, hotels, and similar facilities. To meet the definition of “residential construction,” the end use of the building must be as a home or dwelling and the building must be constructed using traditional wood frame construction materials and method. Construction of nursing homes, hotels, and similar facilities typically involves the use of the following materials in the framework of the structure: precast concrete, steel I-beams (beyond the limited use of steel I-beams in conjunction with wood framing, described above), rebar, and/or poured concrete. These materials are not used in traditional wood frame construction. Buildings that are constructed using these materials will not be considered “residential construction” for purposes of 1926.501(b)(13). However, there may be unusual situations in which a project such as a hotel, motel, or nursing home is being constructed using traditional wood frame construction materials and methods and may meet the definition of “residential construction.” These will be evaluated on a case-by-case basis.
- XIV. Citation Policy.
- A. If an employer engaged in residential construction activities (e.g., carpentry, plumbing, electrical installation) does not provide guardrail systems, safety net arrest systems, personal fall arrest systems, or other fall protection allowed under 1926.501(b), a citation for violating 1926.501(b)(13) will be issued unless the employer can demonstrate the infeasibility of these protective measures or the existence of a greater hazard.
 - B. If the employer demonstrates infeasibility or a greater hazard, the safety officer must determine if the employer has implemented a fall protection plan meeting the requirements of 1926.502(k). Part of that determination will be based on whether the employer has instituted alternative measures to reduce or eliminate fall hazards.
 - C. All fall protection plans under 1926.502(k) are to be in writing and be site-specific. If the fall protection plan is not written, site-specific, or otherwise fails to meet the requirements of 1926.502(k), the violation should be cited as a grouped citation of 1926.501(b)(13) and 1926.502(k). A written plan developed for repetitive use for a particular style/model home will be considered site-specific with respect to a particular site only if it fully addresses all issues related to fall protection at that site.
- XV. Additional Information - OSHA has several resources for Fall Protection. [Fall Protection in Residential Construction](#) (This is a hyperlink)

CSHD-COM-04-1R3
 January 22, 2020
 Residential Fall Protection Compliance Criteria

Appendix A

Residential Fall Protection Methods

Basement Walls:

- Form bracket scaffold
- Welded frame scaffold
- Extension ladders or stepladders

Sill Plate:

- Work from the exterior of the basement walls if the area around basement walls has been backfilled
- Work from ladders or scaffold from the interior of the basement

Floor Joists:

- If area around basement walls has been backfilled, work from the exterior of the basement walls.
- Work from ladders or scaffold from the interior of the basement

Floor Decking:

- Personal fall arrest system (PFAS)
- Floor-mounted anchor with lifeline
- Retractable lifeline
- Engineered fall arrest system
- Controlled Access Zone (with a site-specific plan)
- Do not cut out floor openings until just prior to filling them

Exterior Walls:

- Personal fall arrest system
- Floor-mounted anchor with lifeline
- Retractable lifeline
- Engineered fall arrest system
- Install a guardrail system around the perimeter of the floor areas

Interior Walls:

- Cover or guard window and/or door openings to prevent fall hazards.
- Use exterior framing (stud walls) as a guardrail system (as long as openings are less than 18")

Roof Trusses:

- Use ladders or scaffolds on the interior floor decking to land and secure the trusses.
- Use ladders or scaffolds on the outside of the building to land and secure the trusses.
- Use a lifting hook that can be released remotely or an open hook

Truss Bracing:

- Use of ladders or scaffolds from the floor deck below
- Install temporary truss bracing on the bottom side of the top chord of trusses
- Gang trusses together prior to installation to minimize the amount of temporary bracing needed to be installed after placing trusses

Roof Sheathing:

- Use scaffolds located outside the building to install the first and second rows of roof sheathing
- Use specialized anchor point attached to trusses for personal fall arrest system
- Install guardrails around perimeter of roof
- Install catch platforms around perimeter of roof at eave location

Roofing Material:

- Personal fall arrest system using appropriate roof anchor
- On low sloped roof use safety monitor and/or warning line system
- Install guardrail system
- Follow rules 1926.501(b)(10) and 1926.501(b)(11)

Sample Fall Protection Plan for Residential Work

MIOSHA

Sample Fall Protection Plan for Residential Construction Work



Employers engaged in residential construction work who can demonstrate that it is infeasible or creates a greater hazard to use conventional fall protection systems must develop and follow a site-specific fall protection plan. The plan must conform to the following provisions.

- The plan shall be prepared by a qualified person and developed specifically for the site.
- The plan must be maintained up to date.
- Any changes to the fall protection plan shall be approved by a qualified person.
- A copy of the fall protection plan shall be maintained at the job site.
- The implementation of the fall protection plan shall be under the supervision of a competent person.
- The fall protection plan shall document the reasons why the use of conventional fall protection systems is infeasible or why their use would create a greater hazard.
- The fall protection plan shall include a discussion of other measures that will be taken to reduce or eliminate the fall hazard for workers who cannot be provided with protection from the conventional fall protection systems.
- The fall protection plan shall identify each location where conventional fall protection methods cannot be used. These locations shall then be classified as controlled access zones.

This document is a tool to assist in developing a written site specific fall protection plan that conforms to the provisions of MIOSHA Construction Safety and Health Standard Part 45. Fall Protection rule 1926.502(k). There is no requirement that an employer use this exact format in developing a written site specific fall protection plan. This sample plan is designed to be adapted to each individual employer's need. It does not substitute for a full reading of the standard.

Contact the Consultation, Education, and Training Division at 517-284-7720 or go to the website at www.michigan.gov/cetrca for training and assistance.

Fall Protection Plan for Residential Construction

Enter Company Name Here

A site specific job hazard analysis has determined that conventional fall protection is infeasible or creates a greater hazard for one or more activities at this project. This fall protection plan is specific for the following project:

Location of job:

Date plan prepared or modified:

Plan prepared by:

Plan approved by:

Plan implemented on site by:

Safety monitor:

Employees doing work without conventional fall protection:

(By signing your name, you are verifying that you understand the tasks and the work methods to be used instead of conventional fall protection.)

Written Name

Signature

| | |
|-------|-------|
| _____ | _____ |
| _____ | _____ |
| _____ | _____ |
| _____ | _____ |
| _____ | _____ |
| _____ | _____ |

A separate Job Hazard Analysis (JHA) is required for each jobsite.

I. Statement of Company Policy

Your company name here is dedicated to the protection of its employees from on-the-job injuries. All employees of *your company name here* have the responsibility to work safely on the job. The purpose of the plan is to supplement our existing safety and health program and to ensure that every employee who works for *your company name here* recognizes workplace fall hazards and takes the appropriate measures to address those hazards.

This site specific fall protection plan is available only to our employees engaged in residential construction work who can demonstrate that it is infeasible or it creates a greater hazard to use conventional fall protection equipment. “Infeasible” means that it is impossible to perform the construction work using a conventional fall protection system (i.e., guardrail system, safety net system, or personal fall arrest system) or that it is technologically impossible to use any one of these systems to provide fall protection. This fall protection plan identifies specific activities that require non-conventional means of fall protection. **At all other areas of the job site not specifically addressed by this plan, conventional fall protection and compliance with MIOSHA standards and company rules shall continue.**

This plan is designed to enable employers and employees to recognize the fall hazards associated with this job and to establish the safest procedures to be followed in order to prevent falls to lower levels or through holes and openings in walking/working surfaces.

Each employee will be trained in these procedures and will strictly adhere to them except when doing so would expose the employee to a greater hazard. If, in the employee’s opinion, this is the case, the employee is to notify the competent person of their concern and have the concern addressed before proceeding.

It is the responsibility of name of competent person to implement this fall protection plan. Continual observational safety checks of work operations and the enforcement of the safety policy and procedures shall be regularly enforced. The crew supervisor or foreman, insert name, is responsible for correcting any unsafe practices or conditions immediately.

It is the responsibility of the employer to ensure that all employees understand and adhere to the procedures of this plan and to follow the instructions of the crew supervisor. It is also the responsibility of the employee to bring to management’s attention any unsafe or hazardous conditions or practices that may cause injury to either themselves or any other employees. Any changes to the fall protection plan must be approved by name of qualified person.

II. Infeasibility or Greater Hazard Evaluation

Describe tasks and locations where conventional fall protection is not feasible:

For each task/location where conventional fall protection is not feasible, describe each type of fall protection or work method that was considered. Then, discuss why they these types of fall protection or other work methods are infeasible or would create a greater hazard. At a minimum, discuss personal fall arrest system, guardrails, safety nets, ladders, scaffolds, and aerial work platforms (boom lifts and scissor lifts).

III. Alternative Protective Measures

List and describe the alternative measures that will be taken to reduce or eliminate the fall hazard for workers who cannot be provided with protection from conventional fall protection systems.

IV. Controlled Access Zones

When using a fall protection plan, employees must be protected by limiting access to high hazard locations. Before any non-conventional fall protection system is used as part of the work plan, a Controlled Access Zone (CAZ) shall be clearly defined by the competent person as an area where a recognized hazard exists.

The following locations have been identified as locations where conventional fall protection methods or other safe access methods cannot be used. These locations are classified as a CAZ.

The demarcation of the CAZ shall be communicated by the competent person in a recognized manner, either through signs, wires, tapes, ropes or chains. *Your company name here* shall take the following steps to ensure that the CAZ is clearly marked or controlled by the competent person:

1. All access to the CAZ must be restricted to authorized entrants;
2. All employees who are permitted in the CAZ shall be listed in the Plan (or be visibly identifiable by the competent person) prior to implementation;
3. The competent person shall ensure that all protective elements of the CAZ are implemented prior to the beginning of work.

The following employees are designated to work in a CAZ at this project. No other employees may enter a CAZ.

V. Safety Monitoring System

If no other alternative measure has been implemented to replace conventional fall protection, the employer shall implement a safety monitoring system in conformance with 1926.502(h). Safety monitoring systems and their use shall comply with all the following provisions:

- a. The employer shall designate a competent person to monitor the safety of other employees and the employer shall ensure that the safety monitor complies with the following requirements.
- b. The safety monitor shall be competent to recognize fall hazards;

- c. The safety monitor shall warn the employee when it appears that the employee is unaware of a fall hazard or is acting in an unsafe manner;
- d. The safety monitor shall be on the same walking/working surface and within visual sighting distance of the employee being monitored;
- e. The safety monitor shall be close enough to communicate orally with the employee; and
- f. The safety monitor shall not have other responsibilities which could take the monitor's attention from the monitoring function.

Mechanical equipment shall not be used or stored in areas where safety monitoring systems are being used to monitor employees engaged in roof operations on low-slope roofs.

No employee, other than an employee engaged in roofing work [on low-sloped roofs] or an employee covered by a fall protection plan, shall be allowed in an area where an employee is being protected by a safety monitoring system.

Each employee working in a controlled access zone shall be directed to comply promptly with fall hazard warnings from safety monitors.

VI. Accident Investigations

In the event an employee falls, or some other related, serious incident occurs, (e.g., a near miss) *your company name here* shall investigate the circumstances of the fall or other incident to determine if the fall protection plan needs to be changed (e.g., new practices, procedures, or training) and shall implement those changes to prevent similar types of falls or incidents. Documentation of all incidents and changes to this plan will be kept on site.



Michigan Occupational Safety and Health Administration
Consultation Education and Training Division
530 W. Allegan Street, P.O. Box 30643
Lansing, Michigan 48909-8143

For further information or to request consultation, education and training services
call (517) 284-7720

or

visit our website at www.michigan.gov/miosha

www.michigan.gov/leo

LEO is an equal opportunity employer/program.

MIOSHA Fact Sheets

MIOSHA Fact Sheet

Fall Protection - Highlights of the Construction Standard



Falls are one of the leading causes of fatalities in the construction industry. Injuries from falls or falling objects range from sprains and contusions to death. Construction Standard [Part 45, Fall Protection](#), addresses minimum requirements and criteria for fall protection at construction worksites. Compliance with these key components of the standard can help avoid fall hazards.

1. Must provide fall protection at 6 feet or higher. This includes:
 - Holes and skylights
 - Ramps and walkways
 - Wall openings
 - Roofs
 - Any other walking/working surface

Excavation over 6' require barriers or guardrails if they are wells, pits, shafts, or similar OR if the excavation edge is not readily seen.

Holes must be covered and covers must be secured and able to withstand twice the anticipated load and be marked as "hole" or "cover."
2. Choices for fall protection include:
 - Guardrail Systems
 - Safety Net System
 - Personal Fall Arrest System (PFAS)
3. Guardrails:
 - 42 inches high, plus or minus 3 inches
 - Toprail must support 200 lbs. outward and downward force
 - Midrails must support 150 lbs.
 - Wire rope must be flagged every 6 feet
 - Wire rope must not deflect more than 3 inches
4. Safety nets:
 - Fall distance into net no more than 30 feet
- Nets extend beyond working surface 8 feet to 13 feet depending on distance to surface
- 400 lbs. drop test required for net
5. PFAS:
 - Anchorage must support 5000 lbs
 - Free-fall distance must be limited to maximum of 6 feet
 - Must be inspected daily
 - Lanyards must be shock-absorbing
 - A rescue plan is required that will provide a means to retrieve a victim that has fallen and is suspended by their harness and lanyard
6. Overhand bricklaying has the option of using a controlled access zone.
7. Workers on flat and low-sloped roofs have the option of using a warning line system. Six feet back from the edge for roofers, 15 feet back for all other trades.
8. Workers on steep roofs (greater than 4 in 12) must use either guardrails with toeboards, nets, or personal fall arrest.
9. Precast concrete erection workers and leading edge workers must use either guardrails, nets, or personal fall arrest. Where infeasible, they must implement a written "fall protection plan."

LEO is an equal opportunity employer/program.



Consultation Education and Training Division
 530 W. Allegan Street • P.O. BOX 30643 • Lansing, Michigan 48909-8143
www.michigan.gov/miosha • (517) 284-7720
 (CET Fact Sheet #180 • Revised 8/28/2023)



MIOSHA Fact Sheet

Falls – Unprotected Sides, Wall Openings, and Floor Holes



Falls are one of the leading causes of fatalities in the construction industry. In 2020, 351 fatal falls occurred nationwide. MIOSHA investigated 21 fatalities over the 5-year period of 2018 through 2022 related to falls at construction work sites.

Almost all construction work sites have unprotected sides and edges, wall openings, or floor holes at some point during construction. If these sides and openings are not protected at the work site, injuries from falls or falling objects range from sprains and contusions to death. Construction Standard [Part 1, General Rules](#), Rule 114 requires an Accident Prevention Program at every construction work site which must address hazards, including falls. Construction Standard [Part 45, Fall Protection](#), addresses minimum requirements and criteria for fall protection at construction workplaces.

How To Avoid Hazards

- Use at least one of the following whenever employees are exposed to a fall of 6 feet or more above a lower level: guardrail systems, safety net systems, or personal fall arrest systems.
- A wall opening more than 30 inches in height and more than 18 inches in width must be protected by guardrail systems, safety net systems or personal fall arrest systems.
- Cover or guard floor holes as soon as they are created throughout new construction projects.
- For existing structures, survey the site before working and continually audit as work continues. Guard or cover any openings or holes immediately.
- Construct all floor hole covers so they will effectively support two times the weight of employees, equipment, and materials that may be imposed on the cover at any one time, this includes skylights. Covers must be secured and color coded or marked with the words "HOLE" or "COVER."
- In general, it is better to provide fall prevention systems, such as guardrails, than fall protection systems, such as safety nets or fall arrest devices, because they provide more positive safety means by eliminating the hazard of falling.

If you need additional assistance, please contact the Construction Safety and Health Division at 517-284-7680 or the Consultation Education and Training Division at 517-284-7720. Construction Safety Standards and other information can be viewed on the MIOSHA website at www.michigan.gov/miosha.

LEO is an equal opportunity employer/program.



Construction Safety and Health Division
530 W. Allegan Street • P.O. Box 30645 • Lansing, Michigan 48909-8145
www.michigan.gov/miosha • 517-284-7680
(CSHD Fact Sheet - #009 • Revised 8/10/2023)

