

**MICHIGAN  
DEPARTMENT OF TRANSPORTATION**

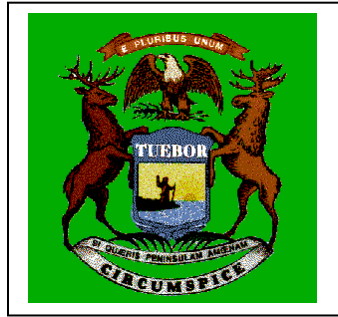

**2012  
STANDARD  
SPECIFICATIONS  
FOR  
CONSTRUCTION**



**MICHIGAN  
DEPARTMENT OF TRANSPORTATION**

**LANSING, MICHIGAN**

Transportation Commission:

Jerrold M. Jung, Chairman  
Linda Miller Atkinson  
Charles F. Moser  
James S. Scalici  
Ted B. Wahby  
Todd A. Wyett

Kirk T. Steudle, Director

April 1, 2011

The following MDOT publications are included by reference in these Standard Specifications as if the same were repeated herein in their entirety:

Field Manual of Soil Engineering (out of print)  
Materials Quality Assurance Procedures Manual  
Michigan Manual on Uniform Traffic Control Devices  
Michigan Test Methods  
Procedures for Aggregate Inspection  
Procedures Manual for Mix Design Processing  
Road and Bridge Standard Plans  
HMA Production Manual  
Soil Erosion and Sedimentation Control Manual  
Density Testing and Inspection Manual  
Work Zone Safety and Mobility Manual

Copies of these standard specifications and publications are available through the MDOT Publications Office by telephone (517-322-1676) or by e-mail ([MDOT-Publications@michigan.gov](mailto:MDOT-Publications@michigan.gov))

## FOREWORD

The 2012 Standard Specifications for Construction is the standard for the basic requirements governing the materials, equipment and methods used in construction contracts administered by the Michigan Department of Transportation.

General Chair - Judy A. Ruszkowski  
Engineer of Specifications - David Pawelec

Division 1 General Provisions - Co-chairs: Brenda O' Brien, Randy Van Portfliet, Mark Chaput

Jill Mullins - Finance  
David Pawelec - C&T  
Larry Strzalka - Design

James Shell - Attorney General  
Pete Pfeiffer - Southwest  
Phillip Lynwood - FHWA

Division 2 Earthwork - Co-chairs: Dave Gauthier, Kurt Coduti

Dave Phillips - Grand  
Dave Tallon - North

Nick VanWoert - Southwest  
Kurt Zachary - FHWA

Division 3 Bases - Co-chairs: Mike Eacker, Mark Grazioli

Dan Kari - Superior  
Bill Erben - Metro  
Al Robords - C&T

Channing Page - University  
Bob Conway - FHWA

Division 4 Drainage - Co-chairs: Mark Van Port Fleet, Gary Karttunen

Pete Jansson - C&T  
Victor Judnic - Metro

Drew Senters - Southwest  
Mark Lewis - FHWA

Division 5 HMA Pavements and Surface Treatments - Co-chairs:  
Curtis Bleech, Steve Palmer

Karl Koivisto - Grand  
Paul Ajegba – Metro  
Bob Conway - FHWA

Kevin Kennedy - C&T  
Julie Van Portfliet - Superior

Division 6 Portland Cement Concrete for Pavements - Co-chairs:  
John Staton, Bob Ranck

Mark Melchiori - University  
Rich LaPalm - Metro  
Steve Bower - University

Joseph Tejkl - C&T  
Bob Conway - FHWA

Division 7 Structures - Co-chairs: Roger Till, Eric Burns

Al Hagen - C&T  
Steve Cook - C&T  
Richard Endres - C&T  
Pete Jansson - C&T  
Tim Stallard - C&T  
Jeff Weiler - C&T  
Bryon Beck - C&T

Steve Beck - Design  
Steve Wohlscheid - C&T  
Ryan Snook - C&T  
Terry Johnson - University  
Jennifer Transue - Design  
Jon Nekritz - FHWA

Division 8 Incidental Construction - Co-chairs: Mark Bott, Brad  
Wieferich

Jeff Bigelow - University  
Carlos Libiran - Design  
Brian Zimmerman - Operations  
Jeff Grossklaus - Metro  
Tom Killingsworth - C&T  
Jeff Bokovoy - Design  
Steve Urda - Design  
Deidre Thompson - Operations  
Alonzo Uzcategui - Operations  
Doug Adelman - Operations

Jack Hofweber - Bay  
Jill Morena - Operations  
Lynette Firman - Operations  
Lynn Lynwood - Design  
Tim Smith - Metro  
Bob Zielinski - Design  
Brian Dollman-Jersey - Design  
Ray Olsen - Operations  
Erin O'Brien - Operations  
Dave Calabrese - FHWA

Division 9 Materials - Coordinator: John Staton

Brenda J. O'Brien, Engineer of Construction & Technology  
John C. Friend, Director, Bureau of Delivery  
Mark A. Van Port Fleet, Director, Bureau of Development  
Gregory C. Johnson, Chief Engineer

The time and effort contributed by members of the specification committees representing the Michigan Infrastructure and Transportation Association, Asphalt Paving Association of Michigan, Michigan Concrete Association, Michigan Aggregates Association, Michigan Road Preservation Association and Associated Consulting Engineers Council are also appreciated.

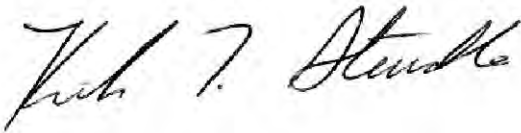
A handwritten signature in black ink, reading "Kirk T. Steudle". The signature is written in a cursive style with a large initial "K" and "S".

Kirk T. Steudle, Director  
Michigan Department of Transportation

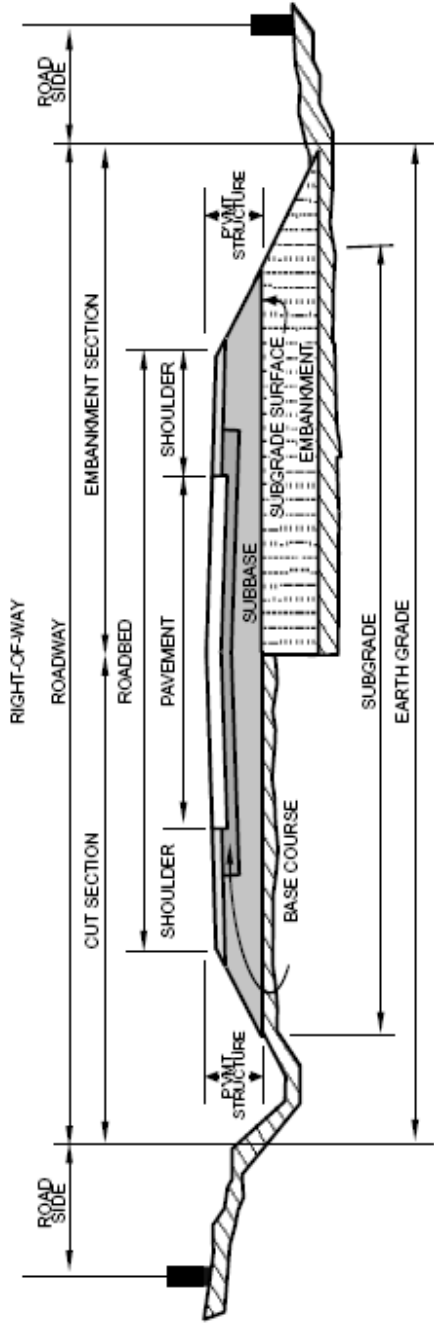

Roadway Nomenclature

## TABLE OF CONTENTS

| <b>Section</b>           | <b>Title</b>   | <b>Page No.</b>   |
|--------------------------|--|-------------------|
| <b><i>Division 1</i></b> | <b><i>General Provisions</i></b> .....                   | <b><u>1</u></b>   |
| 101                      | Terms, Format, and Definitions.....                      | <u>3</u>          |
| 102                      | Bid Submission, Award, and Execution of Contract .....   | <u>16</u>         |
| 103                      | Scope of the Work .....                                  | <u>26</u>         |
| 104                      | Control of the Work.....                                 | <u>30</u>         |
| 105                      | Control of Materials.....                                | <u>48</u>         |
| 106                      | Quality Assurance Acceptance Program .....               | <u>54</u>         |
| 107                      | Legal Relations and Responsibilities to the Public.....  | <u>55</u>         |
| 108                      | Prosecution and Progress.....                            | <u>71</u>         |
| 109                      | Measurement and Payment.....                             | <u>87</u>         |
| 150                      | Mobilization .....                                       | <u>107</u>        |
| <b><i>Division 2</i></b> | <b><i>Earthwork</i></b> .....                            | <b><u>109</u></b> |
| 201                      | Clearing .....   | <u>111</u>        |
| 202                      | Removing Trees, Stumps, and Corduroy.....                | <u>115</u>        |
| 203                      | Removing Drainage Structures, Culverts, and Sewers ..... | <u>117</u>        |
| 204                      | Removing Miscellaneous Structures and Materials.....     | <u>120</u>        |
| 205                      | Roadway Earthwork .....                                  | <u>127</u>        |
| 206                      | Excavation and Backfill for Structures .....             | <u>145</u>        |
| 207                      | Obliterating Roadway.....                                | <u>149</u>        |
| 208                      | Soil Erosion and Sedimentation Control .....             | <u>150</u>        |
| 209                      | Project Cleanup .....                                    | <u>158</u>        |
| <b><i>Division 3</i></b> | <b><i>Bases</i></b> .....                                | <b><u>159</u></b> |
| 301                      | Subbase.....   | <u>161</u>        |
| 302                      | Aggregate Base Course .....                              | <u>162</u>        |
| 303                      | Open-Graded Drainage Courses .....                       | <u>165</u>        |
| 304                      | Rubblizing Portland Cement Concrete Pavement.....        | <u>166</u>        |
| 305                      | HMA Base Crushing and Shaping.....                       | <u>170</u>        |
| 306                      | Aggregate Surface Course .....                           | <u>173</u>        |
| 307                      | Aggregate Shoulders and Approaches.....                  | <u>176</u>        |
| 308                      | Geotextile for Base .....                                | <u>180</u>        |



|                   |   |                   |
|-------------------|---|-------------------|
| <b>Division 4</b> | <b><i>Drainage Features</i></b> .....                                   | <b><u>181</u></b> |
| 401               | Pipe Culverts .....   | <u>183</u>        |
| 402               | Storm Sewers .....  | <u>193</u>        |
| 403               | Drainage Structures .....   | <u>202</u>        |
| 404               | Underdrains .....   | <u>210</u>        |
| 405               | Pump Station Construction .....   | <u>216</u>        |
| 406               | Precast Three-Sided, Arch, and Box Culverts .....                       | <u>217</u>        |
| <b>Division 5</b> | <b><i>Hot Mix Asphalt Pavements &amp; Surface Treatments</i></b> .....  | <b><u>229</u></b> |
| 501               | Plant Produced Hot Mix Asphalt .....                                    | <u>231</u>        |
| 502               | HMA Crack Treatment .....   | <u>250</u>        |
| 503               | Paver Placed Surface Seal .....   | <u>255</u>        |
| 504               | Micro-Surfacing .....   | <u>260</u>        |
| 505               | Chip Seals .....  | <u>271</u>        |
| 506               | Slurry Seal .....   | <u>279</u>        |
| <b>Division 6</b> | <b><i>Portland Cement Concrete Pavements</i></b> .....                  | <b><u>285</u></b> |
| 601               | Portland Cement Concrete for Pavements .....                            | <u>287</u>        |
| 602               | Concrete Pavement Construction .....                                    | <u>301</u>        |
| 603               | Concrete Pavement Restoration .....                                     | <u>327</u>        |
| 604               | Contractor Quality Control for Concrete .....                           | <u>344</u>        |
| 605               | Quality Assurance (Acceptance) for Concrete .....                       | <u>345</u>        |
| <b>Division 7</b> | <b><i>Structures</i></b> .....  | <b><u>347</u></b> |
| 701               | Portland Cement Concrete for Structures .....                           | <u>349</u>        |
| 702               | Mortar and Grout .....  | <u>353</u>        |
| 703               | Mortar and Concrete Patching, Repair, and Resurfacing<br>Mixtures ..... | <u>357</u>        |
| 704               | Steel Sheet Piling and Cofferdams .....                                 | <u>361</u>        |
| 705               | Foundation Piling .....   | <u>366</u>        |
| 706               | Structural Concrete Construction .....                                  | <u>383</u>        |
| 707               | Structural Steel Construction .....                                     | <u>414</u>        |
| 708               | Prestressed Concrete .....  | <u>437</u>        |
| 709               | Timber Structures .....   | <u>446</u>        |
| 710               | Waterproofing and Protective Covers .....                               | <u>450</u>        |
| 711               | Bridge Railings .....   | <u>458</u>        |
| 712               | Bridge Rehabilitation – Concrete .....                                  | <u>462</u>        |
| 713               | Bridge Rehabilitation – Steel .....                                     | <u>488</u>        |
| 714               | Temporary Structures and Approaches .....                               | <u>499</u>        |
| 715               | Cleaning and Coating Existing Structural Steel .....                    | <u>501</u>        |
| 716               | Shop Cleaning and Coating Structural Steel .....                        | <u>514</u>        |
| 717               | Downspouts and Drains .....   | <u>520</u>        |
| 718               | Drilled Shafts .....  | <u>522</u>        |

|                   |  |                   |
|-------------------|--|-------------------|
| <b>Division 8</b> | <b><i>Incidental Construction</i></b> .....  | <b><u>535</u></b> |
| 801               | Concrete Driveways .....   | <u>537</u>        |
| 802               | Concrete Curb, Gutter, and Dividers .....  | <u>538</u>        |
| 803               | Concrete Sidewalks, Sidewalk Ramps, and Steps .....  | <u>542</u>        |
| 804               | Concrete Barriers, Glare Screens, and Foundations for Light<br>Standards and Sign Supports ..... | <u>546</u>        |
| 805               | Hot Mix Asphalt Curb .....   | <u>550</u>        |
| 806               | Shared Use Paths .....   | <u>552</u>        |
| 807               | Guardrail, Guardrail Terminals, and Miscellaneous Posts .....                                    | <u>556</u>        |
| 808               | Fencing .....  | <u>562</u>        |
| 809               | Field Office.....  | <u>568</u>        |
| 810               | Permanent Traffic Signs and Supports .....   | <u>571</u>        |
| 811               | Permanent Pavement Markings .....  | <u>588</u>        |
| 812               | Temporary Traffic Control for Construction Zone<br>Operations.....                               | <u>601</u>        |
| 813               | Slope Protection.....  | <u>633</u>        |
| 814               | Paved Ditches .....  | <u>637</u>        |
| 815               | Landscaping.....   | <u>640</u>        |
| 816               | Turf Establishment .....   | <u>648</u>        |
| 817               | Landscape Mowing.....  | <u>660</u>        |
| 818               | Dune Grass Planting .....  | <u>662</u>        |
| 819               | Electrical and Lighting .....  | <u>663</u>        |
| 820               | Traffic Signals .....  | <u>685</u>        |
| 821               | Preservation of Land Monuments, Control Points, and<br>Property Corners.....                     | <u>705</u>        |
| 822               | Ground or Cut Shoulder Corrugations.....   | <u>711</u>        |
| 823               | Water Mains .....  | <u>713</u>        |
| 824               | Contractor Staking.....  | <u>725</u>        |
| <b>Division 9</b> | <b><i>Materials</i></b> .....  | <b><u>735</u></b> |
| 901               | Cement and Lime.....   | <u>737</u>        |
| 902               | Aggregates.....  | <u>738</u>        |
| 903               | Admixtures and Curing Materials for Concrete.....  | <u>753</u>        |
| 904               | Asphaltic Materials.....   | <u>756</u>        |
| 905               | Steel Reinforcement .....  | <u>767</u>        |
| 906               | Structural Steel .....   | <u>770</u>        |
| 907               | Fencing Materials .....  | <u>775</u>        |
| 908               | Miscellaneous Metal Products .....   | <u>782</u>        |
| 909               | Drainage Products.....   | <u>789</u>        |
| 910               | Geosynthetics .....  | <u>810</u>        |
| 911               | Water .....  | <u>814</u>        |
| 912               | Timber and Lumber .....  | <u>815</u>        |

|  |  |                                   |
|--|--|-----------------------------------|
| 913                                    | Masonry Units .....                                | <a href="#"><u>833</u></a>        |
| 914                                    | Joint and Waterproofing Materials .....            | <a href="#"><u>836</u></a>        |
| 915                                    | Bridge Coating Systems .....                       | <a href="#"><u>842</u></a>        |
| 916                                    | Erosion and Sedimentation Control Materials .....  | <a href="#"><u>844</u></a>        |
| 917                                    | Turf and Landscaping Materials .....               | <a href="#"><u>848</u></a>        |
| 918                                    | Electrical and Lighting Materials .....            | <a href="#"><u>857</u></a>        |
| 919                                    | Permanent Traffic Sign and Support Materials ..... | <a href="#"><u>880</u></a>        |
| 920                                    | Permanent Pavement Marking Materials .....         | <a href="#"><u>890</u></a>        |
| 921                                    | Permanent Traffic Signal Materials .....           | <a href="#"><u>893</u></a>        |
| 922                                    | Temporary Traffic Control Materials .....          | <a href="#"><u>933</u></a>        |
| 923                                    | Water Main Materials .....                         | <a href="#"><u>947</u></a>        |
| <br><b><i>Pay Item Index</i></b> ..... |  | <a href="#"><b><u>949</u></b></a> |
| <b><i>General Index</i></b> .....      |  | <a href="#"><b><u>970</u></b></a> |

## DIVISION 1 – GENERAL PROVISIONS

| <b>Section</b> | <b>Title</b>  | <b>Page No.</b>     |
|----------------|---|---------------------|
| 101            | Terms, Format, and Definitions.....                     | <a href="#">3</a>   |
| 102            | Bid Submission, Award, and Execution of Contract .....  | <a href="#">16</a>  |
| 103            | Scope of the Work .....                                 | <a href="#">26</a>  |
| 104            | Control of the Work.....                                | <a href="#">30</a>  |
| 105            | Control of Materials.....                               | <a href="#">48</a>  |
| 106            | Quality Assurance Acceptance Program .....              | <a href="#">54</a>  |
| 107            | Legal Relations and Responsibilities to the Public..... | <a href="#">55</a>  |
| 108            | Prosecution and Progress.....                           | <a href="#">71</a>  |
| 109            | Measurement and Payment.....                            | <a href="#">87</a>  |
| 150            | Mobilization .....                                      | <a href="#">107</a> |

## NOTES

## Section 101. TERMS, FORMAT, AND DEFINITIONS

**101.01. General.** The titles and headings of the sections, subsections, and subparts are intended for reference and are not considered as bearing on their interpretation.

When a publication is specified, the most recent issue including interim publications prior to the date of the advertisement for proposals for the Project is intended, unless otherwise specified.

Whenever the following abbreviations, terms or pronouns are used in the specifications or in other contract documents they have the following meaning.

### 101.02. Abbreviations.

| <b>Abbreviation</b> | <b>Long Form</b>  |
|---------------------|---|
| AAN .....           | American Association of Nurserymen                                    |
| AAR .....           | Association of American Railroads                                     |
| AASHTO .....        | American Association of State Highway and<br>Transportation Officials |
| ACI .....           | American Concrete Institute   |
| AGC .....           | Associated General Contractors of America                             |
| AIA .....           | American Institute of Architects                                      |
| AIS .....           | American Iron and Steel Institute                                     |
| ANSI .....          | American National Standards Institute, Inc.                           |
| APA .....           | Authorized Public Agency  |
| API .....           | American Petroleum Institute  |
| ARA .....           | American Railway Association  |
| AREMA .....         | American Railway Engineering and<br>Maintenance of Way Association    |
| ARTBA .....         | American Road and Transportation Builders' Association                |
| ASCE .....          | American Society of Civil Engineers                                   |
| ASLA .....          | American Society of Landscape Architects                              |
| ASME .....          | American Society of Mechanical Engineers                              |
| ASNT .....          | American Society for Non Destructive Testing                          |
| ASTM .....          | American Society for Testing and Materials                            |
| ATSSA .....         | American Traffic Safety Services Association                          |
| AWPA .....          | American Wood Preservers' Association                                 |
| AWS .....           | American Welding Society  |
| AWWA .....          | American Water Works Association                                      |
| CFR .....           | Code of Federal Regulations   |
| CIA .....           | Construction Influence Area   |

|                           |  |
|---------------------------|--|
| CRSI.....                 | Concrete Reinforcing Steel Institute                                 |
| DBE .....                 | Disadvantaged Business Enterprise                                    |
| FHWA.....                 | Federal Highway Administration,<br>U.S. Department of Transportation |
| FSS .....                 | Federal Specifications and Standards                                 |
| ICEA.....                 | Insulated Cable Engineers Association                                |
| IEEE .....                | Institute of Electrical and Electronics Engineers                    |
| IES .....                 | Illuminating Engineering Society                                     |
| ITS.....                  | Intelligent Transportation System                                    |
| IMSA .....                | International Municipal Signal Association                           |
| ISSA .....                | International Slurry Surface Association                             |
| ITE.....                  | Institute of Traffic Engineers                                       |
| MCL.....                  | Michigan Compiled Laws   |
| MDELEG ..                 | Michigan Department of Energy, Labor and Economic Growth             |
| MDNRE .....               | Michigan Department of Natural Resources and Environment             |
| MDOT.....                 | Michigan Department of Transportation                                |
| MIOSHA .....              | Michigan Occupational Safety and Health Act                          |
| MMUTCD .....              | Michigan Manual of Uniform Traffic Control Devices                   |
| MSA .....                 | Mine Safety Administration   |
| MSA .....                 | Michigan Statutes Annotated (number always follows)                  |
| <a href="#">MTM</a> ..... | Michigan Test Method   |
| NEC.....                  | National Electrical Code   |
| NELMA.....                | Northeastern Lumber Manufacturers' Association                       |
| NEMA.....                 | National Electrical Manufacturers' Association                       |
| NHPMA .....               | Northern Hardwood and Pine Manufacturers' Association                |
| NIST .....                | National Institute of Standards and Technology                       |
| NPDES.....                | National Pollutant Discharge Elimination System                      |
| NRMCA.....                | National Ready Mix Concrete Association                              |
| RCRA .....                | Federal Resource Conservation Recovery Act                           |
| SAE .....                 | Society of Automotive Engineers                                      |
| SPIB .....                | Southern Pine Inspection Bureau                                      |
| SSPC .....                | Steel Structures Painting Council                                    |
| USDA .....                | United States Department of Agriculture                              |
| UL.....                   | Underwriter's Laboratories, Inc.                                     |
| WCLIB.....                | West Coast Lumber Inspection Bureau                                  |
| WWPA.....                 | Western Wood Products Association                                    |

### 101.03. Definitions.

**Addendum.** Revisions to the plans and/or proposal issued by the Department after the advertisement but before the submission of the bid.

**Adjustment.** A monetary revision to a contract unit price or to the entire contract.

**Advertisement.** The public announcement of a project inviting Contractors to submit bids for work to be performed and materials to be furnished.

**Authorization.** The Department's written approval of a contract modification.

**Average Daily Traffic (ADT).** The total volume of traffic during a given time period, greater than one day and less than one year, divided by the number of days in the time period.

**Award.** The Department's formal execution of the contract.

**Base Course.** The layer or layers of specified material placed on a subbase or subgrade to support a surface course.

**Bid.** A completed schedule of items submitted as an offer to perform work at quoted prices.

**Bid Appeal Committee.** A MDOT committee that performs the administrative review of appeals of low bid rejections.

**Bid Document.** An electronic document prepared using current Department software, which includes the Schedule of Items, Designated, and Specialty Items, if applicable, and Warranty Obligations, if applicable.

**Bid Guaranty.** An amount the bidder agrees to pay to MDOT, at the time of bid submission, if the bidder fails to execute the contract form and file satisfactory bonds and other required documents necessary for award of the contract within the 28-day period provided or within Department approved extensions.

**Bid Review Committee.** A MDOT committee that reviews irregular bids for adherence to standard bid procedures.

**Bidder.**

A. The individual or legal entity submitting a bid.



- B. An affiliated bidder is a bidder having a relationship where one business concern or individual directly or indirectly controls or can control the others.

**Bridge.** A structure, including supports, built over a depression, watercourse, highway, railroad or other obstruction, with a clear span of at least 20 feet, measured along the center of roadway.

**Calendar Day.** Every day shown on the calendar, beginning and ending at midnight. Unless otherwise specified in the contract, the word "day" means calendar day.

**Calendar Date Contract.** A contract where the project is required to be physically complete or open to traffic on or before a designated date on the calendar.

**Calendar Day Contract.** A contract where the time required to physically complete the project, or open it to traffic, is designated by the number of calendar days.

**Certification of DBE Contractors.** The process by which the Department establishes that a Contractor meets the Federal requirements as a DBE.

**Change.** Addition to or deletion from a pay item or condition.

**Commission.** The Michigan State Transportation Commission.

**Construction Influence Area (CIA).** The project and the area surrounding the project, as shown in the contract, which defines the limits of responsibility for traffic control.

**Contract.** The written agreement between the Department and the Contractor setting forth the obligations of the parties for the performance of and payment for the prescribed work. The contract includes the advertisement for bids, bid document, progress schedule, contract form, contract bonds, standard specifications, special details, standard plans, plans, proposal, addenda, notice of award, local agency agreements (when applicable), DBE commitment forms (when applicable), and warranty forms and bonds (when applicable).

**Contract Modification.** The regulation form prepared as a recommendation for changes in, adjustments or extras to the contract. The contract modification becomes an authorization when signed by the duly authorized MDOT representative.

**Contract Time.** The time assigned in the contract to perform and complete all the work, including authorized extensions of time.

**Contract Unit Price.** The unit price of a pay item.

**Contractor.** The individual or legal entity contracting with the Department for performance of prescribed construction work and supplying materials.

**Controlling Operation.** An operation that, if the Contractor's expected rate of performance is not met or the scheduled start date is delayed, would delay the opening to traffic or completion of the entire project. The operation may be on or off the job site. The size of the operation is not a factor.

**Coordination Clause.** A clause in the contract that requires the Contractor to coordinate construction activities with other agencies, utilities, or Contractors.

**Culvert.** A structure, including supports, built over a depression, watercourse, highway, railroad, or other obstruction, with a clear span of less than 20 feet measured along the center of roadway.

**Department.**

- A. The Michigan Department of Transportation, when the State is the awarding authority;
- B. The Board of County Road Commissioners or the County of Wayne, when a County is the awarding authority; or
- C. The City or Village or authorized representative, when the City or Village is the awarding authority.

**Designated Classifications.** Work classifications that the Department lists in the proposal as the major work classifications required to construct the project, requiring appropriate prequalification to perform the specified work.

**Determined Low Bidder.** The bidder who is determined to have the lowest total bid on a project that meets all necessary requirements.

**Director.** The person, as provided by law, to serve as the principal executive officer of the Department and responsible for executing the policy of the Commission.

**Earth Grade.** The elevation of the completely graded roadway before placing the pavement structure.

**Engineer.**

- A. The Director of the Department or the Engineer designated by the Director, acting directly or through authorized representatives, who is responsible for engineering supervision of the construction, when the State is the awarding authority;
- B. The Engineer representing the County, when the County is the awarding authority; or
- C. The Engineer representing the City or Village, when the City or Village is the awarding authority.

**Estimate.**

- A. **Final Estimate.** The compilation of quantities showing work performed; upon which final payment is made.
- B. **Progress Estimate.** An estimate made as the work progresses showing estimated work performed and materials furnished; upon which periodic payments are made.

**Extension of Time.** Additional contract time authorized by the Department.

**Extra Work.** All work determined to be essential to the satisfactory completion of the contract. This work did not appear in the proposal as a specific pay item and was not included in the price bid for other items in the contract.

**Falsework.** Any temporary facility/device used to support the permanent structure until it becomes self-supporting. Falsework would include, but not be limited to, steel or timber beams, girders, columns, piles

and foundations, and any propriety equipment including modular shoring frames, post shores, and adjustable horizontal shoring.

**Float.** The total available time to complete a non-controlling operation or sequence of non-controlling operations, as designated by the Contractor in the progress schedule, minus the total planned duration associated with the non-controlling operation or sequence of non-controlling operations. Float within the schedule is not for the exclusive use or benefit of the Department or the Contractor, but is a resource available to both parties as needed until it expires.

**Forms.** A facility, device, or mold used to retain plastic or fluid concrete in its designated shape until it hardens.

**Grade Separation.** A structure that provides for highway traffic, pedestrian traffic, or utilities to pass over or under another highway or the tracks of a railway.

**Highway.** A general term denoting a public way for purposes of vehicular travel, including the entire area within the right of way.

**Holidays.** Recognized State holidays are: New Year's Day, Martin Luther King Day, President's Day, Memorial Day, Independence Day, Labor Day, Veteran's Day, Thanksgiving Day, the day after Thanksgiving Day, Christmas Eve, Christmas Day, and New Year's Eve.

**Inspector.** The representative of the Engineer assigned to test materials, make inspections of contract performance, or both.

**Laboratory.** A testing laboratory operated by or designated by the Department.

**Labor Dispute.** A controversy between the Contractor and the Contractor's employees, union, bargaining agents, suppliers, or suppliers' bargaining agents, or between unions that results in a work stoppage.

**Lien Bond.** The security furnished by the Contractor and the Contractor's Surety to guarantee payment of the debts covered by the bond.

**Limits of Earth Disturbance.** Area extending 10 feet outside the slope stake line except adjacent to wetlands where the limits of earth disturbance is at the slope stake line.

**Liquidated Damages.** Monetary damages paid at a specified rate by the Contractor to the Department for work not completed by the completion dates or within specified time frames.

**Local Traffic.** Traffic that has origin or destination within the CIA.

**Major and Minor Pay Item.** Pay items having an original item value that meets any of the criteria herein are considered major pay items. All other original pay items are considered minor. The original item value is the product of the plan quantity of the pay item and the contract unit price.

- A. The original contract amount is less than or equal to \$5,000,000 and the original item value is equal to or greater than 5 percent of the original contract amount.
- B. The original contract amount is greater than \$5,000,000 but less than or equal to \$20,000,000 and the original item value is equal to or greater than 4 percent of the original contract amount but not less than \$250,000.
- C. The original contract amount is greater than \$20,000,000 but less than or equal to \$30,000,000 and the original item value is equal to or greater than 3 percent of the original contract amount but not less than \$800,000.
- D. The original contract amount is greater than \$30,000,000 and the original item value is equal to or greater than 2 percent of the original contract amount but not less than \$900,000.
- E. If no major pay items are identified using the criteria in A through D above, then the major item or items are all of the original pay items, in sequence from the greatest original item value to the next lower item value and so on, until the total original value of the items adds up to 60 percent of the original contract amount.

**Materially Unbalanced Bid.** A bid that generates a reasonable doubt that award to the bidder submitting the mathematically unbalanced bid will not result in the lowest ultimate cost to the Department.

**Mathematically Unbalanced Bid.** A bid containing lump sum or unit price bid items that do not reflect reasonable actual costs of labor, equipment, materials, plus a reasonable proportionate share of the bidder's anticipated profit, overhead costs and other indirect costs.

**Maximum Unit Weight or Maximum Density.** The maximum value of the weight per unit volume established for a material.

**Median.** The portion of a divided highway separating the traveled ways.

**Net Prequalification.** The current balance of the Bidder's established prequalification rating. This is obtained by subtracting the uncompleted work on hand from the established rating.

**Non-Controlling Operation.** An operation that, if the Contractor's expected rate of performance is not met or the scheduled start date is delayed, would not delay the opening to traffic or completion of the entire project. The operation may be on or off the project site. The size of the operation is not a factor.

**Notice of Award.** Written notice to the Contractor that the contract has been awarded.

**Pay Item.** An item of work in the contract.

**Pavement Structure.** All combinations of subbase, base course, and surface course, including shoulders, placed on a subgrade.

**Performance Bond.** The security furnished by the Contractor and the Contractor's Surety to guarantee performance of the work in accordance with the contract.

**Plan Grade.** Vertical control grade shown on plans.

**Plan Quantity.** The original contract quantity of a pay item.

**Plans.** The contract drawings that show the location, character, and dimensions of the prescribed work. Contract drawings also include the following:

- A. **Standard Plans.** Drawings approved for repetitive use, showing details to be used where appropriate. The standard plans that apply to the project will be designated in the contract.

B. **Working Drawings.** Supplemental design sheets or similar data that the Contractor may be required to submit to the Engineer. Examples of these include, but are not limited to, stress sheets, shop drawings, erection plans, falsework plans, framework plans, cofferdam plans, and bending diagrams for reinforcing steel.

**Prequalification of Contractors.** A process used by the Department to determine the work classifications a Contractor is eligible to perform and the maximum contract amount that the Contractor's resources enables it to manage. This is done in accordance with the "Administrative Rules Governing the Prequalification of Bidders for Highway and Transportation Construction Work."

**Progress Clause.** A part of the proposal stating the starting date; all intermediate and completion dates or the, number of work days, or both; and other restrictions or conditions.

**Progress Schedule.** A sequential listing of all the controlling operations and the estimated time the operations will remain controlling. The progress schedule is submitted by the Contractor and approved by the Department prior to award of the contract and becomes part of the contract.

**Project.** A specific section of the highway or property on which the construction operation is to be performed as described in the contract.

**Project Limits.** The physical limits given in the contract showing the points of beginning and ending of the work included in the project.

**Proposal.** A document containing information regarding the project being advertised for bid. The information includes the location and description of work, schedule of items, progress clause, bid guaranty amount, date and time for electronic submission and downloading of bids, special provisions, supplemental specifications or other requirements that may vary from or are not contained in the standard specifications or plans, and the applicable wage rates to be paid by the bidder.

**Qualified Products List.** A listing of specific materials that have been prequalified for use on projects.

**Right-of-Way.** A general term denoting land, property or interest therein acquired for or devoted to a highway, as shown on the plans.

**Roadbed.** The portion of the roadway between the outside edges of finished shoulders, or the outside edges of berm immediately back of curbs or gutters, when constructed.

**Roadside.** The portion of the right-of-way outside of the roadway.

**Roadway.** The portion of the right-of-way required for construction, limited by the outside edges of slopes and including ditches, channels, and all structures pertaining to the work.

**Seasonal Limitation.** The time during which construction of work items will be suspended unless otherwise specified in the contract.

**Seasonal Suspension.** The period of time of November 15 through April 15 unless otherwise specified in the contract.

**Segregation.** Areas of non-uniform distribution of material components that are visually identifiable or can be determined by other methods.

**Shoulder.** The portion of the roadway adjacent to the traveled way for accommodation of stopped vehicles, for emergency use, and for lateral support of base and surface courses.

**Sidewalk.** That portion of the roadway primarily constructed for pedestrian use.

**Specialty Classifications.** Work classifications that the Department considers to require specialized equipment or crafts to an extent warranting being listed separately from the Designated Classification in the proposal.

**Specifications.** A general term applied to all written directions, provisions, and requirements concerning the performance of the work.

A. **Standard Specifications.** All requirements and provisions contained in this book.

B. **Supplemental Specifications.** Detailed specifications that add to or supersede the Standard Specifications.



- C. **Special Provisions.** Revisions and additions to the Standard and Supplemental Specifications applicable to an individual project.

**State.**

- A. The State of Michigan or the Michigan Department of Transportation Department, or both, when the State is the awarding authority;
- B. The County, when a county is the awarding authority; or
- C. The Municipality, when a city or village is the awarding authority.

**Subbase.** The layer of specified material placed on the subgrade as a part of the pavement structure.

**Subcontractor.** The individual or legal entity that performs part of the work through a contract agreement with the Contractor.

**Subcontract.** The written agreement between the Contractor and any individual or legal entity to perform a part of the contract work.

**Subgrade.** The portion of the earth grade upon which the pavement structure is placed.

**Substructure.** All of the structure below the bearings of simple and continuous spans, the skewbacks of arches, and the tops of footings of rigid frames, including backwalls, wing walls, and wing protection railings; except backwalls designed integrally with the superstructure.

**Superstructure.** All of a structure not classified as substructure.

**Surety.** The legal entity or individual other than the Contractor, executing a bond(s) furnished by the Contractor.

**Surface Course.** The top layer of a pavement structure.

**Temporary Road.** A roadway and appurtenances constructed to help the movement of highway and pedestrian traffic around a construction operation.

**Temporary Route.** An existing road over which the traffic is temporarily detoured around a construction operation.

**Temporary Structure.** A bridge, culvert, or grade separation constructed to maintain traffic during the construction or reconstruction of a bridge, grade separation, or culvert.

**Traffic Control Devices.** Signs, signals, lighting devices, barricades, delineators, pavement markings, traffic regulators and all other equipment for protecting and regulating traffic in accordance with the MMUTCD, unless otherwise specified in the contract.

**Traffic Lane.** The portion of the traveled way used for the movement of a single line of vehicles.

**Traffic Regulator.** A person assigned to direct traffic, dressed and equipped as specified in the MMUTCD.

**Traveled Way.** The portion of the roadway designated for the movement of vehicles, exclusive of shoulders and auxiliary lanes.

**Utility.** Properties of railway, telegraph, telephone, water, sewer, electric, gas, petroleum, cable television, and similar companies.

**Work.** The furnishing of all labor, materials, equipment, and other items necessary to complete the project according to the contract. This includes all alterations, amendments or extensions thereto, made by work order or other written orders of the Engineer.

**Work Day (Working Day).** All days when, as determined by the Engineer, it is possible for the Contractor to effectively carry out work on the controlling operation.

**Work Day Contract.** A contract where the time required to physically complete the project or open it to traffic is designated by the number of work days.

**Work Order.** A written order by the Engineer requiring performance by the Contractor.

## **Section 102. BID SUBMISSION, AWARD, AND EXECUTION OF CONTRACT**

**102.01. Prequalification of Bidders.** Unless otherwise provided, Bidders must be prequalified for the categories of work on which they submit a bid. A Bidder's net prequalification must be equal to or greater than that required for the proposed contract. When required in the proposal, the Bidder must designate other prequalified Contractors to whom they will subcontract those categories of work for which they lack prequalification, in accordance with subsection [108.01](#).

**102.02. Contents of Proposal.** The Proposal will provide the following information:

- A. Location and description of the contemplated work;
- B. Estimate of the various item quantities and kinds of work to be performed and/or materials to be furnished;
- C. Schedule of items for which proposed unit prices are invited;
- D. Specified days or date in which the work must be completed;
- E. Amount of the bid guaranty;
- F. Date, time and place for the electronic submittal and downloading of bids;
- G. Special provisions, supplemental specifications or other requirements that vary from or are not contained in the standard specifications or on the plans; and
- H. Applicable wage rate schedules.

The plans, specifications, and other documents designated in the Proposal are considered part of the Proposal whether attached or not.

**102.03. Interpretation of Bid Items in the Proposal.** The Department will use estimated quantities in the Schedule of Items to compare bids.

**102.04. Examination of Plans, Specifications, and Work Site.** Prior to submitting a bid, the Bidder must:

- A. Examine the proposal, plans, and the work site to understand the local conditions affecting the work and the detailed requirements of construction.
- B. Upon discovery of uncertainties, inconsistencies, errors, omissions, or conflicts during the examination of the proposal, plans and work site, notify the Department representative identified in the proposal using Department-approved procedures.

C. Be familiar with all requirements of federal, state, and local laws, ordinances, and permits that may directly, or indirectly, affect performance of the work.

The Department considers the submission of a bid proposal as prima facie evidence that the Bidder examined the proposal, plans, and the project site, and understands the requirements of the proposal package and conditions at the project site.

The Bidder must not take advantage of errors or omissions in the proposal that could make the bid mathematically or materially unbalanced. Failure to notify the Department of errors and omissions may result in the Department's rejection of the bid, reduction in or suspension of the bidder's prequalification, or both.

**102.05. Preparation of Bid.** The bid must be prepared using current Department software and in accordance with current Department procedures.

The Bidder must include, and will be deemed to have included, in its bid and contract price all applicable taxes that have been enacted into law as of the date the bid is submitted.

**102.06. Irregular Bids.** By submitting a bid, the Bidder agrees to the Department's procedures and standards for accepting or rejecting irregular bids. Unless the proposal modifies this subsection, the Department will take the following actions for irregular bids.

A. The Department will consider a bid irregular and will reject it for any of the following reasons:

1. The bid does not contain a unit price for each pay item listed in the Unit Prices column or lump sum price in the bid amounts column, as applicable. While a blank space is unacceptable, the explicit quotation of zero does constitute a price and, if awarded the contract, the Bidder would be bound to perform that pay item for zero payment and to do so to the same extent as if a positive numeric price had been quoted.
2. All addenda issued for the project have not been incorporated into the bid as submitted.
3. The bid is not electronically submitted by an authorized representative of the Bidder who has been designated in writing in accordance with current Department procedures.

4. The Bidder, except as otherwise provided in this section, is not prequalified or has insufficient prequalification for the specified category(s) of work required for the purposes of submitting a bid.
5. The Department finds evidence of collusion.
- B. The Department will consider a bid irregular and may reject it for any of the following reasons:
  1. There is an unauthorized addition, deletion, or alteration to the bid.
  2. There is an unauthorized alternate bid or conditional bid.
  3. There is an irregularity of any kind that tends to make the bid incomplete, indefinite, or ambiguous as to its meaning.
  4. The bid fails to comply with any other bid requirement.
  5. Any provision is added to the bid reserving the right, for the Bidder, to accept or reject an award of the contract.
  6. The bid is mathematically unbalanced as defined in subsection [101.03](#). The Department will perform further analysis to determine whether the bid is also materially unbalanced as defined in subsection [101.03](#). Decisions to accept or reject a materially unbalanced bid will be made in accordance with Department procedures and the Department's best interest.
  7. Affiliated Bidders submit bids on the same project.
- C. The Department may waive irregularities in accordance with subsection [102.06.B](#) and accept the lowest qualified bid whenever the considerations set forth in this subsection do not justify rejection of the bid. In determining whether to waive an irregularity and accept a bid, the Department will consider whether the nature or extent of the irregularity is such that acceptance of the bid might:
  1. Confer on the Bidder an unfair advantage or possibility for bid manipulation;
  2. Jeopardize funding for the project;
  3. Impose unreasonable administrative burdens on the Department; or otherwise
  4. Undermine the integrity of a fair, open, and honest competitive bidding process.

If the irregularity will not result in any of the conditions listed under subsection [102.06.C](#), the Department may accept the bid and allow the Bidder to remedy the irregularity. In remedying the irregularity, the Bidder must not increase or decrease any unit price bid.

Only a Bidder whose bid has been rejected pursuant to this subsection and who would otherwise be the lowest Bidder has an opportunity to appeal a proposed rejection in accordance with subsection [102.11](#) and subsection [102.12](#). Once all administrative appeals are exhausted under

subsection [102.11](#) and subsection [102.12](#), the decision of the Department or the Commission is final and binding on all Bidders.

**102.07. Delivery of Bid.** The Bidder must submit the bid using current Department software and before the deadline specified in the proposal.

Only an authorized representative of the Bidder, with a digital ID, may submit a bid to the Department. An authorized representative of the Bidder is an individual identified on the [MDOT Prequalification Application](#) form under "Person Authorized to Execute Contracts." This form must be properly completed and submitted in accordance with the Bureau of Finance and Administration's *Administrative Rules Governing the Prequalification of Construction Contractors*.

**102.08. Withdrawal or Revision of Bid.** The Bidder may withdraw or revise a bid before the deadline for downloading or submission of bids. The Department will consider only the last bid submitted by a Bidder, identified by date and time.

**102.09. Downloading of Bids.** The Department will download the bids and display the total bid amount of each bid on the Department's website as "As Submitted" bid results. If a Bidder has a system-generated receipt of submission and the Department did not receive the bid, the Department may accept a bid after the deadline in accordance with Department procedures and pending an investigation. The Department will handle these situations on a case-by-case basis.

**102.10. Bid Review.** The Department will review bids for mathematical accuracy to determine the apparent low Bidder. The Department will review the bid of the apparent low Bidder to verify compliance with the bidding requirements. If the Department determines the apparent low Bidder's bid is subject to rejection due to bidding irregularities, in accordance with subsection [102.06](#), the Department will repeat the verification process with the next apparent low Bidder until a bid meets the bidding requirements. The Department will refer bids of apparent low Bidders subject to rejection to the Bid Review Committee for review and decision. After the Department determines an acceptable low bid, it will publish the "As Checked" bids and bid prices.

**102.11. Bid Rejection.** If the Bid Review Committee rejects a Bidder's bid, the Administrator of the Contract Services Division, or designee, will notify the Bidder of the following:

- A. The rejection of its bid,
- B. The reasons for the rejection,
- C. The availability of an appeal to the Bid Appeal Committee, and
- D. The appeal procedure.

If circumstances warrant and allow, the Administrator of the Contract Services Division, or designee, may discuss with the Bidder, the problem and the Bidder's position. If the Bid Review Committee rejects an apparent low bid in accordance with subsection [102.06](#), the Bidder may file an appeal in accordance with subsection [102.12](#). If the Department makes successive rejections of low bids, each apparent low Bidder may file an appeal in accordance with subsection [102.12](#).

**102.12. Bid Rejection Appeal.** The Department will expedite the appeal process so as not to delay the award of a contract. The Department must receive a Bidder's written appeal of a bid rejection at the office of the Administrator of the Contract Services Division, within 5 calendar days after the Department notifies the Bidder of the decision to reject the bid.

The Administrator of the Contract Services Division, or designee, may designate a shorter time period for the submission of an appeal. If the Department deems circumstances warrant a time period of less than 5 calendar days for filing the appeal, the Administrator of the Contract Services Division, or designee, will notify the Bidder of the shortened period with the notice of rejection of the bid.

In the appeal, the Bidder must identify why it disputes the decision and supply pertinent information.

**A. Bid Appeal Committee.** The Administrator of the Contract Services Division, or designee, will assemble and submit all relevant information, including the decision of the Bid Review Committee, along with material and information submitted by the Bidder, to the Bid Appeal Committee.

The Bid Appeal Committee will review the information provided by the Administrator of the Contract Services Division, or designee, conduct any further inquiry, and make a decision. The Bid Appeal Committee usually makes a decision on the basis of written appeal, but the Bid Appeal Committee may request the Bidder meet with the Committee to review the issue.

The Deputy Director of the Bureau of Finance and Administration, or designee, will notify the Bidder, and other relevant personnel, in writing,

of the Bid Appeal Committee's decision. If the Commission must approve the contract, the Department will also notify the Bidder of its right to file an appeal with the Commission and the appeal procedure. If the contract does not require the Commission's approval, the Bid Appeal Committee's decision is final and binding.

**B. Appeal to the Commission.** The Bidder must file a written appeal of the Bid Appeal Committee's decision on contracts that the Commission must approve no later than 5 calendar days after the Bid Appeal Committee renders its decision, or by 3:00 p.m. on the day immediately preceding the date the Commission is scheduled to consider approval of the contract, whichever is sooner. If the Bidder receives verbal or written notice of the Bid Appeal Committee's decision less than 24 hours before the appeal submission deadline, the Bidder may file the written appeal no later than 9:00 a.m. on the day the Commission is scheduled to consider approval of the contract.

The Commission will review the information provided by the Department and the Bidder and make a decision. The Commission's decision is final and binding.

**102.13. Consideration of Bids.** To determine the low Bidder, the Department will compare the bids on the basis of the total bid amounts (the sum of lump sum amounts and the products of the estimated quantities and unit prices). For a discrepancy between the calculated total and the total shown in the bid, the Department will use the unit prices entered in the bid and correct the errors found in the calculations.

The Department may consider a Bidder eligible for award, even though its total bid amount exceeds the Bidder's net prequalification, if the Bidder was properly granted eligibility to bid and the Department determines the Bidder to be the low Bidder on only one project. If the Department determines a Bidder to be the low Bidder on more than one project, and the total amount of the multiple low bid proposals exceeds the Bidder's net prequalification, the Department will award the contract(s) in the Department's best interest.

The Department may reject bids, waive irregularities in accordance with subsection [102.06](#), advertise for new bids, or do the work in other ways in the Department's best interest. The decision by the Department to act in its best interest will not entitle Bidders to payment for preparing bids or anticipated profits.



**102.14. Construction Progress Schedule.** In addition to any progress clause in the proposal, the Department will require the determined low Bidder to submit a progress schedule prior to award of the contract and perform work per that schedule in accordance with subsection [108.05](#). The Department may require a critical path method (CPM) schedule and, upon approval by the Department, the CPM schedule will replace the progress schedule. Upon Department approval, the progress schedule or CPM schedule will become part of the contract.

**102.15. Execution and Award of Contract.** The Department will provide the contract and bond forms to the determined low Bidder, at the address on file with the Department. Within 28 calendar days of transmittal, the Bidder must return, and the Department must receive the fully executed contract, bond forms, and other documents required by the Department. The Department may grant an extension of that deadline, if the extension would not impair the Department's interests. If the Department executes a contract received after the deadline, an extension will be deemed to have been granted.

If the Department does not receive the signed contract, bond forms, and other documents required within 28 calendar days of transmittal, or an extended deadline, the Department may award the contract to the next low Bidder, or otherwise exercise its discretion in accordance with subsection [102.13](#).

If the Department does not execute the contract within 49 calendar days after the deadline for bid submission (including Department-approved extensions), the determined low Bidder may withdraw its bid without penalty. If the Department is responsible for the delay in award of the contract, the determined low Bidder may agree to extend the deadline for the execution of the contract for an agreed upon time period.

The Department considers the contract awarded and binding when signed by the determined low Bidder and executed by the Department.

**102.16. Requirements of Contract Bonds.** The determined low Bidder must furnish performance and lien bonds each for not less than 100 percent of the total contract price. The bonds must be on the forms provided by the Department. The bonds must meet the requirements of Michigan law and of the Department and include other items such as the powers of Attorney and Endorsement as specified by the Department. The same surety responsible for writing the performance bond must write the lien bond. It is the determined low Bidder's responsibility to ensure

that the lien bond conforms with the terms of 1905 PA 187, *supra*, except the lien bond must give the time within the notice of lien claim as follows, and secure the payment of claims:

- A. Lienable under the terms of 1905 PA 187, MCL 570.101 et seq;
- B. Notice of which is not given by subcontractors within the statutory period, but
  - 1. Notice of which is given by subcontractors within 60 calendar days after notice of the payment of the final estimate or post final estimate having been made by the Department; or
  - 2. In the case of a supplier to the contractor or a subcontractor, within 120 calendar days after the materials are last furnished.

**102.17. Bid Guaranty Payment.** The determined low Bidder's failure to sign the contract and submit satisfactory bonds and other required documents for the award of the contract within the 28 calendar day period provided, or within a Department-approved extension to that period, will result in the payment of the bid guaranty to the awarding authority.

Each Bidder has a positive duty to carefully prepare and check the accuracy of its bid. The Department will return the bid guaranty only if the Bidder clearly demonstrates the following:

- A. The Bidder made a substantial error and signing the contract would impose a substantial and unjustified hardship on the Bidder, given the size and nature of the project; or
- B. Extraordinary circumstances beyond the control of the Bidder exist in which signing the contract would impose a substantial and unjustified hardship on the Bidder, given the size and nature of the project.

A Bidder's mistake in judgment in preparing the bid will not warrant non-payment of the bid guaranty absent a compelling showing that enforcing payment of the guaranty would be unconscionable under all circumstances. The Bidder is responsible for clearly and convincingly satisfying the criteria for non-payment of the bid guaranty.

The Bidder must make requests for the return of the bid guaranty in writing to the Administrator of the Contract Services Division, or designee. The Bid Appeal Committee will consider and render a decision on the request for non-payment. The Bidder must file the written request with the Department within 15 calendar days after the Department mails notice that the Bidder must forfeit the bid guaranty.

The Committee may require that the Bidder produce original bid documentation and submit other information to enable the Committee to decide if the Bidder is entitled to the return of the bid guaranty. The Committee may also request that Department staff review the documentation and other information and make a recommendation to the Committee. Where the Committee, in its sole determination, finds the documentation and other information provides a partial justification, the Committee may make a correspondingly partial reduction of the bid guaranty. The Committee's decision is final and binding.

If the Committee makes an adverse decision, or the Bidder fails to file a timely request for return, or cancellation, of the bid guaranty, the Bidder must make the bid guaranty payment within 20 calendar days after the Department mails a final demand for payment. If the Bidder does not make the payment within 20 calendar days, the Department will withhold the payment sum from money owed the Bidder, or may become due and owing to the Bidder.

Bidding practices, competitive considerations and last minute price changes commonly result in item prices that, in isolation, could be mischaracterized as bid errors. The Department intends payment of the bid guaranty to deter Bidders from manipulating the competitive process by mischaracterizing such item prices as bid errors to justify withdrawal of low bids, after the downloading of all bids. Payment of the bid guaranty also constitutes liquidated damages for failure to sign the contract, since it is difficult to determine the actual damages for the breach, as they are uncertain in nature and impossible to estimate with certainty. The damages include the various administrative costs as well as other losses, damages, and costs resulting from the failure of the Bidder to sign the contract.

**102.18. Subletting Contract Work to Disadvantaged Business Enterprises (DBEs).** The DBE portion of work set for a project, as specified in the notice of advertisement, must be made available to certified Disadvantaged Business Enterprises (DBEs). Compliance with the designated DBE participation goal must be met by the utilization of DBEs to perform commercially useful functions as required by 49 CFR 26.55.

The names of the DBEs and the description of work to be performed by each must be submitted by the apparent low Bidder to the Contract Services Division of the Department after the furnishing of the contract and bond forms to the apparent low Bidder. This information must be

submitted on the forms provided by the Department. A Bidder who fails to meet the DBE participation goal will be deemed ineligible for award of the contract subject to the provisions of subsection [102.18.A](#).

**A. Pre-Award Waivers or Modifications.** If an apparent low Bidder is unable to meet the DBE participation goal, a request for waiver or modification of the DBE participation goal may be submitted in accordance with current Department DBE Program Procedures. The contract will not be awarded until a determination is made by the Department.

**B. Post-Award Waivers or Modifications.** The Contractor may, after award, request a waiver or modification of the DBE participation goal in accordance with current Department DBE Program Procedures. Prime Contractors may not terminate for convenience an approved DBE working on a federally-assisted contract, and then perform the work of the terminated DBE. The Contractor must notify the Department immediately of a DBE's inability to perform any or all of its work and the Contractor's intent to obtain a substitute DBE.

**C. Appeals.** A Contractor receiving an adverse determination, related to their request for waiver or modification of the DBE participation goal, may appeal the determination in accordance with current Department DBE Program Procedures.

The Department reserves the right to modify any requirement or shorten any time period where the need to place the project under contract is such that the public interest warrants such action and would be impaired by further delay. If the Department waives any of these requirements, except the length of a time period, it will assure that no Bidder is given a material competitive advantage by these actions.

**D. Reports.** The prime Contractor is required to submit to the Engineer a statement of DBE subcontractor payments in accordance with the contract.

**E. Penalties.** Failure to fulfill the DBE subcontracting requirement may result in the Department exercising the rights and remedies available in accordance with the provisions of the contract and may be considered a breach of contract. These may also include suspension, reduction, or removal of the Contractor's prequalification as stated in the *Administrative Rules Governing the Prequalification of Construction Contractors*.

## Section 103. SCOPE OF THE WORK

**103.01. Intent of the Contract.** The intent of the contract is to provide for the successful performance and completion of the work. The Contractor must perform the work as specified in the contract.

### **103.02. Revisions to the Contract.**

A. **General.** The Department reserves the right to revise the contract at any time. Revisions to the contract neither invalidate the contract nor release the surety, and the Contractor agrees to perform the work as revised. The Contractor must not proceed with the revised work until directed to do so by the Engineer, but must continue with all work unaffected by the revision. The Engineer will provide a work order for the revised work when requested by the Contractor.

The Department will pay the Contractor for revisions to the contract in accordance with subsection [109.05](#), and grant time extensions for revisions to the contract in accordance with section [108](#).

If the Contractor believes that one of the following subsections applies, the Contractor must notify the Engineer in accordance with subsection [103.03.B](#). If the Engineer and the Contractor do not agree as to whether one of the following subsections applies, the Contractor is directed to follow the provisions of subsection [104.10](#).

B. **Significant Changes in the Character of Work.** If alterations or changes in quantities significantly change the character of the work under the contract, whether such alterations or changes are in themselves significant changes to the character of the work, or by affecting other work, cause such other work to become significantly different in character, an adjustment, excluding anticipated profit, will be made to the contract. The basis for the adjustment must be agreed upon prior to the performance of the work in accordance with subsection [109.05](#).

The term significant change will be construed to apply only to the following circumstances:

1. When the character of the work, as altered, differs materially in kind or nature from that involved or included in the original proposed construction.
2. When a major pay item, as defined in subsection [101.03](#), is increased in excess of 125 percent or decreased below 75 percent of the original contract quantity. Any allowance for increase in quantity will apply only to that portion in excess of 125 percent of original pay item quantity, or in case of a decrease below 75 percent, to the

actual amount of work performed. For decreases below 75 percent, the maximum allowable adjustment will not exceed an amount equal to 75 percent of the original contract quantity times the contract unit price.

3. When the Engineer increases the quantity of a minor pay item such that the revised quantity meets the criteria for a major pay item. The Department will make an adjustment in the contract unit price that applies only to the quantity of that pay item that exceeds the quantity meeting the criteria for a major pay item.

**C. Differing Site Condition.** During the progress of the work, if subsurface or latent physical conditions are encountered at the site differing materially from those indicated in the contract or if unknown physical conditions of an unusual nature, differing materially from those ordinarily encountered and generally recognized as inherent in the work provided for in the contract, are encountered at the site, the party discovering such conditions must promptly notify the other party in writing of the specific differing conditions before the site is disturbed and before the affected work is performed.

Upon written notification from the Contractor, the Engineer will investigate the conditions, and if it is determined that the conditions materially differ and cause an increase or decrease in the cost or time required for the performance of any work under the contract, an adjustment, excluding anticipated profits, will be made and the contract modified in writing accordingly. The Engineer will notify the Contractor of the determination whether or not an adjustment of the contract is warranted in accordance with subsection [103.03.C](#).

No contract adjustment which results in a benefit to the Contractor will be allowed unless the Contractor has provided the required written notice.

No contract adjustment will be allowed under this clause for any effects caused on unchanged work.

**D. Suspension of Work Ordered by the Engineer.** If the performance of all or any portion of the work is suspended or delayed by the Engineer in writing for an unreasonable period of time (not originally anticipated, customary, or inherent to the construction industry) and the Contractor believes that additional compensation or contract time is due as a result of such suspension or delay, the Contractor must submit to the Engineer in writing a request for adjustment within 7 calendar days of receipt of the notice to resume work. The request must set forth the reasons and support for the adjustment in accordance with subsection [103.03.B](#).

Upon receipt, the Engineer will evaluate the Contractor's request. If the Engineer agrees that the cost or time required for the performance of the contract has increased as a result of the suspension and the suspension was caused by conditions beyond the control of and not the fault of the Contractor, its suppliers, or subcontractors at any tier, and the suspension was not caused by weather, the Engineer will make an adjustment (excluding profit) and modify the contract in writing. The Contractor will be notified of the Engineer's determination whether or not an adjustment of the contract is warranted in accordance with subsection [103.03.C](#).

No contract adjustment will be allowed unless the contractor has submitted a request for adjustment within the time prescribed.

No contract adjustment will be allowed under this clause to the extent that performance would have been suspended or delayed by any other cause, or for which an adjustment is provided for or excluded under any other term or condition of this contract.

**E. Extra Work.** The Engineer may, at any time during the progress of the contract, order extra work. The Engineer will provide the Contractor with a work order stating the location, kind, and estimated quantity of the extra work the Contractor is to perform.

**F. Eliminated Work.** The Engineer may eliminate all or a portion of any pay item.

The Department will compensate the Contractor a fair and equitable amount for all direct costs incurred on the item prior to the elimination of the pay item.

### **103.03. Contractor-Engineer Communication.**

**A. General.** The specified time limits may only be extended through a written, jointly signed agreement between the Contractor and the Engineer.

**B. Written Notice, by Contractor.** The written notice required by subsection [103.02](#) should include the following:

1. A description of the situation;
2. The time and date the situation was first identified by the Contractor;
3. The location of the situation, if appropriate;
4. A clear explanation of why the situation requires a revision to the contract, including appropriate references to the pertinent portions of the contract;
5. A statement of the revisions deemed necessary in the contract price(s), delivery schedule(s), phasing, time, etc. Because of its

preliminary nature, the Department recognizes that this information may rely on estimates;

6. An estimate of the time by which the Engineer must respond to minimize cost or delay, and, if applicable; and
7. Anything else that will help achieve timely resolution.

**C. Written Response, by Engineer.** Within 7 calendar days of receiving the Contractor's written notice, or sooner if possible, the Engineer will provide a written response that includes one of the following:

1. Confirmation of the need for a revision to the contract and a statement of the applicable subsections of section [108](#) and subsection [109.05](#) under which the revision is determined. If the work covered by the revision is complete at the time of the response, the Engineer will include the applicable contract modification in the response. A time extension, if one is necessary, will be determined in accordance with section [108](#) and the result included. Compensation for the revision, if any is necessary, will be determined in accordance with subsection [109.05](#) and the result included.
2. Denial of the request for a revision to the contract, in which case the Engineer will make clear, through reference to the contract, why the issue does not require a revision to the contract.
3. A request for additional information, in which case the Engineer will state clearly what is needed and by when; the Engineer will issue a final response within 7 calendar days of receiving the additional requested information, or sooner if possible.

**D. Contractor's Recourse.** If the Contractor disagrees with the Engineer's final written response or the Engineer's response is untimely, the Contractor may pursue a claim in accordance with subsection [104.10](#).



## Section 104. CONTROL OF THE WORK

**104.01. Authority of Department.** The Contractor must not construe approvals, reviews, or inspections by the Department or its officers, agents, and employees as a warranty or assumption of liability on the part of the Department. The Contractor understands and agrees that approvals, reviews, and inspections are for the sole and exclusive purposes of the Department, which is acting in a governmental capacity under the contract. Department approvals, reviews, and inspections do not relieve the Contractor of its contractual obligations. The Contractor understands that approvals, reviews, and inspections are undertaken for the sole use and information of the Department and will not act as a warranty as to the propriety of the Contractor's performance.

**A. General Authority of the Engineer.** The Engineer will decide questions that arise concerning the interpretation of the contract, and its acceptable fulfillment. The Engineer will also decide questions regarding the quality and acceptability of materials provided, work performed, manner of performance, and rate of progress of the work.

If either party discovers any errors, uncertainties, inconsistencies, omissions, or conflicts in the contract, the Engineer will clarify and determine the true intent of the contract.

**B. Authority of the Engineer to Suspend Work.** The Engineer may suspend the work, or a portion of the work, for the following:

1. Failure by the Contractor to correct conditions that are unsafe for the worker or the general public,
2. Unsuitable weather,
3. Conditions considered unfavorable for the prosecution of the work, or
4. Any other condition or reason deemed to be in the interest of the public.

Upon written notice of a suspension, the Contractor must put the work in a satisfactory condition and protect the work, as directed by the Engineer. The suspended work will not adversely affect the safety or mobility of the public. The Contractor must not resume the suspended work until directed, in writing, by the Engineer.

**C. Authority of the Engineer to Direct the Acceleration of the Work.** The Engineer may order the Contractor to accelerate the work or portions of the work to avoid user delay costs or to complete the project early.

**D. Authority and Duties of Inspectors.** The Department may appoint Inspectors to inspect and test materials and work. These duties may

extend to all parts of the work and preparation or manufacture of materials for use in the work. The Department does not authorize an Inspector to revoke or change the contract. If a dispute arises between the Contractor and the Inspector regarding the materials provided or performance of the work, the Inspector may, by written notice to the Contractor, reject materials or suspend the work until the Engineer makes a determination regarding the dispute. The Department considers work performed contrary to the Inspector's directions or work performed while suspended by the Inspector as unauthorized work. The Engineer may direct the Contractor to remove and replace unauthorized work at no additional cost to the Department in accordance with subsection [104.05](#). Actions or omissions of the Inspector will not relieve the Contractor of the responsibility of completing the work as required by the contract.

**E. Authority to Inspect.** The Contractor must provide the Department and its authorized representatives safe access to the work at all times. The Contractor must provide the Department and its authorized representatives with the information and assistance necessary for them to make complete and detailed inspections. The Department may also perform inspections at a mill, plant, laboratory, shop, or other locations outside of the project limits. The Contractor is not entitled to a time extension or compensation for reasonable delays, inconvenience, or any other cause attributed to the Department's reasonable inspection of the work.

**F. Authority to Inspect Scales.** The Department may inspect or verify scale systems, private scale inspectors, and inspection agencies. The Contractor must immediately correct any failure to meet the requirements of this subsection.

The Contractor must ensure that scales are installed, maintained, and used in accordance with 1964 PA 283 Michigan Weights and Measures and the requirements of the NIST Handbook 44, *Specifications, Tolerances and Other Requirements*.

The Contractor is responsible for all costs incurred for the inspection of scale systems and no additional compensation will be allowed. The Contractor is not entitled to a time extension or compensation for reasonable delays, inconvenience, or any other cause attributed to the Department's inspection of scale systems.

**104.02. Plans and Working Drawings.** The Department will provide plans showing details of the work required by the contract. If the plans omit dimensions necessary to complete the work, the Engineer will

provide the Contractor with the omitted dimensions upon request. The Contractor is responsible for all dimensions he scales from the plans.

The Contractor must submit for review all working drawings (including shop drawings) not furnished by the Department for all parts of the work as required by the contract.

At cofferdam locations where the combined depth of retained water and soil below the water table is less than 6 feet, the Contractor must submit working drawings for cofferdams that are not a part of the finished structure for review. The Contractor must ensure an engineer(s), competent in geotechnical and structural engineering, designs the cofferdam. The Contractor is responsible for the correctness of the working drawings and ensuring that the design complies with any permit requirements.

At cofferdam locations where the combined depth of retained water and soil below the water table is equal to or greater than 6 feet, the Contractor must submit working drawings and design calculations for cofferdams that are not part of the finished structure for review. The Contractor must ensure that a professional engineer, licensed in the State of Michigan, competent in geotechnical and structural engineering, designs and seals the working drawings and design calculations for the cofferdam. The Contractor is responsible for the correctness of the working drawings and design calculations, and ensuring the design complies with any permit requirements.

If the contract requires working drawings and design calculations for falsework and forms that are not part of the finished structure, the Contractor must submit these working drawings and design calculations to the Engineer for Department review. If the contract does not require these working drawings and design calculations, but the Engineer directs the Contractor to submit them, the Department will pay for these working drawings and design calculations as extra work in accordance with subsection [103.02.E](#). The Contractor must ensure that a professional engineer, licensed in the State of Michigan, seals the working drawings and design calculations submitted for falsework and forms. The Contractor is responsible for the correctness of the working drawings and design calculations, and ensuring the design complies with any permit requirements.

The Contractor must submit to the Engineer as many copies of the working drawings, and design calculations as needed for review and distribution. The Department will require a reasonable time for review and approval.

The Department's review and approval does not relieve the Contractor of full responsibility for all negligence in the construction of the project resulting from the working drawings. The Department's review and approval of the working drawings is not a warranty of the adequacy and correctness of the design.

The Contractor may arrange for the Department to deal directly with the fabricator or supplier to review the working drawings for the following or similar items:

- A. Fabricated structural elements,
- B. Mechanical equipment,
- C. Electrical equipment and circuitry, and
- D. Water mains.

On existing structures, the Contractor must check the dimensions and locations of the exposed features before starting construction to see that its relationship to the proposed work is as shown on the plans. The Contractor must notify the Engineer of differences between the actual dimensions and locations of the existing structures and those shown on the plans. The cost of verifying the dimensions and locations of existing structures is included in the contract unit price for Mobilization in accordance with section [150](#).

After completing the work, the Contractor must provide the Department with one complete set of working drawings on a medium approved by the Department. The Contractor must provide copies of catalogue cuts, parts lists, operating procedures, and instructions as deemed necessary for the project by the Engineer.

**104.03. Deviations from the Plans.** The Contractor must not deviate from the plans or from Department-approved working drawings and design calculations, unless the deviation is approved by the Engineer in writing.

If the Engineer approves deviations from the plans or Department-approved working drawings, the Contractor must submit to the Engineer revised plans, working drawings, and design calculations, sealed by a professional engineer, licensed in the State of Michigan, for review by the Department. The Contractor is responsible for the correctness of these revised plans, working drawings, and design calculations, and ensuring that the revised design complies with any permit requirements.

**104.04. Conformity with the Contract.** The Contractor must perform the work as required by the contract. The Engineer may reject work that does not meet the contract requirements. If the Engineer accepts work

that does not meet the contract requirements, the Engineer will document the basis of acceptance by contract modification. The Engineer will determine whether a reduction in the contract unit price or a guaranty bond is appropriate, and will document its determination with a signed contract modification.

The Contractor must remove and replace or correct rejected work as directed by the Engineer, at no additional cost to the Department.

**104.05. Removal of Unauthorized Work.** If the Contractor performs unauthorized work as defined in subsection [104.01.D](#), the Engineer may reject the unauthorized work.

**104.06. Coordination of Drawing Dimensions and Contract Document.** In case of a conflict in the contract documents, the following establishes the order of precedence:

- A. All proposal material except those listed in subsections [104.06.B](#) through [104.06.F](#),
- B. Special provisions,
- C. Supplemental specifications,
- D. Project plans and drawings,
- E. Standard plans, and
- F. Standard specifications.

Plan dimensions take precedence over calculated dimensions; calculated dimensions take precedence over scaled dimensions.

The Contractor must not take advantage of errors or omissions in the contract. If any errors, uncertainties, inconsistencies, omissions, or conflicts are discovered in the contract documents, the Engineer will determine the true intent of the contract in accordance with subsection [104.01.A](#).

**104.07. Contractor Obligations.** The Contractor must obtain and provide sufficient materials, equipment, tools, labor, and incidentals to complete the project as required by the contract. The Contractor, its suppliers, and its subcontractors must allow the Department access to, relevant records, accounts, other project-related documentation, and to their facilities as necessary for the Department to determine compliance with the contract requirements.

Except for safety issues or as required by the contract, the Contractor must not suspend work unless approved by the Engineer in writing. The Contractor must notify the Engineer within 24 hours of suspending the work.

**A. Project Supervisor.** The Contractor must provide a Project Supervisor to manage the work. Before beginning the work, the Contractor must submit to the Engineer the name of the Project Supervisor in writing. As the primary representative of the Contractor on the project, the Project Supervisor must be available at all times and must:

1. Keep a copy of relevant contract documents for the project at the project at all times;
2. Ensure each Subcontractor keeps a set of relevant contract documents covering their work at the project at all times;
3. Communicate in English;
4. Be capable of reading, interpreting, and implementing the relevant contract documents;
5. Communicate with subcontractors in a manner that ensures the Department's directions are carried out;
6. Be familiar with, and competent in, the management of projects involving the type of work being performed;
7. Act as agent for the Contractor and be responsible for subcontractors;
8. Anticipate construction impacts to property owners and businesses, and work with these parties before the impacts occur to minimize conflict;
9. Handle delays or quality issues for the Contractor; and
10. Receive and implement the direction of the Engineer.

When the Contractor or its subcontractors are performing work, the Project Supervisor must be present at the project, unless otherwise approved by the Engineer. When the Contractor is not performing work, the Contractor must designate a representative to receive and execute directions from the Engineer at all times. The representative must be available at all times to receive and sign work orders.

**B. Safety and Health Requirements.** The Contractor is responsible for protecting the life and health of all personnel on the project; the safety and health of the public; and property during the construction of the project.

The Contractor must comply with all local, state, and federal laws and regulations governing construction methods and the furnishing and use of safeguards, safety devices, protective equipment, and environmental and hazardous materials controls.

The Contractor must provide the following prior to the commencement of construction:

1. **Safety Supervisor.** The Contractor must appoint a Safety Supervisor, and an alternate, with the authority and responsibility to administer the Construction Safety Program on the project. The Contractor must provide written notification to the Engineer, State Police, and local law enforcement agencies of the names, addresses, and telephone numbers of the Safety Supervisor and the alternate.
2. **Construction Safety Program.** The Contractor must submit a written "Construction Safety Program" that outlines the plan and procedures for preventing and mitigating accidents and fires on the project and meeting all health and safety requirements of the contract, including subsection [812.03](#). The Contractor must meet with the Engineer to discuss the "Construction Safety Program" and to develop mutual understandings to govern the administration and enforcement of the program.
3. **Emergency Control.** The Safety Supervisor or alternate must remain on-call for notification of emergencies that may arise during periods when construction operations are not in progress.

The Safety Supervisor or alternate must periodically meet with the Engineer as the work progresses to review the contract and the "Construction Safety Program," and to consider necessary changes to the program for traffic protection and accident prevention.

If the Safety Supervisor or the alternate is not available to take protective or corrective action, the Department will authorize others to do the protective or corrective action. The Department considers the cost associated with protective or corrective action, required for traffic protection and accident prevention, and completed by others at the Department's direction to be the responsibility of the Contractor.

**C. Maintenance During Construction.**

1. **Routine Maintenance by the Department.** Except as specified in subsection [104.07.C.2](#) the Department will assume routine maintenance of roads bridges or other facilities open to traffic or in use by the public during periods of approved seasonal suspensions. The Department defines routine maintenance as the repair of damage to roads, bridges or other facilities from normal wear and tear due to traffic and weather. Routine maintenance does not include damage resulting from the Contractor's vehicles or equipment. The Department will perform snow plowing and ice control work on roads and facilities open to traffic.

The Contractor is not entitled to compensation for delays, inconvenience, or any other cause attributed to the Department's performance of routine maintenance.

2. **Routine Maintenance by the Contractor.** If the Contractor maintains through traffic on the project, the Contractor must perform necessary routine maintenance on that portion of the roadbed surface on which construction operations have begun. The Contractor must perform routine maintenance outside the area of construction operations, but within project limits only if directed to do so by the Engineer in writing. The Department will pay the Contractor for the routine maintenance directed by the Engineer as extra work in accordance with subsection [103.02.E](#).

The Contractor must perform routine maintenance on Contractor-constructed temporary facilities not open to traffic or in use by the public (including during periods of approved seasonal suspensions) at no additional cost to the Department, unless otherwise required by the contract. The Contractor must provide access for local traffic to property along the project even during seasonal suspension at no additional cost to the Department unless otherwise provided for in the contract.

3. **Damage Repair by the Contractor.** Except as specified in subsection [107.11](#), the Contractor must repair damage to highway facilities caused by defective materials, faulty workmanship, Contractor operations, and work not protected properly from naturally occurring events at no additional cost to the Department. This includes protection of traffic controls, removal of spilled materials from the roadbed or drainage courses, and repair of damaged facilities necessary for public travel and safety.

The Contractor must provide, install, and operate traffic control devices required to warn traffic of and protect traffic from Contractor-damaged facilities and repair operations at no additional cost to the Department. If the Department determines that the Contractor is not available to take protective or corrective actions, the Department will authorize others to complete the protective or corrective actions. The cost associated with protective or corrective action, required due to Contractor-damaged facilities and repair operations, and completed by others at the Department's direction will be the responsibility of the Contractor.

- D. **Final Clean Up.** Unless otherwise required by the contract, the cost of final clean up is included in the contact unit price for other pay items.



Before final acceptance, the Contractor must complete all of the following:

1. Remove the following from the project limits, unless otherwise required by the contract or directed by the Engineer:
  - a. Falsework;
  - b. Unused materials;
  - c. Temporary erosion control devices;
  - d. Rubbish;
  - e. Temporary bridges, approaches, and buildings;
  - f. Equipment; and
  - g. Temporary traffic control devices.
2. Restore areas occupied during the project to a condition at least equal to the condition existing before the Contractor began performing work, as determined by the Engineer.
3. Replace or repair damaged fences.
4. Restore property that was used or damaged during the performance of the work, including property outside of the project limits.
5. Provide the Department with written certification that all property that was used or damaged during performance of the work, including property outside of the project limits, has been restored in accordance with applicable local, state and federal requirements.
6. Clean paved roadbeds within 5 working days before opening the pavement surface to traffic taking precautions so as not to produce airborne dust when cleaning roadbeds in residential and urban areas.

**104.08. Cooperation by the Contractor.** The Contractor must conduct operations so as to cooperate with and interfere as little as possible with activities of other contractors, the Department, utilities, or public authorities on or near the project, and as directed by the Engineer. The Department may perform other work and allow public utility companies and others to do work on or near the project. The Contractor is not entitled to compensation or time extension for delays or costs incurred as a result of complying with this requirement, except as allowed in either subsection [108.08](#) or subsection [109.05](#).

If a dispute arises between two or more Contractors or others as to the respective rights of each under these specifications, the Engineer will determine the matters at issue and will define the respective rights of the various interests involved, in order to secure the completion of all parts of the work in general harmony and with satisfactory results. The Engineer's decision will be final and binding on all parties concerned. The Contractor, or any other party, is not entitled to a time extension or compensation for delays, inconvenience, or any other cause attributed to

the Engineer's decision, except as allowed in either subsection [108.08](#) or subsection [109.05](#).

**104.09. Lines, Grades, and Elevations.** The Contractor must provide, place, protect, and maintain staking necessary for proper prosecution, inspection, and final measurements of the work required by the contract. The Contractor must determine and lay out detail dimensions and elevations. The Engineer may check to ensure the Contractor's work meets the contract requirements in accordance with subsection [104.01](#).

**A. Engineer Staking.** Before construction, the Engineer will establish the original horizontal and vertical control points, if necessary. The Engineer will perform the following staking:

1. On road projects, the Engineer will set stakes on construction centerline or an offset line every 1,000 feet on tangent and at points of curvature, tangent deflections, and spiral control. The Engineer will loop and set benchmarks shown on the plans and temporary benchmarks as necessary to establish points every 1,000 feet along the project.
2. On bridge projects, the Engineer will provide a staked layout or a base line so the structure can be staked radially. Before staking the layout, the Engineer will discuss the staking method used with the Contractor. The staked layout will include witnesses and two benchmarks. The Engineer will provide a staked layout diagram showing witnesses, angles, and coordinates.
3. If required for the installation of right-of-way fence or to delineate right-of-way, the Engineer will set a right-of-way stake at no greater than 100 foot intervals along the right-of-way line and at all corners marking a change in width or direction.

The Engineer may eliminate points of intersection of curves and spirals if they fall outside of the project limits. The Engineer will provide a list of applicable coordinates for control points and benchmarks.

**B. Contractor Staking.** The Contractor must complete contractor staking in accordance with section [824](#) and the following:

1. Supply stakes, survey equipment, personnel, and other devices to check, mark, preserve, and maintain points, lines, and grades;
2. Set and mark stakes in a manner that will allow the Department to inspect the work;
3. Perform the work in such a manner as to allow the proper verification of all related work and pay items by the Engineer; and

4. Perform staking in such a manner as to allow the Engineer to exercise its authority in accordance with subsection [104.01](#).

Two work days before moving benchmarks or control points, the Contractor must notify and provide the Engineer with a list of points to be moved, including calculations and descriptions of the new locations.

**104.10. Claim for Extra Compensation or Time Extension.** The Contractor must sign and submit a claim for extra compensation or time extension to the Department, whether on behalf of the contractor or any tier subcontractor. If the Contractor fails to submit a claim in accordance with the Department's written claim procedure in effect at the time the Contractor files the claim and this subsection, the Contractor waives its rights to compensation or a time extension for the claim. This waiver applies whether or not, as a result of the Contractor's failure to comply with these requirements, the Department's rights were prejudiced. The Contractor and Department will use the following procedure for claims:

**A. Notice of Claim.** The Contractor must sign all notices of intent to file a claim and ensure the written notice includes a concise description of the claim and identifies the contract requirement in dispute. If seeking extra compensation for any reason not specifically covered elsewhere in the contract, the Contractor must notify the Engineer in writing in accordance with following time requirements:

1. Before beginning the work or upon encountering the circumstance that is the basis of the claim.
2. Within 3 calendar days after the beginning of a delay, for which the Contractor intends to seek compensation.

If the Contractor fails to provide written notice, the Contractor waives all rights to a claim for compensation or a time extension except if the Department prepared records that substantiate the claims with regard to liability and amount, and claims are for extra costs that were unforeseeable. If the Contractor fails to provide proper written notice for extra compensation or if the Contractor fails to allow the Engineer to record accounts of actual costs, the Department's claims process decision regarding extra compensation will be considered final and binding.

The Department will not consider the Contractor's refusal to sign a written contract modification or work order, or the Contractor's signing of a contract modification or work order under protest, as the required written notice.

**B. Keeping Records.** If submitting a written notice of intent to file a claim, the Contractor must:

1. Keep accurate records of the costs of the work or delay;
2. Allow the Engineer every facility for keeping records regarding the costs of the work or delay related to the claim; and
3. Compare records with the Engineer and bring them into agreement at the end of each day.

**C. Validity of Claim.** The notice of intent to file a claim or the Engineer's cost record keeping does not establish the validity of a claim.

**D. Timing for Filing of Claim.** The Contractor must file a claim with the Engineer within the following timeframes, whichever occurs first:

1. No later than 60 calendar days after the work involved in the claim is completed, or the delay, loss of efficiency, loss of productivity, or similar event is terminated; or
2. No later than 60 calendar days after the final acceptance of all contract work.

The Department may grant extensions of the above time requirements in accordance with the Department's current claim procedure.

**E. Claim Content and Certification.** The Contractor's claim must include a completed Form 1953 [Claim Content and Certification](#) that contains the following information, as applicable:

1. A detailed factual statement of the claim providing necessary dates, locations, and items of work related to and included in the claim.
2. The date or dates on which actions resulting in the claim occurred or conditions resulting in the claim became evident.
3. Identification of documents substantiating the Contractor's claim.
4. Identification of the provisions of the contract that support the claim and a statement of the reasons these provisions support the claim.
5. A detailed compilation and a breakdown of the amount of additional compensation sought as follows:
  - a. Documented additional labor costs;
  - b. Documented additional material costs;
  - c. List of additional equipment costs, including each piece of equipment and the rental rate claimed for each; and
  - d. Other additional direct costs or damages, and associated supporting documentation.
6. For a claim related to an extension of time, a detailed compilation of the specific dates and the exact number of calendar days sought for the time extension, the basis for entitlement to time for each day, all documentation of the delay, and all impacts of the delay to the progress schedule and critical path.

Subcontractors must document and certify their claim(s) as described in subsection [104.10.E](#). If the Contractor has a claim item related to a subcontractor's claim, the Contractor must document and certify their claim as described in subsection [104.10.E](#).

**F. Consistency of Claim and Exhaustion of Administrative Remedies.** If the Contractor's claim in any administrative proceeding or in the Court of Claims seeks relief greater than the amount sought at a prior level, or if the claim is based on facts or issues that differ from those presented at a prior level, the Contractor has failed to exhaust its administrative remedies. If the Contractor fails to exhaust its administrative remedies, the claim must be returned by the Department to the preceding level for a new review and decision. The Department in its sole discretion will determine whether the Contractor has exhausted its administrative remedy at any level. The Department's decision is final and binding, and not subject to further review or consideration. Nothing in this paragraph precludes the Contractor from withdrawing any portion of its claim or reducing the amount sought at any time.

The Contractor's written acceptance of an administrative proceeding panel's decision on claim item(s) constitutes a settlement of the claim item(s) and bars the Contractor from pursuing further legal remedies against the Department on the settled claim item(s).

#### **104.11. Work Zone Safety and Mobility.**

**A. General Traffic Control.** The Contractor must not close roads, bridges, or sections of roads and bridges to traffic unless otherwise required by the contract or directed by the Engineer. The Contractor must provide, install, and maintain temporary traffic control devices in accordance with section [812](#) or as required by the contract.

**B. Contractor Operations.** The Contractor must develop and provide a work zone traffic control plan for the project in accordance with the [Work Zone Safety and Mobility Manual](#). The work zone traffic control plan must outline the Contractor's haul routes, work zone access points, and the maintenance of the temporary traffic-control devices. The Contractor must ensure the work zone traffic control plan minimizes conflicts between construction vehicles and motorists, and maintains overall safety and mobility within the work zone.

**1. Limitations for Construction Equipment On or Crossing Pavements and Structures.** The Engineer will consider allowing the Contractor to use construction equipment on pavements and structures within project limits after the Contractor performs the following:

- a. Saws transverse expansion joints and places temporary or permanent seals;
- b. Makes relief cuts for transverse contraction and longitudinal joints;
- c. Places applicable temporary or permanent seals in transverse contraction joints that have been sawed full width;
- d. Completes the transverse post tensioning of a bridge span; and
- e. Ensures the concrete has gained sufficient strength for the placement of the intended load.

The Department will not allow construction equipment traveling on pavements to have tire loads greater than 850 pounds per inch of nominal tire width.

The Contractor must not use equipment that will damage the surface without protective devices, such as planks or timbers. The Contractor cannot use an earth cushion on a bridge structure.

Permission to use construction equipment on pavements and structures will neither constitute a waiver of applicable provisions of subsection [107.11](#) nor waive the Contractor's legal responsibility to observe weight restrictions on highway sections that the Department has approved for traffic in accordance with subsection [107.21](#).

The Department defines overweight loads as loads with maximum gross axle loadings greater than the limits specified in 1949 PA 300 Michigan Vehicle Code. The Department defines legal load limits, as the term is used in this section, as loads carried by vehicles with axle loading as specified in 1949 PA 300.

The Contractor must determine concrete strength as specified for applicable work progress specimens in Division 6 or Division 7.

2. **Construction Equipment Crossing Structures Which Have Not Attained 100 Percent of Class Design Strength.** The Engineer will consider requests to cross concrete bridges, grade separations, and box and slab culverts based on the gross vehicle load and the concrete strength as specified in Table [104-1](#). The Contractor must ensure the maximum axle loading is no greater than the loadings permitted under 1949 PA 300 for the axle spacing indicated therein.

| Table 104-1<br>Loads Permitted to Cross Structures as Concrete Gains Strength     |   |
|---|---|
| Minimum Class Design Compressive Strength, %                                      | Maximum Total Gross Vehicle Weight or Maximum Allowable Number of Axles (a) |
| 60  | 30,000 lbs  |
| 67  | 37,500 lbs  |
| 75  | 5 axles   |
| 80  | No limit on axle number   |
| a. The Department will evaluate crawler-mounted equipment on an individual basis. |   |

3. **Construction Equipment Crossing Structures Which Have Attained 100 Percent of Class Design Strength.** If the Contractor requests permission to cross structures within the project limits with vehicles that weigh more than the legal load limit, the Engineer will make a design analysis of the structure and the proposed loading based on established criteria. If the Engineer approves, the Contractor must cross structures with vehicles that weigh more than the legal load limit as follows:

- a. **General Requirements.** The Contractor must grade and maintain structure approaches flush with the bridge deck at least 50 feet from each end of the structure.

The Contractor must place a temporary concrete or structural timber header on the pavement seat at each end of the structure. The Contractor must use a ¼-inch wood divider, two thicknesses of heavy building paper, or 6 mil polyethylene to separate a temporary concrete header from the pavement seat. The Contractor must remove and dispose of the temporary header and divider board at the time of paving.

The Contractor must ensure equipment comes to a complete stop before crossing a structure. The Contractor must only allow one loaded vehicle on the structure at one time. The Contractor must ensure equipment does not travel on the structure at speeds greater than 5 miles per hour, unless otherwise required by the contract.

- b. **Specific Requirements.** If allowing crossings, the Department will state the following specific conditions in the authorization:
- i. Material to be used to cover and protect joints from infiltration and damage;
  - ii. Axle weights loaded and unloaded;
  - iii. Spacing of axles;
  - iv. Spacing of wheels on each axle;
  - v. Tire size; and

- vi. Estimated number of vehicle crossings to be made.
  - c. **Damage to the Structure.** The Contractor must inspect the structure for damage with the Engineer before and after hauling. The Contractor must repair damage to the structure, including joints, resulting from hauling operations at no additional cost to the Department.
  - d. **Violation of Requirements.** If the Contractor violates any of these requirements or any conditions specified by the Department, the Engineer will immediately revoke the authorized permission. The Contractor must not consider the authorization to haul across a structure or the withdrawal of authorization to haul across a structure as the basis for compensation or for a revision to the contract unit price for any item or entitlement to a time extension.
4. **Overloads Not Exceeding Legal Limits by 50 Percent on or Crossing Pavements.** The Department will consider loads on concrete pavements, other than temporary concrete pavements, that do not exceed legal limits by 50 percent in accordance with Table [104-2](#).

| <b>Flexural Strength all<br/>Mixes, psi</b> | <b>Maximum Load Type Allowed</b>  |
|---|---|
| 450   | Slip-form pavers and finishing equipment  |
| 550   | Load within legal limits  |
| 600   | Loads up to 25 percent over legal limits (for batch-hauling and shoulder operations only) |
| 650   | Occasional loads up to 50 percent over legal limits (to complete construction activities) |

The Engineer may allow occasional loads that exceed the legal limit by not more than 50 percent on hot mix asphalt pavements after rolling is complete and the mat has cooled to ambient temperatures. The Contractor must protect pavement, including edges, to prevent damage to the pavement. If the Contractor's hauling operations cause damage, the Contractor must repair the damage at no additional cost to the Department.

5. **Overloads Exceeding Legal Limits by 50 Percent On or Crossing Pavements.** The Engineer may allow loads that exceed the legal load limit by 50 percent or more to cross existing portland



cement concrete pavements at designated locations under the following conditions:

- a. The Contractor places transverse joint saw cuts in the pavement and uses painted lines to define the crossing area (approximately 50 feet wide);
- b. The Contractor maintains traffic on the pavement during hauling and reconstruction, as approved by the Engineer; and
- c. After completing hauling with overloads, the Contractor must remove the pavement between the two saw cuts and replace the pavement with new pavement of the same type and design as the original pavement.

If traveling across existing or new hot mix asphalt pavements with loads that exceed the legal load limit by 50 percent or more, the Contractor must remove and replace the crossing area to the required surface tolerances, as directed by the Engineer.

If the Contractor crosses existing pavements while hauling material from sources other than Department-designated sources, the Contractor must perform repair and restoration work as consideration for permission to haul with overloaded wheels or axles at no additional cost to the Department.

If the Contractor crosses existing pavements while hauling material from a Department-designated borrow area, the Department will pay for the removal and replacement of pavement, if directed by the Engineer, at the contract unit price for required items of work.

**104.12. Approval for the Use of the Right-of-Way.** The Contractor may use Department-owned right-of-way to perform the work if approved in writing by the Engineer. The Department may designate portions of the right-of-way or other Department property for possible use in the contract. The proposed right-of-way use must be directly related to the operations of the project under contract. Additional restrictions regarding the use of right-of-way may exist in other sections of the contract.

To use Department right-of-way, the Contractor must submit to the Engineer a written request including a "Right-of-Way Use Plan." The Contractor must include the following in the plan:

- A. Site location and layout,
- B. General intended use,
- C. Site access plan,
- D. Identification of materials and method of storage as applicable,
- E. Soil erosion and sedimentation control plan,
- F. Site restoration requirements,

- G. Drainage and environmental protection plan,
- H. Acquisition of necessary permits, and
- I. Commitment to follow all local laws and ordinances.

The Engineer may direct the Contractor to include additional information in the plan.

The Department will review the written request and provide a written response to the request indicating approval, approval with conditions or modifications, or denial with reason.

## Section 105. CONTROL OF MATERIALS

**105.01. Quality and Source of Supply.** Unless otherwise required by the contract, the Contractor must:

A. Provide new materials and fabricated items that meet the requirements of the specifications and are certified by the supplier in writing or approved by the Engineer in writing before use in the work.

B. Upon award of the contract, provide the information requested on the Department's [Materials Source List](#) (Form 0501) for the materials to be used in the work.

C. Notify the Engineer in writing, at least 7 days prior to when materials are required on site, that materials are ready for sampling, testing or inspection by the Department, including materials obtained from Department-approved certifiers or selected from the Department's Qualified Products List.

D. Change the source of supply only after providing the Department with a reasonable time to perform the required sampling, testing or inspection.

E. Provide the required documentation and obtain written approval from the Engineer before transferring materials that the Department has accepted, for use on another Department contract.

If the Department determines that a source of supply does not provide an acceptable product as required by the contract, the Engineer may require the Contractor to provide acceptable material from other sources. The Contractor is not entitled to a time extension or compensation for delays, inconvenience, or any other cause attributed to the Contractor providing acceptable material from other sources.

**105.02. Natural Material Sources Found within the Excavation Limits.** The Contractor may use natural material found within the excavation limits if the material meets the contract requirements of the work for which it is used, as determined by the Engineer. The Department will pay the Contractor for excavating this material at the corresponding contract unit price and for the pay item for which the excavated material is used.

**105.03. Borrow Material.** The Department defines borrow material as material found outside the excavation limits. Unless otherwise required by the contract, the Contractor must provide borrow material. The cost of excavating borrow material is included in the contract unit price of the pay items for which the borrow material is used.

The Contractor may not remove borrow material from the project limits unless approved by the Engineer in writing. If approved by the Engineer, the Contractor must reimburse the Department for the materials removed from the project limits at a rate of \$1.00 per cubic yard, in-place volume.

The contract may identify a source of Department-provided borrow material for the Contractor's use on the project. After removing the borrow material, the Contractor must not waste other material in the borrow area until approved by the Engineer in writing.

If the contract identifies a source of borrow materials, it is the Contractor's responsibility to determine the equipment and work required to produce acceptable material from that source. Variations in the quantity and quality of borrow materials from a Department-provided source are normal. Based on material test results, the Engineer may limit removal of material from a source and may reject portions of the material from the source in accordance with subsection [105.08](#).

Before using material from sources other than those identified in the contract, the Contractor must provide written certification to the Engineer that the material is environmentally acceptable, acquire required rights and permits, and submit a copy of any permits to the Engineer. The cost of acquiring these sources, obtaining necessary permits, and using the material from these sources is included in the contract unit price of the pay item for which the material is used.

Granular material excavated from underwater must be stockpiled and drained so it is free of water before placement on a prepared subgrade. If the Contractor chooses to dewater borrow material by temporarily lowering the water table, the Contractor is responsible for damages caused by this method.

After completing the work, the Contractor must restore sources of borrow material in accordance with subsection [205.03.H.2](#).

The Contractor is responsible for necessary construction, maintenance, and rehabilitation of routes used to haul borrow material, unless otherwise required by the contract. The cost to build and maintain routes to haul borrow material is included in the contract unit price for the relevant pay items. The Contractor is responsible for damages caused by hauling operations in accordance with section [107](#).

The Contractor must make provisions for haul routes involving a private railroad crossing in accordance with subsection [107.20](#).

**105.04. Miscellaneous Quantities.** If it is not possible to determine the location and quantity of a pay item until after construction has begun, the plans will reflect a miscellaneous quantity. If the pay item with the miscellaneous quantity involves the purchase of materials, the Contractor must not order those materials until the Engineer has determined the actual quantity of those materials.

**105.05. Approval of Materials Incorporated into the Work.** The Engineer may inspect materials that the Contractor will incorporate into the work at any time and at any place during the preparation, storage, and use of the materials. The Engineer will perform inspections of the materials, including sampling and testing, in accordance with the methods required by the contract to determine if the material meets the contract requirements. References within the contract to the Department's procedures for inspection, sampling, testing, and certification of materials refer to the edition of the relevant manuals, [MTMs](#), standard plans and standard specifications that are current as of the advertisement date, unless otherwise required by the contract.

If the Engineer inspects the materials at the plant, the Contractor must ensure the producer, supplier, or manufacturer provides and maintains accommodations, for the exclusive use of the Engineer in performing tests, in accordance with section [809](#).

**A. Approval by Certification or Qualified Products List.** A materials certification or inclusion on the Qualified Products List is not to be construed as Department acceptance, warranty, or guarantee that the material provided by the Contractor meets the requirements of the contract. If the Contractor chooses to obtain materials under certification by the supplier or from the Qualified Products List, the Contractor must ensure the supplier provides materials that meet the contract requirements.

If the Department approves the use of materials from a certified supplier or from the Qualified Products List, the Contractor is responsible for removal and replacement of nonconforming materials, even after final acceptance, unless the Contractor can prove all of the following:

1. The Contractor provided the notice required by subsection [105.01.C](#).

2. The Contractor provided the Department a reasonable time to sample, test, or inspect the material prior to incorporation into the work.
3. The Contractor did not know, and had no reason to know through reasonable inquiry, that substandard materials had been supplied.
4. The materials provided matched the material described in the certification statement or Qualified Products List.
5. The material described in the certification statement or Qualified Products List corresponded to the description in the specification.

The Contractor must notify the Engineer if the Contractor has, or by reasonable inquiry should have, reason to believe that a material supplier, producer, or manufacturer's circumstances have changed so that the quality of the materials certified for use on the project or materials on the Qualified Products List might not meet the contract requirements. The Contractor must notify the Engineer if the Contractor has any doubt about the approval of materials certified for use on the project or materials from the Qualified Products List.

**B. Approval by Test.** The Contractor must provide such facilities as may be required by the contract for the Engineer to collect samples of materials and forward the samples to the testing laboratory. The materials represented by the samples being tested are not to be used until the Engineer determines that the materials meet the contract requirements. The Contractor must provide required samples to the Engineer at no additional cost to the Department. The Contractor must prepay transportation charges for shipment of samples to the testing laboratory designated by the Department. The Department will test these samples at its own expense.

**105.06. Storage of Materials.** The Department may designate portions of the right-of-way or other Department property on the plans as possible locations for storing materials, in accordance with subsection [104.12](#). The Contractor must restore locations used for storage in accordance with section [205](#).

The Contractor must store materials as follows:

- A. In a manner that will preserve the quality of the materials and prevent damage to existing woody vegetation not identified for removal.
- B. Using shelters to protect items susceptible to damage.
- C. In a location that does not prohibit or delay the Engineer's inspections.

D. On private property only if approved by the owner and lessee in writing. If storing materials on private property, the Contractor must provide a copy of the written permission to the Engineer.

If the Engineer approved materials before the Contractor stored them, the Engineer may inspect the materials again before the Contractor incorporates them into the work.

**105.07. Handling and Transporting Materials.** The Contractor must handle materials in a manner that will preserve the quality of the materials.

The Contractor must transport materials from a storage location to the location that the Contractor will incorporate the materials into the work using vehicles constructed and maintained to prevent loss or segregation of materials after loading and measuring.

**105.08. Nonconforming Materials.**

**A. Nonconforming Materials Identified before Incorporation into the Work.** The Engineer will take one of the following actions for nonconforming materials identified before incorporation into the work:

1. The Engineer will reject the nonconforming materials and direct the Contractor to correct the rejected materials or remove the rejected materials from the project and replace with materials that meet the contract requirements. The Contractor must correct or remove and replace the rejected materials at no additional cost to the Department. Before incorporating corrected materials into the work, the Contractor must obtain the Engineer's approval.
2. The Engineer will allow the nonconforming materials to be incorporated into the work and will make a reduction in the contract unit price for the relevant pay item or accept a guaranty bond in accordance with subsection [104.04](#).

**B. Nonconforming Materials Identified after Incorporation into the Work.** The Engineer will take one of the following actions for nonconforming materials identified after incorporation into the work:

1. The Engineer will reject the nonconforming materials in accordance with subsection [104.04](#).
2. The Engineer will allow the nonconforming materials to remain in place and will make a reduction in the contract unit price for the relevant pay item or accept a guaranty bond in accordance with subsection [104.04](#).

**105.09. Materials not Incorporated into the Work.** Before the Engineer will grant final acceptance, the Contractor must remove materials not incorporated into the work from the project in accordance with subsection [205.03.P](#), except for materials specially produced for the project.

The Department may purchase the materials specifically produced for the project but not incorporated into the work. If the Department decides to purchase these materials, the Department will only purchase the surplus quantity of these materials not incorporated into the work. The surplus quantity is the difference between the quantity of the material shown on the plans and the actual quantity of materials incorporated into the work. The Department will only pay the Contractor for the cost to produce, deliver, and handle these materials in accordance with subsection [109.05.C](#), excluding overhead and profit.

**105.10. Source of Steel and Iron.** The Contractor must provide steel and iron materials, for permanent incorporation into the work, that were produced only in the United States. FHWA may grant a waiver for steel and iron materials if they are not produced in sufficient and reasonably available quantities that are of satisfactory quality. Steel and iron materials include steel, steel products, and products that include steel components.

The Contractor must ensure that the manufacturing processes, including the application of coatings, for these materials and products occur in the United States. The application of coatings includes processes that protect or enhance the value of the material to which the coating is applied.

The Contractor may provide a minimal amount of foreign steel materials on the project, if the total invoice cost of the foreign steel materials permanently incorporated in the project does not exceed 0.1 percent of the original contract amount or \$2,500, whichever is greater. The Department defines the total invoice cost as the total value of the foreign steel materials delivered to the project.

The Contractor must submit written certification of compliance with the requirements of this subsection to the Engineer.



**Section 106. QUALITY ASSURANCE ACCEPTANCE PROGRAM**

**106.01. Quality Assurance Acceptance Program.** The Department's Quality Assurance Acceptance Program uses a statistical evaluation of test results to estimate the percent of a lot that meets the limits or tolerances established for each quality index parameter. The limits or tolerances for each quality index parameter are specified in the relevant section of the specifications. The Department will use the percent within limits (PWL) to calculate a pay adjustment for each lot tested. The Department will base acceptance and payment on the quality index parameters established in the contract for each pay item covered by this acceptance program. Refer to the contract and the [Materials Quality Assurance Procedures Manual](#) for details.

## **Section 107. LEGAL RELATIONS AND RESPONSIBILITIES TO THE PUBLIC**

**107.01. Laws to be Observed.** The Contractor must be familiar with all state and federal laws, rules, executive orders, regulations, agricultural quarantines, local ordinances, and State Administrative Board resolutions that are current at the date of the advertisement and that supplement the contract or affect the equipment and materials used in the proposed construction, those employed on the work, and the conduct of the work. The Contractor must hold harmless and indemnify the Department and its representatives against any claim arising from any violation.

It is the Contractor's responsibility to determine what the laws require and then, at the sole expense of the Contractor, to perform the work required by the contract in whatever manner may be necessary to comply with all applicable laws. The Contractor is liable to the Department for fines, remediation, or environmental response costs incurred by the Department because of the Contractor's failure to comply with federal, state, and local laws.

It is the Engineer's right to shut down affected operations if the Contractor does not comply with the applicable laws. The Engineer also has the right to direct the Contractor to implement immediate remedial action to bring the affected operations into compliance. The Contractor is not entitled to a time extension or compensation for delays, inconvenience, or any other cause attributed to the Engineer suspending the work or directing remedial actions to bring the affected operations into compliance with the applicable laws.

Pursuant to 1976 PA 453 Elliot-Larsen Civil Rights Act, the Contractor agrees not to discriminate against an employee or applicant for employment with respect to hire, tenure, terms, conditions, or privileges of employment, or a matter directly or indirectly related to employment, because of race, color, religion, national origin, age, sex, height, weight, or marital status. The Contractor further agrees that every subcontract entered for the performance of the contract will contain a provision requiring nondiscrimination in employment binding upon each subcontractor. Breach of this covenant may be regarded as a material breach of the contract.

Pursuant to 1976 PA 220 Persons with Disabilities Civil Rights Act, the Contractor agrees not to discriminate against an employee or applicant

for employment with respect to hire, tenure, terms, conditions, or privileges of employment, or a matter directly or indirectly related to employment, because of a disability unrelated to the individual's ability to perform the duties of a particular job or position. The Contractor further agrees that every subcontract entered for the performance of the contract will contain a provision requiring nondiscrimination in employment binding upon each subcontractor. Breach of this covenant will be regarded as a material breach of the contract.

Pursuant to the Davis-Bacon and Related Acts contained in 29 CFR, Parts 1, 3 and 5 and 1965 PA 166 Prevailing Wages on State Projects, the Contractor must comply with all labor compliance provisions in the contract and as specified in the current written Department procedures for prevailing wage compliance oversight.

**107.02. Permits and Licenses.** The Contractor must obtain and pay for permits and licenses required by the contract and necessary for the lawful prosecution of the work, unless otherwise issued to or by the Department.

**A. Reimbursement of Fees.** The Department will reimburse the Contractor for the following:

1. Permit fees required by local government agencies to construct work as required by the contract; and
2. That portion of deposits or cash bonds required by local government agencies charged for inspection fees.

**B. Environmental Permits.** The Contractor must follow the requirements outlined in the permits issued to the Department. If the proposed work or work methods necessitate a change in conditions for permits issued under the following provisions, the Contractor must provide a written request to the Engineer to change the permits issued under either of the following:

1. 1994 PA 451 Natural Resources and Environmental Protection Act:
  - a. Part 31, Water Resources Protection;
  - b. Part 31, National Pollutant Discharge Elimination System (NPDES);
  - c. Part 301, Inland Lakes and Streams; and
  - d. Part 303, Wetland Protection.
2. U.S. Army Corps of Engineers' Section 404, Dredge and Fill.

The Contractor must not proceed with the change until the Department provides written approval. The Department's approval of the change will

require internal coordination and the Contractor should therefore anticipate some delay. If the Department determines the requested change is detrimental to the environment, the Department will not submit a permit revision request to MDNRE. The Contractor is not entitled to a time extension or compensation for delays, inconvenience, or any other cause attributed to obtaining, or the inability to obtain, the permit changes, unless the need for the permit change was the result of a contract revision in accordance with subsection [103.02](#).

**107.03. Patented Processes and Materials.** The Contractor must defend all patent infringement suits resulting from the use of designs, devices, material, or processes employed to construct the work as required by the contract. The Contractor must hold harmless and indemnify the Department against suits or claims for royalties, damages, and costs.

The Contractor is responsible for submitting to the Engineer a written statement from the patentee or licensee for plans, not supplied by the Department, that embody the use of any patented process, device, or design. The statement must set forth the exact terms under which the plans are to be used and the fixed price for which the Contractor may use the plans, processes, devices, or designs without further liability.

**107.04. Federal Aid Participation.** If any federal laws, rules, or regulations conflict with any provisions of a federally assisted contract, the federal requirements must prevail, take precedence, and be in force over and against such provisions.

If the cost of the contract work includes federal participation, the work will be under the supervision of the Department, but is subject to the inspection and approval of the proper officials of the United States Government. Inspections made by authorized federal representatives will not make the United States Government a party to the contract and will not interfere with the rights of the contract parties.

The making or use of false statements by the Contractor relating to documentation is a felony punishable by a fine of no more than \$10,000, imprisonment for no more than 5 years, or both. Making or using false claims for obtaining payment against federal funds subjects violators to forfeiture of \$2,000 for each violation. This is in accordance with the anti-fraud statute originating from the Federal-Aid Road Act of 1916.

**107.05. Sanitary Provisions.** The Contractor must provide and maintain, in a neat and sanitary condition, facilities for the Contractor's employees to comply with the requirements and regulations of the federal, state, and local health authorities, and must take precautions to avoid creating unsanitary conditions.

The Contractor must remove temporary sanitary facilities from the project limits before final acceptance. The Contractor must construct, maintain, and remove temporary sanitary facilities at no additional cost to the Department.

**107.06. Furnishing Right-of-Way.** The Department will be responsible for the following:

- A. Securing right-of-way necessary for the project before construction, and
- B. Identifying in the contract any right-of-way that the Department has not secured.

**107.07. Protection and Restoration of Property.** The Contractor must restore, at no additional cost to the Department, public and private property damaged because of acts or omissions by the Contractor and the employees and agents of the Contractor, to a condition similar and equal to that existing before the damage occurred. If the Contractor neglects to make restoration within 7 days of receiving written notice from the Engineer, or as otherwise required by applicable laws or regulations, the Engineer may proceed to make the restoration. The Engineer will deduct the cost of the restoration from monies that are or may become due the Contractor.

**107.08. Land Monuments and Property Corners.** The Contractor must locate and preserve existing public land survey corners, property-controlling corners, and alignment control points as shown on the plans or as directed by the Engineer. The Contractor must provide a professional surveyor, licensed in the State of Michigan, to perform work necessary to maintain the corners. This work must be completed, and will be paid for, in accordance with section [821](#).

**107.09. Archaeological and Historical Findings.** If the Contractor finds what appear to be items of potentially archaeological or historical significance (such as bones, artifacts, or buried foundations), the Contractor must immediately stop operations in that location and notify the Engineer. The Engineer will investigate and will direct the Contractor

either to resume operations or to continue the suspension of operations, in accordance with subsection [104.01.B](#).

The Contractor must cooperate in the recovery of archeological and historical items, as directed by the Engineer. The Department will pay the Contractor and grant a time extension for any delay related to the recovery of archeological and historical items as extra work in accordance with subsection [103.02](#).

### **107.10. Indemnification, Damage Liability, and Insurance.**

**A. Indemnification.** The Contractor must hold harmless, indemnify, and defend in litigation the State, the Commission, the Department, and their agents and employees against claims for damage to public or private property and for injuries to persons arising out of the performance of the work until the Contractor achieves satisfactory final inspection in accordance with subsection [109.07.C.1](#). The Contractor will not be responsible for claims that result from the sole negligence or willful acts or omissions of said indemnitee.

**B. Workers' Compensation Insurance.** The Contractor must carry the necessary Workers' Compensation Insurance and must submit a certification that it carries Workers' Compensation Insurance to the Department in accordance with subsection [102.15](#).

**C. Bodily Injury and Property Damage.** The Contractor must carry adequate insurance, satisfactory to the Department, to afford protection against claims for damage to public or private property and injuries to persons arising out of the performance of the work until the Contractor achieves satisfactory final inspection in accordance with subsection [109.07.C.1](#). If required by the contract, the Contractor must also carry adequate insurance to protect the owner of premises on or near which construction operations are to be performed. Copies of completed certificates of insurance must be submitted to the Department, in accordance with subsection [102.15](#).

**1. Bodily Injury and Property Damage Other Than Automobile.** Unless otherwise required by the contract, the Contractor must provide the following minimum limits of property damage and bodily injury liability:

## Bodily Injury and Property Damage Liability:

|                 |             |
|-----------------|-------------|
| Each Occurrence | \$1,000,000 |
| Aggregate       | \$2,000,000 |

This insurance must include coverage for the following:

- a. Underground damage to facilities due to drilling and excavating with mechanical equipment; and
  - b. Collapse or structural damage to structures due to blasting or explosion, excavation, tunneling, pile driving, cofferdam work, or the moving or demolition of buildings.
2. **Bodily Injury Liability and Property Damage Liability Automobile.** Unless otherwise required by the contract, the Contractor must provide the following minimum limits of bodily injury liability and property damage liability:

## Bodily Injury Liability:

|                 |             |
|-----------------|-------------|
| Each Person     | \$500,000   |
| Each Occurrence | \$1,000,000 |

## Property Damage Liability:

|                 |             |
|-----------------|-------------|
| Each Occurrence | \$1,000,000 |
|-----------------|-------------|

## Combined Single Limit for Bodily Injury and Property Damage Liability:

|                 |             |
|-----------------|-------------|
| Each Occurrence | \$2,000,000 |
|-----------------|-------------|

3. **Umbrella Policy.** The Contractor may meet the requirements of subsection [107.10.C.1](#) and subsection [107.10.C.2](#) through an umbrella policy.
4. **Owners Protective Liability.** The Contractor must ensure that the insurer extends bodily injury and property damage protection, including general supervision of work performed, to the State, the Commission, the Department, and their agents and employees and, as indicated by the identity of the contracting parties, to participating political subdivisions and public corporations. The minimum limit will be \$1,000,000.

In lieu of the Owners Protective Liability, the Contractor must add to their Bodily Injury and Property Damage Policy:

- a. **Additional Insured.** The Bodily Injury and Property Damage Policy must name as additional insured the State, the Department, and the Commission and all agents and employees thereof and, where indicated by the identity of the contracting

parties, the protection must be extended to all participating political subdivisions and public corporations.

- b. **Per Project Aggregate.** The Bodily Injury and Property Damage Policy must be endorsed with an endorsement that provides the General Aggregate Limit to each designated construction project.
- c. **Umbrella Policy.** An umbrella policy with a \$2,000,000 limit must be provided.

D. **Notice.** The Contractor must ensure that all insurance policies and binders include an endorsement by which the insurer agrees to notify the Department in writing at least 30 days before there is a cancellation or material change in coverage. The Contractor must stop operations if any insurance is canceled or reduced, and must not resume operations until new insurance is in force.

E. **Damage Claims.** The Contractor is responsible for acting on damage claims that occur from execution of the contract until the Contractor achieves satisfactory final inspection in accordance with subsection [109.07.C.1](#). The Contractor may act directly with the claimant or through the claimants' insurance carrier.

1. **Damage Claim Program.** Before beginning construction on the project, the Contractor must submit a written damage claim program for approval by the Engineer. The damage claim program must outline the Contractor's plan for the investigation and disposition of damage claims. The Contractor must meet with the Engineer to discuss the damage claim program and develop a mutual understanding of how the Contractor will govern, administer, and enforce the program.
2. **Damage Claim Officer.** The Contractor must provide written notification to the Engineer of the name and contact information for the Contractor's Damage Claim Officer. The Damage Claim Officer is the person with the authority and responsibility to administer the Contractor's damage claim program.
3. **Damage Claim Process.** The Engineer will submit damage claim forms received by the Department to the Contractor within 14 days from the first contact with the claimant. The Contractor must act on damage claims within the time frames specified in this subsection,



and must submit to the Engineer a report on damage claims received that includes information as specified in subsection [107.10.E.5](#).

- a. **Claims Less Than or Equal To \$1,500.** The Contractor must reach final disposition and notify the claimant within 60 calendar days of receipt of the damage claim form from the Engineer. If the Contractor fails to reach final disposition and notify the claimant within 60 calendar days, the Engineer will enforce subsection [107.07](#). In this circumstance, the Department defines restoration as payment to the claimant for alleged damages as documented on the original damage claim form. If payment is made based on failure to meet the time requirement, the claimant must sign a waiver indicating that payment was made because of a failure to meet the time requirement not because of the merit of the damage claim. Before the 60 calendar days expires, the Contractor may request an extension of no more than 30 calendar days for documented circumstances beyond the Contractor's control. The Contractor must make this request in writing to the Engineer.
  - b. **Claims Greater Than \$1,500.** The Contractor must reach final disposition and notify the claimant within 120 calendar days of receipt of the damage claim form from the Engineer. If the 120 calendar days expire prior to final acceptance of the project, the Engineer will withhold the amount of the damage claim from payments to the Contractor until the Contractor reaches final disposition and notifies the claimant.
4. **Final Disposition.** The Department will withhold from the final estimate or monies due or to become due the Contractor an amount not exceeding the aggregate amount of all outstanding and unresolved damage claims until final disposition of all damage claims. Final disposition for damage claims \$1,500 or less must include payment, settlement, or denial of the damage claim by the Contractor's insurer or the Contractor. Final disposition for damage claims over \$1,500 must include payment, settlement, or denial of the damage claim by the Contractor's insurer, or settlement or payment by the Contractor.
  5. **Documentation Requirements.** The Contractor must use the Department's standard forms for processing damage claims, unless otherwise approved by the Engineer. The Contractor must submit to

the Engineer a report upon final disposition of each damage claim. The report must include the following information:

- a. Location of the incident;
- b. Specific work activities for day and time of damage claim;
- c. Detailed weather and road conditions;
- d. Traffic movements, signing, equipment in use;
- e. Any unusual occurrences;
- f. Measurements taken at the time or location of the incident;
- g. Records of all contact with Engineer or claimant to discuss disposition;
- h. Other documentation pertinent to the damage claim; and
- i. Report of final disposition of damage claim.

**107.11. Contractor's Responsibility for the Work.** Until the Contractor achieves satisfactory final inspection in accordance with subsection [109.07.C.1](#), the Contractor is responsible for the work and must take every precaution against injury to the public or otherwise, or damage to public or private property due to the elements or other causes. The Contractor is responsible for any expense resulting from and of the aforementioned injuries or damages. The Contractor must rebuild, repair, restore, and make good any injury or damage to the work before the Contractor achieves satisfactory final inspection in accordance with subsection [109.07.C.1](#), and at no additional cost to the Department, except for injury or damage that is beyond the Contractor's control and not the fault of the Contractor, including, but not limited to, the following:

- A. Acts of God or of the public enemy;
- B. Acts of the Government;
- C. Slides found by the Engineer to have been unavoidable;
- D. Ordinary wear and tear on sections of the road opened to traffic as required by the contract or ordered by the Engineer; and
- E. Maintenance and third party damage responsibility for portions of the work that have been granted partial acceptance, or designated for delayed acceptance, by the Department in accordance with subsection [109.07](#).

The Contractor must obtain approval from the Engineer for use of drainage facilities (existing or per the contract), belonging to the Department or another state or local government agency. The Engineer and the Contractor must determine the condition of the facilities and make arrangements to allow use. Before the Contractor achieves satisfactory final inspection in accordance with subsection [109.07.C.1](#), the Contractor must restore drainage facilities used or affected by the Contractor's operations to a condition that is equal to or better than the

condition of the facilities before the Contractor's use. Drainage facilities include catch basins, manholes, inlets, sumps, sewers, lift stations, outlets, and open drainage systems.

In case of suspension of work, the Contractor is responsible for the proper storage of materials and providing suitable drainage of the project.

**107.12. Contractor's Responsibility for Utility Property and Services.** For protection of underground utilities and in accordance with 1974 PA 53, the Contractor must notify Miss Dig at least 3 work days, excluding Saturdays, Sundays, and holidays, before beginning each excavation in areas where public utilities have not been previously located. Utility members will thus be routinely notified. This does not relieve the Contractor of its responsibility to notify utility owners identified in the contract that are not part of the Miss Dig alert system.

The Department's freeway lighting system, the ITS, and other miscellaneous electrical systems are not a part of Miss Dig. The Contractor must contact the maintenance representative at the MDOT Region Office before starting work near lighting systems, the ITS, and traffic systems. The Contractor must not start this work until the Department has staked the lighting systems, the ITS, and traffic systems.

The Contractor must not start work until arrangements are made for the protection of adjacent utilities, or other property where damage might result in expenses, loss, or inconvenience.

The Contractor must cooperate with the utility owner in the removal, relocation, and reinstallation work.

**107.13. Personal Liability of Public Officials.** The Commission, Director, Engineer, and their authorized representatives are not liable, either personally or as officials of the State, for exercising the authorities granted to them by the contract. It is understood that they act solely as agents and representatives of the State.

**107.14. No Waiver of Legal Rights.** The Department and the Commission are not precluded or estopped by measurements, estimates, or certificates made before or after the completion, acceptance, and payment for the work, from showing the true amount and character of the work performed and materials provided by the Contractor, nor from showing that these measurements, estimates, or

certificates are untrue or incorrectly made, or that the work or materials do not conform to the contract. The Department and the Commission are not precluded or estopped, notwithstanding measurements, estimates, or certificates and payments from recovering from the Contractor and the Surety overpayment that may have been caused by the erroneous measurement, estimate or certification and damages it may have sustained by reason of the Contractor's failure to comply with the terms of the contract. Neither the acceptance by the Director or by the Director's representative, nor payment for or acceptance of the whole or part of the work, nor extensions of time, nor possessions taken by the Department will operate as a waiver of portions of the contract or of power reserved, or right to damages provided. A waiver of any breach of the contract is not a waiver of any other or subsequent breach.

**107.15. Compliance with Laws; Environmental Protection.** The Contractor must take the measures during the performance of the work that are necessary to comply with federal, state, and local laws and regulations for the protection of the public health, safety, welfare, and environment. Unless the contract provides otherwise, the costs related to complying with these laws and regulations are included in the contract unit prices for related items of work.

The following are specific requirements with regard to environmental protection matters.

**A. Control of Air Pollution.**

1. **Dust Control.** During the construction of a project, the Contractor must maintain adequate dust control measures to prevent any detriment to the safety, health, welfare, or comfort of any person or damage to property, residence, or business. If the contract does not contain a pay item for dust control, the cost of the dust control is included in the contract unit price for other pay items.
2. **Hot Mix Asphalt Plants, Concrete Plants, and Crushing Plants.** All hot mix asphalt (HMA) plants, portland cement concrete proportioning plants, and crushing plants must be in compliance with the rules of the MDNRE.

For portable HMA plants, portland cement concrete proportioning plants, or crushing plants, the Contractor must obtain a permit-to-install from the MDNRE Permit Section, Air Quality Division (AQD). Application for this permit must be made at least 30 calendar days

before installing plants with an active MDNRE permit, or at least 60 calendar days before installing plants without an active MDNRE permit.

3. **Open Burning.** The Contractor must obtain the Engineer's approval before burning trees, brush, or stumps at the site of land clearing operations within the project limits. The Contractor must burn at least 1,400 feet from the limits of any incorporated municipality and must comply with any local ordinances or state regulations. Adequate control measures must be maintained to prevent any detriment to the safety, health, welfare, or comfort of any person or damage to property, residence, or business.
4. **Demolition or Renovation Notification.** The Contractor must not begin demolition of any building or structure without first submitting the appropriate notifications as required by the contract.

The Contractor must provide copies of all notifications to the Engineer prior to beginning demolition or before the removal of any regulated asbestos containing material.

**B. Construction Site Storm Water Runoff.** The Contractor must perform the work in a manner that will prevent sediment from entering watercourses, streams, lakes, and wetlands. In addition to the soil erosion and sedimentation control requirements of section [208](#), the Contractor must employ good housekeeping and pollution prevention practices to prevent construction related pollutants from entering the storm water drainage system or being carried outside of the project limits by storm water runoff. Potential sources of storm water pollutants include, but are not limited to, the following:

1. Materials storage areas,
2. Equipment maintenance and refueling areas,
3. Construction waste receptacles,
4. Concrete washout areas,
5. Sanitary facilities, and
6. Field office sites.

**C. Control of Hazardous and Polluting Materials.** The Contractor must use, store, and dispose of hazardous materials, hazardous waste, toxic materials, or polluting materials in accordance with applicable federal, state, and local laws and regulations.

1. **Fueling and Equipment Maintenance Area.** The Contractor must store fuel, perform equipment maintenance, and clean or wash vehicles and equipment, including concrete trucks, in an area equipped as follows:
  - a. Located at least 50 feet from storm drainage systems, wetlands or watercourses;
  - b. Paved or lined with a surface that will protect the soil, ground water, and surface water;
  - c. Surrounded by a containment berm; and
  - d. Equipped with a sump to collect and properly dispose of waste material.

The Contractor may propose a written plan to provide alternate protective measures for fueling and equipment maintenance areas to the Engineer for approval.

The Contractor must restore these areas in accordance with the project clean-up requirements in section [209](#).

2. **Equipment Cleaning and Washing.** The Contractor must:
  - a. Limit vehicle and equipment cleaning or washing within the project limits to that necessary to control vehicle tracking;
  - b. Notify the Engineer before cleaning or washing vehicles or equipment within the project limits with soap, solvents, or steam;
  - c. Contain any resulting waste and recycle or dispose of the waste in accordance with state and federal regulations;
  - d. Not use materials containing petroleum distillates to clean vehicles or equipment and must minimize the use of solvents for this purpose;
  - e. Inspect sumps regularly and remove liquids and sediments as necessary;
  - f. Use as little water as possible If washing vehicles or equipment with water; and
  - g. Equip hoses with positive shutoff valves.

**107.16. Forest Protection.** If performing work within or adjacent to State or National Forests, the Contractor must comply with relevant regulations of the State and Federal agencies. In National Forests, the Contractor must contact the United States Forest Service Forest Supervisor, for the appropriate section of the State, regarding the work the Contractor will be performing within or adjacent to the forest land. In State Forests, the Contractor must contact the State Forester, Forest

Management Division, MDNRE, Lansing, regarding the work to be performed within or adjacent to the forest land. The Contractor must contact the Forest Protection Section Leader, Forest Management Division, MDNRE, Lansing, to obtain burning permits.

The Contractor must observe sanitary laws and regulations with respect to the performance of work in forest areas. The Contractor must keep the forest areas in an orderly condition, dispose of refuse, and obtain permits for the construction and maintenance of construction camps, stores, warehouses, residences, latrines, cesspools, septic tanks, and other structures according to the requirements of the Forest Supervisor or State Forester.

The Contractor must obtain permits before burning refuse from clearing and grubbing operations, and require that employees and subcontractors take all precautions reasonably within their power to prevent and suppress forest fires including:

- A. Assist in preventing and suppressing forest fires at the request of Forest officials; and
- B. Make every possible effort to notify a Forest official at the earliest possible moment of the location and extent of any fire observed in the area.

**107.17. Use of Explosives.** Before using explosives on the project, the Contractor must obtain prior written approval from the Engineer. Such approval does not relieve the Contractor of liability or responsibility for damages resulting from the use of explosives. The Contractor must comply with all laws, regulations, and ordinances and exercise the utmost care not to endanger life or property, including new work.

**107.18. Work Over Navigable Waters.** The Contractor must perform work on or over navigable waters in accordance with any permits issued by the controlling authority.

**107.19. Hauling on Local Roads and Streets.** Before hauling materials on local roads and streets, the Contractor is responsible for obtaining approval from the respective local government agency with jurisdiction over the proposed haul routes. The Contractor must ensure haul loads are within the legal load limits established by the local government agency. The Contractor is responsible for preventing the tracking of material onto local roads and streets, and must remove such material at no additional cost to the Department.

**107.20. Private Railroad Crossing for Haul Purposes.** If a temporary railroad crossing is necessary, the Contractor is responsible for the following:

A. Requesting the railroad company to construct the temporary crossings and notifying the railroad company in advance of Contractor's use of the temporary crossings. This is subject to the Contractor meeting the railroad company's requirements, including executing agreements and providing insurance coverage.

B. Determining and complying with the requirements of the railroad company covering the location, installation, protection, maintenance, use, and removal of the temporary crossing. Unless otherwise required by the contract, the costs related to the temporary crossing, including but not limited to the following, are included in the contract unit prices for other pay items:

1. Installation, protection, maintenance, and removal of the temporary crossing;
2. Flaggers;
3. Construction engineering inspection by the railroad company;
4. Contractual liability insurance for the temporary crossing and any other insurance required by the railroad company; and
5. Incidental work, such as drainage facilities and the removal, alteration, and replacement of railroad fences.

**107.21. Approved for Traffic.** The Contractor must not open the project or sections thereof to traffic until approved by the Engineer. Whenever the project or section thereof is in a condition suitable for traffic as determined by the Engineer, the Engineer may designate it "Approved for Traffic" before project completion and the Contractor must open the project or section thereof to traffic as directed by the Engineer. To determine whether the project or section thereof is suitable for traffic, the Engineer will verify that the surfacing material, shoulders, guardrails, signs, and other appurtenances are completed as required by the contract. The Engineer's approval of the project or section thereof for traffic does not constitute partial or final acceptance of the project or any part of it, or a waiver of any provision of the contract. The Contractor is not responsible for the costs of maintaining the section of the project opened for traffic.

If the Engineer designates the entire project or any section of it as "Approved for Traffic" and the Contractor opens it to traffic before final acceptance and final payment, the Contractor must perform the remainder of the work in a manner that causes the least obstruction to traffic. The Contractor must make provisions for the safety of traffic as



required by the contract. Legal weight restrictions, established by 1949 PA 300 as amended, local ordinances, or legal posting, must apply to sections of the project designated as “Approved for Traffic.”

Before the seasonal suspension, the Engineer will determine the work the Contractor must complete to bring the project to an acceptable condition for traffic and winter maintenance, including necessary traffic and erosion control measures. Until the Contractor completes this work, the Engineer will not designate the project “Approved for Traffic.”

On sections of the project opened to traffic, the Contractor must correct damage due to defective materials, to faulty workmanship, to operations of the Contractor, and to natural causes (except as provided in subsection [107.11](#)), at no additional cost to the Department.

## Section 108. PROSECUTION AND PROGRESS

**108.01. Subcontracting of Contract Work.** No portion of the contract may be subcontracted, other than the providing of necessary materials, except as provided for in the Department's procedures for subcontracting. Subcontracting any portion of the work does not relieve the Contractor of full responsibility for the performance of the contract. Written consent of the Department is required to sell or assign any portion of the contract.

The Contractor must use its own organization to perform work amounting to at least 40 percent of the original contract amount. The phrase "its own organization" includes only workers employed and paid directly, inclusive of employees who are employed by a lease agreement acceptable to the Department, and equipment owned or rented with or without operators; and does not include employees or equipment of a subcontractor, assignee, or agent of the Contractor. All items identified as Designated or as Specialty Classifications may be performed by subcontract. The amount of Specialty Classification work performed may be deducted from the original total contract price before computing the amount of work required to be performed by the Contractor's own organization. The 60 percent available for subcontracting must include work identified in the contract as designated classifications and all other work, except specialty classifications.

The Department will determine the value of subcontracted work by multiplying the number of units of a subcontracted pay item by the contract unit price for that pay item. If any portion of a pay item is subcontracted, only that portion of the work to be performed by a subcontractor will be used for determining the percentage of the total work subcontracted. The Department will determine if the subdivision of the subcontracted pay item and the unit price is reasonable.

Bonds furnished by the subcontractor do not reduce the Contractor's bonding requirements.

The Contractor must only issue subcontracts to subcontractors that are prequalified by the Department to perform the classification of work proposed, if applicable. The Contractor must submit the subcontract cover page and pay items to the Engineer responsible for the administration of the contract, before the start of the work associated with the subcontract. The Department's prequalification of the subcontractor is for the benefit of the Department and is not for the

benefit of the Contractor or any other person. The Department's prequalification is not a guarantee or warranty of the subcontractor's ability to perform or complete the subcontracted work. Before final acceptance, the Contractor must certify that the Contractor has met the subcontracting requirements using Form 1386 [Post Certification of Subcontract Compliance](#). The Contractor must itemize the name of each subcontractor, the amount of each subcontract, and the amount paid for each subcontract.

No subcontractor or supplier may maintain an action against the Department for payment relating to the work; any such action must be brought against the Contractor or other responsible party.

A subcontractor must perform not less than 50 percent of the total value of the subcontracted work with the subcontractor's own organization. This requirement is also applicable to and binding upon successive subcontracts.

If any subcontractor is working or subcontractor's equipment is being operated in violation of this subsection, the Engineer may direct the immediate removal of the subcontractor or the subcontractor's equipment. The Contractor is responsible for any costs or damages resulting from such removal. The Contractor's responsibilities in the performance of the work, in case of a subcontract, are the same as if the Contractor performed the subcontracted work with its own organization.

**108.02. Limitations of Operations.** Unless the contract requires or the Engineer approves otherwise, the Contractor must not perform construction operations on Sunday. The Contractor may perform emergency repairs or install proper protection of the work on Sundays.

The Engineer may require the Contractor to cease construction operations during holiday periods or at other times as may be determined to be in the interest of the public.

**108.03. Competence of Workers.** The Contractor must provide the labor to perform the work as required by the contract. The Contractor's workers must possess the skill and experience to perform the assigned work in accordance with the contract.

If the Engineer determines that any worker employed by the Contractor or by any subcontractor does not perform the work in a proper and skillful manner, or is intemperate or disorderly, the Engineer will issue a written

direction for removal of the worker. The Engineer's written direction will state in detail the reasons for the removal of the worker including specific reference to the worker's offending conduct and the affected work operation(s). The Contractor may appeal the Engineer's direction, during which appeal the Engineer's direction will be suspended. The Contractor may not employ the removed worker again in any portion of the work without the Engineer's approval.

If the Engineer's direction stands and the Contractor fails to do either of the following, the Engineer may suspend the work by written notice, withhold partial payment, or both until the Contractor complies with the contract requirements:

- A. Remove such worker or workers as required above, or
- B. Provide the labor for the proper prosecution of the work.

**108.04. Adequacy of Methods and Equipment.** The Contractor must use equipment of sufficient size and in a mechanical condition necessary to perform the work required by the contract.

If the contract does not require specific methods and types of equipment to perform an item of the work, the Contractor may use any method or type of equipment that will accomplish the work in accordance with the contract.

If the contract requires specific methods and types of equipment to perform an item of the work and the Contractor wants to use another method or type of equipment, the Contractor must obtain the Engineer's approval before using the other method or type of equipment. The Contractor must submit a written request to the Engineer that includes a full description of the proposed methods and types of equipment and the reasons for requesting the substitution. If the Engineer approves the request, the Contractor remains fully responsible for performing the work in accordance with the contract. If, after a reasonable trial, the Engineer determines that the work performed is not in accordance with the contract, the Contractor must stop using the substitute method or type of equipment. The Contractor must remove and replace the non-conforming work, or take other corrective actions approved by the Engineer. The Contractor is not entitled to a time extension or compensation for delays, inconvenience, or any other cause attributed to the failure of the Contractor's substituted method or type of equipment to accomplish the work in accordance with the contract, even if the Engineer approved of the substitution.

**108.05. Progress of the Work.** The Contractor must develop and maintain a detailed progress schedule in accordance with subsection [108.05.A](#). When approved, the progress schedule, or updated progress schedule, will become part of the contract.

The Department may require a critical path network schedule that will, upon approval, replace the progress schedule. The “critical path” is the longest continuous path of activities through the schedule that establishes the scheduled completion date. The critical path is typically the path of activities with the least total float. The critical path may follow different paths of activities at different times during the performance of the work due to the progress of the work or revisions made to the schedule.

#### **A. Progress Schedule.**

1. **General.** The Department’s approval of any schedule does not relieve the Contractor of its responsibilities to adjust labor and equipment forces or work schedules and provide sufficient materials to complete the work within the contract time.
2. **Progress Schedule Format and Content.** Unless the contract requires otherwise, the Contractor may submit the progress schedule on Form 1130 [Progress Schedule](#) or may use a diagramming method describing the work activities with the associated relationships. If submitting a diagramming method as the progress schedule, the Contractor must attach Form 1130 for signatures and approvals.

The progress schedule must reflect the scope of work and sequence of operations required by the contract, and must include the following:

- a. Controlling operations for the completion of the project and the planned dates or days (for workday projects) for these controlling operations;
- b. Non-controlling operations to detail the work necessary to complete the project, if directed by the Engineer; and
- c. Controlling dates specified in the proposal including open-to-traffic dates or project completion dates.

The Department may allow overlapping or concurrent controlling operations if the Contractor provides a written explanation of the associated overlap or concurrent controlling operation for each

occurrence. The Contractor must submit the explanation with the progress schedule.

3. **Progress Schedule Updates.** The Contractor must update the progress schedule within 14 calendar days of the occurrence of any of the following events:
- a. The Contractor's rate of progress falls behind that represented in the latest progress schedule;
  - b. A contract revision affects a controlling operation;
  - c. The Contractor revises its sequence of operations from that represented in the latest progress schedule; or
  - d. There is a change to the reasons for overlapping or concurrent controlling operations.

The Engineer will approve or reject the updated progress schedule, in writing, within 14 calendar days of the Contractor's submittal.

If the Contractor fails to update the progress schedule the Engineer may withhold biweekly pay estimates. The cost of preparing and updating the schedule is included in the contract unit prices for other pay items.

**B. Prosecution of the Work.** The Contractor must not begin work until after the award of the contract. After the Department notifies the Contractor of the award of the contract, the Contractor must perform the work according to the approved progress schedule and with sufficient resources to adequately complete the work within the contract time.

If the Contractor fails to perform the work in accordance with the approved progress schedule, the Department may prevent the Contractor from bidding future projects until the Contractor establishes a satisfactory rate of progress.

If the Contractor fails to perform the work in accordance with the approved progress schedule or the Department believes that the Contractor is not performing the work to ensure completion within the contract time, the Engineer may require the Contractor to provide an updated progress schedule, within 48 hours of notice, detailing the efforts required to meet the requirements of the progress schedule. This requirement will not qualify as directed acceleration as stated in subsection [109.05.F](#). If the Contractor fails to perform as directed, the Engineer may place the Contractor in default in accordance with subsection [108.11](#).

**108.06. Determination of Contract Time for Work Day Contracts.**

Starting no earlier than on the 10th day after the Contractor receives the notice of award or on the date agreed upon between the Engineer and the Contractor, the Engineer will determine and charge work days in accordance with subsections [108.06.A](#), [108.06.B](#), and [108.06.C](#).

The Engineer will provide the Contractor with a written report of the number of work days charged to the project each week within 6 days after the last day of the week covered by the report. If the Contractor disagrees with the number of work days charged in a report, the Contractor must notify the Engineer in writing and set forth the reasons for disagreement within 21 days after the last day of the week covered by the report. The Contractor's failure to notify the Engineer of disagreement within the times established in this paragraph constitutes acceptance of the Engineer's determination of the number of work days for that time period.

**A. Full Work Days.** The Engineer will charge full work days for the following days:

1. Every day the Contractor is able to perform work for six or more consecutive hours, beginning at the scheduled starting time, on a controlling operation with full and normal efficiency within seasonal limitations, except as listed in subsections [108.06.B](#) or [108.06.C](#) or as required by the contract;
2. Every day the Contractor elects to work for 6 or more consecutive hours, beginning at the scheduled starting time, or, on a controlling operation with full and normal efficiency within seasonal limitations, except as listed in subsections [108.06.B](#) or [108.06.C](#) or as required by the contract;
3. Sundays or holidays on which the Contractor performs work, if Sunday or holiday work is approved by the Engineer;
4. Days that the Contractor is unable to perform work on a controlling operation due to delayed delivery of materials, unless the Contractor identifies and the Department verifies that the delayed delivery is the result of an industry-wide shortage;
5. Days that the Contractor is performing required work, designated by the Engineer, to make the project acceptable for traffic and winter maintenance including emergency work or erosion control maintenance before or during the seasonal suspension; and
6. Days on which a delay to or suspension of the work is the fault of the Contractor.

**B. Half Work Days.** The Engineer will charge half work days for the following days:

1. Days the Contractor is only able to perform work on a controlling operation for between 3 and 6 consecutive hours beginning at the scheduled starting time, for reasons beyond the Contractor's control and not the Contractor's fault or responsibility;
2. Days the Contractor elects to, perform work on a controlling operation for between 3 and 6 consecutive hours beginning at the scheduled starting time, for reasons beyond the Contractor's control and not the Contractor's fault or responsibility; and
3. Days the Contractor is unable to perform work on a controlling operation with full and normal efficiency, for reasons beyond the Contractor's control and not the Contractor's fault or responsibility, including work stoppages due to a labor dispute.

**C. No Work Day.** The Engineer will not charge work days for the following days:

1. Saturdays, unless provided for in the contract;
2. Any day the Contractor is unable to perform work on a controlling operation for more than 3 consecutive hours beginning at the scheduled starting time, for reasons beyond the Contractor's control and not the Contractor's fault or responsibility, including work stoppages due to a labor dispute;
3. If work is performed on the controlling operation during the seasonal suspension, unless otherwise specified in the contract or in subsection [108.06.A.4](#);
4. When suspension of work on the controlling operation is required, through no fault of the Contractor, for reasons including but not limited to the following:
  - a. Right-of-way or right-of-entry was not available when a controlling operation was required to start;
  - b. Delays resulting from utilities not moved out of the Contractor's work area; and
  - c. Work on an adjacent project prevented the Contractor from performing work.

**108.07. Extension of Time on Work Day Contracts.** If the contract time is specified in work days, the Engineer will grant time extensions for the following excusable delays without liquidated damages for opening to traffic and completing within the contract time on the following basis:

A. If, on a controlling operation, there is an increase in the quantities set forth in the contract and this is not offset by decreases in similar pay



items, the Engineer will base the time extension on Formula 108-1, not to exceed the actual number of days required to perform the additional quantities of work.

$$E_w = \frac{T_w \times I}{Q} \quad \text{Formula 108-1}$$

where:

$E_w$  = Extension of time in work days,

$T_w$  = Work days assigned to the pay item on the progress schedule,

$I$  = Increased quantity of the pay item, and

$Q$  = Contract quantity of the pay item.

B. If there is extra work that delays a controlling operation, as shown on the progress schedule, the time extension will be the time the extra work delayed the controlling operation.

**108.08. Extension Of Time On Calendar Day Or Calendar Date Contracts.** If the contract time is specified in calendar days or by a calendar date, the Engineer will grant time extensions for the following excusable delays without liquidated damages for opening to traffic and completing within the contract time on each of the following bases:

A. If the Department fails to award the contract within 28 calendar days after the Department receives all required documents specified in subsection [102.15](#) from the Bidder, the time extension will be the duration of that delay.

B. If there are delays due to suspension of work ordered by the Engineer in accordance with subsection [103.02.D](#) that affect the controlling operation or the suspension changes the controlling operation(s) required for completion of the project, the time extension will be the duration of the delay. The suspension must be for causes other than negligence, faulty work, failure or refusal of the Contractor to carry out the provisions of the contract or the orders of the Engineer.

C. If there are delays due to unforeseen causes beyond the control and without the fault or negligence of the Contractor, including but not limited to the following, the time extension will be the duration of the delay to the controlling operation:

1. Acts of God;
2. Acts of the public enemy;
3. Acts of Government;
4. Acts of State or any political subdivision;
5. Fires, floods, and epidemics;
6. Labor disputes; or

7. Delayed delivery of the materials specified and approved for the project when the Contractor identifies and the Department verifies that the delay is an industry-wide shortage of materials.

D. If there are delays due to unusual weather conditions, the time extension will be the duration of the delay to the controlling operation. The Department may analyze unusual weather conditions for each calendar month or portion of it during the normal construction season (April 16 through November 14) each year for the following types of projects:

1. For standard projects, the contract completion date is based on a progress schedule using a 4 work day week, which assumes the Contractor will lose 1 work day per week because of weather. On standard projects, work days are considered to be Monday through Friday. If, during a calendar month, the Contractor is prevented from working on the controlling operation because of unusual weather conditions in excess of the average of 1 work day per week, the Contractor may request a time extension based on the difference between the actual work days lost that month compared to the normal work days lost per month. The Department will consider normal work days lost per month to be 4.5 workdays for May through October and 2.25 workdays for the partial months of April and November. The Department will convert work days to calendar days for projects with completion dates prior to September 15 by multiplying by 1.75 and, for projects with completion dates on or later than September 15, by multiplying by 2.0.
2. For expedited projects, the contract completion date is based on a progress schedule using a 5-work day week, which assumes the Contractor will lose 1 workday per week because of weather. On expedited projects, work days are considered to be Monday through Saturday. If, during a calendar month, the Contractor is prevented from working on the controlling operation because of unusual weather conditions in excess of the average of 1 work day per week, the Contractor may request a time extension based on the difference between the actual work days lost that month compared to the normal work days lost per month. The Department will consider normal work days lost per month to be 4.5 work days for May through October and 2.25 work days for the partial months of April and November. The Department will convert the work days to calendar days for projects with completion dates prior to September 15 by multiplying by 1.4 and, for projects with completion dates on or later than September 15, by multiplying by 1.75.

3. For any project, whether standard or expedited, a time extension granted for unusual weather conditions will not reduce the time or work days originally allowed for the Contractor to complete the work operations.

E. If, on a controlling operation, there is an increase in the quantities set forth in the contract and this is not offset by decreases in similar controlling items of work, the Engineer will base the time extension on Formula 108-2, not to exceed the actual number of days required to perform the additional quantities of work.

$$E_c = \frac{T_c \times I}{Q} \quad \text{Formula 108-2}$$

where:

$E_c$  = Extension of time in calendar days,

$T_c$  = Contract time assigned to the pay item on the progress schedule,

$I$  = Increased quantity of the pay item, and

$Q$  = Contract quantity of the pay item.

F. If there is extra work that delays a controlling operation, as shown on the progress schedule, the time extension will be the time the extra work delayed the controlling operation.

The Contractor may propose and the Engineer may approve another equitable method, supported by an acceptable rationale to determine time extensions.

### **108.09. Request For Time Extensions On Work Day, Calendar Day, And Calendar Date Contracts.**

A. **General.** The Contractor must submit written requests for time extensions to the Engineer. The request must state the reasons for the time extension. In case of delays due to unusual weather, the Contractor must submit requests for time extension within 14 days after the last day of the calendar month in which the delay occurred. The Contractor must submit requests for time extensions for all other delays within 14 days after the last day of the delay. Failure to notify the Engineer will constitute a waiver of claim for a time extension. The Engineer will respond with a written decision within 14 days of receipt of the request for the time extension.

The Engineer may grant time extensions, either with or without liquidated damages, and the Engineer will state the time extension using the same terms as the original contract time is stated. An extension of time to a

contract date subject to liquidated damages will apply equally to all contract dates subject to liquidated damages that are impacted by the extension of time. The Engineer will record the number of work days or calendar days granted for each time extension by authorization. The time for opening to traffic and the contract time as extended will thereafter be binding upon the Contractor and Surety as if they appeared in the contract originally.

If the Contractor disagrees with the Engineer's denial of a request for time extension for any reason not specifically covered elsewhere in the contract, the Contractor must notify the Engineer in writing within 7 days after receipt of the Engineer's denial and must proceed in accordance with subsection [104.10](#).

The Engineer will review claims for time extensions in accordance with the Department's written claim procedures.

If the Engineer allows the Contractor or the Surety to continue and complete all or any part of the work after the original or extended contract time, the Department will not have waived any rights under the contract.

**B. Compensable Delays.** Compensable delays are delays that are caused by the Department and could not have been reasonably foreseen or anticipated by the Contractor. The Contractor will be entitled to compensation for the delay computed in accordance with [109.05.E](#) only if the delay is caused by one or more of the following:

1. Contract revisions as defined in subsections [103.02.B](#), [103.02.C](#), [103.02.E](#), or [103.02.F](#);
2. Utility or railroad interference within the project limits;
3. An Engineer-ordered suspension as defined in subsection [103.02.D](#);  
or
4. The actions or neglect of the Department or its failure to act in a timely manner, including, but not limited to, unavailable right-of-way or right-of-entry, incomplete adjacent projects, and lack of Department-obtained permits.

**C. Non-Excusable Delays.** Non-excusable delays are delays that are the Contractor's fault or responsibility. All non-excusable delays are non-compensable. The Engineer will not grant time extensions for non-excusable delays.

**108.10. Liquidated Damages.** If the contract requires the Contractor to maintain through traffic while the Contractor is performing the work or if the contract does not contain a time requirement for opening to traffic, the provisions herein will apply to the contract time only.

The Department will not assess simultaneous liquidated damages for failure to open to traffic on time and for failure to complete within the contract time.

**A. Failure to Open To Traffic Within the Contract Time.** The Contractor must substantially complete the work so that the project, or portion of the project, can be safely opened to traffic in accordance with subsection [107.21](#), on or before the date the contract time expires. Unless the contract requires otherwise, the Department will assess liquidated damages in accordance with subsection [108.10.C](#) for each calendar day that the project or portion of the project remains unopened to traffic, including time within the seasonal suspension. The Contractor must continue work on the project until the Engineer designates that the project is "Approved for Traffic" and the work is suspended, except as otherwise provided in the contract. This may include the work necessary to make the project ready for seasonal suspension. For seasonal suspension, the Engineer will not designate the project "Approved for Traffic" until the project is in an acceptable condition for travel and winter maintenance, including necessary traffic control devices and erosion control measures.

Unless the contract requires otherwise, when the Department has determined that the project or a portion of the project is "Approved for Traffic" in accordance with subsection [107.21](#), the Department will discontinue the assessment of liquidated damages for failure to open to traffic.

**B. Failure to Complete Within the Contract Time.** The Contractor must complete the project on or before the date the contract time expires without liquidated damages. The Department will assess liquidated damages in accordance with subsection [108.10.C](#) for each calendar day that the work remains incomplete. For periods of seasonal suspension, the Department will not assess liquidated damages, except as provided in subsection [108.10.A](#), or as otherwise required by the contract.

**C. Assessment of Liquidated Damages.** Sums assessed as liquidated damages are not penalties, but are fixed and agreed upon liquidated damages due to the Department from the Contractor. The

liquidated damages may contain two or more components of damages added together.

1. **Liquidated Damages for Department Oversight Costs.** This component of liquidated damages represent the Department's added cost of engineering and supervision due to the Contractor's failure to open to traffic or complete the work within the contract time. The amount of these liquidated damages will be based on Table 108-1.

| <b>Original Contract Amount, \$</b> | <b>Amount per Calendar Day, \$</b> |
|-------------------------------------|------------------------------------|
| ≤49,999                             | 200                                |
| 50,000 – 99,999                     | 400                                |
| 100,000 – 499,999                   | 600                                |
| 500,000 – 999,999                   | 900                                |
| 1,000,000 – 1,999,999               | 1,300                              |
| 2,000,000 – 4,999,999               | 1,550                              |
| 5,000,000 – 9,999,999               | 2,650                              |
| 10,000,000 – 19,999,999             | 3,000                              |
| 20,000,000 – 49,999,999             | 3,800                              |
| ≥50,000000                          | 4,500                              |

2. **Liquidated Damages for Other Department Costs.** This component of liquidated damages represent the inconvenience to the public, maintenance of detours, and other items that have caused an expenditure of public funds due to the Contractor's failure to open to traffic or complete the work within the contract time. The contract will specify the amount of these liquidated damages.

### **108.11. Default of Contract.**

**A. Notice of Default.** If the Contractor is responsible for any of the following, the Engineer may give the Contractor and Surety written notice of default and the action required to be taken by the Contractor and Surety:

1. Failing to prosecute the work with the labor, equipment, or materials sufficient to complete the work within the contract time and according to the progress schedule;
2. Performing the work improperly;
3. Neglecting or refusing to remove material or to reconstruct work that has been rejected as defective and unsuitable; or
4. Failing to perform the work as required by the contract for any other reason.

**B. Department Completion of Work.** If any of the following occurs, the Department will have full power and authority to take the work out of the hands of the Contractor and Surety, including appropriation and use of any materials on the project, and use of a contract or any other method that the Department determines may be necessary to complete the work:

1. The Contractor or Surety, within a period of 10 days after the notice of default, does not proceed satisfactorily;
2. The Contractor commits any act of bankruptcy, becomes insolvent, or is declared bankrupt;
3. The Contractor allows a final judgment against the Contractor to remain unsatisfied for 5 days;
4. The Contractor makes an assignment for the benefit of the Contractor's creditors; or
5. The Contractor files proceedings for reorganization in accordance with the Bankruptcy Act, or such proceedings are filed against the Contractor.

If the Department takes over the uncompleted work, the Department will deduct all additional costs and damages, and the costs and charges of completing the same, from monies due or to become due the Contractor. If the total of the damages, costs, and charges exceeds the balance of the contract amount that would have been payable to the Contractor had the Contractor completed the work, the Contractor and Surety must pay the amount of the overage to the Department upon request.

**108.12. Termination of Contract.** If the Department determines that termination is in the Department's best interest, the Department may terminate the contract or any portion of the contract. If the Department orders termination of a contract effective on a certain date, the Department will pay the Contractor for completed or partially completed work as of that date at the contract unit prices or on a force account basis, as determined by the Engineer. If the Department terminates a portion of the contract, the Department may stop delivery and payment for materials made unnecessary. The Department will pay for pay items eliminated in their entirety by the termination in accordance with subsection [103.02.F](#).

The Department may choose to purchase from the Contractor acceptable materials obtained for the work but not used at actual cost delivered to a prescribed location plus 15 percent, or otherwise disposed of as mutually agreed.

The Contractor must submit any claim for additional compensation not covered in the contract within 60 days after the effective termination date, or as otherwise authorized by the Department. The Contractor must make records available to support the validity and amount of compensation sought. The Contractor is not entitled to loss of anticipated profits due to the Department's termination of the contract or any portion of the contract.

The Department's decision to terminate the contract or a portion of the contract will neither relieve the Contractor of its contractual responsibilities for the completed work, nor will it relieve the Surety of its obligation for any just claim arising out of the work performed.

**A. Reasons for Termination.** The Department may terminate the contract after determining that, for reasons beyond either the Department's or the Contractor's control, the Contractor is prevented from proceeding with or completing the contract work. Reasons for termination may include, but are not limited to, the following:

1. Executive orders by the President of the United States relating to war or national defense;
2. A national emergency that creates a serious shortage of materials;
3. Orders from duly constituted authorities relating to energy conservation, preservation of archaeological and historical findings, funding problems, or a change in project priorities;
4. Restraining orders or injunctions obtained by third-party citizen action resulting from national or local environmental protection laws, or where the issuance of the order or injunction is primarily caused by acts or omissions of persons or agencies other than the Contractor; or
5. A differing site condition or altered character of work amounting to significant additional contract costs.

**B. Immediate Obligations.** The Engineer will deliver a Notice of Termination to the Contractor that specifies the extent of termination and the effective date. After receipt of a Notice of Termination, the Contractor must immediately proceed with the following obligations:

1. Stop work as specified in the notice;
2. Place no further subcontracts or orders for materials, services, or facilities, except as necessary to complete the remaining portion of the contract;
3. Terminate all subcontracts to the extent they relate to the work terminated;



4. Transfer title and deliver to the Department the following:
  - a. For the fabricated, partially fabricated, or unfabricated parts, all work in progress, completed work, supplies and other material produced or acquired for the terminated work; and
  - b. The completed or partially completed plans, drawings, information, and other property that, if the contract had been completed, the Contractor would have been required to provide to the Department;
5. Complete the performance of the non-terminated work;
6. With the Engineer, on a date identified by the Engineer, take inventory of acceptable materials obtained for the project that has not been incorporated into the work; and
7. Take any action necessary, or directed by the Engineer, for the protection and preservation of the property related to the contract that is in the possession of the Contractor and in which the Department has or may acquire an interest.

## Section 109. MEASUREMENT AND PAYMENT

**109.01. Measurement of Quantities.** The Engineer will measure quantities of work completed under the contract according to United States standard measures, unless required otherwise.

The Engineer will determine quantities of materials furnished and of work performed under the contract by methods of measurement and computations that are generally recognized as conforming to good engineering practice.

Unless required in the contract, manufacturing tolerances established by the industries involved will be accepted.

When required by the Engineer, the Contractor must file copies of paid freight bills, trucking slips, bills of lading, and paid invoices for any material used in the work. It is the expectation of the Department that the Contractor and the Engineer will routinely review quantities during the life of the project.

**A. Payments Based on Plan Quantities.** If the contract requires payment of an item or part of an item on a plan quantity basis, the payments will be those quantities shown on the plans. Any changes to the quantities will result from an authorized revision to the plans.

For earthwork, the basis for changes in quantities will include any of the following:

1. Changes in original ground topography after the original survey was made;
2. Any demonstrated errors discovered in plan quantities; or
3. Any changes required by the Engineer during construction, such as grade changes, changing of cut or fill slopes, and for excavation of peat, muck, marl, and underlying very soft clay.

If a Contractor believes that a payment based on a plan quantity basis is incorrect, the Contractor may request, in writing, that the Department check the identified quantity. The request must be accompanied by the Contractor's calculations, drawings, or other evidence indicating why the plan quantity is believed to be in error. If the plan quantity is in error, the Department will pay according to the corrected plan quantity, except as otherwise provided in subsection [103.02](#).

If the Department believes that the plan quantity is inaccurate, the Department may check the plan quantity. If the quantity is in error, the Department will pay according to the corrected plan quantity. If during construction, the Department finds that conditions have changed from those anticipated in design to the extent that actual measurement of a plan quantity item is warranted, the Department will measure the quantity and will base payment on the measured quantity.

**B. Payments Based on Actual Quantities.** Unless specified otherwise, the basis of payment for a pay item will be the actual quantity. The Engineer will measure and calculate the actual quantity of work performed, using quantities from measurements taken from the work complete and in-place or from measurements taken from delivery vehicles in accordance with the "Measurement and Payment" subsection for the relevant pay item.

The Engineer will measure the actual quantity of pay items using the following methods:

1. **Linear and Area Measurements.** A station, when used as a definition or term of measurement, will be 100 feet.

When the method of measurement specifies measurements in stations, miles or acres, the measurements will be horizontal measurements, unless specified otherwise.

When the method of measurement for a particular item specifies that it will be measured in place, linear or area measurements will be taken at the surface of the completed item, parallel to the base.

2. **Volume and Weight Measurements.** All materials specified to be measured as compacted-in-place (CIP) will be measured in the field according to the subsection that applies to that material.

All materials specified to be measured by the cubic yard, loose measure (LM) will be measured in the hauling vehicle at the point of delivery, unless specified otherwise. The Engineer's approval is required for all vehicles used for this purpose. The shape of the hauling unit must be such that the volume of the unit may be readily and accurately determined.

When material is measured by weight in tons, the unit is 2,000 pounds.

- a. **Aggregates.** The Engineer will make moisture determinations on aggregates on the dry basis using Formula 109-1.

$$Z = \frac{(X - Y) \times 100}{Y} \quad \text{Formula 109-1}$$

where:

- $X$  = Wet weight,  
 $Y$  = Dry weight, and  
 $Z$  = Percent moisture.

Measurement of pay quantities of aggregates on a ton basis where a maximum specified amount of moisture is allowed will be calculated as follows:

- i. Where the actual moisture, including liquid admixtures, present at time of weighing does not exceed the maximum moisture content permitted, the actual scale weights will be used as pay quantities.
- ii. Where the actual moisture present at time of weighing is more than the maximum moisture content permitted, the pay quantities will be calculated using Formula 109-2.

$$A = B \frac{100 + C}{100 + D} \quad \text{Formula 109-2}$$

where:

- $A$  = Pay quantity of aggregate (tons),  
 $B$  = Weight of wet aggregate (tons),  
 $C$  = Allowable moisture (percent), and  
 $D$  = Actual moisture (percent).

- b. **Asphaltic Materials.** The Engineer will measure asphaltic materials for payment in gallons of material at 60 °F. Material measured at temperatures other than 60 °F will be corrected to volumes at 60 °F by means of the Formula 109-3 for the calculation of volume at 60 °F from volume at observed temperature or by use of ASTM D 1250.

$$V = \frac{V_1}{[K(T - 60) + 1]} \quad \text{Formula 109-3}$$

where:

$V$  = Volume at 60 °F,

$V_1$  = Volume at observed temperature,

$T$  = Observed temperature in °F, and

$K$  = Coefficient of expansion of HMA material from Table 109-1.

| <b>Table 109-1<br/>Coefficients of Expansion to Be Used in Making Volume<br/>Corrections</b> |                                  |                        |
|--|----------------------------------|------------------------|
| <b>Material</b>  | <b>Specific Gravity 60/60 °F</b> | <b>Coefficient (K)</b> |
| Asphaltic Products   | 0.850 – 0.966                    | 0.00040                |
| Asphaltic Products   | >0.966                           | 0.00035                |

If the Contractor furnishes asphaltic material in tank cars, the number of gallons will be determined by the Department's laboratory and this information will be supplied on the laboratory reports.

If the Contractor furnishes asphaltic material from bulk plants or from partly used tank cars, the number of gallons will be calculated by weighing each load and converting to volume in gallons at 60 °F. This measurement will be based on the weight per gallon at 60 °F as recorded on the laboratory test report for the particular material involved. If the units are equipped with a plate or chart showing the calibration of the tank equating depth to gallons, the number of gallons may be measured by the depth of the liquid in the hauling units or distributor. The plate or chart must be provided by the manufacturer or certified by a responsible testing agency. It must also be mounted in a conspicuous location on the tank and show the calibration of the tank, equating inches of depth to gallons. When the quantity is computed by weight and converted to gallons, the calculation will be based on Formula 109-4.

$$G = \frac{W}{S.G.(8.328)} \quad \text{Formula 109-4}$$

where:

$G$  = Volume in gallons at 60 °F,

$W$  = Weight of asphaltic material in pounds, and  
 $S.G.$  = Specific gravity of asphaltic material at 60 °F.

3. **Measuring Wire and Steel Sheets and Plates.** The size of wire for electrical conductors will be measured according to ASTM B 258.

When the term gage refers to the measurement of steel wire, it will mean the wire gage specified in ASTM A 510.

The term gage, when used concerning the measurement of steel sheets and light plates, will mean the gage referenced in ASTM A 568 for uncoated sheet and in ASTM A 525 for a galvanized sheet.

4. **Measuring Depth of Reinforcement and Thickness of Concrete Pavement and Concrete Base Course.** The Engineer will core concrete pavements and concrete base courses to determine thickness of concrete. The Department will determine the depth of reinforcement in accordance with section [602](#) and [MTM 201](#).
5. **Measuring Thickness of Miscellaneous Concrete Construction.** The Engineer may core to verify the thickness of concrete construction for other than pavement or structural concrete when evidence shows the thickness is not within the tolerances of the contract. The Engineer may core concrete construction on any portion or all of the work involved. Concrete pours 6 inches or more in thickness and more than 300 square yards in area will be cored according to [MTM 201](#) and price adjustments will be as specified in subsection [602.04](#). The thickness of concrete pours suspected as deficient, but less than 6 inches thick or less than 300 square yards, will be determined by suitable methods, and deficiencies treated according to subsection [104.04](#).
6. **Measuring Weight on Scales.** Platform, belt conveyor, and surge bin scales must conform to the requirements of 1964 PA 283 Weights and Measures Act.

When a printout system is employed on a platform or a surge bin scale, it must be equipped with a printer that will print and identify all of the following information on a triplicate ticket for each truckload:

- a. Project number;
- b. Contractor's name;

- c. Type of material being weighed;
- d. Time;
- e. Date;
- f. Sequential, non-duplicate, ticket number (may be preprinted on a ticket);
- g. Gross weight;
- h. Tare weight;
- i. Net weight; and
- j. Net accumulated jobs daily total.

The information must be labeled so that each ticket can be readily understood. The system must be interlocked to allow printing only when the scale has come to a complete rest.

**109.02. Scope of Payment.** The Department will pay the Contractor for accepted quantities of contract pay items at the contract unit prices, as required by the contract, except as otherwise specified in subsection [103.02](#).

The Contractor must agree to accept this compensation as full payment for the following:

- A. Providing the necessary materials, labor, tools, equipment, and incidentals to perform and complete the work as required by the contract; and
- B. Compensation for loss or damage arising from the nature of the work or from the action of the elements (except as specified in subsection [107.11](#)), or from any unforeseen difficulties that may be encountered during the prosecution of the work.

**109.03. Payments for Increased or Decreased Quantities.** Whenever the quantity of any item of work as given in the contract is increased or decreased, payment for the item of work will be based on the quantity completed. The payment will be authorized at the unit price for the item named in the contract, except as otherwise provided in subsection [103.02](#).

**109.04. Progress and Partial Payments.** The Engineer will make progress payments for units of work completed and partial payments for fabricated or processed nonperishable materials delivered for use on the project. Payments will be made in a timely manner, however, no claim will be considered for delayed payment of estimates.

**A. Completed Work.** The Engineer will make progress payments based upon estimates prepared by the Engineer of the work items

completed. The estimates are subject to final payment in accordance with subsection [109.07](#). Progress payments will be made biweekly if all of the following occur:

1. The work is progressing according to the progress schedule;
2. The written orders of the Engineer have been or are being fulfilled;
3. The time for completion must not have elapsed; and
4. At least one-half the contract amount or \$1,000 has been earned during the estimate period.

The final payment will be made according to the requirements specified under subsection [109.07](#).

**B. Delivered and Stockpiled Materials.** The Engineer may pay the cost of nonperishable materials that meet the contract requirements and are produced, fabricated, or purchased for incorporation into the contract, including freight charges, when all of the following conditions are met:

1. The value of the delivered material to be used in one item of work, exceeds \$3,000 and is not scheduled to be incorporated into the work within 30 days after delivery;
2. The Contractor presents a copy of the proof of payment, authenticated by the supplier, to the Engineer. However, if the prime Contractor is the supplier, producer, or fabricator, the Engineer will base the payment on proven production cost; and
3. The Contractor stores or stockpiles the materials on the project or at locations near the project, approved by the Engineer.

For materials stockpiled at locations not included in subsection [109.04.B.3](#), for which partial payments are to be made, the materials must have been approved by the Department for shipment or for use.

The Engineer will base the payment for delivered or stockpiled materials on amounts paid by the Contractor for the materials. However, the Engineer will withhold a portion of the contract unit price to cover completion of the work in accordance with current Department procedures. The Engineer will not make payment for materials in excess of contract quantities. When the Engineer makes partial payment for materials, the Contractor must reserve the materials for use on the project. The Contractor is responsible for any loss or damage to the materials until the materials are incorporated in the work and the work is accepted.



The Contractor assumes the cost of any additional testing required by partial payment for stockpiling.

The Engineer's approval of partial payment for delivered or stockpiled materials will not constitute final acceptance of such materials for use in completing items of work.

When the Contractor provides receipted bills, paid invoices, or other satisfactory evidence of payment by the fabricator for structural steel that is to be a part of the completed structure and that has been produced by the steel mill and delivered to the fabricator, the Engineer will include the value of the steel in the progress estimate. Detailed descriptions of the delivered material, including weights, dimensions, heat and unit numbers, and chemical and physical test reports, must be shown on the invoice or supplied to the Engineer. The fabricator must store the material separately and use the material only for fabricating the structural steel for this project.

The Contractor must present evidence that the producer, fabricator, or supplier of the material is fully aware of all details of the transaction.

The Contractor must immediately pay the fabricator for those materials upon receipt of payment by the Department.

If the fabricator notifies the Department that payment for materials paid for by the Department has not been received, and the fabricator's claim remains unsatisfied for more than 30 days following the Department's payment to the Contractor, the amount provided for payment to the fabricator will be deducted from the next progress estimate.

#### **109.05. Payment for Contract Revisions.**

A. **General.** The Department will pay for contract revisions, excluding those resulting from increased or decreased quantities of pay items covered by subsection [109.03](#), using the sequence specified in subsection [109.05.B](#) through subsection [109.05.F](#). This payment covers all costs for performing the revised work, delay costs, and all other associated costs the Engineer deems reasonable and not expressly precluded in subsection [109.05.G](#). The Department may direct the Contractor, at anytime, to perform the revised work under force account.

If a contract revision includes an extension of time for compensable delays under subsections [108.09.B.1](#) through [108.09.B.4](#) the Department will pay for delay costs in accordance with subsection [109.05.E](#)

If a contract revision includes direction to the Contractor to accelerate the work in accordance with subsection [104.01.C](#), the Department will pay for the directed acceleration in accordance with subsection [109.05.F](#).

**B. Contract Unit Prices.** The Engineer will attempt to price revised work using contract unit prices. If the Engineer and the Contractor do not agree on the use of contract unit prices, the Engineer will negotiate with the Contractor in accordance with subsection [109.05.C](#).

**C. Negotiated Prices.** The Engineer and the Contractor will negotiate the price of a contract revision if the Engineer and the Contractor cannot agree on a price using contract unit prices in accordance with subsection [109.05.B](#).

The Contractor must provide an estimate of the proposed unit prices or lump sum price for the contract revision that includes the cost of performing the revised work, delay costs, all other associated costs, plus a reasonable allowance for profit and applicable overhead. The Engineer may request that the Contractor justify the estimate by providing one or more of the following used in deriving the estimate:

1. Contractor's labor requirements by trade in hours for each task;
2. Contractor's equipment costs and time requirements; or
3. Contractor's material and specialty subcontractor costs.

The Contractor must provide the justification within 5 calendar days after the Department's request. The Department will respond to the estimate within 5 calendar days after receipt of the Contractor's justification. The Department and the Contractor can mutually agree to extend these 5-day requirements.

If the Department negotiates with the Contractor but does not agree on compensation, the Engineer may direct the Contractor to perform the revised work in accordance with subsection [109.05.D](#).

**D. Force Account.**

1. **General.** If the parties are unable to reach agreement using contract unit prices or negotiated prices, the Engineer may direct the

Contractor to perform the revised work, including any required offsite work, under force account. The Contractor must submit a written proposal for the directed work, including the planned equipment, materials, labor, and schedule.

The Department will pay the Contractor for the directed work as specified in this subsection. The Contractor must accept the compensation provided in this subsection as full payment for the directed work. At the end of each workday, the Contractor's representative and the Engineer will compare records of the work done under force account.

2. **Work Plan.** Before starting the force account work, the Contractor and the Engineer will work together to develop a work plan from the Contractor's written proposal. The work plan must include, to the extent possible, a progress schedule of controlling items and their duration, equipment to be used (Contractor owned and rented), labor to be used (number of people and crafts), and a listing of material. From the work plan, the Engineer will prepare a budget recommendation for the force account work. If the conditions relative to the force account change or if the progress of the work becomes inconsistent with the original work plan, the Contractor and the Engineer will jointly revise the work plan.
3. **Labor.** The Engineer will pay the Contractor an amount equal to the sum of the following labor costs, plus 35 percent of the sum to cover the costs of field and home office overhead and to provide for a reasonable profit.

For foreman and laborers, the Contractor will receive the rate of wage (or scale) that was agreed to in writing before beginning work. This rate will be paid for the time that the foreman and laborers are engaged in the work. This will include hours required by a collective bargaining agreement or other employment contract applicable to the class of labor employed on the work, exclusive of time included in the "estimated operating costs."

The Contractor will receive the amount paid to, or on behalf of, workers for vacation benefits, health and welfare benefits, pension fund benefits, or other benefits when the amounts are required by a collective bargaining agreement or other employment contract generally applicable to the classes of labor employed on the work.

For the superintendent, the amount the Contractor will receive will be limited to the work hours in which the superintendent is engaged in the performance of the work done under force account.

4. **Bond Premium, Insurance, and Payroll Taxes.** Bond premium, workmen's compensation insurance, personal injury public liability and property damage public liability insurance, unemployment compensation, and federal social security levied against the Contractor will be paid at cost. The Contractor must furnish satisfactory evidence of the amounts paid for each of these required costs as related to force account work. An amount equal to 11 percent will be added to each of these costs.
5. **Materials.** For materials used and accepted by the Engineer, the Contractor will receive the cost of materials delivered, including tax and transportation charges, plus 15 percent.

If a change in the amount, or a change in the type of force account work, results in a surplus of the material ordered and delivered to the project site, the Department will reimburse the Contractor for the costs, including restocking charges, incurred in returning the surplus material to the supplier.

Discount for prompt payment or penalty for late payment will not be considered in determining the cost of materials charged to the force account work.

6. **Equipment and Plant.** The Contractor will be paid according to the following for any equipment or special equipment other than small hand or power tools, the use of which is approved by the Engineer. Exclusive of costs for the operator, the department calculates the base hourly rate for a piece of equipment by adding two distinct components - a rental rate and an operating rate. The Department defines each of these terms as follows:

**Rental Rate.** Includes depreciation, taxes, major overhaul and repairs, overhead, interest, regional adjustment, equipment age adjustment, insurance, and storage.

**Operating Rate.** Includes fuel, lubricants, labor service and maintenance, field repairs, tires, and other expendable items needed for continuous and efficient operation.

**Base Hourly Rate.** The sum of a piece of equipment's rental and operating rates.

Base hourly rate also includes the cost of supplies, attachments not listed separately in the *Rental Rate Blue Book for Construction Equipment*, Volume 1, 2, or 3, by Equipment Watch, Inc. (Blue Book), field and home office overhead, profit and incidentals, insurance covering the usual insurable risks, including fire and theft. The Department will not be liable for losses that can be covered by insurance.

Upon request, the Contractor must furnish to the Engineer either original bills and invoices or certification documenting the equipment's original invoice price plus improvements. Payment for equipment will not exceed the equipment's original invoice cost plus any documented improvements. Cumulative payment for multiple force accounts for any piece of equipment on a single contract will not exceed the equipment's original invoice cost plus any documented improvements.

Time elapsed while equipment is broken down and being repaired will not be considered for payment. Time elapsed after the Engineer has advised the Contractor in writing that the equipment is no longer needed to complete the force account work will not be considered for payment except for transportation costs.

- a. **Contractor-Owned Equipment.** This subsection applies to the equipment and plant owned directly by the Contractor or by entities that are divisions, affiliates, subsidiaries, or in any other way related to the Contractor or parent company.
  - i. **Equipment Listed in Blue Book.** The published monthly rental rate for each piece of Contractor-owned equipment used, including appurtenances and attachments to equipment, will be determined by using the Blue Book. The edition that is current at the time the force account work is started will apply. The rental rate will be equal to the published monthly rental rate divided by 176, modified by the rate adjustment factor and the applicable map adjustment factor. The operating rate will be equal to the published estimated operating costs per hour.

- ii. **Equipment Not Listed in Blue Book.** The monthly rental rate will be determined by using the published monthly rental rate listed for a similar piece of equipment giving proper consideration to the capacity, size, horsepower, and age of the equipment. The rental rate will then be determined by dividing the published monthly rental rate by 176, modified by the rate adjustment factor and the applicable map adjustment factor. The operating rate will be equal to the published estimated operating costs per hour. Rates must be agreed upon in writing before the equipment is used.

For equipment for which there is no comparable in the Blue Book, The Contractor will provide the monthly rental rate and operating rate and furnish cost data to support these rates. The monthly rental rate must be reasonable but not more than 5 percent of the invoiced cost of the equipment. The rental rate will be determined by dividing the monthly rental rate by 176. Rates must be agreed upon in writing before the equipment is used.

- iii. **Small Tools.** No payment will be allowed for small hand and power tools that are not listed in the Blue Book. Small hand and power tools listed in the Blue Book at a rate of less than \$1.00 per hour will not be paid for separately.
- iv. **Foreman's Transportation.** The rate for the foreman's transportation unit will be \$25.00 per hour.
- v. **Minimum Equipment Time.** The minimum time per day for equipment used productively in force account work will be two hours.
- vi. **Equipment Transportation.** Travel time to the location of the force account work will be included when the equipment is moved under its own power. When equipment is moved from one site to another by means other than its own power, the actual operating time during periods of loading and unloading equipment will be paid for at the established base hourly rate and transportation costs will be allowed.

Transportation charges for each piece of equipment to and from the work site will be paid provided:

- Equipment is obtained from the nearest available source;
- Return charges do not exceed the delivery charges; and
- Charges are restricted to those units of equipment not already available and not on or near the project.

- b. **Non-Contractor-Owned Equipment.** If the Contractor is required to rent a specific type of equipment, the Contractor must inform the Engineer of the need to rent the equipment and provide a written estimate from the rental agency for that equipment before using it on the work site. The Contractor will be paid the actual rental cost plus the operating rate for the time that the equipment is used to accomplish the work, plus the cost of moving the equipment onto and away from the job. The Contractor must provide a copy of invoices for all rental expenses incurred.
- c. **Standby Rate and Allowable Hours.** For Contractor-owned equipment, the standby rate will be one-half the rental rate established in subsection [109.05.D.6.a](#). The standby rate will only be allowed if the Engineer specifically requires the equipment to remain on the site for later use on the force account work.

The Engineer will provide written notice when the equipment is no longer needed to complete the force account work and will not be considered for payment, except for transportation costs.

Payments for standby time will not be made on any day the equipment operates for eight or more hours. For equipment accumulating less than eight hours operating time on any normal work day, standby payment will be limited to only that number of hours that, when added to the operating time for that day, equals eight hours.

7. **Subcontracting or Hiring Services by Others.** For administration costs in connection with subcontract work or hiring services by others to perform specialized type of work that the Contractor is not qualified to do, the Contractor will receive an amount equal to five percent of the total cost of the work computed as set forth above. Prior approval by the Engineer is required.

8. **Business Taxes.** The Contractor will receive an amount equal to 3.5 percent of the total force account to compensate the Contractor for business taxes.
9. **Miscellaneous.** No additional allowance will be made for general superintendence or other costs for which no specific allowance is provided.
10. **Coordination of Records.** The Contractor's representative and the Engineer will compare records for work completed on a force account basis and bring these records into agreement at least once a week.
11. **Statements.** Payment will be made for work performed on a force account basis after the Contractor has furnished the Engineer with an itemized statement of the cost of the work. The percentage added to each of the following categories is compensation for expenses not specifically designated.

The Contractor must use a standard MDOT form or approved equal that includes the following details for reporting all force account costs.

- a. **For Each Employee.** Name, classification, dates worked, time worked each day, total time worked on the force account activity, hourly rate of pay, total wages and fringe benefits, and total earnings to date.
- b. **For Each Unit of Equipment Used.** Description, dates used, number of hours operated each day, standby hours, total hours, rental and operating rates, and total cost.
- c. **For Materials Used.** Total quantities of materials used and material costs, including transportation. Statements must be supported by invoices for all materials used and transportation charges.

If materials used on the force account work are not specifically purchased for the work but are taken from the Contractor's stock, the Contractor must give the Engineer an affidavit certifying the following:



- i. The materials were taken from stock;
- ii. The quantity claimed was used; and
- iii. The costs including transportation represent the actual Contractor's cost.

#### E. Delay Costs.

1. **General.** If the Contractor incurs a delay attributable to the Department, the Department will pay for the costs specified in this section as allowed by subsection [108.09.B](#), unless these costs have been previously paid as allowed in subsection [109.05.D](#). Such payment constitutes full compensation for the delay costs.

The Department will make no payment for delays occurring during the period from November 15 to April 15 unless the Contractor's approved progress schedule depicts work on the controlling operation during this period.

The Department will not pay for delay costs until the Contractor submits an itemized statement of those costs. Provide the content specified in subsection [109.05.D.10](#), for the applicable items in this statement and as follows:

- a. Proof of cost of Superintendent, or other project staff salaries, wages, and payroll taxes and insurance;
  - b. Proof of cost of office rent, utilities, land rent, and office supplies;
  - c. Proof of escalated cost for labor, equipment, and material;
  - d. Proof of material storage costs; and
  - e. Proof of other increased project costs.
2. **Allowable Delay Costs.** Increases in cost for labor, equipment, and materials will be calculated as follows:
    - a. **Idle Labor.** Labor costs during delays must be calculated as specified in subsection [109.05.D.3](#) for all non-salaried personnel remaining on the project as required under collective bargaining agreements or for other Engineer-approved reasons.
    - b. **Escalated Labor.** For delays caused by conditions set forth in subsection [108.09.B](#), payments authorized for increases in labor costs will be based on the difference between old and new labor rates established by a State or Federal agency or an agreement between the employee's and the Contractor's bargaining agency which is accepted by the Department. Payment will be based on

certified payrolls. Payment will also include the increases in fringe benefit rates and increases in payroll taxes that the Contractor is required to pay.

- c. **Idle Equipment.** For delays caused by conditions set forth in subsection [108.09.B](#), payment may be allowed on a rental basis for the idled equipment if any one of the following criteria is met:
- i. The equipment is on the project site at the time of the delay, is required for the controlling operation, and cannot be used at other locations on the project.
  - ii. The equipment is specialized and directly related to the controlling operation, whether on or off the project site. This must be certified by the Contractor and verified by the Engineer.

The rental rate for idled leased or rented equipment will be the leased or rented rate. However, the Engineer may direct the Contractor to return equipment and take it off rental.

The rental rate for idled Contractor-owned equipment will be one-half the rate established in subsection [109.05.D.6.a](#). No payment will be allowed for operating costs.

Payment will be limited to the difference between the hours used and 8 hours in any one day and to the difference between the hours used and 40 hours in any one week. No additional compensation for overhead will be allowed.

Equipment demobilization and remobilization, if directed by the Engineer, will be paid in accordance with subsection [109.05](#).

- d. **Material Escalation or Material Storage.** For delays caused by the conditions listed in subsection [108.09.B](#), payment for increased cost of materials will be based on differences in the invoice costs before and after the delay period. When requesting an increase in cost of materials, the Contractor must document the increased costs due to the delay. The cost of materials storage during the delay will be the invoiced storage cost.

F. **Directed Acceleration.** If the Engineer orders the Contractor to accelerate the Work in accordance with subsection [104.01.C](#), prior to accelerating the work, the Engineer and the Contractor will negotiate

compensation to the Contractor for the costs to accelerate the work. In the absence of agreed upon compensation, the Department will compensate the Contractor for performance of the accelerated work in accordance with subsection [109.05.D](#).

**G. Unrecoverable Costs.** The Contractor is not entitled to compensation for costs not specifically allowed or provided for in this subsection including, but not limited to, the following:

1. Loss of anticipated profit.
2. Consequential damages, including loss of bonding capacity, loss of bidding opportunities, insolvency, and the effects of force account work on other projects, or business interruption.
3. Indirect costs.
4. Attorneys fees, claim preparation expenses, and the costs of litigation.
5. Unabsorbed or extended field or home office overhead or any damages using an Eichleay or similar equation, except as otherwise provided in the mark ups specified in subsections [109.05.D.1](#) through [109.05.D.7](#).

**109.06. Source of Supply and Carrier Rates on Materials.** The following do not constitute cause for claim for extra compensation:

- A. The inability to secure satisfactory materials, for reasons beyond the Contractor's control, from the source upon which the bid was based, unless project specific single source suppliers are specified by the Department; or
- B. Changes in carrier rates or the alteration of transportation facilities for these materials during the life of the contract.

**109.07. Final Inspection, Acceptance, and Final Payment.**

**A. Partial Acceptance.** Upon completion of a portion of the work, the Contractor may request, in writing, partial acceptance of that portion of the work. Within 7 days of the Contractor's written request, the Engineer will conduct an inspection to determine if the Contractor has satisfactorily completed that portion of the work in accordance with the contract. Within 7 days of the inspection, the Engineer will provide written notice of either partial acceptance for that portion of the work, or an explanation for rejecting the Contractor's request for partial acceptance. If the Engineer grants the partial acceptance, the Engineer will designate in writing what portion of the work is partially accepted and the effective date of the partial acceptance.

Partial acceptance will relieve the Contractor of maintenance responsibility and third party damage liability for the designated portion of the work. By relieving the Contractor of maintenance and third party damage claims, the Department does not relieve the Contractor of responsibility for defective work or damages caused by the Contractor's operations. The Contractor must not construe partial acceptance to be final inspection, final acceptance of any part of the work, or waiver of any legal rights specified under section [107](#).

**B. Delayed Acceptance.** Upon completion of contract work items designated for delayed acceptance, the Contractor must notify the Engineer, in writing, of the completion of the designated work. Within 7 days of the Contractor's written request, the Engineer will conduct an inspection to determine if the Contractor has satisfactorily completed the designated portion of the work in accordance with the contract. Within 7 days of the inspection, the Engineer will notify the Contractor, in writing, of the date the delayed acceptance period begins.

Delayed acceptance will relieve the Contractor of maintenance responsibility and third party damage liability for the designated portion of the work. By relieving the Contractor of maintenance and third party damage claims, the Department does not relieve the Contractor of responsibility for defective work or damages caused by the Contractor's operations. The Contractor must not construe delayed acceptance to be final inspection, final acceptance of any part of the work, or waiver of any legal rights specified under section [107](#).

**C. Final Inspection and Final Acceptance.**

1. **Final Inspection.** The Engineer will conduct the final inspection within 7 days of receiving the Contractor's written notification that the work is completed. The Contractor must attend the final inspection.

Within 7 days of the final inspection, the Engineer will provide written notice to the Contractor of a satisfactory final inspection or will provide a list of specific defects to be remedied in order to achieve a satisfactory final inspection.

After achieving satisfactory final inspection, the Contractor is relieved of the duty of maintaining and protecting the project. In addition, the Contractor is relieved of its responsibility for third party damage claims, and for damage to the work that may occur after satisfactory final inspection.

2. **Final Acceptance.** Within 7 days of satisfactory final inspection and submission of all required project and materials testing documentation by the Contractor, the Engineer will give the Contractor written notification of final acceptance effective on the date the Department executes Form 1120, [Final Inspection/Acceptance and Certification Report](#).

The Contractor, without prejudice to the terms of the contract, is liable to the Department at any time, both before and after final acceptance, for latent defects, fraud, such gross mistakes as may amount to fraud, or actions affecting the Department's rights under any warranty or guarantee.

D. **Final Payment.** Within 30 calendar days after final acceptance, the Engineer will prepare a final estimate of work performed. The Contractor will have 30 calendar days of issuance of the final estimate to file a claim or objections to the quantities within the final estimate. If no claim or objections are filed within 30 calendar days, the Department will process the final estimate for approval and final payment. At that time, the Contractor will be furnished a copy of the approved final estimate.

1. The final payment will be made when the Contractor has provided the following:
  - a. All reports or documents required by the Department and the Federal Highway Administration;
  - b. The consent of the Surety for payment of the final estimate; and
  - c. Satisfactory evidence by affidavit, or other means, that all the indebtedness due to the contract has been fully paid or satisfactorily secured. If the evidence is not furnished, the Department may retain out of any amount due the Contractor sufficient sums to cover all lienable claims unpaid.
2. The Department can recover from the Contractor in the final estimate all overpayments. However, no recovery for overpayment will be made if both of the following conditions exist:
  - a. The final estimate is issued more than 6 months after the acceptance of the project; and
  - b. The overpayment was paid to a subcontractor not in existence at the time of the final estimate.

## Section 150. MOBILIZATION

**150.01. Description.** This work consists of preparatory work and operations including, but not limited to, the following:

- A. The movement of personnel, equipment, supplies, and incidentals to the project site;
- B. The establishment of the Contractor's offices, buildings, and other facilities to support work on the project including associated job site posters;
- C. Other work and operations the Contractor must perform;
- D. Expenses incurred, before beginning work on pay items at the project site; and
- E. Pre-construction costs, exclusive of bidding costs, that are necessary direct costs to the project rather than directly attributable to other pay items under the contract.

**150.02. Materials.** None specified.

**150.03. Construction.** None specified.

**150.04. Measurement and Payment.**

| <b>Pay Item</b>            | <b>Pay Unit</b> |
|----------------------------|-----------------|
| Mobilization, Max __ ..... | Lump Sum        |

The Department will specify the maximum bid amount for **Mobilization, Max \_\_** in the proposal. If the Contractor submits a bid amount for **Mobilization, Max \_\_** that exceeds the maximum bid amount, the Department will use the maximum bid amount as the Contractor's lump sum bid amount and will correct the total bid amount to reflect this maximum bid amount.

The Department will pay the Contractor for **Mobilization, Max \_\_** in accordance with Table 150-1. The percent of the original contract amount earned is exclusive of the **Mobilization, Max \_\_** pay item.

| <b>Table 150-1<br/>Partial Payment Schedule for Mobilization</b> |  |
|--|--|
| <b>Percent of Original<br/>Contract Amount Earned</b>            | <b>Percent of Bid Amount<br/>for Mobilization, Max ___</b> |
| 5  | 50   |
| 10   | 75   |
| 25   | 100  |

When the percentage of the original contract amount earned is less than 5% on the partial payment schedule, the Department will pay the Contractor for costs of project specific bonding, insurances, and permits when proof of payment is received and accepted by the Engineer. The Engineer will then subtract these costs from the bid amount for **Mobilization, Max \_\_\_**.

The total sum of all payments for this item will not exceed the bid amount for **Mobilization, Max \_\_\_**, regardless of the following conditions:

- A. The Contractor shut down the work on the project for any reason;
- B. The Contractor moved equipment away from the project and then back again; or
- C. The Department added additional quantities or items of work to the contract.

If the contract does not contain a **Mobilization, Max \_\_\_** pay item, the unit prices for other items of work will include the costs of mobilization.

## DIVISION 2 – EARTHWORK

| <b>Section</b> | <b>Title</b>   | <b>Page No.</b>     |
|----------------|--|---------------------|
| 201            | Clearing .....   | <a href="#">111</a> |
| 202            | Removing Trees, Stumps, and Corduroy .....               | <a href="#">115</a> |
| 203            | Removing Drainage Structures, Culverts, and Sewers ..... | <a href="#">117</a> |
| 204            | Removing Miscellaneous Structures and Materials.....     | <a href="#">120</a> |
| 205            | Roadway Earthwork .....                                  | <a href="#">127</a> |
| 206            | Excavation and Backfill for Structures .....             | <a href="#">145</a> |
| 207            | Obliterating Roadway .....                               | <a href="#">149</a> |
| 208            | Soil Erosion and Sedimentation Control .....             | <a href="#">150</a> |
| 209            | Project Cleanup .....                                    | <a href="#">158</a> |



## NOTES

## Section 201. CLEARING

**201.01. Description.** This work consists of clearing, selectively thinning, clearing for fence, and applying growth preventive material if required.

**201.02. Materials.** Provide growth preventive material that is Pathfinder II, or a Department-approved equal. Ensure a certified applicator applies the preventive material.

### 201.03. Construction.

**A. Clearing.** Cut, remove, and dispose of trees, stumps, brush, shrubs, roots, logs, and other vegetation. Salvage marketable timber. Preserve vegetation and objects required to remain from injury or defacement.

1. **Removals.** Remove trees, stumps and other vegetation to 10 feet outside the limits of earth disturbance or to the right-of-way line, whichever is less. In other areas, remove trees, stumps, and other vegetation as shown on the plans. Remove trees without endangering traffic and the general public, injuring other trees, and damaging structures or property.

In peat treatment areas, remove trees, stumps, and other vegetation to the outer limits of the peat excavation. Between outer peat excavation limits and outer clearing limits, cut off vegetation to no greater than 6 inches above the ground. The Engineer will not require removal of stumps and roots beyond the peat excavation limits. If the Engineer approves, stumps may be buried with at least 2 feet of cover in peat disposal areas outside the limits of sound fill.

2. **Protecting Plant Life.** Protect vegetation that is not designated for removal on the plans or by the Engineer. Repair or replace trees or shrubs damaged by Contractor operations at no additional cost to the Department.
3. **Salvaging Marketable Timber.** The Engineer will not allow burning or wasting of marketable timber. Marketable timber includes trees, with a diameter of at least 6 inches as measured at a point 4½ feet above the base of the tree at the ground line. Timber does not need to be cut in lengths less than 8 feet.

Salvage marketable timber in accordance with the following:

- a. **Right-of-Way Purchased in Fee Simple.** On right-of-way purchased in fee simple, the Department considers marketable timber the property of the Contractor. Make marketable timber available to wood-using industries or individuals.

- b. **Right-of-Way Easements.** On right-of-way easements, the Department considers marketable timber the property of the landowner. Unless otherwise shown on the plans, cut and pile marketable timber outside the right-of-way on property owned by the abutting property owner.

Provide the Engineer with the property owner's written direction for the disposal of the marketable timber. Take ownership of marketable timber not wanted by the property owner and make available to wood-using industries or individuals.

On easements or special use permits on land owned by the USDA Forest Service or MDNRE, marketable timber is the property of the Forest Service or MDNRE. Cut and dispose of this timber as agreed by the Department and the Forest Service or MDNRE. The Forest Service may sell, or otherwise dispose of standing marketable timber to others if its removal does not unduly interfere with Contractor operations.

- 4. **Disposing of Unsalvageable Material.** Do not dispose of material, temporarily or permanently, in wetlands or flood plains. Dispose of unmarketable timber and vegetative debris resulting from clearing and selective thinning, in accordance with subsection [205.03.P](#), and one of the following methods:
  - a. **Chipping.** Dispose of chips outside the right-of-way unless otherwise approved by the Engineer.
  - b. **Burning.** Obtain burning permits. Burn only trees, logs, brush, or stumps within the right-of-way in accordance with subsection [107.15.A.3](#). Do not use tires, heavy distillates, or plastics as kindling agents. Dispose of remaining material outside the right-of-way or in other Engineer-approved areas.
  - c. **Other.** Dispose of material outside the right-of-way or in Engineer-approved areas within the right-of-way.

**B. Selective Thinning.** Remove and dispose of undesirable trees, stumps, undergrowth, and debris outside areas designated for clearing. Treat stumps and stubs with a growth preventive material if required.

Protect plant life in accordance with subsection [201.03.A.2](#).

Dispose of materials in accordance with subsection [201.03.A.4](#).

The plans will show, or the Engineer will direct, trees and areas of undergrowth for removal by selective thinning. The Engineer will not

consider this work complete until the Engineer's acceptance of the project.

Perform selective thinning in accordance with the following:

1. **Selective Thinning Type I.** Cut off stumps to no greater than 6 inches above the existing ground level and apply a growth preventive material the same day.
  2. **Selective Thinning Type II.** Chip or grind stumps to 4 inches below the proposed ground level.
- C. **Clearing for Fence.** Remove and dispose of trees, brush, stubs, stumps, and other vegetation on the fence line. Treat stumps and stubs with a growth preventive material.

Clear no greater than 8 feet within the right-of-way. Do not clear outside the right-of-way, unless otherwise approved by the Engineer. Clear less than 8 feet where possible. Access fence work locations from other public rights-of-way to avoid or reduce the removal of existing vegetation. The Contractor is responsible for obtaining and providing the Engineer with written approval from the public landowner before accessing "other" public rights-of-way.

Cut trees, brush, shrubs, stumps, and other vegetation flush with the ground level. The Engineer will not require the removal of roots. Do not remove mature trees or bushes if trimming limbs will allow installation of the fence.

Treat stumps and stubs within 1 foot of the fence line with growth preventive material the same day.

Protect plant life in accordance with subsection [201.03.A.2.](#)

Dispose of materials in accordance with subsection [201.03.A.4.](#)

#### **201.04. Measurement and Payment.**

| <b>Pay Item</b>                    | <b>Pay Unit</b> |
|------------------------------------|-----------------|
| Clearing .....                     | Acre            |
| Thinning, Selective, Type __ ..... | Acre            |
| Clearing, Fence .....              | Station         |

A. **Clearing.** The Engineer will measure **Clearing** by horizontal area bounded by the outermost trees cut. The Engineer will establish the perimeter line along the outside faces of the trunks.

The cost of clearing areas up to 10 feet outside the limits of earth disturbance; State provided borrow areas; clear vision areas; or other

areas designated on the plans is included in the unit price for related pay items unless clearing is a separate pay item.

If the Engineer directs clearing, not shown on the plans, beyond 10 feet outside the limits of earth disturbance, in non-state-provided borrow areas, or in clear vision areas, and the contract provides no separate pay item for **Clearing**, the Department will pay for this clearing as extra work.

If the Engineer directs the Contractor to return to perform additional clearing of areas less than ½ acre after the Engineer accepted the clearing of an area, the Department will pay for this clearing as extra work.

**B. Thinning, Selective.** The Engineer will measure **Thinning, Selective**, of the type specified, by horizontal area. The unit price for **Thinning, Selective** includes the cost of providing and applying growth preventive materials, where required.

**C. Clearing, Fence.** The Engineer will measure **Clearing, Fence** along the fence line by length. The Department will not provide additional compensation for handwork. The unit price for **Clearing, Fence** includes the cost of providing and applying growth preventive material, where required.

## Section 202. REMOVING TREES, STUMPS, AND CORDUROY

**202.01. Description.** This work consists of removing trees and stumps with a diameter of at least 6 inches, located outside the clearing limits, and removing corduroy within the limits of the proposed roadbed and backfilling as required.

**202.02. Material.** Provide materials in accordance with the following:

Granular Material Class III..... [902](#)

### 202.03. Construction.

**A. Removing Trees or Stumps.** As required, remove and dispose of trees or stumps outside the clearing limits with a diameter of at least 6 inches. Remove non-ornamental fruit trees within the right-of-way, even if not otherwise shown on the plans. Remove and dispose of trees, stumps, roots, and debris in accordance with section [201](#).

If removing a stump may result in damage to existing utilities, remove the stump by chipping to a depth of at least 12 inches below the finished ground surface. Remove other stumps by chipping only if approved by the Engineer. If required by the Engineer, backfill removal areas with approved material.

**B. Removing Corduroy.** Remove and dispose of logs, poles, stumps, brush, and other material embedded under the surface of an abandoned or existing road, within the limits of the proposed roadbed. Remove corduroy located in the roadbed if within 4 feet of the plan grade. Dispose of corduroy in accordance with section [201](#). Backfill trenches, excavated after the removal of corduroy, with Class III granular material.

### 202.04. Measurement and Payment.

| <b>Pay Item</b>                      | <b>Pay Unit</b> |
|--------------------------------------|-----------------|
| Tree, Rem, __ inch to __ inch .....  | Each            |
| Stump, Rem, __ inch to __ inch ..... | Each            |
| Tree, Rem, 37 inch or Larger .....   | Each            |
| Stump, Rem, 37 inch or Larger .....  | Each            |
| Corduroy, Rem .....                  | Station         |

**A. Trees and Stumps.** The Engineer will determine the size of trees by the diameter of the trunk, measured to the nearest full inch, at a point 4½ feet above the ground line at the base of the tree. The Engineer will measure trees with major limbs, lower than 4½ feet from the ground, at the smallest diameter below the limbs.

The cost of removing trees or stumps with a diameter less than 6 inches is included in other pay items.

Where more than one trunk has grown from a common stump, the Engineer will measure each trunk as a separate tree.

The Engineer will measure stump diameters, to the nearest full inch, at the top of the stump.

For stumps incorrectly shown on the plans as trees designated for removal, the Engineer will measure and the Department will pay for removing stumps with the relevant stump removal pay item. If the contract does not include stump removal pay items, but does include tree removal pay items, the Department will pay for removing stumps with the relevant tree removal pay item.

The unit price for tree and stump removal pay items includes the cost of providing and placing backfill. Tree removal pay items include respective stump removal.

**B. Corduroy, Removal.** The Engineer will measure **Corduroy, Rem** along the road centerline. The unit price for **Corduroy, Rem** includes the cost of backfill. The Department will apply **Corduroy, Rem** if below the excavation limits required for other pay items.

## **Section 203. REMOVING DRAINAGE STRUCTURES, CULVERTS, AND SEWERS**

**203.01. Description.** This work consists of removing, or abandoning, in whole or in part, drainage structures, culverts, and sewers, salvaging, storing, and disposing of removed materials; and backfilling and compacting the excavated sites.

**203.02. Materials.** Provide materials in accordance with the following:

|                                  |                     |
|----------------------------------|---------------------|
| Sound Earth.....                 | <a href="#">205</a> |
| Granular Material Class III..... | <a href="#">902</a> |

### **203.03. Construction.**

**A. Drainage Structures.** When removing or abandoning a drainage structure, rebuild and reconnect live sewers through the removal area. Maintain service of live sewers during construction operations.

If the plans show abandoning a drainage structure, remove the cover and break down the masonry in accordance with subsection [204.03](#). Dispose of materials in accordance with subsection [205.03.P](#), and backfill in accordance with subsection [204.03.C](#).

**B. Culvert Pipe.** Completely remove pipe culverts as required, including end treatments.

For culvert pipes with a top elevation within 5 feet of the top of pavement, and requiring abandonment, review the abandonment treatment with the Engineer.

If the plans show the extension of an existing culvert, or replacement of the existing end treatment, remove only those portions of the existing culvert pipe necessary to allow connection to the new work. Do not damage the remaining culvert pipe.

Bulkhead abandoned pipe culverts in accordance with subsection [402.03.E](#) or use other Department-approved methods. If the Engineer determines that the culvert is not in suitable condition for abandonment, the Engineer will specify alternate treatment.

Dispose of materials in accordance with subsection [205.03.P](#), and backfill in accordance with subsection [204.03.C](#).

**C. Sewer Pipe.** Remove sewers (storm, sanitary, or combined), or parts of sewers, requiring removal or interfering with the new construction.



Where the plans show the extension of existing sewers or the incorporation of existing sewers into the new work, remove only the part of the existing sewer necessary to allow the required connection to the new work. Trim the connecting sewer pipe edges to meet the required lines and grades without weakening or damaging those parts of the remaining sewer.

Bulkhead abandoned sewers in accordance with subsection [402.03.E](#), or use other Department-approved methods. If the Engineer determines that the sewer pipe is not in suitable condition for abandonment, the Engineer will specify alternate treatment.

For sewer pipes with a top elevation within 5 feet of the top of pavement, and requiring abandonment, review the abandonment treatment with the Engineer.

Dispose of materials in accordance with subsection [205.03.P](#), and backfill in accordance with subsection [204.03.C](#).

**203.04. Measurement and Payment.**

| <b>Pay Item</b>                          | <b>Pay Unit</b> |
|--|-----------------|
| Dr Structure, Rem.....                   | Each            |
| Dr Structure, Abandon.....               | Each            |
| Culv, Rem, Less than 24 inch .....       | Each            |
| Culv, Rem, 24 inch to 48 inch .....      | Each            |
| Culv, Rem, Over 48 inch .....            | Each            |
| Culv, End, Rem, Less than 24 inch .....  | Each            |
| Culv, End, Rem, 24 inch to 48 inch ..... | Each            |
| Culv, End, Rem, Over 48 inch.....        | Each            |
| Sewer, Rem, Less than 24 inch .....      | Foot            |
| Sewer, Rem, 24 inch to 48 inch .....     | Foot            |
| Sewer, Rem, Over 48 inch .....           | Foot            |

A. **General.** Unless otherwise required, the Engineer will measure structures or materials in the original positions.

The unit prices for the removal pay items include the cost of breaking down structures and material; sawing, removal, and disposal; providing, placing, and compacting backfill; and providing and placing replacement soil or base material.

The Department will pay for piling or timber cribs encountered during structure removal, but not shown on the plans, as extra work.

B. **Drainage Structure, Removal and Drainage Structure, Abandon.** The unit prices for **Dr Structure, Rem**, and **Dr Structure, Abandon**

include cost of maintaining and reconnecting live sewers, where required, and of removing attached parts and connections.

**C. Culvert, Removal and Culvert End, Removal.** The Engineer will measure elliptical or pipe arch culverts across the greatest dimension. The cost of removing existing end treatments, regardless of type, is included in the unit prices for the related culvert removal or culvert end removal pay items.

**D. Removal of Pipes (culverts, sewers, underdrains, etc.) With Diameters Less Than 12 inches.** The cost of removing pipes, including culverts, sewers, and underdrains, with diameters less than 12 inches, if portions of the existing pipe are within the excavation limits of a new structure, culvert, or sewer, is included in the unit price for constructing the new structure, culvert, or sewer.

**E. Abandoning Pipe Culverts and Abandoning Sewers.** The Department will not pay separately for abandoning pipe culverts and abandoning sewers.

Unless included in the unit price for abandoning drainage structures, the Department will pay for bulkheads greater than 12 inches, required in abandoning pipe culverts and abandoning sewers, as **Sewer Bulkhead** of the type required, in accordance with subsection [402.04.D](#).

**F. Removal of End Treatments.** The Department will pay for removing end treatments on existing sewers as **Culv End, Rem.**

**Section 204. REMOVING MISCELLANEOUS STRUCTURES AND MATERIALS**

**204.01. Description.** This work consists of removing miscellaneous structures and materials to clear the right-of-way, salvaging or disposing of removed materials, and backfilling the resulting excavated sites.

**204.02. Materials.** Provide material in accordance with the following:

Granular Material Class III..... [902](#)

**204.03. Construction.**

**A. Breaking Down and Removing.** Remove structures or portions of structures designated on the plans for removal, entirely or to the limits required, including attached parts and connections. Do not damage the remaining portion of an existing structure.

If removal of a structure is required but the removal is not shown on the plans, remove the structure entirely, or break it down in accordance with subsection [204.03.A.1](#).

- 1. **Partial Removal.** Break down portions of existing miscellaneous structures, not interfering with the new construction, to 3 feet below the pavement surface within the limits of the roadbed and to 1 foot below the finished grade outside the limits of the roadbed.
- 2. **Pavement, Curb, Sidewalk.** Remove pavement, curb, gutter, curb and gutter, sidewalk, downspout headers, and similar structures to an existing joint or to a sawed joint. Saw concrete full depth unless otherwise approved by the Engineer. Do not use a crane and ball pavement breaker. Provide for proper grades and connections to new work.

Replace adjacent soils or base materials, removed with concrete, with similar material approved by the Engineer.

- 3. **Masonry and Concrete Structures.** Remove entirely, or break down walls, foundations, and similar structures, excluding bridges, culverts, or retaining walls, in accordance with subsection [204.03.A.1](#). Partially or completely remove structures, including utility structures, with a least dimension of 12 inches, if constructed of masonry or non-reinforced concrete and a least dimension of 8 inches if constructed of reinforced concrete.
- 4. **Basement Cleanout.** Remove existing backfill material from basements, break up floors, plug drains, and backfill.

5. **Structures and Retaining Walls.** During Contractor's removal operations, protect the remaining portions of existing structures and new work under construction from damage.

If the contract requires salvaging part of a steel structure, before dismantling, match-mark with paint, the members designated for re-erection. Match-mark pins, nuts, loose plates, and parts to show proper locations. Treat pins, pin holes, and machined surfaces to prevent corrosion. Wire loose parts to adjacent members or pack in match-marked containers.

If the contract requires incorporating portions of an existing concrete structure into the new construction, use a concrete saw to make the concrete cuts that will be exposed in the final work. Do not overcut corners; drill and chip to provide square corners. Avoid cutting reinforcing steel wherever possible. Do not cut off steel reinforcement projecting from the existing concrete structure. Protect projecting steel reinforcement from damage and embed it in the new concrete.

Do not use explosives, unless the Engineer provides written permission. If the Engineer provides written permission, use explosives in accordance with subsection [107.17](#). The Engineer's written permission does not relieve the Contractor of liability and responsibility for damages resulting from the use of explosives.

6. **Culvert Structures.** Remove culvert structures or parts of culvert structures required for removal, or that interfere with the new construction. Remove culvert structures entirely or in accordance with subsection [204.03.A.1](#).

If the contract requires extension or incorporation of existing culvert structures into the new work, remove only enough of the existing structure to allow a connection to the new work. Trim the connecting edges of the existing culvert structure to the lines and grades required, without weakening or damaging that part of the structure.

7. **Railway Trackwork.** Remove rails; paving; timber, rubber or concrete crossing panels; ties; track encasement; concrete header foundations; and other related items. Leave crushed stone or gravel ballast in place as directed by the Engineer.
8. **Guardrail.** Remove posts, beam elements, anchorages, including concrete blocks, steel sleeves, or both, hardware, and other items.

9. **Utility Pole.** Remove poles, parts, and connections attached to utility poles.
10. **Fence.** Remove fence fabric, wire, posts, and foundations.
11. **Concrete Barrier.** Remove concrete barrier, glare screen if removed in conjunction with concrete barrier, and footings to an existing joint or sawed joint, and backfill as required. Remove barrier footings and post footings entirely or in accordance with subsection [204.03.A.1](#). Saw cut concrete full depth unless otherwise approved by the Engineer. Repair damage to existing manholes, catch basins, bridge piers, and remaining concrete barrier, glare screen, and footings, which result from removal operations.

If the contract requires extension or incorporation of existing barrier footings and/or post footings into the new work, remove only enough of the existing footing to allow a connection to the new work required.

12. **Glare Screen.** Remove glare screen. Repair damage to existing bridge piers and remaining glare screen and concrete barrier, which result from removal operations.

**B. Disposal of Materials.** Assume ownership of removed materials except as required by the contract. Without damaging, remove materials reserved for use by the Department, local agency, or others, and store outside the construction limits in a location and manner approved by the Engineer. Dispose of materials not incorporated into the new work in accordance with subsection [205.03.P](#), before the Department accepts the project.

If approved by the Engineer, the Contractor may salvage materials that meet specification requirements, and use in the new work.

Dispose of broken concrete, matted together by steel reinforcement, outside the right-of-way. Provide the Engineer with written permission from the property owner of the disposal site.

**C. Backfilling.** Backfill excavated sites or holes resulting from removals within the subgrade surface limit with Class III granular material, unless otherwise required. Place and compact the granular material in accordance with the controlled density method in subsection [205.03.H.4.a](#). For excavated sites outside or below the subgrade surface, the Engineer will approve backfill material and compaction methods.

## 204.04. Measurement and Payment.

| <b>Pay Item</b>                       | <b>Pay Unit</b> |
|---------------------------------------|-----------------|
| Pavt, Rem .....                       | Square Yard     |
| Curb, Rem .....                       | Foot            |
| Gutter, Rem .....                     | Foot            |
| Curb and Gutter, Rem .....            | Foot            |
| Sidewalk, Rem.....                    | Square Yard     |
| Basement Cleanout.....                | Cubic Yard      |
| Track, Rem .....                      | Foot            |
| Utility Pole, Rem .....               | Each            |
| Structures, Rem.....                  | Lump Sum        |
| Structures, Rem Portions .....        | Lump Sum        |
| Culv, Other than Pipe, Rem.....       | Each            |
| Masonry and Conc Structure, Rem ..... | Cubic Yard      |
| Guardrail, Rem .....                  | Foot            |
| Fence, Rem .....                      | Foot            |
| Concrete Barrier, Rem.....            | Foot            |
| Glare Screen, Rem.....                | Foot            |

A. **General.** Unless otherwise required by the contract, the Engineer will measure the structure or material quantities in their original position.

The cost of breaking down and removing, sawing, disposing of materials, and providing, placing, and compacting backfill is included in the unit price for the related pay items. The cost of providing and placing replacement soils or base materials is included in the related pay items.

The Department will pay for piling or timber cribs encountered during removal of structures, but not shown on the plans, as extra work.

B. **Pavement, Removal.** The limits of **Pavt, Rem**, as shown on the plans, will be established at the discretion of the Engineer. The Engineer may decide to leave areas in place, or remove additional sections to attain the required cross-section and base. The Engineer will measure **Pavt, Rem** in accordance with the following criteria.

1. **HMA Pavements and HMA Driveways.** The Department will pay separately for the removal of curb, curb and gutter, or gutter in conjunction with removing Hot Mix Asphalt (HMA) pavements or HMA driveways.

a. **HMA No Greater Than 12 Inches Thick.** The Engineer will measure the removal of HMA surface, no greater than 12 inches thick, overlying a material designated for removal or that is required to remain in place, as **HMA Surface, Rem** in

accordance with section [501](#). The Engineer will measure the removal of the underlying material separately.

- b. **HMA Greater Than 12 Inches Thick.** The Engineer will measure the removal of HMA surface, greater than 12 inches thick, overlying a material designated for removal or that is required to remain in place, as **Pavt, Rem**. The Engineer will measure the removal of the underlying material separately.

2. **Concrete and Masonry Pavements and Concrete Driveways.** The Engineer will measure the removal of concrete and masonry pavements and concrete driveways as **Pavt, Rem**.

If concrete or masonry pavements are encountered under the pavement being removed, the Engineer will measure each type of additionally encountered pavement at the unit price for **Pavt, Rem**. The Department will consider a concrete overlay a separate pavement.

The Engineer will measure the removal of curb, curb and gutter, or gutter in conjunction with removing concrete or masonry pavement or concrete driveways, as **Pavt, Rem**.

- C. **Curb, Removal; Gutter, Removal; or Curb and Gutter, Removal.** The Engineer will measure **Curb, Rem, Gutter, Rem, and Curb and Gutter, Rem**, if included as separate pay items, and not removed in conjunction with pavement or driveway removal, along the base of the curb face or along the flowline of the gutter.

The unit prices for **Curb, Rem, Gutter, Rem, and Curb and Gutter, Rem** include the cost of removing downspout headers.

- D. **Sidewalk, Removal.** The unit price for **Sidewalk, Rem** includes the cost of removing and disposing of sidewalk, 6 inches thick, or less. The Engineer will measure removing sidewalk greater than 6 inches thick as **Pavt, Rem** in accordance with subsection [204.04.B](#).

- E. **Basement Cleanout.** The Engineer will calculate the volume of **Basement Cleanout** on the elevation of the existing backfill, the elevation of the floor, and the inside dimensions of the foundation. The Engineer will only measure **Basement Cleanout** outside the pay limits for **Excavation, Earth**, in accordance with subsection [205.04](#).

- F. **Track Removal.** The Engineer will measure **Track, Rem** by length of single line track. The unit price for **Track, Rem** includes the cost of removing rails, ties, track encasement, stone or ballast as directed, concrete header foundations and other related items.

The Engineer will measure removal of pavement from between the rails and on either side of the track as **Pavt, Rem** in accordance with subsection [204.04.B](#).

G. **Utility Pole Removal.** The unit price for **Utility Pole, Rem** includes the cost of removing and disposing of the pole, attached parts, and connections.

H. **Structures, Removal and Structures, Removal, Portions.** The unit prices for **Structures, Rem**, and **Structures, Rem Portions** include the cost of removing and disposing of miscellaneous structures or portions of structures.

I. **Payment for Culvert, Other than Pipe, Removal.** The unit price for **Culv, Other than Pipe, Rem** includes the cost of breaking down, removing, sawing, and disposing of materials, and providing, placing, and compacting backfill.

J. **Payment for Masonry and Concrete Structures, Removal.** The Department will only pay for **Masonry and Conc Structure, Rem** if the smallest dimension of the masonry or concrete structures, or parts of masonry or concrete structures, is at least 12 inches, and the smallest dimension of reinforced concrete structures is at least 8 inches. The Department will pay for the removal of other masonry and concrete structures as **Excavation, Earth**, in accordance with subsection [205.04](#).

K. **Guardrail, Removal.** The Engineer will measure **Guardrail, Rem** along the face of the existing guardrail installation. The unit price for **Guardrail, Rem** includes the cost of the removal and disposal of multiple beam elements, posts, anchorages, including concrete blocks and sleeves, hardware, and other items.

L. **Fence, Removal.** The unit price for **Fence, Rem** includes the cost of removing and disposing of fence fabric, wire, posts, and foundations.

M. **Concrete Barrier, Removal.** The Engineer will measure **Conc Barrier, Rem** along the centerline of the barrier. The Engineer will measure the removal of split concrete barrier along the centerline of barrier or glare screen on each side, without deductions for bridge piers. The unit price for **Conc Barrier, Rem** includes the cost of breaking down and removing, sawing, disposing of materials, providing, placing and compacting backfill, and repairing damage to existing items that are damaged during removal operations.

If the pay item **Glare Screen, Rem** is not included in the contract, the cost of removing glare screen in conjunction with concrete barrier removal is included in the unit price for **Conc Barrier, Rem**.



N. **Glare Screen, Removal.** The Engineer will measure **Glare Screen, Rem** along the centerline of the screen. The unit price for **Glare Screen, Rem** includes the cost of breaking down and removing, sawing, disposing of materials, and repairing existing concrete barrier, damaged during removal operations.

O. **Bulkheads.** The cost of bulkheading abandoned pipes, conduits, or service connections, with a diameter no greater than 12 inches, encountered in excavation, is included in other related pay items. The Engineer will measure bulkheading abandoned pipes, conduits, or service connections, with a diameter greater than 12 inches as **Sewer Bulkhead** in accordance with subsection [402.03.E](#).

## Section 205. ROADWAY EARTHWORK

**205.01. Description.** This work consists of the following:

- A. Constructing earth grades by excavating soil or rock and placing embankments or fills;
- B. Salvaging and stockpiling selected materials;
- C. Providing, placing, and compacting embankment materials;
- D. Trimming the earth grade;
- E. Disposing of surplus or unsuitable material; and
- F. Maintaining the work in a finished condition until accepted by the Engineer.

Earth excavation consists of the work to excavate materials not otherwise addressed in the contract as separate work items. Rock excavation and subgrade undercutting are separate work items.

Investigate local conditions before bidding, in accordance with subsection [102.04](#). Soil series notations and boring logs, shown on the plans, are for information only. Refer to the *Michigan Department of State Highways Field Manual of Soil Engineering, 5<sup>th</sup> edition* for detailed data regarding soil series notations and soils descriptions.

### Terminology.

**CIP.** A term, when used with an embankment item, that denotes Compacted in Place.

**LM.** A term, when used with an embankment item, that denotes Loose Measure.

**Sound Earth.** A natural, or otherwise Engineer-approved material, that can be compacted to the required density, contains no organic material, and has a maximum unit weight of at least 95 pounds per cubic foot.

**Frost Heave Textured Material.** A material with more than 50 percent silt particles by weight, and a plasticity index less than 10.

**Silt.** A material with a particle size from 0.002 mm to 0.075 mm.

**205.02. Materials.** Provide materials in accordance with the following:

|                                       |                     |
|---------------------------------------|---------------------|
| Granular Material Class II, III ..... | <a href="#">902</a> |
| Open-Graded Aggregate .....           | <a href="#">902</a> |
| Geosynthetics .....                   | <a href="#">910</a> |

Do not use foundry sand from metal casting for roadway earthwork.

Refer to the [Density Testing and Inspection Manual](#) for maximum unit weight and in-place density test methods.

**205.03. Construction.** Before beginning earth disturbing activities, install soil erosion and sedimentation control (SESC) measures, in accordance with section [208](#).

The Department considers buried rubbish and trash, not identified in the contract, a differing site condition in accordance with subsection [103.02.C](#).

**A. Preparing Roadway Foundation.** Remove material from the roadway foundation and salvage or dispose. Compact the roadway foundation to the depth and density required.

Perform removal, salvage, and disposal operations in accordance with the following:

1. **Removing and Salvaging Topsoil.** Before removing topsoil, reduce vegetation to a height of 6 inches. Remove and dispose of cut vegetation, brush, rocks, and other litter.

Remove topsoil to the required depth from designated areas before excavating or placing embankment. Use equipment and methods that avoid lifting subsoil. Suspend topsoil removal if the Engineer determines soil or weather conditions are unsuitable.

Use topsoil from the roadway on slopes, or stockpile unused topsoil within the right-of-way, and outside the limits of construction. Locate and shape topsoil stockpiles outside of the drip line of preserved trees and away from drainage courses and wetlands.

If temporarily stockpiling topsoil outside the right-of-way, obtain written permission from the owner of the property designated for material placement and required permits in accordance with subsection [208.03.A](#). Provide documentation to the Engineer before stockpiling topsoil. Do not stockpile temporarily or permanently in wetlands or floodplains.

Remove topsoil as follows:

- a. In peat and muck areas, do not remove topsoil;
- b. In borrow and clear vision areas, remove topsoil to the depth and width required;
- c. At inlet, outlet, and berm ditch areas, remove topsoil within the construction limits; and
- d. At roadway cut and embankment areas, remove topsoil within the limits of earth disturbance.

2. **Salvaging Materials.** Remove existing gravel, crushed stone, or selected excavated materials. The Contractor may salvage these materials. The Engineer may approve the use of salvaged materials to construct earth shoulders, approaches, temporary roadway surfacing, or other work the Engineer determines appropriate. Do not salvage foreign or undesirable material. Temporarily stockpile salvaged material outside the limits of Contractor's earth disturbance, and within the right-of-way limits, as approved by the Engineer.

Excess salvaged material is the property of the Contractor. Remove excess salvaged material before project completion. If the Engineer approves excess salvaged material stockpiles to remain on the project, trim excess stockpiles to a neat appearance.

3. **Disposing of Stones, Broken Rock, and Boulders.** The Engineer may allow placement of stones, broken rock, and boulders in the right-of-way in a safe and scenic manner. For material that cannot be incorporated in the work, bury between the roadway and right-of-way lines, or dispose outside the right-of-way. Bury stones, broken rock, and boulders below the natural ground level, with at least 12 inches of cover material. Dispose of materials in accordance with subsection [205.03.P](#).

**B. Rock Excavation.** Excavate boulders with a volume of at least  $\frac{1}{2}$  cubic yard. Excavate rock or cemented soils that do not soften when wet or that cannot be excavated without continuous drilling, blasting, or continuous use of a ripper or other special equipment.

Expose the surface of the rock to allow the Engineer to measure before starting rock excavation. Remove rock encountered in the excavation to the required cross section and in accordance with all of the following:

1. Excavate so no rock extends more than 6 inches above the lines of the required cross section.
2. Excavate backslopes to the neat line slopes shown on the plans, with no rock extending more than 12 inches from the true slope.
3. Excavate the rock surface to provide drainage. Do not leave undrained pockets in the rock surface.
4. Remove rock or boulders loosened in the excavation and overhanging ledges, on or outside the required cross section.

**C. Peat Excavation.** Remove peat, muck, marl, and underlying very soft clay. Coordinate removal with swamp backfill operations.

**D. Swamp Backfill.** Construct embankments across peat marshes as shown on the plans. Widen the embankment at culvert locations to

provide a stable foundation for the length of the culvert, including headwalls and end sections. Provide granular material Class III for swamp backfill.

If total excavation of peat results in a reasonably dry trench as determined by the Engineer, the Engineer may allow backfilling as a separate operation. Backfill the reasonably dry trench immediately after completing the excavation in accordance with the controlled density method in subsection [205.03.H.4.a](#). Perform excavation and backfill as separate operations in shallow peat areas only with the Engineer's prior approval.

Coordinate the rate of advancement of the embankment and surcharge in deep swamps with the rate of excavation of the upheaved peat. If a trench of the required depth is not maintained full width ahead of the surcharge, use additional peat excavating equipment or stop construction of embankment and surcharge until the two operations are in balance.

Dispose of peat as shown on the plans or in accordance with subsection [205.03.P](#).

The Department will bore swamp backfill to determine if unsuitable material is completely excavated or displaced. If the borings show the presence of unsuitable material under the swamp backfill, the Department will determine the corrective action. The Department will complete borings and notify the Contractor of corrective actions within 60 days after completion of the swamp backfill.

Corrective action may consist of excavating, placing a surcharge, excavating relief trenches, or a combination of these actions.

If placing a surcharge over the swamp backfill, the Engineer will determine the width and elevation. Leave the surcharge in place until the Engineer determines that the swamp backfill is stable, or the required settlement has taken place. The Engineer may require that the surcharge remain in place for up to 90 days.

Material from the surcharge is the property of the Contractor.

Obtain the Engineer's approval of swamp backfill and complete peat excavation and spreading before placing the pavement structure.

**E. Subgrade Undercutting.** Undercut the subgrade and backfill to replace material susceptible to frost heaving or differential frost action and to remedy unstable soil conditions.

Topsoil removal and peat excavation are not included in subgrade undercutting. Subgrade undercutting includes excavation below subgrade in cut sections, excavation at the transition from cut to fill sections, and excavation, other than peat excavation, as required below the topsoil in fill sections.

Excavated material from subgrade undercutting is the property of the Contractor.

1. **Limits of Subgrade Undercutting.** Excavate the subgrade to the approximate grade. The Engineer will promptly inspect the grade to decide the necessity of undercutting, and to determine the limits of undercutting.

In shallow fill areas, the Engineer will inspect the fill area and determine the limits of the subgrade undercutting before the Contractor begins embankment placement.

Remove deposits of frost heave textured material between lines 2 feet outside the proposed surface, including paved shoulders. For areas north of the north boundary of Township 12 North, remove the frost heave textured material to a depth of 4 feet to 5 feet below the plan grade. For areas south of the north boundary of Township 12 North, remove the frost heave textured material to a depth of 3½ feet to 4 feet below the plan grade.

2. **Backfill of Subgrade Undercut.** Backfill subgrade undercutting Type I with selected clay or other Engineer-approved material.

Backfill subgrade undercutting Type II with granular material Class II.

Backfill subgrade undercutting Type III with the material excavated from subgrade undercut areas, after mixing the excavated material to break up the undesirable strata of soils, or with other Engineer-approved backfill material.

Compact subgrade undercutting backfill to at least 95 percent of its maximum unit weight.

- F. **Subgrade Manipulation.** Scarify, mix, and blend the roadbed subgrade to a depth of 12 inches below the top of subgrade. Compact to at least 95 percent of its maximum unit weight.

- G. **Earth Excavation.** Excavated material, except as specified in subsection [205.03.A](#), is the property of the Contractor.

Compact the subgrade to at least 95 percent of its maximum unit weight and to a depth of at least 10 inches. If the subgrade cannot be compacted to 95 percent of its maximum unit weight, using conventional

construction methods, the Engineer may authorize use of other methods to attain compaction.

In cut sections where the existing material appears to meet the requirements of subsection [301.02](#), excavate the grade to top of subbase rather than to the bottom of subbase. The Engineer will then determine whether the existing material meets subbase requirements. Shape material meeting subbase requirements to the top of subbase grade and compact to at least 95 percent of its maximum unit weight and to a depth of at least 12 inches. The Engineer will adjust earthwork quantities accordingly. Excavate material not meeting subbase requirements to the bottom of subbase. The Department will not consider claims for damage caused by the Contractor halting grading operations so the Engineer can make subbase determinations.

Maintain the roadbed and ditches and provide drainage at all times. Install and remove temporary drainage facilities at no additional cost to the Department.

Perform grading to avoid removing or loosening material outside the required slopes. Replace and compact material removed or loosened outside the slopes to the required density and cross section.

Dispose of surplus or waste material resulting from ditch construction in accordance with subsection [205.03.P](#). Remove roots, stumps, or other materials unacceptable to the Engineer in the slopes and bottom of the ditch and backfill the holes with suitable material. Maintain ditches until the Engineer's final acceptance.

#### H. **Roadway Embankment.**

1. **Stepping Side Slope.** Step embankments, constructed on existing side slopes of 1:6 or steeper, before placing embankment. Form steps with a horizontal dimension of at least 3 feet.
2. **Borrow.** Borrow consists of material, approved by the Engineer, from locations outside the roadway. Excavate, transport, and place borrow material in accordance with subsection [105.03](#).

After removal of borrow, leave borrow areas free-formed without rigid geometric shapes. Make side slopes as flat as practical, but ensure slopes no steeper than 1:4. Round the tops and bottoms of slopes with vertical curves to blend into adjacent terrain. Grade overburden left in the borrow area, except topsoil, to eliminate unsightly mounds, as determined by the Engineer.

Where practical, shape borrow areas to drain, leaving usable land after completion. In granular soil, leave the area at least 12 inches

above the high ground water level. In cohesive soil, leave the area at least 12 inches above the high water elevation of the drainage outlet.

If the borrow area cannot be drained, create a pond or a wetland. Create ponds by excavating to a depth of at least 8 feet below normal ground water level in granular soil, or to 8 feet below the lowest drainage outlet in cohesive soil. Create wetlands by excavation to the elevation directed by the Engineer.

Restore borrow areas as shown on the plans, or in a manner that will leave the land in a useful condition and with a natural appearance. Restore borrow areas within the right-of-way as required by the contract. Fence ponded borrow areas, unless otherwise directed by the Engineer.

Restore borrow areas outside the right-of-way in accordance with permit requirements covered by 1994 PA 451, Part 91 Soil Erosion and Sedimentation Control. Topsoil, seed, and mulch borrow areas outside the right-of-way, not created as ponds or wetlands. Place topsoil, seed, fertilizer, and mulch above the normal water surface in borrow areas left as ponds or wetlands. Restore borrow areas without existing topsoil, as approved by the Engineer. Use materials and application rates specified in section [816](#) or as otherwise approved by the Engineer. Where the planting of pine seedlings is consistent with surrounding land uses, the Engineer may approve pine seedlings, spaced 6 feet apart, as an alternative for topsoil, fertilizer, seed, and mulch.

The Engineer may allow boulders to remain in borrow areas, if placement creates a natural appearance.

The Engineer may waive restoration requirements if the Contractor takes borrow from the working area of an existing commercial source, or the property owner holds a permit from a county or municipal enforcing agency, designated under 1994 PA 451, Part 91 Soil Erosion and Sedimentation Control. Provide the Engineer with a copy of the property owner's permit.

- 3. Winter Grading.** The Engineer will determine the winter grading limits. Remove ice and snow from the ground surface before placing embankment.

Remove frozen material if the original ground contains more than 4 inches of frost within the limits of 1:1 slopes extending away from the finished shoulders to points of intersection with the original ground.



Remove frozen material on a partially complete fill before placing more fill on the embankment. Stockpile frozen material in areas approved by the Engineer and outside the limits of earth disturbance until thawed. Use the thawed material in the embankment if it meets moisture requirements at the time of use.

4. **Placing and Compacting Embankment.** After preparing the ground area, construct embankments with sound earth or a mixture of sound earth and stones, broken rock, concrete, or masonry, except within the top 3 feet of embankment, or as allowed in the disposal of peat excavation material in accordance with subsection [205.03.D](#), and subsection [205.03.P](#). Do not place frost heave textured materials in the top 3 feet of embankment below subgrade surface. Use a uniformly textured material to construct the top 3 feet of embankment to a uniformly stable condition. Provide at least 50 feet longitudinal transition between two types of textured materials.

Deposit embankment materials and compact in accordance with the controlled density method. The Engineer may direct or approve the 12-inch layer method, rock embankment method, or methods for treatment of peat marshes.

Construct embankments using methods that do not create an unstable slope condition. Do not block the drainage of granular material by placing impervious material on the outside of embankments, or by placing a combination of pervious and impervious material in the embankment, creating potential pockets of saturated material. Do not place peat excavation material in upland areas between the 1:1 slope that extends down from the subgrade surface/front slope intercept point and the final plan fill slope, in fills greater than 14 feet high.

The Engineer may allow placement of stones uncovered within construction limits, broken concrete, and broken rock from rock cuts in embankments. Use stones, broken concrete, and broken rock with the largest dimension no greater than 12 inches. Place in layers. Fill voids with sound earth and compact to at least 95 percent maximum unit weight. Do not place stones, broken concrete, and broken rock layers within 3 feet of the subgrade surface.

Where placing embankment in layers of the required thickness is not feasible, such as filling in water or constructing on poorly drained soil, the Engineer may allow construction of the embankment in one layer of granular material Class III, and will determine the

minimum elevation for equipment operation. Thoroughly compact the fill material. Above the granular material Class III elevation, construct the embankment in accordance with the controlled density method.

Backfill and compact embankment adjacent to structures in accordance with subsection [205.03.I](#) and subsection [206.03.B](#). Construct other embankment and backfill as follows:

- a. **Controlled Density Method.** Deposit cohesive material for embankments and spread in layers no greater than 9 inches deep, loose measure, and extending to the full width of the fill area.

For granular material, attain the required density by depositing, spreading, and compacting in layers no greater than 15 inches deep.

Provide cohesive material with a moisture content no greater than 3 percent above optimum, at the time of compaction. Provide granular material with a moisture content below saturation, in accordance with the one point cone chart in the [Density Testing and Inspection Manual](#).

Provide cohesive material in the top 3 feet of embankment with a moisture content not exceeding optimum. For material containing excess moisture, dry to the required moisture content before compacting. Ensure each layer of material meets moisture requirements and compact each layer to at least 95 percent of the maximum unit weight, before placing the succeeding layer.

If the required percentage of maximum unit weight and the required moisture content are attained, but the compacted material does not provide support for the subbase, the Engineer may direct the Contractor to dry the material by aeration and re-compact. Aerate by disking or manipulating the material by other methods approved by the Engineer.

- b. **Twelve Inch Layer Method.** Deposit the material and spread in layers no greater than 12 inches deep, loose measure, parallel to the finished grade, and extending to the full width of the embankment. Deposit the material by operating the hauling equipment over the layer being placed. Compact each layer to at least 95 percent of its maximum unit weight in accordance with the 12-inch layer method test in the [Density Testing and Inspection Manual](#).

- c. **Rock Embankment.** Use shattered rock from blasting or ripping, with the largest dimension no greater than 12 inches, to construct rock embankment. Deposit rock on the constructed fill and push over the leading edge to extend the fill. Do not deposit the shattered rock from the hauling equipment, directly over the end of the fill. Place the rock embankment in layers no greater than 3 feet thick. Fill the surface of the rock embankment with rock fragments and rock fines to prevent infiltration of the earth embankment. Use granular material Class III to supplement insufficient rock fines to fill the surface of the rock embankment.

Do not use this method in fills less than 4 feet deep. Do not place the stones and broken rock layers within 3 feet of the subgrade surface. For structures located under rock embankment, provide at least 24 inches of granular material Class III along the sides and the top of structures, before placing the rock embankment.

**1. Structure Embankment.**

1. **Compaction of Original Ground.** In fill areas on which a structure is required, remove the topsoil from the area within the toes of slope in accordance with subsection [205.03.A.1](#). Compact the area to at least 95 percent of the maximum unit weight, and at least 9 inches deep.
2. **Placing Structure Embankment.** Place and compact structure embankment to the limits shown on the plans before casting overlying footings. Protect structure embankments from freezing until placement of overlying footings.
  - a. **Under Structure Footings Supported by Piling.** Construct structure embankment with Class III granular material within the limits shown on the plans. The Engineer may allow the use of sound earth as an alternate material when placed between April 1 and November 15. Use sound earth, as defined in subsection [205.01](#), except that for rocks or broken concrete, the greatest dimension must be less than 3 inches. Deposit and compact structure embankment in accordance with the controlled density method.
  - b. **Under Structure Footings for Which Piling is Not Specified.** Construct structure embankment with Class III granular material within the limits shown on the plans and deposit and compact in accordance with the controlled density method. Compact structure embankment to 100 percent of the maximum unit

weight within the limits of 1:1 slopes, extending outward and downward from the bottom edges of the structure footings.

3. **Winter Grading for Structure Embankment.** Construct embankment during winter weather in accordance with subsection [205.03.H.3](#), except, before placing embankment to support a structure, remove ground containing frost within the limits of 1:1 slopes spreading outward in every direction from the bottom edges of structure footings. Stockpile frozen material outside the limits of earth disturbance in areas, approved by the Engineer, until thawed.

J. **Machine Grading.** Machine grading consists of light grading, 12 inches deep, to develop the cross section shown on the plans and includes the following:

1. Scarifying,
2. Plowing,
3. Disking,
4. Moving,
5. Compacting, and
6. Shaping the earth.

Loading or hauling material is not required for machine grading.

Grade ditches to drain runoff water. Grade intersections, approaches, entrances, and driveways as shown on the plans or as directed by the Engineer. Obtain the Engineer's approval before using excavation from ditches and roadbeds for shaping shoulders and adjacent fills.

K. **Ditch Cleanout.** Perform ditch cleanout, to a depth no greater than 2 feet, based on a typical cross section shown on the plans, including the following work:

1. Removing cattails, brush and miscellaneous debris;
2. Removing trees with a diameter less than 6 inches; and
3. Blending ditch profiles to match the existing ditch.

L. **Temporary Railroad Crossing.** Construct temporary railroad crossings in accordance with subsection [107.20](#).

M. **Granular Blanket.** Excavate unstable soil in the slopes and backfill within the limits and to the depths shown on the plans, or as directed by the Engineer. Dispose of excavated material in accordance with subsection [205.03.P](#).

For granular blanket, Type 1, backfill with Class II granular material.

For granular blanket, Type 2, dress the excavated area with a nominal 3-inch layer of Class II granular material before placing the drainage layer. Construct the drainage layer using one of the following:

1. A 2-inch layer of open-graded aggregate with geotextile blanket above and below;
2. A three-dimensional mesh with geotextile blanket above and below;  
or
3. Other geocomposite section approved by the Engineer.

Place at least a 12-inch layer of Class II granular material on the drainage layer to bring the slope and ditch section to the required elevation and cross section.

Construct underdrains adjacent to, or as a part of the slope protection, in accordance with section [404](#).

**N. Trimming and Finishing Earth Grade.** Construct the earth grade to the required grade. Remove exposed stones and rocks with a diameter greater than 3 inches.

Trim the subgrade to the grade shown on the plans. If a subbase is required, trim the subgrade to within  $\pm 1$  inch of the required grade. If a subbase is not required, trim the subgrade to within  $\pm \frac{3}{4}$  inch of the required grade.

Trim and shape the earth grade outside the subgrade to the required lines, grades, and cross sections. Finish slopes to Class B tolerance unless Class A tolerance is required.

Finish Class A slopes to within  $\pm 1$  inch of the average slopes shown on the plans. Make measurements at right angles to the slope.

Finish Class B backslopes to within  $\pm 6$  inches of the average slopes shown on the plans. Make measurement at right angles to the slope. Do not leave abrupt variations in the finished surface. Remove debris and unsuitable material.

Finish Class B fill slopes to within  $\pm 2\frac{1}{2}$  inches of the required grade and cross section, from the outside shoulder line for 3 feet down the slope. Measure at right angles to the slope. Finish the remainder of the fill slope the same as Class B backslope.

If trees or other obstacles do not interfere, round the tops of backslopes, bottoms of fill slopes, and other angles in the lines of the cross section, to form vertical curves as shown on the plans or as directed by the Engineer. Make vertical curve transitions gradual and present a uniform

and attractive appearance. The Contractor may omit vertical curves if constructing ditches in peat.

**O. Channel Excavation.** Trim, straighten, widen, deepen, or relocate the channel of a stream or watercourse. Remove and dispose of excavated material. Remove masonry and concrete structures in accordance with section [204](#). Complete work in the new channel before diverting the stream flow to the new channel. Maintain channels and keep free from debris until final acceptance of the channel.

**P. Disposing of Surplus and Unsuitable Material.** The Department assumes no legal obligation to ensure the Contractor responsibly disposes of surplus and unsuitable material in accordance with this section.

1. **Disposal Within the Right-of-Way.** Do not dispose of material, temporarily or permanently, beyond the normal plan fill slope across wetlands or floodplains. The Engineer may allow disposal of material within the right-of-way to fill low areas or flatten slopes, at no additional cost to the Department. The Engineer may allow burying, piling, or placing material in a safe and scenic manner in selected areas within the right-of-way, at no additional cost to the Department.
2. **Disposal Outside the Right-of-Way.** Do not dispose of material, temporarily or permanently, in wetlands or floodplains. Obtain and file, with the Department, written permission from the owner of the property for disposal outside the right-of-way. Dispose of material and restore areas in accordance with subsection [205.03.H.2](#), at no additional cost to the Department.
3. **Contractor Responsibility.** The Contractor is directly and solely responsible for disposal of surplus and unsuitable material.

Contact the appropriate regulatory agencies to determine if an area is a regulated wetland or floodplain, before disposing surplus or unsuitable material in areas outside the right-of-way, not shown on the plans as disposal sites.

Immediately move surplus or unsuitable material, disposed in portions of wetlands or floodplains not shown on the plans as disposal sites, to an upland site, at no additional cost to the Department. Restore the vacated area as directed by the regulatory agencies, at no additional cost to the Department.

The Engineer will not consider requests for contract time extensions without assessment of liquidated damages for delays associated with moving surplus or unsuitable material to an upland site.

4. **Notification to Regulatory Agencies.** The Department will notify the regulatory agencies if the Department becomes aware that the Contractor disposed of surplus or unsuitable material in portions of a wetland or floodplain not shown on the plans.

**205.04. Measurement and Payment.**

| <b>Pay Item</b>                      | <b>Pay Unit</b> |
|--------------------------------------|-----------------|
| Excavation, Earth .....              | Cubic Yard      |
| Excavation, Rock.....                | Cubic Yard      |
| Excavation, Peat.....                | Cubic Yard      |
| Backfill, Swamp .....                | Cubic Yard      |
| Subgrade Undercutting, Type __ ..... | Cubic Yard      |
| Subgrade Manipulation.....           | Square Yard     |
| Embankment, LM .....                 | Cubic Yard      |
| Embankment, CIP .....                | Cubic Yard      |
| Embankment, Structure, CIP.....      | Cubic Yard      |
| Machine Grading .....                | Station         |
| Ditch Cleanout .....                 | Station         |
| Excavation, Channel.....             | Cubic Yard      |
| Granular Blanket, Type __.....       | Cubic Yard      |
| Granular Material, Cl __ .....       | Cubic Yard      |

A. **Roadway Earthwork Volumes.** The Engineer will calculate roadway earthwork volumes using the average end areas, or the staked-section method, unless otherwise required.

The Engineer will determine the average end areas using the cross sections determined from the original and final elevation measurements.

For the staked-section method, the Engineer will calculate earthwork quantities using the original cross sections taken before construction, and slope stake and grade stake data from field notes.

The Engineer will take measurements during construction to ensure conformance to the required grade and cross sections. The Engineer will adjust quantities for changes in design or Engineer-authorized deviation from the established grade and cross section.

B. **General.** The cost to build, maintain, remove, and restore borrow haul routes is included in the unit prices for other pay items.

The Engineer will measure removing topsoil and other selected excavated materials from embankment areas as **Excavation, Earth.**

If the progress clause in the contract requires the Contractor to construct embankments during the winter, the Department will pay for the frozen material removed and the embankment required to replace it at the unit

price for **Excavation, Earth** and **Embankment**, of the type required. The Engineer will direct the winter grading limits.

The Department will not pay for removing topsoil and frozen material to facilitate the Contractor's operations.

The unit prices for other pay items include the cost of compacting existing material in embankment and cut sections after removing topsoil.

The Department will pay for removal of masonry and concrete structures in accordance with section [204](#).

The Engineer will measure **Granular Material, CI II** and **Granular Material, CI III** in place. The Engineer will measure **Granular Material, CI III**, required for constructing fills in water or constructing fills on poorly drained soil, as **Backfill, Swamp**.

The Engineer will measure **Underdrains, Bank** in accordance with subsection [404.04](#).

The cost of trimming the subgrade and slopes, to the required tolerances is included in the unit prices for other pay items.

The cost of restoring borrow and disposal areas is included in the unit prices for other pay items.

**C. Excavation, Rock.** The Engineer will measure **Excavation, Rock** by the staked-section method with no allowance for overbreak. The Department considers overbreak the material removed outside the area shown on the plans or Engineer-approved cross section for rock excavation.

The Engineer will not make deductions for rock projecting inside the lines of the cross section, within the limits required.

The Engineer will measure boulders greater than ½ cubic yard individually and will calculate the volume from average dimensions taken in three directions. The Department will pay for boulders, greater than ½ cubic yard, as **Excavation, Rock**.

The Engineer will measure removal of overburden as **Excavation, Earth**.

**D. Peat Excavation and Swamp Backfill.** The Engineer will measure total **Excavation, Peat** in its original position.

For the measurement of partial **Excavation, Peat** and displacement, the Engineer will include the volume of the peat excavated to form the trench, and the excavation of the upheaved peat in the trench. The Engineer will estimate the volume of upheaved peat, required for



removal from the trench, at 100 percent of the actual peat displaced. The Department will not include peat, displaced outside the pay limits shown on the plans, in the pay quantity. The Engineer will take borings to determine the depth of displacement for calculating pay quantities.

The Department will pay for excavating peat, muck, marl, and underlying very soft clay as **Excavation, Peat**.

The unit price for **Excavation Peat**, includes the cost of re-handling waste material to facilitate displacement.

In the treatment of peat marshes, the Department will not allow claims for delays lasting less than 60 days caused by Department testing and determination of corrective methods. Perform corrective work in areas requiring the total excavation method at no additional cost to the Department.

The Department and the Contractor will share equally, the costs for corrective work in areas where the partial peat excavation and displacement method is required or directed by the Engineer. Payment for the corrective work includes excavation and relief trenches. If the Engineer recommends placement of a temporary surcharge, the Department will pay for half the swamp backfill quantity required for the surcharge. The Department will pay for half the quantity of swamp backfill removed as **Excavation, Earth**, after the backfill stabilizes or the required settlement occurs.

If shown on the plans, the Department will pay for placement of temporary surcharge at the unit price for **Embankment, CIP or Backfill, Swamp**. The Department will pay for the removal of temporary surcharge at the unit price for **Excavation, Earth**.

The cost of maintaining a temporary surcharge, moved forward as the fill progresses, is included in the unit prices for other relevant pay items

The Engineer will measure **Backfill, Swamp** in its original position. To facilitate measurement, isolate an area in the borrow pit or roadway cut as the exclusive source of material for **Backfill, Swamp**. If the Engineer requires more than initial and final cross sections to measure and calculate the volume of material removed, pay the Department for additional cross sections and calculations.

If not practical to calculate the volume of **Backfill, Swamp** in its original position, the Engineer will calculate the volume within the limits shown on the plans, or from fill borings, and increase the volume by 15 percent. The Engineer will not increase the **Backfill, Swamp** volume by 15 percent if the peat excavation results in a dry hole.

The Engineer will not increase the volume of **Backfill, Swamp** by 15 percent if the material is used to construct sand core fills regardless of whether sand core fills are shown on the plans or directed by the Engineer.

**E. Subgrade Undercutting and Subgrade Manipulation.**

1. **Subgrade Undercutting.** The Engineer will measure **Subgrade Undercutting** in its original position. The Department will not make deductions in subgrade undercut quantities for areas where underdrain is installed.

The Department will not adjust the unit price for changes to the quantity of the type of **Subgrade Undercutting** required.

The unit price for **Subgrade Undercutting** of the type required includes the cost of removal and disposal of unsuitable material, and replacement with required material.

2. **Subgrade Manipulation.** The Engineer will measure **Subgrade Manipulation** only in designated areas shown on the plans or directed by the Engineer.

**F. Earth Excavation and Embankment.** The cost of stepping side slopes is included in the unit prices for the related roadway embankment pay items.

1. **Embankment, LM.** The Engineer will measure **Embankment, LM** by volume, loose measure. The unit price for **Embankment, LM** includes the cost of providing, hauling, placing, and compacting material at the required locations.
2. **Excavation, Earth and Embankment, CIP.** The Engineer will determine if payment for **Excavation, Earth** and **Embankment, CIP** will be based on plan quantities.

If use of plan quantities is not feasible, the Engineer will measure **Excavation, Earth** and **Embankment, CIP** in accordance with all of the following:

- a. The Engineer will measure **Excavation, Earth** using the staked-section method unless the Contractor performs excavation without predetermined excavation limits.
- b. The Engineer will measure **Embankment, CIP** based on the grade and cross section shown on the plans or approved by the Engineer, using the staked-section method. The Engineer will not make allowance for increases in quantities of fill material

required due to normal consolidation of the natural ground under the embankment. If the Contractor disposes of surplus or unsuitable material outside the plan cross sections, the Engineer will not measure it as **Embankment, CIP**.

If material is removed in embankment areas to a greater depth than required, the Department will only pay for the quantities of **Excavation, Earth; Embankment, CIP; and Embankment, Structure, CIP** as shown on the plans, or as directed by the Engineer.

3. **Embankment, Structure, CIP.** The Engineer will measure **Embankment, Structure, CIP** based on the grade and cross section shown in the plans, using the staked-section method. The Engineer will not make allowance for increases in quantities of fill material required due to normal consolidation of the natural ground under the embankment.

The Engineer will measure sound earth, if used as structure embankment under pile-supported footings, as **Embankment, CIP**.

G. **Machine Grading.** The Engineer will measure **Machine Grading** along the surface edge. The Engineer will measure each side of the road, where work is performed, separately.

H. **Ditch Cleanout.** The Engineer will measure **Ditch Cleanout** along the center line of the ditch. The Engineer will measure, and the Department will pay for the cost of restoring the ditch in accordance with section [816](#).

I. **Granular Blanket.**

1. **Granular Blanket, Type 1.** The Engineer will measure **Granular Blanket, Type 1**, including the volume of granular material Class II, within the limits and to the depth shown on the plans or approved by the Engineer.
2. **Granular Blanket, Type 2.** The Engineer will measure **Granular Blanket, Type 2** in place, and include the volumes of the drainage layer and granular material Class II, within the limits and to the depth shown on the plans or approved by the Engineer.

J. **Channel Excavation.** The Engineer will measure **Excavation, Channel** by volume in its original position.

## Section 206. EXCAVATION AND BACKFILL FOR STRUCTURES

**206.01. Description.** This work consists of clearing, removing old structures or parts of structures, removing materials required for constructing structures, disposing of excess or unsuitable material in accordance with subsection [205.03.P](#), and backfilling completed structures.

**206.02. Materials.** Provide materials in accordance with the following:

|                                 |                     |
|---------------------------------|---------------------|
| Sound Earth.....                | <a href="#">205</a> |
| Granular Material Class II..... | <a href="#">902</a> |
| Aggregate, 6A.....              | <a href="#">902</a> |
| Geosynthetics.....              | <a href="#">910</a> |

**A. Bridges, Pump Stations, Retaining Walls and Culverts (other than pipe).** Provide granular material Class II for backfilling bridges, pump stations, retaining walls, and culverts other than pipe.

**B. Miscellaneous Structures.** Unless otherwise required, provide sound earth to backfill miscellaneous structures. Miscellaneous structures are structures other than bridges, pump stations, retaining walls, and culverts other than pipe.

### 206.03. Construction.

**A. Foundation Excavation, and Rock Foundation Excavation.** Excavate to allow for foundation unit construction. If shown on the plans or approved by the Engineer, trim the footing excavation to the exact size of the footing and omit the footing forms. For concrete placed on or against an excavated surface other than rock, do not disturb the bottom and side surfaces of the excavation before placing concrete. Excavate to the required grade immediately before concrete placement.

Before placing concrete, check the excavation depth and secure the Engineer's approval of the foundation support material. Place concrete in the absence of free-standing water. Change the elevations for the bottom of footings, as directed by the Engineer to ensure a stable foundation.

If directed by the Engineer, remove and replace unsound material under proposed structures, and replace with Department-approved material. Remove loose fragments, clean, and cut rock surface, or other hard material before placing concrete on required surface. Level, step, or serrate the surface, as directed by the Engineer.

1. **Foundation Excavation.** Excavate materials, including portions of the existing structures, within the foundation excavation limits shown on the plans, except rock foundation excavation.
  2. **Rock Foundation Excavation.** Excavate boulders measuring at least ½ cubic yard and rock or cemented soil in accordance with subsection [205.03.B](#).
- B. Backfill Placement and Compaction.** Place and compact backfill around completed structures.

1. **Placing Backfill.** Provide material for the type of structure requiring backfill in accordance with subsection [206.02](#).

If soil, excavated from the site, meets material requirements, in accordance with subsection [206.02](#), the Contractor may use it to backfill around completed structures.

Do not place backfill against the concrete structure until completion of the required curing, surface finishing, and waterproofing, and the Engineer approves. Cover the inlet of each weep hole with geotextile blanket. Immediately after the Engineer approves the structure, place backfill to protect the structure.

Place backfill evenly around the structure to equalize horizontal loadings. Backfill voids with sound earth, or another Department-approved material.

2. **Compacting Backfill.**
  - a. **Bridges, Pump Stations, Retaining Walls and Culverts (other than pipe).** For bridges, pump stations, retaining walls, and culverts, other than pipe culverts, place backfill material in 6-inch layers. Compact each layer to 100 percent of the maximum unit weight in the load bearing area. The load bearing area is the area within the 1:1 slope, down and away from the outer limits of the bottom of the footing to the bottom of the excavation.

Place backfill behind and around substructure units, between the outer limits of the bottom of the footing and the surface elevation, in layers no greater than 6 inches deep. Compact backfill to at least 95 percent of the maximum unit weight.

Place backfill between the bottom of footing elevation and the bottom of slope paving subbase, in layers no greater than 6 inches deep. Compact to at least 95 percent of the maximum unit weight.

Compact granular material with a moisture content below saturation, as determined by the One Point Cone Chart in the [Density Testing and Inspection Manual](#). If the material contains excess moisture, dry to the required moisture content before compacting.

- b. **Miscellaneous Structures.** For miscellaneous structures, place backfill in 6-inch layers, and compact to at least 95 percent of the maximum unit weight.

The Engineer may approve an increase in the thickness of layers if the Contractor obtains the required compaction results.

#### 206.04. Measurement and Payment.

| <b>Pay Item</b>               | <b>Pay Unit</b> |
|-------------------------------|-----------------|
| Excavation, Fdn.....          | Cubic Yard      |
| Excavation, Rock Fdn.....     | Cubic Yard      |
| Backfill, Structure, CIP..... | Cubic Yard      |
| Backfill, Structure, LM.....  | Cubic Yard      |
| Aggregate, 6A.....            | Cubic Yard      |

A. **Excavation.** The Department does not consider excavation to include removal of ice, water, or liquids. Unless otherwise required, the cost of sheeting, shoring, and dewatering is included in the unit prices for related structure excavation pay items.

1. **Excavation, Foundation.** The Engineer will base payment for **Excavation, Fdn** on plan quantity, in accordance with subsection [109.01.A](#). Unless otherwise shown on the plans, the Engineer will determine the plan quantities using the space bounded by the existing ground surface or exposed portions of the existing substructure, the elevation of the bottom of the foundation, and the 1:1 slopes extending outward and upward from points 18 inches outside the bottom of the footing.

If not shown on the plans, the Department will pay for removal of piling below the bottom of footing elevations, encountered during structure excavation, as extra work.

2. **Excavation, Rock Foundation.** The Engineer will measure **Excavation, Rock Fdn** in its original position for the amount of rock excavated within vertical planes through the footing neat lines. The Engineer will make allowance for overbreak if the Engineer determines it is impractical to excavate to the neat lines of the footing. The Engineer will measure the amount of overbreak by actual cross sections of the footing excavation. Overbreak

allowance is limited to vertical planes 6 inches outside and parallel to the neat lines of the footing, and to a depth of 3 inches below the elevation of the bottom of the footing, as shown on the plans.

Rock foundation excavation does not include removal of portions of existing structures.

**B. Backfill.**

1. **Backfill, Structure, CIP.** The Engineer will base payment for **Backfill, Structure, CIP** on plan quantity, in accordance with subsection [109.01.A](#), regardless of the foundation excavation slope. The Engineer will not measure material placed outside the maximum pay limits shown on the plans.

The Department will pay for granular material Class II used to backfill bridges, pump stations, retaining walls, and culverts other than pipe, as **Backfill, Structure, CIP**.

2. **Sound Earth.** The cost of sound earth used as backfill material for miscellaneous structures is included in the unit prices for related pay items.
3. **Aggregate, 6A.** The Engineer will measure **Aggregate, 6A** by volume, loose measure. The unit price for **Aggregate, 6A** includes the cost of providing, hauling, and placing material at locations directed by the Engineer.

## Section 207. OBLITERATING ROADWAY

**207.01. Description.** This work consists of obliterating existing or temporary roadways, as required by the contract.

Obliterating roadway applies to those portions of the existing or temporary roadway, outside the limits of the new roadway.

**207.02. Materials.** None specified.

**207.03. Construction.** If an existing or temporary roadway is no longer needed for traffic, remove the HMA or concrete pavement and fill ditches and obliterate the roadway, using grading operations. Provide suitable drainage and blend the area with the surrounding ground contours.

Construct natural-appearing obstructions in the old roadway to prevent use by traffic. Break down and bury or remove old structures. If required, scarify the obliterated roadway to mix aggregate surfacing materials with earth, and leave in a smooth condition.

Topsoil, seed, fertilize, and mulch obliterated areas in accordance with section [816](#).

If approved by the Engineer, the Contractor may obliterate the roadway by breaking the pavement to provide drainage and covering to at least 12 inches deep, with Department-approved material provided by the Contractor.

### 207.04. Measurement and Payment.

| Pay Item                 | Pay Unit      |
|--------------------------|---------------|
| Obliterate Old Road..... | Station, Acre |

The Engineer will measure **Obliterate Old Road** along the centerline of the roadway requiring obliteration and outside the limits of the new roadway.

The Engineer will measure the removal of HMA surface as **HMA Surface, Rem** or **Pavt, Rem**, in accordance with subsection [501.04](#) or subsection [204.04](#), respectively, as appropriate. The Engineer will measure the removal of concrete pavement as **Pavt, Rem**, in accordance with subsection [204.04](#).

The Engineer will measure, and the Department will pay for seeding, fertilizer, topsoil surface, and mulch in accordance with section [816](#).

The Department will pay for materials, salvaged from the obliterated roadway and used in the construction of the new roadway, at the unit prices for the pay items.



**Section 208. SOIL EROSION AND SEDIMENTATION CONTROL**

**208.01. Description.** This work consists of installing and maintaining erosion and sedimentation controls to minimize soil erosion and control sediment from leaving the right-of-way and affecting water resources of the State of Michigan and adjacent properties. Complete this work in accordance with this section and the [Soil Erosion and Sedimentation Control \(SESC\) Manual](#). The Department considers the terms “stabilization” and “erosion control measures” as defined in the [SESC Manual](#).

Failure by the Contractor to install and maintain soil erosion controls may result in project shutdown, fines from the MDNRE, or both. The Contractor is responsible for obtaining applicable federal, state, and local permits when disturbing areas outside Department right-of-way or outside Department acquired easement areas.

**208.02. Materials.** Provide materials in accordance with the following:

|   |                     |
|---|---------------------|
| Coarse Aggregate, 6A .....              | <a href="#">902</a> |
| Granular Material Class II .....        | <a href="#">902</a> |
| Dense-Graded Aggregate, 21AA, 22A ..... | <a href="#">902</a> |
| Open-Graded Aggregate, 34R .....        | <a href="#">902</a> |
| Fencing Materials .....                 | <a href="#">907</a> |
| Culvert Pipe .....                      | <a href="#">909</a> |
| Geosynthetics .....                     | <a href="#">910</a> |
| Riprap .....                            | <a href="#">916</a> |
| Heavy Riprap .....                      | <a href="#">916</a> |
| Coarse Aggregate, 3 x 1 .....           | <a href="#">916</a> |
| Cobblestone .....                       | <a href="#">916</a> |
| Temporary Plastic Sheet .....           | <a href="#">916</a> |
| Sand and Stone Bags.....                | <a href="#">916</a> |
| Turbidity Curtain .....                 | <a href="#">916</a> |

**208.03. Construction.**

**A. Area Limitations.** Conduct work to minimize soil erosion.

Limit the area of earth disturbance to 50 stations of dual roadways, or 100 stations of single roadway during clearing and grading. The Engineer may change the limits of exposed surface area based on the Contractor's ability to minimize erosion and prevent offsite sedimentation.

Do not disturb lands and waters outside the limits of earth disturbance, within the right-of-way, without prior approval from the Engineer. Restore Contractor-disturbed areas beyond the plan or Engineer-approved limits at no additional cost to the Department.

Obtain and give the Engineer copies of local, state, or federally required permits before disturbing sites outside the right-of-way, such as borrow, waste or disposal areas, haul roads, or storage sites. Provide temporary and permanent erosion and sedimentation controls in accordance with the permits.

**B. Time Limitations.** Bring grading sections to the final earth grade as soon as possible. Completion of the final earth grade does not include topsoil or other permanent restoration measures. The Engineer will consider the earth grade final and ready for placement of topsoil and permanent soil erosion control measures when the Contractor constructs a slope, channel, ditch, or other disturbed area in accordance with subsection [205.03.N](#). Complete topsoil placement and stabilize slopes, channels, ditches, and other disturbed areas within 5 calendar days after final earth grade with permanent soil erosion control measures. Permanently restore and place topsoil on slopes and ditches within 150 feet of lakes, streams, or wetlands within 24 hours of achieving final earth grade, using permanent soil erosion control measures. Do not prolong trimming, finishing final earth grade, or both, to permanently stabilize the project at one time.

**C. Construction and Maintenance of Erosion and Sedimentation Controls.** Construct temporary or permanent erosion and sedimentation controls in accordance with the [SESC Manual](#), details shown on the plans, or as directed by the Engineer.

Maintain temporary erosion and sedimentation controls as necessary to ensure their effectiveness until stabilization of the disturbed area. Dispose of sediment and debris removed from temporary sedimentation control devices in accordance with subsection [205.03.P](#).

Maintain permanent erosion controls as necessary to ensure their effectiveness until project completion and acceptance. Repair damaged areas, replace lost devices, and remove sediment as required. Dispose of sediment and debris removed from permanent sedimentation control devices in accordance with subsection [205.03.P](#).

- 1. Check Dams.** Install, maintain, and remove check dams across ditches.
- 2. Sediment Traps and Basins.** If directed by the Engineer or shown on the plans, excavate 5 cubic yards or less, for sediment traps, and greater than 5 cubic yards for sediment basins. Maintain, and fill sediment traps or sediment basins.

Prevent the excavated material from eroding into lakes, watercourses, or wetlands. Install required check dams downstream from a trap or basin before excavating the trap or basin.

3. **Filter Bag.** Provide, place and remove, as directed by the Engineer, at least 225 square foot filter bags constructed of geotextile blanket. Pump water from the construction area into the filter bag to filter the water before it enters a watercourse. Install gravel filter berms on the downslope side of the filter bag for additional protection in sensitive areas, or where the Engineer determines the filter bag is not effectively removing the sediment. Place the filter bag in an upland vegetated area, on level ground, above, and as far as possible from watercourse banks. Use one pump discharge hose per filter bag, unless otherwise approved by the Engineer. Use multiple filter bags as necessary to ensure effective filtration. The Engineer must approve the location of the filter bag, before pumping begins. Replace or dispose of the filter bag and its contents when no longer effective or required. Dispose of filter bags in accordance with subsection [205.03.P](#).

The Contractor may discharge silt-free, sediment-free water directly to a watercourse.

4. **Sand and Stone Bags.** Provide, place, maintain, remove, and dispose of sand or stone bags. Use non-contaminated sediment-free materials, approved by the Engineer. The stone from stone bags may remain in place after the required period, if the bags are cut open and the stone spread evenly, as directed by the Engineer.
5. **Silt Fence.** Provide, install, maintain, remove, and dispose of silt fence, consisting of woven geotextile fabric stapled to, and supported by posts. Place material removed from trenching in the silt fence on the upslope side of the silt fence. In areas where water ponds behind the silt fence, provide a stone filter to channel away the water and prevent failure. Silt fence may remain in place after the required period, if directed by the Engineer.
6. **Gravel Filter Berm.** Provide, place, maintain, remove, and dispose of gravel filter berms consisting of coarse aggregate 6A or open-graded aggregate 34R. Do not use gravel filter berm in lieu of a check dam in a ditch.
7. **Inlet Protection, Fabric Drop.** Provide, place, maintain, and remove fabric drop inlet protection devices, as directed by the Engineer. Remove and dispose of accumulated sediment as necessary.

8. **Inlet Protection, Geotextile and Stone.** Provide, place, maintain, remove, and dispose of geotextile blanket, coarse aggregate 6A, or open-graded aggregate 34R, or both, for inlet protection. Remove and dispose of accumulated sediment as necessary.
9. **Inlet Protection, Sediment Trap.** Excavate, provide, maintain, remove, and dispose of sediment traps consisting of geotextile blanket, and coarse aggregate 6A, or open-graded aggregate 34R. Remove and dispose of accumulated sediment as necessary.
10. **Temporary Plastic Sheets or Geotextile Cover.** Provide, place, maintain, remove, and dispose of plastic sheets or geotextile cover. Secure temporary plastic sheets or geotextile cover as directed by the Engineer.
11. **Sand Fence.** Provide, maintain, remove, and dispose of fence to prevent sand from migrating onto roads.
12. **Aggregate Cover.** Provide, place, maintain, remove, and dispose of geotextile separator and dense-graded aggregate 21AA, coarse aggregate 3x1, coarse aggregate 6A or other Engineer-approved material.
13. **Gravel Access Approach.** Provide, place, maintain, remove, and dispose of geotextile separator and coarse aggregate 3x1 or other Engineer approved-material.
14. **Turbidity Curtain.** Provide, install, maintain, remove, and dispose of shallow or deep turbidity curtain at the locations shown on the plans, or as directed by the Engineer.

Use shallow turbidity curtain when the water is no greater than 2 feet deep. Use deep turbidity curtain when the water is greater than 2 feet deep.

Provide a floating or staked turbidity curtain, as required. During removal, minimize sediment loss.

15. **Intercepting Ditch.** Construct and maintain intercepting ditches at the location shown on the plans, or as directed by the Engineer. Remove ditches when directed by the Engineer.

**D. Removal of Erosion and Sedimentation Control Facilities.**

Remove or obliterate temporary erosion and sedimentation controls when the permanent controls are complete and approved, unless otherwise directed by the Engineer. Do not remove temporary controls next to lakes, watercourses, or wetlands until the establishment of turf on the adjacent slopes. Before placing topsoil, permanent seed, and

fertilizer, remove or incorporate mulch, placed for temporary erosion control, into the slope. Minimize erosion and sedimentation into watercourses during removal of erosion controls. Repair damage caused during the removal of erosion controls at no additional cost to the Department.

**208.04. Measurement and Payment.**

| <b>Pay Item</b>  | <b>Pay Unit</b> |
|--|-----------------|
| Erosion Control, Check Dam, Stone .....                          | Foot            |
| Erosion Control, Sediment Trap .....                             | Each            |
| Erosion Control, Sediment Basin .....                            | Cubic Yard      |
| Erosion Control, Filter Bag .....                                | Each            |
| Erosion Control, Sand Bag .....                                  | Each            |
| Erosion Control, Stone Bag .....                                 | Each            |
| Erosion Control, Silt Fence .....                                | Foot            |
| Erosion Control, Gravel Filter Berm .....                        | Foot            |
| Erosion Control, Inlet Protection, Fabric Drop .....             | Each            |
| Erosion Control, Inlet Protection, Geotextile and<br>Stone ..... | Each            |
| Erosion Control, Inlet Protection, Sediment Trap .....           | Each            |
| Erosion Control, Temp Plastic Sheet/Geotextile<br>Cover .....    | Square Yard     |
| Erosion Control, Sand Fence .....                                | Foot            |
| Erosion Control, Aggregate Cover .....                           | Square Yard     |
| Erosion Control, Gravel Access Approach .....                    | Each            |
| Erosion Control, Maintenance, Sediment Removal .....             | Cubic Yard      |
| Erosion Control, Turbidity Curtain, Shallow .....                | Foot            |
| Erosion Control, Turbidity Curtain, Deep .....                   | Foot            |
| Ditch, Intercepting .....  | Station         |

The Department will not pay for repairing or replacing temporary or permanent SESC measures damaged by the Contractor’s negligence. The Department will pay for repairing or replacing temporary or permanent SESC measures damaged by causes other than the Contractor’s negligence, at the contract unit price for the relevant pay items.

**A. Erosion Control, Check Dam, Stone.** The Engineer will measure **Erosion Control, Check Dam, Stone** in place. The unit price for **Erosion Control, Check Dam, Stone** includes the cost of providing, placing, maintaining, and removing the stone check dam.

**B. Erosion Control, Sediment Trap or Basin.**

1. **Erosion Control, Sediment Trap.** The unit price for **Erosion Control, Sediment Trap** includes the cost of excavating, constructing, maintaining, and removing sediment traps.

The Department will pay separately for removing and disposing of accumulated sediment or debris from a sediment trap as **Erosion Control, Maintenance, Sediment Removal**.

2. **Erosion Control, Sediment Basin.** The Engineer will measure **Erosion Control, Sediment Basin** by volume, loose measure. The unit price for **Erosion Control, Sediment Basin** includes the cost of excavating, constructing, maintaining, and removing the sediment basin.

The Department will pay separately for removing and disposing of accumulated sediment or debris from a sediment basin as **Erosion Control, Maintenance, Sediment Removal**.

- C. Erosion Control, Filter Bag.** The unit price for **Erosion Control, Filter Bag** includes the cost of providing, placing, maintaining, and disposing of the filter bag and its contents, and restoring the filter bag site.

The unit price for **Erosion Control, Gravel Filter Berm** includes the cost of gravel filter berm used in conjunction with a filter bag.

- D. Erosion Control, Sand Bag and Erosion Control, Stone Bag.** The Engineer will measure **Erosion Control, Sand Bag** and **Erosion Control, Stone Bag** in place. The unit prices for **Erosion Control, Sand Bag** and **Erosion Control, Stone Bag** include the cost of providing, placing, maintaining, removing, and disposing of the sand or stone bags.

- E. Erosion Control, Silt Fence.** The Engineer will measure **Erosion Control, Silt Fence** in place excluding overlaps. The unit price for **Erosion Control, Silt Fence** includes the cost of providing, installing, maintaining, removing, and disposing of the fence and posts.

The Department will pay separately for removing and disposing of accumulated sediment or debris from behind silt fence as **Erosion Control, Maintenance, Sediment Removal**.

- F. Erosion Control, Gravel Filter Berm.** The Engineer will measure **Erosion Control, Gravel Filter Berm** in place. The unit price for **Erosion Control, Gravel Filter Berm** includes the cost of providing, placing, maintaining, removing, and disposing of the gravel filter berm.

**G. Erosion Control, Inlet Protection.**

1. **Erosion Control, Inlet Protection, Fabric Drop.** The unit price for **Erosion Control, Inlet Protection, Fabric Drop** includes the cost of constructing, maintaining, and removing inlet protection fabric drops.
2. **Erosion Control, Inlet Protection, Geotextile and Stone.** The unit price for **Erosion Control, Inlet Protection, Geotextile and Stone** includes the cost of constructing, maintaining, and removing geotextile and stone inlet protection.
3. **Erosion Control, Inlet Protection, Sediment Trap.** The unit price for **Erosion Control, Inlet Protection, Sediment Trap** includes the cost of excavating, constructing, maintaining, and removing sediment traps for inlet protection.

The Department will pay separately for removing and disposing of accumulated sediment or debris from a sediment trap inlet protection device as **Erosion Control, Maintenance, Sediment Removal**.

**H. Erosion Control, Temporary Plastic Sheet/Geotextile Cover.** The unit price for **Erosion Control, Temporary Plastic Sheet/Geotextile Cover** includes the cost of constructing, maintaining, and removing temporary plastic sheets and geotextile covers.

**I. Erosion Control, Sand Fence.** The Engineer will measure **Erosion Control, Sand Fence** in place. The unit price for **Erosion Control, Sand Fence** includes the cost of constructing, maintaining, and removing sand fence.

**J. Erosion Control, Aggregate Cover.** The unit price for **Erosion Control, Aggregate Cover** includes the cost of constructing, maintaining, and removing aggregate cover.

**K. Erosion Control, Gravel Access Approach.** The unit price for **Erosion Control, Gravel Access Approach** includes the cost of temporary culverts and ditching required to maintain existing drainage courses through or around gravel access approaches, and providing, constructing, maintaining, and removing gravel access approaches.

**L. Erosion Control, Maintenance, Sediment Removal.** The Engineer will measure **Erosion Control, Maintenance, Sediment Removal** by volume, loose measure. The unit price for **Erosion Control, Maintenance, Sediment Removal** includes the cost of removing sediment and debris from erosion and sedimentation control devices, as required by the [SESC Manual](#), and as necessary to ensure their effectiveness.

M. **Erosion Control, Turbidity Curtain.** The Engineer will measure **Erosion Control, Turbidity Curtain, Shallow** and **Erosion Control, Turbidity Curtain, Deep** in place. The unit prices for **Erosion Control, Turbidity Curtain, Shallow** and **Erosion Control Turbidity Curtain, Deep** include the cost of providing, installing, maintaining, and removing turbidity curtains.

The unit price for **Erosion Control, Maintenance, Sediment Removal** includes the cost of removing and disposing of accumulated sediment or debris retained by the turbidity curtain.

N. **Intercepting Ditch.** The Engineer will measure **Ditch, Intercepting** in place along the ditch centerline. The unit price for **Ditch, Intercepting** includes the cost of constructing, maintaining, and removing the intercepting ditch.



**Section 209. PROJECT CLEANUP**

**209.01. Description.** This work consists of removing and disposing of debris; including fences, fallen timber, logs, guardrail sections and posts, rocks, boulders, and other rubbish from the Contractor’s operations within the project limits in accordance with section [201](#) and section [205](#).

**209.02. Materials.** None specified.

**209.03. Construction.** Provide project cleanup as an ongoing operation. Perform project cleanup within the right-of-way, but over an area no greater than 50 feet beyond the limits of earth disturbance for the length of the project.

Fill holes and ruts, resulting from construction operations, with Department-approved material. Compact and level filler materials and restore ruts and holes to the surrounding contour in accordance with section [816](#), or as directed by the Engineer.

Clean existing culverts, sewers, or drainage structures that contain sediment or debris from the construction operation.

**209.04. Measurement and Payment.**

| <b>Pay Item</b>       | <b>Pay Unit</b> |
|-----------------------|-----------------|
| Project Cleanup ..... | Lump Sum        |

The Department will pay for **Project Cleanup** upon completion of the cleanup operation. If the contract does not include a pay item for **Project Cleanup**, the Department will consider the cost of this work to be included in the contract unit prices for other relevant pay items.

### DIVISION 3 – BASES

| <b>Section</b> | <b>Title</b>                                      | <b>Page No.</b>     |
|----------------|---|---------------------|
| 301            | Subbase.....                                      | <a href="#">161</a> |
| 302            | Aggregate Base Course .....                       | <a href="#">162</a> |
| 303            | Open-Graded Drainage Courses .....                | <a href="#">165</a> |
| 304            | Rubblizing Portland Cement Concrete Pavement..... | <a href="#">166</a> |
| 305            | HMA Base Crushing and Shaping.....                | <a href="#">170</a> |
| 306            | Aggregate Surface Course .....                    | <a href="#">173</a> |
| 307            | Aggregate Shoulders and Approaches .....          | <a href="#">176</a> |
| 308            | Geotextile for Base .....                         | <a href="#">180</a> |

## NOTES

## Section 301. SUBBASE

**301.01. Description.** This work consists of constructing a granular subbase on a surface approved by the Engineer.

**301.02. Materials.** Provide material in accordance with the following:

Granular Material Class II..... [902](#)

**301.03. Construction.** Spread the subbase material evenly and compact to at least 95 percent of the maximum unit weight, at a less-than-optimum moisture content, for its entire thickness. Place the subbase in one layer if the compacted depth is less than 15 inches. Where the required depth is more than 15 inches, place the material in layers of equal thickness. Construct the subbase to plan grade within a tolerance of plus 1 inch.

Do not place subbase on frozen, soft, unstable, or rutted subgrade. If subbase material becomes mixed with subgrade material, remove, dispose of, and replace the subbase material at no additional cost to the Department.

**301.04. Measurement and Payment.**

| <b>Pay Item</b>    | <b>Pay Unit</b> |
|--------------------|-----------------|
| Subbase, LM .....  | Cubic Yard      |
| Subbase, CIP ..... | Cubic Yard      |

A. **Subbase, LM.** The Engineer will measure **Subbase, LM** based on hauling unit dimensions and load count before placement and compaction. The unit price for **Subbase, LM** includes the cost of providing, hauling, placing, compacting, and shaping the material.

B. **Subbase, CIP.** The Engineer will measure **Subbase, CIP** by the staked-section method as described in subsection [205.04](#). The unit price for **Subbase, CIP** includes the cost of providing, hauling, placing, compacting, and shaping the material.

## Section 302. AGGREGATE BASE COURSE

**302.01. Description.** This work consists of constructing an aggregate base course on a surface approved by the Engineer.

**302.02. Materials.** Provide materials in accordance with the following:

Dense-Graded Aggregate 21AA, 21A, 22A..... [902](#)

Provide aggregate meeting the aggregate series shown on the plans.

**302.03. Construction.**

**A. Placing and Compacting.** Provide a ticket with each load, stating the following information:

1. Project number,
2. Aggregate source,
3. Aggregate series,
4. Date,
5. Time,
6. Truck identifier number,
7. Supplier name, and
8. Type of aggregate approval.

If the contract requires payment by weight, ensure the ticket includes the gross weight, tare weight, and net weight to the nearest 100 pounds. Determine the truck tare weight at least twice daily.

If the contract does not require payment by weight, the Engineer may accept written documentation in lieu of tickets. Written documentation must identify the pay item of the material and include all information listed above except time and truck identifier number.

Provide and place aggregate with a uniform gradation, free of contamination and segregation. Do not place aggregate base on frozen, soft, unstable or rutted subgrade, subbase, or aggregate base. Do not rut or distort the subbase material or aggregate base during spreading.

The Contractor may use additives to facilitate compaction, shaping, and maintenance of the aggregate surface.

Compact the aggregate layers to a uniform thickness, no greater than 6 inches. Compact each layer of aggregate base to at least 98 percent of the maximum unit weight at a moisture content no greater than optimum for aggregate base under hot mix asphalt pavement. Compact each layer of aggregate base to at least 95 percent of the maximum unit weight at a moisture content no greater than optimum for aggregate base under concrete pavement.

Shape the finished surface and the layer thickness to within  $\pm\frac{1}{2}$  inch of the crown and grade shown on the plans.

If placing aggregate base in a layer no greater than 3 inches, compact using pneumatic-tired rollers or vibratory compactors to at least 95 percent of the maximum unit weight at a moisture content no greater than optimum.

Remove, dispose of, and replace aggregate base material that mixes with subbase or subgrade material, at no additional cost to the Department.

**B. Conditioning Aggregate Base.** Shape the finished surface of the existing aggregate base course to within  $\pm\frac{1}{2}$  in of the grade and cross section shown on the plans. Provide additional aggregate to address irregularities and obtain the required grade or cross section.

To correct surface irregularities or to add more material, mix the loose and compacted materials to at least 2 inches deep and recompact. Compact the aggregate base as specified in subsection [302.03.A](#).

**C. Maintenance During Construction.** Maintain the aggregate base course layer at the required line, grade, and cross section until placement of the next layer. Ensure the exposed aggregate base course layer remains smooth, compacted, and uncontaminated.

If the subgrade, subbase, or aggregate base is damaged due to the Contractor's operations or construction traffic, restore to the required condition at no additional cost to the Department.

#### **302.04. Measurement and Payment.**

| <b>Pay Item</b>                   | <b>Pay Unit</b>      |
|-----------------------------------|----------------------|
| Aggregate Base.....               | Ton                  |
| Aggregate Base, LM.....           | Cubic Yard           |
| Aggregate Base, __ inch .....     | Square Yard          |
| Aggregate Base, Conditioning..... | Station, Square Yard |

**A. Aggregate Base.** The Engineer will determine the moisture content and pay weights in accordance with section [109](#).

The Engineer will measure **Aggregate Base** by the scale weight of the material, including admixtures, and moisture content no greater than 6 percent.

The Engineer will perform moisture tests at the start of weighing operations and if construction operations, weather conditions, or other causes may change the moisture content of the material. If tests indicate a moisture content greater than 6 percent, the Engineer will deduct the

weight of the excess moisture from the scale weight of the aggregate until moisture tests indicate the moisture content is no greater than 6 percent.

**B. Aggregate Base, LM.** The Engineer will measure **Aggregate Base, LM** based on hauling unit dimensions and load count, before placement and compaction. The unit price for **Aggregate Base, LM** includes the cost of providing, hauling, placing, compacting, and shaping the material, and providing water for compaction.

**C. Aggregate Base, \_\_ inch.** The Engineer will measure **Aggregate Base, \_\_ inch** by width and length, for the specified depth, as shown on the plans.

**D. Aggregate Base, Conditioning.** If the contract requires payment for **Aggregate Base, Conditioning** in station pay units, the Engineer will measure along the construction centerline of the roadway.

If the contract requires payment for **Aggregate Base, Conditioning** in area pay units, the Engineer will measure by the width and length shown on the plans.

If the contract does not include the pay item **Aggregate Base, Conditioning**, the Department will consider the cost of conditioning aggregate base and providing additives and water for compaction and maintenance, to be included in other aggregate base pay items.

**Section 303. OPEN-GRADED DRAINAGE COURSES**

**303.01. Description.** This work consists of constructing an Open-Graded Drainage Course (OGDC), as required by the contract, on a surface approved by the Engineer.

**303.02. Materials.** Provide Open-Graded Aggregate 4G as required by the contract.

**303.03. Construction.** Provide and install the separation treatment for the OGDC, as shown on the plans, between the OGDC and the subbase or subgrade. Place the OGDC as required by the contract.

**303.04. Measurement and Payment.** The Engineer will measure and the Department will pay for OGDC according to the contract.



**Section 304. RUBBLIZING PORTLAND CEMENT CONCRETE PAVEMENT**

**304.01. Description.** This work consists of preparing, shattering, compacting reinforced or non-reinforced Portland Cement Concrete (PCC) pavement to provide a rubblized base, and disposing of excess and deleterious material in accordance with subsection [205.03.P](#).

**304.02. Materials.** Provide material in accordance with the following:

Dense-Graded Aggregate 21AA ..... [902](#)

**304.03. Construction.**

**A. Equipment.** Use an Engineer-approved water system to suppress dust generated from pavement shattering operations.

For rubblizing pavement, use one of the following types of self-contained, self-propelled pavement breaking equipment:

1. Resonant frequency equipment producing a low amplitude breaking force; or
2. Multiple impact hammer equipment, capable of lifting and falling in an independent, adjustable, random sequence with variable force of impact.

If using impact hammer equipment, the number and spacing of hammers may vary. Ensure the weights of individual hammers do not destroy the integrity of layers within 24 inches below the rubblized pavement.

**B. Preparation Work.** Before beginning pavement rubblizing, complete all of the following:

1. Saw cut a relief joint full depth where rubblizing abuts concrete pavement required to remain or will be rubblized in a later stage.
2. Match the elevation of pavement widening or shoulders to the adjacent pavement requiring rubblizing.
3. Complete construction of drainage systems for the new pavement structures, including outlet endings. Backfill and compact to the existing grade to prevent damage to the drainage system.
4. Remove pavement shown on the plans or directed by the Engineer, over utilities or pipes with less than 18 inches of granular material cover, as measured from the bottom of the pavement to the top of the utility or pipe. Extend the limits for pavement removal 3 feet beyond each side of utility or pipe. Backfill the removal area with filler aggregate, in layers no greater than 6 inches, and compact.
5. Remove loose patching material before rubblizing, as directed by the Engineer. Do not fill voids before rubblizing.

C. **Quality Control Checks.** Perform all of the following field checks and provide same day documentation of field checks to the Engineer:

1. At the start and during rubblizing operations, establish, demonstrate, and document equipment capabilities, including the speed and impact frequency.
2. At least once per lane, and every 1,500 feet, inspect the rubblized pavement to determine if the rubblizing operation has de-bonded the reinforcement from the concrete and is achieving the particle size specified in subsection [304.03.F](#).

Mechanically excavate an area of 25 square feet through the full depth of the pavement, taking care not to further rubblize. Location of the check will be determined by the Engineer. Notify the Engineer at least 2 hours before excavation to allow verification of results for acceptance.

If the Engineer directs, perform spot inspections to the top of reinforcement, using manual methods. Considerable physical effort must be expended to inspect rubblized material by manual excavation. Use a shovel or pick to excavate an area of 25 square feet. Use a geologist pick or mason hammer to separate the concrete pieces above the reinforcing mat. Remove as much material as possible and clean the remaining surface with a stiff-bristled broom or brush to expose the reinforcing mat. The Department considers the mat de-bonded if at least 80 percent of the mat is visible after excavation and sweeping.

If performing inspection using manual methods, sound concrete below the reinforcing mat to determine if material is fractured.

Restore inspection sites with filler aggregate and compact. The Engineer may adjust the inspection frequency.

3. Ensure the completed rubblized surface has a uniform appearance with no unbroken strips of pavement, exposed reinforcement, or visible joint filler and Hot Mix Asphalt (HMA) patching material.

D. **Compaction.** Before placing the HMA mixture, compact the rubblized pavement with vibratory steel-wheeled and pneumatic-tired rollers in the following sequence:

1. At least two passes with a Z-grid vibratory roller, or steel drum roller, as approved by the Engineer;
2. A third pass, and subsequent passes, with a pneumatic-tired roller; and
3. A final pass just before HMA placement with a pneumatic-tired roller.

The Department considers a pass, down and back in the same path.

Provide rollers with a nominal gross weight of at least 10 ton. Operate vibratory rollers in a high vibration mode and at a speed no greater than 6 feet per second, unless otherwise limited by the condition of the base, subbase, subgrade, or drainage features.

The Contractor may apply water if the Engineer approves. Avoid rehydrating cementitious materials.

After compaction and before placing HMA, ensure the finished surface varies no more than  $\pm 1$  inch, when tested with a 10-foot straightedge. Fill voids and depressions with filler aggregate and compact.

**E. Miscellaneous.** Do not allow vehicular traffic on the rubblized pavement before HMA placement, unless otherwise required for construction and maintenance of traffic, as approved by the Engineer. Maintain the compaction of portions of the rubblized pavement, with no exposed reinforcement, for crossroad or ramp traffic.

In part-width construction areas, rubblize the pavement to the limits of the required overlay for that stage. Saw cut the longitudinal joint deep enough to cut the tie bar, unless rubblizing extends beyond the centerline and past the tie bar.

Avoid damaging items required to remain, including drainage structures and monument boxes.

**F. Acceptance Criteria.** The Engineer will observe quality control checks described in subsection [304.03.C](#) and base acceptance on the following criteria:

1. PCC pavement shattered to full-depth;
2. Non-reinforced PCC pavement and concrete pavement patches reduced to unbound particles with a nominal diameter less than 10 inches;
3. Reinforced PCC pavement and concrete pavement patches, above the reinforcement, reduced to unbound particles with a nominal diameter from 2 inches to 6 inches;
4. Reinforced PCC pavement and concrete pavement patches, below reinforcement, exhibit sporadic particles greater than 10 inches, provided the Engineer verifies de-bonding of reinforcement near the particle;
5. No oversized particles at the surface for PCC pavements;
6. De-bonding of reinforced pavement achieved, if the required particle size is met;

7. Exposed reinforcement has been cut off below the surface and removed. Embedded reinforcement may remain in place;
8. No visible joint sealant or HMA patching material on the compacted surface and voids filled with filler aggregate;
9. Joints, and cracks greater than ¼ inch wide at the surface not distinguishable; and
10. No displacement of underlying base, subgrade, or underdrains.

#### 304.04. Measurement and Payment.

| <b>Pay Item</b>         | <b>Pay Unit</b> |
|-------------------------|-----------------|
| Pavt, Rubblize .....    | Square Yard     |
| Aggregate, Filler ..... | Ton             |
| Saw Cut, Rubblize ..... | Foot            |

A. **Rubblized Pavement.** The unit price for **Pavt, Rubblize** includes the cost of the following:

1. Required quality control work;
2. Rubblizing;
3. Dust suppression, including water;
4. Removing joint fillers and patching material;
5. Cutting exposed steel, loading, hauling, and disposing of the steel and immediate restoration of disturbed rubblized concrete;
6. Breaking down or removing and disposing of oversized pavement pieces;
7. Disposing of material removed from inspection areas; and
8. Maintaining the condition of the rubblized pavement until placement of the HMA pavement.

B. **Filler Aggregate.** The unit price for **Aggregate, Filler** includes the cost of producing, delivering, placing, leveling, and compacting the aggregate in rubblized pavement.

C. **Saw Cut, Rubblize.** The unit price for **Saw Cut, Rubblize** includes the cost of cutting a relief joint full depth where the rubblizing abuts concrete pavement, required to remain, or removed for other purposes, and cutting the longitudinal joint where necessary.

The Department will pay for concrete pavement removal separately as **Pavt, Rem**, in accordance with section [204](#).

**Section 305. HMA BASE CRUSHING AND SHAPING**

**305.01. Description.** This work consists of constructing new aggregate base from existing flexible pavement.

**305.02. Materials.** Provide material in accordance with the following:

Dense-Graded Aggregate 21A, 21AA, 22A..... [902](#)

**305.03. Construction.** Crush and shape Hot Mix Asphalt (HMA) to the depth and width shown on the plans. The plans will also show construction staging and shoulder treatment. Obtain the Engineer’s approval for the initial surfacing course HMA mix design before crushing begins.

**A. Equipment Requirements.** Provide a self-propelled rotary reduction crushing machine capable of crushing the pavement to the size required by the contract and mixing the crushed material with the underlying aggregate base to the required depth.

Use a water sprinkling system approved by the Engineer to suppress dust generated from pavement crushing operations.

Provide final grading equipment that includes automatic cross slope and crown control and an automated grade referencing system for longitudinal control.

**B. Crushing and Grading.** Unless otherwise required, reference the longitudinal crushed grade from the existing pavement surface or the new HMA pavement surface.

The Contractor may blade the existing shoulder asphalt or seal coat material onto the mainline pavement before crushing.

Uniformly crush existing asphalt pavement, including 1 inch to 2 inches of the aggregate base, to the required width and depth. Ensure 95 percent of the crushed material has a maximum particle size of 1½ inches, and the remaining 5 percent contains no particles larger than 4 inches.

Uniformly spread and compact the crushed material to the dimensions shown on the plans. Use salvaged crushed material, if available, or dense-graded aggregate to add material to attain the plan grade or cross section. Spread added aggregate uniformly before crushing or place aggregate on the crushed surface and remix to the full crushed depth.

**C. Compacting and Shaping.** Compact the crushed material to at least 98 percent of the maximum unit weight, at no greater than optimum

moisture content, in accordance with the Michigan Modified T 180 Test in the [Density Testing and Inspection Manual](#).

Repair base destabilized by over watering or non-uniform water application, damaged by Contractor operations, or from maintaining traffic, at no additional cost to the Department.

**D. Excess Crushed Material.** The Contractor may use excess crushed material as aggregate base or aggregate shoulder.

**E. Weather Limitations.** Do not crush HMA pavement if anticipated precipitation may destabilize the prepared base. Crush and shape HMA base in accordance with the seasonal limitations specified in section [501](#).

**F. Acceptance Criteria.** The Engineer will inspect crushing and shaping work and base acceptance on all of the following criteria:

1. Crushed material meets particle size requirements;
2. After final shaping, the surface does not vary by more than ½ inch, when tested with a 10-foot straightedge;
3. Immediately before paving, undulations or variations are corrected to meet the criteria in subsection [305.03.B](#) and subsection [305.03.C](#); and
4. Required density is maintained until the HMA surface material application.

### **305.04. Measurement and Payment.**

| <b>Pay Item</b>                                | <b>Pay Unit</b> |
|--|-----------------|
| HMA Base Crushing and Shaping.....             | Square Yard     |
| Material, Surplus and Unsuitable, Rem, LM..... | Cubic Yard      |
| Salv Crushed Material, LM .....                | Cubic Yard      |

**A. HMA Base Crushing and Shaping.** The Engineer will base payment for **HMA Base Crushing and Shaping** on plan quantity, in accordance with subsection [109.01.A](#), regardless of any variation in depth.

The unit price for **HMA Base Crushing and Shaping** includes the cost of water to obtain the required density, and scarifying, crushing, grading, shaping, rolling, and compacting existing HMA.

**B. Excess Crushed Material.** The Department will only pay for **Salv Crushed Material, LM** for use in other items of work if excess crushed material requires loading and hauling.

The Engineer will measure, and the Department will pay for excess material loaded and hauled from locations on the project to attain the plan grade or cross section, in the final location as **Salv Crushed**

**Material, LM** or as shoulder or approach material in accordance with subsection [307.04](#).

C. **Material, Surplus and Unsuitable, Remove, LM.** The Department will only pay for **Material, Surplus and Unsuitable, Rem, LM** if the Contractor removes material from the project site and disposes in accordance with subsection [205.03.P](#).

D. **Trenching.** The Department will pay separately for Trenching, in accordance with subsection [307.04](#).

E. **Aggregate.** The Department will pay separately for additional aggregate as **Aggregate Base**, in accordance with subsection [302.04](#). If **Aggregate Base** is not included in the contract, the Department will pay for additional aggregate as extra work.

## Section 306. AGGREGATE SURFACE COURSE

**306.01. Description.** This work consists of constructing aggregate surface course on a prepared subgrade or existing aggregate surface.

**306.02. Materials.** Provide materials in accordance with the following:

|  |                     |
|--|---------------------|
| Dense-Graded Aggregate 21A, 21AA, 22A, 23A ..... | <a href="#">902</a> |
| Salvaged Aggregate .....                         | <a href="#">902</a> |

Provide Aggregate 21A, 21AA, or 22A if the plans show aggregate surface course later receiving a paved surface. Provide Aggregate 23A if the plans show construction of aggregate surface without a paved surface. Provide Dense-Graded Aggregate 21A, 21AA, 22A, 23A, or salvaged aggregate for temporary maintenance gravel.

**306.03. Construction.**

**A. Preparation of Base.** When required, blade, or scarify and blade, existing aggregate surfaces to remove irregularities in the grade.

**B. Placing and Compacting.** Provide a ticket with each load, stating the following information:

1. Project number,
2. Aggregate source,
3. Aggregate series,
4. Date,
5. Time,
6. Truck identifier number,
7. Supplier name, and
8. Type of aggregate approval.

If the contract requires payment by weight, ensure the ticket includes gross weight, tare weight, and net weight to the nearest 100 pounds. Determine the truck tare weight at least twice daily.

If the contract does not require payment by weight, the Engineer may accept written documentation in lieu of tickets. Written documentation must identify the pay item of the material and include all information listed above except time and truck identifier number.

Provide a uniform aggregate mixture, compacted in place to a uniform density full depth. Provide a complete surface course to the line, grade, or cross section shown on the plans.

Place maintenance gravel to provide a flush transition between shoulders, driveways and other areas for maintenance of traffic. If



approved by the Engineer, the Contractor may leave maintenance gravel in place as part of the work.

Do not place aggregate on unstable base, as determined by the Engineer. Maintain the aggregate in a smooth, stable condition and provide dust control until removed or surfaced.

Compact the aggregate layers to a uniform thickness, no greater than 6 inches. If placing HMA surface over the aggregate surface course, compact each aggregate layer to at least 98 percent of the maximum unit weight at a moisture content no greater than optimum. For other aggregate surface course applications, compact each layer of aggregate to at least 95 percent of the maximum unit weight, at a moisture content no greater than optimum.

Shape the finished surface and layers to within ±½ inch of the crown and grade shown on the plans.

If placing aggregate base in a layer no greater than 3 inches, compact using pneumatic-tired rollers or vibratory compactors to at least 95 percent of the maximum unit weight at a moisture content no greater than optimum.

C. **Use of Additives.** The Contractor may use additives to facilitate compaction and for dust control.

**306.04. Measurement and Payment.**

| <b>Pay Item</b>                       | <b>Pay Unit</b> |
|---------------------------------------|-----------------|
| Aggregate Surface Cse, ___ inch ..... | Square Yard     |
| Aggregate Surface Cse .....           | Cubic Yard, Ton |
| Maintenance Gravel, LM .....          | Cubic Yard      |
| Maintenance Gravel .....              | Ton             |

A. **Aggregate Surface Course.** The Engineer will measure **Aggregate Surface Cse, \_\_\_ inch** by the width and length shown on the plans.

The Engineer will determine the moisture content and pay weights as specified in section [109](#).

If the contract requires weight measurement, the Engineer will measure **Aggregate Surface Cse** by the scale weight, including additives, at a moisture content no greater than 6 percent.

The Engineer will perform moisture tests at the start of weighing operations and when construction operations, weather conditions, or other causes may change the moisture content of the material. If tests indicate a moisture content greater than 6 percent, the Engineer will deduct the weight of the excess moisture from the scale weight of the

aggregate until moisture tests indicate the moisture content is no greater than 6 percent.

The unit price for **Aggregate Surface Cse**, \_\_ inch and **Aggregate Surface Cse**, includes the cost of additives and water.

B. **Maintenance Gravel**. The Engineer will measure **Maintenance Gravel, LM** based on hauling unit dimensions and load count, before placement and compaction. The unit price for **Maintenance Gravel, LM** includes the cost of constructing, maintaining, and removing the aggregate surface.

The Engineer will measure **Maintenance Gravel** in tons by the scale weight of the material. The Engineer will perform moisture tests at the start of weighing operations and if construction operations, weather conditions, or other causes may change the moisture content of the material. If tests indicate a moisture content greater than 6 percent, the Engineer will deduct the weight of the excess moisture from the scale weight of the maintenance gravel until moisture tests indicate the moisture content is no greater than 6 percent.

## Section 307. AGGREGATE SHOULDERS AND APPROACHES

**307.01. Description.** This work consists of constructing aggregate shoulders or approaches on a prepared subgrade or existing aggregate surface.

**307.02. Materials.** Provide material in accordance with the following:

|  |                     |
|--|---------------------|
| Dense-Graded Aggregate 21A, 21AA, 22A, 23A ..... | <a href="#">902</a> |
| Salvaged Aggregate .....                         | <a href="#">902</a> |

Provide the following aggregate grades for the class of shoulders and approaches required by the contract documents:

- A. For Class I, provide Aggregate 22A;
- B. For Class I requiring a paved surface, provide Aggregate 21A, 21AA or 22A;
- C. For Class II, provide Aggregate 23A;
- D. For Class III, provide salvaged aggregate or Aggregate 23A; and
- E. For Class IV shoulders, provide existing shoulder material.

For salvaged materials, provide Engineer-approved salvaged aggregate or other material from existing roads or stockpile. Remove particles larger than 2 inches from borrow or salvaged materials and dispose of in accordance with subsection [205.03.P](#).

### 307.03. Construction.

**A. Trenching.** Excavate, shape, and compact trenches to the width and depth required. For trenches under Hot Mix Asphalt (HMA), compact the bottom of the trench to at least 98 percent of the maximum unit weight at no greater than optimum moisture content. Compact the bottom of other trenches to 95 percent of the maximum unit weight. The Engineer may allow 95 percent if 98 percent of maximum unit weight cannot be achieved.

Take ownership of trenched material and dispose in accordance with subsection [205.03.P](#) at no additional cost to the Department.

Place and maintain traffic control devices in accordance with section [812](#), in shoulder areas that cannot be backfilled and compacted the same day. Bring shoulder material flush with existing pavement the next calendar day.

**B. Constructing Shoulders and Approaches.** Provide a ticket with each load stating the following information:

- 1. Project number,
- 2. Aggregate source,

3. Aggregate series,
4. Date,
5. Time,
6. Truck identifier number,
7. Supplier name, and
8. Type of aggregate approval.

If the contract requires payment by weight, ensure the ticket includes the gross weight, tare weight, and net weight to the nearest 100 pounds. Determine the truck tare weight at least twice daily.

If the contract does not require payment by weight, the Engineer may accept written documentation in lieu of tickets. Written documentation must identify the pay item of the material and include all information listed above except time and truck identifier number.

Provide aggregate with a uniform gradation, free of contamination and segregation when placed. Do not place aggregate shoulder and approach material on frozen, soft, unstable, or rutted subgrade, subbase, or aggregate base.

The Contractor may use additives to facilitate compaction, shaping, and maintenance.

Scarify the existing surface full-width to at least 2 inches deep if adding aggregate material.

Do not rut or distort the subbase material or aggregate base during spreading. Place and compact material without damaging adjacent paved surfaces. Maintain aggregate material in a smooth, stable condition, and provide dust control.

Maintain compacted aggregate flush with each layer of placed HMA.

Grade aggregate material to provide drainage off the shoulder.

**C. Density Requirements.** If placing material in a layer no greater than 3 inches compact using pneumatic-tired rollers or vibratory compactors.

1. **Class I Shoulders and Approaches.** Compact Class I shoulders and approaches to at least 98 percent of the maximum unit weight at no greater than optimum moisture content.
2. **Class II and Class III Shoulders and Approaches.** Compact Class II and Class III shoulders and approaches to at least 95 percent of the maximum unit weight at no greater than optimum moisture content.

3. **Class IV Shoulders.** Compact Class IV shoulders to at least 95 percent of the maximum unit weight at no greater than optimum moisture content.

D. **Excess or Unsuitable Aggregate Material.** The Contractor may use excess or unsuitable aggregate in fills in accordance with section [205](#).

Take ownership and dispose of unused material in accordance with subsection [205.03.P](#) at no additional cost to the Department.

**307.04. Measurement and Payment.**

| <b>Pay Item</b>                | <b>Pay Unit</b> |
|--------------------------------|-----------------|
| Trenching.....                 | Station         |
| Shoulder, CI _____             | Ton             |
| Shoulder, CI __, LM.....       | Cubic Yard      |
| Shoulder, CI __, CIP.....      | Cubic Yard      |
| Shoulder, CI __, __ inch ..... | Square Yard     |
| Approach, CI _____             | Ton             |
| Approach, CI __, LM.....       | Cubic Yard      |
| Approach, CI __, CIP.....      | Cubic Yard      |
| Approach, CI __, __ inch ..... | Square Yard     |

A. **Trenching.** The Engineer will measure **Trenching** along each pavement edge.

The unit price for **Trenching** includes the cost of trenched aggregate reused in shoulders or approaches that does not require loading and hauling.

The Engineer will measure **Shoulder, CI III, LM** and **Approach, CI III, LM** at the final point of delivery. The Department will pay for trenched aggregate, that is reused in shoulders or approaches, which requires loading and hauling, as **Shoulder, CI III, LM** and **Approach, CI III, LM**.

The Engineer will measure and the Department will pay for trenched aggregate, reused in fills, as Embankment in accordance with subsection [205.04](#).

B. **Shoulder and Approach.** If the contract requires the Engineer to measure shoulder or approach contract items by weight, the Engineer will use the scale weight, including additives, unless the moisture content is greater than 6 percent. The Engineer will perform moisture tests at the start of weighing operations and if construction operations, weather conditions, or other causes may change the moisture content. If tests indicate a moisture content greater than 6 percent, the Engineer will deduct the weight of the excess moisture from the scale weight of the

aggregate until moisture tests indicate the moisture content is no greater than 6 percent. The Engineer will determine of the aggregate moisture content and pay weights in accordance with section [109](#).

If the contract requires the Engineer to measure shoulder or approach contract items by area, the Engineer will make longitudinal measurement parallel to the center line. The Engineer will use the transverse dimensions shown on the plans.

If the contract requires the Engineer to measure shoulder or approach contract items by volume in place, The Engineer will use the lines and dimensions shown on the plans to measure volumes, compacted in place.

The Engineer will measure shoulder or approach, loose measure pay items based on hauling unit dimensions and load count, before placement and compaction. The unit prices for shoulder and approach loose measure pay items include the cost of providing, hauling, placing, compacting, and shaping the material.

C. **Water.** The cost to provide and apply water to facilitate placement or compaction is included in the unit prices for related items of work.

**Section 308. GEOTEXTILES FOR BASE**

**308.01. Description.** This work consists of providing and installing Geotextile products on a surface approved by the Engineer.

**308.02. Materials.** Provide material in accordance with the following:

|                                |                     |
|--------------------------------|---------------------|
| Geotextile Separator.....      | <a href="#">910</a> |
| Stabilization Geotextile ..... | <a href="#">910</a> |

**308.03. Construction.**

**A. Geotextile Placement.** Place or install Geotextile Separator or Stabilization Geotextile products in accordance with the manufacturer’s installation guidelines and this subsection.

Do not operate equipment required to place backfill directly on geotextile products. Eliminate wrinkles or waves that develop during placement. Place the products in direct contact with the soil below before placing backfill on the geotextile products.

Shingle-lap longitudinal and transverse joints at least 2 feet, or seam the joints in accordance with the manufacturer’s recommendations. Ensure field or factory seams meet the minimum grab tensile strength for the product application. Place seams facing upward for inspection purposes. Repair tears or damage to the geotextile in accordance with the manufacturer’s recommendations.

**B. Aggregate or Granular Material Placement.** Spread and grade the first layer of aggregate or granular material after placing geotextile to create a stable work platform before compaction. Place additional aggregate or granular material, as required, and compact. Fill ruts with additional aggregate or granular material and compact before placing each subsequent layer.

**308.04. Measurement and Payment.**

| <b>Pay Item</b>                 | <b>Pay Unit</b> |
|---------------------------------|-----------------|
| Geotextile, Separator.....      | Square Yard     |
| Geotextile, Stabilization ..... | Square Yard     |

The Engineer will measure **Geotextile, Separator** and **Geotextile, Stabilization** in place, to the limits shown on the plans.

The cost of aggregate or granular material, including additional quantities required to fill ruts, is included in the unit prices for related pay items.

## DIVISION 4 – DRAINAGE FEATURES

| <b>Section</b> | <b>Title</b>                                      | <b>Page No.</b>     |
|----------------|---|---------------------|
| 401            | Pipe Culverts .....                               | <a href="#">183</a> |
| 402            | Storm Sewers .....                                | <a href="#">193</a> |
| 403            | Drainage Structures .....                         | <a href="#">202</a> |
| 404            | Underdrains .....                                 | <a href="#">210</a> |
| 405            | Pump Station Construction .....                   | <a href="#">216</a> |
| 406            | Precast Three-Sided, Arch, and Box Culverts ..... | <a href="#">217</a> |



## NOTES

## Section 401. PIPE CULVERTS

**401.01. Description.** This work consists of constructing pipe culverts of the size and class required, including excavation and backfill.

**401.02. Materials.** Provide materials in accordance with the following:

|  |                            |
|--|----------------------------|
| Concrete, Grade S2.....                      | <a href="#"><u>701</u></a> |
| Mortar, Type R-2 .....                       | <a href="#"><u>702</u></a> |
| Granular Material, Class II, III, IIIA ..... | <a href="#"><u>902</u></a> |
| Aggregate, 6A,17A,34R.....                   | <a href="#"><u>902</u></a> |
| Asphaltic Materials .....                    | <a href="#"><u>904</u></a> |
| Culvert Pipe .....                           | <a href="#"><u>909</u></a> |
| Sealers for Culvert Joints .....             | <a href="#"><u>909</u></a> |
| Steel Pipe (for jacking in place) .....      | <a href="#"><u>909</u></a> |
| Drainage Marker Post.....                    | <a href="#"><u>909</u></a> |
| Geosynthetic.....                            | <a href="#"><u>910</u></a> |
| Culvert, Downspouts .....                    | <a href="#"><u>909</u></a> |

Select pipe sections and joint assemblies for use in culverts from the Qualified Products List.

Provide grout for jacked in place steel pipe that consists of a mixture of portland cement and no greater than 50 percent sand by volume.

**A. Pipe Culverts.** Pipe culverts are divided into six classes as shown in Table 401-1.

If the contract only shows the size and class of the culvert, select and provide a culvert pipe specified in Table 401-1.

If a particular type of culvert material is required, instead of the classes designated in Table 401-1, the contract will indicate the type and size of the culvert.

The Engineer will allow the substitution of a higher strength or greater thickness of culvert for the minimum strength or thickness required.

**Table 401-1  
Pipe Alternates for Culvert Classes**

| Type of Pipe<br>Depth of Cover (ft) (a)              | Class A<br>Culvert<br>0-10 (l) | Class B<br>Culvert<br>>10-16 | Class C<br>Culvert<br>>16-23 | Class D<br>Culvert<br>>23-33 (i) | Class E<br>Culvert<br>0-3 (b) | Class F<br>Drive<br>Culvert (c) |
|--|--------------------------------|------------------------------|------------------------------|----------------------------------|-------------------------------|---------------------------------|
| Reinforced Concrete Pipe (d)                         | II                             | III                          | IV                           | V                                | IV                            | II                              |
| Nonreinforced Concrete Pipe (e)                      | 1                              | 3                            | No                           | No                               | No                            | 1, 3 (f)                        |
| Corrugated and Spiral Ribbed Al-<br>Alloy Pipe       | Yes                            | Yes                          | Yes                          | Yes                              | No                            | Yes                             |
| Corrugated and Spiral Ribbed<br>Steel Pipe           | Yes                            | Yes                          | Yes                          | Yes                              | No                            | Yes                             |
| Smooth-Lined Corrugated<br>Plastic Pipe (CPE) (g, j) | Yes (h)                        | Yes (k)                      | No                           | No                               | No                            | Yes (h)                         |

a. Cover, including the pavement structure is the height of fill above the top of the pipe.

b. Class E culvert applies if the culvert is beneath the influence of proposed pavement and the depth of cover is 3 ft or less.

c. Class F culvert applies for driveway culverts (residential and commercial).

d. Roman numerals refer to class of reinforced concrete pipe in accordance with AASHTO M 170.

e. Arabic numerals refer to the class of nonreinforced concrete pipe in accordance with AASHTO M 86.

f. Nonreinforced concrete pipe Class 1 is allowed for Class F culverts with a depth of cover up to 10 ft.

g. Nonreinforced concrete pipe Class 3 is allowed for Class F culverts with a depth of cover from 10 ft to 16 ft.

h. Provide CPE in accordance with AASHTO M 294, Type S polyethylene pipe.

i. Allowed only for no greater than 36 in diameter pipe for CPE pipes

j. Special design is required for fill heights greater than 33 ft.

k. At least 2 ft cover if the culvert is outside the influence of proposed pavement (measured from top of pipe to final grade)

l. Allowed only for 12 in to 24 in diameter CPE pipes. Refer to the Class B Plastic Pipe Qualified Products List for approved manufacturers and products.

m. Class A culvert applies if the culvert is outside the influence of proposed pavement or is beneath the influence of proposed pavement and the depth of cover is from 3 ft to 10 ft.

### 401.03. Construction.

**A. Excavation and Culvert Bedding.** Excavate in accordance with subsection [206.03.A](#). Construct pipe culvert bedding using granular material Class IIIA, placed in layers no greater than 10 inches thick. Compact each layer to at least 95 percent of maximum unit weight for the entire length of the culvert. Where rock or hardpan is encountered, excavate the trench to at least 6 inches below the proposed bottom of the pipe; backfill with granular material Class IIIA, and compact.

Where unstable soil conditions, or obstructions other than rock, require excavation of the trench below the elevation detailed on the plans; undercut, backfill, and compact the trench as directed by the engineer. Use 6A, 17A, or 34R aggregate as backfill material for undercutting due to unstable soil conditions. This work will be paid for as trench undercut and backfill according to subsection [402.04.E](#).

**B. Repair of Damaged Coated Surfaces.** Repair, at no additional cost to the Department, coated culvert surfaces, damaged during transporting, handling, or installing. Complete repair of galvanized culvert surfaces in accordance with subsection [716.03.E](#). Repair other coated culvert surfaces as directed by the Engineer.

**C. Laying and Jointing Pipe.** Lay culverts with bells or grooves upgrade, ends fully and closely jointed, and with full, firm bearing throughout the length of the culvert. For pipe with diameters greater than 24 inches, wrap pipe joints with geotextile blanket. Use geotextile blanket with a width of at least 22 inches and center it on the joint.

Take up, and relay culvert sections showing signs of settlement or poor horizontal or vertical alignment, as determined by the Engineer. Remove, replace and mandrel test, if required by the Engineer, culverts damaged by the Contractor's operations.

Correct settled, misaligned, or damaged culvert sections at no additional cost to the Department.

1. **Corrugated Plastic Pipe.** Provide homing marks on smooth lined corrugated plastic pipe (CPE) to show the correct alignment of the pipe sections and joint material during field installation.

After the trench backfill and compaction is complete, the Engineer will select at least 50 percent of the installed length of each CPE size for deformation testing. Provide the labor and equipment required to complete this testing. Use a 9-point mandrel with an effective diameter of 95 percent of the nominal pipe diameter. Pull mandrel through the pipe by hand using non-mechanical means without

damaging the pipe. Provide the Engineer with a proving-ring to verify the mandrel size. Conduct mandrel testing from five to ten working days before pavement surfacing or completion of final grade, unless otherwise approved by the Engineer.

Remove and reinstall, or replace, pipe with a nominal diameter reduced by at least 5 percent at no additional cost to the Department. Only reinstall undamaged pipe. Do not reinstall pipe without the Engineer's prior approval.

The Contractor is responsible for all expenses and delays due to the replacement of deformed or damaged pipe.

2. **Concrete Pipe.** Install reinforced concrete elliptical pipe with the longer axis placed horizontally, unless otherwise required.

Install Type HE elliptical pipe with the longer axis within 5 degrees of the horizontal.

Install Type VE elliptical pipe with the longer axis within 5 degrees of the vertical.

Install elliptically reinforced, circular concrete pipe with the lift holes or manufacturer's marks on top of the pipe. Ensure the lift holes or manufacturer's marks, designating the top and bottom of the pipe, are not more than 5 degrees from the vertical plane through the longitudinal axis of the pipe. After installing the pipe, seal the lift holes with concrete plugs and waterproof.

3. **Metal Pipe.** Do not use wedge lock dimple bands for corrugated metal pipe.

Do not use dissimilar types of base metal (steel or aluminum alloy) or dissimilar types of coatings on steel (zinc or aluminum) in a single line of pipe. However, the Engineer will accept the use of zinc coated steel end sections with aluminum coated steel pipe. Use coupling bands of the same base metal and coating metal as the pipe.

4. **Extending Culverts.** If extending a pipe culvert, cast a concrete collar at least 3 inches thick and extending 6 inches on each side of the joint. Wrap the connecting joint with a 36-inch wide geotextile strip centered on the joint. When extending an existing corrugated metal pipe with a corrugated metal pipe, the Engineer will allow a dimple band with filter wrap instead of a concrete collar on the first connection if the existing culvert is in good condition and has a circular cross section. Other methods of connecting to the existing pipe before construction require approval of the Engineer. Provide

joints tested in accordance with [MTM 723](#) for remaining joints of the extension.

**D. Backfilling.** Backfill culverts, within the limits of the roadbed, with granular material Class II, III, or IIIA. Place backfill in layers no greater than 10 inches thick and compact each layer to at least 95 percent of the maximum unit weight. Backfill culvert downspouts, culverts, or portions of culverts outside the limits of the roadbed with granular or suitable material as detailed on the plans. Compact thoroughly as directed by the Engineer. Maintain at least 3 feet of cover, unless trimming for final grades.

Backfill smooth lined CPE with granular material Class IIIA to at least 1 foot above the pipe and as shown on the plans. The Engineer may allow the use of Class II backfill above this elevation. Place the backfill in layers no greater than 10 inches or half the pipe diameter, whichever is less. Place the backfill equally on opposite sides of the pipe at the same time.

Stake, or use other methods to maintain the line and grade of the culvert during the backfilling operation.

**E. Headwalls and End Sections.** Protect the ends of the culvert using headwalls or end sections constructed in accordance with details on the plans. Construct headwalls in accordance with section [706](#).

Use precast concrete end sections on concrete culverts in accordance with Standard Plan R-86 Series. If sloped end sections on concrete culverts are required, use either metal or concrete sloped end sections in accordance with Standard Plan R-95 Series. If footings for precast end sections or precast sloped end sections are required, use either precast or cast in place footings. Form or place them at the locations and to the elevations shown on the plans.

Use metal end sections on corrugated metal pipe culverts. Attach metal end sections to the ends of corrugated metal pipe using standard metal bands or other connecting devices as shown on the plans or approved by the Engineer. Provide and install toe plates on the metal end sections if shown on the plans.

Use either precast concrete or metal end sections on CPE. Do not use plastic end sections. Fasten end sections to the pipe as recommended by the pipe manufacturer or as directed by the Engineer. The Engineer will allow the use of a metal end section that is one size larger in diameter than the CPE. Slip the end section over the end of the pipe and securely fasten, making sure that the portion of the plastic pipe left exposed is less than 3 inches. If using a concrete end section, wrap the

joint with a strip of geotextile blanket 36 inches wide and centered on the joint.

Provide and install end section grates for culvert end sections on designated culvert end sections. Fabricate end section grates from weldable grade hot-rolled steel bars, plain or deformed, of the diameter and configuration shown on the plans. Fasten grates securely to the concrete end sections as shown on the plans.

Place salvaged end sections in accordance with specifications for placing new end sections.

Replace end sections damaged by Contractor's operation during salvaging or replacing operations with the same size end section as the original, at no additional cost to the Department.

**F. Drainage Marker Posts.** Place drainage marker posts at headwalls and culvert end sections for culverts with a diameter no greater than 36 inches, and at outlet endings. Ensure drainage marker posts are embedded at least 2 feet, or as recommended by the manufacturer.

**G. Pipe Culverts Jacked in Place.** Jack the culvert into place to the line and grade shown on the plans or established by the Engineer.

If jacking pipe under railroad tracks, submit to the Engineer, sheeting and bracing plans for the jacking pits for approval by the railroad company. Do not begin excavation of the jacking pit until receipt of the approval.

Excavate the approach trench large enough to accommodate jacks and blocking and at least one section of pipe. Lay two rails or sills in the bottom of the trench to keep the pipe at the established line and grade.

Minimize excavation ahead of the pipe to prevent caving of the earth. The Engineer will allow attachment of a steel cutting edge or shield to the front section of pipe to form and cut the required opening for the pipe.

Fill voids between the excavation and the pipe using materials and placing methods approved by the Engineer.

**H. Steel Pipe Jacked in Place.** Jack steel pipe in place to serve as a carrier pipe or a casing for a carrier pipe. Jack steel pipes in place in accordance with subsection [401.03.I](#).

**I. Steel Casing Pipe.** Install steel casing pipe in a trench as shown on the plans. Provide steel casing pipes placed for future use with a temporary bulkhead at each end to prevent infiltration into the pipe.

**J. Corrugated Steel Culvert.** Do not use dissimilar type of base metal (steel or aluminum alloy) or dissimilar types of coatings on steel (zinc or aluminum) in a single line of pipe.

**K. Disposal of Surplus Material.** Dispose of surplus material in accordance with subsection [205.03.P](#).

**L. Cleanout.** Maintain culverts installed on the project. Ensure they are free of silt, debris, and other foreign matter above the existing flow line of the drainage course at the time of final acceptance.

**M. Video Inspection.** Video inspect culverts as specified for sewers in subsection [402.03.K](#). Video inspection is not required for the following:

1. Driveway culverts,
2. Culvert extensions less than 50 feet,
3. New culverts less than 50 feet, or
4. The extension of existing catch basin leads less than 20 feet.

**N. Dewatering and Maintaining Stream Flow During Construction.** During construction, perform dewatering or pumping and temporary drainage to maintain stream flow so as to avoid damaging adjacent property or structures and interfering with the rights of the public, adjacent property owners, vehicular traffic, or other contractors.

Do not disturb the soil under and next to existing structures during dewatering and temporary pumping operations. Direct water from dewatering operations or from maintaining stream flow through a filter bag before discharging to an existing drainage facility. Do not overload or obstruct existing drainage facilities.

#### **401.04. Measurement and Payment.**

| <b>Pay Item</b>   | <b>Pay Unit</b> |
|---|-----------------|
| Culv, CI __, __ inch .....  | Foot            |
| Culv, CI __, (material), __ inch .....  | Foot            |
| Culv, Downspout __ inch .....   | Foot            |
| Culv, Reinf Conc Ellip, CI __, (rise) inch x (span) inch .....                      | Foot            |
| Culv, CSP Arch, CI __, (span) inch x (rise) inch .....                              | Foot            |
| Culv, Slp End Sect, (slope), __ inch, Longit .....                                  | Each            |
| Culv, Slp End Sect, (slope), __ inch, Transv .....                                  | Each            |
| Culv, Slp End Sect, Arch Pipe, (slope), (span) inch x<br>(rise) inch, Longit .....  | Each            |
| Culv, Slp End Sect, Arch Pipe, (slope), (span) inch x<br>(rise) inch, Transv .....  | Each            |
| Culv, Slp End Sect, Ellip Pipe, (slope), (rise) inch x<br>(span) inch, Longit ..... | Each            |



|  |       |
|--|-------|
| Culv, Slp End Sect, Ellip Pipe, (slope), (rise) inch x (span) inch, Transv ..... | Each  |
| Culv End Sect, (material), __ inch .....   | Each  |
| Culv End Sect, __ inch .....   | Each  |
| Culv End Sect, Footing .....   | Each  |
| Culv End Sect, Grate .....   | Pound |
| Culv, CI __, __ inch, Jacked in Place .....                                      | Foot  |
| Steel Casing Pipe, __ inch, Jacked in Place .....                                | Foot  |
| Steel Casing Pipe, __ inch, Trench Det __ .....                                  | Foot  |
| Dr Marker Post .....   | Each  |
| Culv End Sect, Salv, 30 inch or less .....                                       | Each  |
| Culv End Sect, Salv, over 30 inch .....  | Each  |

A. **Culverts.** The Engineer will measure culverts, of the diameter, class, or material required, by length, excluding the length of end sections as shown on the plans. The unit prices for culverts include the cost of the following:

1. Excavating the material down to grade or to the culvert bedding bottom elevation;
2. Dewatering and maintaining the stream flow during construction stages;
3. Providing and placing the culvert and geotextile strip;
4. Providing temporary cover and restraining the pipe to maintain line and grade;
5. Providing, placing, and compacting the backfill;
6. Mandrel testing if required; and
7. Disposing of excess material.

B. **Culvert, Jacked in Place.** The Engineer will measure **Culv, CI \_\_, \_\_ inch, Jacked in Place** of the size and type required, by length, as determined by multiplying the number of units actually jacked by the commercial laying length. The unit price for **Culv, CI \_\_, \_\_ inch, Jacked in Place** includes the cost of excavating the pit; providing and installing sheeting, bracing, and other safety devices; providing jacking equipment; drainage and dewatering; and other items associated with the operation.

C. **Culvert End Sections.**

1. **End Sections.** The unit price for **Culv, Slp End Sect** of the size or type required includes the cost of providing and placing end sections, including longitudinal and cross tubes as detailed on Standard Plans R-95 Series.

The unit price for **Culv End Sect** of the size or type required includes the cost of providing and placing the end section.

The unit price for **Culv End Sect, Metal** includes the cost of providing and placing the end sections and toe plates, if shown on the plans. The unit price for **Culv End Sect, Metal** also includes the cost of providing and placing the length of associated culvert represented by the "c" dimension shown on the plans.

If corrugated plastic pipe is provided, the Department will pay for culvert end sections of the diameter required for the culvert, even if the Contractor provides a metal end section larger than the nominal diameter of the pipe.

The unit price for culvert end section includes the cost of fastening the end section to the pipe. The Department will pay for required riprap in accordance with subsection [813.04](#).

2. **Culvert End Sections, Footing.** The Department will pay for footings required for precast concrete end sections as **Culv End Sect, Footing**. The unit price for **Culv End Sect, Footing** includes the cost of the following, for the footing as shown on the plans:
  - a. Excavation and forming;
  - b. Providing and placing the steel reinforcement; and
  - c. Providing, placing, finishing, and curing the concrete.
3. **Culvert End Sections, Salvage.** The unit price for **Culv End Sect, Salv** includes the cost of removing the existing end section, salvaging and storing, and reinstalling end sections.
4. **Culvert End Section, Grate.** The Engineer will measure **Culv End Sect, Grate** by weight as shown on the plans for the size of grate required.
- D. **Headwalls.** The Engineer will measure, and the Department will pay for headwalls as steel reinforcement and concrete, Grade S2, in accordance with subsection [706.04](#). If using precast wing walls, headwalls, and aprons in lieu of cast-in-place wing walls, headwalls, and aprons, the Department will pay for them as the corresponding pay items for the cast-in-place wing walls, headwalls, and aprons as required by the contract.
- E. **Jacked in Place Steel Pipe.** The Department will not pay separately for jacked in place steel pipe used, at the Contractor's discretion, to act as a casing for the carrier pipe. The cost of grouting between the carrier and casing pipes is included in payment for the carrier pipe.

F. **Steel Casing Pipe.** The unit price for steel casing pipe includes the cost of excavation and backfill.

The Department will pay separately for carrier pipe inserted into a steel casing pipe. The unit price for the carrier pipe includes the cost of casing chocks, inserting the carrier pipe, and required grouting.

G. **Videotaping Sewer and Culvert Pipe.** The Engineer will measure, and the Department will pay for videotaping sewer and culvert pipe in accordance with subsection [402.04](#).

H. **Rock Excavation.** The Engineer will measure and the Department will pay separately for rock excavation in accordance with subsection [205.04](#).

## Section 402. STORM SEWERS

**402.01. Description.** This work consists of constructing storm sewers of the size and class required, including excavation, bedding, and backfill.

**402.02. Materials.** Provide materials in accordance with the following:

|   |                            |
|---|----------------------------|
| Concrete, Grade S3.....                     | <a href="#"><u>701</u></a> |
| Mortar, Type R-2 .....                      | <a href="#"><u>702</u></a> |
| Granular Material Class II, III, IIIA ..... | <a href="#"><u>902</u></a> |
| Aggregate 6A, 17A, 34R.....                 | <a href="#"><u>902</u></a> |
| Sewer Pipe .....                            | <a href="#"><u>909</u></a> |
| Sealers for Sewer Joints.....               | <a href="#"><u>909</u></a> |
| Steel Pipe (for jacking in place).....      | <a href="#"><u>909</u></a> |
| Geosynthetics.....                          | <a href="#"><u>910</u></a> |

Select pipe with watertight joint systems from the Qualified Products List.

Storm sewers are divided into five classes, as specified in Table 402-1. If the contract only specifies the size and class of sewer, provide an alternate allowed in Table 402-1.

For types of sewer material required, but not included in Table 402-1, the contract will specify the type and size of sewer material.

The Contractor may substitute a higher strength or greater thickness of sewer for the minimum sewer strength or minimum thickness required.

**Table 402-1  
Pipe Alternates for Storm Sewer Classes**

| Type of Pipe/Depth of Cover in feet (a)        | Class A<br>Sewer<br>0-10 (k) | Class B<br>Sewer<br>>10-16 | Class C<br>Sewer<br>>16-23 | Class D<br>Sewer<br>>23-33 (l) | Class E<br>Sewer<br>0-3 (b) |
|--|------------------------------|----------------------------|----------------------------|--------------------------------|-----------------------------|
| Reinforced Concrete Pipe (c)                   | II                           | III                        | IV                         | V                              | IV                          |
| Nonreinforced Concrete Pipe (d)                | 1                            | 3                          | No                         | No                             | No                          |
| Corrugated and Spiral Ribbed Al-Alloy Pipe (e) | Yes                          | Yes                        | Yes                        | Yes                            | No                          |
| Corrugated and Spiral Ribbed Steel Pipe (f)    | Yes                          | Yes                        | Yes                        | Yes                            | No                          |
| Smooth-Lined Corrugated Plastic Pipe (CPE) (g) | Yes (h)                      | Yes (i)                    | No                         | No                             | No                          |
| Corrugated Polyvinyl Chloride Pipe (CPV) (j)   | Yes (h)                      | Yes (i)                    | No                         | No                             | No                          |

a. Cover, including the pavement structure is defined as the height of fill above the top of the pipe measured to final grade.

b. Class E Sewer applies when the sewer is beneath the influence of proposed pavement and the depth of cover is no greater than 3 ft.

c. Roman numerals refer to class of reinforced concrete pipe, AASHTO M 170.

d. Arabic numerals refer to the class of nonreinforced concrete pipe, AASHTO M 86.

e. Allowed for 12 in to 66 in spiral ribbed and 12 in to 18 in helically corrugated 2<sup>2</sup>/<sub>3</sub> in x 1/2 in aluminum alloy pipe only.

f. Allowed for 12 in to 84 in spiral ribbed and 12 in to 18 in helically corrugated 2<sup>2</sup>/<sub>3</sub> in x 1/2 in steel pipe only.

g. CPE shall conform to AASHTO M 294, Type S Polyethylene pipe.

h. Allowed only for 36 in diameter pipe and under for CPE and CPV pipes. At least 3 ft of cover.

i. Allowed only for 12 in to 24 in diameter CPE and CPV pipes. Refer to the Class B Plastic Pipe Qualified Products List for approved manufacturers and products.

j. CPV must conform to AASHTO M 304.

k. Class A sewer applies when the sewer is outside the influence of proposed pavement or is beneath the influence of proposed pavement and the depth of cover is greater than 3 ft but less than or equal to 10 ft.

l. Special design is required for depths of cover greater than 33 ft.

### **402.03. Construction.**

**A. Excavation, Trench Construction, and Sewer Bedding.** Perform trench construction using methods meeting the health and safety requirements specified in subsection [104.07](#).

Begin the trench excavation at the downstream end of the sewer. Excavate the trench as shown on the plans, or as determined by the Engineer. Construct the trench width to at least the minimum width shown on the Standard Plans, but wide enough to provide free working space and to allow compaction of the backfill around the pipe. Shape the bottom of the trench to support the pipe uniformly. Backfill and compact with granular material Class II to the required elevation.

If unstable soil conditions, or obstructions other than rock, require excavation of the sewer trench below the elevation shown on the plans, undercut, backfill, and compact the trench as directed by the Engineer. Use 6A, 17A, or 34R aggregate to backfill trench undercutting due to unstable soil conditions.

Take possession and dispose of surplus material from sewer excavation in accordance with subsection [205.03.P](#).

During sewer construction, maintain and protect existing live utilities. Minimize service interruptions and coordinate with the local municipality or utility company. Immediately repair or replace utilities, interrupted during sewer construction, as directed by the Engineer.

**B. Repair of Damaged Coated Surfaces.** Repair, at no additional cost to the Department, coated pipe surfaces damaged during pipe transportation, handling, or installation. Complete repair of galvanized pipe surfaces in accordance with subsection [716.03.E](#). Repair other coated sewer pipe surfaces as directed by the Engineer.

**C. Laying and Jointing Pipe.** Lay storm sewers as shown on the plans, with bells or grooves upgrade, and ends closely jointed. Provide a full, firm bearing along the length of each pipe section. Wrap pipe joints, with a diameter greater than 24 inches, using geotextile fabric. Use geotextile at least 22 inches wide, centered on the joint.

Remove and replace pipe damaged by Contractor operations. Mandrel test replaced CPE and CPV pipe. Remove and re-lay sewer sections that the Engineer determines, show signs of settlement or poor alignment at no additional cost to the Department.

1. **Corrugated Plastic Pipe (CPE and CPV).** During field installation, align pipe sections with homing marks on CPE and CPV pipe sections and joint material.

After trench backfill and compaction is complete, the Engineer will select at least 50 percent of the installed length of each size of CPE and CPV for the Contractor to mandrel test for deformation.

Unless otherwise approved by the Engineer, perform the mandrel test from 5 to 10 working days before pavement surfacing or completion of final grade.

Provide the labor and equipment required to complete testing. Use a nine-point mandrel with a diameter equal to 95 percent of the nominal pipe diameter. Provide the Engineer with a proving-ring to verify the mandrel size. Pull the mandrel through the pipe by hand, with no mechanical advantage, and without damaging the pipe.

Remove and reinstall, or replace, pipe with nominal diameter reduced by more than 5 percent at no additional cost to the Department. Only reinstall undamaged pipe. Do not reinstall pipe without the Engineer's prior approval.

The Contractor is responsible for all expenses and delays caused by reinstallation or replacement of pipe.

2. **Concrete Pipe.** Install reinforced concrete elliptical pipe with the longer axis placed horizontally, unless otherwise required.

Install Type HE elliptical pipe with the longer axis within 5 degrees of horizontal.

Install Type VE elliptical pipe with the longer axis within 5 degrees of vertical.

Install circular concrete pipe with elliptical reinforcement so the lift holes or manufacturer's marks are on top of the pipe. Place pipe so the lift holes or manufacturer's marks, designating the top and bottom of the pipe, are no more than 5 degrees from the vertical plane through the longitudinal axis of the pipe. After installing the pipe, seal the lift holes with concrete plugs and waterproof.

- D. **Sewer Taps.** Make connections to county, municipality, or drain commission-owned storm sewers in accordance with the regulations of the owner and as required by the contract. If a conflict exists between the owner's regulations and these specifications, the owner's regulations will take precedence.

For existing storm sewers with plugs or bulkheads, remove plugs or bulkheads without damaging the existing sewer and make watertight joint connections. Take possession and dispose of the removed material in accordance with subsection [204.03.B](#).

If tapping an existing pipe, cut an opening in the receiving pipe at least 6 inches larger than the outside diameter of the inlet pipe. Insert the inlet pipe and cut flush with the inner wall of the receiving pipe. Pack a layer of mortar at least 3 inches thick around the inlet pipe and strike smooth with the inner wall of the receiving pipe. Encase the inlet pipe on the outside of the connection with concrete to provide bearing under the pipe. Repair or replace existing pipe damaged by Contractor tapping operations at no additional cost to the Department.

Do not direct tap sewer inlet pipes with outside diameters greater than half the inside diameter of the trunk sewer. Construct a manhole structure for these taps in accordance with section [403](#). Obtain the Engineer's approval before using other methods for tapping existing sewers.

**E. Sewer Bulkheads.** Construct sewer bulkheads using Grade S3 concrete or brick or block masonry. Extend the bulkhead at least 1 foot into the pipe from the inner wall of the drainage structure. Construct masonry bulkheads in accordance with subsection [403.03](#).

**F. Backfilling.** Backfill in accordance with subsection [401.03.D](#).

**G. Corrugated Steel Sewer.** In a single line of pipe, do not use dissimilar base metals or coatings on steel.

**H. Sewer Jacked in Place.** Jack sewers in place in accordance with subsection [401.03.G](#).

**I. Disposal of Surplus Material.** Take possession and dispose of surplus material in accordance with subsection [205.03.P](#).

**J. Cleanout.** Maintain storm sewers installed on the project. Ensure installed sewers are free of silt, debris, and other deleterious material at the time of final acceptance.

**K. Video Inspection of Sewer Pipe.** Use closed circuit television to inspect required storm sewers. Dewater or divert flow in sewers for inspection. Video inspection is not required for extensions of existing catch basin leads less than 20 feet.

After backfilling and compacting the trench, and from 5 to 10 working days before pavement surfacing or completion of final grade, conduct the



inspection of sewers under pavement, unless otherwise approved by the Engineer.

For sewers not under pavement, conduct the inspection as close to project completion as possible, but allow time for corrective action determined by the video inspection and directed by the Engineer.

1. **Traffic Control.** Obtain the Engineer's approval of traffic control measures at least 5 days before beginning work. Propose a traffic control plan in accordance with the [Michigan Manual of Uniform Traffic Control Devices](#).

Unless otherwise approved by the Engineer, keep traffic lanes open. For necessary lane or shoulder closures, use traffic control measures in accordance with the traffic control plan.

2. **Equipment.** Use a camera designed and constructed for inspecting sewers, equipped with the following features:
  - a. A pan and tilt head external to the main body of the camera to allow inspection of the sewer joints and cracks or other defects;
  - b. Lighting to allow a clear picture of the perimeter of the pipe; and
  - c. Underwater operation, capable of producing a picture quality satisfactory to the Engineer.

If the Engineer determines the video quality is not satisfactory, re-inspect the pipes to obtain acceptable results, at no additional cost to the Department.

Use continuous running video capable of recording audio and video information. Include the date, the month, day and year, and camera location. Provide a continuous record of the sewer section, from manhole to manhole or from end to end. Use high quality, color, DVD format at a standard play speed. Obtain the Engineer's approval before using other recording media.

3. **Sewer Flow Control.** Provide flow control to bring the depth of flow in the sewer pipe within the range specified in subsection [402.03.K.3.a](#) for video inspection. Submit to the Engineer for approval, the proposed method of sewer flow control before starting work.
  - a. **Depth of Flow.** Lower the depth of flow in the sewer during the videotaping operation to less than 2 inches. Reduce flow by plugging or blocking the flow, or by pumping the flow and bypassing the pipe section during inspection, as approved by the Engineer.

- b. **Plugging or Blocking.** Insert a sewer line plug into the line upstream of the section undergoing inspection. Use a plug designed to allow the release of portions of the flow. During video inspection, reduce the flow depth to 2 inches. Restore normal flow after completing the work. Meter flow discharge to prevent erosion.
  - c. **Pumping and Bypassing.** For pumping and bypassing, supply the pumps, conduits, and other equipment to divert the flow around the sewer section undergoing inspection. Provide a bypass system with a capacity to handle existing flow plus additional flow that may occur during a rain event. Provide the labor and supervision required to set up and operate the pumping and bypassing system.
  - d. **Flow Control Precautions.** If the flow in a sewer line is plugged, blocked, or bypassed, protect the sewer lines from damage that may result from sewer surcharging. Ensure sewer flow control operations do not cause flooding or damage to public or private property.
4. **Procedure.** Move the camera through the line at a rate no greater than 0.5 feet per second, stopping as required to document the joint and pipe conditions. Use winches, cable, powered rewinds, or other devices that do not obstruct the camera view or interfere with proper documentation of the pipe conditions.

Adjust the camera to travel above the level of the flow in the pipe. If the camera encounters a dip in the pipe such that the water rises above the springline of the pipe, or if the camera lens becomes submerged, withdraw the camera and re-insert it from the other end as far as possible. Do not back the camera into a pipe undergoing inspection.

Measure the distance to the location of defects above ground using a meter device. The Engineer will not allow marking defect locations on the cable to measure the distance to defects. Provide a distance meter with an accuracy within 1 foot and check using a walking meter, roll-a-tape, or other device.

5. **Documentation.** After completing the video inspection, provide two copies of the video to the Engineer. Include a written log of damages or installation defects, including pipe deformation, cracking, joint separation, corrosion, perforation or other features identified in the video. Provide two copies of the log to the Engineer. Locate the damage or defect by meter marking of the video in the inspection

log. Label the videos to describe the reaches of sewer or culverts contained in the videos, including street location and manhole numbers. If manhole numbers are not provided, assign a numbering system to allow identification in the inspection report and video.

**402.04. Measurement and Payment.**

| <b>Pay Item</b>  | <b>Pay Unit</b> |
|--|-----------------|
| Sewer, Cl __, __ inch, Tr Det _____                                    | Foot            |
| Sewer, Reinf Conc Ellip, Cl __, (rise) by (span) inch,<br>Tr Det _____ | Foot            |
| Sewer, Cl __, (type), __ inch, Jacked in Place _____                   | Foot            |
| Sewer Tap, __ inch _____   | Each            |
| Sewer Bulkhead, __ inch _____  | Each            |
| Trench Undercut and Backfill _____                                     | Cubic Yard      |
| Dewatering System, Trench _____  | Foot            |
| Video Taping Sewer and Culv Pipe _____                                 | Foot            |

A. **Sewer and Sewer, Reinforced Concrete Elliptical.** The Engineer will measure **Sewer** and **Sewer, Reinf Conc, Ellip**, of the size, class, and trench detail required, in place from center to center of manholes, catch basins, or inlets. The unit price for **Sewer** and **Sewer, Reinf Conc, Ellip** includes the cost of excavation, backfill, geotextile fabric and mandrel testing.

B. **Sewer, Jacked in Place.** The Engineer will measure **Sewer, Jacked in Place**, of the size and class required, by multiplying the number of units jacked by the commercial laying length. The unit price for **Sewer, Jacked in Place** includes excavating the pit; providing and installing sheeting, bracing, and other safety devices; providing jacking equipment; drainage and dewatering; and other items associated with the operation.

C. **Sewer Tap.** The Engineer will measure **Sewer Tap**, based on the inlet pipe size required, by each tap into an existing system. If tapping an existing sewer line using a drainage structure, the Department will pay for one sewer tap in addition to the drainage structure.

D. **Sewer Bulkhead.** The Engineer will only measure sewer bulkheads for storm sewers with a diameter larger than 12 inches. The cost of constructing sewer bulkheads for pipes with a diameter less than or equal to 12 inches, or constructed as part of abandoning or removing drainage structures as shown on the plans, is included in the unit prices for related pay items.

The Department will pay separately for bulkheading pipes greater than 12 inches.

E. **Trench Undercut and Backfill.** The Engineer will measure **Trench Undercut and Backfill** by calculating the volume from the length, depth, and width of undercut authorized by the Engineer and shown on the plans. The Engineer will not make allowance for sloping the sides of the trench. The unit price for **Trench Undercut and Backfill** includes the cost of excavation and disposal of material; and providing, placing, and compacting 6A, 17A, or 34R aggregate to the bottom of trench elevation shown on the plans.

F. **Rock Excavation.** The Engineer will measure and the Department will pay separately for rock excavation in accordance with subsection [205.04](#).

G. **Dewatering System, Trench.** If the contract does not include a pay item for **Dewatering System, Trench** and the Contractor uses a dewatering system, the Department will not pay separately for the system, but will consider the cost to be included in the unit prices for related pay items.

H. **Tunneling.** The Engineer may authorize tunneling, in place of open-cut construction methods. The Department will delete, or proportionally reduce pay item quantities required for corresponding open-cut construction from the contract if the Engineer authorizes tunneling. The Department will not make an adjustment in the pay items of **Minor Traffic Devices or Flag Control**.

If the contract does not include a unit price for tunneling of the proposed pipe size, the Department will pay for tunneling as Extra Work at an agreed upon price. Payment for the work performed by tunneling methods will not exceed the unit price bid for the open-cut method.

I. **Video Taping Sewer and Culvert Pipe.** The unit price for **Video Taping Sewer and Culv Pipe** includes the cost of dewatering, flow control, video inspection, and documentation.

The Department will pay separately for traffic maintenance and control in accordance with subsection [812.04](#).

**Section 403. DRAINAGE STRUCTURES**

**403.01. Description.** This work consists of adjusting, constructing, or temporarily lowering drainage structures and cleaning existing drainage structures and leads as directed by the Engineer.

Drainage structures include manholes, catch basins, leaching basins, inlets, and drop inlets.

**Drainage Structure.** Includes concrete footing or precast sump. Used for access to new or existing sewers with a diameter no greater than 48 inches.

**Precast Manhole Tee and Manhole Riser.** Used for access to new sewers with diameters of at least 42 inches.

**Manhole Base, Type 1 or Type 2, and Manhole Riser.** Used for access to new or existing sewers with a diameter of at least 48 inches. Manhole Base Type 1 may be substituted for Precast Manhole Tees.

**403.02. Materials.** Provide materials in accordance with the following:

|  |                     |
|--|---------------------|
| Concrete, Grade S3.....                    | <a href="#">701</a> |
| Mortar Type R-2 .....                      | <a href="#">702</a> |
| Granular Material Class II, III.....       | <a href="#">902</a> |
| Steel Reinforcement.....                   | <a href="#">905</a> |
| Miscellaneous Metal Products.....          | <a href="#">908</a> |
| Castings.....                              | <a href="#">908</a> |
| Culvert, Sewer Pipe, and Box Sections..... | <a href="#">909</a> |
| Geosynthetics.....                         | <a href="#">910</a> |
| Masonry Units.....                         | <a href="#">913</a> |

Provide cast-in-place or precast concrete construction for sanitary sewer manholes.

Provide structural steel plate, at least ½ inch thick, for temporary lowering of drainage structures that span 72 inch, or less. Ensure plates cover the entire drainage structure with a bearing surface of at least 12 inches. Submit to the Engineer, structural calculations prepared by a professional engineer, licensed in the state of Michigan, for plates that span greater than 72 inches.

Provide leveling course hot mix asphalt (HMA) for patching during the temporary lowering operations, or other HMA mixture as approved by the Engineer.

### 403.03. Construction.

#### A. Constructing, Adjusting, and Temporary Lowering of Drainage Structures, Precast Manhole Tees, Manhole Bases, and Manhole Risers.

1. **Excavation.** Excavate for constructing, adjusting, and temporarily lowering drainage structures, precast manhole tees, manhole bases and manhole risers in accordance with subsection [206.03.A](#).
2. **Concrete Construction.** Construct concrete portions of drainage structures in accordance with subsection [706.03](#). Do not cast drainage structures if the concrete temperature is above 90 °F.
3. **Placing Brick and Block Masonry.** Do not place masonry with mortar when the ambient air temperature is 36 °F or less unless approved by the Engineer. Remove and replace work damaged by frost. Apply a ½-inch thick plaster coat of mortar to the outer surface of structures, and to the inner surface below the outlet flow line on catch basins with traps or sumps. Place the first set of bricks or blocks on a full bed of mortar. Lay brick or block in courses with uniform mortar joints ½ inch thick,  $\pm\frac{1}{8}$  inch. Stagger joints by half the length of the brick or block on adjoining courses. Place courses level unless otherwise required. Strike and point joints so the exposed surface is smooth. Rake joints and wet brick or block before placing the plaster coat. Allow the brick or block surface to dry to provide for proper bonding of the plaster coat.

Wet the brick. Allow the brick surface to dry to allow the brick and mortar to bond. Do not use broken or chipped brick on the faces of the structure. Provide a course made of headers, at least every seventh course. Make closures with brick lengths no less than the width of a whole brick.

4. **Precast Reinforced Concrete Units.** Use poured-in-place concrete, in accordance with subsection [403.03.A.2](#), or precast concrete footings. Construct precast reinforced concrete units in accordance with the contract. Seal the joints with mortar in accordance with subsection [403.03.A.3](#) or use butyl rubber sealant that conforms to ASTM C 990. Support precast concrete footings on a 6-inch subbase of compacted granular material Class II.
5. **Steel Reinforcement.** Install steel reinforcement in accordance with subsection [706.03](#).
6. **Inlet and Outlet Pipes.** Place and compact backfill around the manhole base or sump to provide bedding for inlet and outlet pipes.

Extend inlet and outlet pipes through the outside wall surface of the manhole a sufficient length to allow for pipe connections. Carefully construct masonry around pipes and seal with mortar to prevent leakage.

7. **Backfilling.** Backfill in accordance with subsection [401.03.D](#).

The Contractor may stage backfilling to follow the construction progress of the structure.

8. **Temporary Lowering of Drainage Structures.** Lower drainage structures before milling the pavement.

Record the location of the structure so each cover can be reinstalled at its original location. Remove the existing frames and covers and match mark them for later identification and placement. Salvage and safely store frames and covers. Repair the existing structure to allow uniform contact of the steel plate to the top of the structure. Place and compact the HMA for patching in accordance with section [501](#).

9. **Protection During Construction.** Install appropriate inlet protection device in accordance with section [208](#), when working around drainage structure.

**B. Drainage Structure Covers.** Provide and install new covers, including frames and grates, on new or existing structures as required. Place castings on a full mortar bed.

**C. Adjusting Drainage Structure Covers.** Adjusting drainage structure covers applies when the new elevation of the cover requires a vertical change of no greater than 6 inches. Immediately before placing the HMA top course or overlay, make final adjustments to drainage structure covers within the HMA pavement section, if only applying one course. Adjust the cover to the required elevation by supporting it on one of the following:

1. A metal ring adjustor,
2. A concrete collar,
3. Masonry in a full mortar bed, or
4. An alternate adjustor selected from the Qualified Products List.

Hold adjusted covers in place. Remove and replace the adjacent pavement, curb, or curb and gutter to match the existing grades or the required new elevations.

**D. Additional Depth of Adjusting Drainage Structures.** Additional depth of adjusting drainage structure covers applies when a drainage structure cover is adjusted more than 6 inches from the existing cover

elevation due to a change in elevation of the roadway or when alterations to the drainage structure exceed 6 inches regardless of the change in cover elevation. Remove damaged or unsound portions of the structure, as directed by the Engineer, and adjust as required.

**E. Drainage Structure Taps.** Make connections to existing drainage structures, owned by counties, municipalities, or drain commissions, in accordance with the owner's regulations and the contract. If a conflict exists between the owner's regulations and these specifications, the owner's requirements take precedence.

If tapping an existing drainage structure, cut an opening into the receiving structure at least equal to the outside diameter of the inlet pipe plus 6 inches and insert the pipe. Pack a layer of mortar at least 3 inches thick around the inlet pipe and strike smooth with the inner wall of the receiving structure. Repair or replace existing drainage structure damaged by Contractor operations during tapping at no additional cost to the Department.

Tap directly to a sewer or culvert in accordance with subsection [402.03.D](#).

**F. Cleanout.** Maintain catch basins, manholes, leaching basins, and inlets installed on the project. Ensure installed catch basins, manholes, leaching basins, and inlets are free of silt, debris, and other deleterious material at the time of final acceptance.

**G. Cleaning Existing Drainage Structures and Leads.** Before starting work, the Engineer will determine the condition and will identify the areas on the project that require cleaning of existing drainage structures and leads.

First, clean the downstream drainage structure nearest the trunk sewer and place a temporary bulkhead so the trunk sewer remains clear. Clean upstream drainage structures and leads only after cleaning and bulkheading the downstream drainage structure.

Clean the drainage structures, leads, or both, of sand, silt, and debris and prevent further contamination of the leads.

Dispose of the waste generated from the drainage structure or drainage structure lead cleanout operation using either Disposal Alternate A, or Disposal Alternate B, in accordance with subsection [403.03.G.1](#) and subsection [403.03.G.2](#).

If the Contractor suspects the waste generated is contaminated but non-hazardous or is hazardous, the Contractor must notify the Engineer.



Immediately notify the Engineer if testing shows the material is a hazardous waste as defined in 1994 PA 451, Part 111, Hazardous Waste Management.

1. **Disposal Alternate A.**

a. **Solid Waste Phase.** Solid waste disposal rules require that the waste have no releasable liquids. Dispose of the solid waste at a Type II landfill. The landfill may require testing before accepting the waste. Provide disposal documentation from the Type II landfill to the Engineer.

b. **Liquid Waste Phase.** Dispose of the liquid waste using one of the following options:

Option 1 – Evaporate the liquid waste by use of drying beds, decanting stations, or similar systems that contain the solids during evaporation.

Option 2 – Place liquid waste in a sanitary sewer system with the sanitary sewer owner’s approval. Provide a copy of the owner’s approval to the Engineer.

Option 3 – Pump the majority of clear liquid from the drainage structure and leads without disturbing the solids. Discharge this clear liquid to:

- i. A sanitary sewer system with the sanitary sewer owner’s approval;
- ii. The curb and gutter such that it re-enters and is completely contained within the storm sewer system and does not enter the waters of the state; or
- iii. An area of undisturbed, well- vegetated ground at a rate that does not result in excessive ponding, runoff, or soil erosion.

Dispose of the remaining solid and liquid phase as waste using Disposal Alternate A, either Option 1 or Option 2, or Disposal Alternate B.

2. **Disposal Alternate B.** Use a Licensed Liquid Industrial Waste Hauler to transport the waste generated and dispose of it in accordance with 1994 PA 451, Part 121, Liquid Industrial Waste. Provide the Engineer a copy of the transport manifest.

**403.04. Measurement and Payment.**

| <b>Pay Item</b>   | <b>Pay Unit</b> |
|---|-----------------|
| Dr Structure, __ inch dia.....                                  | Each            |
| Dr Structure, Add Depth of __ inch dia, 8 foot to 15 foot ..... | Foot            |

|  |      |
|--|------|
| Dr Structure, Add Depth of ___ inch dia, more than 15 foot ..... | Foot |
| Drop Inlet, Type ___ .....                                       | Each |
| Mh, Precast Tee, CI __, __ inch .....                            | Each |
| Mh Base, ___ inch, Type ___ .....                                | Each |
| Mh Riser .....   | Foot |
| Dr Structure Cover, Type ___ .....                               | Each |
| Dr Structure Cover, Adj, Case ___ .....                          | Each |
| Dr Structure, Adj, Add Depth .....                               | Foot |
| Dr Structure, Tap, ___ inch .....                                | Each |
| Dr Structure, Temp Lowering .....                                | Each |
| Dr Structure, Cleaning .....                                     | Each |
| Dr Structure Lead, Cleaning, ___ inch .....                      | Foot |

**A. Drainage Structures Excluding Drop Inlets.** The Engineer will measure the depth of drainage structures, with the exception of drop inlets, from the top of the masonry to the top of the concrete footing.

The unit price for **Dr Structure**, of the diameter required includes the cost of concrete footing and no greater than 8 feet of the drainage structure depth. The unit price for **Dr Structure** includes the cost of temporary or final grade adjustments of the structure.

The unit price for **Dr Structure, Add Depth, 8 foot to 15 foot**, of the diameter required includes the cost of drainage structure portions, greater than 8 feet deep, but no greater than 15 feet deep.

The unit price for **Dr Structure, Add Depth, more than 15 foot**, of the diameter required includes the cost of drainage structure portions greater than 15 feet deep.

The unit price for new structures includes the cost of cleaning new drainage structures.

**B. Drop Inlets.** The Engineer will measure drop inlets as units, of the type required, regardless of depth.

The Department will pay separately for pipe leading from the drop inlet to a sewer or catch basin. The cost of pipe from drop inlets, Type 1 is included in the unit price for related sewer pay items, in accordance with subsection [402.04](#). The cost of pipe from drop inlets, Type 2, is included in the unit price for the related encased sewer pay item.

The Department will pay for a sewer tap or drainage structure tap, in accordance with subsection [402.04](#), only if tapping the sewer or encased sewer into an existing drainage system is required.

C. **Manhole Base and Riser.** The Engineer will measure **Mh Riser** vertically from above the collar of the **Mh, Precast Tee**, or above the **Mh Base** to the top of the riser.

The unit price for **Mh Base, Type 1** includes the cost of cutting access holes in the sewer.

If the Contractor uses **Mh Base, Type 1** in place of **Mh, Precast Tee** and the contract does not include the pay item **Mh Base, Type 1**, the unit price for **Mh, Precast Tee** includes the cost of installing a Type 1 manhole base.

D. **Drainage Structure Covers.** When new covers are placed on existing structures, the Engineer will measure and the Department will pay for **Dr Structure Cover, Adj, Case \_\_\_** in addition to the new cover.

The unit price for **Dr Structure Cover, Adj, Case 1** includes the cost of the following:

1. Sawcutting existing pavement, curb, and curb and gutter;
2. Adjusting the cover up or down, no greater than 6 inches; and
3. Removing and replacing pavement adjacent to the adjusted cover.

The Department will pay separately for removing and replacing curb and gutter adjacent to the adjusted structure.

The Department will only pay for **Dr Structure Cover, Adj, Case 2** for structure adjustments located outside existing pavement, curb, and curb and gutter.

The unit price for **Dr Structure Cover, Adj**, of the case required includes the cost of repairs for uniform contact of temporary steel plate to the top of structures.

The Engineer will measure **Dr Structure, Adj, Add Depth**, of the required diameter and depth, beginning 6 inches from the level of the existing structure, in the direction of adjustment, to the limit of the additional adjustment depth. If the contract includes a pay item for **Dr Structure, Adj, Add Depth**, the contract will also include a pay item for **Dr Structure Cover, Adj**, of the case required. The unit price for **Dr Structure, Adj, Add Depth** includes the cost of drainage structure taps, within the limits of the adjustment.

The Department will pay for drainage structure taps outside the limits of the adjustment as **Dr Structure, Tap**. The Department will pay for taps to existing sewers as **Sewer Tap**, of the size required, in accordance with subsection [402.04](#).

**E. Drainage Structure, Temporary Lowering.** The unit price for **Dr Structure, Temp Lowering** includes the cost of the following:

1. Match marking;
2. Removing, salvaging, and transporting castings to and from site;
3. Storing the existing structure castings;
4. Plating the structure;
5. HMA patching; and
6. Removing the plate and HMA patching materials for final adjustment.

The Department will pay separately for the final adjustments to drainage structures. The unit price for **Dr Structure Cover, Adjust, Case 1** includes the cost of removing pavement to lower the structure.

The cost of repairs is included in unit price for the related drainage structure adjustment pay item.

**F. Cleaning Existing Drainage Structures and Leads.** The unit price for **Dr Structure, Cleaning** includes the cost of testing for disposal, hauling and disposing of generated waste.

The unit price for **Dr Structure Lead, Cleaning**, of the size required includes the cost of testing for disposal, hauling and disposing of generated waste.

The Department will pay separately for placing and removing temporary bulkheads.

The cost for cleaning out existing sewers, plugged by Contractor operations, is included in related pay items.

The Department will pay for disposal of contaminated material, whether non-hazardous or hazardous, in accordance with subsection [109.05.D](#).

**Section 404. UNDERDRAINS**

**404.01. Description.** This work consists of constructing and installing underdrains, foundation underdrains, Prefabricated Drainage Systems (PDS), and underdrain outlets.

**404.02. Materials.** Provide materials in accordance with the following:

Mortar, Type R-2 ..... [702](#)  
 Granular Material Class II AA ..... [902](#)  
 Open-Graded Aggregate 34R ..... [902](#)  
 End Sections ..... [909](#)  
 Pipe for Underdrains ..... [909](#)  
 Rodent Screens ..... [909](#)  
 Underdrain Outlets ..... [909](#)  
 Drainage Marker Posts ..... [909](#)  
 Geosynthetics, PDS ..... [910](#)  
 Sod ..... [917](#)  
 Topsoil ..... [917](#)

A. **Pipe.** Provide geotextile-wrapped perforated pipe and tubing for underdrains, except if using with open-graded backfill material. For underdrain outlets, provide non-perforated pipe and tubing, not wrapped with geotextile. If using steel furnace slag for open-graded drainage course, provide the following slot or hole size and water inlet area for pipe.

| <b>Table 404-1</b>   |                                 |
|--|---------------------------------|
| <b>Pipe Opening Sizes for Steel Furnace Slag Open-Graded Drainage Course</b> |                                 |
| <b>Opening Type</b>  | <b>Size</b>                     |
| Slot width   | 1/16 in – 1/8 in                |
| Hole diameter  | 1/8 in – 3/16 in                |
| Water inlet area (min)   | 2 in <sup>2</sup> /ft of tubing |

B. **Aggregate for Trench Backfill.** Provide open-graded aggregate 34R to backfill the trench for an open-graded underdrain or PDS. Provide granular material Class II AA as backfill for other underdrains and underdrain outlets.

C. **Outlet Endings.** Provide a concrete ring, a steel end section, or a concrete end section for the outlet ending. Provide and install rodent screens on outlet endings.

**404.03. Construction.** The plans will show the locations for underdrain and underdrain outlets, or will establish a miscellaneous quantity of pipe for use on the project. The plans will show, or the Engineer will

determine, the line and grade of the underdrain. Place the outlets at the intervals shown on the plans and ensure the outlets drain.

**A. Trench Excavation.** Excavate underdrain trenches using a wheel or chain trencher, or other trenching method approved by the Engineer. Grade trench bottoms to the shape of the underdrain pipe.

Excavate PDS trenches 3 inches to 6 inches wide. Excavate a wider trench if wall collapse prevents backfill placement and compaction.

Line trenches for open-graded underdrains with geotextile blanket as required.

**B. Laying Underdrains.** Place the underdrains to the line and grade shown on the plans or established by the Engineer. Ensure a firm bearing along the length of the pipe. Place compatible end caps on the upgrade ends of the underdrain pipes. Remove and re-lay damaged or displaced pipe.

If the contract requires PDS as part of pavement rehabilitation, install PDS underdrain adjacent to the edge of the pavement. Install the PDS underdrain to the depth shown on the plans or directed by the Engineer.

Do not place equipment or materials on the installed PDS until after placement of the open-graded drainage course.

**C. Connections.** Select fittings and connection methods, in accordance with the underdrain system manufacturer's recommendations, to prevent pipe separation. Obtain the Engineer's approval of connection methods before beginning underdrain installation. Mechanically fasten connections between the underdrain and outlet pipes using aluminum blind rivets, stainless steel self-tapping screws, or interlocking parts.

Do not penetrate the inside diameter of the pipe with the self-tapping screws by more than  $\frac{1}{8}$  inch. Wrap fittings with geotextile blanket and seal the geotextile to the outlet pipe with waterproof tape.

**D. Backfill and Compaction.** Place backfill in trenches only after the Engineer approves the underdrain line and grade.

**1. Foundation, Bank and Subgrade Underdrains, and Underdrain Outlets.** Backfill the following using granular material Class IIAA:

- a. Foundation underdrains,
- b. Bank underdrains,
- c. Subgrade underdrains, and
- d. Underdrain outlets.

Place the granular material around the pipe to cover the drain with at least 12 inches of material. Place the remaining backfill in layers no greater than 12 inches. Compact the trench backfill material within the influence of the roadbed to 95 percent of the maximum unit weight. Compact trenches outside the roadbed as directed by the Engineer.

If the contract calls for open-graded subgrade underdrain and open-graded bank underdrain, place the open-graded aggregate 34R as shown on the plans and as required for open-graded underdrains.

2. **Open-Graded Underdrains.** Backfill pipe and PDS open-graded underdrains with open-graded aggregate 34R. Immediately after placing the backfill, compact the backfill and the surrounding grade material with a vibrating plate compactor. Begin compaction along the shoulder side of the underdrain and progress toward the pavement. Do not operate the compactor directly above the underdrain.

Maintain the exposed underdrain and backfill to prevent contamination.

If the Engineer determines the backfill is not clean, remove and replace the backfill at no additional cost to the Department. If the Engineer determines the underdrain is obstructed, clear the obstruction at no additional cost to the Department.

- E. **Underdrain Outlet.** Lay underdrain outlets on at least a 4 percent grade and install the underdrain outlet at least 4 inches above the receiving ditch or sewer flow line. If the Engineer determines that it is not practical to meet both the percent grade and the outlet elevation requirements, the Engineer may waive the percent grade requirement. Do not backfill the outlet trench until approved by the Engineer. Install underdrain outlets within 48 hours of installing adjoining longitudinal underdrains. Mark and maintain the outlets.

- F. **Outlet Endings.** Place the outlet endings as shown on the plans or as directed by the Engineer. Excavate areas requiring sod to at least 4 inches deep and place topsoil and sod in accordance with subsection [816.03](#). Install drainage marker posts in accordance with subsection [401.03.F](#).

If installing underdrains in conjunction with constructing or resurfacing concrete or HMA shoulders, mark the locations of outlet endings on the adjacent shoulder. Mark locations with a ½-inch deep, 4 inch by 6 inch depression. Place the long edge of the depression perpendicular to the

edge of the shoulder. The Engineer may approve the following alternative methods of marking locations.

1. Stencil markers in concrete shoulders after texturing.
2. Form markers in HMA shoulders during finish rolling. Obtain the Engineer's approval of forming method prior to beginning work.

G. **Cleanout.** Ensure installed underdrains and outlets are free of silt, debris, and other deleterious material at the time of final acceptance.

H. **Video Inspection of Underdrains.** The Department will perform video inspection of underdrains, underdrain outlets, and outlet endings after installation is complete.

The Department will perform video inspections of open-graded underdrains after the mainline pavement placement is complete, but before shoulder paving.

Submit a log detailing the locations of the drain outlets installed on the project to the Engineer. Ensure the drain outlet log includes locations for the bank drain outlets, subgrade and subbase underdrain outlets, and open-graded underdrain outlets.

1. **Deficiencies.** The Engineer will direct a more extensive video inspection with expanded video coverage if the video spot-checks reveal deficiencies. The Engineer will require corrective action, including excavation and repair or removal and replacement of the underdrain or underdrain outlets, if video inspection reveals any of the following deficiencies:

- a. Crushed pipe,
- b. Separated joints,
- c. Plugged underdrain or underdrain outlet pipe,
- d. Standing water greater than half the pipe diameter for greater than 25 feet, or
- e. Other defects in materials or workmanship as determined by the Engineer.

2. **Corrective Action.** Ensure the Engineer approves the repair or removal and replacement method before beginning corrective action. Complete corrective action within 10 working days of video inspection completion, or other date as approved by the Engineer.

Complete the following corrective action at no additional cost to the Department:

- a. Excavate;



- b. Repair or remove and replace defective underdrain, underdrain outlets and outlet endings;
- c. Backfill excavated areas;
- d. Replace and compact overlying fill, aggregate base separator course, and open-graded drainage course materials; and
- e. Replace geotextile separator as required.

If the finished shoulder material is in place when the Department discovers a deficiency, remove the shoulder material and replace in accordance with the contract documents, and at no additional cost to the Department.

**404.04. Measurement and Payment.**

| <b>Pay Item</b>                                  | <b>Pay Unit</b> |
|--|-----------------|
| Underdrain, Subgrade, __ inch .....              | Foot            |
| Underdrain, Bank, __ inch .....                  | Foot            |
| Underdrain, Subgrade, Open-Graded, __ inch ..... | Foot            |
| Underdrain, Bank, Open-Graded, __ inch .....     | Foot            |
| Underdrain, Fdn, __ inch .....                   | Foot            |
| Underdrain, Subbase, __ inch .....               | Foot            |
| Underdrain, Pipe, Open-Graded, __ inch .....     | Foot            |
| Underdrain, PDS, Open-Graded, __ inch .....      | Foot            |
| Underdrain, Edge of Pavt, __ inch .....          | Foot            |
| Underdrain Outlet, __ inch .....                 | Foot            |
| Underdrain, Outlet Ending, __ inch .....         | Each            |

The Engineer will measure underdrains in place.

The Engineer will measure **Underdrain Outlet**, of the size required, in place from the underdrain to the center of a drainage structure or from the underdrain to the end of the outlet pipe. In addition to work specified for individual pay items, the unit prices for the relevant underdrain and underdrain outlet pay items include the cost of the following:

- Excavating the trench;
- Providing and placing the pipe and fittings;
- Providing, placing, and compacting the backfill material; and
- Disposing of surplus material excavated from the trench.

The Department will not consider claims for additional compensation for time required to perform video inspection or to repair, or remove and replace deficient underdrain, underdrain outlets, and overlying materials. If the Department has performed video inspection inconsistent with the approved progress schedule, the Department may grant a time extension.

A. **Subgrade, Bank, Foundation, and Subbase Underdrains.** The unit prices for **Underdrain, Subgrade, Underdrain, Bank, Underdrain, Fdn,** and **Underdrain, Subbase,** of the sizes required include the cost of providing the pipe and fittings with a geotextile wrap.

B. **Underdrain, Pipe, Open-Graded.** The unit price for **Underdrain, Pipe, Open-Graded,** of the size required, includes the cost of providing and lining the trench with geotextile.

C. **Underdrain, PDS, Open-Graded.** The unit price for **Underdrain, PDS, Open-Graded** includes the cost of additional excavation and backfill to compensate for wall collapse or inability to obtain compaction.

D. **Underdrain Outlet.** The unit price for **Underdrain, Outlet,** of the size required, includes the cost of the following:

1. Locating installed outlets;
2. Maintaining the end of the outlet pipe or end section clear of obstructions; and
3. Providing and installing temporary tie-downs.

E. **Underdrain, Outlet Ending.** The unit price for **Underdrain, Outlet Ending,** of the size required, includes the cost of the following:

1. Excavating the area at the end of the outlet;
2. Providing and placing the concrete ring, steel end section, or concrete end section;
3. Providing and installing the rodent screen; and
4. Disposing of surplus excavated material.

The Engineer will measure, and the Department will pay for pipe or tubing used in or through the outlet ending as **Underdrain Outlet.** The unit price for **Underdrain, Outlet Ending** includes the cost of marking the outlet ending locations on the adjacent shoulder.

The Engineer will measure, and the Department will pay for drainage marker posts in accordance with subsection [401.04](#).

**Section 405. PUMP STATION CONSTRUCTION**

**405.01. Description.** This work consists of constructing pump stations in accordance with the contract.

**405.02. Materials.** Provide material as required by the contract.

**405.03. Construction.** Construct pump houses as required by the contract.

**405.04. Measurement and Payment.** The Engineer will measure and the Department will pay for pump houses in accordance with the contract.

## Section 406. PRECAST THREE-SIDED, ARCH, AND BOX CULVERTS

**406.01. Description.** This work consists of the following:

- A. Designing, load rating, manufacturing, and constructing precast three-sided, arch, and concrete box culverts and appurtenances;
- B. Providing dewatering;
- C. Maintaining the water flow during construction stages; and
- D. Providing and installing gaskets and geotextile fabric to seal culvert joints.

**406.02. Materials.** Provide materials in accordance with the following:

|   |                     |
|---|---------------------|
| Concrete .....                              | <a href="#">701</a> |
| Mortar, Type R-2 .....                      | <a href="#">702</a> |
| Cement Type I, Type III .....               | <a href="#">901</a> |
| Granular Material Class II, III, IIIA ..... | <a href="#">902</a> |
| Coarse Aggregate 6A, 6AA, 17A .....         | <a href="#">902</a> |
| Fine Aggregate 2NS .....                    | <a href="#">902</a> |
| Open-Graded Aggregate 34R .....             | <a href="#">902</a> |
| Concrete Admixtures .....                   | <a href="#">903</a> |
| Fly Ash .....                               | <a href="#">903</a> |
| Asphaltic Materials .....                   | <a href="#">904</a> |
| Steel Reinforcement .....                   | <a href="#">905</a> |
| Sealers for Culvert Joints .....            | <a href="#">909</a> |
| External Rubber Gaskets .....               | <a href="#">909</a> |
| Geosynthetics .....                         | <a href="#">910</a> |

Provide natural coarse aggregate for 6A, 6AA, and 17A, in accordance with subsection [902.02](#). Provide aggregate with a gradation meeting Michigan Series 6AA or 17A, the physical requirements of 6AA, and not exceeding the following nominal maximum size requirements:

- A. One-fifth the narrowest dimension between forms,
- B. One-third the depth of slabs, and
- C. Three-quarters the minimum clear spacing between individual reinforcing bars or wires.

Ensure the Freeze-Thaw Dilation, percent per 100 cycles does not exceed 0.030 percent.

Provide steel with a minimum yield strength of 65,000 psi for welded wire fabric and 60,000 psi for deformed billet-steel bars.

Provide  $\frac{3}{4}$ -inch or 1-inch diameter inserts or a Department-approved equal.

Provide epoxy coated steel in headwalls exposed to traffic.

### **406.03. Construction.**

A. **Design.** Ensure a professional engineer, licensed in the state of Michigan, seals the design for precast three-sided, arch, and box culverts.

1. **Precast Three-Sided and Arch Culverts.** Provide culverts with the rise, span, skew angle, and minimum waterway area shown on the plans. Obtain the Engineer's approval for larger spans or rises.

Select a Department-approved culvert design and manufacture at a Department-approved commercial precast concrete plant.

Certify the precast three-sided or arch culvert design in accordance with current AASHTO LRFD Bridge Design Specifications and ASTM C 1504. Base the design on the AASHTO loads shown on the plans. Investigate all load factor combinations to produce the positive and negative extremes (minimum load factors applied to loads that reduce the force effect being investigated). Include with the certification, in tabular format, the maximum factored inward and outward horizontal forces, and vertical forces, at the base of the culvert wall. Ensure the maximum factored horizontal and vertical forces are less than the horizontal and vertical capacities of the footings, as shown on the plans. Ensure the footing dimensions, including width, depth, and keyway size, and footing concrete compression strength, as shown on the plans, are compatible with the culvert design. Determine maximum inward and outward horizontal forces by appropriate usage of minimum and maximum load factors. Submit all design calculations for the culvert sections, headwalls, and wingwalls. Design headwall connections and wingwalls for sliding and overturning.

2. **Precast Concrete Box Culverts.** Design precast box culverts in accordance with current AASHTO LRFD Bridge Design Specifications and ASTM C 1577. Design the culvert to carry live loads as specified in Table 1 of ASTM C 1577. As an alternative to using the design tables in ASTM C 1577, the Contractor may use the current version of the FHWA approved LRFD BOXCAR program to design culverts provided the design includes HL-93 live load without lane load and dynamic load allowance as defined in the AASHTO LRFD Specifications.

The Department will not allow precast concrete box culverts manufactured using dry cast methods.

Ensure the joint design accommodates the joint sealing material required, and conforms to Section 8 of ASTM C 1577.

**B. Shop Drawings.** Submit shop drawings for culverts greater than 10 feet in span length to the Engineer, for review and approval in accordance with subsection [104.02](#). Do not begin fabrication until receipt of written approval of the shop drawings from the Engineer.

Include the following in the shop drawings:

1. Load ratings using as-designed conditions;
2. Design assumptions;
3. Design loads;
4. Design calculations;
5. Culvert dimensions;
6. Details of the concrete mix design;
7. Methods of manufacture;
8. Method of joining adjacent culvert elements, if required;
9. Recommended installation procedures; and
10. The manufacturer's minimum depth of fill required for construction traffic over the culvert.

Provide shop drawings that show insert details and connection details for attaching head walls, wing walls, aprons and curtain walls, as shown on the plans.

The Contractor may submit shop drawings for cast-in-place head walls, wing walls, aprons, and curtain walls as an alternative to precast sections shown on the plans.

Call attention to deviations from the contract on the shop drawings. If deviations are not clearly identified, the Department will not consider the deviations as part of the shop drawing approval.

### **C. Load Rating.**

1. **Load Rating Procedure.** Meet legal loads and class A overloads. Before manufacture, perform load ratings on precast three-sided, arch or box culverts greater than 10 feet in span length, in accordance with the AASHTO Manual of Bridge Evaluation, Section 6, Part A, the Michigan Bridge Analysis Guide current at the time load rating is performed, and the Michigan Structure Inventory and Appraisal Guide. Use as-designed conditions and assume an in-place future wearing surface to calculate the following ratings:
  - a. The Inventory Rating, National Bridge Inventory (NBI) Item 66;
  - b. The Operating Rating, NBI Item 64;
  - c. The Michigan Operating Rating, MDOT Item 64M; and

d. The Michigan Overload Class, MDOT Item 193.

After construction, review the load rating for as-constructed conditions, using as-constructed conditions, and as-constructed conditions with placement of future wearing surfaces.

2. **Load Rating Documentation.** Before manufacture, deliver the following information to MDOT in paper or electronic format:
  - a. Assumption sheet – A list of assumptions made in the analysis regarding material properties, vehicle configurations, live load factors, live load distribution, and other factors;
  - b. Program or calculation input and output; and
  - c. A complete Bridge Analysis Summary Form.

Resubmit Load Rating Documentation including any changes from as-designed conditions to as-constructed conditions impacting load ratings. Ensure a professional engineer, licensed in the state of Michigan, seals the load ratings.

#### D. **Manufacture.**

1. **Placement of Reinforcement.** Provide concrete cover for welded wire fabric reinforcement at least three times the wire diameter and at least 1 inch thick. For the reinforcement in the top of the top slab of structures covered by less than 2 feet of fill, provide a minimum concrete cover of at least 2 inches. Assemble reinforcement using a maximum of three layers of welded wire fabric.

The Contractor may use a single layer of deformed steel bars instead of welded wire fabric.

If using deformed steel bars, provide a minimum concrete cover of 2 inches. Ensure the ends of the longitudinal reinforcement are no greater than 2 inches from the ends of the culvert section. The Department will not consider exposure of the ends of longitudinal reinforcement, or spacers used to position the reinforcement, as cause for rejection.

2. **Reinforcement Development Length, Splices and Spacing.** Develop the exterior corner reinforcement and splice circumferential reinforcement in accordance with the current AASHTO LRFD Bridge Design Specifications.

For circumferential reinforcement composed of bars, meet the crack control criteria in the current AASHTO LRFD Bridge Design Specifications. Perform and submit calculations to the Department verifying that proposed bar spacing meets crack control criteria.

3. **Placement of Protective Sealant Coating.** Place the protective sealant coating on the exterior top surface of precast units as required by the contract.
4. **Joints.**
  - a. **Precast Three-Sided and Arch Culverts.** Provide a 1 inch by 1 inch or  $\frac{3}{4}$  inch by  $\frac{3}{4}$  inch beveled edge on the external surface of the joint formed between the culvert units.
  - b. **Precast Box Culverts.** Provide tongue and groove ends.
5. **Concrete.** Unless otherwise shown on the plans, the precast culvert manufacturer is responsible for the concrete mix design with 28-day compressive strength of at least 5,000 psi and containing 6.5 percent  $\pm$  1.5 percent entrained air. If using Type F or Type G admixtures, the Department will allow a maximum air entrainment of 8.5 percent.  
Proportion and mix cement, aggregate, admixtures, and water to produce a homogeneous concrete that meets strength requirements.
6. **Forms.** Use rigid forms to maintain the culvert dimensions within the tolerances specified in subsection [406.03.E](#). Use a smooth material for forming surfaces.
7. **Curing.** Cure culvert sections to ensure the required compressive strength. Use one of, or a combination of, the following curing methods.
  - a. Low pressure steam-cure the culvert sections in accordance with subsection [708.03.A.11](#).
  - b. Water cure the culvert sections using methods that maintain continuous moisture on the sections for at least 7 days.
  - c. Accelerate overnight curing using an external heat source, while minimizing moisture loss from exposed surfaces. Apply the initial heating 2 hours after final concrete placement.
  - d. Apply a sealing membrane that conforms to ASTM C 309.
8. **Handling.** Handle the culverts using a method approved by the manufacturer and Engineer. Do not drill holes for handling the precast unit.

Fill holes using one of the following methods before placing backfill:

- a. Fill holes with Type R-2 mortar.
- b. Fill tapered holes with concrete plugs, and secure with Type R-2 mortar, or other approved adhesives.
- c. Fill holes with neoprene plugs, wedged tightly in the holes to eliminate annular space. Affix a 9 inch by 9 inch rubber gasket



and 24 inch by 24 inch piece of geotextile fabric to the culvert segment, centered over the plug and installed as specified by the manufacturer.

9. **Product Marking.** Use a method approved by the Engineer, to mark the interior of each precast unit with the following information:
    - a. Span and Rise,
    - b. Date of manufacture,
    - c. Name or trademark of the manufacturer, and
    - d. Design earth cover.
- E. **Tolerances.** Ensure precast elements meet the tolerances specified by the designer and the following:
1. **Internal Dimensions.** Manufacture precast elements so the internal dimensions do not vary from the design dimensions by more than 2 inches. For culverts with haunches, ensure haunch dimensions do not vary more than  $\frac{3}{4}$  inch from the dimensions shown on the shop drawings.
  2. **Slab and Wall Thickness.** Manufacture precast elements so the slab and wall thicknesses do not vary from the dimensions shown on the shop drawings by more than 5 percent or  $\frac{1}{2}$  inch, whichever is greater. The Engineer will not consider slabs and walls thicker than the required dimension as cause for rejection, unless, in the opinion of the Engineer, the thickness variation prevents joint sealing.
  3. **Length of Opposite Surfaces.** Manufacture precast elements so the laying lengths of two opposite culvert section surfaces do not vary by more than 1 inch.
  4. **Length of Section.** Manufacture precast elements so the underrun from the required length measures no greater than  $\frac{1}{2}$  inch.
  5. **Position of Reinforcement.** Manufacture precast elements so the position of reinforcement does not vary more than  $\frac{1}{2}$  inch. If the depth of cover over the top surface is less than 24 inches, ensure at least a 2 inch concrete cover over the top slab reinforcement.
- F. **Testing and Inspection.**
1. **Testing.** Test the concrete for compressive strength in accordance with Section 10 of ASTM C 1504 for precast three-sided and arch culverts, and Section 10 of ASTM C 1577 for precast box culverts.
  2. **Workmanship, Finish and Appearance.** Provide a smooth finish on the culvert surfaces, free of fractures. Fabricate culvert ends

normal to the walls and centerline, within the required tolerances, unless the culvert is designed for skewed crossings.

3. **Repairs.** Repair manufacturing imperfections, handling damage, or construction damage to culverts as approved by the Engineer, in accordance with section [712](#), and at no additional cost to the Department.
4. **Rejection.** The Engineer may reject precast three-sided, arch, and box culverts due to the following:
  - a. Fractures or cracks in the slab or wall;
  - b. Defects that indicate imperfect proportioning, mixing, or forming;
  - c. Honeycombed or open textured surfaces;
  - d. Damaged ends preventing required joint construction;
  - e. Concrete that does not attain the required compressive strength;
  - f. Out of tolerance dimensions;
  - g. Low or high air content; or
  - h. Exposed reinforcing steel.
5. **Quality Assurance.** For culvert spans greater than 20 feet, provide the Department access to perform quality assurance inspection. Notify the Engineer at least 2 weeks before beginning fabrication. The Department does not consider this inspection a substitute for the manufacturer's quality control requirements.
- G. **Installation.** Construct the culvert in accordance with section [206](#) and section [706](#), as shown on the plans, and as specified in this subsection.

Perform dewatering or pumping and temporary drainage to maintain stream flow during construction. During dewatering or pumping and temporary drainage operations, avoid damaging adjacent property or structures and interfering with the rights of the public, adjacent property owners, vehicular traffic, or other contractors. Do not disturb the soil under and next to existing structures during dewatering and temporary pumping operations. Direct water from dewatering operations through a filter bag before discharging to an existing drainage facility. Do not overload or obstruct existing drainage facilities.

Construct the wingwalls, headwalls, and aprons for precast concrete culverts with a positive connection to the adjoining precast section as shown on approved shop drawings. Use  $\frac{3}{4}$ -inch or 1-inch diameter threaded bars to make the connection, unless otherwise shown on the plans.

Lay the culvert sections in stages to coincide with maintaining traffic, dewatering, temporary pumping, and part width phased construction sequencing, and as approved by the Engineer.

The Contractor may use precast wing walls, headwalls, and aprons, as alternatives to cast-in-place wingwalls, headwalls, and aprons. Attach precast wing walls or headwalls as shown on the shop drawings.

Place backfill in accordance with subsection [206.03](#). Place and compact backfill on opposite sides of the culvert at the same time, so backfill levels on opposite sides do not differ by more than 2 feet. Hand compact backfill within 1 foot of the structure. Use vibratory compactors meeting the culvert manufacturer's specifications.

The Contractor is responsible for construction traffic on the culvert.

Do not exceed the maximum design loads, as noted on the shop drawings, with construction traffic. Replace damaged units at no additional cost to the Department.

1. **Precast Three-Sided and Arch Culverts.** Construct the footing from cast-in-place concrete in accordance with the contract. Construct the footing keyway level to minimize the height of the shims for leveling the precast sections. The Engineer may approve alternate procedures that provide a uniform bed of Type R-2 mortar under the culvert sections.

Before placing the culvert sections onto the footing, survey the surface of the keyway and locate the high spot. Use the high spot as the control elevation for the bottom of the culvert sections. Add 1 inch to the high spot and place shims to that elevation. Use shims that are not susceptible to corrosion. Ensure the shims maintain the elevation of the culvert until the mortar surrounding the shims cures.

Set the shims 12 inches from each corner of the culvert sections. If installing the culvert sections on a sloping grade, establish elevation control points at 50-foot increments and run a string line between these elevations to set other shims. Provide joints no greater than 1 inch wide. After placing the culvert sections, grout underneath the culvert leg sections, and to the tops of the sides of the keyway with Type R-2 mortar. Grout by mounding the mortar on one side of the leg and vibrating until it passes through to the other side of the leg. If mortar does not pass through the leg, repeat the process on the other side.

Before sealing joints between adjacent culvert sections, provide smooth surfaces, free of debris. If using cast-in-place headwalls or

wingwalls, seal the joints between the culvert elements and headwalls, and the joints between headwalls and wingwalls. Make the joints watertight.

If using precast headwalls or wing walls, seal the joints between the culvert elements and headwalls, and the joints between headwalls and wingwalls, watertight using the same method for joints between adjacent culvert sections.

Seal the joints between the adjacent precast culvert sections using a  $\frac{7}{8}$  inch by  $1\frac{3}{8}$  inch butyl rope conforming to ASTM C 990. Place the butyl rope between the units in the bevel.

If the manufacturer recommends sealing joints using non-shrink grout, and if approved by the Engineer, the Contractor may omit the butyl rope.

Cover the butyl rope with an external type rubber gasket at least 9 inches wide, conforming to ASTM C 877, centered over the joint. Use a primer compatible with the rubber gasket to secure the gasket. Install the gasket in accordance with the manufacturer's recommendations. Cover the joint with a 24-inch wide strip of geotextile blanket centered over the joint.

Make the completed joint watertight. The Engineer will consider the joint watertight if no visible signs of leakage appear around the joint for the duration of the project. If the joint is not watertight, create a watertight seal at no additional cost to the Department.

If limited spacing between culvert legs of adjacent spans of multiple span structures prevents sealing culvert leg joints for adjacent spans, use self-compacting engineered fill to prevent leakage of fill through joints. Prevent migration of fines through the engineered fill.

2. **Box Culverts.** Construct culvert bedding for the box culvert structure as shown on the plans. Use at least 9 inches deep, coarse aggregate 6A, at least 80 percent crushed, covered with 3 inches of open-graded aggregate 34R to construct the bedding. Before placing the open-graded aggregate 34R, compact the coarse aggregate 6A using at least three passes of a vibrating plate compactor. Compact the open-graded aggregate 34R using at least one pass of a vibrating plate compactor. If unstable soil conditions or obstructions other than rock require excavation of the trench below the elevation shown on the plans, undercut, backfill, and compact the trench as directed by the Engineer. Use 6A, 17A, or 34R aggregate as backfill material for undercutting.

Fill the space between the box culvert joints during placement of box sections with closed-cell rubber extrusion type gaskets in accordance with AASHTO M 198. Use the gasket sizes and installation methods recommended by the manufacturer and approved by the Engineer. After placement, treat every precast concrete box culvert exterior joint with cold applied culvert joint sealer and cover with a 36-inch strip of geotextile blanket centered on the joint.

**406.04. Measurement and Payment.**

| <b>Pay Item</b>   | <b>Pay Unit</b> |
|---|-----------------|
| Culv, Precast Three-Sided or Arch, (span) foot × (rise) foot..... | Foot            |
| Culv, Precast Conc Box, (span) foot × (rise) foot.....            | Foot            |
| Culv Bedding, Box Culv.....                                       | Cubic Yard      |

**A. Precast Three-Sided or Arch Culvert.** The Engineer will measure **Culv, Precast Three-Sided or Arch** along the centerline of the structure, from fascia to fascia. The Department will pay for **Culv, Precast Three-Sided or Arch**, of the type required, in accordance with the span-rise combination shown on the plans. The unit price for **Culv, Precast Three-Sided or Arch** includes the following:

1. Designing, manufacturing, load rating, and installing precast elements;
2. Headwalls and wing walls, precast or cast-in-place;
3. Providing and placing shims to level the precast elements;
4. Type R-2 mortar;
5. Joint sealer;
6. Inserts;
7. Required geotextile blankets;
8. Dewatering and maintaining the stream flow during construction stages; and
9. Providing plan modifications, including design, plan quantities, and pay items, to accommodate precast units.

The Department will pay for **Culv, Precast Three-Sided or Arch** by plan quantity in accordance with subsection [109.01.A](#).

The Department will pay separately for cast-in-place concrete, other than for culvert segments, wingwalls, and headwalls; excavation; protective coating; providing and placing backfill material, including engineered fill between adjacent spans and drainage materials; by plan quantity in accordance with subsection [109.01.A](#).

B. **Box Culvert.** The unit price for **Culv, Precast Conc Box** includes the cost of the following:

1. Designing, manufacturing, load rating, and installing the precast elements;
2. Cold applied culvert joint sealer;
3. Closed-cell rubber extrusion type gaskets;
4. Geotextile pipe wrap for box culvert joints;
5. Inserts for bars; and
6. Dewatering and maintaining the stream flow during construction stages.

The Department will pay separately for excavation and backfill.

The Department will pay for cast-in-place wingwalls, headwalls, aprons, and curtain walls provided as an alternative to precast equivalents, as the corresponding cast-in-place wing wall, headwall, apron, and curtain wall pay items.

The unit prices for trench undercut and backfill pay items include undercutting, backfilling, and compacting trenches excavated due to unstable soil conditions or obstructions other than rock, in accordance with subsection [402.04.E](#).

C. **Culvert Bedding, Box Culvert.** The Engineer will measure **Culv Bedding, Box Culv** by volume compacted in place to the depth, length, and width shown on the plans or as directed by the Engineer. The unit price for **Culv Bedding, Box Culv** includes placement and compaction of the coarse aggregate 6A and open-graded aggregate 34R.

D. **Rock Excavation.** The Engineer will measure and the Department will pay separately for rock excavation in accordance with subsection [205.04](#).

## NOTES

**DIVISION 5 – HOT MIX ASPHALT PAVEMENTS & SURFACE  
TREATMENTS**

| <b>Section</b> | <b>Title</b>                         | <b>Page No.</b>            |
|----------------|--------------------------------------|----------------------------|
| 501            | Plant Produced Hot Mix Asphalt ..... | <a href="#"><u>231</u></a> |
| 502            | HMA Crack Treatment .....            | <a href="#"><u>250</u></a> |
| 503            | Paver Placed Surface Seal .....      | <a href="#"><u>255</u></a> |
| 504            | Micro-Surfacing .....                | <a href="#"><u>260</u></a> |
| 505            | Chip Seals .....                     | <a href="#"><u>271</u></a> |
| 506            | Slurry Seal .....                    | <a href="#"><u>279</u></a> |



## NOTES

## Section 501. PLANT PRODUCED HOT MIX ASPHALT

**501.01. Description.** This work consists of providing and placing Hot Mix Asphalt (HMA) mix using Superpave Mixture Design Methods.

### A. Terminology.

**Broken Aggregate.** Cracked aggregate caused by construction operations.

**Crack.** A visible fissure of varying length and orientation in the HMA, partially or completely through at least one course.

**Flushing.** A shiny or reflective condition, tacky to the touch, appearing on the HMA surface when asphalt binder collects in the voids at high pavement temperatures.

**HMA Mix Design.** The selection and proportioning of aggregates, mineral filler, Reclaimed Asphalt Pavement (RAP), and asphalt binder to meet the mix design criteria required by the contract.

**HMA Segregation.** Areas of HMA pavement exhibiting non-uniform distribution of coarse and fine aggregate particles, visually or otherwise identifiable.

**Job Mix Formula (JMF).** An HMA mix for a specific project, including adjustments to optimize the field application.

**Lot.** A discrete tonnage of one mix, typically made up of five sublots.

**Pavement.** The completed HMA placement, including layers on driving lanes and shoulders.

**Pavement Edge.** The extremity boundaries of the pavement.

**Roller Cracking.** High density surface map-cracking that appears immediately after rolling.

**Rutting.** A depression or displacement of the HMA surface that occurs in a longitudinal direction or a localized area.

**Sublot.** A portion of a lot represented by a complete set of quality assurance tests.

**Target Value.** A JMF parameter value that may be adjusted, if approved by the Engineer, to account for changes in the physical properties of the mixture.

**501.02. Materials.** Provide materials in accordance with the following:

Superpave HMA Mixtures..... [902](#)

|                               |                     |
|-------------------------------|---------------------|
| Superpave Aggregates.....     | <a href="#">902</a> |
| Mineral Filler, 3MF.....      | <a href="#">902</a> |
| Anti-Foaming Agent.....       | <a href="#">904</a> |
| Asphalt Binders .....         | <a href="#">904</a> |
| Bond Coat, SS-1h, CSS-1h..... | <a href="#">904</a> |

Plant produced HMA consists of asphalt binder, aggregates, mineral filler, and other additives.

Provide release agents that do not harm the HMA mixture. Do not use fuel oil or other distillate derivatives.

Provide the HMA mix type and the performance grade of asphalt binder as required by the contract.

Provide blended aggregates for HMA top course mixtures, except top courses for shoulders, bike paths, temporary roads, and parking areas, meeting the required Aggregate Wear Index (AWI).

#### A. **Composition of HMA Mixtures.**

1. **Mix Design.** Develop an HMA mix design in accordance with the [HMA Production Manual](#) and submit to the Department. The Department will evaluate the design in accordance with Section 1 of the [HMA Production Manual](#), "Procedures for HMA Mix Design Processing."

Provide written certification that the materials in the mix design are from the same source and meet the material properties in the mix design or the Department-approved JMF. Ensure that all JMF adjustments are in accordance with the [HMA Production Manual](#).

The Contractor may use mix designs approved by the Department on other projects, if approved by the Engineer. Provide combined aggregate blends meeting the properties specified in section [902](#). Provide a mix design that meets the requirements of Table 501-1, Table 501-2, and Table 501-3 as applied to combined aggregate blends.

For mix design purposes, top and leveling courses are the mix layers within 4 inches of the surface. The base course consists of the layers below 4 inches from the surface. For mix layers within the 4-inch threshold, if less than 25 percent of the mix layer is within 4 inches of the surface, the mix layer is a base course.

For projects that specify a mix type E03, the Contractor may use a mix type LVSP.

If High Stress HMA is shown on the plans, provide the same mix design as required for the mainline top and leveling courses, except change the performance graded binder as shown on the HMA application table.

| <b>Table 501-1<br/>Superpave Mix Design Criteria</b>   |                     |          |          |          |             |
|--|---------------------|----------|----------|----------|-------------|
| <b>Design Parameter</b>  | <b>Mix Number</b>   |          |          |          |             |
|  | <b>5</b>            | <b>4</b> | <b>3</b> | <b>2</b> | <b>LVSP</b> |
| Percent of Maximum Specific Gravity (%G <sub>mm</sub> ) at the design number of gyrations, (N <sub>d</sub> ) (c)   | 96.0% (a)           |          |          |          |             |
| %G <sub>mm</sub> at the initial number of gyrations, (N <sub>i</sub> )   | See Table 501-3     |          |          |          |             |
| %G <sub>mm</sub> at the maximum number of gyrations, (N <sub>m</sub> )   | 98.0%               |          |          |          |             |
| VMA min % at N <sub>d</sub> (based on aggregate bulk specific gravity, (G <sub>sb</sub> )) (c)   | 15.00               | 14.00    | 13.00    | 12.00    | 14.00       |
| VFA at N <sub>d</sub>  | See Table 501-2 (b) |          |          |          |             |
| Fines to effective asphalt binder ratio (P <sub>No200</sub> /P <sub>be</sub> )   | 0.6–1.2             |          |          |          |             |
| Tensile strength ratio (TSR)   | 80% min             |          |          |          |             |
| a. For mixtures meeting the definition for base course, design mixtures to 96.0% of Maximum Specific Gravity %G <sub>mm</sub> at the design number of gyrations, (N <sub>d</sub> ). During field production, increase %G <sub>mm</sub> at the design number of gyrations, (N <sub>d</sub> ) to 97.0%.<br>b. For base course or regressed shoulder mixtures, the maximum criteria limits do not apply.<br>c. Lower Target Air Voids by 1.0% if used in a separate shoulder paving operation, unless otherwise shown on the plans. |                     |          |          |          |             |

| <b>Table 501-2<br/>VFA Minimum and Maximum Criteria</b> |                 |                                       |                    |
|---|-----------------|---------------------------------------|--------------------|
| <b>Estimated Traffic<br/>(million ESAL)</b>             | <b>Mix Type</b> | <b>Top &amp; Leveling<br/>Courses</b> | <b>Base Course</b> |
| ≤0.3  | LVSP            | 70–80                                 | 70–80              |
| ≤0.3  | E03             | 70–80                                 | 70–80              |
| >0.3 – ≤1.0   | E1              | 65–78                                 | 65–78              |
| >1.0 – ≤3.0   | E3              | 65–78                                 | 65–78              |
| >3.0 – ≤10  | E10             | 65–78 (a)                             | 65–75              |
| >10 – ≤30   | E30             | 65–78 (a)                             | 65–75              |
| >30 – ≤100  | E50             | 65–78 (a)                             | 65–75              |
| a. The specified VFA range for mix Number 5 is 73%–76%. |                 |                                       |                    |

| Estimated Traffic<br>(million ESAL) | Mix Type | %G <sub>mm</sub> at (N <sub>i</sub> ) | Number of Gyration (a) |                |                |
|-------------------------------------|----------|---------------------------------------|------------------------|----------------|----------------|
|                                     |          |                                       | N <sub>i</sub>         | N <sub>d</sub> | N <sub>m</sub> |
| ≤0.3                                | LVSP     | 91.5%                                 | 6                      | 45             | 70             |
| ≤0.3                                | E03      | 91.5%                                 | 7                      | 50             | 75             |
| >0.3 – ≤1.0                         | E1       | 90.5%                                 | 7                      | 76             | 117            |
| >1.0 – ≤3.0                         | E3       | 90.5%                                 | 7                      | 86             | 134            |
| >3.0 – ≤10                          | E10      | 89.0%                                 | 8                      | 96             | 152            |
| >10 – ≤30                           | E30      | 89.0%                                 | 8                      | 109            | 174            |
| >30 – ≤100                          | E50      | 89.0%                                 | 9                      | 126            | 204            |

a. Compact mix specimens fabricated in the SGC to N<sub>d</sub>. Use height data provided by the SGC to calculate volumetric properties at N<sub>i</sub>. Compact mix specimens at optimum P<sub>b</sub> to verify N<sub>m</sub> for mix design specimens only.

2. **Recycled Mixtures.** The Contractor may substitute Recycled Asphalt Pavement (RAP) for a portion of the new material required to produce HMA mixture. Design and produce the mix to meet the criteria in this subsection and the contract.

- a. **Stockpile Requirements.** Process RAP to the size required for the specified HMA mix. Ensure the stockpile contains enough material to produce the recycled mixtures the Engineer approves for the project. If the RAP stockpile is not sufficient to produce recycled mix quantities required for the project, provide an Engineer-approved mix design without RAP at the same unit price.

Provide documentation of testing and accumulated tonnage in the stockpile to the MDOT laboratory. The Contractor may estimate the tonnage. The Department will begin evaluating the mix design after receipt of the documentation.

- b. **Mix Design.** Submit required documentation for recycled mix designs in accordance with Section 1 of the [HMA Production Manual](#), "Procedures for HMA Mix Design Processing."

**B. HMA Plant Certification.** Ensure hot mix asphalt plants are certified by the Department at least 3 work days before mix production begins. The Engineer will certify hot mix asphalt facilities in accordance with Section 2 of the [HMA Production Manual](#), "Certification Procedure of HMA Plants." Post a seal of certification in the plant control office.

**C. HMA Production.** Submit an approved mix design for the mix required to the Engineer at least 2 work days before production begins.

Ensure even heating of the mass of asphalt binders and maintain heat control. Heat asphalt binders to the temperature required for the type of binder, except ensure that neither the asphalt binder nor the HMA

exceed the maximum temperature specified in Table 904-7. The Department will reject asphalt binder and mix if the temperature exceeds the maximum specified in Table 904-7. The Department will reject contaminated asphalt binder.

Stockpile aggregates at the facility, in a manner that prevents segregation. Dry aggregates to a moisture content that will ensure an appropriately coated HMA mix. For batch and continuous plants, the Department will reject aggregates in the hot bins that contain sufficient moisture to cause foaming or a water-saturated mixture. Remove rejected materials from the bins.

Place uniform gradations of aggregates in the cold feed system. If providing a blend of aggregates for the mix by combining aggregates from at least two cold feed bins, ensure the blend meets the combined gradation (from JMF) quality control tolerances.

The Engineer will allow the use of at least one hot aggregate bin to proportion aggregates to meet the JMF tolerances, if the cold feed requirements are met.

### **501.03. Construction.**

**A. Equipment.** Provide equipment in accordance with section [107](#), capable of producing pavement that meets the requirements of this section.

1. **Cold-Milling Machines.** Provide equipment that consistently removes the HMA surface, in one or more passes, to the required grade and cross section, and produces a uniformly textured surface. Provide machines equipped with the following:
  - a. Automatically controlled and activated cutting drums, and
  - b. Grade reference and transverse slope control capabilities.
2. **Hauling Equipment.** Ensure transport trucks are equipped to protect the mix from the weather and retard the loss of heat.
3. **Pressure Distributor.** Provide a pressure distributor in accordance with subsection [505.03.A.1](#).
4. **Pavers.** Equip each paver with a full-width vibratory or tamper bar screed capable of spreading and finishing HMA to the required cross section and grade. Use a paver that produces a uniformly finished surface, free of tears, other blemishes, and measurable segregation.

Equip the paver to provide a uniform head of material ahead of the screed. Install reverse pitch augers or paddles inside the ends of the auger shafts to force the mix to the center of the main screed.

Ensure extensions, added to the main screed, provide the same vibrating or tamping action and heating capabilities as the main screed. Adjust extensions to the main screed so, after breakdown rolling, no longitudinal marks remain on the surface. Equip in-line screed extensions with a continuation of the automatically controlled spreading augers to within 12 inches of the outside edge. Follow the manufacturer's recommendations for other screed extensions.

Except for the paving operations listed in subsection [501.03.F.1.a](#) through subsection [501.03.F.1.d](#), equip pavers with an automatically controlled and activated screed with grade reference and transverse slope control. Use an Engineer-approved grade referencing attachment, at least 30 feet long, for lower courses and the first pass of the top course. Ensure the Engineer approves alternate grade referencing attachments before use.

After placing the first pass of the top course, the Contractor may, with prior approval from the Engineer, substitute a joint matcher, a grade referencing attachment at least 10 feet long, or other grade referencing equipment for constructing adjacent passes of the top course.

## 5. Rollers.

- a. **Steel-Wheeled Rollers.** Provide self-propelled vibratory steel-wheeled rollers, static tandem rollers, or self-propelled static three-wheeled rollers. Provide a steering device that allows the roller to follow the established alignment. Equip rollers with wheel sprinklers and scrapers. Provide smooth roller wheels, free of openings or projections that will mar the pavement surface.

Provide vibratory rollers with an automatic shutoff to deactivate the vibrators if the roller speed decreases below ½ mph. Provide rollers that operate in accordance with the manufacturer's recommended speed, impacts per foot, and vibration amplitude for the thickness of HMA mix.

- b. **Pneumatic-Tired Rollers.** Provide self-propelled pneumatic-tired rollers. Equip rollers with at least seven wheels spaced on two axles so the rear group of tires does not follow in the tracks of the forward group, providing at least ½-inch tire path overlap. Provide smooth tires capable of being inflated to the pressure recommended by the roller or tire manufacturer. Equip the rollers with a mechanism that can smoothly reverse the motion of the roller.

Equip the rollers with wheel scrapers and skirting to enclose the wheels to within 3 inches of the pavement surface. Use a release agent to prevent material from sticking to the tires and being deposited on the top course pavement during rolling.

- c. **Combination Rollers.** The Contractor may use combination pneumatic-tired and steel-wheeled rollers manufactured specifically for HMA compaction, if equipped with the required sprinklers and scrapers.
  6. **Spreaders.** Use self-propelled spreaders capable of pushing the hauling units. Ensure spreaders can maintain the required width, depth, and slope, without causing segregation.
  7. **Material Transfer Device.** When a Material Transfer Device (MTD) is required, it must be capable of delivering HMA mix from the truck transport to the paver hopper to ensure constant paver speed, remixing HMA material using manufacturer's developed technology, and depositing material in the paver hopper. Provide a paver hopper insert with at least a 10 ton capacity in the paver and keep at least one-third full of mix during paving.
  8. **Compressed Air System.** If a compressed air system is required for cleaning pavement, equip the air compressor with a moisture separator to remove oil and water from the air supply. Provide a compressor capable of producing at least 100 psi and continuous 150 cfm airflow.
  9. **Miscellaneous Equipment.** Provide a straightedge at least 10 feet long and other tools to finish the work.
  10. **Lights on Equipment.** If maintaining traffic on HMA construction, equip equipment within the project, including cold-milling machines, distributors, and rollers, with at least one Department-approved flashing, rotating, or oscillating amber light. Equip pavers with at least one light on each side. Mount the lights so the warning signal is visible to traffic in every direction. Operate the lights while work is in progress. Ensure hauling units activate four-way flashers on the project.
- B. **Preparation of Base.** Provide subgrade, subbase, aggregate base course, crushed and shaped base, or rubblized base in accordance with the relevant sections of Division 2 and Division 3, before HMA placement.
- C. **Preparation of Existing Pavement.** Prepare the existing surface as required to construct HMA pavements, shoulders, and approaches.



1. **Drainage Structures, Monument Boxes, and Water Shutoffs.** Adjust, temporarily lower, or both, catch basins, manhole covers, monument boxes, and water shutoffs in accordance with subsection [403.03.A](#).

2. **Cleaning Pavement.** Using methods approved by the Engineer, clean dirt and debris from the pavement surface and paved shoulders before placing HMA. Remove loose material from joints and cracks using compressed air.

If the Engineer determines the compressed air system will not remove deleterious material, remove loose material by a hand or mechanical method, as approved by the Engineer. The Department will pay for removal of material by hand or mechanical methods in accordance with subsection [501.04.E](#).

Do not place HMA until the Engineer inspects and approves the condition of the existing pavement.

3. **Removing Existing Pavement for Butt Joints.** If a butt joint is required, remove the existing surface to the thickness of the proposed overlay, for the full width of the joint. Uniformly taper the removal to the original surface over at least 35 feet.
4. **Edge Trimming.** For required removal of HMA shoulder material or no greater than 1 foot width of HMA pavement, cut the HMA material full depth along the pavement edge or removal line to prevent tearing the pavement surface. Cut joints, where the completed surface will be exposed, with a saw, cold-milling machine, or other methods approved by the Engineer. Cut joints, where the completed surface will be covered by HMA mix, with a coultter wheel, saw, cold-milling machine, or other method approved by the Engineer.
5. **Cold-Milling HMA Surfaces.** Before milling existing pavement, obtain a Department-approved mix design in accordance with subsection [501.02.A](#), and ensure the availability of HMA mix quantities to cover milled surfaces.

Remove the HMA surface to the depth, width, grade, and cross section shown on the plans. Backfill and compact depressions resulting from removal of material below the specified grade, in accordance with subsection [501.03.C.9](#).

If the milling machine discovers buried structures within the specified grade, such as valve boxes, manholes, or railroad tracks that are not identified on the plans, the Department will pay for all associated costs, as extra work, in accordance with subsection [103.02](#).

Immediately after cold-milling, clean the surface. Dispose of removed material in accordance with subsection [104.07.D](#) and subsection [204.03](#).

6. **Removing HMA Surface.** Except as specified in subsection [501.03.C.4](#), removing HMA surface applies to removing HMA overlying a base course that is to remain in place.

Cut joints, exposed in the completed surface, with a saw or cold-milling machine. Cut joints, covered by HMA mix, with a coultter wheel, saw, or cold-milling machine. Obtain the Engineer's approval of alternate methods for cutting joints.

When removing HMA overlying a base course that is to remain in place, cut the edges of the surface requiring removal along straight lines for the full depth of the HMA surface.

When removing HMA by cold-milling, the Engineer may direct the Contractor to remove less than the full depth of HMA surface.

7. **Removing HMA Patches.** Remove patches that may compromise the performance of the overlay.
8. **Joint and Crack Clean Out.** If the plans show joint and crack clean out, use mechanical or hand methods to remove joint sealants to at least 1 inch deep. Remove vegetation, dirt, and debris that cannot be removed using the methods specified in subsection [501.03.C.2](#), from transverse and longitudinal joints and cracks. Use hand patching to fill cleaned joints and cracks at least 1 inch wide.
9. **Hand Patching.** If the contract requires hand patching, fill holes, depressions, joints, and cracks in the existing pavement and replace existing patches. Compact the hand patching material in no greater than 3 inch layers to the adjacent pavement surface grade using a machine vibrator or Department-approved roller. Use top course or other Engineer-approved mix for hand patching material.
10. **Repairing Pavement Joints and Cracks.** Repair joints and cracks as required.

D. **Bond Coat.** Uniformly apply the bond coat to a clean, dry, surface with a pressure distributor. Obtain the approval of the Engineer for the application rate after work begins. Apply the bond coat ahead of the paving operation to allow the bond coat to cure before placing HMA.

Do not leave pools of bond coat on the surface and do not spray the bond coat on adjacent pavement surfaces. Apply the bond coat to each

HMA layer and to the vertical edge of the adjacent pavement before placing subsequent layers.

**E. Transportation of Mixtures.** Weigh each load of HMA, accepted by the Department, to the nearest 20 pounds on an approved scale with an automatic printout system. Provide a scale and printout system for platform and suspended scales in accordance with subsection [109.01.B.6](#).

Apply a release agent, in accordance with subsection [501.02](#), to hauling units. The Engineer will reject loads with excessive amounts of release agent. Do not place crusted HMA in the paver.

The Department will reject loads with a temperature either below 250 °F or greater than  $\pm 20$  °F from the recommended maximum mixing temperature specified by the binder producer at the time of discharge from behind the screed.

#### F. Placing HMA.

1. **General.** Provide a pavement as shown on the plans.

Place HMA on a cured bond coat using pavers in accordance with subsection [501.03.A.4](#), unless placing mixtures for the following:

- a. Variable width sections;
- b. The first course of a base course mix on a subgrade or sand subbase;
- c. Base course mixtures for shoulders and widening less than 10½ feet wide; or
- d. Top and leveling course mixes for shoulders and widening less than 8 feet wide.

Place HMA mix in layers, and do not exceed the application rate. If the application rate for an HMA pavement exceeds the maximum rates specified in Table 501-4, and the edges are not confined, construct the pavement in at least two layers.

| Mix Number | Course Application | Application Rate, (lb/yd <sup>2</sup> )<br>minimum–maximum (a) |
|------------|--------------------|--|
| 2          | Base               | 435–550  |
| 3          | Base, Leveling     | 330–410  |
| 4          | Leveling, Top      | 220–275  |
| 5          | Top                | 165–220  |
| LVSP       | Leveling, Top      | 165–250  |
| LVSP       | Base               | 220–330  |

a. Minimum application rates do not apply to wedging courses.

Wedge with HMA to remove irregularities in the existing road surface. Place and compact HMA wedging to correct the foundation. Allow the wedging to cool enough to support construction equipment without causing visible distortion of the mat before placing subsequent wedging, base, leveling, or top course mixtures.

Place HMA mix to the slope and width shown on the plans. Place subsequent HMA course to align the vertical edge with the previous courses, without constructing a ledge. Correct ledges that result from placing material in excess of the width shown on the plans at no additional cost to the Department.

Place shoulder aggregate and compact flush after placement of each layer of HMA at the end of the paving day or place traffic control devices in accordance with subsection [812.03](#), at no additional cost to the Department. Complete final shaping and compaction of the shoulders after placing the top course of HMA.

If delays slow paving operations and the temperature of the mat immediately behind the screed falls below 200 °F, stop paving and place a transverse construction joint. If the temperature of the mat falls below 190 °F before initial breakdown rolling, remove and replace the mat at no additional cost to the Department.

If placing the uppermost leveling and top course, place the longitudinal joint to coincide with the planned painted lane lines.

If the temperature of the mat falls below 170 °F before placing the adjacent mat, apply bond coat to the vertical edge of the mat.

If constructing the lanes with at least two pavers in echelon, match the depth of loose HMA from each paver at the longitudinal joints.

Transition the new mat to existing surfaces at the beginning and end of resurfacing sections and at intersections unless using butt joints. Transition the new mat to existing surfaces at a rate of 1 inch over 35 feet. Construct transitions on a cured bond coat applied at a rate of 0.10 gallons per square yard. After compaction, spray with bond coat, sand, and roll the first 3 feet of the joint and 1 foot of the existing surface.

## 2. Joints in HMA Pavement.

- a. **Transverse Construction Joint.** If constructing a transverse construction joint, stop the paver and lift the screed before material falls below the auger shaft. Remove the paver and roll through the planned joint location. Cut a transverse vertical joint and remove excess HMA.

Place burlap, canvas, or paper as a bond breaker ahead of, and against the vertical face. Place HMA against the bond breaker and taper from the new mat to the existing surface. Extend the temporary taper 5 feet for each inch of mat thickness, or as directed by the Engineer. Compact and cool the temporary taper before allowing traffic on the new surface. Remove the temporary taper before resuming paving.

- b. **Vertical Longitudinal Joint.** When opening to traffic, plan the work to resurface adjacent lanes to within one load of the same ending point at the completion of paving operations each day. Construct a vertical joint to conform to the pavement cross section.

When compacting an unsupported (unconfined) edge of the mat, keep the roller from 3 inches to 6 inches inside the unsupported edge on the first pass; ensure the roller overhangs the unsupported edge by 3 inches to 6 inches on the second pass.

When placing HMA in a lane adjoining a previously placed lane, place the mixture so that the strike off shoe will produce an edge that is adjacent to or minimally overlaps the adjoining course. Compact the longitudinal joint by rolling from the hot side, keeping the edge of the roller approximately 6 inches to 8 inches inside the cold joint for the first pass. For the second pass of the roller, compact the joint from the hot side while overlapping the cold side by 6 inches to 8 inches.

- c. **Tapered Overlapping Longitudinal Joint.** The Engineer will allow a tapered overlapping longitudinal joint in lieu of a longitudinal vertical joint.

If using tapered overlapping longitudinal joints, the Engineer will not require resurfacing lanes within one load of the same point-of-ending at the completion of paving operations each day. Pave adjacent lanes within 24 hours, unless delayed by inclement weather or approved by the Engineer.

Construct the tapered overlapping longitudinal joint by tapering the HMA mat at a slope no greater than 1:12. Extend the tapered portion beyond the normal lane width.

Place a ½-inch to 1-inch notch at the top of the taper on paving courses.

Provide a uniform slope by constructing the tapered portion of the mat using a Department-approved strike-off device that will not restrict the main screed.

Apply bond coat to the surface of the taper before placing the adjacent lane.

3. **Placing HMA Shoulders.** Use a self-propelled mechanical paver or spreader to place HMA shoulders.

If placing the top course on new shoulders, or placing leveling, or top course on existing HMA shoulders at least 8 feet wide, place the mix using a paver with an automatically controlled and activated screed and strike-off assembly and corresponding grade referencing equipment. Use grade-referencing equipment, as directed by the Engineer.

Stop shoulder paving at crossroad approaches, auxiliary lanes, commercial driveways, and ramps. Do not pave through these areas.

4. **Placing HMA Approaches.** Place HMA on driveway or crossroad approach foundations, approved by the Engineer.

Place approaches in layers no greater than the application rate. Do not stop mainline paving of lanes adjacent to the approach to pave the HMA approach.

- G. **Rolling.** Compact each layer of HMA in accordance with the contract and free of roller marks.

Keep the surface of the steel roller wheels moist during rolling.

- H. **Smoothness Requirements.** After final rolling, the Engineer may test the surface longitudinally and transversely using a 10-foot straightedge at selected locations in accordance with [MTM 722](#). Construct the surface and correct variations, at no additional cost to the Department, to the tolerances specified in this subsection.

1. **Base Course.** Construct lower layers of base courses to a tolerance of  $\frac{3}{4}$  inch, and final layers of base courses to a tolerance of  $\frac{3}{8}$  inch.
2. **Leveling and Top Course.** For multiple course construction, construct lower courses to a tolerance of  $\frac{1}{4}$  inch, and top courses to a tolerance of  $\frac{1}{8}$  inch.

Construct single courses to a tolerance of  $\frac{1}{4}$  inch.

**I. Weather and Seasonal Limitations.**

1. **HMA Weather Limitations.** Except as limited by subsection [501.03.I.2](#), place HMA in accordance with the following restrictions:

- a. Do not place HMA or apply bond coat when moisture on the existing surface prevents curing;
- b. Do not place HMA unless the temperature of the surface being paved is at least 35 °F and there is no frost on or in the grade or on the surface being paved, unless otherwise approved by the Engineer in writing;
- c. Place only HMA courses that are greater than 200 pounds per square yard if the temperature of the surface being paved is greater than 35 °F;
- d. Place only HMA courses that are greater than 120 pounds per square yard if the temperature of the surface being paved is at least 40 °F; and
- e. Place any HMA course if the temperature of the surface being paved is at least 50 °F

2. **HMA Seasonal Limitations.** Unless otherwise approved by the Engineer in writing, place HMA in accordance with subsection [501.03.I.1](#) and the following seasonal limitations.

- a. From June 1 to October 15 for the Upper Peninsula;
- b. From May 15 to November 1 for the Lower Peninsula, north of M-46; and
- c. From May 5 to November 15 for the Lower Peninsula, south of M-46.

**J. Protection of Structures.** Protect bridges, curbs, gutters, driveways, sidewalks, barriers, and other appurtenances to prevent surfaces from becoming discolored during application of bond coat or HMA to the road surface. Remove material from appurtenances, as directed by the Engineer, at no additional cost to the Department.

**K. Aggregate Shoulders.** On resurfacing projects, scarify existing aggregate shoulder surfaces before placing new aggregate material.

Maintain the shoulder for vehicles to pass the construction equipment. If Contractor operations or traffic disturbs the area between the pavement and the right-of-way line, restore the area to a condition approved by the Engineer at no additional cost to the Department.

**L. Monument Boxes.** Place or adjust monument boxes in accordance with section [821](#).

**M. Quality Control (QC) Plan.** Prepare and implement a quality control (QC) plan for HMA, in accordance with the [HMA Production Manual](#).

Make adjustments in process controls to prevent production of non-conforming material in lieu of accepting payment at a reduced price. The Department will not allow continual production of non-conforming material at a reduced price in lieu of making adjustments.

The Engineer will not perform sampling or testing for quality control or assist in controlling the HMA production and placement operations.

**N. HMA Mix Acceptance.** The Engineer will inspect field-placed material, perform QA sampling and testing, and monitor Contractor adherence to the HMA-QC Plan.

1. **HMA Field-Placed Inspection.** The Engineer will perform inspection acceptance of HMA. The Department will inspect the base and leveling courses within 18 hours and the top course within 36 hours of placement. The Engineer will accept the pavement within these timeframes unless corrective action is required. If the Engineer determines that corrective action is required, inspection acceptance and paving of overlying courses will not occur until after the Contractor completes corrective action and the Engineer has determined that the pavement is in conformance with the contract.

The Engineer will determine the need for corrective action based on the acceptance factors specified in Table 501-5. Corrective action may include remedial treatment, including crack or surface sealing, or replacement.

Submit an action plan to the Engineer that addresses all acceptance factors that resulted in the need for corrective action. Complete all corrective action required to repair or replace unacceptable work at no additional cost to the Department.

If the Engineer and the Contractor agree, the Department may make a contract adjustment of no greater than 100 percent of the bid price for corrective action.

The Department will not grant time extensions for repair work to meet the inspection acceptance requirements specified in subsection [501.04.N.1](#).

The Engineer will determine the area subject to corrective action, for removal and replacement of top courses, as the longitudinal extent of corrective action multiplied by the width of the paving course affected.



The Department will accept HMA subject to corrective action as follows:

- a. HMA placed for corrective action involving full removal and replacement will be accepted in accordance with the contract.
  - b. The area requiring corrective action other than full removal and replacement will not be measured for incentive payment.
  - c. If more than 10 percent of the area of a subplot requires corrective action, the subplot will not be measured for incentive payment.
2. **HMA Testing Acceptance.** The Engineer will accept HMA based on visual inspection, small tonnage, or QA sampling and testing acceptance criteria. The Engineer will notify the Contractor before conducting QA sampling to allow the Contractor to witness the sampling, but not in a manner that will allow alteration of production in anticipation of sampling. The Engineer will conduct QA sampling in accordance with [MTM 313](#).
- a. **Visual Inspection Acceptance Criteria.** The Engineer may accept quantities less than 500 tons, of any individual mixture, in accordance with the [Materials Quality Assurance Manual](#).
  - b. **Small Tonnage Acceptance Criteria.** If the total tonnage of a specific mix does not exceed 5,000 tons, the Engineer will perform QA sampling and testing in accordance with the contract.
  - c. **QA Sampling and Testing Acceptance Criteria.** If the total tonnage of a specific mix is greater than 5,000 tons, the Engineer will perform QA sampling and testing in accordance with the contract.
- O. **Asphalt Binder Acceptance.** The Department will accept asphalt binder in accordance with Department procedures.

**Table 501-5  
HMA Acceptance Factors and Corrective Action**

| Acceptance Factors (a)       | Length | Extent (b)                          | Severity   | Corrective Action (c) |
|------------------------------|--------|-------------------------------------|--|-----------------------|
| Segregation                  | —      | >215 ft <sup>2</sup> /<br>328 ft LL | Heavy (d)  | Replace               |
| Rutting                      | —      | >32 ft                              | >¼ in average depth over<br>the length of occurrence | Replace               |
| Flushing                     | —      | >108 ft <sup>2</sup> /<br>328 ft LL | High (e)   | Replace               |
| Edge of<br>Paved<br>Shoulder | >33 ft | visible<br>ledges                   | >3 in  | Trim                  |
| Crack (g)                    | any    | any                                 | all  | Seal (f)              |

Note: LL = lane length.

a. Acceptance factors apply to all courses except flushing, which applies to the top course only.

b. Extent is calculated by summing locations within the length required.

c. The appropriate corrective action is dependent on the extent and severity of the factor, and on the intended service life of the pavement.

d. Segregation severity will be determined in accordance with [MTM 326](#). If segregation thresholds are met twice on a paving course, the Contractor may be required to use a Material Transfer Device for the remaining paving for that course at no additional cost to the Department.

e. Flushing severe enough to significantly effect surface friction (Friction Number <35).

f. Other corrective action may be required as crack frequency increases.

g. A reflective crack determined by the Engineer to be caused by an underlying condition.

#### 501.04. Measurement and Payment.

| Pay Item                             | Pay Unit         |
|--------------------------------------|------------------|
| HMA, 5 E _____                       | Ton              |
| HMA, 4 E _____                       | Ton              |
| HMA, 3 E _____                       | Ton              |
| HMA, 2 E _____                       | Ton              |
| HMA, LVSP _____                      | Ton              |
| HMA, (type), High Stress _____       | Ton              |
| HMA Approach _____                   | Ton              |
| HMA Approach, High Stress _____      | Ton              |
| Pavt for Butt Joints, Rem _____      | Square Yard      |
| Edge Trimming _____                  | Foot             |
| Cold Milling HMA Surface _____       | Square Yard, Ton |
| HMA Surface, Rem _____               | Square Yard      |
| HMA Patch, Rem _____                 | Square Yard      |
| Joint and Crack, Cleanout _____      | Foot             |
| Hand Patching _____                  | Ton              |
| Pavt, Cleaning _____                 | Lump Sum         |
| Pavt Joint and Crack Repr, Det _____ | Foot             |

A. **HMA, (type), High Stress.** The Department may pay for **HMA, (type), High Stress** for up to 150 feet outside the limits shown on the plans to ensure the Contractor has time to transition to the high stress HMA. The Department will pay for high stress HMA placed outside the 150-foot limit as other HMA mix pay items.

B. **Pavement for Butt Joints, Removal.** The unit price for **Pavt for Butt Joints, Rem** includes the cost of removing and disposing of concrete or HMA materials.

C. **Edge Trimming.** The Engineer will measure **Edge Trimming** along the cut edge. The unit price for **Edge Trimming** includes the cost of cutting, removing, and disposing of excess HMA material.

D. **Cold Milling HMA Surface.** The unit price for **Cold Milling HMA Surface** includes the cost of removing, loading, hauling, weighing and disposing of the cold milled material, and cleaning the cold milled pavement. If paid by the ton for cold-milled HMA, deposit the cold milled material directly from the cold milling machine into the hauling units and weigh on a scale meeting the requirements of subsection [109.01.G](#) before placement in a stockpile or a disposal area.

The Engineer will not weigh or pay for material picked up by cleaning after cold milling.

E. **Pavement, Cleaning.** The Engineer will measure **Pavt, Cleaning** as a unit, including paved shoulders, approaches, and widened areas. The unit price for **Pavt, Cleaning** includes the cost of cleaning the foundation, joints, and cracks, and sweeping shoulders, base courses, and leveling courses.

If the Engineer directs additional hand or mechanical methods to clean the pavement, the Department will pay for this work as **Joint and Crack, Cleanout** if the contract documents include the pay item. If the contract documents do not include a pay item for joint and crack cleanout, the Department will pay for additional hand or mechanical work as extra work, in accordance with subsection [109.07](#).

F. **Joint and Crack, Cleanout.** The Engineer will measure **Joint and Crack, Cleanout** along the cleaned joint and crack. If using compressed air does not completely clean out the joint or crack, and the Engineer directs the use of hand or mechanical methods to remove loose material, then the Department will pay for this as extra work, in accordance with subsection [103.02](#).

G. **Hand Patching.** The unit price for **Hand Patching** includes the cost of placing HMA, by hand or other methods, and compacting the material.

H. **Removing HMA Surface.** The Engineer will measure, and the Department will pay for removing HMA surface, no greater than 12 inches thick, overlying material to remain in place, as **HMA Surface, Rem**. The unit price for **HMA Surface, Rem** includes the cost of edge cutting to establish a neat line, as required, and removal and disposal of the HMA material.

The Engineer will measure and the Department will pay for removing HMA surface, greater than 12 inches thick, overlying material to remain in place, as **Pavt, Rem** in accordance with subsection [204.04](#).

I. **Pavement Joint and Crack Repair.** The Engineer will measure **Pavt Joint and Crack Repr**, of the detail required, along the joint and crack. If the pavement joint and crack repair exceeds 30 inches in width, the Engineer will measure each 30-inch wide segment, or portion thereof, separately for payment. The Department will pay for the HMA material used to fill the joints, after removal of objectionable material, as **Hand Patching**.

J. **HMA.** The Engineer will measure, and the Department will pay for, **HMA** of the mix specified based on the weight placed, as supported by weigh tickets. The Engineer will adjust the unit price for HMA, of the mix specified, in accordance with the contract.

## Section 502. HMA CRACK TREATMENT

**502.01. Description.** This work consists of treating cracks in Hot Mix Asphalt (HMA) surfaces using either a saw or rout and seal process or an overband process.

**502.02. Materials.** Provide materials in accordance with the following:

|                               |                     |
|-------------------------------|---------------------|
| Hot Poured Joint Sealant..... | <a href="#">914</a> |
| Asphalt Binder .....          | <a href="#">904</a> |
| Polyester Fibers.....         | <a href="#">904</a> |

A. **Saw or Rout and Seal.** Provide hot-poured joint sealant that meets the requirements of subsection [914.04](#) for sealing sawn or routed cracks.

B. **Overband.** Provide overband material as specified in subsection [502.02.B.1](#) or subsection [502.02.B.2](#).

1. **Overband (Alternate 1).** Provide a field-blended liquid mixture with the following characteristics and proportions:
  - a. Performance graded asphalt binder PG 64-22 south of M-46 and PG 58-28 north of M-46;
  - b. Asphalt rubber product selected from the Qualified Product List, 5 percent by weight; and
  - c. Polyester fibers, 5 percent by weight.

If using field mixed material, add the polyester fibers to the polymer modified asphalt cement and mix in the kettle. Do not allow field mix material to exceed 400 °F.

2. **Overband (Alternate 2).** Provide an asphalt rubber product selected from the Qualified Product List. Do not allow prepackaged material to exceed 400 °F.

### 502.03. Construction.

A. **Equipment.** Provide equipment, in accordance with section [107](#) and this subsection, capable of meeting the requirements of this subsection.

1. **Compressed Air System.** Provide and use a compressed air system that produces a continuous, high-volume, high-pressure stream of clean, dry air to prepare cracks. Equip the air compressor with a moisture separator to remove oil and water from the air supply. Provide a compressor capable of producing at least 100 psi at a continuous air flow of 150 cfm.

2. **Melter Applicator.** Provide a melter applicator consisting of a boiler kettle equipped with pressure pump, hose, and applicator wand. Equip the unit with the following:
  - a. Shutoff control on the applicator hose;
  - b. Mechanical full-sweep agitator in the kettle to provide continuous blending;
  - c. Thermometers to monitor the material temperature and the heating oil temperature; and
  - d. Thermostatic controls that allow the operator to regulate material temperature up to 425 °F.
  
3. **Application Wand.** Apply the material using either a wand followed by a V-shaped or U-shaped squeegee or a round application head with a concave underside.
  
- B. **Pre-Production Meeting.** Before beginning work, conduct an on-site pre-production meeting with the Engineer to discuss the following:
  1. Contractor's detailed work schedule,
  2. Traffic control plan,
  3. Required project documentation,
  4. Inspection of the condition of equipment,
  5. The Contractor's Quality Control (QC) Plan, and
  6. The Contractor's designated Authorized Representative.
  
- C. **Crack Preparation.** Clean and dry cracks using compressed air and other tools to remove loose dirt, vegetation, and deleterious material. Clean cracks no more than 10 minutes before filling.
  
- D. **Crack Treatment Methods.**
  1. **Saw or Rout and Seal.** Treat visible working cracks no greater than 1¼ inches wide in the pavement surface using the saw or rout and seal process. Treat working cracks in shoulders unless otherwise required. The Department defines working cracks as cracks that experience considerable horizontal or vertical movement, at least ⅛ inch, as a result of temperature change or traffic loading.  
  
Create a reservoir by sawing or routing along the crack. Create the reservoir to a volume of at least 7.5 cubic inches per foot of crack and with a 1:1 width to depth ratio. Ensure the finished reservoir walls are vertical and the reservoir bottom is flat. Place sealant flush or no greater than ⅛ inch below the pavement surface.
  2. **Overband.** The Contractor may treat non-working cracks with material placed in an overband configuration. The Department defines non-working cracks as cracks that experience relatively little

horizontal or vertical movement, less than  $\frac{1}{8}$  inch, as a result of temperature change or traffic loading.

Apply overband material to clean, dry cracks. Apply overband 4 inches wide and from  $\frac{1}{8}$  inch to  $\frac{3}{16}$  inch thick.

The Contractor may increase the maximum application width to 6 inches for coverage of multiple cracks, with Engineer's prior written approval.

Place temporary pavement markings before opening the road to traffic if overband material obliterates existing pavement markings.

Apply overband as follows unless otherwise required:

- a. **Stand Alone Overband Crack Fill.** If no other surface treatment is required on the pavement, fill visible cracks in the road less than  $1\frac{1}{4}$  inch wide.
- b. **Micro-Surfacing Preparation.** If preparing the pavement for a micro-surface overlay, fill visible cracks in the road less than  $1\frac{1}{4}$  inch wide.
- c. **Chip Seal Preparation.** If preparing the pavement surface for a single or double chip seal, fill cracks greater than  $\frac{1}{8}$  inch wide or 3 feet long. Seal cracks with varying widths and portions at least  $\frac{1}{8}$  inch wide, along the entire length.
- d. **Paver Placed Surface Seal.** If preparing the pavement for a paver placed surface seal, fill cracks with widths from  $\frac{1}{4}$  inch to  $1\frac{1}{4}$  inch.
- e. **HMA Ultra-Thin Overlay.** If preparing the pavement for an HMA ultra-thin overlay, fill visible cracks less than  $1\frac{1}{4}$  inch wide.

E. **Weather Limitations.** Place material at air temperatures from 45 °F to 85 °F. Do not place material if moisture is present in the crack.

F. **Cure Time and Repair.** Allow the material to cool before opening the road to traffic. Apply de-tackifying solution, if required, to protect the uncured crack treatment material from tracking. Do not use blotting materials, including sand, aggregate, sawdust, or paper. Repair treated pavement areas, damaged by traffic at no additional cost to the Department.

G. **Quality Control (QC).** Provide and follow a QC plan for production and construction processes. Provide the Engineer a copy of the QC plan for review and approval, prior to the pre-production meeting. Maintain QC measures until the Engineer accepts the work.

Comply with the approved QC plan throughout the project and allow the Engineer access to work in progress for assurance review and testing. If the Engineer identifies a condition causing unsatisfactory crack treatment, immediately stop production and correct the work at no additional cost to the Department.

Ensure the QC plan addresses at least the following:

1. A detailed description explaining how field crews will determine working and non-working cracks. Separately detail projects with multiple pavement sections.
2. The sealant material and equipment used to heat, handle, and apply sealant material in accordance with the manufacturer's specifications. Provide the material manufacturer's specifications to the Engineer upon request.
3. Reservoir configuration for the saw or rout and seal operation.
4. Procedures for crack cleaning.
5. Replacement criteria for cutting tools.
6. Controls implemented to ensure flying dust and debris is not directed toward adjacent traveled lanes, pedestrians, parked vehicles, or buildings.
7. An action plan for adjusting crack sealing operations to address actual environmental conditions if adverse environmental conditions occur.
8. Proposed procedure for monitoring the work to ensure acceptance requirements are met.

H. **Acceptance.** Upon completion of work, schedule an inspection with the Engineer. The Engineer will note deficiencies, including areas exhibiting adhesion failure, cohesion failure, missed cracks, or other factors the Engineer determines unacceptable. Correct work the Engineer identifies as unacceptable. Notify the Engineer upon completion of required corrective work.

#### 502.04. Measurement and Payment.

| Pay Item                           | Pay Unit     |
|------------------------------------|--------------|
| Overband Crack Fill, Roadbed ..... | Roadbed Mile |
| Overband Crack Fill, Ramp .....    | Roadbed Mile |
| HMA Crack Treatment, Roadbed ..... | Roadbed Mile |
| HMA Crack Treatment, Ramp .....    | Roadbed Mile |

A. **Overband Crack Fill.** The Engineer will measure **Overband Crack Fill, Roadbed** along the roadway centerline. This measurement includes traffic lanes, paved shoulders, auxiliary lanes, and ramps to the



2-foot gore point. For divided highways, the Engineer will measure the roadway separately in each direction.

The Engineer will measure **Overband Crack Fill, Ramp** along the ramp centerline beginning at the 2-foot gore point.

The unit prices for **Overband Crack Fill**, of the type required, include the cost of preparing and filling cracks using the overband method, providing the required documentation, corrective work, and temporary traffic markings.

**B. HMA Crack Treatment.** The Engineer will measure **HMA Crack Treatment, Roadbed** along the roadway centerline. This measurement includes traffic lanes, paved shoulders, auxiliary lanes, and ramps to the 2-foot gore point. For divided highways, the Engineer will measure the roadway separately in each direction.

The unit price for **HMA Crack Treatment, Roadbed** includes the cost of preparing, filling, and sealing the cracks, including treating working cracks with the saw or rout and seal method, and treating non-working cracks with the overband method.

The Engineer will measure **HMA Crack Treatment, Ramp** along the ramp centerline beginning at the 2-foot gore point.

The unit price for **HMA Crack Treatment, Ramp** includes the cost of preparing, filling, and sealing the cracks, including treating working cracks with the saw or rout and seal method, and treating non-working cracks with the overband method.

## Section 503. PAVER PLACED SURFACE SEAL

**503.01. Description.** This work consists of providing and placing paver placed surface seal (PPSS), including preparing existing pavement and constructing PPSS, uniform in texture, density, and smoothness with no measurable segregation.

**503.02. Materials.** Provide materials in accordance with the following.

|                              |                     |
|------------------------------|---------------------|
| Aggregate .....              | <a href="#">902</a> |
| Asphalt Emulsion, PPSS ..... | <a href="#">904</a> |
| Asphalt Binder, .....        | <a href="#">904</a> |

**A. Asphalt Binder Selection Criteria.** Provide PG Asphalt Binder in accordance with Table 503-1.

| Location   | PG Asphalt Binder |
|--|-------------------|
| North of M-72 in lower peninsula and the upper peninsula | PG 64-28P         |
| South of M-72 (including M-72)                           | PG 70-28P         |
| MDOT Metro Region only                                   | PG 70-22P         |

**B. PPSS Mixture Design.** Submit a mix design from a Department-approved laboratory to the Engineer, 5 working days before beginning construction. Design the mixture so asphalt binder produces a film thickness of at least 9 microns. Calculate the film thickness in accordance with the *Hot Mix Asphalt Materials, Mixture Design and Construction*, 2nd Edition, National Center for Asphalt Technology.

Provide a mix design in accordance with Table 503-2 and the minimum film thickness. Do not use reclaimed material in the mixture.

**C. Mix Design Documentation.** Provide the following documents with the mix design:

1. [Contractor Bituminous Mix Design Communication](#) (Form 1855);
2. [Sample Identification](#), include with AWI sample (Form 1923);
3. Average maximum percent draindown for each test temperature (Report);
4. [Tensile Strength Worksheet](#) (Form 1937);
5. Calculation of film thickness (Report);
6. The material sources for the mix design; and
7. Test results verifying the mix meets the requirements in Table 503-2 and the specified film thickness.

**Table 503-2  
Mixture Requirements**

| <b>Mix Type</b> | <b>Aggregate</b> | <b>% Asphalt Binder Content</b> | <b>Draindown Test (% Max) AASHTO T 305 (a)</b> | <b>Moisture Sensitivity (% Min) AASHTO T 283 (b)</b> |
|-----------------|------------------|---------------------------------|--|--|
| B               | 30SS             | 4.8–6.2                         | 0.10   | 80   |
| C               | 27SS             | 4.6–6.2                         | 0.10   | 80   |

- a. Conduct the draindown test at the JMF asphalt content plus 0.5%. Test the draindown at the mixing temperature plus 27 °F but do not exceed 350 °F.
- b. Compact specimens for T-283 testing using the Superpave Gyratory Compactor (SGC) at 100 gyrations with target dimensions of 150 mm diameter × 95 mm ±3 mm height or 100 mm diameter × 63 mm ±3 mm height. No adjustment is made to the number of revolutions to target an air void range. Cure the loose bituminous surface course mix 1 h at the specified application temperature. Minimum time for vacuum saturation: 20 min. Specimens subject to freeze-thaw conditioning. If an anti-stripping agent is needed, report the amount and type with the mix design.

### 503.03. Construction.

**A. Equipment.** Provide equipment, in accordance with section [107](#), and this subsection.

1. **Self-Priming Machine.** Provide a self-priming machine that sprays polymer modified emulsion membrane and places an HMA surface course over the membrane in a single pass, continuous application. Ensure the self-priming machine does not contact the polymer modified emulsion membrane before applying the HMA surface course. Provide a self-priming machine with the following:
    - a. A receiving hopper with at least two heated, twin screw, and mix feed augers.
    - b. An integral storage tank for the polymer modified asphalt emulsion.
    - c. Twin expandable emulsion spray bars, immediately in front of the HMA feed augers and ironing screed. Meter the spray bars to measure the application of polymer modified asphalt emulsion and monitor the rate of spray across the width of the paving pass.
    - d. A variable-width vibratory heated ironing screed. Ensure the screed is adjustable and capable of providing positive and negative crowns to the thickness and cross section shown on the plans.
  2. **Compacting Equipment.** Use at least two steel-wheel rollers each weighing at least 10 tons. Ensure rollers meet the requirements of subsection [501.03.A.5](#).
- B. Pre-Production Meeting.** Before beginning work, conduct an on-site pre-production meeting with the Engineer to discuss the following:

1. Work schedule,
2. Traffic control plan,
3. Equipment calibrations and adjustments,
4. Condition of equipment for safety criteria,
5. Quality control plan, and
6. Contractor's authorized representative.

**C. Weather and Seasonal Limitations.**

1. **Weather Limitations.** Place PPSS on dry pavement. Do not place PPSS if the air temperature is below 50 °F.

2. **Seasonal Limitations.** Place PPSS from May 1 to October 15.

**D. PPSS Placement.** Ensure the quality of the PPSS, including materials sampling, testing, and construction inspection. Provide and install a finished product as required.

1. **Emulsion Membrane.** Apply polymer modified asphalt emulsion membrane at a rate of 0.20 gallon per square yard. The Engineer will allow a field adjustment of the emulsion application rate for changes in existing pavement surface conditions or limitations of the HMA mix design. Apply the polymer modified asphalt emulsion membrane at a temperature from 140 °F to 175 °F.

2. **PPSS.** Apply Type B surface course mixture at a rate of 73 pounds per square yard and Type C surface course mixture at a rate of 83 pounds per square yard. Ensure the application rate provides a PPSS thickness that prevents the fracture of aggregate by the screed. Apply the PPSS mix at a temperature from 300 °F to 330 °F and compact before the mat cools to 185 °F.

3. **Rough Joints.** Repair transverse or longitudinal construction joints from PPSS operations that cause bumps or poor riding joints, as determined by the Engineer, using a mutually agreed upon repair method.

**E. Ride Quality.** Before PPSS placement, the Department will determine the ride quality of the original pavement, except shoulders, using the International Roughness Index (IRI). The Department will retain plots of the original roadway profiles.

Ensure the pavement ride quality does not diminish after applying PPSS. The Engineer may accept the finished pavement surface without measuring the new roadway profile if, in the Engineer's opinion, the final ride quality at least equals the original pavement.

If the Engineer determines the ride quality is diminished after PPSS placement, correct the ride quality. If the Contractor disputes the diminished ride quality assessment, the Department will re-measure the pavement profile and compare the IRI values for the finished pavement surface to the original IRI values. Correct reductions in the ride quality, as directed by the Engineer, to produce a finished pavement surface with an IRI at least equal to that of the original pavement.

**F. Quality Control (QC).** Provide and follow a QC plan, in accordance with requirements of section [501](#), that will maintain QC for production and construction processes, as required. Provide the Engineer a copy of the QC plan for review and approval, before the pre-production meeting. The Engineer may verify QC test accuracy and production controls.

Notify the Engineer immediately and stop mixture production if the QC test results exceed any tolerance shown in Table 503-3. Identify the cause of the deviation and determine the corrective action necessary to bring the mixture into compliance prior to resuming mixture placement.

Perform, at a minimum, the following QC tests.

- HMA Surface Course.** Perform three yield checks, daily, to determine the application rate of the HMA surface course. Ensure the yield does not exceed a tolerance of  $\pm 5$  pounds per square yard from the target application rate.
- HMA Mixture.** Take a sample of the HMA mix from the truck transports in accordance with ASTM D 979 and reduce the sample size in accordance with [MTM 313](#). Test this sample before beginning production the following day. Test results must fall within the quality control tolerances specified in Table 503-3.

| Sieve Size   | Mix Type B       | Mix Type C       |
|--|------------------|------------------|
|  | Tolerance, % (a) | Tolerance, % (a) |
| $\frac{3}{4}$ in   | —                | —                |
| $\frac{1}{2}$ in   | —                | $\pm 5$          |
| $\frac{3}{8}$ in   | $\pm 5$          | $\pm 5$          |
| No. 4  | $\pm 5$          | $\pm 5$          |
| No. 8  | $\pm 4$          | $\pm 4$          |
| No. 200  | $\pm 1$          | $\pm 1$          |
| PG Asphalt Binder Content, %                               | $\pm 0.4$        |                  |
| Film Thickness   | 9 microns (Min)  |                  |
| a. Tolerance in reference to values listed in Table 902-7. |                  |                  |

**G. Acceptance.** Upon completion of all or a portion of the PPSS placement, as determined by the Engineer, review the PPSS with the Engineer for compliance with the contract documents. If the Department

determines the PPSS does not comply with the contract, repair defects at no additional cost to the Department.

**503.04. Measurement and Payment.**

| <b>Pay Item</b>                          | <b>Pay Unit</b> |
|--|-----------------|
| Paver Placed Surface Seal, Type __ ..... | Square Yard     |

A. **Paver Placed Surface Seal.** The unit price for **Paver Placed Surface Seal**, of the type required, includes the cost of preparing the surface, placing temporary pavement markings, and placing a membrane and HMA surface course for full width coverage.

## Section 504. MICRO-SURFACING

**504.01. Description.** This work consists of preparing existing pavement and providing and placing a micro-surfacing mixture.

**504.02. Materials.** Provide materials in accordance with the following:

|  |                     |
|--|---------------------|
| Portland Cement, Type I.....             | <a href="#">901</a> |
| Fine Aggregates, 2FA, 3FA.....           | <a href="#">902</a> |
| Asphalt Emulsion, CSS-1hM, CSS-1mM ..... | <a href="#">904</a> |
| Water .....                              | <a href="#">911</a> |

A. **Aggregate.** Ensure aggregates comply with gradation and physical requirements in Tables [902-7](#) and [902-8](#).

Use 3FA fine aggregate in micro-surfacing mixture for rut filling.

Use 3FA or 2FA fine aggregates in micro-surfacing mixtures for standard micro-surfacing.

Use 2FA fine aggregate in micro-surfacing mixture for single-course applications.

B. **Mix Design.** Provide micro-surfacing mixtures consisting of a blend of polymerized asphalt emulsion, fine aggregate, portland cement, water, and other additives.

Submit to the Engineer, at least 5 work days before starting production, a mix design, prepared and certified by a Department-approved laboratory. Ensure the combined material meets the mix design criteria specified in Table 504-1.

| <b>Table 504-1</b>                         |                                  |                        |
|--|----------------------------------|------------------------|
| <b>Micro-surfacing Mix Design Criteria</b> |                                  |                        |
| <b>Test Method</b>                         | <b>Parameter</b>                 | <b>Specification</b>   |
| ISSA TB-114                                | Wet Stripping                    | ≥90%                   |
| ISSA TB-100                                | Wet Track Abrasion Loss          | —                      |
|  | One Hour Soak                    | ≤50 g/ft <sup>2</sup>  |
|  | Six Day Soak                     | ≤75 g/ft <sup>2</sup>  |
| ISSA TB-144                                | Saturated Abrasion Compatibility | ≤3 g loss              |
| ISSA TB-113                                | Mix Time at 77 °F                | Controllable to ≥120 s |
|  | Mix Time at 100 °F               | Controllable to ≥35 s  |

Provide a Job Mix Formula (JMF), meeting the limits shown in Table 504-2, to the Engineer at the pre-production meeting.

Submit a new mix design for changes in aggregate or asphalt emulsion sources.

| <b>Table 504-2<br/>JMF Limits</b> |                                      |
|-----------------------------------|--------------------------------------|
| <b>Test Method</b>                | <b>Specification</b>                 |
| Asphalt Binder Content (Residual) | 7.0%–8.5%, dry weight, 2FA aggregate |
|                                   | 6.5%–8.0%, dry weight, 3FA aggregate |
| Mineral Filler                    | 0.25%–3.0%, dry weight aggregate     |

C. **Mix Design Documentation.** Provide the following information in the final mix design:

1. Proportion of each material;
2. Sources of each material including:
  - a. Aggregate,
  - b. Name and pit number,
  - c. Gradation,
  - d. Sand equivalence, and
  - e. Angularity Index (AI);
3. Field simulation tests including:
  - a. Wet stripping tests,
  - b. Wet track abrasion loss,
  - c. Saturated abrasion compatibility, and
  - d. Trial mix time at 77 °F and 100 °F;
4. Interpretation of results and the determination of a JMF including:
  - a. Mineral filler, percent (minimum and maximum);
  - b. Water, including aggregate moisture, percent (minimum and maximum);
  - c. Mix set additive, percent;
  - d. Modified emulsion in mix, percent;
  - e. Residual asphalt content of modified emulsion, percent; and
  - f. Residual asphalt content in mix, percent;
5. ADT for the pavement sections where placing mix; and
6. Mix designer's signature and date.

D. **Bond Coat.** Use the same emulsion for bond coat as used in production of the mixture.

### 504.03. Construction.

A. **Equipment.** Provide equipment, in accordance with section [107](#), that can produce a specification product.

1. **Mixing Machine.** Provide at least one self-propelled, front feed, continuous loading mixing machine equipped and operated as follows:



- a. A positive connection conveyer belt aggregate delivery system and an interconnected positive displacement, water-jacketed gear pump to proportion aggregate and asphalt emulsion.
- b. Continuous flow, twin shaft, multi-blade type pugmill at least 50 inches long.
- c. Blade sizes and side clearances meeting the equipment manufacturer's recommendations.
- d. Mineral filler feed that drops mineral filler on the aggregate before discharging into the pugmill.
- e. Asphalt emulsion introduced within the first one-third of the mixer length to ensure mixing of materials before exiting the pugmill.
- f. Rate indicators for proportioning each material, readily accessible and positioned to allow determination of the quantity of each material. Calibrate and test each material rate indicator to ensure proper operation before production.
- g. A water pressure system and nozzle type spray bar to provide water spray in front of and outside the spreader box. Apply water to dampen the existing pavement surface without causing free flowing water in front of the spreader box.
- h. Opposite side driving stations on the front to optimize longitudinal alignment during placement.
- i. Remote forward speed control at the rear-mixing platform for the back operator to control forward speed and level of mixture in the spreader box.

Provide enough transports to ensure continuous operation during mix production and application. Use transport units with belt-type aggregate delivery systems, emulsion storage tanks, and water storage tanks to proportionally mix aggregate delivered by each transport.

The Contractor may use truck-mounted batch-type machines on projects or sections of projects smaller than 15,000 square yards. Provide at least two truck-mounted batch-type machines. Do not delay mix production more than 15 minutes. Stop mix production if delays exceed 15 minutes.

Calibrate mixing machines before use. Maintain documentation of the calibrations of each material-metering device at various settings. Supply materials and equipment, including scales and containers, for calibration. Recalibrate mixing machines after changes in aggregate or asphalt emulsion sources.

2. **Spreader Box.** Provide a mechanical-type spreader box, attached to the mixer and equipped with paddles mounted on adjustable

shafts to continually agitate and distribute the mixture. Equip spreader boxes with the following:

- a. Front and rear flexible seals capable of maintaining direct contact with the road;
- b. A secondary strike-off, attached to the spreader box capable of providing a finished smooth surface texture on the final or surface pass; and
- c. A drag capable of producing a uniform finish.

Replace the drag if mixture builds up.

3. **Rut Box.** Use a Department-approved steel V-configuration screed rut box designed and manufactured to fill ruts to perform micro-surface rut filling applications. Ensure a mixture spread width from 5 feet to 6 feet, and use a secondary strike-off to control crown on the rut box. Equip the rut box with a third strike-off to control texture.
4. **Miscellaneous Equipment.** Provide hand squeegees, shovels, and other equipment to perform the work. Provide cleaning equipment for surface preparation, including power brooms, air compressors, water flushing equipment, and hand brooms.
5. **Lights on Equipment.** Equip power brooms, distributors, and truck mount spreaders with at least one Department-approved, flashing, rotating, or oscillating amber light, visible in every direction. Equip continuous spreader units with one light on each side of the spreader.
- B. **Pre-Production Meeting.** Before beginning work, conduct an on-site pre-production meeting with the Engineer to discuss the following:
  1. Detailed work schedule;
  2. Traffic control plan;
  3. Equipment calibration;
  4. Mix design previously submitted to the Engineer;
  5. Equipment inspection, including transport units;
  6. Test strips to check the material and demonstrate placement procedures;
  7. [Permit to Place](#) (Form 1125);
  8. JMF; and
  9. Availability of materials.

If using multiple machines, lay a test strip with each machine at the time of the pre-production meeting. The Engineer will compare each test strip to detect and correct variances in surface texture and appearance.

**C. Surface Preparation.** Immediately before surfacing operations, remove pavement markings using an abrasion method.

Clean existing surface of loose materials, vegetation, dirt, dust, mud and other deleterious materials. Remove animal remains and wash the surface before placing the mixture.

Protect drainage structures, monument boxes, water shut-offs, and other existing structures during bond coat and mix application.

Apply bond coat on concrete surfaces, unless otherwise directed by the Engineer. Mix bond coat with one part emulsion to two parts water. Apply the bond coat at a rate from 0.035 gallons per square yard to 0.070 gallons per square yard, without excessive run off. Allow the bond coat to cure before placing mixture.

Before placing the mixture, establish, identify, and maintain, 1,000-foot intervals until project completion.

**D. Application Methods and Rates.** Apply micro-surface mixtures to the areas shown on the plans to fill minor cracks and ruts in the roadbed, to construct a uniform surface with straight longitudinal joints, transverse joints, and edges.

1. **Rutfilling.** Fill ruts if the rut is at least  $\frac{1}{2}$  inch deep and the contract includes the pay items for either standard micro-surfacing or rut filling. Use a 3FA mixture for rut filling and apply using a rut box for each wheel track.

Maintain a clean overlap and straight edges between wheel tracks. Limit each pass of rut filling to no deeper than 1 inch. For each 1 inch of mix, provide an additional  $\frac{1}{8}$  inch crown.

2. **Standard Micro-Surfacing.** Select one of the following application methods for standard micro-surfacing:
  - a. Apply at least one course of 3FA mix to the pavement surface at an average application rate of at least 35 pounds per square yard, excluding shoulders, as required. Apply 3FA mix to pavement surface course and shoulders at a rate of at least 22 pounds per square yard.
  - b. Apply at least two courses of 2FA mix to the pavement surface, at an average combined application rate of at least 30 pounds per square yard, excluding shoulders, as required. Apply 2FA mix to pavement surface course and shoulders at a rate of at least 17 pounds per square yard.

3. **Single Course Micro-Surfacing.** Apply a single course using 2FA mix at an average minimum application rate of 24 pounds per square yard  $\pm$ 2 pounds per square yard, by weight of dry aggregate, to the pavement surface, including shoulders if required.

#### E. **Surface Quality.**

1. **Joint Construction.** Place longitudinal construction joints and lane edges to coincide with the planned painted lane lines. Construct longitudinal joints with less than 3 inches overlap on adjacent passes and no more than  $\frac{3}{8}$  inch thick overlap as measured with a 10-foot straight edge. To prevent water from collecting on the pavement surface, place successive passes on the up-slope side of the overlap.

Construct neat and uniform transverse joints with less than a  $\frac{1}{8}$  inch difference in elevation across the joint as measured with a 10-foot straight edge. Provide neat and uniform lane edges with no greater than 2 inches of horizontal variance over 100 feet. Immediately stop work to correct defective joints or edges and obtain the Engineer's approval before resuming work.

2. **Cross Section.** For standard micro-surface, restore the driving lane cross section to within  $\frac{1}{8}$  inch of the planned elevation, measured transversely across the pavement with a 7-foot straight edge, except pavement segments designed with a quarter crown cross slope or areas of the segment within 6 inches of the edge line, lane line, or centerline.
3. **Ride Quality.** Before construction, the Department will determine the ride quality of the pavement surface, except shoulders, using the International Roughness Index (IRI). The Department will retain the plots of the original roadway profiles.

Ensure the ride quality of the pavement does not diminish after applying micro-surfacing. The Engineer may initially accept the finished pavement surface without measuring the new roadway profile if, in the Engineer's opinion of the Engineer, the final ride quality at least equals that of the original pavement.

If the ride quality appears diminished after placing micro-surfacing, correct the ride quality. If the Contractor disputes a diminished ride quality determination, the Department will re-measure the pavement profile and compare the IRI values for the finished pavement surface to the original IRI values. Correct reductions in the ride quality, as directed by the Engineer, to produce a finished pavement surface with an IRI at least equal to the original pavement IRI.

**F. Cure Time and Repair.** Do not allow traffic on the mixture until it cures, preventing pickup by vehicle tires. Ensure the new surface can carry normal traffic without damage within 1 hour of application. Protect the new surface from damage at intersections and driveways. Repair damage to the mixture caused by traffic at no additional cost to the Department.

**G. Weather and Seasonal Limitations.**

1. **Weather Limitations.** Place the mixture when the air and pavement temperatures reach at least 45 °F.

Do not place mixture in rain, inclement weather, or when the air temperature is forecast to be below 32 °F within 24 hours of work completion.

2. **Seasonal Limitations.** Place mixture from June 1 to September 15 in the Upper Peninsula and from May 1 to October 1 in the Lower Peninsula.

**H. Quality Control (QC).** Provide a finished surface free of excessive scratch marks, tears, rippling, and other surface irregularities, as determined by the Engineer. Do not leave ripples greater than 1/8 inch as measured by a 10-foot straight edge in accordance with [MTM 722](#). Do not leave tear marks greater than 1/2 inch wide and 4 inches long, or other marks greater than 1 inch wide and 1 inch long. If the finished surface exceeds the specified tolerances, stop work immediately and correct irregularities. Review corrective action with the Engineer before resuming production.

Produce a mixture that will meet the JMF and the QC tolerances specified in Table 504-3. Notify the Engineer immediately if QC test results exceed the tolerances specified in Table 504-3, and stop mix production. Identify the cause of the deviation and determine the corrective action necessary to bring the mixture into compliance. Obtain the Engineer's approval before resuming work.

The Engineer reserves the right to verify QC test accuracy and production controls.

If the Engineer identifies a condition that causes an unsatisfactory micro-surfacing treatment, immediately stop production work and correct the defect at no additional cost to the Department.

| Table 504-3<br>Micro-Surfacing Quality Control Tolerances |       |       |        |                      |        |         |         |
|---|-------|-------|--------|----------------------|--------|---------|---------|
| Aggregate Gradation Tolerances (±)                        |       |       |        |                      |        |         |         |
| Sieve Size  | No. 4 | No. 8 | No. 16 | No. 30               | No. 50 | No. 100 | No. 200 |
| Tolerance   | 5.0%  | 5.0%  | 5.0%   | 5.0%                 | 4.0%   | 3.0%    | 2.0%    |
| General Quality Control Tolerances (±)                    |       |       |        |                      |        |         |         |
| Parameter   |       |       |        | Tolerance            |        |         |         |
| Asphalt Cement Content Single Test                        |       |       |        | 0.5% from JMF        |        |         |         |
| Asphalt Cement Content Daily Average                      |       |       |        | 0.2% from JMF        |        |         |         |
| Application Rate (as determined by 1,000 ft yield checks) |       |       |        | 2 lb/yd <sup>2</sup> |        |         |         |
| Sand Equivalent Test (ASTM D2419)                         |       |       |        | 7% from JMF          |        |         |         |

1. **QC Plan Contents.** Provide and follow a QC plan, in accordance with requirements of section 501, that will maintain QC for production and construction processes, as required. Provide the Engineer a copy of the QC plan for review and approval, before the pre-production meeting.

Include, at a minimum, the following items:

- a. The source of materials used on the project.
  - b. Sampling and testing methods used to determine compliance with material specifications.
  - c. A detailed description of how field crews will determine pavement rut depths and locations. Detail each section of multiple pavement sections separately.
  - d. The equipment to be used on the project.
  - e. Calibration method used to determine compliance with the mix design (JMF).
  - f. Pavement cleaning and preparation procedure.
  - g. Plan for protecting micro surfacing mixture from damage by traffic.
  - h. Procedure for monitoring initial acceptance requirements.
  - i. An action plan demonstrating adjustments of the micro-surfacing operation for adverse environmental conditions.
2. **Minimum QC Sampling and Testing Frequency.** Include the following minimum QC sampling and testing frequencies in the QC Plan.
    - a. **Fine Aggregate Gradation.** Sample fine aggregate from the project stockpile and test for gradation. Perform one test per 500 tons of fine aggregate or one test per day of mixture production, whichever is greater.
    - b. **Sand Equivalent Test (ASTM D 2419).** Perform at least one sand equivalency test for each mixture design.

- c. **Asphalt Content.** Calculate the percent asphalt content of the mixture at least three times per day, on a random basis, using the equipment counter readings.
  - d. **Application Rate.** Calculate the yield of the course placed at least three times per day, on a random basis, using the equipment counter readings.
3. **Documentation.** Complete a daily report that includes the following information:
- a. Control section;
  - b. Job number;
  - c. Route;
  - d. Engineer;
  - e. Date;
  - f. Air temperature;
  - g. Control settings;
  - h. Calibration values;
  - i. Unit weight of emulsion (pounds per gallon);
  - j. Percent residue in emulsion;
  - k. Beginning and ending intervals;
  - l. Counter readings (beginning, ending, and total difference);
  - m. Length and width;
  - n. Total area (square yards);
  - o. Aggregate weight;
  - p. Gallons of emulsion;
  - q. Percent of each material including asphalt cement;
  - r. Application rate, (pounds per square yard);
  - s. Combined application rate, (pounds per square yard);
  - t. JMF (percent portland cement, percent emulsion, gradations, percent asphalt cement);
  - u. Contractor's authorized signature;
  - v. Calibration forms;
  - w. QC aggregate gradations;
  - x. Materials acceptance documentation;
  - y. Asphalt emulsion bill of lading; and
  - z. QC and equivalent test result.

If truck-mounted machines are used, complete a separate daily report for each machine.

4. **Field Tests.** Before opening micro-surfacing to traffic, perform both of the following field tests:

- a. Probe the entire depth of the micro-surfacing to verify no free emulsion exists in the mixture.
  - b. Place a white absorbent paper blotter on the micro-surfacing to confirm the presence of clear water without brown staining from unbroken emulsion.
- I. **Acceptance.** Allow the Engineer access to in-progress work for quality assurance review and testing.
1. **Field Inspection Acceptance.** Upon completion of work, schedule an inspection with the Engineer. The Engineer will note deficiencies, including areas exhibiting adhesion or cohesion failure. Reconstruct work identified by the Engineer as unacceptable.
  2. **Delayed Acceptance.** At least 30 days after completion of the micro-surface rutfilling, standard or single course, the Engineer will inspect the surface with the Contractor for surface flushing, raveling, or delamination. If the Engineer determines that these surface deficiencies exist, correct the work within 7 working days of the review, or by an agreed upon date, and at no additional cost to the Department.

#### 504.04. Measurement and Payment.

| Pay Item                        | Pay Unit    |
|---------------------------------|-------------|
| Micro-Surface, Rutfilling ..... | Ton         |
| Micro-Surface, Std .....        | Square Yard |
| Micro-Surface, Single Cse.....  | Square Yard |

A. **General.** The unit prices for **Micro-Surface**, regardless of the type required, include the cost of providing traffic control, including traffic control to complete corrective action; cleaning existing pavement; applying a bond coat; temporary pavement markings; stationing; and corrective action.

B. **Micro-Surface Rutfilling.** The Engineer will measure **Micro-Surface, Rutfilling** based on the dry weight of fine aggregate in the mix. The unit price for **Micro-Surface, Rutfilling** includes placing mix over each wheel rut to create full lane coverage.

C. **Micro-Surface, Standard.** The unit price for **Micro-Surface, Std** includes the cost of preparing the surface, placing temporary pavement markings, placing the micro-surfacing mixture, applying a rut filling course, a leveling course, a surface course, or all, for full width coverage.

D. **Single Micro Surface.** The unit price for **Micro Surface, Single Cse** includes the cost of preparing the surface, placing temporary



504.04

pavement markings, placing the micro-surfacing mix, and applying a single course of mixture for full width coverage.

E. **Pavement Marking Removal.** The Department will pay separately for removing pavement markings in accordance with subsection [812.04](#).

## Section 505. CHIP SEALS

**505.01. Description.** This work consists of preparing the pavement surface and providing and placing a single chip seal, double chip seal, or shoulder chip seal.

**505.02. Materials.** Provide materials in accordance with the following:

|                              |                     |
|------------------------------|---------------------|
| Coarse Aggregate, 34CS ..... | <a href="#">902</a> |
| Asphalt Emulsion, CSEA.....  | <a href="#">904</a> |

The Department will waive the AWI requirement on shoulders.

### 505.03. Construction.

A. **Equipment.** Provide equipment, in accordance with section [107](#) and the following, capable of producing and placing a product meeting the requirements of this section.

- 1. Pressure Distributor.** Provide a pressure distributor with a computerized application rate and speed control, capable of maintaining the asphalt emulsion at the temperature required by the contract. Ensure the control has a radar ground-sensing device that controls the application rate regardless of ground speed and spray bar width. Ensure the spray bar nozzles produce a uniform, triple-lap application fan spray, with instantaneous shutoff and no dripping. Ensure each pressure distributor can maintain the required application rate within  $\pm 0.015$  gallons per square yard for each load.
- 2. Chip Spreader.** Provide a self-propelled chip spreader equipped with a computerized spread control, pneumatic tires, and a screen to remove oversized material.
- 3. Compacting Equipment.** Provide at least three self-propelled pneumatic-tired rollers, each weighing at least 8 tons.
- 4. Brooms.** Provide motorized brooming equipment, capable of cleaning the road surface before treatment and removing loose particles after treatment. Provide pick-up sweepers to clean road surfaces adjacent to lawns or roadways with curb and gutter.
- 5. Pilot Car.** Provide a pilot car equipped with a sign that reads "Pilot Car — Follow Me" in accordance with [MDOT Sign Standard G20-4](#). Mount the sign in a conspicuous position on the rear of the vehicle.
- 6. Lights on Equipment.** Equip self-propelled equipment with at least one Department-approved, flashing, rotating, or oscillating amber light, visible in every direction. Equip chip spreaders with one light on each side of the spreader.

**B. Pre-Production Meeting.** Before beginning work, conduct an on-site pre-production meeting with the Engineer to discuss the following:

1. Review of the work schedule;
2. Examination of the traffic control plan;
3. Review of equipment calibration and adjustments;
4. Inspection of conditions of materials and equipment, including transport units;
5. Submission of the mix design including JMF and a "Design for Intended Yield," containing the aggregate gradation, LA Abrasion Resistance, loose unit weight, and application rate of asphalt emulsion and aggregate;
6. Submission of test results for flat and elongated ratio. Collect samples from one of the following locations:
  - a. The shipping face of the stockpile at the production source, or
  - b. The job site stockpile;
7. Discussion of the Quality Control (QC) plan; and
8. Designation of the Contractor's authorized representative.

**C. Weather and Seasonal Limitations.**

1. **Weather Limitations.** Place the chip seal when pavement and ambient temperatures are at least 55 °F. Do not place chip seal if air temperatures are forecast below 40 °F within 24 hours of completing placement. Do not apply chip seals in foggy or rainy weather, or if the existing pavement temperature is equal to or greater than 130 °F.
2. **Single Chip Seals and Shoulder Chip Seals Seasonal Limitations.** Place single chip seals and shoulder chip seals in accordance with the following:
  - a. From June 1 to August 15, in the Upper Peninsula;
  - b. From May 15 to September 1, in the Lower Peninsula north of M-46; and
  - c. From May 15 to September 15, in the Lower Peninsula south of M-46.
3. **Double Chip Seal Seasonal Limitations.** Place double chip seals in accordance with the following:
  - a. From June 1 to August 1, in the Upper Peninsula;
  - b. From May 15 to August 1, in the Lower Peninsula north of M-46; and
  - c. From May 15 to August 1, in the Lower Peninsula south of M-46.

**D. Placement Operation.**

1. **Signing.** Post signs along the roadway reading, "Loose Gravel," FHWA (W8-7), and mount a 35 mph speed plaque below the sign. Place the signs at no greater than ½-mile intervals throughout the length of the project.
2. **Dust Control.** During normal traffic operations, wet broom, or lightly fog seal the roadway to control dust, as required by the Engineer. If dusty conditions continue, pre-coat the aggregate. Pre-coat the aggregate with 0.75 percent, by mass, residual asphalt.

The Contractor may perform pre-coating in a weight-batch type, continuous mixing type, or drum-type hot mix plant, using PG 64-22 asphalt binder or CSS-1h emulsion.

3. **Loose Stone.** During normal traffic operations, damage to motorist' vehicles due to loose stone picked up off the surface is unsatisfactory. Broom or fog seal the roadway until the condition is eliminated.
4. **Bleeding or Tracking.** During normal traffic operations, bleeding or moderate tracking is unsatisfactory. Sand and sweep the roadway to eliminate bleeding or moderate tracking. If sanding and sweeping do not eliminate bleeding or moderate tracking, apply, roll, and broom a heated aggregate with the physical properties specified in [Table 902-8](#).
5. **Preparing Pavement Surface.** Prepare the pavement surface to receive the chip seal. Clean pavements requiring treatment with a motorized power broom to remove loose material. Use a hand broom to clean cracks and other areas inaccessible by power broom. Use pick-up sweepers adjacent to lawns or roadways with curb and gutter.
6. **Protecting Utility Castings and Raised Pavement Markers.** Before beginning the chip seal operation, protect utility castings and raised pavement markers using tarpaper or other Department-approved materials. Remove the protective coverings before sweeping and opening to traffic.
7. **Equipment Operation.** Operate vehicles and equipment involved in the chip sealing as close together as possible. Spread the aggregate to cover the asphalt emulsion within 30 seconds of application. Do not allow the chip spreader to trail the emulsion distributor by more than 150 feet.

## 8. Longitudinal Construction Joints.

- a. **Longitudinal Construction Joints in Single Chip Seal.** Where corrugations are not present, construct longitudinal construction joints in single chip seal to coincide with painted lane lines or at the outside edge of the shoulder except where corrugations are present. Where corrugations are present, construct joints at the outside edge of the far side of the corrugation on the first pass.
  - b. **Longitudinal Construction Joints in Double Chip Seal.** Where corrugations are not present, construct longitudinal construction joints in the first course of a double chip seal to overlap the painted lane lines by 6 inches, and in the second course to coincide with the original painted lane line locations. Where corrugations are present construct joints at the outside edge of the far side of the corrugation on the first pass. Construct joints at the outside edge of the opposite side of the corrugation for the second application.
  - c. **Longitudinal Construction Joints in Shoulder Chip Seal.** Construct the longitudinal construction joint in shoulder chip seal at the edge of the driving lane or at a location requiring a minimal overlap without extending onto the driving lane.
9. **Rolling.** Roll the aggregate after spreading. Allow no more than 2 minutes between the spreading of aggregate and completion of initial rolling. Use the rollers in a longitudinal direction at a speed no greater than 5 mph. Ensure each roller travels over the aggregate three times with the final pass in the direction of the chip spreader.
  10. **Sweeping after Placement.** After chip seal placement, use the sweeping equipment specified in subsection [505.03.A.4](#) to perform an initial sweep of the construction traffic control zone before opening to traffic. Allow a minimum waiting period of 30 minutes between application of the chip seal and initial sweeping. Additional sweeping to remove loose stones after opening to traffic will be required as determined by the Engineer. The Contractor may use an arrow board, in bar mode, pulled behind a vehicle trailing the sweeping equipment. Conduct sweeping so loose aggregate does not migrate back onto the pavement. Use a pick-up sweeper to remove loose aggregate adjacent to lawns, curbs, or intersections.
  11. **Cure Time and Repairs.** For double chip seals, wait at least 24 hours between completion of the first course and application of the second course.

Do not allow traffic on the new surface until it cures, to prevent pickup by vehicle tires. Repair traffic damage to the new chip seal surface at no additional cost to the Department.

Grind the surface and lightly apply a fog seal to eliminate bumps or poor riding surfaces caused by transverse or longitudinal construction joints from a chip seal application.

Readjust the spray bar and nozzles if longitudinal grooves or ridges in the surface cause an asymmetric appearance.

**E. Application Rates.** Apply the asphalt emulsion followed by a uniform application of coarse aggregate.

Notify the Engineer immediately if the coarse aggregate gradation, or existing pavement surface conditions, necessitate an adjustment to the JMF target rate. Document the new JMF rates by stationing.

1. **Asphalt Emulsion.** Apply asphalt emulsion from 0.39 gallons per square yard to 0.46 gallons per square yard. Apply the asphalt emulsion at a temperature from 170 °F to 190 °F.
2. **Coarse Aggregate.** Apply coarse aggregate from 20 pounds per square yard to 24 pounds per square yard.

**F. Documentation.**

1. **Daily Report.** Submit a daily report to the Engineer with the following information:
  - a. Control section;
  - b. Project number;
  - c. County;
  - d. Route;
  - e. Engineer;
  - f. Date;
  - g. Detailed weather information;
  - h. Pavement temperature;
  - i. Asphalt emulsion application temperature;
  - j. Beginning and ending stations (placement and brooming);
  - k. Notification of mix design change;
  - l. Aggregate gradation and moisture content (at least one per day); and
  - m. Signature of the Contractor's authorized representative,
2. **Miscellaneous.** Document the following as required:
  - a. Load tickets for coarse aggregates and asphalt emulsion; and
  - b. Changes in the design for intended yield.

**G. Quality Control (QC).** If the Engineer identifies conditions that cause an unsatisfactory chip seal, immediately stop production and begin corrective action, at no additional cost to the Department. Maintain QC measures until the Engineer accepts the work.

1. **Quality Control Plan.** Provide and follow a plan to maintain QC for production and construction processes, as required. Provide the Engineer a copy of the QC plan for review and approval, prior to the pre-production meeting.

Establish and maintain an effective QC plan. Ensure the QC plan, details procedures, and organization to produce the required single, double, and shoulder chip seal operations. Comply with the Engineer-approved QC plan for the duration of the project and allow the Engineer access to in-progress work for Assurance review and testing.

Ensure the QC plan addresses at least the following:

- a. Materials;
  - b. Sampling and testing methods to determine compliance with material specifications;
  - c. Equipment;
  - d. Calibration method to determine compliance with the application rates;
  - e. Procedures for pavement cleaning and preparation;
  - f. Controls implemented to ensure the chip seal material cures or sets up before opening to traffic;
  - g. Proposed procedure for monitoring initial acceptance requirements;
  - h. Dust control;
  - i. Bleeding;
  - j. Rough joints;
  - k. Surface patterns;
  - l. Procedures to ensure that both the initial and final sweeping are completed in a manner that prevents damage to vehicles; and
  - m. An action plan, demonstrating how the chip seal operation will be adjusted for adverse environmental conditions.
2. **QC Sampling and Testing.** Perform the following minimum QC tests during chip seal placement.
    - a. **Coarse Aggregate.** Determine the actual application rate by placing a tarp over 1 square yard of pavement, applying coarse aggregate to the pavement in a production run, retrieving the

aggregate placed on the tarp, and weighing the coarse aggregate. Place coarse aggregate within.

Collect one sample from the project aggregate stockpile each day of production, and perform a sieve analysis. Ensure sieve analysis results meet the requirements of Table 902-7 and fall within the quality control tolerances of Table 505-1 to substantiate the design for intended yield.

| <b>Parameter</b>           | <b>Tolerance</b>  |
|----------------------------|---|
| % in sieve                 | -5.0%   |
| No. 4 sieve                | +5.0%   |
| Aggregate Application rate | ±1 pound per square yard of the required JMF application rate |
| Emulsion Application Rate  | ±0.01 gallon per square yard of the JMF target rate           |

b. **Emulsion.** Determine the actual application rate using a 1,000-foot yield check. Apply the asphalt emulsion within.

#### H. **Acceptance.**

1. **Field Inspection Acceptance.** Upon completion of work, schedule an inspection with the Engineer. The Engineer will note deficiencies, including areas exhibiting adhesion failure, cohesion failure, excessive stone, loss of stone, or other factors the Engineer identifies as unacceptable. Correct work the Engineer determines unacceptable.
2. **Delayed Acceptance.** At least 30 days after placing the single chip seal, double chip seal, or shoulder chip seal, the Engineer, with the Contractor, will inspect the project for surface flushing, surface patterns, or loss of stone. If the Engineer determines the work includes these deficiencies, correct the work within 7 working days of the review, or by an agreed upon date, as approved by the Engineer, and at no additional cost to the Department.

#### 505.04. **Measurement and Payment.**

| <b>Pay Item</b>           | <b>Pay Unit</b> |
|---------------------------|-----------------|
| Seal, Single Chip .....   | Square Yard     |
| Seal, Double Chip .....   | Square Yard     |
| Seal, Shoulder Chip ..... | Square Yard     |

A. **Price Adjustment.** The Department will not make adjustments in the unit price for chip seal if the specified application rates for asphalt



emulsion and coarse aggregate are within the ranges specified in subsection [505.03.E](#).

The Department may make an adjustment for an Engineer-approved revision to the application rates of asphalt emulsion and coarse aggregate, if the rates are outside of the specified ranges. The Department will limit the unit price adjustment to the material costs outside the specified ranges.

Provide unit prices for use in determining price adjustments for asphalt emulsion and coarse aggregate at the pre-construction meeting.

**B. Seal, Single Chip.** The unit price for **Seal, Single Chip** includes the cost of placing a single application of asphalt emulsion and coarse aggregate to a pavement and the accompanying shoulders, and material sampling and testing, surface preparation, brooming, and documentation.

**C. Seal, Double Chip.** The unit price for **Seal, Double Chip** includes the cost of placing a double application of asphalt emulsion and coarse aggregate to a pavement and the accompanying shoulders, and material sampling and testing, surface preparation, brooming, and documentation.

**D. Seal, Shoulder Chip.** The unit price for **Seal, Shoulder Chip** includes the cost of placing a single application of asphalt emulsion and coarse aggregate to shoulders and material sampling and testing, surface preparation, brooming, and documentation.

## Section 506. SLURRY SEAL

**506.01. Description.** This work consists of providing traffic control, preparing the surface, and applying a slurry seal mixture.

**506.02. Materials.** Provide material in accordance with the following:

|                                |                     |
|--------------------------------|---------------------|
| Type I Portland Cement.....    | <a href="#">901</a> |
| Fine Aggregate, 2FA .....      | <a href="#">902</a> |
| Asphalt Emulsion, CSS-1h ..... | <a href="#">904</a> |
| Water .....                    | <a href="#">911</a> |

The Engineer will waive the cement mixing test for Asphalt Emulsions, CSS-1h.

**A. Mix Design Requirements.** Provide a slurry seal mix consisting of asphalt emulsion, fine aggregate, portland cement, water, and other additives. At least 10 working days before beginning production, submit to the Engineer a mix design prepared and certified by a Department-approved laboratory. The Contractor may use mix additives to provide additional control of the quick set properties and to increase adhesion. List additives as part of the mix design.

The Department will require a new mix design for any change in aggregate or asphalt emulsion sources.

Verify the compatibility and proportions of the fine aggregate, asphalt emulsion, portland cement, and additives.

From the mix design, develop a Job Mix Formula (JMF) showing the proportions of each material. Ensure the JMF complies with ASTM D 3910 for consistency, set time, cure time, and wet track abrasion.

Design a JMF with a residual asphalt binder content from 9.0 percent to 11.0 percent of the aggregate dry weight, and with a cement content from 0.5 percent to 3.0 percent of the aggregate dry weight.

1. **Mix Design Documentation.** Include all of the following in the mix design:
  - a. Sources of individual materials.
  - b. Aggregate properties including gradation, sand equivalence, and angularity index (A.I.).
  - c. Test results for the following parameters as tested in accordance with ASTM D 3910:
    - i. Consistency test,
    - ii. Set time,

- iii. Cure time, and
  - iv. Wet track abrasion.
- d. Interpretation of results and determination of a JMF including the following:
- i. Cement (minimum and maximum), percent;
  - ii. Water, including aggregate moisture (minimum and maximum), percent;
  - iii. Additive (if required), percent;
  - iv. Emulsion in mix, percent;
  - v. Residual asphalt content of emulsion; and
  - vi. Residual asphalt content in mix, percent.
- e. Mix designer's signature and date.

### 506.03. Construction.

A. **Equipment.** Provide equipment, in accordance with section [107](#) and this section, capable of producing a specification product.

1. **Slurry Seal Mixer.** Provide a continuous-flow slurry seal mixing machine with automated controls, capable of delivering predetermined proportions of aggregate, water, and asphalt emulsion to the mixing chamber, and capable of continuously discharging the mixed product. Do not mix violently. Equip and operate each mixing machine as follows:
- a. Easy to read metering devices that accurately measure the raw materials before they enter the pugmill.
  - b. A system to pre-wet the aggregate in the pugmill immediately before mixing with the emulsion.
  - c. A fines feeder with a metering device, or other approved means, to drop the required mineral filler quantity onto the aggregate before entering the mixing machine. Use the fines feeder if mineral filler is part of the aggregate blend.
  - d. A water pressure system and a fog-type spray bar to fog the surface immediately ahead of the spreading equipment. Apply water fog from 0.03 gallon per square yard to 0.06 gallon per square yard.
  - e. Capable of a speed of at least 60 feet per minute. Operate at less than 180 feet per minute.
  - f. Storage capacity to mix at least 7 tons of slurry seal.
  - g. A method of measuring materials in each slurry seal batch. Obtain the Engineer's approval of the measurement method and make available for observation.

- h. Check the slurry seal mixer weekly to ensure the condition of the equipment meets requirements.

The Engineer may use the recorders and measuring devices of the slurry seal unit to determine application rates, asphalt emulsion content, and mineral filler content of individual loads.

- 2. **Spreading Equipment.** Attach an adjustable, mechanical-type single squeegee distributor to the mixing machine. Equip the distributor with flexible material in contact with the road surface to prevent loss of slurry. Ensure a uniform application of slurry on varying grades and crowns. Provide a steerable distributor, adjustable in width with a flexible strike-off.

Ensure the spreader box does not leave grooves in the slurry. Keep the spreader box clean, and do not allow material build-up on the spreader.

Obtain the Engineer's approval of burlap, or other textile drag. Wet the drag with water at the beginning of each application. Clean or change the drag as directed by the Engineer.

- 3. **Calibration Requirements.** Before construction, calibrate each slurry seal mixer in accordance with the *Asphalt Institute Manual Series No. 19*, 2<sup>nd</sup> edition. Submit to the Engineer documentation of the calibration of each material metering device at various settings. Supply materials and equipment, including scales and containers, for calibration. After calibrating each mixing machine, demonstrate to the Engineer the ability of the machine to mix components together to simulate an end product. Repeat mixer calibration for changes in aggregate or asphalt emulsion source.
- 4. **Miscellaneous Equipment.** Provide hand squeegees, shovels, and other equipment to perform the work. Provide cleaning equipment including power brooms, air compressors, water flushing equipment, and hand brooms for surface preparation.
- 5. **Lights on Equipment.** Equip power brooms, distributors, and truck-mounted spreaders and mixers with at least one Department-approved, flashing, rotating, or oscillating amber light, visible in every direction. Equip continuous mixer and spreader units with one light on each side of the machine.
- B. **Pre-Production Meeting.** Before beginning work, conduct an on-site pre-paving meeting with the Engineer to discuss the following:
  - 1. Contractor's detailed work schedule;
  - 2. Traffic control plan;

3. Equipment calibration;
4. Mix design previously submitted to the Engineer;
5. Equipment inspection, including transport units;
6. Surface preparation and pre-treatment;
7. [Permit to Place](#) (Form 1125); and
8. Availability of materials.

C. **Surface Preparation.** Remove loose material, vegetation, dirt, mud, and other deleterious materials, and wash animal remains from the surface before placing the slurry seal.

Before placing slurry seal, treat visible cracks with overband crack fill in accordance with section [502](#).

If a bond coat is required, use one part CSS-1h emulsified asphalt to three parts water, and apply at a rate of 0.05 gallons per square yard. Allow the bond coat to cure before placing the slurry seal.

D. **Application.** Apply a single course of slurry seal over the area shown on the plans at a rate of at least 16 pounds per square yard, based on the weight of dry aggregate.

E. **Surface Quality.** Provide a finished surface, free of scratch marks, rippling, and other surface irregularities. Do not leave tear marks greater than ½ inch wide and 4 inches long, or other marks greater than 1 inch wide and 1 inch long.

F. **Cure Time and Repair.** Do not allow traffic on the new surface until it cures, to prevent pickup by vehicle tires. Repair traffic damage to the new slurry seal surface at no additional cost to the Department.

G. **Weather and Seasonal Limitations.**

1. **Weather Limitations.** Place the slurry seal when pavement and ambient air temperatures are at least 45 °F and are rising. Do not place mix in rain or inclement weather, or if temperatures are forecast below 32 °F within 24 hours of application.
2. **Seasonal Limitations.** Place slurry seal in accordance with the following seasonal limitations:
  - a. From June 1 to September 15, in the Upper Peninsula; or
  - b. From May 1 to October 1, in the Lower Peninsula.

H. **Quality Control.** If the Engineer identifies conditions that cause an unsatisfactory slurry seal, immediately stop production and begin corrective action, at no additional cost to the Department. Maintain QC measures until the Engineer accepts the work.

Produce a mix that meets the JMF and the QC tolerances specified in Table 506-1. Notify the Engineer immediately and stop mix production if the QC test results exceed the tolerance specified in Table 506-1. Identify the cause of the deviation and determine the corrective action necessary to bring the mix into compliance. Obtain the Engineer's approval before resuming work.

1. **Sampling and Testing.** Conduct QC sampling and testing at the following minimum frequency:
  - a. Randomly sample fine aggregate from the mixer and test for gradation at a rate of one test per 500 ton of aggregate. Conduct at least one test per day of mix production.
  - b. Randomly, at least three times per day, calculate the percent asphalt content of the mixture using the equipment counter readings.

| <b>Table 506-1</b>                            |                      |
|---|----------------------|
| <b>Slurry Seal Quality Control Tolerances</b> |                      |
| <b>Sieve Size</b>                             | <b>Tolerance (±)</b> |
| No. 4   | 5.0%                 |
| No. 8   | 5.0%                 |
| No. 16  | 5.0%                 |
| No. 30  | 5.0%                 |
| No. 50  | 4.0%                 |
| No. 100                                       | 3.0%                 |
| No. 200                                       | 2.0%                 |
| <b>General Quality Control Tolerances (±)</b> |                      |
| <b>Parameter</b>                              | <b>Tolerance</b>     |
| Asphalt Cement Content Single Test            | 0.5% from JMF        |
| Asphalt Cement Content Daily Average          | 0.2% from JMF        |

2. **Documentation.** Within 1 working day of mix production and placement, provide a daily report to the Engineer with the following information:
  - a. Control section;
  - b. Project number;
  - c. County;
  - d. Route;
  - e. Engineer;
  - f. Date;
  - g. Air temperature;
  - h. Control settings;
  - i. Calibration values;
  - j. Unit weight of emulsion (pounds per gallon);
  - k. Percent residue in emulsion;
  - l. Beginning and ending stations;

- m. Counter readings (beginning, ending, and total difference);
- n. Aggregates placed;
- o. Gallons of emulsion placed;
- p. Percent of each material;
- q. Percent of asphalt cement;
- r. Application rate;
- s. JMF (percent portland cement, percent emulsion, gradation, percent AC);
- t. Contractor's authorized signature;
- u. Calibration forms;
- v. Aggregate gradations;
- w. Aggregate certification or [Shipment of Tested Stock Report](#) (Form 1922); and
- x. Asphalt emulsion load ticket and [Shipment of Tested Stock Report](#) (Form 1922).

If using truck mounted machines, prepare a separate daily report for each machine.

**I. Acceptance.**

- 1. **Field Inspection Acceptance.** Upon completion of work, schedule an inspection with the Engineer. The Engineer will note deficiencies, including areas exhibiting adhesion or cohesion failure, or other factors the Engineer determines unacceptable. Correct work identified by the Engineer as unacceptable.
- 2. **Delayed Acceptance.** At least 30 days after completion of the slurry seal, the Engineer will inspect the project for surface flushing and loss of material. If the Engineer finds these deficiencies, correct the work as approved by the Engineer within 7 working days of the inspection, or other date, as agreed by the Engineer, and at no additional cost to the Department.

**506.04. Measurement and Payment.**

| <b>Pay Item</b>    | <b>Pay Unit</b> |
|--------------------|-----------------|
| Seal, Slurry ..... | Square Yard     |

The unit price for **Seal, Slurry** includes the cost of cleaning existing pavement surface, applying a bond coat, placing the mix, and traffic control, including traffic control to complete corrective action.

The Department will pay separately for overband crack fill pre-treatment, in accordance with subsection [502.04](#).

## DIVISION 6 – PORTLAND CEMENT CONCRETE PAVEMENTS

| <b>Section</b> | <b>Title</b>                                      | <b>Page No.</b>     |
|----------------|---|---------------------|
| 601            | Portland Cement Concrete for Pavements .....      | <a href="#">287</a> |
| 602            | Concrete Pavement Construction .....              | <a href="#">301</a> |
| 603            | Concrete Pavement Restoration.....                | <a href="#">327</a> |
| 604            | Contractor Quality Control for Concrete .....     | <a href="#">344</a> |
| 605            | Quality Assurance (Acceptance) for Concrete ..... | <a href="#">345</a> |



## NOTES

## Section 601 PORTLAND CEMENT CONCRETE FOR PAVEMENTS

**601.01. Description.** This work consists of providing and placing a concrete mixture of portland cement, blended portland cement, supplemental cementitious materials, fine aggregate, coarse aggregate, water, and admixtures, combined in proportions for the grades of concrete required.

The term “sack” refers to a 94 pound sack of cement.

**601.02. Materials.** Provide materials in accordance with the following:

|   |                     |
|---|---------------------|
| Cement .....  | <a href="#">901</a> |
| Slag Cement.....                                    | <a href="#">901</a> |
| Fly Ash.....  | <a href="#">901</a> |
| Coarse Aggregate 4AA, 6A, 6AA, 6AAA, 26A, 29A ..... | <a href="#">902</a> |
| Fine Aggregate 2NS .....                            | <a href="#">902</a> |
| Concrete Admixtures .....                           | <a href="#">903</a> |
| Water .....   | <a href="#">911</a> |

Select coarse aggregate for the required grade of concrete in accordance with Table [601-2](#).

Use stone sand 2SS only in concrete not exposed to vehicular traffic.

Provide concrete having an entrained air content of 5.0 to 8.5 percent unless otherwise required by the contract. The Department will not reject concrete, based solely on an air content less than 5.0 percent, provided the concrete is incorporated into the finished work at least 3 feet below the surface of the ground or is entirely under water.

The Contractor may use slag cement and fly ash as an optional portion of the cementing material with portland cement.

### 601.03. General Requirements.

**A. Certified Batching Plants.** Provide portland cement concrete from certified portable and stationary concrete batch plant facilities that meet the current requirements of the National Ready Mixed Concrete Association (NRMCA) or other Department approved certification programs for automatic control and automatic systems including the following:

#### 1. Plant Certification.

- a. **Stationary Concrete Batch Plants.** Maintain plant equipment, facilities, associated weighing and batching devices during production. Schedule inspections, and maintain valid plant certification. Meet the requirements specified in the NRMCA

*Certification of Ready Mixed Concrete Production Facilities Quality Control Manual* or other Department-approved program requirements.

Provide for scale inspections that conform to Item 2.1.2 of the NRMCA *Certification of Ready Mixed Concrete Production Facilities Quality Control Manual*, Section 3, “Plant Certification Check List” (the NRMCA checklist), or other Department-approved program requirements, at intervals no longer than six months.

Check the batching accuracy of volumetric admixture dispensers and volumetric water batching devices (including water meters) in accordance with Item 2.5.3 and Item 2.5.4 of the NRMCA checklist, or other Department-approved program requirements, at intervals no longer than 90 days.

- b. **Portable Concrete Batch Plants.** At the start of production, and annually thereafter, ensure portable concrete batch plants meet the requirements of subsection [601.03.A.1.a](#). After each move, verify by inspection that the plant meets the requirements for certification. Provide documentation of inspection to the Engineer. Enlist the services of a registered private scale inspection agency to certify the calibration and working order of the weighing system after each move, before production.

Clearly display current inspection reports, certifying that scales and volumetric batching devices meet the required tolerances at each plant facility. Conduct inspections using qualified company personnel, outside agencies, or scale companies. Display a photocopy of the inspection checklist, completed by the inspecting engineer, at each plant facility before providing material to the project. Display the Certificate of Conformance at each plant facility, provided by the NRMCA or other Department-approved program administrator. Send current copies of the Certificate of Conformance, scale inspection reports, and inspection reports on volumetric batching devices to the Engineer.

Correct nonconformance to certification requirements before continuing concreting operations.

The Department may inspect batching equipment, facilities, and associated weighing and batching devices, and review the qualifications of private plant and scale inspectors, or inspection agencies.

2. **Batch Tolerances.** Provide batching equipment meeting the tolerances specified in the inspection checklist.
  - a. **Cementitious Materials.** Provide cementitious materials within  $\pm 1$  percent of the required weight, or for loads less than 30 percent of the scale capacity, within  $\pm 0.3$  percent of the scale capacity.
  - b. **Aggregates.** Provide aggregates within one of the following tolerances:
    - i.  $\pm 2$  percent of the required weights;
    - ii.  $\pm 1$  percent of the required intermediate and final cumulative weights in aggregate batchers; or
    - iii.  $\pm 0.2$  percent of the scale capacity for intermediate weights below 15 percent of the scale capacity and for final cumulative weights, 30 percent below scale capacity.
  - c. **Water.** Provide water within  $\pm 1.5$  percent of the required quantity, or  $\pm 1.0$  gallon, whichever is greater.
  - d. **Admixtures.** Provide admixtures within  $\pm 3$  percent of the required quantity, or plus or minus the minimum dosage rate per 100 pounds of cementitious material, whichever is greater.
3. **Capacity.** Provide weighing and batching equipment capable of weighing, in a single weighing, the quantity of each material required to complete the final batch, unless the plant is equipped to weigh the materials using one of the following alternate methods:
  - a. A device that automatically cycles to provide the required number of increments; or
  - b. An automatic recording device that provides a permanent record of the quantity of cement, aggregate, and water measured in each individual batch.
4. **Ticketing System and Weekly Summary.** Provide a ticketing system conforming to the NRMCA or other Department-approved program requirements. Ensure the information on the delivery ticket is computer generated. Customer information may be hand printed on each ticket.

Provide a space on each ticket for the inspector to sign at the project. If producing concrete for more than one project, include on each ticket, certification executed by the concrete producer. Include a certification statement that concrete materials are tested and approved, or certified as meeting Department specifications. If using a dedicated batch plant for only one paving project, the Department

does not require an inspector signature or the concrete producer's certification on the delivery ticket. Provide one signature for the daily production, accompanied by the daily summary of concrete production.

Provide an automated printout of target and actual batch weights with each delivery ticket. If target and actual batch weight information is computer generated on a separate document, include the serial number of the corresponding delivery ticket, or other means of cross reference. Attach the automated printout of target and actual batch weights to the corresponding delivery ticket. Collect tickets accompanying loads of concrete and provide them to the inspector.

The Engineer may require additional information and a signature on the tickets.

Provide a weekly summary of daily batching operations with shipments identified by project to the MDOT region materials staff for projects located in the region.

**B. Non-Certified Batching Plants.** Provide automatic cement and aggregate batchers.

1. **Weighing and Batching Equipment.** Provide weighing and batching equipment capable of weighing, in a single weighing, the quantity of each material required to produce proportioned concrete, unless the plant is equipped to weigh the materials using one of the following methods:
  - a. A device that automatically cycles to provide the required number of increments for a batch; or
  - b. A Department-approved automatic recording device that shows the number of increments placed in each batch.

With each method, make batch increments of equal size, unless the weighing equipment automatically meets the requirements specified in subsection [601.03.A.3](#) for varying batch sizes.

Weigh cement and aggregates on separate scales in separate weigh hoppers, except in plants equipped to weigh cement cumulatively with aggregates by first weighing cement in an enclosed compartment of a single weigh hopper. If weighing cement cumulatively with aggregates, conform to the batching tolerances specified in subsection [601.03.A.2](#).

Discharge cement and aggregate in accordance with subsection [601.03.A](#), except discharge cement within  $\pm 1$  percent of the cement

batch weight. Discharge aggregates within  $\pm 1$  percent of the combined aggregate batch weights, or 94 pounds, whichever is less.

If using fly ash or slag cement as a blending material, weigh fly ash or slag cement separately or cumulatively with the portland cement.

2. **Bins and Hoppers.** Provide the following:
  - a. Equipment to load aggregate bins capable of transporting and discharging the aggregate into the bins without spilling into other stockpiles, bins, or compartments;
  - b. Weather tight bins for cement, fly ash, and slag cement;
  - c. Weighing hoppers of a size and shape capable of holding the material without leaking, supported entirely on the scales;
  - d. Hoppers and appurtenances designed and constructed to prevent loss of material by air currents or other means during weighing and discharge; and
  - e. Protection for the material against loss or damage while transferring from the weigh hoppers to the mixer.
  
3. **Scales.** Enlist a registered private scale inspection agency to certify the calibration and working order of the weighing system before production. Display current inspection reports certifying that scales and volumetric batching devices meet the required tolerance at each plant facility. Send current copies of the scale inspection reports and inspection reports to the Engineer.
  
4. **Automatic Controls.** Provide automatic controls for batching equipment with individual starting mechanisms for each material, or a single starting mechanism that when actuated controls all functions of the weighing and metering operations for the materials. For each material weighed, ensure placement of the required weight in the weigh hopper and that the scale indicator balances within the required tolerances for at least 1 second before continuing succeeding operations.

Equip the automatic control for each batching scale system with a device for stopping the automatic cycle in the underweight and overweight check positions for each material.

Electrically operate and interlock automatic batchers to provide the following controls for each material weighed:

- a. Interlock the hopper inlet mechanism to prevent opening if the discharge gate is open; and
- b. Interlock the hopper discharge mechanism to prevent the following:

- i. Opening while filling the hopper;
- ii. Opening before the full batch is in the hopper and the scale balanced;
- iii. Opening if the batch in the hopper is overweight or underweight by more than the required tolerances; and
- iv. Closing and locking and starting the next batch before emptying the hopper to less than 1 percent of the batch weight for the scale, or 94 pounds.

Do not allow the automatic control system sensing mechanism to exert a force on the scale weighing mechanism or indicating mechanism within the weighing range of the indicator.

Equip each dial scale system with a removable dial puller that inspectors can attach to the dial lever system to check the automatic control system settings by moving the dial smoothly and slowly through its range.

Provide weighing systems equipped with load cells, including a device capable of simulating load conditions to enable verification of proportioning setpoints and interlocking tolerances for each material. Equip the device with the ranges or adjustments to enable a display of each consecutive value of digital indication, held for the time necessary for inspection.

Ensure the plant operator completes the automatic control system checkout procedure periodically, as requested by the Engineer.

5. **Dispensers and Controls for Liquid Admixtures.** Provide dispensers capable of measuring the admixture volumetrically. Ensure batching controls are clearly visible to allow the operator to monitor the accuracy of admixture delivery. Start the admixture dispenser system using the single starting mechanism for the entire batching system, or for one of the primary ingredients of the mixture. Introduce the admixture into the sand, the water line, or directly into the mixing drum.

Use a separate dispenser for each admixture. If using more than one admixture, avoid intermixing admixtures before introduction into the mixture by dispensing admixtures as follows:

- a. Outlet into different portions of the sand in the weigh hopper;
- b. Outlet into different locations in the water line;
- c. Use separate outlets into the sand, the water line, and the mixer drum; or
- d. Cycle through a common outlet to dispense only one admixture at a time.

Provide a dispenser piping system free of leaks with valves to prevent backflow or siphoning.

Provide a dispenser system for admixtures capable of measuring and dispensing the quantity required for each batch. Include a device on the dispensing system showing the flow of admixture, or showing if admixture is in the dispenser.

Provide a dispensing device with an accuracy within  $\pm 3$  percent of the required material volume batched, or within  $\pm 1.0$  fluid ounces, whichever is greater. Equip the plant with the calibrated devices to check the dispensed volume to the required accuracy.

Provide batching controls that start the batching operation and stop the flow automatically when the required volume is measured. Ensure controls show when the batching operation is complete.

Interlock the admixture dispenser system with the batching operations to ensure the dispenser resets to start before charging. Interlock the dispenser to ensure it does not start admixture discharge unless the controls are cleared of the previous batch with the volumetric devices resetting to start or signaling empty.

6. **Water Measuring Equipment.** Measure water by volume or weight. If directed by the Engineer, demonstrate the accuracy of water measuring equipment. Ensure the water system discharges the required water into the mixer drum during the first  $\frac{1}{3}$  of the required mixing time and stops the flow automatically after discharging the required quantity of water. Provide an indicator to show the quantity of water used in each batch.
7. **Mixers.** Provide Department-approved batch mixers meeting the requirements of this subsection. Ensure mixers combine the aggregates, cement, water, and admixtures and discharge the mixture without segregation.

Provide portable and central batch type mixers. Equip batch type mixers with a timing device that automatically locks the discharge mechanism during mixing and releases at the end of the mixing period. Provide a mixer capable of mixing the entire volume of batched material in one operation.

Provide revolving drum truck mixers in good condition. Ensure mix materials, including water, do not leak or spill from the time of charging until discharged. Equip the mixer with a Department-approved revolution counter. Use truck mixers capable of removing wash water collected in the mixer drum.



Ensure mixers have an attached metal plate showing the following information:

- a. Serial number;
  - b. Maximum mixing capacity in volume of mixed concrete;
  - c. Mixing speed of the drum; and
  - d. The maximum agitating capacity in volume of mixed concrete, or on truck mixers and agitators, the agitating speed of the drum or blades.
8. **Concrete Hauling Units.** Provide hauling units capable of delivering concrete in a non-segregated condition. Maintain equipment in good condition. Ensure mix materials, including water, do not leak or spill from the time of loading until discharged.
  9. **Continuous Batching and Mixing.** Provide continuous batching and mixing equipment meeting the requirements of ASTM C 685. Only use continuous batching and mixing equipment for proportioning latex modified concrete or prepackaged hydraulic fast set patching mixtures.
  10. **Inspector Facilities.** Provide space for the inspector to observe batching operations, and provide desk space in commercial plants, for the inspector's use.

If the contract requires determination of the water to cementitious material ratio, provide sample-drying equipment, work, and storage areas for performing moisture tests and storing equipment.

**C. Waiver of NRMCA Certification and/or Automation Requirements.** If no fully automated, certified facility is located within 25 miles of the project, the Engineer may waive certification, automation requirements, or both.

1. **Waiver of Certification.** The Engineer may allow the use of non-certified, automated plants if no fully automated, certified facility is located within 25 miles of the project. Provide an automated plant that meets the requirements of subsection [601.03.B](#).
2. **Waiver of Automation and Certification.** The Engineer may allow the use of non-certified, manual plants if no automated plant with batching facilities meeting the requirements of subsection [601.03.B](#), is located within 25 miles of the project. If no automatic plant is located within 25 miles of the project, the Engineer will not require the following devices specified in subsection [601.03.B](#):
  - a. Automatic incremental batch cycling devices,
  - b. Interlocking devices for cement and aggregate,

- c. Electrical tolerance indicator devices, and
- d. Automatic dispensers for admixtures.

#### D. **Providing and Handling Materials**

1. **Aggregates.** Provide, stockpile, and handle aggregates to minimize segregation. Place each aggregate source and type in a separate bin or stockpile. Do not intermix aggregate sources. Provide firm, level ground for stockpiles and clean the area of deleterious material before importing aggregates. If stockpile areas are not paved, do not use the bottom 12 inches of the stockpile. Do not use lumps of frozen aggregate. Use appropriate equipment and stockpile management procedures to ensure that the aggregates are maintained within specifications.

Maintain a uniform aggregate moisture content during each day's run, without evidence of surplus water. Keep stockpiles of slag and other highly absorptive aggregates at a uniform saturated surface-dry moisture content using the methods specified in the Department-approved Contractor Concrete Quality Control Plan.

Store fine and coarse aggregates for Department work in separate piles or bins, separate from aggregates for other work. If the coarse aggregate consists of a blend of at least two gradations, stockpile each gradation separately.

2. **Cementitious Material.** Store cementitious material provided in bulk form in separate weatherproof bins. Do not use wet or contaminated material.

Before refilling bins with new material of a different type or grade of cementitious material, empty bins to a quantity less than the quantity necessary for two concrete batches.

Changes in cementitious material sources will require a new mix design.

Provide the Engineer with a copy of the shipment notice showing the quantity of each cementitious material for each shipment and certification that material meets Department specifications.

3. **Chemical Admixtures.** Handle, store, and protect chemical admixtures in accordance with the manufacturer's recommendations.

#### E. **Mixing Concrete.**

1. **General.** Produce and deliver ready-mixed concrete as central-mixed or truck-mixed concrete. The Department considers central-mixed concrete completely mixed in a central mixer and transported

to the project in a truck agitator, a truck mixer, or Department-approved non-agitating equipment. The Department considers truck-mixed concrete completely mixed at the plant site in a truck mixer with a Department-approved revolution counter.

Provide communication service from the project to the batching plant and make the service available to the Engineer during concreting operations.

Empty the mixer drum completely after each batch and before recharging. Do not exceed the capacity of the mixer shown on the metal plate attached to the mixer. For agitating units and truck mixers used to transport central-mixed concrete, do not exceed the manufacturer's recommended batch size for the maximum agitating capacity of the equipment.

2. **Batch Mixing.** Rotate the drum or blades at the speeds recommended by the manufacturer and shown on the metal plate attached to the mixer. Measure mixing time from the time all cement and aggregates are in the mixer until the start of concrete discharge. For multi-compartment mixers the mixing time includes the transfer time between drums. Charge the ingredients into the mixer so some water enters before the cement and aggregate, and all the water enters the drum before  $\frac{1}{3}$  of the required mixing time elapses.
  - a. **Central Mixed Concrete.** Mix each batch of central-mixed concrete 45 seconds for turbine mixers and 60 seconds for revolving drum and pugmill mixers, or as otherwise specified in the quality control plan. For revolving drum and pugmill mixers with a capacity of 1 cubic yard or less, mix for at least 90 seconds.
  - b. **Truck Mixed Concrete.** Mix each batch of truck mixed concrete for more than 70 revolutions at mixing speed.
3. **Elapsed Time.** Do not exceed the time limits specified in Table 601-1 from the time of charging the mixer to complete concrete discharge.

Charging begins when the cement contacts the mixing water or damp aggregates.

For agitating units and truck mixers, if the time from charging the mixer to complete discharge may exceed 30 minutes, continuously agitate the concrete.

**Table 601-1  
Time Between Charging Mixer and Placing Concrete (a)**

| Type of Unit  | Concrete Temperature (ASTM C 1064) |               |        |
|---|------------------------------------|---------------|--------|
|   | <60 °F                             | 60 °F – 85 °F | >85 °F |
| Open Top Trucks (b)   | 60                                 | 45            | 30     |
| Open Top Agitating Units (b)  | 60                                 | 60            | 30     |
| Closed Top Agitating Units and Truck Mixers   | 90                                 | 60            | 45     |
| Truck Mixers and Closed Top Agitating Units with Concrete Containing Water-Reducing Retarding Admixture (c) | 120                                | 90            | 70     |

a. Times shown in this table are in minutes.

b. Not allowed for structural concrete.

c. Superstructure concrete must meet the time limits for closed top agitating units and truck mixers.

4. **Additional Water at Placement Site.** Add water to concrete transported in truck mixers only if additional mixing water is needed for the concrete to achieve the slump specified in the approved mix design and the batch in the truck mixer does not exceed the rated mixing capacity. Do not add more water than specified in the Department-approved concrete mix design, based on the maximum water content and maximum water to cementitious material ratio. After adding water, provide at least 30 revolutions of the truck mixer drum at mixing speed before discharging concrete. Complete additional mixing at the project within the maximum time specified in subsection [601.03.E.3](#). Document, on the delivery ticket, water added after batching and the resulting water to cementitious material ratio. Provide the information to the Engineer on a daily basis. Do not add water to the concrete during discharge or placement. Do not add water in truck chutes or pump or slipform hoppers beyond the minimum necessary to wet the surfaces for lubrication.

F. **Concrete Temperature Requirements.** At the time of concrete placement, ensure a concrete temperature from 45 °F to 90 °F.

1. **Heating Concrete Constituents.** Heat the water, the aggregates, or both to meet the minimum required placement temperature. Do not heat aggregates to more than 150 °F.

If heating the concrete constituents, do not exceed a plastic concrete temperature of 80 °F, except if placing concrete in insulated forms, do not exceed a plastic concrete temperature of 70 °F. Mix the water with the aggregates before adding the cement.

Use aggregates free of ice and frozen lumps at time of batching. Heat aggregates in stockpiles or bins using steam or hot water coils, live steam, or by indirect hot air. Do not use direct flame to heat coarse aggregate. During batching operations, compensate for

accumulated condensation from heating to maintain the slump within the required limits.

2. **Concrete Accelerators.** For concrete pavements, if the mean daily air temperature is forecast to remain below 45 °F during the curing period, the Engineer may allow or require the use of additional cement or a non-chloride accelerating admixture. Include the increased cement content or the admixture content in the mixture requirements.

G. **Concrete Quality Control.** Provide quality control for concrete in accordance with section [604](#). Unless otherwise required, supply concrete pavement mixtures meeting the requirements of Table [601-2](#). Use supplemental cementitious materials as allowed by the contract.

H. **Work Progress Specimen.** Ensure that the strength of pavement and structure concrete meets the requirements of subsection [104.11.B](#) for opening to construction traffic or vehicular traffic, removing shoring or forms, or similar operations. Determine concrete strength by one or more of the methods specified in subsections [601.03.H.1](#) or [601.03.H.2](#). Allow the Engineer to witness testing of work progress cylinder or beam specimens and non-destructive testing, including calibration tests.

Adjust operations as necessary to conform to the specified concrete strength requirements.

1. **Test Cylinders or Beams.** Make a series of test cylinders or beams. Cure the specimens in environmental conditions similar to those in which the pavement or structure will cure.

2. **Non-Destructive Tests.** Conduct non-destructive tests at locations designated or approved by the Engineer. Perform non-destructive tests according to ASTM C 803 or ASTM C 805. Calibrate non-destructive test equipment between the strength of flexure or compression test specimens at various stages of curing, and rebound number measured by a concrete test hammer, or penetration resistance. Calibrate for a given instrument and for the specific materials and concrete mix. Make and test occasional cylinders or beams to verify the calibration.

Obtain the Engineer's approval for alternative non-destructive concrete strength test methods.

**601.04. Measurement and Payment.** The cost of portland cement concrete pavement mixtures is included in unit prices for related pay items.

| Table 601-2<br>Concrete Pavement Mixtures |   |                          |       |                            |       |        |        |                               |       |        |        |
|---|---|--------------------------|-------|----------------------------|-------|--------|--------|-------------------------------|-------|--------|--------|
| Minimum Class Design Strength (a)         |   |                          |       |                            |       |        |        |                               |       |        |        |
|   |   |                          |       | Flexural Strength<br>(psi) |       |        |        | Compressive Strength<br>(psi) |       |        |        |
| Concrete<br>Grade<br>(b, c, g)            | Section<br>Number<br>Reference<br>(i)   | Cement Content<br>(d, h) |       | 3days                      | 7days | 14days | 28days | 3days                         | 7days | 14days | 28days |
|   |   | lb/cyd                   | sacks |                            |       |        |        |                               |       |        |        |
| P-NC                                      | <u>603, 801</u>   | 658                      | 7.0   | 550                        | 600   | —      | 650    | 2,600                         | 3,000 | —      | 3,500  |
| P1M (f)                                   | <u>602, 603</u>   | 470 – 564                |       | —                          | 550   | 600    | 650    | —                             | 2,600 | 3,000  | 3,500  |
| P1  | <u>602, 603,</u><br><u>801, 802,</u><br><u>803, 810</u>   | 564                      | 6.0   | —                          | 550   | 600    | 650    | —                             | 2,600 | 3,000  | 3,500  |
|   |   | 526 (e)                  | 5.6   |                            |       |        |        |                               |       |        |        |
| P2  | <u>602, 803,</u><br><u>804, 806,</u><br><u>808, 810,</u><br><u>813, 814,</u><br><u>819</u>  | 517                      | 5.5   | —                          | 500   | 550    | 600    | —                             | 2,200 | 2,600  | 3,000  |
|   |   | 489 (e)                  | 5.2   |                            |       |        |        |                               |       |        |        |
| M   | Commercial grade concrete containing 517 lb/cyd (5½ sacks/cyd) of cement. If substituting 1.0 lb of fly ash for each pound of cement removed, the Contractor may reduce portland cement up to 20%, by weight.                           |                          |       |                            |       |        |        |                               |       |        |        |
| X   | Unless otherwise specified, Grade X concrete contains at least 282 lb/cyd (3.0 sacks/cyd) of cement. If substituting 1.0 lb of fly ash for each pound of cement removed, the Contractor may reduce portland cement up to 20% by weight. |                          |       |                            |       |        |        |                               |       |        |        |

Table 601-2

## Concrete Pavement Mixtures (continued)

- a. Use flexural strength for opening to traffic and compressive strength for acceptance in other paving situations.
- b. Use coarse aggregate 6A, 6AA or 6AAA for Grades P-NC, P1, P2 and M. Use Class 6AAA coarse aggregate exclusively for mainline and ramp concrete pavement if the directional ADT is greater than or equal to 5,000 vehicles per day.
- c. The mix design basis for bulk volume (dry, loose) of coarse aggregate per unit volume of concrete is 72% for Grades P-NC and P1; 74% for Grade P2.
- d. If the local average minimum temperature for the next 10 consecutive days after concrete placement is forecast to be below 40 °F, submit a revised quality control plan for the Engineer's approval prior to cold weather concrete placement. The revised plan must detail changes in materials, concrete batching and mixing processes, construction methods, curing, and protection of the in situ concrete to ensure that the quality characteristics of the hardened concrete are not compromised by the cold weather.
- e. Use the manufacturer's recommended quantity of water-reducing admixture, specified in the Qualified Products List, to provide reduction in mixing water for mixes with reduced cement content.
- f. Grade P1M concrete requires an optimized aggregate gradation as specified in section [604 \(MTM 130\)](#). Use aggregates from only geologically natural sources. Coarse aggregates must meet the physical requirements specified in subsection [902.03.C](#).
- g. The Contractor may use an optimized aggregate gradation, as required ([MTM 130](#)).
- h. Type III cement is not permitted.
- i. Number Reference
- |                     |  |                     |                                     |
|---------------------|--|---------------------|-------------------------------------|
| <a href="#">902</a> | Concrete Pavement                            | <a href="#">603</a> | Concrete Pavement Restoration       |
| <a href="#">801</a> | Concrete Driveways                           | <a href="#">802</a> | Concrete Curb, Gutter and Dividers  |
| <a href="#">903</a> | Concrete Sidewalk, Sidewalk Ramps, and Steps | <a href="#">804</a> | Concrete Barriers and Glare Screens |
| <a href="#">810</a> | Permanent Traffic Signs and Supports         | <a href="#">813</a> | Slope Protection                    |
| <a href="#">814</a> | Paved Ditches                                | <a href="#">819</a> | Electrical and Lighting             |

## Section 602. CONCRETE PAVEMENT CONSTRUCTION

**602.01. Description.** This work consists of constructing a jointed portland cement concrete pavement, unbonded concrete overlay, base course, or shoulder, with or without reinforcement. This work also includes submitting a concrete quality control plan in accordance with section [604](#) before beginning concrete production.

**A. Classification.** The term "pavement", as used in these specifications, may include the following:

**Concrete Pavement.** Concrete placed for mainline pavement, multiple lane ramps, and collector-distributor roadways. Typical sections consist of standard widths and of lengths conducive to production paving.

**Concrete Overlay.** Concrete pavement placed on an existing pavement section. Typical sections consist of standard widths and of lengths conducive to production paving.

**Miscellaneous Concrete Pavement and Miscellaneous Concrete Overlay.** Concrete placed for single lane ramps, acceleration/deceleration lanes, approaches, and intersections, and pavement gaps. Typical sections consist of variable widths and limited lengths not conducive to production paving.

**Temporary Concrete Pavement.** Concrete pavements constructed for temporary duration.

**Concrete Pavement with Integral Curb.** Pavement and curb constructed monolithically.

**Concrete Base Course.** Concrete pavement that will be surfaced with hot mix asphalt (HMA) or concrete overlay.

**Concrete Shoulders.** Concrete pavements placed as shoulders.

**602.02. Materials.** Provide materials in accordance with the following:

|                                   |                     |
|-----------------------------------|---------------------|
| Concrete, Grades P1, P1M, P2..... | <a href="#">601</a> |
| Curing Materials .....            | <a href="#">903</a> |
| Epoxy Coated Lane Ties .....      | <a href="#">905</a> |
| Steel Reinforcement.....          | <a href="#">905</a> |
| Bond Breaker Material.....        | <a href="#">914</a> |
| Joint Materials .....             | <a href="#">914</a> |

Provide Grade P1 or Grade P1M for concrete pavement, miscellaneous concrete pavement, concrete overlay, and miscellaneous concrete overlay.



Provide Grade P1, Grade P1M, or Grade P2 for concrete base course, concrete shoulders, and temporary concrete pavement.

The Engineer may approve Grade P1M for other applications.

Where concrete shoulders are cast monolithically with concrete pavement, provide the grade required for the concrete pavement.

Provide curing compounds in accordance with the following:

- A. Transparent curing compound for base course concrete;
- B. White or transparent curing compound for temporary concrete pavement; and
- C. White curing compound for other pavement, shoulders, and curb surfaces.

Install epoxy coated lane ties or deformed bars in accordance with Standard Plan R-41 Series. For epoxy coated load transfer dowels delivered without the bond-breaking coating, submit written certification to the Engineer. Include the specification designation of the asphalt or equivalent material for the coating and certify that the material conforms to specification requirements.

### **602.03. Construction.**

**A. Equipment.** Provide and maintain equipment necessary to complete the work.

1. **Fixed Forms and Back-Up Rails.** If paving with fixed forms, use back-up rails attached to the forms to raise equipment wheel flanges clear of previously cast pavement.

Provide metal forms with section rigidity to support the paving.

Use flexible or standard steel forms with flexible liners where the radius of the curve is less than 150 feet, except where temporary concrete pavement is required.

2. **Compactor.** Use mechanical compactors for constructing aggregate base under the concrete pavement.
3. **Concrete Spreader.** Use a Department-approved device to spread and strike off each layer of concrete and to finish the top layer of concrete. Provide a spreader with a weight and rigidity to strike off the concrete to the required grade and profile.
4. **Dowel Bar Insertter (DBI).** The Engineer may allow the use of a DBI in lieu of load transfer assemblies. Use a Department-approved mechanical DBI that automatically installs load transfer bars at the required depth and consolidates the surrounding concrete.

5. **Lane-Tie Installer.** Use a Department-approved manual or mechanical method for installing lane-ties.
6. **Reinforcement Bridge.** For reinforcement not placed on chairs or mechanically lifted off the grade, transfer the reinforcement from the hauling equipment to a movable bridge that spans the newly cast pavement. Provide a bridge that can carry the reinforcement load without deflecting the form or rutting the track line.

7. **Internal Vibrator.** Use mechanical internal vibrators, set in accordance with the manufacturer's specifications, which provide concrete consolidation for a radius of 1 foot around the vibrator head.

Provide a device to monitor the rate of vibration for each concrete vibrator. Verify that all vibrators are operating properly, each day prior to paving and periodically during daily paving operations. Replace any defective vibrators immediately. Connect the vibrators to start automatically with the forward movement of the equipment and stop automatically when the forward movement stops. Space and operate vibrators as recommended by the manufacturer.

8. **Floating and Finishing Equipment.** Shape, screed, and float the concrete to form a dense, homogeneous pavement, requiring only minimum hand finishing.

Provide hand floats and 10-foot straightedges, rigid and free of warping. Provide handles with a length that will allow finishing half the width of the newly placed pavement. Provide box or channel hand floats with a floating face at least 6 inches wide.

The Contractor may use a roller screed or other manual or semi-automated finishing equipment for one lane-width pavements. The Engineer may approve the use of a roller screed for wider pavements if the Contractor demonstrates methods and equipment are in accordance with subsection [602.03.A.3](#) and subsection [602.03.A.6](#).

9. **Straightedges for Testing Surface Smoothness.** Provide two 5-foot straightedges and one 10-foot straightedge, rigid and free from warping, for the Engineer's use.
10. **Stencils.** Provide a template device for imprinting the pavement. Provide numerals that are 3 inches to 4 inches high and at least  $\frac{1}{4}$  inch deep.
11. **Foot Bridges.** Provide at least one moveable bridge for use in finishing the pavement, installing monument boxes, performing wet checks, and crossing the pavement. Foot bridges spanning slab

widths of at least 16 feet must be equipped with wheels, unless they are an integral part of the paving equipment. Design and construct foot bridges to prevent contact with the concrete.

12. **Membrane Sprayer.** Use mechanical equipment to apply curing compound to exposed pavement surfaces. Provide fully atomizing, self-contained spray equipment that is self-supported on wheels or tracks located outside the newly placed pavement. Provide continuous stirring of the compound during application. Apply a continuous uniform film of curing compound to exposed concrete surfaces.

The Engineer may approve hand spraying equipment for small and irregular shapes of new concrete pavement. Ensure the sprayer is capable of applying a uniform film of atomized curing compound at the required rate.

Inspect curing compound application equipment before starting daily production to ensure its ability to apply the curing compound, as required.

13. **Concrete Saws.** Use a concrete saw for the required application and as recommended by the manufacturer.
14. **Joint Sealing Equipment.** For hot-poured rubber-asphalt type joint sealing compound, provide an indirect or double-boiler heating kettle, using oil as the heat transfer medium. Provide a thermostatically controlled heat source, built-in automatic agitator, and thermometers to show the temperature of the melted sealing material and the oil bath. The Engineer may require a demonstration that the equipment will consistently produce a joint sealant of required pouring consistency.

Equip the kettle with a pressure pump, hose, and nozzle that can place the joint sealant to the full depth of the joint and completely fill the joint. Do not use direct flame heat on the nozzle.

- B. **Base Preparation.** Construct and maintain the base to the required line, grade, and cross section, in accordance with subsection [302.03](#) before pavement placement. Prepare the base and allow the Engineer to test and accept the base before setting forms or slip-form paving.

Ensure that the paving equipment will maintain the grade tolerance specified for the pavement. Shape and finish the base in accordance with subsection [302.03](#). If the prepared base is damaged by construction equipment, reconstruct the grade and cross section, as

directed by the Engineer, before placing the concrete, at no additional cost to the Department.

**C. Placing Forms.** Trim the compacted base close to the staked grade using base preparation equipment. Check the base for line and grade, and correct irregularities before placing the forms. Compact the base outside the area to be paved, to support the forms.

Set forms and provide time for the Engineer to check them before placing concrete. Provide uniform bearing of the forms directly on the base throughout their length and width. Securely join, lock, and stake each form segment. During paving, do not allow vertical movement to exceed  $\frac{1}{8}$  inch, and horizontal movement to exceed  $\frac{1}{4}$  inch. Brace flexible forms to prevent movement during concrete placement.

After the forms are set and cleaned of hardened concrete or mortar, the Engineer will check them. If requested by the Engineer, fabricate string lines for checking line and grade. Adjust form lines that vary from the staked line by more than  $\frac{1}{2}$  inch, or from the staked grade by more than  $\frac{1}{8}$  inch.

Treat the inside of all forms with a release agent that will not discolor or adversely affect the concrete. Do not allow the release agent to come in contact with steel reinforcement, lane ties, or existing concrete surfaces.

**D. Placing Concrete.** Set structure castings to grade and alignment before, or during, concrete placement. The Engineer will allow the boxing-out method for concrete base course and temporary concrete pavement. Clean structure castings to allow adhesion of the concrete.

Place concrete on a moist base. Do not place concrete on a frozen base, or an unstable base caused by excessive moisture.

Keep the top of the forms clean and free of concrete during placing and finishing.

Inspect vertical surfaces of previously placed concrete and the adjacent grade, and remove material that would prevent the adjoining concrete pour from consolidating or conforming to the plan dimensions. Before placing an adjoining pavement, inspect the open-graded base for contamination from fines or debris. If the Engineer determines that contamination requires removal or replacement, remove and replace at no additional cost to the Department.

Where pavement is constructed on a base that could sustain damage from hauling units, mechanically transfer the concrete from the hauling units to the grade. Provide transfer equipment that is self contained, and

self supported, with wheels or tracks located outside the base for the concrete pavement.

Spread and strike off the concrete as soon as it is deposited on the base. Avoid segregation. Consolidate the concrete along the faces of fixed or sliding forms and next to transverse dowel bar assemblies with internal vibrators.

Where using the slip form method, vibrate concrete for the full width and depth of the pavement. Where placing the concrete in two layers, the consolidation may occur after placing the top layer.

Continually monitor the operation of vibrators mounted on the paving machine. Do not commence with paving until the Engineer has documentation that vibrators are operating in accordance with the manufacturer's specifications. If a vibrator malfunctions during paving, discontinue paving operations and correct the malfunction. Resume paving when malfunctions are corrected and the Engineer approves.

Cease vibration and tamping when the paving equipment stops.

Provide labor, materials, and equipment to ensure continuity of the paving operation. The Engineer may stop production if there is not sufficient equipment or labor to keep pace with the other paving operations. Where placing the concrete in two layers, place the top layer of concrete within 30 minutes of placing the bottom layer. For unavoidable interruptions of concrete placement, for longer than 30 minutes, place a transverse, end-of-pour joint, Symbol H.

Operate equipment to prevent damage to pavements and bridge decks and to maintain the required grade in transitioning from the pavement to the deck.

Do not allow vehicles or equipment, other than joint saws or ride quality measurement equipment, on new pavement, or portions of new pavement, until the concrete reaches a strength in accordance with subsection [104.11](#).

Keep existing pavements clean of materials that may interfere with finishing operations or cause damage to the concrete surface.

Where placing slip form pavement in two layers, the first layer may be cast from 3 inches to 6 inches narrower, on each side, than the width of the proposed pavement slab. Ensure the gaps on each side are at least twice the largest dimension of the concrete aggregate. Cast full depth pavement at the edges with the second layer.

Finish concrete placed each day during daylight, unless required artificial light is provided. Provide artificial light at no additional cost to the Department.

To maintain cross-traffic, provide gaps in the concrete pavement or place temporary bridges or pavement crossings in accordance with section [812](#) and as approved by the Engineer.

**E. Placing Pavement Reinforcement.** Place the reinforcement from a reinforcement bridge, or by other Department-approved methods that will not contaminate the concrete. Place reinforcement that is free of loose rust and other contaminants.

**F. Constructing Joints.**

1. **Longitudinal Lane Tie Joints with Straight Tie Bars (Symbol D and Symbol S).** Place tie bars at the required depth, parallel to the finished surface, at right angles to the joint, and at the spacing shown on the plans. Install lane tie bars, except in temporary concrete pavement, using Department-approved chairs or mechanical devices. Do not place lane tie bars in the concrete by hand methods.

The Engineer will not require installation of lane tie bars and the sawing of joints for temporary concrete pavement, unless otherwise required by the contract.

Pull-out resistance testing is not required for Symbol S joints.

2. **Longitudinal Bulkhead Joints (Symbol B).** Install epoxy coated bent bars parallel to the surface of the pavement and at right angles to the edge of the pavement. Install the bent bars to allow consolidation around the bars without causing concrete slumping at the edges. Straighten bent tie bars after the concrete has gained required strength. Straighten tie bars to run parallel to the surface of the pavement and perpendicular to the edge of the pavement. Ensure the epoxy coating is not torn or loosened within 6 inches of the joint face. Repair tears or loosening of the epoxy coating within 6 inches of the joint face using the coating material recommended by the coating manufacturer.

Space and install lane ties to meet the pull-out resistance shown in Table 602-1. If the test results on the ties from the first day of placement meet the requirements of Table 602-1, the Engineer will determine the need for additional testing.

If the average pull-out resistance is less than the minimum requirements in Table 602-1, install additional epoxy-anchored lane

ties in accordance with Standard Plan R-41 Series, at no additional cost to the Department. Do not place adjacent pavement until the Engineer tests the additional lane ties.

The Engineer may waive verification tests for projects with less than 1,000 feet of longitudinal bulkhead joints.

| <b>Distance From Joint Being Constructed to Nearest Free Edge of Completed Pavement (a)</b>  | <b>Average Pull-out Resistance Per Foot of Joint (lb minimum) (b, c)</b> |
|--|--|
| ≤12 ft   | 2,200  |
| >12 ft – 16 ft   | 3,200  |
| >16 ft – 23 ft   | 4,500  |
| >23 ft – 27 ft   | 5,200  |
| >27 ft – 35 ft   | 6,800  |
| >35 ft   | —(d)   |
| a. Includes combinations of tied lane widths, valley gutter, curb and gutter, or concrete shoulder.<br>b. Slippage must not exceed 1/16 in.<br>c. Refer to Section D7 of the <a href="#">Materials Quality Assurance Manual</a> for inspection procedure<br>d. As directed by the Engineer |  |

3. **Transverse Joints.** Saw transverse contraction and expansion joints in accordance with subsection [602.03.N](#). Construct transverse plane-of-weakness joints in pavements without load transfer bars as shown on the plans.

Where placing pavement in partial-width slabs, place transverse joints in line with like joints in the adjacent slab. Where widening existing pavements, place transverse joints in line with like joints in the existing pavement and in line with "working" cracks that function as joints, if directed by the Engineer.

Provide load transfer assemblies manufactured in accordance with the Standard Plans. The Engineer will reject nonconforming load transfer assemblies. Stake the load transfer assemblies in place. Do not cut the shipping tie wires. Allow time for the Engineer to check the assemblies for condition, line, and grade before placing concrete. Permanently mark dowel bar locations on the vertical face of the plastic concrete pavement to accurately identify and locate joints for subsequent sawing.

For expansion joints, equip the free end of the bar with a close-fitting, Department-approved cap.

Where using more than one section of premolded joint filler in a joint, tightly butt the sections together. Place the bottom edge of the premolded filler in contact with the base and the top edge at the required depth below the surface of the pavement. Place the expansion joint filler perpendicular to the surface and the centerline of the pavement.

Construct an end-of-pour joint (Symbol H) if at least seven days will elapse between casting adjacent pours. If operations will resume before seven days, construct the joint at a contraction or expansion joint. Locate and form the joint by placing a bulkhead in the center of the load transfer device.

If using a Dowel Bar Inserter (DBI) to install load transfer bars, space the bars in accordance with Standard Plan R-40 Series for DBIs. Place and consolidate the pavement full-depth before inserting the dowel bars. Permanently mark dowel bar locations on the vertical face of the plastic concrete pavement for accurate identification and location of joints for subsequent sawing.

Insert dowel bars into the full-depth plastic concrete, and consolidate the concrete around the dowel bars, leaving no voids. Do not use hand-held vibrators. Align dowel bars in the vertical and horizontal planes to within  $\frac{1}{4}$  inch for the entire length of the bar. Center dowel bars longitudinally within a tolerance of  $\pm 2$  inches of the location of the transverse joint shown on the plans.

Verify the inserted dowels meet the required tolerances. The Engineer will witness these measurements. Provide documentation, if requested by the Engineer. Perform daily wet checks of the dowel bars as required by the concrete quality control plan. Mark and replace joints that are out of tolerance at no additional cost to the Department.

Locate the night header at the transverse joint location shown on the plans, or relocate if approved by the Engineer. Place a test joint beyond the night header. Saw the joint full-depth and remove for inspection of the dowel bar placement before restarting the concrete pavement operation. Install dowels in the night header by excavating into the plastic concrete or place them in drilled or preformed holes after removal of the test joint. If the Contractor uses a continuous paving operation that does not stop, the Engineer will establish the test joint location. The Engineer may waive the test joint requirements with documents showing three successive days of satisfactory performance.



**G. Screeding.** Screed and consolidate concrete pavement to achieve the final cross section shown on the plans. Use machine methods that avoid material segregation.

The Engineer may allow the use of manual methods for concrete pavement gaps less than 160 feet long and no greater than one lane width wide, or if the pavement is entirely concrete base course.

Do not use water to enhance finishing operations, unless otherwise directed by the Engineer. If the Engineer allows the use of water to enhance finishing operations, apply the water as a fog spray or fine mist.

**H. Finishing Surface.** Screed or extrude the finished surface to a smooth, sealed, and uniform appearance in accordance with the final cross section shown on the plans.

**I. Straightedge Testing, Surface Correction, and Edging.** While the concrete is still plastic, test the slab surface for compliance with the required grade and cross section using a 10-foot straightedge, or other method if approved by the Engineer.

If high or low spots exceed  $\frac{1}{8}$  inch over 10 feet, suspend paving operations and correct the finishing procedures. Correct high or low spots in pavements that exceed the tolerances and obtain the Engineer's approval before resuming paving operation.

The Engineer will evaluate high or low spots, in hardened concrete, that exceed  $\frac{1}{2}$  inch over 10 feet, or  $\frac{3}{4}$  inch over 50 feet in accordance with subsection [104.04](#).

Correct edge settlement that exceeds  $\frac{3}{8}$  inch before the concrete hardens. Suspend paving if edge settlement exceeding  $\frac{1}{4}$  inch continues for at least 10 feet, and make corrections before resuming paving.

Do not leave overhanging projections on pavement edges, except on temporary concrete pavement.

Ensure the final elevation of drainage structure castings in accordance with this subsection. The Engineer will evaluate drainage structures not meeting the requirements of this subsection in accordance with subsection [104.04](#).

**J. Ride Quality.** Provide ride quality as required by the contract.

**K. Texturing.** When the pavement sets and will maintain a texture, drag the surface longitudinally using one or two layers of Department-approved damp fabric material. Maintain contact between the fabric and the concrete surface across the entire width of newly placed concrete.

Immediately after dragging, groove pavement surfaces, other than concrete base courses and shoulders. Unless otherwise shown on the plans, use a track machine to orient the grooves parallel to the longitudinal joint. Prevent noticeable wander, overlap, or wave pattern in the grooves. Ensure the groove edges do not exhibit slumping or severe tearing of the concrete surface. Place grooves with a width and depth of  $\frac{1}{8}$  inch  $\pm 1/32$  inch, spaced  $\frac{3}{4}$  inch  $\pm 1/16$  inch on center. Do not texture the pavement surface within  $1\frac{1}{2}$  inches of longitudinal joints. Provide a mean texture depth from 0.04 inch to 0.10 inch, in accordance with ASTM E 965.

For areas requiring turf-drag texturing, produce the texture by longitudinally dragging a Department-approved artificial turf material to produce a uniform pattern parallel to the centerline. Maintain continual and uniform contact with the plastic concrete over the entire area being textured. Periodically clean turf material to maintain uniform texture. Provide a mean texture depth at least 0.03 inch, in accordance with ASTM E 965.

For miscellaneous pavement, the Engineer will allow use of a manual texturing device with a texture rake at least the same width as the plastic concrete pavement.

In areas where the contract requires transverse texturing, orient the grooves perpendicular to the centerline and form the grooves in the plastic concrete. Do not allow the grooves to slump at the edges or severely tear the surface. Provide a surface texture consisting of  $\frac{1}{8}$  inch wide grooves spaced  $\frac{1}{2}$  inch on center, and  $\frac{1}{8}$  inch to  $\frac{1}{4}$  inch deep.

Texture the plastic concrete before applying curing compound. If the Engineer determines that the texturing operations are delaying the application of the curing compound, stop the texturing operation, and complete the application of curing compound.

If texturing is not complete before placing curing compound or if the pavement is not textured as required, complete the surface texturing of the hardened concrete, at no additional cost to the Department, after the pavement achieves the minimum required class design strength. Correct pavement surfaces by grooving the hardened concrete. Submit a corrective action plan, including collection and disposal of the residue from retexturing, for the Engineer's approval.

**L. Stenciling Pavement.** After texturing, stencil survey station numbers into the pavement surface. Stencil station numbers 16 inches from the edge of the pavement. Place numbers perpendicular to the centerline of the roadway, legible from a vehicle traveling in the direction

of traffic. On two-way roads, stencil station numbers to read in the direction of stationing.

Stencil the month, day, and year into the concrete pavement at the beginning and end of each day's pavement operation, near the edge of the slab opposite the edge used for stationing. Place the date so it can be read if facing in the direction of pavement placement.

Do not stencil concrete base courses and temporary pavements.

Mark underdrain outlets in concrete shoulders, in accordance with subsection [404.03.F](#). Stencil the marker into the concrete surface, after texturing.

**M. Curing.** Curing operation will take precedence over texturing in accordance with subsection [602.03.K](#).

Cure the concrete as soon as the free water leaves the surface of the pavement. Coat and seal the pavement surface and sides of slip-formed pavement with a uniform layer of membrane curing compound.

Apply one coat of curing compound on non-grooved surfaces and two coats on grooved surfaces. Apply at least 1 gallon per 25 square yards of surface for each coat. Apply the second coat after the first coat dries, but do not allow more than 2 hours between coats.

Maintain a thoroughly mixed compound in accordance with the manufacturer's recommendation. Do not thin curing compound.

For miscellaneous concrete pavement more than one lane wide, apply the compound from a foot bridge, if using a manually operated pressure-type sprayer.

Immediately reapply curing compound to surfaces damaged by rain, joint sawing, Contractor foot traffic, or other activities.

If fixed-forms are removed within the 7 day curing period, coat the sides of the pavement with curing compound immediately after removing the forms.

If using cold-weather protection during the curing period, curing compound may be omitted, if approved by the Engineer.

Repair or replace concrete showing injury or damage due to inadequate curing, at no additional cost to the Department.

**N. Sawing Joints.** Saw joints as shown on the Standard Plans. The Engineer will allow the use of a concrete saw on the pavement to saw the joints. The Engineer will not allow the water supply truck on the new

pavement until the pavement has attained the strength specified in subsection [104.11](#).

Immediately stop sawing operation if sawing causes raveling or spalling, and continue to monitor the concrete hardness before resuming sawing operation.

1. **Longitudinal Joints.** Saw Symbol D longitudinal joints. Start sawing operation after the concrete pavement hardens but before random cracks develop in the concrete pavement.
2. **Transverse Contraction and Expansion Joints.** Construct the joint groove in expansion joints as shown on the Standard Plans. Flush loose concrete and slurry from the groove and the immediate area.

If the required seal is not installed within seven days of final sawing, temporarily seal the joint groove with a Department-approved material or device to prevent the infiltration of foreign material.

Install either the permanent seal or a temporary seal before allowing vehicles to travel over the full width joint grooves.

Saw joints in two stages, in accordance with the following:

- a. Place a relief cut directly over the center of the load transfer assembly or over the preformed joint filler. Make the relief cut after the concrete hardens and will not excessively ravel or spall, but before random cracks develop in the concrete pavement. Immediately stop sawing if sawing operation causes excessive raveling or spalling, and continue to monitor the concrete hardness before resuming sawing operations. Do not allow traffic over the expansion joint relief cuts.
- b. Center the joint groove over the relief cut. Adjust the groove width to compensate for change in the relief cut due to pavement contraction. Immediately stop sawing if sawing operation causes excessive raveling or spalling, and continue to monitor the concrete hardness before resuming sawing operations. Maintain the curing of the concrete near the joint, and if required, install the permanent joint sealant or place temporary cover material. Give second stage sawing of expansion joints priority over second stage contraction joint sawing, if higher pavement temperatures are forecast.

If proposing an alternative method for sawing, submit a plan to the Engineer for approval. The Engineer will not allow spalling, raveling, and random cracks in the concrete pavement.

Repair raveling or spalling in accordance with subsection [602.03.P](#). Remove and replace random cracked panels as directed by the Engineer.

The standard plans will specify the location of the transverse joint in the pavement, shoulder, curb and gutter, valley gutter, or base course; if the joint requires a load transfer assembly, expansion joint filler, or both; and the type of sealant or seal required.

**O. Coring Pavement.** The Department will core for thickness and steel location in accordance with subsection [602.04](#). The Engineer will allow coring of the pavement for information on the day following casting, but will not test information-only cores. Information cores are for the Contractor's information only.

Prevent damage to the pavement by using portable, lightweight equipment. Extract cores with diameters no greater than 4 inches. The Engineer will allow no more than six cores per mile (one per slab), to monitor pavement thickness and steel location. Extract cores, fill core holes with fresh concrete, consolidate, and finish on the same day.

Reapply the curing compound on the pavement to core-hole locations.

**P. Patching Transverse Joints.** After sawing and cleaning the joints, inspect for spalls and voids. Remove loose, unsound, or damaged concrete as directed by the Engineer. Repair joints in concrete base course and temporary concrete pavement for intermediate and major spalls.

1. **Minor Spalls.** Minor spalls or voids are less than 36 square inches (length multiplied by width beyond joint face), and exceed the following limits:

- a. Spalls that extend more than  $\frac{1}{4}$  inch from the joint face and over  $\frac{1}{2}$  inch below the surface of the pavement;
- b. Spalls that extend more than  $\frac{1}{4}$  inch from the joint face and are at least 2 inches long, regardless of the depth; or
- c. Void areas with a diameter greater than  $\frac{1}{2}$  inch, in the upper 1 inch of the joint face, or greater than 1-inch diameter in any location.

Repair minor spalls by patching with a Department-approved epoxy mortar before installing the seal.

Sandblast or power wire brush the spalled concrete surface. The Engineer may allow hand wire brushing for limited amounts of patching. Blow the patch clean with a jet of oil-free compressed air. Insert a rigid polyethylene sheet, or other rigid material covered with

polyethylene film, into the joint groove and hold tightly against the joint face being patched.

Ensure clean and dry concrete at the time of the epoxy mortar placement. For concrete surfaces 32 °F or less, heat the surface to remove frost. Use a clean source of heat, preventing carbon deposits on the concrete. Heat gradually and evenly.

Use Type I epoxy binder for temperatures from 60 °F to 104 °F and Type II epoxy binder for temperatures from 36 °F to 60 °F, in accordance with subsection [914.05](#).

Mix two parts epoxy resin to one part curing agent, by volume, or in accordance with the epoxy manufacturer's instruction. Unless using the entire contents of the original containers in one batch, use a mechanical volumetric dispensing device that dispenses each component with an accuracy within  $\pm 2$  percent by volume. Obtain the Engineer's approval of the dispenser.

Mix in a clean, metal or polyethylene vessel. Gradually add the curing agent to the epoxy resin, constantly stirring. Use a low-speed air or electrically driven mixer. Continue stirring for 2 minutes to 3 minutes to obtain a uniform mixture.

Mix the epoxy binder and retain a portion of the material for priming. Blend the dry masonry sand into the balance of the mixture, using 3½ parts dry sand, by volume, to 1 part mixed binder, to produce an epoxy mortar of stiff, but workable consistency.

Prime the spalled surface with the freshly mixed epoxy binder. Scrub the prime coat into the surface with a brush to ensure complete wetting and coverage of the spalled area. Immediately after priming, place the epoxy mortar in the spalled area and finish to the shape of the original pavement surface. If the initial bond coat loses tackiness, apply a second coat before placing the epoxy mortar. Form the edge of the patch to the adjacent joint groove. Sprinkle dry masonry sand onto the fresh epoxy mortar surface to eliminate gloss. Cure the epoxy mortar, and remove the polyethylene insert before sealing the joint.

2. **Intermediate Spalls.** Intermediate spalls are larger than 36 square inches and do not exceed either of the following:
  - a. Extend below the reinforcement in reinforced pavement; or
  - b. Greater than 4 inches deep in non-reinforced pavement.

Saw cut spalls parallel to the joint groove at the outer extremity of the spalled area. Cut at least 1 inch deep. Chip the concrete out to the

saw cut to form a vertical face at the back of the repair area. Cut the two ends of the repair area to form vertical faces. Sandblast the entire area to remove loose particles. Blow repair area clean with a jet of oil-free compressed air to remove the sand and other loose material. Flush the entire area with clean water. Remove excess water with oil-free compressed air. Insert a rigid polyethylene sheet, or other rigid material, covered with polyethylene film, into the joint groove and hold tightly against the joint face being patched.

Prime the bottom and vertical faces of the repair area with Type R-1 grout with a creamy consistency. Scrub the prime coat into the surface with a brush to ensure complete wetting and coverage of the repair area and prevent pooling in the rough surfaces of the repair area. Apply the prime coat immediately before placing the fresh mortar.

Use a Type R-2 mortar with a stiff consistency, tamp into the primed repair area, and finish flush with the pavement surface. Add a liquid air-entraining admixture to maintain an air content from 8 percent to 11 percent. Make the edge of the patch at the joint face conform to the rest of the joint groove. Spray white membrane curing compound on the patch surface immediately after the mortar is placed and finished. Remove the polyethylene form after 72 hours.

If a small number of intermediate spalls require patching, the Engineer may approve the epoxy primer and mortar system used for minor spalls in accordance with subsection [602.03.P.1](#), provided the repair areas are saw cut and chipped as specified by this subsection for intermediate spalls.

3. **Major Spalls.** Patch major spalls as directed by the Engineer. Major spalls are those that exceed either of the following:
  - a. Extend below the reinforcement in reinforced pavement; or
  - b. Are greater than 4 inches deep in non-reinforced pavement.

Q. **Repair of Longitudinal Joints and Edges.** Patch spalls that occur between adjacent lanes of concrete pavement in accordance with subsection [602.03.P.1](#).

Where a concrete pavement abuts an HMA surface, patch spalls that extend more than  $\frac{3}{4}$  inch from the joint face and more than  $\frac{3}{4}$  inch below the surface of the pavement. If the cumulative total of spall lengths exceeds 20 feet per mile of pavement joint, patch spalls less than  $\frac{3}{4}$  inch from the joint face and more than  $\frac{3}{4}$  inch below the surface of the pavement.

The Engineer will direct the repair of spalls greater than 36 square inches within 10 feet of longitudinal joint or edge. Remove and replace the pavement if directed by the Engineer, and at no additional cost to the Department.

**R. Cleaning Joints.** Clean joints, including the surface of the pavement next to the joint groove, with appropriate tools and equipment to remove slurry, stones, or other loose material.

Blast clean the faces of the joint that will contact the joint sealant, using a 1,500-psi to 3,000-psi water spray or a dry abrasive material. Allow joints to air-dry to the touch, with no visible signs of surface moisture, prior to placing joint sealant material.

Give joints a final cleaning with a jet of oil and water-free compressed air, with a pressure of at least 90 psi.

**S. Sealing Joints.** Seal longitudinal and transverse joints as shown on the plans.

The Engineer will not allow the use of artificial heat to dry joints before sealing.

Seal the joints immediately after cleaning. Ensure dry joint surfaces for sealing. Place sealant when the concrete temperature is at least 40 °F and rising without the use of artificial heat.

Melt sealant in a heating kettle; do not heat directly. Do not use sealants that are heated to more than the safe heating temperature recommended by the manufacturer.

Apply hot-poured joint sealant using a pressure applicator with a nozzle that extends into the groove. Remove sealant from the surface of the pavement. Before allowing traffic over the sealed joint, cure the sealant to resist pickup.

**T. Weather and Temperature Limitations.**

- 1. Protection Against Rain.** Protect the concrete pavement from damage by rain.
- 2. Protection from Cold Weather.** Protect the concrete pavement from freezing until it attains a compressive strength of at least 1,000 psi. Remove and replace concrete slabs damaged by cold weather, as directed by the Engineer, and at no additional cost to the Department.
- 3. Cold Weather Limitations.** Do not place concrete pavement until the ambient air temperature away from artificial heat is at least 25 °F



and rising, unless otherwise approved by the Engineer. Do not place concrete pavement if portions of the base, subbase, or subgrade layer are frozen, or if the grade exhibits poor stability from excessive moisture.

- 4. **Hot Weather Limitations.** Protect concrete pavement during hot weather as required by the concrete quality control plan. Protect the concrete pavement if the rate of evaporation is equal to or greater than 0.20 psf per hour, in accordance with Figure [706-1](#).

Provide equipment, approved by the Engineer, for determining the relative humidity and wind velocity at the concrete pavement site.

- 5. **Concrete Temperature Limitations.** At the time of concrete placement, ensure a concrete temperature from 45 °F to 90 °F.

**602.04. Measurement and Payment.**

| <b>Pay Item</b>                                       | <b>Pay Unit</b> |
|---|-----------------|
| Conc Pavt, Reinf, __ inch .....                       | Square Yard     |
| Conc Pavt, Nonreinf, __ inch .....                    | Square Yard     |
| Conc Pavt, Ovly, Furnishing and Placing .....         | Cubic Yard      |
| Conc Pavt, Ovly, Finishing and Curing .....           | Square Yard     |
| Conc Pavt with Integral Curb, Reinf, __ inch .....    | Square Yard     |
| Conc Pavt with Integral Curb, Nonreinf, __ inch ..... | Square Yard     |
| Conc Pavt, Misc, Reinf, __ inch .....                 | Square Yard     |
| Conc Pavt, Misc, Nonreinf, __ inch .....              | Square Yard     |
| Conc Pavt, Ovly, Misc, Furnishing and Placing .....   | Cubic Yard      |
| Conc Pavt, Ovly, Misc, Finishing and Curing .....     | Square Yard     |
| Conc Pavt, Reinf, __ inch, Temp .....                 | Square Yard     |
| Conc Pavt, Nonreinf, __ inch, Temp .....              | Square Yard     |
| Conc Base Cse, Reinf, __ inch .....                   | Square Yard     |
| Conc Base Cse, Nonreinf, __ inch .....                | Square Yard     |
| Shoulder, Reinf Conc .....                            | Square Yard     |
| Shoulder, Nonreinf Conc .....                         | Square Yard     |
| Shoulder, Freeway .....                               | Square Yard     |
| Joint, Contraction, (type) .....                      | Foot            |
| Joint, Expansion, (type) .....                        | Foot            |
| Joint, Plane-of-Weakness, (type) .....                | Foot            |
| Conc, Grade __ .....                                  | Cubic Yard      |
| Pavt Gapping .....                                    | Foot            |

- A. **Concrete Pavement and Base Course.** The Engineer will measure, and the Department will pay for concrete pavement and base course by area, based on plan quantities in accordance with subsection [109.01](#). The Department will establish pay items based on the type of

pavement installed, the pavement thickness required, and whether reinforcement is required.

The Engineer will measure concrete pavement with integral curb by area, including the curbs.

The Engineer will measure transition areas between concrete valley gutter and concrete curb and gutter, and concrete valley gutter cast integrally with concrete pavement at the apex of gore areas, by dividing the area in half and measuring each half using the units of adjacent pay items.

The unit prices for other pavement and base course pay items include the cost of concrete headers abutting bridges and track crossings constructed by thickening the pavement.

The unit prices for **Conc Pavt, Misc, Reinf** and **Conc Pavt, Misc, Nonreinf**, of the thicknesses required, include the cost of additional concrete additives if concrete pavement for pavement gapping requires additives to meet minimum opening-to-traffic strength requirements.

#### B. **Concrete Shoulder.**

1. **Shoulder, Reinforced Concrete and Shoulder, Non-reinforced Concrete.** The Engineer will measure, and the Department will pay for **Shoulder, Reinf Conc**, and **Shoulder, Nonreinf Conc** by area, based on plan quantities in accordance with subsection [109.01](#).
2. **Shoulder, Freeway.** The Engineer will measure and the Department will pay for **Shoulder, Freeway** based on plan quantities in accordance with subsection [109.01](#). If the Contractor uses concrete for the shoulder, the unit price for **Shoulder, Freeway** includes the cost of the transverse joints in the shoulder and the external longitudinal pavement joints.

#### C. **Concrete Overlay.**

1. **Concrete Pavement, Overlay Furnishing and Placing.** The Engineer will measure, and the Department will pay for **Conc Pavt, Ovly, Furnishing and Placing**, on concrete pavements and shoulders, including providing and placing the concrete mixture, by volume. The Engineer will determine the volume based on in place quantities.
2. **Concrete Pavement, Overlay Finishing and Curing.** The Engineer will measure **Conc Pavt, Ovly, Finishing and Curing** in place. The unit price for **Conc Pavt, Ovly, Finishing and Curing** includes the cost of finishing and curing concrete pavements and

shoulders, finishing and curing the concrete overlays, and constructing longitudinal joints.

The Engineer will measure and the Department will pay for constructing transverse joints, in accordance with subsection [602.04.E](#), and for repairing and removing the existing pavement, in accordance with subsection [603.04.B](#).

3. **Concrete Pavement, Overlay, Miscellaneous Furnishing and Placing and Concrete Pavement, Overlay, Miscellaneous Finishing and Curing.** The unit prices for **Conc Pavt, Ovly, Misc, Furnishing and Placing**, and **Conc Pavt, Ovly, Misc, Finishing and Curing** include the cost of reconstructing ramps, ramp overlays, gore areas, and approach areas. The Engineer will measure, and the Department will pay for **Conc Pavt, Ovly, Misc, Furnishing and Placing** in accordance with subsection [602.04.C.1](#), and **Conc Pavt, Ovly, Misc, Finishing and Curing**, in accordance with subsection [602.04.C.2](#).

If the Engineer approves a substitution of a higher concrete grade for a lesser grade (e.g., P1 for P2), the Department will pay for the higher grade of concrete using the original bid and pay items.

- D. **Pavement Gapping or Bridging.** The Engineer will measure **Pavt Gapping** by the length parallel to the centerline of the project from the beginning of concrete to the end of concrete, within the gapped section. The Engineer will measure each individual lane of gapped concrete pavement separately. The unit price for **Pavt Gapping** includes the cost of interrupting paving operations, moving back to pave the gap, and maintaining cross traffic.

The unit prices for other pay items include the cost of gapping curbs, curb and gutter, gutters, driveways, and sidewalks.

- E. **Joints.** The unit prices for other pay items include the cost of transverse end-of-pour joints (Symbol H) and transverse plane-of-weakness joints (Symbol U). The Department will pay for other transverse joints by the length, based on plan dimensions, for the type of joint required.

The unit price for the transverse contraction, expansion, and plane-of-weakness joints include the cost of the following:

1. Providing required joint materials such as load transfer assemblies, expansion joint fillers, and joint seals or sealants;
2. Sawing, forming, and cleaning the joints;
3. Providing and applying bond breaker if required; and

#### 4. Providing and placing poured joint sealant.

The Engineer will measure and the Department will pay for expansion or contraction joints for concrete shoulders, shown on the plans, based on plan dimensions.

The unit prices for other pay items include the cost of internal and external longitudinal joints.

**F. Concrete Accelerators.** If the Engineer approves the use of concrete accelerator as extra work, the Department will pay the invoice cost plus 15 percent.

**G. Price Adjustment for Pavement, Shoulder, and Base Course Based on Thickness and Depth of Reinforcement.** The Engineer will core the concrete pavement before final acceptance to determine the thickness of the concrete pavement, and if required, the depth of reinforcement below the pavement surface. The Engineer will only measure the top layer of steel for depth of concrete cover for concrete pavements with two layers of required reinforcement.

The Engineer will not core the following:

1. Temporary concrete pavement,
2. Pavement within 4 feet of an obstruction,
3. Pavement areas less than 300 square yards, or
4. Pavement less than 3 feet wide.

The Engineer will determine concrete pavement units, core locations, and evaluate cores in accordance with [MTM 201](#).

The Department will adjust the contract unit price for areas of concrete pavement where thicknesses or reinforcement locations exceed required tolerances.

Use Table [602-2](#) to classify cores and determine price adjustments according to concrete pavement thickness. Use either Table [602-3A](#), or Table [602-3B](#) to classify cores and determine price adjustments according to steel depth. The Department will apply these adjustments cumulatively to the evaluated pavement unit.

1. **Initial Core.** The Engineer will classify each initial core with a one or two letter core-type code. The first letter (A, B or C) represents the thickness classification in accordance with Table [602-2](#) and the second letter (X, Y or Z), represents the steel depth classification in accordance with Table [602-3A](#).

If the Engineer classifies an initial core from a concrete pavement unit as Type AX, indicating both thickness and steel depth are within

required tolerances, the Department will not apply an adjustment and the Engineer will take no additional cores.

2. **Additional Cores.** If the Engineer does not classify an initial core from a concrete pavement unit as Type AX, the Engineer will take additional cores. The Department will only consider the dimensions not within the A or X range, for adjustment based on subsequent cores. The Engineer will decide whether to accept the work, make a price adjustment of up to 100 percent, or direct the Contractor to remove and replace concrete pavement, based on the initial and additional cores.
3. **Price Adjustment for Thickness.**

- a. **Initial Core Type A.** The Department considers a Core Type A to have a thickness within the required tolerances. The Engineer will not take additional cores to measure thickness, and the Department will not apply a price adjustment to the concrete pavement unit.
- b. **Initial Core Type B.** The Department considers a Core Type B to deviate from the design thickness as shown in Table [602-2](#). The Engineer will take two additional cores and measure the thickness.

The Engineer will calculate the average thickness for the concrete pavement unit. In determining the average thickness, the Engineer will record measurements of individual cores that exceed the required pavement thickness by more than  $\frac{1}{4}$  inch as the required thickness plus  $\frac{1}{4}$  inch.

The Department will determine the unit price adjustment using the average thickness rounded to the nearest 0.1 inch, and Table [602-2](#).

- c. **Initial Core Type C.** The Department considers a Core Type C to deviate from the design thickness by more than 1.1 inches.

The Engineer will take straddler cores to determine the area of deficiency.

The Engineer will establish a new initial core for the concrete pavement unit, excluding the deficient area, and repeat the evaluation and calculation for the concrete pavement thickness.

Remove and replace deficient areas in accordance with subsection [602.04.G.5](#).

4. **Price Adjustments for Steel Locations Within the Pavement Structure.** The Department will consider two variables when considering price adjustments for steel depth — the steel location relative to the pavement surface and the deviation of the steel location from the allowable depth range. The Department will determine both and apply only the larger of the two deviations from the requirements in Table [602-3A](#) and Table [602-3B](#).
- a. **Initial Core Type X.** The Department considers a Core Type X to have reinforcement placed within the required tolerances for depth from surface of pavement. The Engineer will not take additional cores, and the Department will not make a price adjustment to the concrete pavement unit for reinforcement placement.
- b. **Initial Core Type Y.** The Department considers Core Type Y to contain reinforcement that deviates from the design depth. The Engineer will take two additional cores and measure the depth of steel from concrete pavement surface for each core.

The Engineer will calculate the average reinforcement depth.

The Engineer will use the average reinforcement depth and Table [602-3A](#) to determine the price adjustment based on the location of the steel from the concrete pavement surface.

The Engineer will calculate the absolute deviation from the limits of the design depth range for each core, and the average absolute deviation from the required depth range.

The Engineer will use the average absolute deviation and Table [602-3B](#) to determine the contract price adjustment based on deviation from required depth of steel range.

- c. **Initial Core Type Z.** The Department considers Core Type Z to contain reinforcement that deviates from the design depth by more than the required tolerance.

The Engineer will take straddler cores to determine the area of deficiency.

The Engineer will establish a new initial core for the concrete pavement unit, excluding the deficient area, and repeat the evaluation and calculation of depth of steel.

Remove and replace the deficient area in accordance with subsection [602.04.G.5](#).

5. **Remove and Replace.** If an initial core falls into either the Core Type C or Core Type Z category, the Engineer will delineate the deficient area by taking straddler cores at 5-foot intervals, longitudinally, in both directions from the initial core. The Department will consider defective areas separately from the remainder of the concrete pavement unit. The Contractor will remove and replace Core Type C and Core Type Z areas as directed by the Engineer. The Contractor will remove an area of pavement at least 10 feet long, for the full panel width. If the area designated for removal is within 15 feet of a transverse joint, the Contractor will remove the defective concrete pavement area to the joint. The Engineer will core and evaluate the replaced areas in accordance with subsection [602.04.G](#). If the concrete pavement is within the tolerances specified in Table 602-2, Table 602-3A, and Table 602-3B, the Department will pay for the replaced concrete pavement at the contract unit price.

| <b>Initial Core Type</b>  | <b>Deficiency in Thickness (in)</b> | <b>Price Adjustment (%)</b> |
|---|-------------------------------------|-----------------------------|
| A   | ≤0.2                                | 0                           |
| B   | 0.3                                 | -5                          |
| B   | 0.4                                 | -15                         |
| B   | 0.5                                 | -25                         |
| B   | 0.6 – 1.0                           | -50                         |
| C   | ≥1.1                                | -100 (a)                    |
| a. Corrective action up to and including remove and replace pavement. |                                     |                             |

| <b>Table 602-3A<br/>Price Adjustment for Depth of Steel from Pavement Surface<br/>Tolerance on Depth of Reinforcement for Uniform Plan Thickness</b> |  |                    |                      |                 |                                 |
|--|--|--------------------|----------------------|-----------------|---------------------------------|
| <b>Core Type</b>   | <b>Tolerance on Depth of Reinforcement for Uniform Plan Thickness<br/>(in) (a, b, c)</b> |                    |                      |                 | <b>Price Adjustment<br/>(%)</b> |
|  | <b>7.75 – 8.50</b>   | <b>8.75 – 9.50</b> | <b>10.75 – 11.50</b> | <b>Shoulder</b> |                                 |
| Z  | 0.0 – 0.9  | 0.0 – 0.9          | 0.0 – 0.9            | 0.0 – 0.9       | -100 (e)                        |
| Y  | 1.0 – 1.9  | 1.0 – 1.9          | 1.0 – 2.4            | 1.0 – 2.4       | -25 (e)                         |
| X (d)  | 2.0 – 4.0  | 2.0 – 4.5          | 2.5 – 5.5            | 2.0 – 4.0       | 0                               |
| Y (d)  | 4.1 – 4.8  | 4.6 – 5.4          | 5.1 – 6.0            | 4.1 – 5.0       | -25                             |
| Y (d)  | 4.9 – 6.4  | 5.5 – 7.2          | 6.1 – 8.0            | 6.7 – 8.8       | -50                             |
| Z (d)  | ≥6.5   | ≥7.3               | ≥8.1                 | ≥8.9            | -100 (e)                        |

a. If the contract requires a pavement reinforced with two layers of reinforcement, the Engineer will only measure the depth of the top layer of steel.

b. To determine pavement thicknesses, use the same depth range as the pavement the shoulder is tied to. Use the average shoulder thickness, if tapered.

c. Pavement or base course.

d. If a core length measures at least 0.2 in over the plan thickness, increase the maximum depth range by one-half the excess core length over the plan thickness, round to the nearest 0.1 in, in accordance with ASTM E 29, and then add it to the range shown.

e. Corrective action up to and including removing and replacing pavement.



**Table 602-3B**  
**Price Adjustment for Deviation of Depth of Steel from Design Range Initial**  
**Allowable Average Absolute Deviation from Design Depth of Reinforcement**  
**per Uniform Plan Thickness**  
**(in) (a, b, c)**

| Core Type    | Allowable Average Absolute Deviation from Design Depth of Reinforcement<br>(in) (a, b, c) |            |            |             | Price Adjustment<br>(%) |
|--------------|---|------------|------------|-------------|-------------------------|
|              | 6.5 – 7.5   | 7.75 – 8.5 | 8.75 – 9.5 | 9.75 – 10.5 |                         |
| X (d)        | 0.0 – 0.5   | 0.0 – 0.5  | 0.0 – 0.5  | 0.0 – 0.5   | 0                       |
| Y (d)        | 0.5 – 1.0   | 0.5 – 1.0  | 0.5 – 1.0  | 0.5 – 1.0   | -10                     |
| Y (d)        | ≥1.0  | ≥1.0       | ≥1.0       | ≥1.0        | -25                     |
| Design Range | 2.0 – 4.0   | 2.0 – 4.0  | 2.0 – 4.5  | 2.5 – 5.5   | 2.5 – 6.0               |

a. If the contract requires a pavement reinforced with two layers of reinforcement, the Engineer will only measure the depth of the top layer of steel.

b. To determine pavement thicknesses, use the same depth range as the pavement the shoulder is tied to. Use the average shoulder thickness, if tapered.

c. Pavement or base course.

d. If a core length measures at least 0.2 in over the plan thickness, increase the maximum depth range by ½ the excess core length over the plan thickness, round to the nearest 0.1 in, in accordance with ASTM E 29, and then add it to the range shown.

## Section 603. CONCRETE PAVEMENT RESTORATION

**603.01. Description.** This work consists of restoring concrete pavement including the following:

- A. Removing and repairing portions of a concrete pavement, one lane wide and 100 feet long, or less, with reinforced and non-reinforced portland cement concrete, with the type of joint required;
- B. Diamond grinding portland cement concrete pavement;
- C. Resawing and sealing existing longitudinal pavement joints;
- D. Sawing, cleaning, and sealing cracks in concrete pavements;
- E. Removing sections of concrete pavement, one lane wide and greater than 100 feet long in accordance with section [204](#) or subsection [603.03.B.1](#), as determined by the Engineer; and
- F. Replacing sections of concrete pavement one lane wide and greater than 100 feet long in accordance with section [602](#).

Refer to Standard Plan R-44 Series, R-45 Series and the contract for details.

**603.02. Materials.** Provide material in accordance with the following:

|   |                     |
|---|---------------------|
| Concrete, Grades, P1, P1M .....                     | <a href="#">601</a> |
| Concrete, Grades P-MS, P-NC .....                   | <a href="#">603</a> |
| Course Aggregate, 21AA, 22A .....                   | <a href="#">902</a> |
| Curing Materials for Pavements .....                | <a href="#">903</a> |
| Insulating Blankets .....                           | <a href="#">903</a> |
| HMA Mixtures for Restoring Shoulders .....          | <a href="#">904</a> |
| Steel Reinforcement .....                           | <a href="#">905</a> |
| Epoxy Coated Dowel Bars and Deformed Tie Bars ..... | <a href="#">914</a> |
| Joint Materials .....                               | <a href="#">914</a> |

For concrete pavement repairs, the Engineer will determine the required concrete grade, based on the required opening of repairs to traffic, in accordance with Table 603-1. The Engineer will not require 28-day compressive strength test cylinders for concrete pavement repairs.

| From Casting to Scheduled<br>Opening | Concrete Grade | Minimum Flexural<br>Strength |
|--------------------------------------|----------------|------------------------------|
| <72 hours                            | Grade P-NC     | 300 psi                      |
| ≥3 days                              | Grade P1, P1M  | 550 psi                      |

Provide the cement and admixture combinations necessary to obtain the strength specified in Table 603-1 in the required time period. Do not use

a calcium chloride admixture. Provide coarse aggregate with no greater than 2.5 percent absorption in accordance with ASTM C 127.

The Engineer will proportion Grade P-NC mixtures. Provide the mixture as ready-mixed concrete, with the required consistency, to the project.

Use Grade P-NC concrete patching mixture containing 658 pounds per cubic yard (7 sacks) of cement when the forecasted air temperature is above 59 °F. Use 752 pounds per cubic yard (8 sacks) of concrete when the forecasted air temperature is 59 °F or less.

The Contractor may provide a non-chloride, Type C, or Type E, set accelerating admixture, from the Qualified Products List, with the required cement content to achieve the flexural strength of 300 psi by the required opening-to-traffic time.

### **603.03. Construction.**

**A. Equipment Requirements.** Provide equipment necessary to perform the work in accordance with section [602](#) and the following:

1. **Drilling Machine.** Provide a drilling machine and use methods to drill holes in the existing pavement vertical surfaces in accordance with the following:
  - a. Drill the holes to the required diameter and depth ( $\pm\frac{1}{2}$  inch) midway between the top and bottom surfaces of the concrete pavement.
  - b. Drill holes parallel to the pavement surface and parallel to the longitudinal joint within a tolerance of  $\pm\frac{1}{8}$  inch.
  - c. When positioned against the face of the existing pavement, drill holes parallel to the longitudinal joint.
  - d. Support the drill on rails that rest on the pavement surface at both ends of an 8 foot long repair, or by other alignment methods approved by the Engineer, to ensure holes meet the requirements of subsection [603.03.A.1.b](#).
  - e. Provide a drill that uses mechanically applied pressure for forward and reverse travel. Match the drill and pressure mechanism to drill the nominal depth holes to prevent cracking the concrete and causing spalls more than  $\frac{1}{2}$  inch horizontally or vertically.
  - f. Equip the drill with a snug fitting drill guide bushing, positioned against the face of the concrete to prevent eccentricity or overriding of the holes more than  $\frac{1}{16}$  inch, and to maintain the alignment tolerances.
  - g. Space bars in accordance with Standard Plan R-44 Series.

- h. Drill dowel bar holes and deformed tie bar holes for transverse joints with a diameter of 1 $\frac{3}{8}$  inch, and 9 inches  $\pm\frac{3}{8}$  inch deep.
- i. Drill deformed lane tie bar holes for longitudinal joints with a diameter of  $\frac{3}{4}$  inch and 7 inches  $\pm\frac{3}{8}$  inch deep.

## 2. Grout Dispenser.

- a. **Bulk Grout Systems.** For bulk grouting, provide a grout dispenser and static mixing nozzle system recommended by the grout material manufacturer. Use a machine that proportions the components, mixes the components as they are extruded through the static nozzle, and deposits the mixed material in the back of the hole.

If using a bulk grout system, provide two bulk grout dispensers on the project or provide one bulk grout dispenser and a two-day supply of prepackaged grout material, dispensers, and static mixing nozzles.

- b. **Prepackaged Injection Grout Systems.** For prepackaged injection grouting, provide a grout dispenser and static mixing nozzle supplied by the manufacturer of the grout material. Use a static mixing nozzle capable of depositing grout to the back of the hole.

- 3. **Vibratory or Roller Screeds.** Provide a steel-shod vibratory screed, with the weight and vibrating frequency required to screed concrete flush with the existing pavement in a single pass.

Provide a roller screed with the weight and speed required to screed the concrete surface flush with the existing pavement in two or more passes.

Provide screeds at least 6 inches longer than the width of the concrete pavement repair.

- 4. **Diamond Grinding Equipment.** Provide diamond blades, spaced as required for the application, and mounted on a self-propelled machine designed for grinding and texturing pavement. Use equipment that will not cause damage to the underlying surface of the pavement. Do not use grinding equipment that ravels or spalls the concrete pavement, fractures aggregate, or damages the transverse or longitudinal joints. Provide grinding equipment that produces the required texture. To remove residue and excess water, provide vacuum equipment that extracts the slurry material from the pavement and prevents dust from escaping into the air.

5. **Equipment for Sawing and Sealing Cracks.** Provide equipment for sawing and sealing cracks in accordance with subsection [602.03.A.13](#). Equip the saw with a diamond blade with a diameter of 8 inches or less.

B. **Construction of Concrete Pavement Repair.** Construct concrete pavement repairs, 50 feet long, or less, in accordance with section [602](#), except as modified by this subsection.

To make repairs, remove existing concrete pavement in sections at least 4 feet long. If the repair area is less than 4 feet from an existing joint, remove the existing concrete pavement to at least one foot beyond the joint. If the repair area is less than 8 feet from the next repair area, remove the concrete pavement between the two areas.

For repairs greater than 15 feet long, control the grade by separately casting adjacent lanes, ramps, or shoulders in the repair area.

For repairs greater than 50 feet long, establish and control grades in accordance with subsection [602.03](#).

If the lane adjacent to a repair area is damaged, cast the repair area and open to traffic, then perform the removal and recasting of concrete repairs in the adjacent lane. The Engineer must approve the adjacent lane repair.

1. **Removing Existing Pavement (Concrete Pavement Repair).**

a. **Removing and Repairing Pavement Damaged by the Contractor.** The Engineer will not allow the use of removal equipment that damages the concrete pavement required to remain in place. If the plans do not show the disturbance of the base, complete the work in accordance with this subsection. Repair remaining concrete pavement, damaged during removal operations, at no additional cost to the Department.

Saw cut, remove, dispose, and provide additional concrete to repair spalls at no additional cost to the Department. Fill isolated spalls, less than 10 square inches, with a hot-poured joint sealant. Repair the following in accordance with subsection [602.03.P.2](#):

- i. Isolated spalls, at least 10 square inches;
- ii. Numerous spalls in the same joint area; and
- iii. Intermediate spalls.

Repair major spalls in accordance with subsection [602.03.P.3](#) by re-sawing. Place the new saw cuts in line with, or at least 2 feet from, saw cuts in adjacent lane repair areas.

- b. **Planned Pavement Removal and Repair.** Remove part-depth or full-depth hot mix asphalt (HMA) patches, included in the portion of pavement being removed, as removal of concrete, without regard to additional effort that may be involved in the removal of dissimilar materials. Avoid disturbing the base during removal.

If the plans show repair areas that include concrete shoulders, perform shoulder removal using the same method as concrete pavement removal.

If the repair areas include repairing concrete curb, curb and gutter, or valley gutter, remove the curbing adjacent to the repair and in line with the joints of the repair. If curbing removal leaves a section length, less than 6 feet from the saw cut to the nearest existing curb joint, remove the concrete curb to the existing joint. Construct the curb joint at the existing joint. Do not extend the joint created by the concrete pavement repair into the curb.

Do not begin sawing more than two weeks before concrete pavement removal. Saw the concrete full depth using multiple passes within the same 12-hour period, or in one pass. Make straight, transverse saw cuts, at right angles to the centerline of the concrete pavement, within a tolerance of  $\pm 1$  inch per lane width. Saw the longitudinal joint full depth between adjacent lanes, ramps, shoulders, or curb and gutter. Use water, immediately after sawing, to flush slurry off the surface of the pavement.

Place concrete repairs the same day as the removal of existing concrete pavement. Remove concrete pavement between narrowly spaced saw cuts at the end of a slab with air hammers and hand tools. Except for utility cuts, install lifting devices in the slab. Lift the slab without disturbing the base. Clean the area with hand tools. Remove slurry from sawed surfaces.

2. **Installing Dowels or Deformed Tie Bars in Transverse Joints.** Drill the faces of the existing concrete pavement to allow the insertion of dowel bars or deformed tie bars. Re-drill holes that do not meet the required depth, diameter, and alignment at no additional cost to the Department.

After drilling the holes, clean with a blast of oil-free compressed air with at least 90 psi. Fully insert the air wand into the holes.

After cleaning the holes, fill with a grout selected from the Qualified Products List. Fill the holes with grout to their full length to ensure the grout covers the embedded length of the inserted dowel bars or deformed bars. Slowly insert the bars into the holes using hand pressure and a twisting motion, until fully seated. Wipe excess grout, extruded around the bars onto the face of the concrete, using a metal trowel. Do not proceed until the Engineer verifies the dowel bars are properly installed and the grout set.

For expansion joints (Erg), drill or punch the fiber filler to match the location of the holes in the existing pavement. Drill or punch the holes in the fiber filler to produce neat, clean holes without excessively tearing the filler. After grouting the dowel bars in place, install the filler and position it against the existing pavement. Extend the fiber filler the full depth of the repair and install flush with the existing pavement surface. Ensure fiber filler fully contacts, and covers the entire vertical surface of the sawed joint face. Place fiber filler in one continuous length across the joint, except for pavements wider than the nominal lane width, the Engineer will allow a short piece of filler.

Coat the portions of dowel bars that extend beyond the face of the existing pavement or the fiber filler with an approved bond-breaking coating. Do not coat deformed bars used with tied joints (Trg) or grouted-in-place lane ties with bond-breaking coating.

Install an approved expansion cap on the end of each dowel bar for expansion joints (Erg), after applying the bond breaker.

3. **Site Preparation.** If the plans show base corrections, excavate and backfill in accordance with section [205](#) and section [302](#). If the existing base is greater than 2 inches lower than the required grade, and the condition existed before concrete removal, correct the low base by adding base course aggregate and compacting to the required density and elevation. If the existing base is 2 inches or less below the required grade, or lower than the required grade as the result of concrete pavement removal operations, fill the area with concrete during repair construction.

Set forms to the line and grade shown on the plans. Use one-piece forms for repairs 10 feet or less. For repairs greater than 10 feet, use forms that lock together or splice sections to provide a continuous form. Provide metal or wood forms. If using wood forms,

provide 2-inch thick lumber for shoulder side forms and 1-inch thick lumber for side forms between lanes.

Position and support reinforcement in accordance with the standard plans.

4. **Longitudinal Joints.** If casting more than one lane in a single pour, construct longitudinal joints in line with the existing longitudinal joints. Make the depth of the longitudinal joint  $\frac{1}{3}$  the thickness of the pavement. Construct longitudinal joints by sawing before opening to traffic or by forming. Do not construct an external longitudinal joint between concrete pavement repairs and concrete curbing or shoulders.

Install lane ties in accordance with Standard Plan R-44 Series. Construct grouted-in-place lane ties in accordance with subsection [603.03.B.2](#), for deformed bars used with tied joints (Trg), except the Engineer will allow the use of handheld drills.

5. **Transverse Joints.** If the contract requires an existing curb left in place, and there is an expansion space in the adjacent lane repair, saw or chip an expansion joint (Esc) in the curb. Construct the joint in line with and equal width to the expansion joint in the adjacent lane repair. Shape the fiber joint filler to match the curb cross section.
6. **Placing Concrete.** Immediately before concrete placement, wet the faces of the existing pavement and the surface of the aggregate base with water.

Cast each repair in one continuous full-depth operation. Consolidate the concrete using a hand-held immersion-type vibrator, approved by the Engineer. Consolidate the concrete around dowel bars, deformed tie bars, and deformed lane tie bars.

7. **Finishing Concrete.** Strike off the surface flush with the existing pavement surface at least twice with a vibratory or roller screed. Do not float in lieu of striking off. For repairs 15 feet long or less, place the screed parallel to the centerline of the roadway. For repairs greater than 15 feet long, place the screed perpendicular to the centerline.

While the concrete is still plastic, check that the edges of the repair surface are flush with the edges of the existing concrete pavement, and test to ensure the repaired surface meets the required line and grade. Use a straightedge in accordance with this subsection.



For repairs 10 feet long or less, place the straightedge parallel to the pavement centerline with the ends resting on the existing pavement and draw the straightedge across the repair. For repairs 10 feet long, or less, use a straightedge no greater than 6 inches longer than the repair. Ensure the straightedge remains in contact with the existing pavement while drawing it across the repair. Correct high or low spots greater than  $\frac{1}{8}$  inch, recheck the surface after making corrections, and eliminate irregularities.

For repairs greater than 10 feet long, straightedge in accordance with subsection [602.03.I](#). Make the first and the last measurement with half the straightedge resting on the existing pavement. Make the second and the next to last measurement with 2 inches to 3 inches of the straightedge resting on the existing pavement. Correct high or low spots greater than  $\frac{1}{8}$  inch.

Before texturing, run an edger with a  $\frac{1}{8}$ -inch to  $\frac{1}{4}$ -inch radius along the perimeter of the repair. Remove temporary forms after the concrete attains the strength required to prevent sagging or spalling upon removal of the forms.

8. **Texturing.** Texture the surface of the repair to match texturing on the adjacent concrete pavement.
9. **Stenciling.** Stencil the month and the year in each repair in accordance with subsection [602.03.L](#). If repair operations cause the removal of the existing stationing, stencil the station in the repair at the required location.
10. **Curing.** Apply curing compound immediately after free water evaporates from the concrete pavement surface. Do not delay curing compound application for other work during concrete pavement placing and finishing operations. Continuously apply curing compound.

Use white membrane curing compound, unless the repair requires a bituminous overlay. For repairs requiring bituminous overlay, use transparent curing compound. Apply the required curing compound in two coats, at a rate of at least 1 gallon per 25 cubic yards for each coat.

Stop concrete pavement placement if the curing compound application process fails to meet the requirements specified in this subsection. Maintain the placed and finished concrete in a continuously moist condition until membrane curing compound application. Fog mist the pavement without damaging the concrete pavement surface.

Reapply curing compound immediately to surfaces damaged by rain, joint sawing, Contractor foot traffic, or other activities.

Place insulated blankets to meet open-to-traffic requirements and protect the concrete pavement from weather damage. Provide insulated blankets at least 2 inch thick. When the air temperature falls below 50 °F during the curing period, place blankets over the repaired area, as soon as the curing compound dries. Secure edges and seams in the blanket to prevent heat loss. Protect the concrete until it attains the minimum flexural strength specified in subsection [603.02](#).

Conform to methods included in the concrete quality control plan, the method for achieving the open-to-traffic strength within the required time period.

The Contractor may use the maturity method to determine the in-place, opening-to-traffic flexural strength, if the Contractor makes the necessary preliminary flexural strength versus opening-to-traffic time correlations before placing the concrete.

Cure test beams for open-to-traffic strengths the same as the repair.

11. **Cleaning Joints.** Before blast cleaning, remove concrete from the top of the filler in the expansion joint. Immediately before sealing joints, blast clean, except tied joint (Trg), and clean with a jet of compressed-air, free of oil and water, with at least 90 psi. Place a silicone coated, paper bond breaker tape, with pressure sensitive adhesive on one side, in the bottom of the contraction joint (Crg) groove after the final cleaning and before sealing.
12. **Sawing and Sealing Joints.** Do not construct reservoirs for seals in the following joints that do not require sealing:
  - a. Longitudinal bulkhead joints;
  - b. Joints in base course repairs;
  - c. Joints in repairs constructed in preparation for HMA overlays;  
and
  - d. Reinforced grouted tied joints.

For all other joints and saw cuts in concrete pavements, shoulders, or gutters, caused by overcutting, clean and seal using hot-poured joint sealant.

Before sealing joints with fiber filler, remove the joint fiber filler at the concrete pavement surface by sawing 1 inch wide and 1½ inches deep.

Saw joint grooves for the contraction joints (Crg) as required by the contract.

Saw joint grooves for C2 joints and E2 joints after the concrete pavement attains the strength required to prevent excess raveling or spalling, but before random cracks develop. The Engineer will not allow forming of joint grooves. Saw the initial relief cut and extend the groove to the plan width and depth in accordance with subsection [602.03.N](#), or initially saw to the width and depth shown on the plans.

13. **Resealing Transverse and Longitudinal Pavement Joints.** After completion of concrete pavement repairs, spall repairs, and pavement texturing, seal transverse and longitudinal concrete pavement joints with hot-poured sealant in accordance with subsection [602.03.S](#). Resaw the transverse and longitudinal joints over the existing joint groove to produce a finished joint with two freshly sawed faces. Immediately after sawing, flush the joint groove with water to remove the slurry and debris. After final cleaning of the joints, insert a backer rod into the joint, creating a 1:1 width to depth ratio for hot-poured sealant. Seal the joint groove to no greater than  $\frac{1}{8}$  inch (after cooling) below the concrete pavement surface.
14. **HMA Shoulder Replacement.** Before opening to traffic, restore HMA shoulders to the existing line and grade using a plant-mixed HMA, as directed by the Engineer. Replace cold patch mixtures for temporary patching with plant-mixed HMA, unless the plans show shoulder reconstruction as part of the project. Compact the HMA using mechanical or hand methods required for the size of the repair area. Fill the voids and compact flush with the surrounding shoulder. Place HMA at the required compaction temperatures.  
  
Properly dispose of materials removed from the shoulder.
15. **Opening to Traffic.** Ensure the concrete pavement attains the required minimum flexural strength, and ensure joints are sawed in accordance with subsection [603.03.B.12](#) before opening to traffic. The Engineer will allow traffic over the repair before the Contractor cleans and seals the joints.

C. **Diamond Grinding Concrete Pavement.** Complete joint restoration work, except sealing, before diamond grinding.

Diamond grind concrete pavement in the longitudinal direction beginning and ending at lines perpendicular to the pavement centerline. Stop grinding if conditions cause water to freeze.

Do not disturb Reflective Pavement Markers (RPM). Taper grinding to the existing pavement surface within 2 inches of the RPM.

Texture at least 95 percent of the pavement surface unless otherwise directed by the Engineer. The Engineer will not require extra depth grinding to eliminate minor depressions.

After initial grinding, regrind faulted areas, greater than  $\frac{1}{16}$  inch, at transverse cracks and joints, until faulting is less than  $\frac{1}{16}$  inch.

Uniformly grind a parallel corduroy-type texture, consisting of grooves from  $\frac{1}{16}$  inch to  $\frac{1}{8}$  inch wide,  $\frac{1}{16}$  inch deep, and from  $\frac{1}{16}$  inch to  $\frac{1}{8}$  inch on center. Ensure the mean texture depth is at least 0.03 inch, in accordance with ASTM E 965.

Construct a uniform transverse slope with no depressions or misalignment greater than  $\frac{1}{8}$  inch when checked with a 10-foot straightedge. The Engineer will not apply straightedge requirements across longitudinal joints or outside ground areas. Provide for cross slope drainage.

To provide drainage and the required riding surface, transition grind auxiliary or ramp lanes from the mainline edge. The Engineer will determine the transitions from ground to unground pavement surfaces.

Seal joints after grinding.

1. **Control and Disposal of Grinding Residue.** Before beginning grinding, obtain the Engineer's approval of the grinding residue spreading and disposal method.

Do not allow grinding residue to enter enclosed drainage systems.

If approved by the Engineer, spread residue along the roadway slopes with the following restrictions:

- a. Spread residue at least 5 feet away from the curb.
- b. Do not spread the residue within 100 feet of a natural stream or lake.
- c. Do not spread residue within 5 feet of a water-filled ditch.

If surface runoff occurs, collect and haul the grinding residue to an Engineer-approved location on the project. Collect, haul and dispose of grinding residue at no additional cost to the Department.

2. **Testing Diamond Grinding Residue.** The Department will take random samples of the grinding residue and cooling water for chemical testing. Allow Department personnel access to obtain the samples.

**D. Sawing and Sealing Pavement Joints.** Saw, or re-saw, clean, and seal longitudinal and transverse concrete pavement joints in accordance with subsection [602.03.S](#) and the following.

Use low-modulus hot-poured joint sealant.

Repair spalls before resawing the longitudinal joint and as directed by the Engineer.

Saw longitudinal and transverse joints in new repairs as required by the contract. Resaw existing longitudinal and transverse joints from 1 inch to 1¼ inches deep, and from ¼ inch to ½ inch wide. Immediately after sawing, flush the joint groove with water to remove slurry and debris. Saw, or resaw, longitudinal joints before resealing the intersecting transverse joints.

Provide a final cleaning just before sealing, in accordance with subsection [602.03.R](#). After the final cleaning, insert a backer rod into the longitudinal joint to provide a 1:1 width to depth ratio of joint sealant.

Ensure the joint faces and pavement surface are dry before sealing joints. Seal the joint groove to no greater than ⅛ inch (after cooling) below the surface of the pavement.

**E. Sawing and Sealing Cracks.** Seal cracks with a hot-poured sealant as follows:

Saw cracks from ½ inch to ⅝ inch deep and from ⅜ inch to ½ inch wide.

After sawing, use hand tools or a lightweight chipping hammer to remove slivers of concrete, less than 1 inch wide, along the crack. Immediately before sealing, blast both faces of the sawed crack with dry abrasive to remove contamination and texture the faces. After dry abrasive blasting, clean the crack of debris and residue with oil-free compressed air with at least 90 psi.

Ensure the joint faces and pavement surface are dry before sealing joints. If the crack below the sealant reservoir is greater than ⅜ inch wide, insert a backer rod into the crack to form the bottom of the reservoir at the required depth. Seal the crack to no greater than ⅛ inch (after cooling) below the surface of the pavement.

If required by the crown of the roadway and the slope of the shoulder, fill the reservoir in two or more passes, place temporary dikes in the sealed reservoir, or use both methods. Remove the temporary dikes before the sealant fully cools and seal the resulting cavity. Apply the additional sealant before the previous application becomes contaminated.

**603.04. Measurement and Payment.**

| <b>Pay Item</b>                                      | <b>Pay Unit</b> |
|--|-----------------|
| Pavt Repr, Rem .....                                 | Square Yard     |
| Saw Cut, Intermediate .....                          | Foot            |
| Pavt Repr, Reinf Conc, __ inch .....                 | Square Yard     |
| Pavt Repr, Nonreinf Conc, __ inch .....              | Square Yard     |
| Non-Chloride Accelerator .....                       | Gallon          |
| Joint, Contraction, Crg .....                        | Foot            |
| Joint, Expansion, Erg .....                          | Foot            |
| Joint, Expansion, Esc .....                          | Foot            |
| Joint, Tied, Trg .....                               | Foot            |
| Lane Tie, Epoxy Anchored .....                       | Each            |
| Diamond Grinding Conc Pavt .....                     | Square Yard     |
| Sawing and Sealing Longit Pavt Joints .....          | Foot            |
| Sawing and Sealing Trans Pavt Joints .....           | Foot            |
| Resealing Trans Joints with Hot-Poured Rubber .....  | Foot            |
| Resealing Longit Joints with Hot-Poured Rubber ..... | Foot            |
| Crack Sealing, Conc Pavt .....                       | Foot            |
| Cement .....   | Ton             |

**A. Price Adjustments for Concrete Pavement Repairs.** The Engineer will determine the final concrete pavement repair thickness in accordance with subsection [603.04.C](#). The Department may core the concrete pavement repairs and will adjust the unit prices for repairs that do not meet the required depth or the required reinforcement location in accordance with subsection [602.04](#).

**B. Pavement Repair, Removal.** The Department considers **Pavt Repr, Rem** the removal of pavement sections without disturbing the base, as shown on the plans. The unit price for **Pavt Repr, Rem** includes the cost of the following:

1. Moving from repair to repair;
2. Saw cutting;
3. Removing adjacent concrete shoulders, curb, curb and gutter, and valley gutter;
4. Removing part-depth or full-depth HMA patches;
5. Lifting the repair section without disturbing the base;
6. Loading, hauling, and disposing of the removed material; and
7. Placing HMA mixture, as necessary, to restore the shoulders to the existing line and grade.

The Department will include the pay item, **Saw Cut, Intermediate** for sections of pavement on which the plans show **Pavt Repr, Rem**. The Department will not include the pay item, **Saw Cut, Intermediate** for

sections of pavement on which the plans show **Pavt, Rem**. The Department will pay for intermediate saw cuts for concrete pavement repairs over 6 feet long, but less than 50 feet long, to allow loading onto hauling units, as **Saw Cut, Intermediate**. The Department will not pay separately for additional saw cuts, made by the Contractor to reduce slabs into pieces smaller than one lane width by 6 feet long.

The Department will pay for the removal of portions of concrete that contain partial, or full-depth HMA patches as **Pavt Repr, Rem**.

**C. Pavement Repair, Reinforced Concrete, and Pavement Repair, Non-reinforced Concrete.** The Department will establish a concrete pavement thickness for repairs, as shown on the plans, based on the original plan thickness of the existing concrete pavement plus 1 inch. The minimum thickness of the concrete pavement repair may vary by no greater than  $\pm 1$  inch from the thickness shown on the plans.

The Department will not pay separately for work required to correct low base conditions caused by Contractor removal operations. The Department will pay for site preparation to correct base, more than 2 inches below the required grade, not caused by Contractor operations, under the relevant pay items. If the contract does not include a relevant pay item, the Department will pay for base corrections greater than 2 inches deep, not caused by Contractor operations, as extra work.

1. **Repair.** The Engineer will measure **Pavt Repr, Reinf Conc**, and **Pavt Repr, Nonreinf Conc**, of the thickness specified, longitudinally along the pavement surface, and will use the transverse dimension shown on the plans.

The unit prices for **Pavt Repr, Reinf Conc**, and **Pavt Repr, Nonreinf Conc** include the cost of the following:

- a. Moving from repair to repair;
  - b. Providing, placing, finishing, texturing, stenciling, and curing the concrete;
  - c. Providing and placing bar chairs and the steel reinforcement; and
  - d. Providing additional concrete, as necessary, to correct low base conditions that do not exceed 2 inches measured from the required grade.
2. **Tied Joints (Trg).** The unit price for **Joint, Tied, Trg** includes the cost of the following:
    - a. Removing saw slurry from the pavement surface and sawed faces;

- b. Drilling and cleaning holes for dowel bars and deformed bars;
  - c. Providing, mixing, and installing grout; and
  - d. Providing and installing dowel bars or deformed bars.
3. **Contraction Joints (Crg).** The unit price for **Joint, Contraction, Crg** includes the cost of work specified by subsection [603.04.C.2](#) and the following:
- a. Sawing the joint grooves;
  - b. Cleaning and preparing the joint groove;
  - c. Providing and applying the dowel bar bond breaker coating;
  - d. Providing and installing the bond breaker tape; and
  - e. Providing and installing the joint groove sealant.
- D. **Concrete Grade P-NC.** If the Engineer determines the time from casting the repair area to the intended opening-to-traffic requires the use of Grade P-NC concrete mixtures, the Engineer will measure, and the Department will pay for the extra cement based on the following:
- 1. If the forecasted air temperature is above 59 °F, 94 pounds per cubic yard; or
  - 2. If the forecasted air temperature is 59 °F and below, 188 pounds per cubic yard.
- E. **Type C and Type E Non-Chloride Accelerator.** If the Engineer requires the addition of Type C or Type E non-chloride accelerator to the concrete mixture, the Engineer will measure, and the Department will pay for **Non-Chloride Accelerator** based on the quantity printed on the automated batch ticket. The Department will make deductions for wasted or rejected materials.
- F. **Repair of Concrete Shoulders, Curbs, and Curb and Gutter.** The Engineer will measure repairs for concrete shoulders, curbs, and curb and gutter as **Pavt Repr, Nonreinf, Conc**, at the same thickness as adjacent concrete pavement repairs. The Department will pay for repairing concrete shoulders, curbs, and curb and gutter as **Pavt Repr, Nonreinf, Conc**.
- G. **Joints.**
- 1. **Joint, Expansion, Esc.** The unit price for **Joint, Expansion, Esc** includes the cost of sawing and chipping the joint and providing and installing the joint filler material.
  - 2. **Expansion, Erg.** The unit price for **Joint Expansion Erg** includes the cost of the following:
    - a. Making the saw cuts required at the ends of the repairs;



- b. Removing the saw slurry from the pavement surface and sawed faces;
- c. Drilling and cleaning the holes for the dowel bars and deformed bars;
- d. Providing, mixing, and installing the grout;
- e. Providing and installing the dowel bars and deformed bars;
- f. Providing and applying the dowel bar bond breaker coating;
- g. Providing, drilling or punching, and installing the fiber filler;
- h. Providing and installing the dowel bar expansion caps;
- i. Sawing the joint grooves;
- j. Cleaning and preparing the joint groove; and
- k. Providing and installing the joint groove sealant.

The Department will pay for sawing depths, greater than 1 inch below the depth shown on the plans, as extra work.

3. **Transverse Plane-of-Weakness Joints D1.** The Engineer will measure, and the Department will pay for transverse plane-of-weakness joints D1 in accordance with subsection [602.04](#).
  4. **Transverse Plane-of-Weakness Joints U.** The unit prices for other concrete pavement repair pay items include the cost of transverse plane-of-weakness joints U.
- H. **Lane Tie, Epoxy Anchored.** The unit price for **Lane Tie, Epoxy Anchored** includes the cost of the following:
1. Drilling and cleaning the holes;
  2. Providing, mixing, and installing the grout; and
  3. Providing and installing the deformed bars.

The unit prices for other pay items include the cost of final trim and clean-up, part-width construction, and restoring shoulders.

I. **Diamond Grinding Concrete Pavement.** The Engineer will include the final textured surface area in the measurement for **Diamond Grinding Conc Pavt.** The Department will not deduct minor areas of untextured pavement if the minor areas total no greater than 5 percent of the area shown on the plans.

The unit price for **Diamond Grinding Conc Pavt** includes the cost of collecting, hauling, and spreading grinding residue. The unit prices for other pay items include the cost of additional passes or regrinding to meet ride quality requirements.

J. **Longitudinal Pavement Joints and Transverse Pavement Joints.** The unit prices for **Sawing and Sealing Longit Pavt Joints** and **Sawing**

**and Sealing Transv Pavt Joints** include the cost of sawing or resawing, cleaning, and sealing the joints with hot-poured rubber.

**K. Resealing Transverse and Longitudinal Joints with Hot-Poured Rubber.** The Engineer will measure **Resealing Transv Joints with Hot-Poured Rubber** and **Resealing Longit Joints with Hot-Poured Rubber** in a straight line in the direction of each joint. The unit prices for **Resealing Transv Joints with Hot-Poured Rubber** and **Resealing Longit Joints with Hot-Poured Rubber** include the cost of removing existing sealants, cleaning, and sealing the joints.

**L. Crack Sealing, Concrete Pavement.** The Engineer will measure **Crack Sealing, Conc Pavt** in a straight line in the direction of each crack.

**Section 604. CONTRACTOR QUALITY CONTROL FOR CONCRETE**

**604.01. Description.** This work consists of providing and maintaining an effective concrete quality control plan for all concrete production and placement on the project.

The Engineer will not sample or test for quality control or assist in controlling the Contractor's production operations.

Provide the personnel and testing equipment necessary to perform the required tests for quality control. Ensure personnel performing quality control sampling and testing are qualified through a Department-approved program.

**604.02. Materials.** None specified.

**604.03. Quality Control Elements.** Provide and maintain an effective concrete quality control program as required by the contract.

**604.04. Measurement and Payment.** All costs associated with this work are included in the unit prices for the relevant concrete items. The Department will not pay separately for providing and maintaining an effective quality control program.

## **Section 605. QUALITY ASSURANCE (ACCEPTANCE) FOR CONCRETE**

**605.01. Description.** Unless otherwise specified, all concrete provided and placed on the project is covered by the Department's Concrete Quality Assurance (QA) program. Refer to the contract for additional concrete quality assurance details.

**605.02. Materials.** None specified.

**605.03. Quality Assurance Considerations.** The Engineer will sample and test concrete for quality assurance (acceptance).

Do not continue production of nonconforming work. The Engineer will not accept concrete at a reduced price in lieu of the Contractor making adjustments to bring work into conformance.

Refer to the contract for additional concrete quality assurance considerations.

**605.04. Measurement and Payment.** Concrete quality assurance will be applied according to the contract.

## NOTES

## DIVISION 7 – STRUCTURES

| <b>Section</b> | <b>Title</b>   | <b>Page No.</b>     |
|----------------|--|---------------------|
| 701            | Portland Cement Concrete for Structures .....                          | <a href="#">349</a> |
| 702            | Mortar and Grout .....   | <a href="#">353</a> |
| 703            | Mortar and Concrete Patching, Repair, and Resurfacing<br>Mixtures..... | <a href="#">357</a> |
| 704            | Steel Sheet Piling and Cofferdams .....                                | <a href="#">361</a> |
| 705            | Foundation Piling .....  | <a href="#">366</a> |
| 706            | Structural Concrete Construction .....                                 | <a href="#">383</a> |
| 707            | Structural Steel Construction .....                                    | <a href="#">414</a> |
| 708            | Prestressed Concrete.....  | <a href="#">437</a> |
| 709            | Timber Structures .....  | <a href="#">446</a> |
| 710            | Waterproofing and Protective Covers.....                               | <a href="#">450</a> |
| 711            | Bridge Railings .....  | <a href="#">458</a> |
| 712            | Bridge Rehabilitation – Concrete .....                                 | <a href="#">462</a> |
| 713            | Bridge Rehabilitation – Steel.....                                     | <a href="#">488</a> |
| 714            | Temporary Structures and Approaches.....                               | <a href="#">499</a> |
| 715            | Cleaning and Coating Existing Structural Steel.....                    | <a href="#">501</a> |
| 716            | Shop Cleaning and Coating Structural Steel.....                        | <a href="#">514</a> |
| 717            | Downspouts and Drains .....  | <a href="#">520</a> |
| 718            | Drilled Shafts .....   | <a href="#">522</a> |

## NOTES

## Section 701. PORTLAND CEMENT CONCRETE FOR STRUCTURES

**701.01. Description.** This work consists of producing and furnishing concrete proportioned for the grades of concrete required.

The term "sack" refers to a 94-pound sack of cement.

**701.02. Materials.** Provide materials in accordance with the following:

|                                   |                     |
|-----------------------------------|---------------------|
| Cement .....                      | <a href="#">901</a> |
| Slag Cement.....                  | <a href="#">901</a> |
| Fly Ash.....                      | <a href="#">901</a> |
| Coarse Aggregate 6A, 6AA,17A..... | <a href="#">902</a> |
| Fine Aggregate 2NS, 2SS .....     | <a href="#">902</a> |
| Concrete Admixtures .....         | <a href="#">903</a> |
| Water .....                       | <a href="#">911</a> |

Provide coarse aggregate in accordance with Table [701-1A](#) and Table [701-1B](#) for the specified concrete grade.

Provide stone sand 2SS only for structure concrete not exposed to vehicular traffic.

Do not use concrete accelerators that contain calcium chloride in concrete for bridges or concrete with embedded aluminum or galvanized steel.

### 701.03. General Requirements.

**A. Structural Concrete Mixtures.** Provide concrete mixtures in accordance with:

1. Batch plant equipment, certification, and certification waiver requirements of subsection [601.03.A](#), subsection [601.03.B](#), and subsection [601.03.C](#), respectively;
2. Materials handling requirements of subsection [601.03.D](#);
3. Concrete mixing requirements of subsection [601.03.E](#); and
4. Concrete temperature requirement of subsection [601.03.F.1](#).

**B. Concrete Quality Control.** Provide concrete Quality Control (QC) in accordance with section [604](#) and the contract. Unless otherwise specified in the contract, provide concrete structure mixtures in accordance with Table [701-1A](#) and Table [701-1B](#). Use supplemental cementitious materials as specified in the contract.

**C. Air Content of Structural Concrete.** Do not use de-foaming (air-detraining) admixtures. Furnish concrete containing 5.0 to 8.0 percent entrained air, except as follows:



## 701.03

1. Provide an entrained air content of 5.5 to 8.5 percent for concrete containing Type F or Type G admixtures;
2. Air content less than 5.5 percent for concrete that lies in the finished work at least 3 feet below the surface of the ground or entirely under water will not be cause for rejection; and
3. The Engineer will allow non-air-entrained concrete for concrete placed in steel shell piles not subject to freezing.

Use the Department's modification of ASTM C 231 or ASTM C 173 to determine the air content of freshly mixed concrete. Take samples according to [MTM 207](#).

Use the volumetric method, ASTM C 173 to determine the air content of freshly mixed concrete containing highly porous coarse aggregate. Take samples according to [MTM 207](#).

If the proportion of air entraining admixture used is adjusted, record the new quantity on the first delivery ticket following the adjustment.

If concrete having low air content arrives at the project site in truck mixers, additional air-entraining admixture may be added at the site, with additional mixing as necessary, until adjustments at the batching plant are made.

**D. Work Progress Specimens for Structure.** Ensure that the strength of structure concrete meets the requirements of subsection [104.11.B](#) for opening to construction traffic or vehicular traffic, removing shoring or forms, or similar operations. Test work progress specimens in accordance with subsection [601.03.H](#).

**701.04. Measurement and Payment.** The cost of producing and furnishing structure concrete mixtures is included in the unit prices for other relevant pay items.

**Table 701-1A**  
Concrete Structure Mixtures by Slump

| Concrete Grade<br>(e, h) | Section Number Reference<br>(i)                             | Cement content per cubic yard<br>(b, c) |      | Type A, D or no Admixture<br>(g) | Slump (in)       |                             |                               |
|--------------------------|---|---|------|----------------------------------|------------------|-----------------------------|-------------------------------|
|                          |   | lb                                      | sack |                                  | Before Admixture | Type MR, F, or G Admixtures |                               |
|                          |   |   |      |                                  |                  | After Admixture (Type MR)   | After Admixture (Type F or G) |
| D (a)                    | <a href="#">706, 711, 712</a>                               | 658 (d)                                 | 7.0  | 0-3                              | 0-3              | 0-6                         | 0-7                           |
| S1                       | <a href="#">705</a>   | 611                                     | 6.5  | 3-5                              | 0-3              | 3-6                         | 3-7                           |
| T                        | <a href="#">705, 706</a>                                    | 611                                     | 6.5  | 3-7                              | 0-4              | 3-7                         | 3-8                           |
| S2 (a)                   | <a href="#">401, 705, 706, 712, 713, 801, 802, 803, 810</a> | 564                                     | 6.0  | 0-3                              | 0-3              | 0-6                         | 0-7                           |
| S3                       | <a href="#">402, 403, 803, 804, 806</a>                     | 517                                     | 5.5  | 0-3                              | 0-3              | 0-6                         | 0-7                           |
|                          |   | 489 (d)                                 | 5.2  |                                  |                  |                             |                               |

Note: See Table 701-1B below for table notes.

**Table 701-1B**  
Concrete Structure Mixtures by Strength of Concrete

| Concrete Grade<br>(e, h) | Section Number Reference<br>(i)                             | Cement content per cubic yard<br>(b, c) |      | Minimum Strength of Concrete<br>(f) |        |        |                    |        |        |
|--------------------------|---|---|------|-------------------------------------|--------|--------|--------------------|--------|--------|
|                          |   | lb                                      | sack | Flexural, (psi)                     |        |        | Compressive, (psi) |        |        |
|                          |   |   |      | 7 day                               | 14 day | 28 day | 7 day              | 14 day | 28 day |
| D (a)                    | <a href="#">706, 711, 712</a>                               | 658 (d)                                 | 7.0  | 625                                 | 700    | 725    | 3,200              | 4,000  | 4,500  |
| S1                       | <a href="#">705</a>   | 611                                     | 6.5  | 600                                 | 650    | 700    | 3,000              | 3,500  | 4,000  |
| T                        | <a href="#">705, 706</a>                                    | 611                                     | 6.5  | 550                                 | 600    | 650    | 2,600              | 3,000  | 3,500  |
| S2 (a)                   | <a href="#">401, 705, 706, 712, 713, 801, 802, 803, 810</a> | 564                                     | 6.0  | 550                                 | 600    | 650    | 2,600              | 3,000  | 3,500  |
| S3                       | <a href="#">402, 403, 803, 804, 806</a>                     | 517                                     | 5.5  | 500                                 | 550    | 600    | 2,200              | 2,600  | 3,000  |
|                          |   | 489 (d)                                 | 5.2  | 500                                 | 550    | 600    | 2,200              | 2,600  | 3,000  |

**Notes for Table 701-1A and Table 701-1B:**

- a. Unless otherwise required, use Coarse Aggregate 6AA or 17A for exposed structural concrete in bridges, retaining walls, and pump stations.
- b. If the local average minimum temperature for the next 10 consecutive days after concrete placement is forecast to be below 40 °F, submit a revised quality control plan for the Engineer's approval prior to cold weather concrete placement. The revised plan must detail changes in materials, concrete batching and mixing processes, construction methods, curing, and protection of the in situ concrete to ensure that the quality characteristics of the hardened concrete are not compromised by the cold weather. The restriction does not apply to Grade S1 concrete in foundation piling below ground level or Grade T concrete in tremie construction.
- c. Type III cement is not permitted.
- d. Use admixture quantities specified by the Qualified Products Lists to reduce mixing water. Admixture use is required for Grade D, Grade S2, and Grade S3, concrete with a reduced cement content. Use a water-reducing retarding admixture at the required dosage for Grade D concrete to provide the setting retardation required. When the maximum air temperature is not forecast to exceed 60 °F for the day, the Contractor may use a water-reducing admixture or a water-reducing retarding admixture. Ensure Grade D concrete in concrete diaphragms contains a water-reducing admixture, or a water-reducing retarding admixture. For night casting, the Contractor may use a water-reducing admixture in lieu of water-reducing retarding admixture, provided that the concrete can be placed and finished prior to initial set.
- e. The mix design basis for bulk volume (dry, loose) of coarse aggregate per unit volume of concrete is 68% for Grade S1, and 70% for Grade D, Grade S2, Grade T, and Grade S3 Footnote e does not apply to mix designs containing Engineer-approved, optimized aggregate gradations.
- f. The Contractor may use flexural strength to determine form removal. Use compressive strength for acceptance in other situations.
- g. MR = Mid-range.
- h. The Engineer will allow the use of an optimized aggregate gradation meeting the requirements of [MTM 130](#).
- i. Section Number Reference
- |  |  |
|--|--|
| <a href="#">401</a> Culverts                                     | <a href="#">402</a> Storm Sewers                         |
| <a href="#">403</a> Drainage Structures                          | <a href="#">705</a> Foundation Piling                    |
| <a href="#">706</a> Structural Concrete Construction             | <a href="#">711</a> Bridge Railings                      |
| <a href="#">712</a> Bridge Rehabilitation-Concrete               | <a href="#">713</a> Bridge Rehabilitation-Steel          |
| <a href="#">801</a> Concrete Driveways                           | <a href="#">802</a> Concrete Curb, Gutter and Dividers   |
| <a href="#">803</a> Concrete Sidewalk, Sidewalk Ramps, and Steps | <a href="#">804</a> Concrete Barriers and Glare Screens  |
| <a href="#">806</a> Bicycle Paths                                | <a href="#">810</a> Permanent Traffic Signs and Supports |

## Section 702. MORTAR AND GROUT

**702.01. Description.** This work consists of producing and furnishing mortars and grouts proportioned as required.

**702.02. Materials.** Provide material in accordance with the following:

|   |                     |
|---|---------------------|
| Portland Cement Type I, Type IA .....       | <a href="#">901</a> |
| Masonry Cement Type N, Type S, Type M ..... | <a href="#">901</a> |
| Hydrated Lime Type S, Type SA .....         | <a href="#">901</a> |
| Fine Aggregate 2NS, 2MS .....               | <a href="#">902</a> |
| Air-Entraining Admixture .....              | <a href="#">903</a> |
| Water .....                                 | <a href="#">911</a> |

**A. Standard Mortars and Grouts.** Proportion cement and fine aggregates, as specified in Table [702-1A](#) and Table [702-1B](#), by weight for batches of at least 1 cubic yard, and by weight or volume for smaller batches. Add water to obtain a mortar or grout of the consistency required.

**B. Non-shrinking Mortar and Grout, Type H-1 (Non-metallic).** Provide Type H-1 non-shrinking mortar and grout, selected from the Qualified Products List, for filling post-tensioning stress pockets in fascia beams of prestressed box beams, under leveling plates supporting structures, and for grouting dowels.

**C. Expansive Grout, Type E-1.** Provide Type E-1 expansive grout for filling the void around post-tensioned tendons in precast concrete box beams. Proportion the grout as follows:

1. Type I portland cement, 94 pounds;
2. Water, no greater than 5 gallons; and
3. Expansive admixture, as recommended by the manufacturer.

Do not use sand in the grout mixture. Do not use grout containing aluminum or other components that produce hydrogen, carbon dioxide, or oxygen gas.

Ensure grout attains a 28-day minimum compressive strength of 3,000 psi, in accordance with ASTM C 942, except proportion the grout as specified in this subsection.

Do not use expansive admixtures, plasticizing, or water-reducing agents that contain chloride ions in excess of 0.50 percent by weight, fluorides, sulfides, nitrates, thixotropic additives, or chemicals that may contribute to stress corrosion in steel.

Provide admixtures in liquid or solid form. Use a gas-evolving material, well dispersed throughout the admixture. Provide grout with an unrestrained expansion from 5 percent to 10 percent, in accordance with ASTM C 940, except proportion the grout as specified in this subsection, and determine expansion at 3 hours.

**702.03. Construction.** The Contractor may remix mortars and grouts.

Do not retemper mortars and grouts or use grout and mortar after it begins to set.

Place mortar and grout when materials receiving the application of mortar and grout, maintain a temperature of at least 40 °F during the placement and curing period.

**702.04. Measurement and Payment.** The cost of producing and furnishing mortar or grout is included in the unit prices for other relevant pay items.

| Table 702-1A<br>Proportioning Standard Mortars and Grouts by Dry Weight |  |                    |                   |                  |                   |                    |                   |                  |                   |              |
|---|--|--------------------|-------------------|------------------|-------------------|--------------------|-------------------|------------------|-------------------|--------------|
| Mortar<br>or<br>Grout<br>Type   | General<br>Use   | Materials          |                   |                  |                   |                    |                   |                  |                   |              |
|   |  | Portland<br>Cement | Masonry<br>Cement | Hydrated<br>Lime | Fine<br>Aggregate | Portland<br>Cement | Masonry<br>Cement | Hydrated<br>Lime | Fine<br>Aggregate | Net<br>Water |
| R-1<br>(Grout)  | Bond or<br>Primer<br>Coat  | Type I,IA          | —                 | —                | 2NS               | 1,175              | —                 | —                | 964               | 705          |
|   |  | —                  | Type M            | —                | 2MS               | —                  | 930               | —                | 2,137             | 415          |
|   |  | Type I             | Type N            | —                | 2MS               | 468                | 349               | —                | 1,991             | 415          |
| R-2<br>(Mortar)<br>(a)  | Filling<br>Space<br>Between<br>Box<br>Beams  | Type I,IA          | —                 | Type S,SA        | 2MS               | 828                | —                 | 75               | 2,016             | 415          |
|   |  | Type I,IA          | —                 | —                | 2MS,2NS           | 930                | —                 | —                | 1,966             | 415          |
| R-3<br>(Mortar)<br>(a)  | Setting<br>Precast<br>Concrete<br>Barriers;<br>Filler<br>Between<br>Slope<br>Protection<br>Blocks<br>and<br>Riprap | Type I,IA          | —                 | —                | 2NS               | 765                | —                 | —                | 2,266             | 353          |
|   |  | —                  | —                 | —                | —                 | —                  | —                 | —                | —                 | —            |

a. Provide an entrained air content of 14 percent  $\pm$ 4 percent using masonry cement, Type IA portland cement, Type SA lime, or an air-entraining admixture. Do not combine masonry cement and Type IA portland cement, or Type IA portland cement and Type SA lime, unless tests indicate the air content is within acceptable limits.

| Table 702-1B<br>Proportioning Standard Mortars and Grouts by Bulk Volume Parts  |   |                 |                |               |                |                                      |                |               |                |
|---|---|-----------------|----------------|---------------|----------------|--------------------------------------|----------------|---------------|----------------|
| Mortar or Grout Type  | General Use   | Materials       |                |               |                | Mix Proportions by Bulk Volume Parts |                |               |                |
|   |   | Portland Cement | Masonry Cement | Hydrated Lime | Fine Aggregate | Portland Cement                      | Masonry Cement | Hydrated Lime | Fine Aggregate |
| R-1<br>(Grout)  | Bond or Primer Coat<br>Patching<br>Spalls;<br>Filling<br>Space<br>Between<br>Box Beams                          | Type I,IA       | —              | —             | 2NS            | 1                                    | —              | —             | 1              |
|   |   | —               | Type M         | —             | 2MS            | —                                    | 1              | —             | 2½             |
|   |   | Type I          | Type N         | —             | 2MS            | (b)                                  | (b)            | —             | (b)            |
| R-2<br>(Mortar)<br>(a)  | Space<br>Between<br>Box Beams   | Type I,IA       | —              | Type<br>S,SA  | 2MS            | (b)                                  | —              | (b)           | (b)            |
|   |   | Type I,IA       | —              | —             | 2MS,2NS        | 1                                    | —              | —             | 2½             |
| R-3<br>(Mortar)<br>(a)  | Setting<br>Precast<br>Concrete<br>Barriers;<br>Filler<br>Between<br>Slope<br>Protection<br>Blocks and<br>Riprap | Type I,IA       | —              | —             | 2NS            | 1                                    | —              | —             | 3½             |
|   |   |                 |                |               |                |                                      |                |               |                |
| <p>a. Provide an entrained air content of 14 percent ±4 percent for mortars by using masonry cement, Type IA portland cement, Type SA lime, or an air-entraining admixture. Do not combine masonry cement and Type IA portland cement, or Type IA portland cement and Type SA lime, unless tests indicate the air content is within acceptable limits.</p> <p>b. Do not proportion by volume if blending cementitious materials (portland cement, masonry cement, or lime).</p> |   |                 |                |               |                |                                      |                |               |                |

## Section 703. MORTAR AND CONCRETE PATCHING, REPAIR, AND RESURFACING MIXTURES

**703.01. Description.** This work consists of producing and furnishing mortar and concrete mixtures for patching, repair, and concrete overlays in accordance with section [701](#), except as modified by this section.

**703.02. Materials.** Provide materials in accordance with the following:

|   |                     |
|---|---------------------|
| Cement, Type I, Type IA.....                                | <a href="#">901</a> |
| Silica Fume.....  | <a href="#">901</a> |
| Coarse Aggregate 6AA, 6A, 26A.....                          | <a href="#">902</a> |
| Fine Aggregate 2NS.....                                     | <a href="#">902</a> |
| Polypropylene Fibers.....                                   | <a href="#">903</a> |
| Latex Emulsion Admixture.....                               | <a href="#">903</a> |
| Water Reducing and Water Reducing-Retarding Admixtures..... | <a href="#">903</a> |
| Air Entraining Admixtures.....                              | <a href="#">903</a> |
| Water.....  | <a href="#">911</a> |

**A. General Requirements.** Unless otherwise required by the contract, provide air-entrained concrete or mortar.

Proportion mixtures as specified in Table [703-1](#) and Table [703-2](#). Aggregate weights specified in the tables are based on a dry bulk specific gravity of 2.65 for gravel and stone. Adjust the weights if the specific gravity of the materials used varies by more than 0.02 from the specified values.

The specified quantity of water is approximate. Use the least amount of water to provide the consistency required for the specific mixture.

Do not use slag aggregates.

**B. Mortar and Concrete Patching Mixtures, Types F-L, M, C-L, C-L-HE, C, and C-HE.** Provide mortar and concrete patching mixtures for patching bridge decks or substructure elements.

Select a mixture from Table [703-1](#) based on the depth of patched area and the length of curing time available before allowing traffic on patches. Provide either regular strength or high-early strength patching mixtures. Allow a cure time of at least five days for regular strength patching mixtures and at least 24 hours for high-early strength patching mixtures.

**C. Latex Modified Concrete (LMC) Overlay Mixture.** Provide 100 percent crushed 26A coarse aggregate conforming to section [902](#). Ensure LMC meets the strength requirements of Grade D concrete as specified in Table [701-1](#), in accordance with section [605](#) and the contract.



| Table 703-1<br>Structures Patching Mixtures |                       |                        |   |                             |                                |                         |                     |                           |
|---|-----------------------|------------------------|---|-----------------------------|--------------------------------|-------------------------|---------------------|---------------------------|
| Depth of Patch<br>in                        | Aggregate<br>Required | Mixture<br>Type<br>(g) | Mixture Proportions per cyd, dry weight |                             |                                |                         | Air<br>Content<br>% |                           |
|   |                       |                        | Cement<br>lb                            | Net Water<br>(approx)<br>lb | Latex<br>Admixture<br>lb (gal) | Fine<br>Aggregate<br>lb |                     | Coarse<br>Aggregate<br>lb |
| <1.5  | 2NS                   | F-L                    | 752 (c)                                 | (b)                         | 235 (28.0)                     | 2,450                   | N/A                 | 6.0 ±2.0                  |
| 1.5 - 4                                     | 2NS & 26A             | M                      | 799                                     | 358 (a)                     | N/A                            | 1,260                   | 1,260               | 7.5 ±1.5                  |
| ≥ 1.5                                       | 2NS & 26A<br>(d)      | C-L                    | 658 (c)                                 | 169 (b)                     | 143 (17.0)                     | 1,348 (e)               | 1,458 (e)           | 4.5 ±1.5                  |
|   |                       | C-L-HE                 | 846 (c)                                 | (b)                         | 228 (27.0)                     | 1,308 (e)               | 1,416 (e)           | 4.5 ±1.5                  |
| >4 (f)                                      | 2NS & 6AA             | C                      | 705                                     | 315 (a)                     | N/A                            | 1,220                   | 1,530               | 6.5 ±1.5                  |
|   |                       | C-HE                   | 846                                     | 300 (a)                     | N/A                            | 1,220                   | 1,590               | 5.5 ±1.5                  |

a. Control water to provide a stiff, workable mixture with 1 in to 2 in slump. During hot and windy weather, the Contractor may increase slump to 3 in to 4 in, as determined by the Engineer.

b. Add water, in addition to water in the latex admixture, to control slump to within 3 in to 5 in. Measure slump from 4 min to 5 min after discharge from the mixer. During this waiting period, deposit concrete on the deck and do not disturb. If placing mixtures on sections within super-elevated curves, the Contractor may need to use the lower allowable range of the slump requirement, as determined by the Engineer. Do not exceed water-cement ratio, by weight, of 0.30 including water contained in the latex emulsion.

c. Use only Type I cement in these mixtures.

d. Ensure the 26A absorption does not exceed 2.5%, in accordance with ASTM C 127.

e. The aggregate proportions are approximate; due to gradation changes, the Engineer may make adjustments. The Contractor may increase the fine aggregate quantity by no greater than 5% by weight of total aggregate if reducing coarse aggregate by an equivalent volume.

f. Substructure repairs.

g. F, M, and C indicate fine, medium, and coarse; L indicates latex modified; HE indicates high-early strength. Type F mixtures are mortars.

**Table 703-2  
Overlay Mixtures**

| Mixture Type | Aggregate     | Slump in | Air Content % | Admixture Required | Mixture Proportions lb/yd <sup>3</sup> , dry weight |                               |               |           |            |                 |
|--------------|---------------|----------|---------------|--------------------|---|-------------------------------|---------------|-----------|------------|-----------------|
|              |               |          |               |                    | Cement (a)  | Dry Densified Silica Fume (i) | Net Mix Water | Fine Agg  | Coarse Agg | Latex Admixture |
| SFMC         | 2NS & 26A (b) | 4 – 6    | 6.5±1.5       | (c, d, e)          | 618   | 40                            | 273 (f)       | 1,273     | 1,601      | —               |
| LMC          | 2NS & 26A (b) | (g)      | 4.5±1.5       | —                  | 658   | —                             | (g)           | 1,490 (h) | 1,300 (h)  | 206             |

a. Use only Type I portland cement.

b. Provide 26A aggregate, 100% crushed, with an absorption no greater than 2.5%, in accordance with ASTM C 127.

c. Water-reducing high-range admixture or water-reducing high-range and retarding admixture.

d. Virgin polypropylene collated fibers at 2 lb/yd<sup>3</sup>.

e. Air entraining admixture.

f. Provide a net water to cementitious material ratio of 0.41 (cementitious material includes cement and silica fume).

g. Add water. In addition to water in the latex admixture, to control slump to within 3 in to 5 in. Measure slump from 4 min to 5 min after discharge from the mixer. During this waiting period, deposit concrete on the deck and do not disturb. If placing mixtures on sections within super-elevated curves, the Contractor may need to use the lower allowable range of the slump requirement, as determined by the Engineer. Do not exceed water-cement ratio, by weight, of 0.30 including water contained in the latex emulsion.

h. Aggregate proportions are approximate; due to gradation changes, the Contractor may increase proportions by no greater than 5% by weight of total aggregate if reducing coarse aggregate by an equivalent volume.

i. For SFMC mixtures, the Contractor may use a blended silica fume portland cement. However, if the silica fume content of the blended material is greater than 8% of the total cementitious material, submit to the Engineer, modified mix proportions with Type I portland cement added to the blended material to achieve the equivalent individual cementitious material mixture proportions.

**D. Silica Fume Modified Concrete (SFMC) Overlay Mixture.** Provide 100 percent crushed 26A coarse aggregate conforming to section [902](#). Ensure SFMC meets the strength requirements of Grade D concrete as specified in Table [701-1](#), in accordance with section [605](#) and the contract. Supply the silica fume admixture in dry-densified form. Remove dry-densified silica fume from packaging. Do not incorporate the packaging into the concrete mix.

### **703.03. Construction.**

**A. Equipment.** Provide equipment for producing latex modified concrete by volumetric batching and continuous mixing in accordance with ASTM C 685. Provide certification to the Engineer, or demonstrate by field tests, that equipment is calibrated for yield and proportioning. Obtain the Engineer's approval for equipment before starting production.

Supply hand held vibrating equipment to consolidate the repair concrete.

**B. Mixing Concrete and Mortar.** Mix and transport silica fume modified concrete and mortar patching mixtures as specified in subsection [601.03](#). Do not deliver more than 7.0 cubic yards of silica fume modified concrete per load to the bridge site in ready mix trucks.

Proportion and mix latex modified mixtures in self-contained mobile continuous type mixers in accordance with ASTM C 685, except the Engineer will determine requirements for certification.

Ensure silica fume modified mixtures receive at least 100 revolutions at mixing speed after adding dry-densified silica fume. Add additional high-range water reducer (HRWR) to the mixture at the project to adjust the slump to the required range. After adding the HRWR, provide at least 60 revolutions at mixing speed. Do not add water at the project.

**703.04. Measurement and Payment.** The cost of mortar and concrete patching, repair, and resurfacing mixtures is included in the unit prices for other relevant pay items.

## Section 704. STEEL SHEET PILING AND COFFERDAMS

**704.01. Description.** This work consists of the following:

- A. Providing and driving permanent steel sheet piling,
- B. Designing, providing, installing, maintaining, and removing temporary steel sheet piling, or cutting off temporary steel sheet piling left in place, including bracing, tie backs, walers, and related material, and
- C. Designing, installing, maintaining, and removing cofferdams or cutting off cofferdams left in place, including sheet piling, bracing, tie backs, walers, and related material.

**704.02. Materials.** Provide material in accordance with the following:

|                          |                     |
|--------------------------|---------------------|
| Geosynthetics.....       | <a href="#">910</a> |
| Steel sheet piling ..... | <a href="#">906</a> |

Provide new or used continuous interlock-type steel sheet piling including connections and corner pieces. Used steel sheet piling must be in good condition and its use must be approved by the Engineer. Provide steel sheet piling with a nominal section modulus of at least 18.1 cubic inches per foot of wall, for both temporary steel sheet piling and cofferdams, when installed adjacent to traffic or when supporting traffic loads. Provide the permanent steel sheet piling section modulus shown on the plans.

The Contractor may provide cold-rolled sheeting for applications specified in this section.

**704.03. Construction.**

**A. Design and Installation.** Design steel sheet piling and cofferdams in accordance with the AASHTO *Standard Specifications for Highway Bridges*, 17th edition, and the contract.

Include the following information, as applicable, on the design documents:

1. Sheet piling section modulus and, embedment depth;
2. Design criteria for bracing and bracing sections, connection and tie-back details, and deadman sections;
3. Assumptions and references for the design calculations;
4. Any temporary loads for construction equipment, construction materials, traffic loading and any unbalanced hydrostatic pressure loading; and
5. Profile views and plan views with cross sections.

Document each stage of the construction on the working drawings. Submit an electronic file copy and one paper copy of the proposed design, supporting calculations and working drawings for steel sheet piling and/or cofferdams to the Engineer for review not less than 10 working days before beginning work, in accordance with subsection [104.02](#). If required by subsection [104.02](#), have working drawings sealed by Contractor's designer.

Begin work only after the Engineer approves the sheet pile design. The Engineer will not make allowance for increases in cost or lost time associated with resubmittals of the design due to comments or questions from the Department.

Construct steel sheet piling and cofferdams to the cutoff elevations and coordinate with the construction staging required by the contract. Provide a copy of any steel sheet piling or cofferdam design and working drawings at the job site as required by MIOSHA Construction Safety Standard.

**B. Driving Steel Sheet Piling.** Drive, brace, and cut off steel sheet piling in accordance with the Contractor's design for temporary steel sheet piling and cofferdams and the contract.

The Contractor may use drop hammers. Unless otherwise shown on the plans, the Contractor may use vibratory hammers.

Cut off temporary steel sheet piling, left in place, to the elevation shown on the plans. Do not pull up or redrive temporary steel sheet piling, left in place, to match the cut off elevation required, unless otherwise shown on the plans or approved by the Engineer.

After casting adjoining concrete, do not drive steel sheet pilings to a greater depth. To lower the top of permanent sheet piling after placing adjoining concrete, remove by cutting.

**C. Cofferdams.** Construct partial or total enclosure cofferdams to allow construction of substructures, above the seal or subfooting, in the dry without damaging the work. The Engineer may approve alternate methods, in lieu of cofferdams. The Engineer will consider approval after receiving applicable MDNRE permits for the alternate method.

Construct cofferdams with interior clearance for constructing forms, and inspecting form exteriors, and to allow pumping outside the forms. Construct cofferdams to protect the work from damage from high water and prevent damage to the foundation by erosion. Align or enlarge cofferdams or cribs that tilt or move laterally during the process of sinking, to provide required clearance.

Do not brace cofferdams to substructure forms. Bracing which extends into or remains in the finished concrete is not permitted.

If dewatering, pump from a sump located outside the forms. Do not dewater until the tremie seal obtains the minimum strength in accordance with subsection [706.03.H.3](#).

If the plans do not call for a tremie seal, discharge water pumped from a cofferdam into a geotextile filter bag. If the plans call for a tremie seal, maintain the water level inside the cofferdam equal to the water level outside the cofferdam, until the tremie seal is placed, unless otherwise approved by the Engineer. After placing tremie seal and initially dewatering into a geotextile filter bag, the Contractor may pump silt-free and sediment-free water directly into the watercourse, if approved by the Engineer.

Remove cofferdams without disturbing or marring finished concrete.

Cut off the cofferdams, left in place, at the elevation shown on the plans. Do not pull up or redrive cofferdam sheeting to match the cut off elevation, unless otherwise shown on the plans or approved by the Engineer.

#### **704.04. Measurement and Payment.**

| <b>Pay Item</b>                                 | <b>Pay Unit</b> |
|---|-----------------|
| Steel Sheet Piling, Permanent .....             | Square Foot     |
| Steel Sheet Piling, Temp .....                  | Square Foot     |
| Steel Sheet Piling, Temp, Left in Place .....   | Square Foot     |
| Cofferdams (Structure No.) .....                | Lump Sum        |
| Cofferdams, Left in Place (Structure No.) ..... | Lump Sum        |

#### **A. Steel Sheet Piling.**

- 1. Steel Sheet Piling Permanent.** The Engineer will calculate quantities of **Steel Sheet Piling, Permanent** based on the lines and lengths below cutoff, shown on the plans or authorized by the Engineer.
- 2. Steel Sheet Piling, Temp and Steel Sheet Piling, Temp, Left in Place.** The Engineer will calculate quantities of **Steel Sheet Piling, Temp** and **Steel Sheet Piling, Temp, Left in Place** based on the area of earth retention. The Engineer will calculate the vertical dimension of the area, based on the difference in ground elevations at the sheeting line, or the planned foundation excavation limits at the sheeting line, whichever is less. Unless otherwise shown on the plans, the Engineer will calculate the lateral limits based on the design specified in subsection [704.03.A](#).

If retaining earth on both sides of the same steel sheet piling during different construction stages, the Engineer will calculate the quantity based on the stage requiring the largest area of earth retention; not the sum of the areas of earth retention for each stage.

The Engineer will take horizontal measurements along the sheet piling alignment without allowance for the structural shapes of the separate sections.

- a. **Steel Sheet Piling, Temp.** The unit price for **Steel Sheet Piling, Temp** includes designing, providing, installing, maintaining, and removing the sheet piling, bracing, tie backs, walers, deadman, related material, and equipment required to maintain support of the sheeting and adjacent embankment.
  - b. **Steel Sheet Piling, Temp, Left in Place.** The unit price for **Steel Sheet Piling, Temp, Left in Place** includes designing, providing, installing, maintaining, and cutting off the sheet piling, bracing, tie backs, deadman, walers, related material, and equipment required to maintain support of the sheeting and adjacent embankment.
- B. **Cofferdams.** The Engineer will measure, and the Department will pay for filter bags as specified in subsection [208.04](#).
1. **Cofferdams.** If the contract includes a separate pay item for **Cofferdams**, the Engineer will group and measure cofferdams for the structure as a unit. The unit price for **Cofferdams**, of the type required, includes designing, providing, installing, maintaining, and removing sheet piling, bracing, tie backs, walers, deadman and related material.
  2. **Cofferdams, Left in Place.** If the contract includes a separate pay item for **Cofferdams, Left in Place**, the Engineer will group and measure cofferdams specified as left in place for the structure as a unit. The unit price for **Cofferdams, Left in Place** includes designing, providing, installing, maintaining, and cutting off of sheet piling, bracing, tie backs, walers, deadman, and related material.

If the contract does not include a pay item for **Cofferdams** or **Cofferdams, Left in Place**, the cost of constructing a cofferdam for structures not crossing streams is included in the unit prices for other items of work; for structures crossing streams or encroaching on water courses, the cost of constructing a cofferdam will be paid for as extra work.

If the Engineer authorizes an alternate method to a sheet pile cofferdam, the Department will pay for the alternate method at the unit price for **Cofferdams** or **Cofferdams, Left in Place**.



**Section 705. FOUNDATION PILING**

**705.01. Description.** This work consists of providing and driving timber piles, cast-in-place concrete piles, and steel piles. The following definitions apply to this work:

**Absolute Refusal.** The nominal pile driving resistance value of 150 percent of the nominal pile driving resistance shown on the plans.

**CIP.** In this section, the abbreviation for cast-in-place.

**Design Pile Length.** The pile length shown on the plans.

**Design Pile Tip Elevation.** The pile tip elevation if the design pile length is shown on the plans.

**Dynamic Formula.** Empirical formula to estimate Nominal Pile Driving Resistance during pile driving. The FHWA Gates formula is specified.

**Dynamic Testing.** High strain dynamic testing during pile driving to estimate Nominal Pile Driving Resistance using instrumentation and signal-matching computer software.

**Estimated Pile Length.** The length shown on the plans used as a guide for estimating the work and ordering test piles if the nominal pile driving resistance is shown on the plans.

**Estimated Pile Tip Elevation.** The elevation shown on the plans, estimated for piles to develop the nominal pile driving resistance.

**Manufacturer.** The company that manufactures the pile driving equipment including hammers and appurtenances.

**Minimum Pile Length.** The length between pile cutoff elevation and minimum pile penetration elevation shown on the plans.

**Minimum Pile Penetration Elevation.** The elevation shown on the plans that the bottom of piles must be driven to, or below.

**Nominal Pile Driving Resistance.** Nominal pile driving resistance measured during pile driving with the dynamic formula or dynamic testing methods in kips, as shown on the plans.

**Ordered Pile Length.** The length determined from test pile results. For timber piles, the Engineer will determine the ordered length. For cast-in-place concrete piles and steel piles, the Contractor will determine the ordered length.

**Practical Refusal.** A nominal pile driving resistance value of 110 percent of the nominal pile driving resistance shown on the plans.

**Prebore Elevation.** The elevation designated for stopping preboring, as shown on the plans.

**Production Piles.** Piles other than test piles.

**Spuds.** Short, strong, driven members, removed to make holes for inserting piles.

**Test Pile.** A pile driven at a location shown on the plans to determine pile driving characteristics. The Engineer will certify Nominal Pile Resistance of a test pile using a static load test, dynamic formula, or dynamic testing methods.

**705.02. Materials.** Provide materials in accordance with the following:

|  |                     |
|--|---------------------|
| Concrete, Grade S1, .....                          | <a href="#">701</a> |
| Granular Material, Class II.....                   | <a href="#">902</a> |
| Steel Reinforcement .....                          | <a href="#">905</a> |
| Foundation Piles.....                              | <a href="#">906</a> |
| Water .....  | <a href="#">911</a> |
| Treated Timber Piles .....                         | <a href="#">912</a> |
| Pile Points (including Shoes and End Plates) ..... | <a href="#">906</a> |

Provide new or used steel piles, consisting of the rolled structural steel shapes meeting yield strengths shown on the plans or the Engineer's authorization. Provide used steel piles in good condition, as approved by the Engineer. Provide new steel shells for watertight Cast-In-Place (CIP) Concrete Piles.

Provide steel reinforcement meeting the yield strength shown on the plans.

Provide full length treated timber piles.

Provide Concrete, Grade S1 for CIP Concrete Piles.

**705.03. Construction.**

A. **Piling.**

1. **Storage and Handling of Piles.** Store piles off the ground with cribbing to prevent bending or distorting the piles.

Store and handle piles to prevent dirt, water, or other deleterious material from entering steel shells for CIP concrete piles.

Handle timber piles in accordance with subsection [709.03](#).

2. **Equipment.** Size pile driving equipment to drive production and test piles without damage, in accordance with this subsection. Do not use driving equipment that damages the piling.

Obtain advance approval from the Engineer for pile driving equipment, including the pile driving hammer, hammer cushion, helmet, pile cushion, and other appurtenances. Submit a description of pile driving equipment to the Engineer at least 21 calendar days before beginning pile driving. The Engineer will evaluate the proposed driving system using the dynamic formula, the wave equation analysis, or both.

The Engineer will use the required number of hammer blows per inch, and the pile driving stresses over the entire driving process to evaluate pile driving equipment.

Select pile driving equipment that installs piles at a rate from two blows per inch to 10 blows per inch, at the required nominal pile driving resistance, for every method of pile resistance certification.

For preliminary hammer selection purposes, the Contractor may estimate the minimum and maximum hammer energy as follows:

$$E_d \geq 0.082(R_{ndr} + 100)^2 \quad \text{Formula 705-1}$$

$$E_d \leq 0.193(R_{ndr} + 100)^2 \quad \text{Formula 705-2}$$

Where:

$R_{ndr}$  = Nominal pile driving resistance measured during pile driving in kips.

$E_d$  = Energy developed by the hammer per blow in foot-pounds.

For pile stresses determined by wave equation analysis, do not exceed the maximum pile driving stresses specified in Table 705-1 for the entire driving operation.

| Table 705-1<br>Maximum Pile Driving Stress |                             |
|--|-----------------------------|
| Pile Material                              | Maximum Pile Driving Stress |
| Steel                                      | 90% of the yield strength   |
| Timber                                     | 3.1 ksi ( $F_{co} = 0.9$ )  |

The Engineer will predict pile stresses for vertical piles using wave equation analysis, based on hammer efficiencies specified in Table 705-2.

| <b>Hammer Type</b>                                   | <b>Efficiency (%)</b> |
|--|-----------------------|
| Drop   | 25 – 40               |
| Single Acting Air                                    | 67                    |
| Double Acting Air                                    | 50                    |
| Diesel   | 80                    |
| Hydraulic or Diesel with Built-in Energy Measurement | 95                    |

The Engineer will notify the Contractor of acceptance or rejection of the driving system within 14 calendar days of receiving the Pile and Driving Equipment Data Form. If the Engineer rejects the driving system, modify or replace the proposed methods or equipment, at no additional cost to the Department.

Use the approved system during pile driving operations. Submit revised pile driving equipment data to the Engineer for review and acceptance before changing driving system. The Engineer will notify the Contractor of acceptance or rejection of the driving system changes within five working days of the Engineer's receipt of the requested change. The Department will not grant a time extension for time required for submission, review, and approval of a revised driving system.

The Engineer's approval of pile driving equipment does not relieve the Contractor of responsibility to drive piles without damage to the required nominal pile driving resistance and the minimum pile penetration elevation shown on the plans.

Use air, diesel, or hydraulic hammers to drive piles.

- a. **Drop Impact Hammers.** The Contractor may use drop impact hammers to drive timber piles, if allowed by the contract.

Do not use drop hammers for piles where the required nominal pile driving resistance exceeds 200 kip. If the contract allows drop hammers, ensure the ram weighs at least 2.0 kip and the height of drop is no greater than 12 feet. Do not use a ram weight less than the combined weight of the helmet and the pile. Equip drop hammers with hammer guides and a helmet to ensure concentric impact.

- b. **Air Impact Hammers.** Operate air hammers within the manufacturer's specified ranges. Provide the Engineer with the hammer specifications to determine the energy developed by the hammer with each blow. Use striking parts that weigh at least 2.75 kip and at least  $\frac{1}{3}$  the combined weight of pile and helmet.

Provide the power plant and equipment for air hammers with a capacity capable of maintaining, under working conditions, the air volume and pressure at the hammer, as specified by the manufacturer. Equip the power plant and equipment with accurate pressure gauges, easily accessible to the Engineer.

Connect the compressor to the hammer with a hose of at least the minimum size recommended by the manufacturer.

The Engineer will evaluate hammer performance at the end of driving by measuring blows per minute and comparing with the manufacturer's recommendations. Measure the blow rate using an automatic measuring device.

- c. **Diesel Impact Hammers.** For open-end, single acting hammers, provide the Engineer with a chart from the hammer manufacturer equating stroke and blows per minute. The Engineer will determine the average hammer stroke at the end of drive from the blow rate in blows per minute or by using an automatic measuring device to determine average hammer stroke. Equip open-end diesel hammers with rings, or other device on the ram to allow the Engineer to visually determine hammer stroke during pile driving operations.

Equip closed-end, double acting hammers with a bounce chamber pressure gauge, mounted near ground level and easily accessible to the Engineer. Provide a correlation chart of bounce chamber pressure and potential energy. The Engineer will determine the average hammer stroke at the end of drive from bounce chamber pressure.

- d. **Hydraulic Impact Hammers.** Operate hydraulic hammers within the manufacturer's specified ranges. Provide a power plant for hydraulic hammers with a capacity capable of maintaining the hydraulic volume and pressure specified by the manufacturer. Equip the power plant with pressure gauges, easily accessible to the Engineer.

Equip hydraulic hammers with an energy readout device. Provide wave equation analysis to the Engineer indicating the nominal pile driving resistance of the pile. The Engineer will use the wave equation analysis to determine the capability of the hammer. Do not use Formula [705-1](#) through Formula [705-5](#) for calculating the nominal pile driving resistance.

- e. **Non-Impact Hammers.** Do not use non-impact hammers, including vibratory hammers, or driving aids, followers, and

prebored holes unless approved by the Engineer in writing or stated in the contract.

3. **Additional Equipment or Methods.** If using a hammer specified in subsection [705.03.A.2](#) does not obtain the minimum pile penetration elevation, provide a hammer of greater energy or, if approved by the Engineer, use supplemental methods, such as preboring. The Engineer will conduct additional wave equation analyses for the new hammers to assess predriving pile stresses in accordance with subsection [705.03.A.2](#).

## B. Driving Appurtenances.

1. **Hammer Cushion.** Equip impact pile driving equipment with a hammer cushion to prevent damage to the hammer or pile, except drop hammers and hammers designed for use without hammer cushions.

Provide hammer cushions fabricated from durable manufactured materials that will retain uniform properties during driving. Do not use wood, wire rope, or asbestos hammer cushions. Place a striker plate on the hammer cushion to ensure uniform compression of the cushion material.

Remove the hammer cushion from the helmet and inspect in the presence of the Engineer before beginning pile driving at each structure or after each 100 hours of pile driving, whichever is less. Replace the hammer cushion if the thickness is reduced more than 25 percent of the original thickness before continuing driving.

2. **Helmet.** Fit piles with a helmet to distribute the hammer blow uniformly and concentrically to the pile top. Ensure the helmet surface, contacting the pile, is planed and smooth and aligned parallel with the hammer base and the pile top. Guide the helmet with leads; do not allow it to swing freely. Fit the helmet to the pile top to maintain the hammer and pile in concentric alignment.

For timber piles, do not allow the least inside horizontal dimension of the helmet or hammer base to exceed the pile top diameter by more than 2 inches. Trim the pile top to fit the helmet if the timber pile diameter exceeds the least helmet or hammer base horizontal dimension. Do not trim the pile top below the cutoff elevation.

3. **Pile Cushion.** If CIP concrete piles require redriving after concrete placement and curing inside steel shells, protect pile tops with a pile cushion. Proportion the pile cushion to distribute the blow of the hammer throughout the cross-section of the pile.

4. **Leads.** Use pile driving leads that align the pile and hammer in positions throughout the driving operation. Use leads constructed to allow free movement of the hammer and maintain hammer and pile alignment to ensure concentric impact. Use leads designed to allow alignment of battered piles, if required. Do not allow the driven pile section to extend above leads.

Provide fixed or swinging type leads. Fit swinging leads with a pile gate at the bottom of the leads. Use leads embedded in the ground or constrain the pile in a structural frame to maintain alignment. Provide leads with a length that eliminates the need for a follower.

5. **Followers.** Use followers only if the Engineer approves in writing, or required by the contract. If the Engineer does not perform a wave equation analysis, use a follower with impedance from 50 percent to 200 percent of the pile impedance.

Maintain the follower and pile in alignment during driving. Drive the first pile in each bent, and every tenth pile full length without a follower to ensure pile penetration develops the required nominal pile driving resistance. Use a follower constructed of material and dimensions to allow pile driving to the penetration depth determined by driving the full-length piles. Verify the final position and alignment of the first two piles in each substructure unit, installed with followers meet location tolerances specified in subsection [705.03.C.2.e](#), before installing additional piles.

6. **Spud.** The Engineer will not allow spuds in lieu of preboring.

C. **Driving Methods.**

1. **Preparation for Driving.** Before driving, cut pile tops square with the axis of the pile. Use collars, bands, or other devices to protect timber piles against splitting and brooming.
- a. **Excavation and Fill.** Do not drive, or redrive piles until completion of excavation, fill, or both, unless otherwise required. If piles require driving or re-driving through fills, compact the embankment to the bottom of the concrete substructure unit before driving piles. Remove material forced up between the piles to the required elevation before placing concrete foundation.
- b. **Pile Preboring to Facilitate Driving.** Prebore holes to the prebore elevation shown on the plans. Provide a finished hole with a diameter equal to or no more than 6 inches greater than the diameter of the pile.

Maintain a stable, open hole until pile installation to the bottom of the bore. Do not begin final drive for bearing until the pile reaches the prebore elevation shown on the plans. Control caving or unstable soil layers using temporary casing or non-toxic and non-hazardous drilling slurry. Handle and dispose of drilling slurry on the project, or at an off-site location where structures will be unaffected, in accordance with 1994 PA 451, Part 91 Soil Erosion and Sedimentation Control. Obtain the Engineer's approval for on-site disposal.

Remove or clear boulders, cobbles, or other obstructions. Provide rock chisels, extractors, core barrels, or other equipment to clear obstructions.

To the extent possible, complete preboring in a foundation unit and advance piles to the prebore elevation, before beginning the final drive. If preboring within 20 feet of a completed pile, recheck the pile capacity by restriking the pile. The Engineer will select the piles for restrike. Restrike with the same driving equipment from the initial installation. If a reduction in capacity occurs, redrive piles to the nominal pile driving resistance.

Backfill voids after the final drive with granular material Class II or a Department-approved equal.

Prebore pile holes within a vertical tolerance of  $\frac{1}{4}$  inch per foot, or within the batter line shown on the plans. Upon completion, ensure the center of the hole at cutoff elevation is within 6 inches of the position shown on the plans.

Unless otherwise shown on the plans, if driving piles through compacted fill deeper than 5 feet, drive piles in holes prebored to natural ground.

2. **Driving.** During driving, maintain pile tops square with the axis of the pile.
  - a. **Obstructions.** If an impenetrable obstruction is encountered during pile driving, remove and reuse the pile, or cut the pile off and drive a new pile.

If removing a pile, reuse as approved by the Engineer, adjust the pile laterally, and redrive in accordance with subsection [705.03.C.2.e.](#)

If cutting off a pile, cut the pile at the lowest possible elevation and drive another pile, adjusted laterally. Drive the new pile in accordance with subsection [705.03.C.3.e.](#)



If removing and adjusting, or cutting off and adjusting a pile, does not bypass the obstruction, remove the obstruction. Provide rock chisels, extractors, core barrels, or other equipment to clear obstructions.

- b. **Penetration.** For design pile lengths, install piles to the design pile tip elevation shown on the plans, unless driving operations attain absolute refusal.

If the plans show the estimated pile length, install piles to a penetration that meets the following:

- i. The nominal pile driving resistance equals at least the required nominal pile driving resistance shown on the plans; and
- ii. The bottom of the pile is at or below the minimum pile penetration elevation shown on the plans.

Do not drive piles past absolute refusal unless Dynamic Testing is required. If Dynamic Testing is required, ensure pile stresses do not exceed the stresses specified in Table [705-1](#), as determined by the Engineer.

- c. **Test Piles.** If test piles are required by the contract, use the pile lengths shown on the plans for estimating purposes. Provide actual pile lengths to achieve the required nominal pile driving resistance and minimum pile length. If test piles are not required, provide the piles in accordance with the design pile length shown on the plans.

Complete the excavation or embankment to within 2 feet of the proposed grade at test pile locations. Install test piles at locations shown on the plans with approved impact hammer equipment. Drive test piles to the minimum pile length or absolute refusal, whichever is greater.

The Engineer may stop test pile driving at tip penetrations greater than 10 feet below the estimated pile tip elevation to check for soil setup.

If test piles fail to achieve the required nominal pile driving resistance after driving 10 feet below the estimated pile tip elevation, but the resistance reaches at least 85 percent of the required nominal pile driving resistance, leave piles in place for at least 48 hours to allow soil setup, unless otherwise directed by the Engineer.

After the waiting period, restrike the test pile to check the nominal pile driving resistance. The Engineer will determine the nominal pile driving resistance after soil setup based on the number of restrike blows necessary to drive the pile an additional 3 inches. Use a hammer for restriking piles, warmed up by applying at least 20 blows to another pile at least 25 feet away from the restrike pile, or as approved by the Engineer. The Engineer will accept restrike piles if they exhibit a nominal pile driving resistance greater than the resistance required.

After restriking, continue test pile driving, providing piling, splices, and restrikes until the nominal pile driving resistance measured during driving reaches practical refusal, or until the Engineer stops driving. The Engineer will prepare a record of test pile driving, including the number of hammer blows per foot for the driven length, the as-driven length of the test pile, cutoff elevation, penetration in ground, and other pertinent information.

Cut off test piles, driven in production pile locations and incorporated in the structure as permanent piles. Cut off or pull test piles, not driven in production pile locations, as directed by the Engineer.

Determine the ordered pile lengths of steel H-piles and CIP concrete piles from the test pile results. Provide CIP pile shell and steel pile lengths to obtain the required nominal pile driving resistance and penetration.

The Engineer will evaluate test pile results and determine the ordered pile lengths for timber piles.

The Engineer will not require test piles if the plans show a design pile length.

- d. **Splicing.** Do not splice timber piles. Provide steel piles in full length sections or splice them as shown on the plans, or approved by the Engineer.

The Contractor may provide piling and field splices, as required to obtain the required nominal pile driving resistance and penetration.

Weld in accordance with AWS D1.1 and subsection [707.03.D.8.b](#), subsection [707.03.D.8.c](#), and subsection [707.03.D.8.d](#), with the temperature exceptions specified in this subsection. The Contractor may use E7015, E7016, or E7018

electrodes provided they are stored and used in accordance with AWS requirements.

Do not perform field welding if the ambient temperature is below 0 °F. If the pile metal temperature falls below 32 °F, preheat the pile metal in the area of the weld to at least 70 °F, and maintain the temperature during welding. Employ welders certified by agencies approved by the Department.

Remove slag from all weld passes including finished welds. For fillet welds, verify weld size by using a fillet weld gage witnessed by the Engineer. Non-destructive testing of the pile splices by the Contractor is not required unless visual inspection by the Engineer indicates unacceptable welds.

- e. **Accuracy.** Drive piles for foundation work within ¼ inch per foot from the vertical or batter line shown on the plans. After driving, ensure the position of each pile at the cutoff elevation is within 6 inches of the position shown on the plans. Ensure a distance of at least 9 inches between the edges of piles and the outline of the superimposed concrete.

Drive pile bents to allow the adjustment of piles to the positions and elevations shown on the plans without damaging or overstressing piles. Do not pull laterally on piles to correct misalignment, or splice an aligned section on a misaligned section.

Drive timber piles to allow adjustment to the position shown on the plans at the elevation of cap or wale, without damaging or overstressing piles. Draw and hold piles requiring capping, in position before cutoff. If the pile cutoff diameter is greater than the width of the cap, trim the pile to eliminate horizontal projections outside the cap.

Do not drive timber piles to the exact grade shown on the plans; cut them off below the tapered head to provide an unfractured, bearing with a full cross section of the pile.

Increase pile cap dimensions or reinforcing to accommodate out-of-position piles at no additional cost to the Department.

- f. **Redriving of Heaved Piles.** At the start of pile driving operations, the Engineer will make level readings to measure pile heave after driving until the Engineer determines checking is no longer required. If piles heave up during driving adjacent piles, redrive heaved up piles to the required bearing capacity or

penetration. Adjust upheaval or settlement of material between the piles to the correct elevation before placing concrete for the foundation.

If the Engineer detects pile heave for CIP concrete pile shells filled with concrete, redrive the piles to the original position after concrete obtains the required strength using a pile cushion system, approved by the Engineer.

#### D. Determination of Nominal Pile Resistance.

1. **Static Load Test.** Perform load tests as required. Refer to the contract for load testing details.
2. **Dynamic Formula.** Do not use the dynamic formula to install production piles with a required nominal pile driving resistance greater than 600 kip, or if the contract requires dynamic testing with signal matching.

The Engineer will determine the nominal pile driving resistance for test piles using the same method specified for production piles.

$$R_{ndr} = 1.75\sqrt{E_d} \log_{10}(10N_b) - 100 \quad \text{Formula 705-3}$$

Where:

$N_b$  = Number of hammer blows per inch of pile penetration;

$E_d$  = Energy developed by the hammer per blow in foot-pounds; and

$R_{ndr}$  = Nominal pile driving resistance measured during pile driving in kips.

The Engineer will determine the value of “ $E_d$ ”. For piles driven on a batter, multiply the value of “ $E_d$ ” by the hammer energy reduction coefficient “ $U$ ” as follows:

$$U = \sin(\alpha) 0.975 \quad \text{Formula 705-4}$$

$$\alpha = \tan^{-1}(m) \quad \text{Formula 705-5}$$

Where:

$U$  = Hammer energy reduction coefficient, less than unity;

$\alpha$  = Angle of batter from horizontal (less than 90 degrees for battered piles); and

$m$  = Vertical component of batter.

For drop, single acting air hammers, and open type diesel hammers, the Engineer will measure the ram velocity using the kinetic energy. If measuring ram velocity is not possible, the Engineer may approximate the velocity using the potential energy calculated by multiplying the weight of hammer striking parts by the observed fall or stroke height.

For double acting air hammers and closed type diesel hammers, the Engineer will calculate the energy using ram weight and bounce chamber pressure. Submit hammer literature and correlation charts to the Engineer to determine the hammer energy of each blow. The Engineer will reduce the calculated value of " $E_d$ " for battered piles by the hammer energy reduction coefficient " $U$ " before calculating the nominal pile driving resistance.

Formula [705-3](#), Formula [705-4](#), and Formula [705-5](#), for piles driven with a drop hammer are applicable under the following conditions:

- a. Hammers have an unrestricted free fall;
- b. Pile tops are not broomed, crushed, or splintered;
- c. The hammer exhibits no appreciable bounce after striking the pile; and
- d. Penetration is at a uniform or uniformly decreasing rate.

If required, or if using a hydraulic hammer, the Engineer will determine the nominal pile driving resistance using the results of a wave equation analysis. The Engineer will consider the hammer driving system, site-specific subsurface data, and project pile geometry, to develop driving criteria that will not overstress the pile and indicate the nominal pile driving resistance.

3. **Dynamic Testing and Analysis.** Perform dynamic testing with signal matching as required by the contract.

E. **Defective Piles.** Protect piles from splitting, splintering and brooming of the wood, or excessive deformation of the steel. Do not manipulate piles to force them into position using excessive force, as determined by the Engineer.

At no additional cost to the Department, use one of the following methods to correct piles damaged by internal defects, driven improperly, driven below the cutoff elevation determined by the Engineer or as required, or piles driven outside the required location:

1. Withdraw the pile and replace with a new, longer pile;
2. Drive a second pile adjacent to the defective or low pile; or

3. Splice or build up the pile or extend a portion of the footing to properly embed the pile.

**F. Placing Concrete in Cast-in-Place Concrete Piles.** Before placing concrete, inspect piles to confirm the full pile length and dry bottom condition. Provide a mirror or light for inspection.

Do not place concrete in piles until after driving, re-driving, cleaning, and obtaining the Engineer's acceptance of pile shells within a radius of 20 feet. Place the concrete in the pile shells to the cutoff elevation as soon as practical after driving.

Place concrete in accordance with subsection [706.03.H](#), except concrete may free-fall more than 5 feet. During placement, vibrate the concrete in the upper  $\frac{1}{3}$  of the pile shell, to a depth no greater than 25 feet, without causing segregation.

**G. Protective Coating for Steel Piles and CIP Concrete Piles.** If required, galvanize steel H-piles and steel shells exposed to air or water in the finished structure, in accordance with ASTM A 123.

Do not use corrosive embankment material within 30 feet of piles. Repair damage to galvanization in accordance with subsection [716.03.E](#) at no additional cost to the Department.

**H. Cleaning Steel Piles and Steel Pile Shells.** If embedding steel piles or pile shells at least 1 foot or more in structural concrete, exclusive of tremie concrete, clean dirt and loose scale from the portion requiring embedding.

**I. Pile Cutoff.** Cut off piles normal to the longitudinal axis of the pile and within 1 inch of the elevation required and anchor to the structure as required by the contract.

Take possession of piling cutoff lengths. Dispose of cutoff lengths in accordance with local, state, and federal regulations.

Cut off timber piles to completely remove material damaged by driving.

#### **705.04. Measurement and Payment.**

| <b>Pay Item</b>                               | <b>Pay Unit</b> |
|---|-----------------|
| Pile, Treated Timber, Furn.....               | Foot            |
| Pile, Treated Timber, Driven.....             | Foot            |
| Pile, CIP Conc, Furn and Driven, __ inch..... | Foot            |
| Pile, Steel, Furn and Driven, __ inch.....    | Foot            |
| Pile, Galv, (Structure No.).....              | Lump Sum        |
| Test Pile, Treated Timber.....                | Each            |
| Test Pile, CIP Conc, __ inch.....             | Each            |

|  |          |
|--|----------|
| Test Pile, Steel, ___ inch.....                    | Each     |
| Pile Point, CIP Conc.....                          | Each     |
| Pile Point, Steel.....                             | Each     |
| Prebore, Fdn Piling.....                           | Foot     |
| Pile Driving Equipment, Furn, (Structure No.)..... | Lump Sum |

**A. Piles.**

1. **Driven Piles.** The unit prices for **Pile, CIP Conc, Furn and Driven, \_\_\_ inch**, and **Pile, Steel, Furn and Driven, \_\_\_ inch**, include the cost of restrrike due to preboring.

For piles removed, adjusted, and reused, due to obstructions, the Engineer will measure the total length of the pile driven, including the length of pile embedded in the ground and removed. For piles that require cutting off due to obstructions, the Engineer will measure the total length of the new pile driven, including the length of obstructed pile cut off and left in the ground.

Payment for initial restrrike is included in pay item Test Pile. The Department will pay for subsequent restrrikes, if necessary, as extra work. The Department will pay for pile restrrike for production piles as extra work unless the Contractor chooses to stop driving, wait and restrrike or redrive piles to achieve the required nominal pile driving resistance. If the Contractor chooses to restrrike or redrive piles, no payment will be made for the restrrikes or redrive.

The Department will pay for re-driving heaved piles as extra work.

The Engineer will measure **Pile, Treated Timber, Driven** by the piling length left in place below cutoff. The unit price for **Pile, Treated Timber, Driven** includes the cost of cutting off piles. Cutoff material will remain the property of the Contractor.

The Engineer will measure **Pile, CIP Conc, Furn and Driven**, and **Pile, Steel, Furn and Driven**, by the length of piling left in place below cutoff.

The unit prices for **Pile, CIP Conc, Furn and Driven**, and **Pile, Steel, Furn and Driven** include the cost of providing ungalvanized pile shells or steel piles, and the cost of driving the galvanized pile length.

The unit prices for **Pile, CIP Conc, Furn and Driven**, and **Pile, Steel, Furn and Driven** do not include the cost of the length of the pile point extending beyond the pile.

The unit prices for furnished and driven pile pay items include the cost of splices.

2. **Pile, Treated Timber, Furnished.** The Department will pay for **Pile, Treated Timber, Furn**, at the ordered pile length.
3. **Galvanized Piles.** The unit price for **Pile, Galv**, includes the cost associated with galvanizing the required length of pile as shown on the plans.
4. **Pile Driving Equipment.** The Engineer will measure **Pile Driving Equipment, Furn** as a unit for each structure. The unit price for **Pile Driving Equipment, Furn**, includes the cost of providing and removing equipment for driving piles.

The unit price for the length of pile driven includes the cost of operating equipment for driving piles.

5. **Prebore Foundation Piling.** The Engineer will measure **Prebore, Fdn Piling**, from the bottom of the foundation to the prebore elevation shown on the plans. The unit price for **Prebore, Fdn Piling** includes the cost of the following:
  - a. Boring pile holes;
  - b. Disposing of excavated material;
  - c. Backfilling voids;
  - d. Installing and removing temporary casings;
  - e. Providing and disposing of drilling slurry;
  - f. Restriking completed piles within a radius of 20 feet; and
  - g. Equipment operating costs.

If **Prebore, Fdn Piling**, is shown on the plans, the unit price for **Pile Driving Equipment, Furn** includes the cost of providing equipment for prebore. If the plans do not show preboring, but the Engineer authorizes preboring in writing, the Department will pay for providing equipment as extra work.

6. **Pile Points.** If the contract includes the pay item **Pile Points**, the Department will pay separately for **Pile Points**, of the type required. If the plans do not include **Pile Points**, but the Engineer requires pile points, the Department will pay for pile points as extra work.
7. **Test Piles.** The Department will pay for test piles in addition to the contract unit prices for furnished and driven pile pay items.

The unit prices for **Test Pile**, of the type required, include the cost of initial restrike. The Department will pay for subsequent restrikes as extra work.



705.04

B. **Obstruction Removal.** The Engineer will measure and the Department will pay for the removal of obstructions, which require the use of special equipment or tools specified in subsection [705.03.C.2.a](#), at the unit price for **Obstruction Removal**, in accordance with subsection [718.04.D](#).

## Section 706. STRUCTURAL CONCRETE CONSTRUCTION

**706.01. Description.** This work consists of constructing concrete portions of bridges, box, and slab culverts, headwalls, retaining walls, and other structures, and providing and installing electrical grounding systems.

**706.02. Materials.** Provide materials in accordance with the following:

|  |                     |
|--|---------------------|
| Concrete, Grades S2, T, D .....                    | <a href="#">701</a> |
| Mortar and Grout .....                             | <a href="#">702</a> |
| Curing Materials .....                             | <a href="#">903</a> |
| Insulating Blankets .....                          | <a href="#">903</a> |
| Polystyrene Insulation .....                       | <a href="#">903</a> |
| Steel Reinforcement .....                          | <a href="#">905</a> |
| Bar Chairs and Wire Ties .....                     | <a href="#">905</a> |
| Structural Steel .....                             | <a href="#">906</a> |
| Miscellaneous Metal Products .....                 | <a href="#">908</a> |
| Geosynthetics .....                                | <a href="#">910</a> |
| Water .....  | <a href="#">911</a> |
| Fiber Joint Filler for Concrete Construction ..... | <a href="#">914</a> |
| Joint Sealants for Concrete Construction .....     | <a href="#">914</a> |
| Conduit .....                                      | <a href="#">918</a> |
| Electrical Grounding System .....                  | <a href="#">918</a> |

Provide Grade T concrete for structure concrete placed under water. Unless otherwise required by the contract, provide Grade S2 for other structure concrete.

Provide Grade S2 concrete for substructure concrete.

Provide 6AA natural aggregate and with no greater than 2.50 percent absorption as specified in ASTM C 127 for Grade D superstructure concrete and Grade D superstructure concrete, night casting. Do not use slag aggregate.

Provide AASHTO M 270, Grade 36 steel, galvanized in accordance with section [707](#), for expansion joint cover plates. Provide plates at least  $\frac{3}{8}$  inch thick with a static coefficient of friction of at least 0.6. Provide ASTM F 593 (Type 304) stainless steel,  $\frac{3}{4}$ -inch diameter, flathead countersunk screws with  $\frac{3}{4}$ -inch diameter inserts for use in expansion joint cover plates.

Refer to Section [701](#), Table [701-1](#), and the contract for minimum flexural and compressive strengths of concrete.

**706.03. Construction.****A. Equipment.**

1. **Placing Equipment.** Provide equipment with capacity and arrangement for placing concrete in accordance with subsection [706.03.H](#). Make equipment available to the Engineer for inspection, testing, and approval before use.

Use a tremie, pump, or other Engineer-approved equipment for placing concrete under water.

If placing concrete with a tremie, provide a tremie with a capacity of at least 7 cubic feet, with a watertight discharge tube at least 10 inches in diameter. Equip the lower end of the tremie with a valve or suitable device capable of closing tightly while charging and lowering the tremie into position, and opening fully in the lowered position.

If pumping concrete, provide a pump discharge, pipe, and fittings with an inside diameter of at least 4 inches. Do not use aluminum pipe for conveying or placing concrete.

2. **Bridge Deck Finishing Equipment.** Provide a self-propelled, transverse finishing machine capable of finishing concrete from curb to curb or from curb to bulkhead. Equip bridge deck finishing machines with rotating finishing cylinder(s), auger(s), drag float, and other structural and mechanical equipment to finish the concrete within the required tolerances.

Provide a machine or supporting frame to transversely span the cast section and travel in the direction of concrete placement. Mount the machine on wheels operated on longitudinal rails capable of carrying the loads between supports with a deflection no greater than  $1/16$  inch. Use rail sections, straight within  $1/8$  inch per foot, and rail grades that differ from the required screed grade by no more than  $1/16$  inch. Install the rail at a height above the surface allowing hand floating under the rails. Mount each rail on adjustable supports that prevent deflection under the machine load.

Place rail supports over beams. Use portable, lightweight, or wheeled work bridges capable of transversely spanning the cast section to transversely finish machine-finished deck sections.

Provide a 3-foot, lightweight metal float and a 10-foot, lightweight, rigid straightedge, each equipped with a suitable handle. The Contractor may use truss type vibrating screeds if approved by the Engineer.

3. **Concrete Saws.** Use a self-propelled saw to neatly cut hardened concrete to the line and depth required.
  4. **Texturing Equipment.** Use texturing equipment to produce uniform transverse grooves of the required width, depth, and spacing.
  5. **Equipment for Applying Penetrating Water Repellent Material.** Apply penetrating water repellent material with low pressure, 15 psi to 40 psi, airless-type spray equipment or with long-nap rollers.
  6. **Equipment Approval.** Obtain the Engineer's approval for all equipment and tools for placing and finishing of concrete before starting work including, but not limited to, pumping equipment, air compressors, vibrators, joint sealing equipment, straightedges, and finishing tools.
- B. **False Decking.** Construct false decking to the limits shown on the plans.

Construct false decking capable of supporting all material and debris falling from the deck. Abut false decking pieces to prevent material or debris from falling through. Use a false decking system that does not damage beams and meets the approval of the Engineer.

Install false decking after erecting structural steel or precast concrete beams, or before beginning deck removal, repair, or other bridge construction activities. Do not construct false decking systems over traffic that project below beam bottom flanges. Maintain false decking to prevent hazards to vehicular, pedestrian, or waterway traffic. Remove material or debris on the flooring outside the fascia at least once per day. Leave false decking in place until completion of construction activity, as directed by the Engineer.

For bridges over waterways, the Contractor may use a barge in the waterway in place of constructing a false decking system over the waterway. Position the barge in the waterway after erecting the structural steel or precast concrete beams, or before beginning deck removal, deck repair, or bridge construction activities. Maintain the barge to prevent hazards or impediments to waterway traffic. Provide a barge large enough to support material and debris falling from the deck. Leave the barge in place until completion of the bridge construction, as directed by the Engineer. If the Engineer determines the barge is ineffective in preventing falling material and debris from entering the waterway, replace it with a conventional false decking system at no additional cost to the Department.

C. **Falsework.** Design, construct, place, and remove temporary supports required for constructing the permanent structure. Weld form supports in accordance with subsection [707.03.D.8](#).

Submit working drawings and design calculations for falsework in accordance with subsection [104.02](#). The Engineer will review the falsework and forms before concrete placement. The Engineer's review does not relieve the Contractor of responsibility for the design.

Correct settlement in the falsework during loading.

#### D. **Forming.**

1. **General.** Construct forms true to the lines shown on the plans. Construct mortar-tight forms with net sections capable of withstanding impacts during placement and of supporting the weight of concrete through curing. Use falsework for forms in accordance with subsection [706.03.C](#).

2. **Vertical Clearance.** The Department defines minimum under-clearance as the minimum vertical distance from any point on the pavement, including 24 inches either side of the pavement, to the structure.

Maintain form work above the bottom of beams. If form work must extend below the bottom of beams, obtain the Engineer's approval. Provide and place advance-warning signs at locations directed by the Engineer before changing the existing structure under-clearance. Provide 10 working days for the Engineer to determine the locations for the advance warning signs.

3. **Removable Forms.** The Department designates surfaces formed with removable forming material as Type A, or Type B.

a. **Type A Surface.** Type A surfaces are exposed surfaces of piers, abutments, wing walls, retaining walls; and the outside faces of girders, T-beams, slabs, columns, brackets, curbs, headwalls, barriers, railings, arch rings, spandrel walls, and parapets.

Use metal forms or 5-ply structural grade western fir plywood for face forming material. If the grain of three plies of the plywood runs perpendicular to the studs, the Engineer will consider the  $\frac{25}{32}$  inch thickness to meet 1-inch nominal thickness.

The Engineer will allow dressed shiplap or square edged lumber, sized four sides, at least  $\frac{3}{4}$  inch thick, covered by form lining, in lieu of structural plywood for form lumber. Provide metal,

composition, or plywood form lining for shiplap or square edged lumber. Provide composition or plywood lining at least  $\frac{1}{4}$  inch thick.

The Engineer will approve the sizing, spacing, and dimensions of metal, composition, or special plywood forms, and allow continued use based on performance.

The Engineer may modify the requirements for pattern and minimum lumber thickness for curved Type A surfaces. Ensure that inside faces of forms for Type A surfaces are free of holes, irregularities, or unevenness.

- b. **Type B Surface.** Type B surfaces are formed concrete surfaces that will not be exposed in the finished work; the bottoms of floor slabs and sidewalk; the sides of interior beams and girder; backwalls above the bridge seat; and exposed surfaces not included in Type A surfaces.

Use metal forms or face forming material at least  $\frac{3}{4}$  inch thick for Type B surfaces.

The Contractor may use material allowed for Type A surfaces for Type B surfaces, except square edge lumber for forming horizontal surfaces is prohibited. Form lining is not required for shiplap and square edge lumber.

- c. **Type A and B Surfaces.** Do not use forms and face form material with defects for Type A or Type B surfaces.

For Type A surfaces, space studs no greater than 12 inches apart, center-to-center. For Type B surfaces, space studs no greater than 24 inches apart, center-to-center. Provide nominal 2 inch by 6 inch or nominal 4 inch by 4 inch sections, except the Engineer will allow nominal 2 inch by 4 inch studs for pours no greater than  $3\frac{1}{2}$  feet in height from the bottom of the pour to the top of the pour. Cap studs with a straight top plate at least the size of the Engineer-approved studs.

Scab all joints in plates 4 feet each way to provide continuity.

Ensure constructed forms remain true to shape. Countersink bolts and rivet heads on the inside face of the forms.

Design clamps, pins, or other connecting devices to hold forms rigidly together and allow removal without damage to the concrete. Do not use metal forms that do not present a smooth

surface or that do not line up properly. Maintain metal forms free of rust, grease, or other material that may discolor concrete.

Scab wales to prevent distortion during concrete placement and curing. Place a row of wales within 6 inches of the bottom of each pour, unless studs extend below the bottom of the pour secured by wales fastened to rods in the previous pour.

- d. **Construction.** Brace forms to prevent movement during concrete placement. Do not use mechanical or adhesive methods, which will be exposed in the completed structure, to secure forms to concrete bridge decks or pavements. Finish corners square, without moldings. For exposed concrete faces, saw the form edges at corners square and straight, and place them to form a tight fit. Form chamfered corners with dimensions measured on the sides.

For Type A surfaces, arrange the forms to present a neat geometric pattern of form marks. Do not offset or shift patterns. Construct forms to allow removal without damaging concrete.

If supporting concrete deck forms by welding to structural steel beams, weld in accordance with subsection [707.03.D.8](#).

- e. **Ties and Spreaders.** Do not use wire ties and pipe spreaders.

After removing forms, remove the ends of metal appliances inside the forms to maintain correct alignment. Remove ends to a depth of at least 1 inch from the surface of the concrete without creating an opening greater than 1½ inches in diameter. Remove metal or wooden spreaders, which are separate from form ties, during concrete placement.

- f. **Form Surface Treatment.** Treat the inside of forms with a release agent that will not discolor or adversely affect the concrete. Do not allow the release agent to contact steel reinforcement or existing concrete surfaces.

#### 4. **Permanent Metal Deck Forms.**

- a. **Materials.** Use ASTM A 653 coating designation G210 steel, except Grade 50, Class 3, to fabricate permanent deck forms and supports. Galvanize fasteners in accordance with AASHTO M 232. Fabricate permanent metal deck forms, supports, and accessories in accordance with section [707](#).
- b. **Design and Fabrication.** Verify superstructure beam dimensions before fabricating permanent metal deck forms.

Select sheet size for permanent metal deck forms as recommended by the manufacturer. Use unit working stresses no greater than 0.725 of the specified yield strength of the steel, or 36,000 psi, whichever is less.

Include construction loads of 50 psf in addition to the dead load of the form, plastic concrete, and steel reinforcement. Consider the full slab thickness shown on the plans, to be above corrugations. If not filling corrugations with styrofoam, account for the weight of the additional concrete, as required.

Design forms, form supports, and attachments to carry construction loads, dead loads, and resultant horizontal loads due to forming of cantilever overhangs. Consider the clear span of the form plus 2 inches, measured parallel to the form flutes. Design forms for a maximum deflection of  $\frac{1}{4}$  inch or  $\frac{1}{180}$  of the form span length, whichever is less. Do not use form camber to compensate for deflection greater than the limits specified.

- c. **Construction.** Do not use metal forms below longitudinal or transverse open joints, or expansion type joints.

Do not allow form sheets to rest directly on beam flanges. Center each sheet in the bay and ensure a bearing length of at least 1 inch at each end. Attach sheets promptly to avoid hazards that may result from lateral movement or sudden uplift of the forms. Provide safety stops where necessary.

Make attachments using welds, bolts, clips, or other Department-approved methods. Attach sheets using sheet metal screws, or other Department-approved fasteners, from the top side where practical. Bolt and weld attachments in top flange compression areas. Do not flame cut metal deck forms or supports. The Department will not require repair of galvanized areas at welds or unbolted edges after shearing or punching.

Field drill  $\frac{1}{4}$ -inch diameter weep holes, at spacing no greater than 12 inches, along transverse and longitudinal construction joints.

Place styrofoam in corrugations and secure to prevent displacement during concrete placement. If styrofoam is omitted, the extra concrete required to fill in the corrugations will not be paid for. Place concrete onto forms from no greater than 15 inches above the top of the form.



**E. Steel Reinforcement.**

1. **Storage and Protection.** Store steel reinforcement on platforms, skids, or other supports. Store steel reinforcement neatly and clearly marked to facilitate inspection. Locate storage sites at water crossing locations above the high water elevation shown on the plans. Store epoxy coated bars on padded wood or steel cribbing, and cover to prevent exposure to ultraviolet rays.
2. **Handling of Epoxy-Coated Reinforcement.** Use systems with padded contact areas for handling coated bars. Pad bundling bands or use other banding to prevent damage to the coating. Lift bundles of coated bars with a strongback, spreader bar, multiple supports, or platform bridges to prevent bar-to-bar abrasion. Do not drop or drag the bars or bundles.
3. **Field Bending.** Do not bend reinforcing bars in the field unless otherwise shown on the plans, or to correct minor errors or omissions in shop bending. Perform field bending cold. Make field bends in accordance with subsection [905.03](#) for shop bends. Repair damage to epoxy coating, resulting from field bending, in accordance with subsection [706.03.E.8](#).
4. **Placing and Fastening.** Accurately place and firmly secure steel reinforcement during concrete placement. Ensure steel reinforcement is free of dirt and excessive rust, loose mill scale, or other deleterious material when placed. Ensure bar spacing does not vary more than  $\frac{1}{8}$  of the spacing shown on the plans, except as needed to allow placing anchor bolts and position dowels. Use wire ties to secure all bar intersections for the top mat, and other mats where the product of the length and width of bar intersection spacing exceeds 120 square inches. If the product of the length and the width of spacing does not exceed 120 square inches, tie alternate intersections. Do not weld.

Tie bar laps near each end of the lap. Provide a clear distance from the reinforcement to the concrete surface at least equal to the dimensions shown on the plans, but no more than +25 percent of the dimension, except for deck reinforcement. For deck reinforcement, do not vary the distance from the top transverse reinforcement to the bottom of the concrete slab by more than  $\frac{3}{8}$  inch from the dimensions shown on the plans. Provide concrete clear cover over the top transverse reinforcement at least equal to the dimensions shown on the plans.

Maintain the required reinforcement distances from forms using stays, ties, hangers, bar chairs, or other Department-approved supports, except in bridge superstructures. If bar chairs are used they must be plastic or coated metal with a bearing area that prevents penetration into forming material. Use commercial grade concrete brick only in footings.

For bridge decks, place bar chairs parallel to the beam, spaced with the lines of supports, measured from center to center, at the  $\frac{1}{4}$  point and  $\frac{3}{4}$  point for beam spacing less than 9 feet, and at the  $\frac{1}{6}$  point,  $\frac{1}{2}$  point, and  $\frac{5}{6}$  point for beam spacing 9 feet or greater.

Use additional bar chairs outside the fascia beam to support reinforcing steel along and near the fascia. On concrete box beam bridges without slab ties, use bar chairs along the longitudinal centerline of each beam. Support the upper layer of reinforcing steel over the supports for the lower layer of steel with rows of Department-approved continuous steel bar supports consisting of at least three longitudinal wires.

Tie the upper layer of reinforcing steel to the structural steel, stud shear developers, or other structural components, at intervals no greater than 5 feet along each beam or girder. Use two loops of 16-gauge tie wire for tie-downs. Tie coated bars with coated tie wire to prevent wire from damaging the coating.

Cover epoxy coated reinforcement in the deck if concrete for the deck is not cast within two months from the time of placing the epoxy-coated reinforcement. Use a cover that will prevent exposure to ultraviolet rays.

5. **Splicing.** Do not splice bars unless otherwise shown on the plans.
6. **Lapping.** Overlap sheets of mesh or bar mat reinforcement at least 24 inches to maintain uniform strengths and fasten in at least two locations at the overlaps.
7. **Cutting Epoxy-Coated Reinforcement.** The Contractor may saw or shear bars when cutting is permitted. Repair cut or sheared bar ends.
8. **Repair of Epoxy Coating.** Repair coating damaged by bending, sawing, shearing, or damaged during shipping, unloading, storage, installation, and handling on the project.

Patch sawed or sheared ends and visible defects in accordance with AASHTO M 284. Use a patching or repair material selected from the Qualified Products List. Clean areas requiring patching by removing

surface contaminants and damaged coating. Roughen the area requiring patching before applying patching material. Remove rust by dry blast cleaning or power tool cleaning immediately before applying patching material.

Immediately treat bars in accordance with the resin manufacturer's recommendations and before oxidation occurs. Overlap patching material onto the original coating by 2 inches, or as recommended by the manufacturer. Provide at least 8 mils of dry film thickness on the patched areas. The Engineer will consider bars with at least 5 percent damaged area in a 12-inch bar length to be severely damaged. Replace severely damaged bars. Coat mechanical splices after splice installation in accordance with AASHTO M 284 for patching damaged epoxy coating.

**F. Placing Galvanized Metal Pipe Sleeves.** Place galvanized metal pipe sleeves in the bridge to carry utility company facilities across the bridge. The utility company will provide pipe sleeves at the bridge site at no cost to the Contractor. Notify the utility company at least one week before the sleeves are needed. If the contract requires the utility company to install conduit or ducts in the structure, notify the utility company at least one week before the utility company is required to install conduit or ducts. The Department will not allow additional compensation for costs associated with delays caused by utility company operations.

**G. Placing Conduit.** Align the conduit, tightly fit the joints, and firmly secure conduit during concrete placement. Assemble and protect sleeve expansion joints in the superstructure to allow movement after concrete encasement. Place concrete encasement after the Engineer approves the alignment of, and connection to, the conduit. Swab the conduit for the entire length immediately after casting encasement to remove mortar.

**H. Placing Concrete.**

1. **General.** Prepare and test work progress specimens, as necessary, in accordance with subsection [701.03.D](#).

Obtain the Engineer's written approval of forms, bracing, reinforcing steel, and preparations for casting concrete before beginning concrete placement operations. Before placing concrete, clean forms, piling, and reinforcing steel, and remove sawdust, chips, and other debris from the form interior.

Remove struts, stays, and braces to hold forms in correct shape and alignment when the concrete elevation renders them unnecessary.

Place concrete to avoid material segregation and reinforcement displacement.

Complete each pour in a continuous operation with no interruption longer than 45 minutes, except concrete subfootings. Place and consolidate each layer before initial set of the previous layer.

For concrete subfootings, the Contractor may place a full-depth portion of the subfooting for a substructure unit at one time and complete the unit later.

Do not place additional concrete on substructure concrete until the substructure concrete cures for at least three days or attains at least 70 percent of its 28-day flexural or compressive design strength.

Do not use mechanical attachments to support forms until substructure concrete attains at least 70 percent of its 28-day flexural or compressive design strength. Verify the concrete strength by testing at least two beams or cylinders cured in the same environment as the respective concrete items. Conduct testing on the project site, witnessed by the Engineer.

The Engineer will lower the required concrete strength after reviewing calculations submitted by a Professional Engineer, licensed in the state of Michigan, showing that imposed loads will not exceed 70 percent of the concrete strength at the time the load is applied.

Regulate concrete placement so pressure caused by wet concrete does not exceed the pressure used in designing the forms.

Deposit the concrete in the forms in layers of suitable thickness, as near the final position as possible. In pier caps and wall sections, place layers no greater than 12 inches thick. The Engineer may modify the layer thickness requirements for wall sections depending on the steel reinforcement spacing.

For concrete placed by pumping, dispose of water-cement slurry used to lubricate the discharge pipe outside the forms.

Place and vibrate concrete in the dry for substructure units other than subfootings and tremie seals.

Place subfooting and tremie concrete to the full depth of the section.

Place footing concrete and column concrete in layers no greater than 36 inches.

Do not allow superstructure concrete to freefall more than 6 inches to the top of reinforcing steel. Do not allow concrete to freefall more than 5 feet in other structural applications. If concrete must drop more than 5 feet, deposit concrete through Department-approved pipes or tubes at least 6 inches in diameter and arranged to avoid concrete segregation. If reinforcing bar spacing prevents the use of a 6 inch tube, loosen the bar ties and spread the bars enough to allow the use of the tube or chute. Reposition and retie bars before covering with concrete.

Provide vibrators, approved by the Engineer, capable of visibly affecting the mixture for at least 18 inches from the vibrator.

Use mechanical, high-frequency internal vibrators to consolidate the concrete during and immediately after depositing. If using epoxy coated or other coated reinforcement, use a vibrator with a rubber coated head.

The Engineer will allow concrete consolidation using hand methods if the use of vibratory equipment is not possible.

Use vibrators to consolidate incoming concrete within 15 minutes of placement. Manipulate vibrators to work the concrete around the reinforcement and embedded fixtures, into corners and angles of forms. Vibrate freshly deposited concrete at the deposit point. Thoroughly consolidate the concrete, but do not cause segregation.

Move vibrators to prevent forming localized areas of grout. Uniformly space the points of vibration no greater than twice the radius over the visibly effective vibration area. Do not hold vibrators against forms or reinforcing steel, and do not use them for flowing or spreading concrete. Do not disturb partially hardened concrete.

Do not disturb forms or projecting reinforcement after the initial set of the concrete.

Maintain forms, reinforcing steel, and placing equipment clean and free of hardened concrete. Discharge water used to flush placing equipment away from concrete and forms.

If concreting operations extend into the night, light the work to make operations clearly visible for inspection.

Do not cast sidewalk, curb, or barrier pours until deck concrete attains at least the minimum specified 7-day flexural or compressive strength, and after completion of the 7-day continuous wet cure, unless the wet cure can be maintained during forming and placing of subsequent pours.

Do not place heavy equipment on the deck until deck concrete attains at least the 28-day flexural or compressive design strength, and after completion of the 7-day continuous wet cure.

- 2. Hot Weather Limitations.** Cast concrete mixtures for bridge decks when the rate of evaporation at the site is less than 0.20 psf per hour, in accordance with Figure [706-1](#). Cast structural concrete only when the temperature of the concrete being placed is below 90 °F.

Supply Engineer-approved equipment for determining the relative humidity and wind velocity on the project.

- 3. Placing Concrete Under Water.** Deposit concrete under water if shown on the plans. Use Grade T concrete proportioned in accordance with Table [701-1](#). Place concrete under water in a compact mass, in the final position, using a tremie or by pumping. Equip the tremie tube so the bottom end closes if concrete does not encase the pipe. Do not use bottom dump buckets. Maintain still water at the point of deposit, and provide tight forms. Do not disturb the concrete after deposit.

Support the tremie tube to allow free movement of the discharge end over the entire work surface and to allow rapid raising or lowering to adjust the concrete flow. Place the concrete full depth in one continuous operation, starting from one end of the cofferdam. Always keep the tremie tube in the freshly deposited concrete; only withdraw the tremie tube upon completion of each pour, or as required by piling or cofferdam bracing.

After withdrawing the tremie tube, recharge it with concrete above water, lower it to the new position, and set the discharge end into freshly deposited concrete. During placing operations, maintain the tremie tube full to the bottom of the hopper. After dumping a batch into the hopper, induce the flow of concrete by raising the discharge end of the tube slightly. Do not remove the end from the concrete.

Remove laitance or other deleterious material without damaging the concrete. Place concrete to at least the elevation of the top of tremie seals, but no more than +6 inches above the seals. Remove excess concrete.

Dewater cofferdams after the tremie concrete has been placed and has attained at least 50 percent of the 28-day compressive design strength or after test beams cured in water on top of the tremie concrete break with a modulus of rupture of at least 325 psi, as specified in Table [701-1](#). These strength requirements are in no way

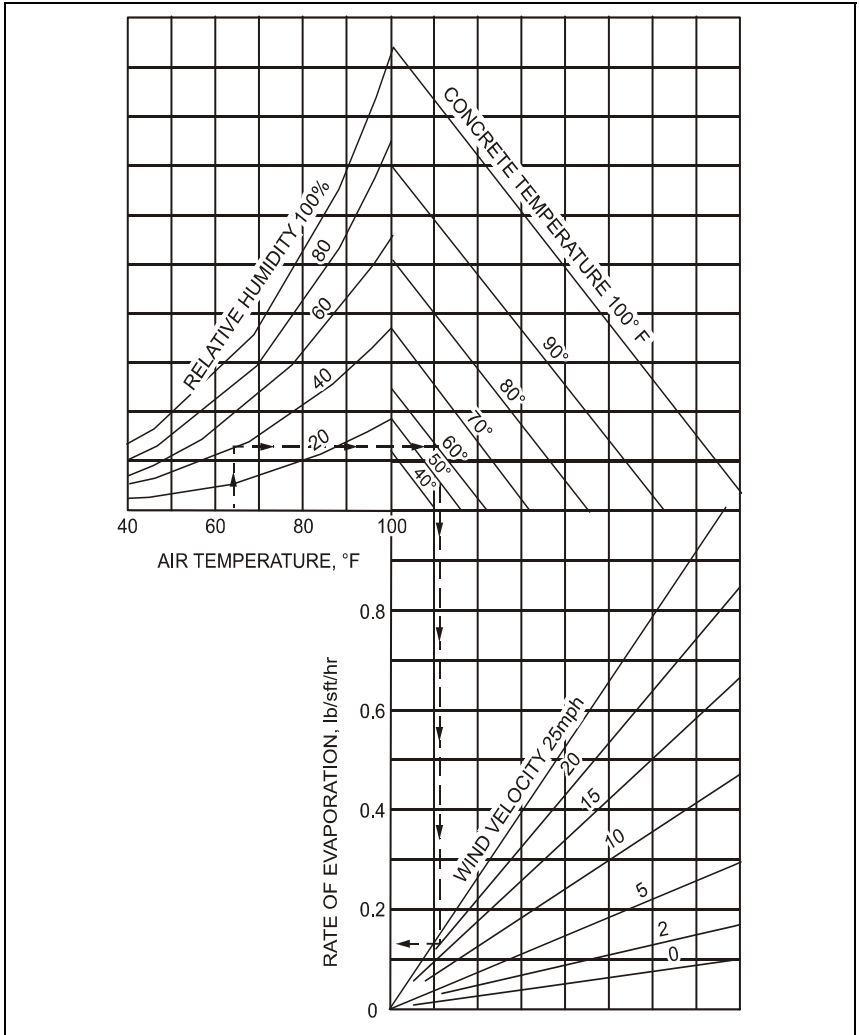

**Figure 706-1: Surface Evaporation for Concrete**

- Estimate the evaporation rate in accordance with the following:
- Enter the air temperature, measured from 4 feet to 6 feet above the evaporating surface, on the windward side and shielded from the sun;
  - Move up to the line corresponding to the relative humidity;
  - Move right to the line corresponding to the concrete temperature;
  - Move down to the line corresponding to the wind velocity, measured from 18 inches above the evaporating surface;
  - Read the evaporation rate on the scale to the left of this point.

construed as relieving the Contractor of responsibility for failure of any part of the cofferdam.

**I. Nighttime Casting of Superstructure Concrete.**

1. **Construction Methods.** Begin work from one hour after sunset to midnight, or as directed by the Engineer. Use the sunset time published by the National Weather Service for the proposed date of night casting or the time determined by the Engineer. Coordinate nighttime deck pours with the Engineer to allow scheduling of inspection.

Conform to the deck pouring sequence and curing requirements shown on the plans. If approved by the Engineer, the Contractor may consecutively pour areas shown on the plans for simultaneous pour, the same night, using retarder in the first pour to prevent initial set until completion of the second pour.

2. **Lighting Requirements.** Provide light sources to achieve a minimum average intensity of 10 foot-candles over the entire work area, including the concrete testing area. Submit the deck lighting scheme to the Engineer for approval. Ensure lighting alignment does not interfere with or impede traffic on open roadways. Refer to subsection [812.03.H](#) for additional lighting requirements for night work.

**J. Cold Weather Precautions.** Protect concrete to prevent damage from cold weather. Remove and replace frozen concrete or concrete damaged by cold weather at no additional cost to the Department.

If the National Weather Service forecasts that air temperatures will remain below 50 °F, but above 40 °F, apply ordinary protection requirements to protect concrete.

If the National Weather Service forecasts air temperatures below 40 °F during the curing period, apply low temperature protection requirements to protect concrete.

Cure in accordance with subsection [706.03.N.1](#), except only one application of interim curing compound is required.

1. **Ordinary Protection.** Ordinary protection consists of using tarpaulins, straw covering, or other Engineer-approved methods to protect concrete. If the prevailing temperatures will produce concrete temperature less than 45 °F, raise the concrete temperature in accordance with subsection [601.03.F.1](#).



Seal keyways, anchor bolt wells, or other depressions on exposed horizontal surfaces against water intrusion.

If approved by the Engineer, protect footings by completely submerging them under water inside the cofferdam area 2 hours after placement. After submersion, maintain water level necessary to cover the concrete, and keep ice from contacting the concrete.

2. **Low Temperature Protection.** Low temperature protection consists of using insulated forms or heating and housing to protect concrete. Place concrete in the forms at temperatures specified in subsection [601.03.F.1](#). Maintain concrete at a temperature of at least 40 °F.
- a. **Insulated Forms-Substructure Concrete.** Apply blanket insulation tightly against the forms and fasten securely. Insulate corners and edges. If depositing concrete against previously cast concrete, extend the blanket insulation at least 14 inches and hold in place against the previously cast concrete. Patch or cover tears and holes in the blanket.

Cut polystyrene insulation to fit snugly between wood form studs and fasten securely. For steel forms, fit the insulation boards between the ribs and hold in place with adhesive or Department-approved fasteners.

Provide insulating blankets or polystyrene insulation with the minimum thickness or the minimum R value specified in Table 706-1.

| Table 706-1<br>Insulation Requirements |                                 |         |                                |         |
|--|---------------------------------|---------|--------------------------------|---------|
| Thickness of Pour,<br>(in)             | Minimum Insulation Requirements |         |                                |         |
|  | Unlined Steel Forms             |         | Wood-Lined Steel or Wood Forms |         |
|  | in                              | R Value | in                             | R Value |
| <12                                    | 2                               | 7.0     | 2                              | 5.25    |
| 12 – 24                                | 2                               | 7.0     | 1.5                            | 5.25    |
| >24                                    | 1.5                             | 5.25    | 1                              | 4.0     |

Clean ice, snow, and frost from forms when casting concrete. Place substructure concrete when the air temperature is above 35 °F, unless the form interiors, metal surfaces, and adjacent concrete surfaces are preheated to at least 35 °F. Use only gas-fired burners if heating by direct flame. Cast substructure concrete using insulated forms only when the air temperature is above 15 °F, except that the Contractor may cast subfootings, footings, and cast-in-place concrete piles if the air temperature is

above 0 °F. Wrap exposed portions of cast-in-place concrete piles with insulating blankets or protect them with straw.

Cover the top of pours with insulating blankets. Cover inaccessible areas around protruding reinforcing bars with straw. Cover the tops of insulated pours, including the insulation, with tarpaulins or other Department-approved material.

Leave insulated forms in place until the concrete attains at least 50 percent of the 28-day flexural or compressive design strength and for at least five calendar days after final concrete placement in individual units.

Unless otherwise directed by the Engineer, do not loosen forms to lower temperatures. Remove blankets or straw from the tops of footings no earlier than the third day after casting, to allow forming subsequent portions of the unit. Obtain the Engineer's approval before loosening forms or removing the top covering. If the outside air temperature reaches 0 °F or below, or the National Weather Service forecasts air temperatures 0 °F or below for the next 24 hours, do not remove forms for eight days after casting unless otherwise directed by the Engineer, and only if the air temperature is from 0 °F to 32 °F and the temperature difference between the air and the concrete surface is no greater than 30 °F. If possible, remove forms at mid-day.

- b. **Insulated Forms-Superstructure Concrete.** If the National Weather Service forecasts air temperatures below 20 °F during the curing period, provide material and heating equipment on the project to protect forms and concrete.

Do not place superstructure concrete if the air temperature is below 40 °F, unless form interiors, metal surfaces, and the adjacent concrete surfaces are preheated to at least 40 °F. Use only gas-fired burners if heating by direct flame. Do not begin placing superstructure concrete if the air temperature is below 35 °F.

Insulating the bottom of deck forms is not required. If the National Weather Service forecasts air temperatures below 40 °F for more than 8 consecutive hours during the curing period, protect the top of the freshly cast concrete as soon as possible to maintain a concrete temperature of at least 40 °F. Use tightly joined insulating blankets or polystyrene insulation and insulate in accordance with Table [706-1](#).

Hang tarpaulins, or other Department-approved material from the top of the curb to enclose the entire protected section. If the temperature falls below 15 °F during the curing period, circulate heated air under the enclosed superstructure section. Maintain circulation for the remainder of the protection period required for concrete protected by heating and housing.

- c. **Heating and Housing.** Before placing concrete in forms, provide housing for concrete sections being placed to maintain the specified temperatures within the enclosure.

Arrange enclosures to allow removal of forms and finishing of concrete surfaces without interrupting heating.

Provide uniform forced air or radiant heat in the enclosure. Vent the heating system to prevent exposure to carbon dioxide exhaust gases during concrete placement and curing. Before placing concrete, preheat reinforcing steel and form surfaces to temperatures from 40 °F to 75 °F.

During and after concrete placement, operate the heating system to maintain an air temperature in the enclosure from 40 °F to 75 °F. Maintain the temperature in the enclosure until concrete attains at least 50 percent of the 28-day flexural or compressive design strength.

At the end of the heating period, decrease the temperature to the outside air temperature at a rate no greater than 15 °F per 12 hours. Allow the concrete surface to dry during the cooling period. Remove the housing.

In case of a heating system failure, provide emergency salamanders for use within 1 hour. Maintain a temperature of at least 40 °F with the salamanders. Place and operate salamanders and provide for moisture, as directed by the Engineer.

**K. Construction and Expansion Joints.** Construct joints in concrete structures where shown on the plans. Clean laitance and other deleterious material from the contact concrete surface in place, and wet surfaces before placing new concrete. Finish face edges of joints to the line and elevation shown on the plans. Finish joint surfaces that provide expansion in the plane of the joint within 1/8 inch of a true plane. Form keys within reasonable tolerances, using suitable material.

1. **Sealer.** Use poured joint sealers of the type required by the contract. Handle hot-poured joint sealer material in accordance with subsection [602.03.S](#).
2. **Fiber Joint Filler.** Shape premolded expansion joint material to fit adjacent concrete. Hold premolded expansion joint material in place to prevent formation of concrete fins under or between expansion joint material.
3. **Joint Seals.** For concrete, install seals as shown on the plans.
  - a. **Sawing Construction Joints.** Saw the joint groove at each transverse construction joint, as shown on the plans. Provide a joint groove symmetrical about the construction joint.
  - b. **Sawing Expansion Joints.** Saw expansion joints as shown on the plans, and symmetrical about the filler centerline.  
Extend the depth of the saw cut below the top of the filler.  
Saw or form vertical sections of the joint in the curb or sidewalk.
  - c. **Cleaning After Sawing.** Immediately after sawing, remove deleterious material from sawed joints.
  - d. **Patching Transverse Joints.** Patch transverse joints in accordance with subsection [602.03.P](#).
  - e. **Installing Seals.** Install the top of the seal  $\frac{1}{4}$  inch below the surface of the deck.
4. **Expansion Joint Devices.** Select joint devices for each location, from the options shown in the contract, and inform the Engineer of selection. The Engineer will provide standard shop drawings of the joint device. The Contractor must determine the necessary dimensions. The Engineer will not review the dimensions.  
  
Install expansion joint devices as shown on the plans and the standard shop drawings. Install the joint seal in one continuous piece for the length of the joint, as specified by the manufacturer.  
  
Weld in accordance with subsection [707.03.D.8.b](#) through subsection [707.03.D.8.d](#).
5. **Expansion Joint Device Covers.** Install plate covers as shown on the plans. Cast curbs and sidewalks with sliding plates in place to ensure proper alignment of inserts and screws. Apply bond breaker to sliding plates before installation. Form concrete recess areas in sidewalks to receive sliding plates and grind to provide smooth surface. Tool or grind concrete edges to a  $\frac{1}{4}$ -inch radius.

Apply one coat of epoxy resin adhesive to allow bent sliding plate to move freely without friction. Ensure no adhesive contacts the expansion joint device or gland. Remove foreign particles before installing plates. Install plates to position the anchors on the high side of longitudinal sidewalk grade. Repair damage to galvanized surfaces in accordance with section [716](#).

**L. Placing Anchor Bolts and Position Dowels in Concrete.** Set anchor bolts and position dowels in concrete using a template during concrete casting or, if shown on the plans, by drilling holes in hardened concrete in accordance with subsection [712.03.J](#) and subsection [712.03.K](#).

Finish the surface around anchor bolts or position dowels in accordance with subsection [706.03.M.2](#).

**M. Finishing Plastic Concrete.** Do not over-vibrate or over-finish the completed surface. If approved by the Engineer, apply water to the concrete surface with a fog sprayer to aid finishing. After finishing, texture sidewalks and curbs in a transverse direction with a broom to produce uniform, narrow grooves no greater than  $\frac{1}{8}$  inch deep. Texture the final deck surface in accordance with subsection [706.03.M.3](#).

**1. Machine Finishing.** Use a self-propelled transverse finishing machine to strike off and finish concrete surfaces subject to highway traffic. To accommodate the type of finishing machine used, the Engineer may authorize elimination of longitudinal construction joints shown on the plans.

Immediately before placing concrete, operate the finishing machine over the full length and width of the bridge segment to be placed, and adjacent segments if a pour sequence is required. Perform the test run with the screed adjusted to the finishing position. While operating the finishing machine, check the screed for deflection and adjustment. Measure and record the depth of the reinforcement below the screed, the controlling dimensions of deck reinforcement, and the forms. Make corrections before placing concrete.

When finishing concrete surfaces, complete screed passes with sufficient concrete material along the leading edge to ensure filling low spots. Leave the surface at the required grade, and free of water and laitance after the final pass of the screed. Remove deleterious material from the gutters, where the Engineer allows final hand finishing.

As soon as practical, place the work bridge behind the finishing machine.

While concrete remains plastic, test the slab surface for trueness with a 10-foot straightedge, or other Engineer-approved method. Finish the surface to the required grade and cross section.

If conditions warrant and if authorized by the Engineer, the Contractor may use truss type vibrating screeds.

Ensure complete removal of rail supports located in concrete or partial removal so no part remains less than 3 inches below finished concrete, without damaging concrete. Remove supports, fill the resulting holes with concrete, and finish flush with the deck concrete before deck concrete hardens.

2. **Hand Floated Surface Finish.** Provide a floated surface finish on areas not requiring machine finishing, such as bridge seats, sidewalks, areas of bridge decks under sidewalks, and similar surfaces. Finish by striking off the concrete surface with a screed set to the required cross section.

The Contractor may use vibrating or oscillating screeds, if approved by the Engineer.

Provide a movable screed on guides set to the required elevation with allowance for camber, if required. After striking-off, finish the surface with a wood or magnesium float.

Broom finish the concrete surface under elastomeric bearings.

3. **Texturing.** Groove the final deck surface as soon as deck concrete can maintain a texture. Construct grooves perpendicular to the centerline. Form grooves in plastic concrete without causing edges to slump, or surface tearing. End grooving 12 inches to 16 inches from curb or barrier edges. Do not groove within 3 inches to 6 inches of expansion or contraction joints, or the end of the slab. Space grooves on  $\frac{1}{2}$ -inch centers,  $\frac{1}{8}$  inch wide, and  $\frac{1}{8}$  inch deep. Random spacing is permitted if the spacing between grooves remains within the range of  $\frac{1}{4}$  inch to 1 inch.

The Engineer may require removal and replacement of deck surfaces that are not grooved as required. If the Engineer determines grooves are too shallow, but allows decks to remain in place, regroove after the concrete attains the 28-day flexural or compressive design strength. Use a machine built specifically for grooving pavements, with blades 0.095 inch  $\pm$ 0.003 inch wide, spaced randomly from  $\frac{3}{4}$  inch to  $1\frac{1}{4}$  inch on centers. Orient grooves along the initial grooving, at right angles to the centerline of the

pavement or skewed, no greater than the maximum skew of the bridge. Cut grooves uniformly to  $\frac{1}{8}$  inch deep.

Remove and dispose of residue from the grooving operations as directed by the Engineer to minimize dust and to prevent debris from entering drainage systems.

4. **Surface Tolerances.** As soon as practical, check surface tolerances. If surfaces do not meet the specified tolerances, grind with a carborundum brick or other Department-approved methods. If grinding to obtain evenness results in an elevation below the limits shown on the plans, the Engineer will direct corrective action.

Position bridge seats within  $\frac{1}{8}$  inch of elevations shown on the plans. Finish bridge seats under bearings or masonry plates to an unevenness of no greater than  $\frac{1}{16}$  inch.

Cast the tops of concrete subfootings within  $\frac{1}{2}$  inch of the elevations shown on the plans, and footings, wingwalls, parapets, slope walls, headers, and other surfaces within  $\frac{1}{4}$  inch the elevations shown on the plans.

For final deck surfaces, cast decks to within a tolerance of  $\frac{1}{8}$  inch over 10 feet. Before acceptance, the Engineer will check the deck with a 10-foot straightedge and mark defective areas. Remove or reduce high spots or ridges greater than  $\frac{1}{8}$  inch, or other defects by rubbing with a carborundum brick and water, or grinding, and re-grooving.

N. **Curing.** Protect steel reinforcement from curing compound overspray. For air temperatures below 40 °F, cure structural concrete in accordance with subsection [706.03.J](#). For air temperatures of at least 40 °F, cure structural concrete in accordance with subsection [706.03.N.1](#). Prepare and test work progress specimens, as necessary, in accordance with subsection [701.03.D](#).

#### 1. **Top Surfaces Exposed in the Completed Structure.**

- a. **Other than Bridge Decks.** Immediately upon completion of concrete finishing operations, spray curing compound uniformly on the concrete surface. Use transparent or white curing compound. Apply white curing compound at a rate of at least 1 gallon of compound per 150 square feet. Apply transparent curing compound in two coats at a rate of at least 1 gallon of compound per 300 square feet for each coat. Apply the second coat when the first coat dries sufficiently to avoid runoff, but no

more than 2 hours after applying the first coat. Do not dilute the curing compound.

- b. **Bridge Decks.** Use a two-phase continuous 7-day wet-cure procedure. Before beginning concrete placement operations, demonstrate to the Engineer that curing materials and equipment are on-site and that equipment is in operating condition.

Immediately after the bleed water sheen leaves the textured concrete surface, begin the first phase of the curing procedure by spraying a single coat of curing compound over the surface. Apply the curing compound at a rate of at least 1 gallon per 150 square feet of surface. Do not leave more than 10 feet of textured concrete surface exposed without curing compound.

Prepare clean, contaminant-free burlap by soaking it in clean water for at least 12 hours before beginning concrete placement. Immediately before use, drape or suspend the burlap sheeting vertically to remove excess water that may dilute or damage plastic concrete. Cover concrete surfaces with wet burlap when the curing compound has dried sufficiently to prevent adhesion, and the concrete surface can support it without deformation, but no more than 2 hours after the concrete placement. Do not allow the burlap to dry once it is in place. Do not use Burlene or other products with impervious surfaces.

Install a network of soaker hoses over the wet burlap when the concrete surface can support it without deformation. Use soaker hoses, perforated throughout their lengths within the limits of curing. Use soaker hoses of lengths and capacities capable of applying cure water uniformly and continuously over the entire bridge deck surface without the need to move the hoses periodically. Prevent excessive localized water discharge that may damage concrete surfaces. Use non-perforated hose outside the limits of curing. Demonstrate to the Engineer that soaker hose systems provide uniform and thorough coverage of the deck surface.

Place a layer of transparent or white polyethylene film, at least 4 mils thick, over the deck surface and the soaker hose system. Overlap seams in the polyethylene at least 10 inches. Activate the wet cure system and maintain it to ensure uninterrupted wet curing of the deck surface. Control the water runoff to prevent soil erosion or hazards to traffic. Do not allow curing water runoff to discharge directly into surface waters.



Maintain the wet cure until the concrete attains at least the minimum specified 7-day flexural or compressive strength, and for at least 7 days following concrete placement. Do not remove the wet cure system based on 7-day compressive strengths attained in less than 7 days.

- 2. Top Surfaces to Which Succeeding Portions of the Structure Will Be Bonded.** Maintain top surfaces on which succeeding portions of the structure will be placed, including but not limited to, medians, shoulders, sidewalks, barriers parapets, membrane waterproofing, and latex overlays, free of curing compound.

Cure these surfaces by keeping them continuously wet until the concrete attains at least the minimum specified 7-day flexural or compressive strength, and for at least 7 days following concrete placement. Stop curing during casting of succeeding structure portions. Begin wet curing when the concrete hardens sufficiently to prevent marring or water damage.

- 3. All Surfaces Other than Top Surfaces.** Cure surfaces, other than top surfaces, by keeping continuously wet until the concrete attains at least 70 percent of the 28-day flexural or compressive design strength, and for at least 5 days following concrete placement. Alternately, cure concrete by leaving forms or other waterproof devices in place during the curing period, or by applying transparent membrane curing compound for structures.

Do not use membrane curing compound on surfaces requiring water curing and bonding of additional concrete, or surfaces requiring application of joint waterproofing or protective coatings.

Clean surfaces of steel dowels, anchors, waterstops, and similar devices of curing compound before encasement.

For structures, apply transparent membrane curing compound in two coats, each of at least 1 gallon of compound per 300 square feet of surface. Apply the first coat immediately after removing forms. Apply the second coat from 30 minutes to 2 hours after applying the first coat.

Apply curing compound using a brush, roller, or spray equipment capable of producing a uniform film, without causing the compound to run or sag. Obtain the Engineer's approval for spray equipment before use.

If the method of applying the compound does not produce a uniform film, stop using the curing compound and keep the concrete surface wet for the required curing period.

**O. Removing Falsework and Temporary Supports.** Leave falsework and temporary supports for concrete structures other than railings, in place until the concrete attains at least 70 percent of the specified 28-day flexural or compressive design strength, and for at least 5 days following concrete placement. Prepare and test work progress specimens, as necessary, in accordance with subsection [701.03.D](#).

Unless otherwise directed by the Engineer, the Contractor may remove falsework for railings after 15 hours.

Remove materials used to construct falsework outside low water limits to at least 6 inches below the finished ground surface. Remove falsework material inside low water limits to the stream bed.

**P. Removing Forms.** Do not remove vertical forms, including bulkheads at construction joints, until at least 15 hours after completion of the pour. Remove forms under slab spans, beams, girders, and brackets in accordance with subsection [706.03.O](#). If forms are braced against finished work portions subject to movement due to temperature changes, remove restraining falsework or adjust to prevent damage to the new work.

**Q. Placing Beams on Substructure Units.** Do not place beams until substructure concrete attains at least 70 percent of the specified 28-day flexural or compressive design strength. Prepare and test work progress specimens, as necessary, in accordance with subsection [701.03.D](#).

**R. Finishing Hardened Concrete.**

1. **General.** Remove concrete fins and irregular projections from surfaces, except those that will not be exposed, or those not requiring waterproofing. Clean honeycomb areas, broken corners or edges, cavities produced by form ties, other defects, and holes greater than  $\frac{3}{4}$  inch in diameter and  $\frac{3}{8}$  inch deep. Keep surfaces saturated with water until pointed and trued with mortar. Mix the mortar using cement and fine aggregate of the proportions used in the concrete grade finished. Use a cement mixture composed of  $\frac{2}{3}$  of the brand used in the concrete and  $\frac{1}{3}$  white cement. Use fine aggregate from the same source as used in the concrete. Use workable mortar that has attained initial set. Restore consistency by reworking, but not retempering. Cure mortar patches in accordance with subsection [706.03.N](#).

2. **Rubbed Surface Finish.** If the plans show a rubbed surface finish, start rubbing as soon as possible after removing forms and completing pointing and truing required in accordance with subsection [706.03.R.1](#). Immediately before beginning rubbing work, keep the concrete saturated with water for at least 1 hour. Allow time before wetting concrete to allow mortar in pointing of holes and defects to set. Do not damage mortar used in pointing of holes and defects. Rub the surfaces with a medium-coarse carborundum stone. Do not paint or plaster surfaces with neat cement or mortar. Continue rubbing to obtain a uniform surface, including the removal of form marks, projections, and irregularities, and filling of voids. Leave paste produced by this rubbing in place.

After casting all concrete above the treated surface, obtain the final finish by rubbing with a fine carborundum stone and water. Continue rubbing to produce a smooth surface, uniform in color.

After completion of final rubbing and the after the surface dries, rub with burlap to remove loose powder. Leave rubbed surfaces free of unsound patches, paste, powder, and marks the Engineer determines objectionable.

- S. **Penetrating Water Repellent Treatment.** Select penetrating water repellent from the Qualified Products List. Before applying the material, provide the Engineer with the product data sheets showing manufacturer's recommended surface preparation, application procedure, and temperature range.

Unless adjacent steel surfaces require coating after concrete cleaning, protect them to prevent damage. If damage occurs, repair it according to the contract at no additional cost to the Department.

1. **Application.** Apply penetrating water repellent material in accordance with the manufacturer's recommendations and at the rate specified in the Qualified Products List. Do not dilute or alter penetrating water repellent material.
2. **Limitations.** Cure concrete at least 28 days before treating. Allow concrete to air dry during the final 48 hours of the curing period. Apply penetrating water repellent material to surface dry concrete.

Apply penetrating water repellent material when the concrete and the air temperature are within the range recommended by the manufacturer, but no cooler than 40 °F.

Do not spray the water repellent material if wind, rain, or other conditions prevent required application.

**T. Electrical Grounding System.** Ensure licensed electricians, experienced in grounding system installation, complete grounding work. Install a ground at each side of the bridge, at opposite ends.

Weld bonding jumpers across the steel structure at the expansion joints and across the steel fence posts at expansion joints. Install grounding cables down the piers or abutments from the bonding jumpers, fence posts, or steel fence, to the grounding rod. Make connections with exothermic welds. Use the required mold and associated equipment for each connection.

Install bonding jumpers and grounding cables to allow for at least 2 inches of expansion between connections.

Measure ground resistance using the fall of potential method and do not exceed 25 ohms. If a single 8-foot grounding rod does not attain 25 ohms, drive additional 8-foot grounding rods, added to the top of the first rod or driven as a second ground, and connect to the first ground.

**U. Name Plates.** Furnish and install name plates as shown on the plans. Before installation, submit name plates, with the required data imprinted legibly in the surface, to the Engineer for approval.

**V. Wall Drain.** Attach wall drain strips as recommended by the manufacturer. Peel geotextile layers from the core at the lower edge and wrap around the foundation underdrain. Provide additional geotextile sections to completely encapsulate the pipe-strip junction. Shingle lap geotextile to preclude entrance of backfill material.

Hold the top composite strip snug against the wall using mechanical means or a heavy bead of caulk, as approved by the Engineer, until the backfill placement.

Repair damage to composite strips or replace the strip. Ensure delivery and storage of composite strips in ultraviolet resistant wrapping. Protect composite strips from prolonged exposure to sunlight in accordance with the manufacturer's instructions.

#### **706.04. Measurement and Payment.**

| <b>Pay Item</b>                              | <b>Pay Unit</b> |
|--|-----------------|
| False Decking.....                           | Square Foot     |
| Reinforcement, Steel.....                    | Pound           |
| Reinforcement, Steel, Epoxy Coated.....      | Pound           |
| Reinforcement, Steel, Culv and Headwall..... | Pound           |
| Conc, Grade __.....                          | Cubic Yard      |
| Conc, Grade S2, Subfooting.....              | Cubic Yard      |
| Substructure Conc.....                       | Cubic Yard      |

|  |             |
|--|-------------|
| Superstructure Conc.....   | Cubic Yard  |
| Superstructure Conc, Night Casting.....  | Cubic Yard  |
| Water Repellent Treatment, Penetrating.....  | Square Yard |
| Expansion Joint Device .....   | Foot        |
| Expansion Joint Device, Cover Plate .....  | Foot        |
| Pipe Sleeve, __ inch.....  | Each        |
| Pipe Sleeve, __ inch, Placed.....  | Each        |
| Conduit, __ inch.....  | Foot        |
| Conduit, __ inch, Placed.....  | Foot        |
| Superstructure Conc, Form, Finish, and Cure<br>(Structure No.).....                | Lump Sum    |
| Superstructure Conc, Form, Finish, and Cure,<br>Night Casting (Structure No.)..... | Lump Sum    |
| Bridge Ltg, Furn and Rem (Structure No.) .....                                     | Lump Sum    |
| Bridge Ltg, Oper and Maintain .....  | Cubic Yard  |
| Support, Temp.....   | Each        |
| Conc, Low Temperature Protection.....  | Cubic Yard  |
| Elec Grounding System.....   | Each        |
| Wall Drain .....   | Square Foot |

**A. Plan Quantities.** Unless otherwise specified, the Engineer will calculate pay quantities for pay items listed in this subsection based on the lines and dimensions shown on the plans. The Engineer will calculate concrete volumes without subtracting the volume of steel reinforcement.

The Engineer will calculate the weight of bars or bar mats, plain or coated, from the theoretical bar weights in accordance with Table 706-2, based on the total calculated weight for the bar sizes and lengths, mesh, or bar mats. The Engineer will not make allowance for the weight of coating.

| <b>Bar Size<br/>Designation</b> | <b>Weight,<br/>(lb/ft)</b> | <b>Diameter, Round Sections,<br/>(in)</b> |
|---------------------------------|----------------------------|---|
| No. 3                           | 0.376                      | 0.375                                     |
| No. 4                           | 0.668                      | 0.500                                     |
| No. 5                           | 1.043                      | 0.625                                     |
| No. 6                           | 1.502                      | 0.750                                     |
| No. 7                           | 2.044                      | 0.875                                     |
| No. 8                           | 2.670                      | 1.000                                     |
| No. 9                           | 3.400                      | 1.128                                     |
| No. 10                          | 4.303                      | 1.270                                     |
| No. 11                          | 5.313                      | 1.410                                     |
| No. 14                          | 7.65                       | 1.693                                     |
| No. 18                          | 13.60                      | 2.257                                     |

**B. Structure Concrete.** Conduct concrete quality control as specified in section [604](#) and the contract. The Engineer will conduct quality assurance as specified in section [605](#) and the contract. The Department will pay for concrete required for this work based on the quality assurance results.

Provide substructure concrete and superstructure concrete for bridge structures. Provide concrete, of the grade required for box and slab culverts, headwalls, retaining walls, tremie seals, and other structures.

The Engineer will measure superstructure concrete for decks based on batch plant tickets with deductions made for material wasted or rejected.

The unit prices for **Substructure Conc, Conc, Grade \_\_, and Conc, Grade S2, Subfooting**, include the cost of forming, finishing and curing.

If the contract requires casting concrete against steel sheet piling, the Engineer will calculate the concrete volume based on an outline to the mid-point of the corrugations in the sheet piling section.

If casting concrete footings on or against excavated rock, the Engineer will make an allowance in concrete volume for rock overbreak within 6 inches outside and 6 inches below the neat outline of the footing.

The Engineer will measure, and the Department will pay for concrete placed by pumping as concrete placed by other methods. The Department will not adjust the unit price of concrete due to adjustments in aggregate proportions, or an increase in cement to facilitate the use of pumping equipment, or for the water-cement slurry pumped through the discharge pipe at the beginning of a pour.

**C. False Decking.** The Engineer will measure **False Decking** for the total area protected, including beam widths. The unit price for **False Decking** includes the cost of providing, installing, maintaining, moving, and removing false decking material or barges.

**D. Water Repellent Treatment, Penetrating.** The unit price for **Water Repellent Treatment, Penetrating** includes the cost of preparing concrete surfaces and providing and placing water repellent material.

**E. Expansion Joint Device.** The Engineer will determine **Expansion Joint Device** quantities by the joint device length placed within the limits shown on the plans or authorized by the Engineer, including allowance for vertical heights. The unit price for **Expansion Joint Device** includes the cost of providing and placing attaching hardware for the device.

F. **Conduit and Pipe Sleeve.** The unit prices for **Conduit, \_\_ inch** and **Pipe Sleeve \_\_ inch** include the cost of providing and installing conduit or pipe sleeve.

The unit prices for **Conduit, \_\_ inch, Placed,** and **Pipe Sleeve, \_\_ inch, Placed** include the cost of installing conduit or pipe sleeve provided by others.

The Department will not make additional payments to the Contractor for additional work of forming for conduit or ducts.

G. **Superstructure Concrete, Form, Finish, and Cure.** The Engineer will measure **Superstructure Conc, Form, Finish, and Cure** as a unit for each structure.

The unit prices for **Form, Finish, and Cure** pay items include the cost of designing, fabricating, providing, and erecting forms or permanent metal deck forms, and providing and installing Styrofoam.

H. **Bridge Lighting.**

1. **Bridge Lighting, Providing and Removing.** The Engineer will measure **Bridge Ltg, Furn, and Rem** as a unit for each structure. The unit price for **Bridge Ltg, Furn, and Rem** includes the cost of providing, placing, and removing material for nighttime lighting.

2. **Bridge Lighting, Operating and Maintaining.** The Engineer will measure **Bridge Ltg, Oper and Maintain** based on cubic yards of superstructure concrete cast at night. The unit price for **Bridge Ltg, Oper and Maintain** includes the cost of operating and maintaining the lighting system.

I. **Support, Temporary.** The unit price for **Support, Temp** includes the cost of providing, placing, and removing supports.

J. **Low Temperature Protection.** If the contract does not include a separate item for **Conc, Low Temperature Protection**, and the Department orders low temperature protection work due to Department-caused delays, or the Department orders an expedited progress schedule, the Department and the Contractor will agree on a unit price for **Conc, Low Temperature Protection** before beginning protection work.

The Department will pay for **Conc, Low Temperature Protection** based on the concrete quantity actually protected if the quantity did not increase due to the Contractor's failure to perform the work as shown on the progress schedule or due to the Contractor performing more work than shown on the progress schedule.

K. **Providing and Placing Interim Curing Material.** The unit prices for the relevant structural concrete pay items includes the cost of providing and placing interim curing material on bridge deck top surfaces, exposed in the completed structure.

L. **Electrical Grounding System.** The unit price for **Elec Grounding System** includes the cost of providing and installing the complete system to ground the bridge on two sides.

M. **Wall Drain.** The unit price for **Wall Drain** includes the cost of providing and attaching geocomposite and additional geotextile to wrap the foundation underdrain. The Engineer will measure, and the Department will pay for foundation underdrain in accordance with subsection [404.04](#).

N. **Name Plates.** The cost of providing, fabricating, imprinting, and installing name plates on structures is included in the unit prices for other items of work.

O. **Unstable Foundations.** The Department will pay for special treatment for unstable foundations at the unit price or authorized unit price for the item of work.

P. **Expansion Joint Device, Cover Plate.** The Engineer will determine **Expansion Joint Device, Cover Plate** quantities by the length of cover plate placed within in the limits shown on the plans or authorized by the Engineer.



**Section 707. STRUCTURAL STEEL CONSTRUCTION**

**707.01. Description.** This work consists of fabricating, shop cleaning and coating, providing, delivering, and erecting structural steel and other materials.

**A. Steel Fabrication Requirements.** American Institute of Steel Construction (AISC) certification is required for the steel fabrication work listed below.

1. Category Simple Steel Bridges (Sbr) for un-spliced rolled beams or other bridge related components including but not limited to pin and hanger assemblies, excluding machining operations; diaphragms, cross-frames, and connection angles and plates.
2. Category Major Steel Bridges (Cbr) for welded plate girders.
3. Fracture Critical Members Endorsement in addition to Category Major Steel Bridges for fracture critical members.
4. Sophisticated Paint Endorsement for painted steel surface areas greater than 500 square feet. The Engineer will accept Society of Protective Coatings, SSPC QP3 Shop Painting Certification Program as an acceptable alternate.
5. Category Bridge and Highway Metal Components when fabricating bridge tube railing, bearing assemblies (including pot and disc bearings), modular bridge expansion joints, sidewalk and deck grating (welded only), and miscellaneous steel components permanently attached to the structure as determined by the Engineer

**B. Welding Requirements.** Weld in accordance with AWS D1.5, Bridge Welding Code, as modified by this section. The Engineer will consider rolled beams, cover plates, flange and web plates, link bars, end diaphragms, and end diaphragm connection plates and stiffeners as primary members. For horizontally curved girders the Engineer will consider intermediate cross frames and connection plates and stiffeners as primary members.

**C. Shop Cleaning and Coating.** Shop clean and coat in accordance with section [716](#).

**707.02. Materials.** Provide material in accordance with the following:

|  |                     |
|--|---------------------|
| Structural Steel .....                           | <a href="#">906</a> |
| High Strength Steel Bolts, Nuts and Washers..... | <a href="#">906</a> |
| Pins.....  | <a href="#">906</a> |
| Shear Developers.....                            | <a href="#">906</a> |
| Miscellaneous Metals .....                       | <a href="#">908</a> |
| Elastomeric Bearings.....                        | <a href="#">914</a> |

Non-Metallic Washers ..... 914

Provide bushings with a nominal wall thickness of ¼ inch, selected from the Qualified Products List.

Provide steel castings unless cast iron or other material is required or approved by the Engineer in writing.

Provide the Engineer with one copy of Mill Test Reports, from the manufacturer's records, of chemical composition and physical properties of structural steel members. Provide an affidavit stating that the material meets specifications. If Mill Test Reports are unavailable, arrange for tests of chemical and physical properties and provide two certified copies of the test reports and affidavits to the Engineer, at no additional cost to the Department.

For materials not requiring Mill Test Reports, provide two copies of an affidavit stating that the material meets the specifications, to the Engineer.

Identify each test report and affidavit with the relevant Department structure number and the specific structure members to which the test reports or affidavits apply.

### **707.03. Construction.**

**A. Shop Inspection.** The Department will provide shop inspection for structural steel, castings, and similar materials. The fabricator must establish and maintain effective quality control procedures. The Department inspection is not a substitute for fabricator quality control procedures.

- 1. Notice of Beginning of Work.** Give two weeks notice to the Engineer before beginning work in the shop.

If the fabricator suspends work for a period in which the Inspector leaves the shop, provide two weeks notice, or a period, agreed upon in advance with the Engineer and fabricator, before restarting work.

- 2. Facilities for Inspection.** Provide facilities for inspection of material and workmanship, at no additional cost to the Department. Include a desk, locker, plan rack, secure storage space for testing equipment, high-speed broadband internet service, and a telephone. Allow the Inspector access to parts of the shop relating to the work.

Provide an office close to the work with at least 120 square feet of floor space, lighted, heated or air conditioned, ventilated, and shared by no more than one other Inspector. The Engineer may approve sharing larger offices with additional Inspectors. Provide equipment

in the office in working order. Provide a parking space for the Inspector next to the office.

3. **Shop Inspector's Authority.** The Inspector has the authority to reject material or construction that does not meet the contract requirements. The Inspector may suspend the use of equipment or an operation that does not produce desired results, until the fabricator takes corrective action. If problems arise that the Inspector cannot resolve, conduct a three-way conversation between the Engineer, the Inspector, and the fabricator.

The Inspector will report final decisions back to the fabricator.

4. **Rejections.** The Engineer may reject finished members at the project site that the Inspector approved at the shop for material and workmanship. Correct or replace damaged or defective material or workmanship at no additional cost to the Department.

**B. Prefabrication Meeting.** Do not begin fabrication work until the Engineer and the fabricator conduct a prefabrication meeting at the fabricating plant. Verify the date of the prefabrication meeting. The prefabrication meeting must include the Engineer, other Department representatives, and the fabricator's representatives directly responsible for supervision and control of the work. Finalize procedures relating to shop fabrication of the material included in the contract and the proposed schedule of fabrication and delivery at the prefabrication meeting.

### C. Furnishing and Fabricating.

1. **Shop Plans.** Prepare working drawings of fabrication details in accordance with subsection [104.02](#). Do not use design drawings in lieu of shop plans. Submit one set of drawings and one electronic file copy to the Engineer for review and approval. After the Engineer approves the working drawings, provide the Engineer one complete sets of prints, one electronic file copy, and three sets of shop bills. After fabrication is complete, provide the Engineer one complete set of working drawings in ink on white, 3-mil polyester/Mylar drafting film, 24 inches by 36 inches and an electronic file copy. Include changes from the time the Engineer approved the original drawings.

### 2. Welded Plate Girders and Rolled Beam Fabrication.

- a. **General.** Show, on the working drawings, the procedure for each type and size of welded joint or bolted connection.

Weld the plates that comprise the flange and web of the girders into a single plate before welding flanges and webs together to form individual girders or box girders.

Use the automatic Submerged Arc Welding (SAW) process to make flange and web butt welds, to connect the flanges to the webs, to attach cover plates to beam flanges, and to attach stiffener and connection plates to webs, including flange-to-web welds in box girders, arches, towers, and truss web and chord members.

Use flat (1F) or horizontal (2F) positions for flange-to-web and cover plate-to-flange fillet welding. Limit the use of the Shielded Metal Arc Welding (SMAW) process to welding stiffeners or connection plates to rolled beams, stiffener-to-flange welding on plate girders, and welding bearing assemblies. Use SMAW for other welding applications if the limited access, isolated locations, or short weld lengths render the use of automatic or semi-automatic welding equipment impractical. Use E7018 electrodes for the SMAW process.

Do not use electroslag or electrogas welding processes.

Remove weld metal splatter on adjacent base metal, as approved by the Engineer, before blast cleaning and coating.

Determine fillet weld size by the thicker of the two parts joined, unless the calculated stress requires a larger size. The Engineer does not require exceeding the thickness of the thinner part joined with fillet welds. If the weld size is smaller than the minimum required due to plate thickness, preheat to ensure weld soundness. Provide a minimum  $\frac{5}{16}$  inch fillet weld for a flange weld. Provide the minimum fillet weld sizes specified in Table 707-1 and Table 707-2.

| <b>Base Metal Thickness of<br/>Thicker Part Joined<br/>(in)</b> | <b>Minimum Size of Fillet<br/>Weld<br/>(in)</b> |
|---|---|
| $\leq \frac{3}{4}$  | $\frac{1}{4}$                                   |
| $> \frac{3}{4} - 1\frac{1}{2}$                                  | $\frac{5}{16}$                                  |
| $> 1\frac{1}{2} - 2\frac{1}{4}$                                 | $\frac{3}{8}$                                   |
| $> 2\frac{1}{4} - 6$  | $\frac{1}{2}$                                   |
| $> 6$   | $\frac{5}{8}$                                   |

| <b>Based Metal Thickness of<br/>Thicker Part Joined<br/>(in)</b>                  | <b>Minimum Effective Weld Size<br/>(a)<br/>(in)</b> |
|---|---|
| $\leq \frac{3}{4}$  | $\frac{1}{4}$                                       |
| $> \frac{3}{4} - 1\frac{1}{2}$  | $\frac{5}{16}$                                      |
| $> 1\frac{1}{2} - 2\frac{1}{4}$   | $\frac{3}{8}$                                       |
| $> 2\frac{1}{4} - 6$  | $\frac{1}{2}$                                       |
| $> 6$   | $\frac{5}{8}$                                       |
| a. Except the effective throat need not exceed the thickness of the thinner part. |   |

- b. **Lifting Methods.** If using lifting lugs, weld them to the upper flange in areas subjected to compression. Submit the proposed details and design calculations to the Engineer for approval before fabricating. Conduct nondestructive testing on the welds connecting lifting lugs to the girder, as directed by the Engineer. Note on shop drawings if lugs will lift one piece, or will lift assemblies of two pieces or more.

Immediately after erecting the steel girder, remove lifting lugs by cutting and grind the area smooth.

Provide lifting devices with softeners to prevent damage. If using hooks for lifting, provide jaw and throat widths large enough to prevent damage. Provide spreader beams or multiple cranes for lifting plates and long slender members to prevent overstress and distortion.

3. **Straightening.** Straighten material in accordance with the tolerances in AWS D1.5, Bridge Welding Code, Section 3.5, before laying or working the material. Obtain the Engineer's approval for straightening methods. The Engineer may reject material with kinks or bends.

Straighten flanges joined by butt welds before fitting to the webs. Remove distortion, due to welding or handling, by applying heat over the full width of the flange. Do not heat to greater than 1,200 °F. Cool slowly. Complete straightening before testing in accordance with subsection [707.03.C.9](#).

4. **Cambering.** Accomplish cambering, camber adjustment, and horizontal curvature by heat in accordance with Section 11.4.12, Curved Girders, of AASHTO LRFD Bridge Construction Specifications. Provide dimensional tolerances in accordance with AWS D1.5, Bridge Welding Code, Section 3.5.

During the heating process, verify the temperature using temperature monitoring devices.

Measure the camber of each member in the shop and with the Inspector present, as a condition for approval for shipment.

5. **Cutting and Planing.** Plane  $\frac{1}{4}$  inch of metal from sheared edges of steel greater than  $\frac{5}{8}$  inch thick and alloy steel greater than  $\frac{1}{2}$  inch thick. Fillet a  $\frac{3}{4}$ -inch radius on re-entrant angles.

If flame cutting flange and web plates, cut edges simultaneously.

At the time of cutting, transfer heat numbers to the pieces of primary member material cut from large plates. Mark with white paint that lasts through fabrication.

6. **Splices and Connections.**

- a. **Shop Splices.** The fabricator may splice girder web plates, unless prohibited by the contract.

Only splice flange plates in girders greater than 50 feet long.

If the Engineer approves, provide one splice per cover plate.

Obtain the Engineer's approval for the location of optional web and flange splices.

Separate girder flange plate and web plate butt welds, as well as stiffener and connection plate attachment welds, by at least one foot

- b. **Holes for High Strength Bolts.** Punching holes is limited to AASHTO M 270 Grade 36 steel no greater than  $\frac{3}{4}$ -inch thick or high-strength steel no greater than  $\frac{5}{8}$  inch thick. Provide a die with a diameter that does not exceed the diameter of the punch by more than  $\frac{1}{16}$  inch for punching full-size. Provide a die that does not exceed the diameter of the punch by more than  $\frac{3}{32}$  inch for sub-punching.

Sub-drill or sub-punch holes for primary member splices two sizes undersize and ream full size.

Drilling holes full size is permitted while working on the splice if all material is assembled as it will be used in the final joint assembly. When drilling assembled splices, pre-drilling one plate full-size for use as a template is acceptable.

Drilling holes full size with computer numerically controlled (CNC) equipment is permitted.

Match-mark all joints, which have been reamed or drilled, with the parts assembled. Partially assemble joints with plates attached so erecting crews do not misplace, interchange, or reverse joint parts. Match-mark in one location using low stress stamping. Show match-marking schemes on the shop drawings and obtain the Engineer's approval for mark locations.

For primary members, load carrying diaphragms, and load carrying cross-frame connections, drill finished holes  $\frac{1}{16}$  inch larger than the nominal bolt diameters required. Ensure finished holes are clean cut, without torn, ragged, burred, or crimped edges. Make finished holes in other diaphragms and cross-frames no more than  $\frac{3}{16}$  inch larger than the nominal bolt diameter. Do not use welding to fill or repair misplaced drilled or punched holes.

7. **Assembly.** Assemble field connections of primary members in the shop and ream sub-size holes to the size required. Assemble using full truss or girder assembly methods, unless otherwise required.
- a. **Full Truss or Girder Assembly.** Assemble members of each truss, arch rib, bent, tower face, continuous beam line, plate girder or rigid frame at one time.
  - b. **Progressive Truss or Girder Assembly.** Assemble for each truss, arch ribs, bents, tower faces, continuous beam lines, plate girders, or rigid frame, at least three consecutive shop sections or members in at least three consecutive panels. For structures longer than 150 feet, assemble at least the number of panels associated with three consecutive chord lengths, but no less than 150 feet of panels.

Before removing a member from the rearward end, maintain the assembled length by adding at least one shop section or panel, or as many panels as associated with a chord length at the advancing end of the assembly.

- c. **Full Chord Assembly.** Assemble, with geometric angles at the joints, the full length of each chord of each truss or open spandrel arch, or each leg of each bent or tower. Ream field connection holes while the members are assembled. Ream the web member connections to steel templates set at geometric angular relation to the chord lines.

Ream field connection holes in web members to steel templates. Mill or scribe at least one end of each web member normal to the

longitudinal axis of the member. Position templates at both ends of the member from one milled end or scribed line.

- d. **Progressive Chord Assembly.** Assemble consecutive chord members as required for full chord assemblies and in the number and length required for progressive truss or girder assemblies.
- e. **Special Complete Structure Assembly.** Assemble the entire structure, including the floor system.

Before reaming, obtain the Engineer's approval of each assembly, including camber, alignment, accuracy of holes, and fit of milled joints. Maintain a gap no greater than  $\frac{3}{8}$  inch between girder ends at bolted field splices.

Provide a camber diagram to the Engineer, showing the camber at each panel point of each truss, arch rib, continuous beam line, plate girder, or rigid frame. Show the camber measured in assembly on the camber diagram if shop assembly is full truss, girder, or special complete structure assembly. For other shop assembly methods, show calculated camber on the camber diagram.

Use bolts for assembly of the same diameter as bolts required for erection. Use pins for assembly of the same diameter as the hole and in sufficient number to ensure accuracy.

Ensure drifting done while assembling field connections does not enlarge holes or distort metal. Ream under size holes to admit bolts. Do not move assemblies while drilling a joint, nor disassemble until drilling or reaming is complete and the Inspector approves the holes and markings.

Ensure the Engineer approves tack welding temporary fitting aids during fabrication. Do not tack weld fitting aids to the flange.

- 8. **High Strength Steel Bolts.** If high strength steel bolts are required for connections, provide heavy hexagon structural bolts. Provide heavy, semi-finished, hexagonal nuts with one circular washer for each bolt. Lubricate galvanized nuts with a lubricant with a visible dye. Supply two washers for oversize holes, one under each element. Supply 5 percent more high strength steel bolts of each size and length than required.



9. **Welding.** Ensure shop welders, welding operators, welding equipment, and welding procedures are qualified in accordance with AWS D1.5, Bridge Welding Code, as modified by the contract.

Make test welds under the supervision of a Department representative. The Engineer will not accept weld tests by other agencies.

Shop welder and welding operator qualifications remain in effect for three years unless welders or welding operators are not engaged in a welding process for at least three months, or a specific reason exists to question the welder's ability. The Engineer may require a confirming qualification test during the progress of the work. The Department considers welders and welding operators, qualified on Grade 50 high-strength steel, qualified to weld Grade 36 steel if the shop qualifies the procedure as required.

10. **Nondestructive Testing of Welds.** Nondestructive testing of welds is required. The fabricator must provide labor, equipment, and materials for making inspections. The Engineer will determine the adequacy of the equipment, materials, and procedures and witness testing.

Make required identification marks on butt welds with paint. Do not stencil or punch the marks.

Ensure technicians approved by the Department perform ultra-sonic testing.

- a. **Scope of Examination of Groove Welds.** Use radiographic test methods in accordance with AWS D1.5, Bridge Welding Code. Use ultrasonic test methods for examining full penetration corner joints and T-joints if radiographic testing is not possible. If the Engineer allows ultrasonic testing, use glycerine as the coupling agent. Test butt welds, or other full penetration welds in primary members as follows:
- i. Flange splices, 100 percent;
  - ii. Splices subject to reversal of stress, 100 percent;
  - iii. Web splices, beginning at the point of maximum tension, 12 inches, or at least  $\frac{1}{3}$  the length plus 12 inches of the web splice beginning at the compression end, including splices connecting pin plates to webs;
  - iv. Compression and shear splices in built-up members, 25 percent;
  - v. Flange to web connections of box girders, 25 percent, unless otherwise shown on the plans;

- vi. Similar welds in a member subject to partial examination if the Engineer finds a defect in the member welds, 100 percent;
- vii. Butt weld repairs requiring weld defect removal and replacement, 100 percent; and
- viii. Ultrasonically tested plug and slot welds, 100 percent.

For thickness transition joints, place radiographic film on both sides of the joint, position the pack, and use tapered edge blocks. If substandard images result from film placement on transition sides, move the film to the planar side.

Submit for the Engineer's approval, a proposed procedure for ultrasonic testing of corner joints or joints with backup bars.

Complete radiographic or ultrasonic tests on groove welds and obtain written approval before assembling and welding the flange plates and web plates to form girders.

Check full penetration butt welds on both ends for surface defects using dye penetrant inspection, in accordance with ASTM E 165. Inspection is mandatory for welds inspected by radiography or ultrasonic testing.

Use extension blocks to extend radiographic film at least 1 inch beyond the edges of the radiographed section.

If using ultrasonic testing, perform radiography on one out of four welds. The Engineer may waive this requirement if the welders demonstrate and maintain a high level of competence.

- b. **Scope of Examination of Fillet Welds.** Magnetic particle testing of fillet welds is required. Perform magnetic particle testing in accordance with ASTM E 709, using the yoke, or aluminum prod method. Use half-wave rectified alternating current (direct current) for magnetic particle testing.

Test fillet welds, including welds connecting bearings and intermediate stiffeners to girder tension flanges and sole plates welded to girders using the magnetic particle process. Do not test fillet welds connecting intermediate stiffeners to the girder web, diaphragm assemblies, sway bracing, and other secondary members.

Test stiffener end to tension flange welds over the entire length. Test other fillet welds on at least 10 percent of the length of every weld, or at least 10 inches, whichever is greater for each fillet weld size. Include all primary members such as girders;

floor beams; stringers; truss members including end connections; and bearing blocks and assemblies including their attachment to members.

Locate the tests randomly in members to produce results typical for each weld size. If test results show unacceptable defects, test the full length of the weld, or 5 feet on each side of the tested length, whichever is less.

- c. **Weld Condition.** Clean paint, scale, grease, and other deleterious material from welded edges and surfaces. Grind flange welds flush on aligned sides and merge smoothly on transition sides.

Maintain areas requiring automatic and semi-automatic welding at a temperature of at least 40 °F for at least 1 hour before beginning work. Maintain the temperature during work.

If conducting radiography testing, grind web, shear, or pin plate splices. Grind the length of the film on the film side of the web, and begin merging smoothly at ends beyond the film. Grind fascia beams on the inside of the girder.

Grind surfaces to a roughness rating of 125 micro inches per inch root mean square. Remove loose mill scale on joint sides ultrasonically tested to allow one bounce of the ultrasound with a 70-degree transducer. Remove glycerine with a solvent before welding or blast cleaning the steel.

- d. **Defective Welds.** Repair and replace welds with rejectable defects documented by Contractor personnel or Department personnel, regardless of testing method and regardless of conflicts in test results from other methods. Submit repair procedures in writing and obtain the Engineer's approval for the repair method of weld defects before beginning repairs.

Repair, or remove and replace welds in accordance with AWS Code. Retest repaired or replaced welds, including at least 3 inches on all sides of the repair, by non-destructive testing method.

Remove and replace the entire weld if second repair attempts do not succeed. If the Engineer determines defects, or repairs to defects excessive, or the same defect undergoes repair more than twice, the Engineer may reject the entire piece.

11. **Fit of Stiffeners.** Remove and correct stiffeners showing evidence of compressive stress after fitting is completed, including waviness along the stiffener length, before final welding.
12. **Pins and Link Plates.** The contract drawings show the nominal diameter of pins. The fabricator may establish the exact diameter of the pin, show it on the shop drawings within +0 inch and  $-1/32$  inch of the nominal diameter and then fabricate the pin to within  $\pm 0.005$  inch.

Use stainless steel hanger pins. Finish the surface to less than 16 micro inches per inch, root mean square (rms) on the bearing surface, and less than 125 micro inches per inch rms on the ends.

Finish the surface on link plates to less than 125 micro inches per inch rms on cut edges and bored holes.

Orient the longitudinal axis of the link plates and pins in the direction of rolling or forging of plates or bars.

Do not weld on pins or link plates. Finish pin holes smooth, straight, at right angles to the axis of the member, and parallel to each other.

Do not exceed  $1/32$  inch variation from the required distance from outside to outside of adjacent pin holes in tension members, or from inside to inside of adjacent pin holes in compression members. Bore built-up members after welding. Drill or bore link plates in a jig or in assembled pairs.

Drill or bore the pin hole in the web  $1/32$  inch  $\pm 0.005$  inch, larger than the pin diameter.

13. **Bushings for Pins and Link Plates.** Prime the inside of the holes in the link plate with an organic zinc-rich primer before installing bushings. Install bushings before the primer dries. Install bushings with an interference fit of at least 0.001 inch. Provide a clearance from 0.005 inch to 0.015 inch between the inside diameter of the bushing and the finished diameter of the stainless steel pin.
14. **Bearings and Bearing Surfaces.** The Contractor may build up sole plates 3 inches thick, or greater, by welding together plates at least  $1\frac{1}{2}$  inches thick.

Bevel plate edges  $1/4$  inch and weld with a continuous weld along the full perimeter. Plane the top and bottom surfaces of column and pedestal base plates and cap plates or, if less than 4 inches thick, flatten by pressing. Face member parts, contacting column and pedestal base plates and cap plates, to fit.

Ensure sole plates on beams and plate girders fully contact flanges. Seal weld around sole plates. Plane, heat straighten, or flatten by pressing, sole plates and masonry plates. If planing is required on welded pedestals, complete the welding first. The Engineer does not require planing surfaces bearing on elastomeric bearing pads. Ensure planed or bored bearing surfaces meet the following roughness rating values:

- a. Bridge rockers, 250 micro inches per inch rms; and
- b. Pin holes and sliding bearings, 125 micro inches per inch rms,

Galvanize and apply the tie coat, intermediate coat, and top coat to steel material for bearings, except the portion welded to beams, after fabricating the bearing.

15. **Finished Members.** Provide finished members, true to the line shown on the plans, and free of twists, bends, and open joints.

Dull or flatten the corners of exposed steel edges by grinding or other Engineer-approved methods before shop cleaning.

Repair damage caused by handling, to the Engineer's satisfaction.

16. **Correction of Errors or Defects.** Obtain the Engineer's approval for the proposed method of correcting errors or defects in fabricated material, before beginning work. Perform corrections in a timely manner, unless the Engineer approves delaying the work until later fabrication stages.

Obtain written approval from the Engineer before beginning corrective work paid by the Department. Maintain an accurate record of the labor, equipment, and materials and present an itemized bill for approval by the Engineer. Correlate records daily with those kept by the Inspector.

17. **Galvanizing Structural Steel.** Hot-dip galvanize position dowels and anchor bolts, including nuts and washers, in accordance with AASHTO M 232. Tap oversized galvanized nuts in accordance with AASHTO M 291 or AASHTO M 292 and meet Supplementary Requirement S1 of AASHTO M 291 or AASHTO M 292. Remove excess hot-dip galvanizing on threaded portions by centrifuging or air blasting upon withdrawal. Do not flame-chase.

Before galvanizing, prepare steel components in accordance with SSPC-SP8 Pickling.

Galvanize portions of bearings not welded to the beam or girder, and other structural members and parts requiring galvanizing in

accordance with AASHTO M 111. Blast clean fabricated components to remove mill scale and welding slag before galvanizing.

If top coating galvanized surfaces, use the “dry process” during galvanizing. Do not quench galvanized components following galvanizing. Do not apply chromate surface passivation treatments to galvanized components requiring top coats.

18. **Handling and Storing Materials.** Store structural material on platforms, skids, or other supports above high water elevations. Maintain materials free of dirt, oil, or other contaminants and protect from corrosion. Pad structural members in storage at points of contact. Pitch trough sections to provide drainage. Support long members at frequent intervals to prevent deflection. Handle, store, and brace girders and beams in the erected position, unless otherwise authorized by the Engineer, and avoid distortion.

Protect fasteners from dirt and moisture on the project. Remove from protected storage, the number of fasteners required to be installed and tightened during a work shift. Return unused fasteners to protected storage at the end of shifts. Do not remove lubricant required for fasteners in the as-delivered condition. Clean, relubricate, and test fasteners for slip-critical connections that accumulate rust or dirt from site conditions, before installation.

Handle structural steel members and parts of primary member with clamps or plate hooks that do not leave nicks, gouges, or depressions. Repair damage to primary members using methods approved by the Engineer. Repair damage consistent with the delivery of structural steel in accordance with ASTM A 6, and AWS D 1.5, Bridge Welding Code, Section 3. Do not use chains or chokers for handling structural steel, unless placing a protective shield between the chain and the steel. Minimize handling stresses on beams and girders during transportation, storage, and erection. Use one-point pickup so overhang does not exceed the values specified in Table 707-3. Do not exceed the distances specified in Table 707-3 between hooks for two-point pickup.

| <b>Table 707-3</b>                                |                       |                       |                       |                          |
|---|-----------------------|-----------------------|-----------------------|--------------------------|
| <b>Rigging Requirements</b>                       |                       |                       |                       |                          |
| <b>Beam Size</b>                                  | <b>30 inch<br/>WF</b> | <b>33 inch<br/>WF</b> | <b>36 inch<br/>WF</b> | <b>Plate<br/>Girders</b> |
| Overhang for One-Point<br>or 2-Point Pickup, Max  | 37 ft                 | 40 ft                 | 42 ft                 | 50 ft                    |
| Distance Between Hooks<br>for 2-Point Pickup, Max | 74 ft                 | 80 ft                 | 85 ft                 | 100 ft                   |

19. **Marking and Shipping.** Provide the Department with copies of material orders and shipping statements, as directed by the Engineer. Show the weights of individual members on the statements. Mark weights on the member if greater than 6 tons.

If using low stress stamping equipment, the fabricator may stamp members if approved by the Engineer. Do not stamp link plates, pin plates, or pins. If stamping primary members, stamp before coating, in the top flange cross-sectional area or on the top of the compression flange, within 6 inches of the end. Show the match-marking scheme on the shop drawings. Markings must be legible after completion of the final coating system.

Load, transport, and unload structural members using trucks or railcars, without stressing, deforming, or otherwise damaging members. Place a protective shield between the chain or chain binder and primary members during shipping, to prevent gouging the flange edges or damaging the coating.

Pack bolts, loose nuts, and washers of each length, diameter, or size, separately. Store and ship pins, small parts, and packages of bolts, washers, and nuts in clean, moisture proof boxes, crates, kegs, or barrels. Limit the gross weight of each package to 300 pounds. Provide a list and description of contents on the outside of each shipping container.

#### D. **Erection of Structural Steel.**

1. **Methods and Equipment.** Before beginning work, obtain the Engineer's approval for proposed equipment and erection methods. Do not use material intended for the finished structure for erection or temporary purposes unless otherwise shown on the plans or approved by the Engineer.

The Engineer's approval does not relieve the Contractor of the responsibility for the safety of the method or equipment.

2. **Bearings.** Position column bases, truss and girder pedestals, shoes, and bearing plates with a full, uniform bearing on the substructure concrete. Adjust bearing plate and masonry plate locations and rocker positions to compensate for temperature at the time of erection.
3. **Falsework.** Build and remove falsework in accordance with subsection [706.03.C](#) and subsection [706.03.O](#).
4. **Straightening and Repair of Damaged Material.** Straighten plates, angles, other shapes, and built-up members, with the Engineer's

approval, without producing cracks or other damage. Straighten distorted members by carefully planned and supervised application of limited localized heat. Do not exceed 1,200 °F on heated areas, as determined by temperature-indicating crayons, liquids, or bimetal thermometers. Do not apply mechanical forces for straightening.

Inspect the surface of the metal for damage after straightening. Perform nondestructive testing, as directed by the Engineer.

5. **Assembling Steel.** Assemble parts according to the plans and shop drawings. Do not damage steel during erection. Clean rust, loose mill scale, dirt, oil or grease, and other deleterious material from bearing surfaces and surfaces in permanent contact before assembly.

At the time of erection, coat machine finished surfaces with a commercial grade lubricant approved by the Engineer. Lubricate pedestal and rocker-to-sole plate surfaces and sliding metal-on-metal bearing surfaces.

Align all parts in splices and field connections before inserting connection bolts. The Engineer may direct filling at least 10 percent of each splice connection with temporary bolts to bring the plies of steel tight before installing permanent bolts. Install permanent bolts in remaining splice locations and commence turn-of-nut tightening of the permanent bolts in accordance with subsection [707.03.D.7.c](#). Remove temporary bolts and replace with permanent bolts. Tighten using turn-of-nut method.

In bolted connections, do not expose nuts in fascia girder outer faces or on the bottom faces of lower flanges.

If field splicing girders in the air, install  $\frac{1}{3}$  of the bolts, evenly distributed over the connecting elements, and snug tighten before releasing lifting devices.

Tighten bolts in spans of continuous girders in accordance with subsection [707.03.D.7.c](#) before casting deck concrete.

6. **Misfits.** Correct and replace misfits, errors, and damage at no additional cost to the Department. Obtain the Engineer's approval for correction methods. Do not force structural members into place.

The Engineer will witness correction methods.

7. **Bolted Connections.** Do not exceed a 1:20 slope on the surfaces of bolted parts in contact with bolt heads and nuts, with respect to a plane perpendicular to the bolt axis. Use beveled washers to



compensate for slopes greater than 1:20. Fit bolted parts solidly together and do not separate with compressible material.

During assembly, maintain joint surfaces free of mill scale, burrs, dirt, and other deleterious material. Use the same combinations of tested nut, bolt, and washer lots for field assembly as those tested and approved by the Engineer for use in combination.

- a. **Washers.** Install a hardened washer under the fastener element turned during tightening. Seat the element for turning during tightening against a non-sloping surface.

Use smooth beveled washers where necessary to compensate for the surface slope of bolted parts with respect to the bolt head or nut.

- b. **Bolt Tension.** Tighten each fastener in accordance with Table 707-4.

Tighten bolts using the turn-of-nut method in accordance with subsection [707.03.D.7.c](#). If required because of bolt entering and wrench operation clearances, tighten by turning the bolt while preventing the nut from rotating.

If using impact wrenches, provide wrenches sufficient to tighten each bolt in approximately 10 seconds. Perform verification testing, witnessed by the Engineer, on a representative sample of at least three bolt assemblies of each diameter, length, and heat or lot. Test at the beginning of work in a device that shows bolt tension. Show that the method for estimating the snug tight condition, and controlling the turns from snug tight, develops a tension of at least 5 percent greater than the tension specified in Table 707-4, when performed by the bolting crew. Perform periodic retesting if directed by the Engineer.

| <b>Bolt Size<br/>(in)</b> | <b>Minimum Bolt Tension (lb),<br/>(a)</b> |
|---------------------------|---|
| ½                         | 12,050                                    |
| ⅝                         | 19,200                                    |
| ¾                         | 28,400                                    |
| ⅞                         | 39,250                                    |
| 1                         | 51,500                                    |
| 1⅛                        | 56,450                                    |
| 1¼                        | 71,700                                    |
| 1⅝                        | 85,450                                    |
| 1½                        | 104,000                                   |

a. Equal to 70% of specified minimum tensile strength of bolts.

- c. **Turn-of-Nut Tightening.** Bring enough bolts to a snug tight condition to ensure parts of the joint fully contact. Snug tight is the tightness attained by a few impacts of an impact wrench, or the full effort of a person using an ordinary spud wrench. Place bolts in remaining holes in the connection and bring to snug tightness. Mark each bolt to reference the rotation required for tightening. Tighten all bolts in the joint by rotating the nut in accordance with Table 707-5. Tighten systematically from the most rigid part of the joint to the free edges. Ensure parts, not turned by the wrench, do not rotate during tightening operations.

Do not reuse AASHTO M 164 bolts and nuts. The Engineer will not consider re-snugging previously tightened bolts loosened by the tightening of adjacent bolts, as reuse.

| Table 707-5<br>Nut Rotation from Snug Tight Condition (a)   |   |                                 |                            |
|---|---|---------------------------------|----------------------------|
| Disposition of Outer Faces of Bolted Parts  |   |                                 |                            |
| Bolt Length<br>(b)  | Two<br>Normal (c)   | One Normal One<br>Sloped (c, d) | Two Sloped<br>Faces (c, d) |
| ≤4D   | 120°+30°  | 180°+30°                        | 240°+45°                   |
| >4D – 8D  | 180°+30°  | 240°+45°                        | 300°+45°                   |
| >8D – 12D   | 240°+45°  | 300°+45°                        | 360°+45°                   |
| >12D  | No data; determine required rotation by tests<br>simulating actual conditions |                                 |                            |
| a. Nut rotation is relative to bolt, regardless of the element (nut or bolt) being turned.<br>b. Measured from underside of head to extreme end of point. "D" is nominal bolt diameter.<br>c. Relative to bolt axis.<br>d. Sloped face not more than 1:20; no bevel washer. |   |                                 |                            |

- d. **Inspection.** The Engineer will determine if bolts meet the requirements for bolt tension. Provide the Engineer with the opportunity to witness the bolt snugging, marking for final rotation, and tightening.
8. **Field Welding.** Do not field weld unless otherwise shown on the plans or approved by the Engineer. Obtain Engineer's approval for welding procedures before beginning field welding. Perform field welding and nondestructive testing in accordance with AWS D1.5, Bridge Welding Code.

Perform structural field welding by the SMAW process using E7018 electrodes. Do not use Gas Metal Arc Welding (GMAW), or other gas shielded processes. The Engineer may approve SAW and Flux Cored Arc Welding (FCAW) for field welding.

- a. **Qualification.** For welder qualification, test field welders. The Engineer will witness testing. The Engineer will not accept welder tests by other agencies. Perform welder qualification tests in accordance with AWS D1.5, Part B, Section 5, in the same position required for field welding, as determined by the Engineer. Field welder qualifications remain in effect for two years, unless the welder does not engage in welding for at least three months, or a specific reason exists to question the welder's ability.

For procedure qualification, do not perform field welding until preparation of written welding procedures, as established by testing. Perform weld procedure tests in the same position and joint configuration required for the field welding. The Engineer will approve the written welding procedures after completion of successful weld testing. Test in accordance with AWS D1.5, Section 5. Perform tests on the same steel plate material type for welding, and provide mill certification.

- b. **Welding Requirements.** Blast clean or grind contact surfaces, joints, and surrounding area before field welding. Remove loose mill scale, paint, galvanizing, grease, oil, rust, moisture, and other deleterious material from base metal before welding. Grind joints before field welding to remove pitting and irregularities. Prepare joints and remove deleterious material in accordance with AWS D1.5, Section 3.

Bring parts into close contact. If the separation between parts exceeds  $\frac{1}{16}$  inch, increase the legs of the fillet weld by the separation distance. Do not weld if the separation between parts exceeds  $\frac{3}{16}$  inch.

Transition weld profiles by grinding stop-start areas or other irregularities.

Do not perform field welding if the ambient air temperature falls below 40 °F or during periods of precipitation, unless heating and housing the area as approved by the Engineer.

Dry electrodes in an oven at a temperature of at least 500 °F for at least 2 hours before use. Store the electrodes at a temperature of at least 250 °F after drying. Use electrodes within 2 hours of exposure to the atmosphere, or redry. Do not redry electrodes more than once. Do not use electrodes that have been wet.

Preheat surfaces for welding 3 inches in every direction from the weld. Before welding, preheat surfaces to at least 250 °F for base metal no greater than 1½ inches thick. For base metals from 1½ inches thick to 2½ inches thick, preheat to at least 300 °F. If welding on plates greater than 2½ inches thick, preheat to at least 400 °F.

- c. **Inspection.** The Engineer will verify that the nondestructive testing, including visual inspection has been performed in accordance with, and the welds are acceptable according to, AWS D1.5. The Contractor is responsible for nondestructive testing of field welds. Blast clean or grind welds before conducting nondestructive testing. Use liquid dye penetrant or magnetic particle testing for fillet and partial penetration butt welds. Use ultrasonic testing for complete penetration butt welds, plug welds, and slot welds.

Perform nondestructive testing in accordance with subsection [707.03.C.10](#) and AWS D1.5. The Engineer will determine the frequency, location, and type of nondestructive testing. Personnel qualified as Level II or Level III in accordance with the American Society for Nondestructive Testing (ASNT), Recommended Practice No. SNT-TC-1A must perform all tests. Ensure an AWS Certified Weld Inspector (CWI) inspects all welds. Ensure testing personnel provide certifications to the Engineer before beginning the work. The Engineer will witness nondestructive testing.

Repair cracked welds, or welds the Engineer determines are unacceptable. Repair welds in accordance with AWS D1.5, Section 3.7. Inspect and test repaired welds before the Engineer's acceptance. Repair and retest welds at no additional cost to the Department.

- d. **Welding Piles or Falsework.** Agencies approved by the Department may perform welder qualification tests for welding piles or falsework. Structural welding or welding repair work requires Department qualification testing.

Ensure field welders present a certificate documenting qualification within the previous two years in accordance with the Department's Welder Certification by Agency program. Conform welding to AWS D1.1. The Engineer may require a confirming qualification test during the progress of the work.

- e. **Welding for Form Supports and Accessories.** If no other methods exist, the Engineer may allow welding to primary steel members. Prepare and submit to the Engineer for written approval, a detailed plan of operations if welding to primary steel members is anticipated. If the Engineer allows, weld to steel beams in compression areas only.

Ensure the field welder presents a certificate documenting qualification within the previous two years in accordance with the Department’s Welder Certification by Agency program. Conform welding to AWS D1.1.

- f. **Shear Developers.** Do not weld if the temperature falls below 32 °F or if the surface is wet or exposed to rain or snow.

Remove rust, mill scale, paint, and galvanizing from the base metal at the stud location by grinding. Clean the stud end. End weld stud shear connectors to steel beams or girders with automatically timed stud welding equipment. When using automatically timed stud welding equipment, do not preheat the top of the beam flange. Perform and test stud welding in accordance with AWS D1.5, Bridge Welding Code.

Repair studs without a full 360-degree fillet weld by adding a 5/16-inch fillet weld to replace missing welds.

**707.04. Measurement and Payment.**

| <b>Pay Item</b>                                   | <b>Pay Unit</b> |
|---|-----------------|
| Structural Steel, Rolled Shape, Furn and Fab..... | Pound           |
| Structural Steel, Rolled Shape, Erect.....        | Pound           |
| Structural Steel, Plate, Furn and Fab.....        | Pound           |
| Structural Steel, Plate, Erect.....               | Pound           |
| Structural Steel, Mixed, Furn and Fab.....        | Pound           |
| Structural Steel, Mixed, Erect.....               | Pound           |
| Bearing, Elastomeric, __ inch.....                | Square Inch     |
| Shear Developers (Structure No.).....             | Lump Sum        |
| Bushing.....                                      | Each            |

A. **Structural Steel.** The Engineer will measure structural steel by the calculated weight of metal in the finished structure, excluding filler metal in welding, as shown on shop plans or working drawings. The Engineer will calculate the weight using the rules and assumptions specified in this subsection.

Unless otherwise required, the following metal weights apply:

1. Steel — 0.2833 pound per cubic inch;

2. Cast iron — 0.26 pound per cubic inch;
3. Bronze — 0.315 pound per cubic inch; and
4. Lead — 0.411 pound per cubic inch.

The Engineer will calculate the weights of rolled shapes and plates incorporated in the finished work on the basis of nominal weights and dimensions, as shown on the approved shop drawings, deducting for copes, cuts, and holes, except those for high strength bolts.

The Engineer will include the total calculated weight of bolts, nuts, and washers in the finished work in the weight of structural steel.

The Engineer will calculate the weight of castings from the dimensions shown on the approved shop drawings with an addition of 10 percent for fillets and overrun.

The Engineer will not make allowance for galvanizing, optional splices, lifting lugs, shop coating, or excess bolts in the calculated weight.

The Engineer will not include the weight of lifting lugs in the calculated weight for structural steel. The unit prices for structural steel pay items include the cost of providing, welding, and removing the lugs.

**B. Welding.** The Department will not pay for welding and nondestructive testing required for new, retrofitting, repairing, rehabilitation, or replacing structural steel components, including shop fabrication and field welding.

The Department will not pay for welding and submittal of qualification specimen costs, including nondestructive testing of weld specimens by radiography or ultrasonic testing and confirming test specimens. The Department will cut, machine, and test specimens without charge, except the Contractor is responsible for the cost of testing additional specimens if the first test specimens fail.

**C. Structural Steel Plants.** The Department will not allow additional compensation for costs incurred in the certification of structural steel plants, or claims by the Contractor for delays and inconvenience attributed to certification requirements.

**D. General.** The unit prices for **Structural Steel, Erect** pay items include the cost of installing and removing temporary bolts as directed by the Engineer. The unit price for **Structural Steel, Erect** pay items include the cost of field drilling.

The unit prices for **Structural Steel, Furn and Fab** pay items include the cost of shop cleaning and coating the steel.

## 707.04

The Engineer will measure **Bearing, Elastomeric**, of the size required, by area, with no deductions for holes. The unit price for **Bearing, Elastomeric** includes the cost of steel laminates bonded to the elastomeric bearing.

The Engineer will measure **Shear Developers** as a unit for each structure. The unit price for **Shear Developers** includes the cost of providing studs, cleaning the surface by grinding, and welding studs to the girder flanges.

The unit price for **Bushing** includes the cost of priming the inside holes in the link plate and providing and installing the bushing.

The cost of supplying, installing, and removing temporary bolts at splice connections when this work is required by subsection [707.03.D](#), is included in the unit price for relevant pay items.

## Section 708. PRESTRESSED CONCRETE

**708.01. Description.** This work consists of manufacturing and erecting prestressed concrete.

**708.02. Materials.** Provide materials in accordance with the following:

|                                     |                     |
|-------------------------------------|---------------------|
| Mortar and Grout .....              | <a href="#">702</a> |
| Cement .....                        | <a href="#">901</a> |
| Coarse Aggregate 6AA, 17A .....     | <a href="#">902</a> |
| Fine Aggregate 2NS .....            | <a href="#">902</a> |
| Admixtures .....                    | <a href="#">903</a> |
| Fly Ash.....                        | <a href="#">901</a> |
| Prestress Strand.....               | <a href="#">905</a> |
| Post-tensioning Strand or Bar ..... | <a href="#">905</a> |
| Reinforcing Steel .....             | <a href="#">905</a> |
| Steel Welded Wire Fabric.....       | <a href="#">905</a> |
| Structural Steel.....               | <a href="#">906</a> |
| Water .....                         | <a href="#">911</a> |

Provide natural aggregate for Coarse Aggregate 6AA or 17A in accordance with subsection [902.02](#).

The Contractor may substitute natural aggregate 17A for 6AA if 17A natural aggregate meets the physical requirements of 6AA in accordance with Table [902-2](#) and has a maximum freeze-thaw dilation of 0.010 percent per 100 cycles, based on 6AA gradation.

Use non-deformed steel rods in accordance with AASHTO M 270 Grade 36 and hot-dip galvanized in accordance with AASHTO M 111, as position dowels for precast beams.

Use prestress strand, free of oil, dirt, paint, rust and other results of corrosion, and deleterious material that prevents bonding between strands and concrete. Do not use a reel or pack of strand if one or more wires in the strand show a coating of adherent rust that light rubbing cannot remove. Do not use strand that contains adherent rust, pits visible to the naked eye, kinks, bends, nicks, or other defects. Cover prestress strand stored outside with waterproof tarps and block above the ground to prevent contact with soil and water. Do not use strand without identification.

Select a de-bonding compound for prestressed concrete 1800 Beam Flange from the Qualified Products List, or provide a Department-approved equal. Follow the manufacturer's specifications and procedures for mixing the compound.



**708.03. Construction.****A. Construction of Prestressed Concrete.**

1. **Plant Certification.** For bridge beams, use plants certified by the Prestressed Concrete Institute (PCI) for Category B3, Prestressed Straight Strand Bridge Beams, or Category B4, Prestressed Deflected Strand Bridge Beams. For products requiring draped strands, use plants certified for Category B4, Prestressed Deflected Strand Bridge Beams. For miscellaneous prestressed concrete products, use plants certified for Category B2, Prestressed Miscellaneous Bridge Products, or Category C2, Prestressed Hollow Core and Repetitively Produced Products.

Immediately correct items that do not conform to PCI plant certification. Provide a copy of the certificate of conformance to the Engineer before beginning production. Display the certificate of conformance in each plant facility. Provide inspection facilities in accordance with section [809](#) and subsection [707.03.A.2](#).

2. **Shop Plans.** Submit shop plans in accordance with subsection [104.02](#). Show complete fabrication details and initial prestressing forces. Send three sets of drawings to the Engineer for review and approval. Do not start production until the Engineer approves the shop plans.
3. **Notifying the Engineer.** Notify the Engineer at least one week before beginning the manufacture of concrete beams.
4. **Equipment.**
  - a. **Forms.** Use metal forms. Ensure forms meet the requirements of subsection [706.03.D](#).  
The fabricator may use wood forms for bulkheads.
  - b. **Specimen Molds.** Use specimen molds for making test specimen in accordance with ASTM C 470.
  - c. **Curing Tank.** Provide a Department-approved curing assembly, consisting of a water tank equipped with thermostatic controls. Maintain lime-saturated water at 70 °F ±5 °F. Provide a tank sized to contain the required number of 28-day test specimens.
  - d. **Compression Testing Machine.** Provide a compression testing machine in accordance with ASTM C 39. Submit to the Engineer, a calibration certificate no greater than 12 months old.

5. **Void Boxes, Inserts, and Attachments.** Design and construct void boxes, inserts, and attachments to withstand forces imposed during fabrication without bulging, sagging, collapse, or other deformation. Fasten void boxes, inserts, and attachments to maintain the proper position during concrete placement and compaction. Place weep-holes to provide drainage for voids. Puncture weep holes immediately after removal from casting bed.
6. **Design and Proportioning of Concrete Mixtures.** Design a concrete mixture meeting the following requirements:
- Air content of 5.0 percent to 8.0 percent, except as specified in item e;
  - 28-day compressive strength as shown on the plans;
  - Slump from  $\frac{3}{4}$  inch to  $2\frac{1}{2}$  inches if not using water-reducing or retarding admixtures;
  - Slump no greater than 4 inches if using a Type A or Type D chemical admixture;
  - Slump no greater than 8 inches and an air content no greater than 8.5 percent if using a Type F or Type G chemical admixture; and
  - At least 564 pounds of cementitious material per cubic yard of concrete.

Provide cementitious material with fly ash content no greater than 25 percent of the total weight of the cementitious material. Provide slag cement content no greater than 40 percent of the total weight. If using fly ash and slag cement in the same mixture, do not exceed 15 percent fly ash and 25 percent slag cement.

7. **Concrete Strength.** The Engineer will base acceptability of concrete strength on the results of compressive strength tests on standard 6 inch by 12 inch or 4 inch by 8 inch cylinders. Mold, store, and test cylinders at no additional cost to the Department.
- Molding and Curing.** Make at least six test cylinders from concrete for each prestressed product line. Make  $\frac{1}{3}$  of the cylinders from each of three separate batches or concrete loads in casting each product line.

The fabricator may mold and cure additional sets of three cylinders to determine concrete strength for acceptance at less than 28 days.

Mold and cure cylinders in accordance with ASTM C 31, except as modified by this subsection. Leave cylinders with the product or in the curing enclosure until stripping the member. Then,

remove the 28-day cylinders from molds and place in a water curing tank until testing. Leave remaining cylinders with the product until testing.

- b. **Testing and Acceptance.** Conduct compressive strength tests in the Engineer's presence. Test in accordance with ASTM C 39, except test specimens in moist condition resulting from required curing conditions.

Use one set of three test cylinders to determine the time of transfer of prestress from end anchorages to concrete.

Test optional test cylinder sets before the end of the 28-day curing period. Test all three cylinders of an optional set at the same time. The Engineer will accept optional cylinder test results, in place of the 28-day tests, if optional cylinder test results equal or exceed the 28-day strength requirements.

If optional cylinder test results do not meet or exceed the 28-day strength requirements, continue curing remaining sets of three test cylinders for the full 28-day period. Test remaining three cylinders at 28 days to determine acceptability of the concrete strength.

Do not ship product until it meets 28-day strength requirements.

Ensure test specimen compressive strengths meet the following conditions:

- i. The average of the compressive strength of the three test specimens equals at least the required minimum compressive strength; and
- ii. At least two of three specimens meet the required minimum compressive strength and the third specimen exhibits at least 60 percent of the required minimum compressive strength.

If test specimens do not meet the criteria, the Engineer may either reject products represented by the tests, or determine if the concrete has sufficient structural strength. If the Engineer determines concrete has sufficient structural strength, the Engineer will prorate the unit price for the pay item and quantity represented based on Formula 708-1:

$$A = \frac{S_t}{S_r} \times U$$

Formula 708-1

Where:

$A$  = The adjusted unit price,

$S_t$  = Tested strength,

$S_r$  = Required strength, and

$U$  = Unit price.

8. **Placing Reinforcing Steel.** Tie reinforcing steel. Tie epoxy coated steel with epoxy coated wire ties. Do not weld steel reinforcement.
9. **Bond Breaker.** If bond breaker is required, use two tubes, one inside the other, and turn the overlap in opposite directions.
10. **Placing Concrete.** Place concrete in accordance with subsection [706.03.H](#), and as modified as follows:
  - a. The fabricator may use external vibrators.
  - b. Protect fresh concrete from rain and cover forms during interruption of casting operations due to rain.
  - c. Maintain the concrete temperature from 45 °F to 90 °F, as close to 70 °F as practical, during placement.
11. **Curing Beams.** Protect concrete from cold weather. Construct curing enclosures to allow air or steam circulation around exposed portions of the concrete. Cure concrete at temperatures from 70 °F to 160 °F until concrete attains the release strength shown on the shop plans.

Maintain the required temperature during the curing period with steam or radiant heat.

Apply steam or radiant heat after concrete reaches initial set in accordance with ASTM C 403, without damaging the concrete. During the waiting period, maintain the ambient temperature in the curing enclosure from 50 °F to 70 °F.

Do not direct steam or radiant heat at the concrete or the forms, causing localized high temperatures. During initial application of steam or radiant heat, increase the ambient temperature in the curing enclosure by no greater than 80 °F per hour until reaching the curing temperature. Maintain the maximum curing temperature within the enclosure until concrete reaches the desired temperature and strength. Do not exceed a maximum concrete temperature of 195 °F during the curing cycle. Upon curing completion, reduce the ambient temperature in the enclosure at a rate no greater than 80 °F per hour.

Provide recording thermometers for steam or radiant heat curing, capable of showing the time-temperature relationship in the curing enclosure from the time of concrete covering, to transfer of prestress. Use at least two recording thermometers per product line, at locations determined by the Engineer, to monitor the concrete and the curing rate. Graph time-temperature documentation and provide a copy to the Engineer for evaluation.

12. **Cracks in the Concrete.** The Engineer will evaluate cracked concrete for approval.
13. **Workmanship.**
  - a. **Concrete Defects.** Immediately after removing forms, patch air holes larger than 1 inch with Type R-2 mortar, as directed by the Engineer. The Engineer will evaluate concrete with honeycomb areas for approval.
  - b. **Finishing I-Beams.** Smooth finish the outer 1 inch of the top surface of the I-beam. Rough finish remaining I-beam top surfaces to provide a ¼ inch surface texture.
  - c. **Finishing 1800 Beams.** Smooth finish the outer 6 inches of 1800 beam top surfaces. Rough finish remaining 1800 beam top surfaces to provide a ¼ inch surface texture. Clean the outer 6 inches of the top surface and apply a de-bonding compound in accordance with the manufacturer's recommendations. Use a compound color that contrasts with 1800 beam flanges to show application after curing. Prevent compound from spreading over 1800 beam flanges or toward the center of the beam. Remove compound that exceeds the 6 inch boundary before it cures. Use solvents approved by the de-bonding compound manufacturer.
  - d. **Finishing Box Beams.** Smooth finish the outer 1 inch of the box beam top surface. Rough finish remaining box beam top surfaces to provide a ¼ inch surface texture unless otherwise required. If hot mix asphalt overlay is required, provide a wood float finish on the top surface.
  - e. **Sole Plates.** Hot-dip galvanize sole plates in accordance with AASHTO M 111.
  - f. **Bearing Surfaces.** Ensure bearing surfaces meet a flatness tolerance of ⅛ inch over 12 inches.
14. **Tolerances.** The Engineer will evaluate beams that do not conform to the dimensional tolerances specified in Table 708-1.

| <b>Table 708-1<br/>Dimensional Tolerances for Beams</b>  |   |
|--|---|
| <b>Beam Type</b>   | <b>Tolerance</b>  |
| Length of I-Beams and 1800 Beams   | $\pm\frac{1}{4}$ in/25 ft, 1 in max                       |
| Length of Box Beams  | $\pm\frac{3}{4}$ in                                       |
| Width of I-Beams and 1800 Beams  | $+\frac{1}{2}$ in, $-\frac{1}{8}$ in                      |
| Width of Box Beams   | $\pm\frac{1}{2}$ in                                       |
| Height of I-Beams, 1800 Beams, or Box Beams  | $+\frac{1}{4}$ in, $-\frac{1}{8}$ in                      |
| Camber Deviation From Design Value (Measured Within 24 h of Strand Release)  | $\frac{1}{8}$ in/10 ft                                    |
| Thickness of Top Slab of Box Beam  | $+\frac{1}{2}$ in, $-\frac{1}{4}$ in                      |
| Length of I-Beam End Blocks  | +2 ft, -0 in  |
| Sweep of I-Beams and 1800 Beams (Horizontal Deviation of Centerline from a Straight Line Between Ends Measured at Both Top and bottom) | $\frac{1}{4}$ in/10 ft                                    |
| Sweep of Box Beams (Horizontal Deviation of Centerline from a Straight Line Between Ends Measured at Both Top and Bottom)              | $\frac{3}{8}$ in up to 60 ft, $\frac{1}{2}$ in over 60 ft |
| Vertical Deviation of Side Forms Between Top and Bottom of Beam  | $\leq\frac{1}{4}$ in from plan location                   |
| Prestress Strand   | $\leq\frac{1}{4}$ in from plan location                   |
| Location of Conduit for Transverse Post Tensioning   | $\leq\frac{1}{2}$ in from plan location                   |
| Location of Holes for Position Dowels (I-beams and 1800 Beams)   | $\leq\frac{1}{2}$ in from plan location                   |
| Location of Holes for Position Dowels Box Beams  | $\leq 1$ in from plan location                            |

15. **Stress Transfer.** Do not transfer bond stress to concrete, or release end anchorages until concrete attains the required compressive release strength. Cut or release prestressing strand to minimize lateral eccentricity of prestress.

After detensioning strands, cut flush with the concrete surface and cover ends and depressions around cable ends with asphaltic material approved by the Engineer.

16. **Handling, Storage, and Transporting.** Handle and store products to prevent damage. Keep beams upright.

When moving a product, lift by the loop devices shown on the plans, unless the Engineer approves alternate lifting devices and procedures. Apply equal loads to each pair of lifting devices.

Support stockpiled beams across the full width on two battens, each greater than 4 inches wide. Do not support beams at more than two points.

Use battens to hold beams off the ground over the full length. Place battens in from the beam ends no greater than  $1\frac{1}{2}$  times the depth of the beams, or 3 feet, whichever is less. For skew beams, measure the distance along the centerline of the beam. Place battens to

support stacked beams, one above the other, along the same vertical plane, at each end of the beams.

Support beams during transport the same as stockpiled beams, except the Contractor may use trucks with two rear bolsters. If truck bolsters are worn, use wood shingles to give bearing. Place wood blocks under chains to hold beams in place on the trucks.

## B. Erection of Prestressed Beams.

1. **Box Beams.** Shim beam bearing pads during erection to provide full bearing contact with the bottom of the beam. Place seal washers, or other devices meeting the Engineer's approval, between the beams at the transverse conduit holes. After setting beams, drill position dowel holes into bridge seats through holes provided in each beam end. Insert dowels.

At the expansion bearings, fill position dowel holes with hot-poured rubber-asphalt type filler to at least 3 inches above the position dowels. Fill the remainder of the hole with Type H-1 grout. Fill holes at fixed bearings with Type H-1 grout.

After setting beams in final position, clean the beams with water, and grout longitudinal joints and the surfaces between beams. Use Type R-2 grout with a slump of 5 inches and place when the air temperature rises above 40 °F. Fill spaces between beams full-depth. Rod the grout into the space to form a tight, solid joint. Cure for 48 hours. After grout cures, post-tension the deck transversely. Tension tendons to the force required, except do not exceed the yield stress of the material.

After tensioning, clean the annular space between the tendon and hole by flushing with water. Remove water with compressed air. With the grouting vent open at one end of the hole, inject Type E-1 grout under pressure at the other end. Continue injecting grout until material comes out through open vents. Close open vents while maintaining grout pressure. Gradually increase pressure to at least 50 psi and hold for 15 seconds. Close the inlet valve. Remove lifting devices.

2. **I-Beams and 1800 Beams.** Place beam bearing pads over the position dowel and shim to provide full bearing contact with the bottom of the beam. Position beams on the substructure and rigidly block them in place before beginning deck and diaphragm forming. Remove lifting devices.

**708.04. Measurement and Payment.**

| <b>Pay Item</b>                           | <b>Pay Unit</b> |
|---|-----------------|
| Prest Conc Deck, __ inch .....            | Square Foot     |
| Post Tensioning (Structure No.) .....     | Lump Sum        |
| Prest Conc Box Beam, Furn, __ inch .....  | Foot            |
| Prest Conc Box Beam, Erect, __ inch ..... | Foot            |
| Prest Conc I Beam, Furn, __ inch .....    | Foot            |
| Prest Conc I Beam, Erect, __ inch .....   | Foot            |
| Prest Conc 1800 Beam, Furn .....          | Foot            |
| Prest Conc 1800 Beam, Erect .....         | Foot            |

The unit prices for **Prest Conc, Erect** pay items include the cost of position dowels, shimming to provide full bearing contact, and bracing and blocking.

The Engineer will measure prestressed concrete box beams, placed a nominal 1½ inches apart, as **Prest Conc Deck**, based on the nominal overall length of the units, multiplied by the overall plan width. Plan width is the sum of the widths of the beams plus the sum of the 1½-inch spaces between beams.

The Engineer will measure prestressed concrete box beams, placed more than a nominal 1½ inches apart, as **Prest Conc Box Beam, Furn, \_\_ inch**, and **Prest Conc Box Beam, Erect, \_\_ inch**, and based on the nominal length of the unit.

The Engineer will measure **Prest Conc I Beam Furn, \_\_ inch**, and **Prest Conc I Beam, Erect, \_\_ inch**; and **Prest Conc 1800 Beam, Furn**, and **Prest Conc 1800 Beam, Erect**, based on the nominal length of the units. The unit prices for **Prest Conc I Beam, Furn, \_\_ inch**, and **Prest Conc 1800 Beam, Furn**, include the cost of de-bonding beam flange

The Engineer will measure and the Department will pay for elastomeric bearings in accordance with subsection [707.04](#).

The Department will not allow additional compensation for costs incurred in the certification of prestressed concrete plants, or claims by the Contractor for delays or costs associated with prestressed concrete fabrication plant certification.



## Section 709. TIMBER STRUCTURES

**709.01. Description.** This work consists of providing, fabricating, and placing structural timber, lumber, timber piling, hardware, castings, and other accessories in structures consisting entirely, or in part, of timber.

**709.02. Materials.** Provide materials in accordance with the following:

|                                   |                     |
|-----------------------------------|---------------------|
| Structural Steel .....            | <a href="#">906</a> |
| Miscellaneous Metals .....        | <a href="#">908</a> |
| Hardware .....                    | <a href="#">908</a> |
| Structural Timber and Lumber..... | <a href="#">912</a> |
| Timber Piles.....                 | <a href="#">912</a> |
| Preservative Treatments .....     | <a href="#">912</a> |

### 709.03. Construction.

**A. Storage of Materials.** Store lumber and timber to prevent contamination from dirt and water.

Closely stack treated material to prevent long timbers or pieces with small cross sections from sagging or becoming crooked. If the Engineer directs, cover the pile with a layer of tarpaper, or equivalent, and at least a 1-inch layer of sand or earth to protect the pile from long exposure to direct sunlight or possible fire hazard.

**B. Workmanship.** Drive nails and spikes to set the heads flush with the surface of the wood. Do not make deep or frequent hammer marks in surfaces or edges of timbers.

Tighten bolts to draw all fastened parts together. Workmanship on metal parts must be in accordance with subsection [707.03](#).

### C. Framing and Placing Treated Timber and Piling.

1. **Handling.** Avoid damaging the edges of timbers or exposing untreated wood. Do not use peavies, cant hooks, timber dogs, or other pointed tools on treated timber. Use clamps on timber or piling to support staging or other construction facilities. The Engineer will not allow temporary bolting, spiking, or nailing of treated timbers.

2. **Framing and Boring.** Cut, frame, and bore treated timbers as close to plan dimensions as possible before treatment. Cut and frame lumber and timber so the joints will have even bearing over the entire contact surfaces.

Do not shim in making joints, unless approved by the Engineer. The Engineer will not accept open joints.

If the Engineer allows the use of shims, use pressure treated timber shims.

Bore holes for hardware in accordance with Table 709-1.

| <b>Table 709-1<br/>Hardware Hole Sizes</b> |   |
|--|---|
| <b>Hardware</b>                            | <b>Hole Size</b>                                      |
| Round Driftpins and Dowels                 | $\frac{1}{16}$ in < diameter of the pin or bolt       |
| Square Driftbolts or Dowels                | Equal to the smallest dimension of the bolt or dowel  |
| Machine Bolts and Rods                     | $\frac{1}{16}$ in > the diameter of the bolt or rod   |
| Lag Bolts                                  | $\leq$ the body of the bolt at the root of the thread |

3. **Pile Driving.** Provide and drive piling for timber construction in accordance with section [705](#).
4. **Sills.** Splice sills only as approved by the Engineer. Bed sills as shown on the plans. If placing sills directly on the foundation soil, provide a continuous firm and uniform bearing for the full length of the sill and carefully tamp in position with backfill material. If required, construct a mortar bed to ensure a uniform and even bedding on hard foundation soil, using a 1:2 mix of cement and sand. Spread the mortar so it is at least 3 inches thick under the full bearing area of the sill, and embed the sill in the mortar 1 inch. Bed grillages or mats to allow uniform bearing of sills. Finish the top surface of concrete pedestals smooth and to a single plane to provide uniform and even bearing for sills or posts. Size sills to a single plane at the bearings of posts.
5. **Field Treatment.** Trim and coat field cuts, except pile cutoff; daps; field bored holes; and abrasions in treated piles, lumber, and timber in accordance with subsection [912.03](#).

Coat with at least two coats of preservative allowing at least 2 hours between applications. After cut-off, treat the tops of the treated timber piles, in accordance with subsection [912.03](#). Apply three coats of preservative in accordance with the manufacturer's recommendations. Plug unfilled holes, after treating, with preservative treated plugs.

6. **Caps.** Size caps and bring them to a uniform thickness and even bearing on piles or posts. Place the side with the most sap wood, downward. Fasten caps to posts or piles with the drift bolts extending an equal distance into cap and post or pile.

After installing the caps, trim portions of the pile extending beyond the pile caps to drain off water, and treat in accordance with subsection [709.03.C.5](#).

7. **Posts.** Saw posts to the required length for their position (vertical or batter) and to even bearing on the cap and sill.
8. **Braces.** Frame and fasten sash and sway bracing, and longitudinal bracing to piles or posts. To accommodate variation in the size of piles, use filling pieces between braces and the piles of a bent, and securely fasten and face to obtain bearing against piles. Fit braces from the bottom, and cut to length at the top. Treat the cut surface in accordance with subsection [709.03.C.5.](#)
9. **Stringers.** Size stringers at bearings to a uniform depth and place in position so knots near edges will be in the top portion of the member; otherwise, turn the edges with the most sapwood down. Lap interior stringers to take bearing over the full width of the cap or floor beams. Frame cross bridging between stringers to a full bearing against the sides of the stringers and nail in place.
10. **Floor Plank.** Ensure floor planks are at least 10 inches wide. Plane base plank and plank for single plank floors on one side and one edge (S1S1E) and closely lay them with the surfaced side down. Ensure surface or top course plank are surfaced on four sides (S4S). Stagger joints in base plank or surface plank. Nail base plank at both edges at all points of support. Nail surface or top course plank at both edges at intervals no greater than 9 inches. Provide nails or spikes with a length equal to twice the thickness of the material through which they are driven. Cut planks to a neat line parallel to the sides or ends of the floor.
11. **Curbs.** Surface timber for curbs and scupper blocks on four sides (S4S) with a 1 inch wide chamfer at the inside upper corner of curbs. Place them as shown on the plans and bolt in place. Make half-and-half joints in curb timbers and lap at least 12 inches. Where using scupper blocks, place curb joints immediately above a scupper block.
12. **Railings.** Frame timber railings, including posts and braces, to straight lines. Use straight material, free of blemishes and surface on four sides (S4S).
13. **Miscellaneous Hardware.** Countersink the heads of screws or bolts to prevent interference with assembling work. Treat recesses formed for countersinking with preservative in accordance with subsection [709.03.C.5.](#)

Proportion plate and cast washers to develop the full strength of the bolt. Provide washers and heads of domehead bolts with a diameter at least 3.5 times the diameter of the bolt. Provide square washers

with at least one side at least 3.5 times the diameter of the bolt. Use washers on bolts with a diameter of at least ½ inch, or use special bolt heads and nuts that provide equivalent bearing surface and strength.

14. **Prefabricated Dowel Laminated Timber Panels.** Drill dowel holes after cutting timber members to length, but before treatment. Fabricate the panels and fully assemble them at the fabrication plant. Match-mark the panels before shipment.

#### 709.04. Measurement and Payment.

| <b>Pay Item</b>                                     | <b>Pay Unit</b>     |
|---|---------------------|
| Structure, Timber (Structure No.).....              | Lump Sum            |
| Timber and Lumber, Treated, Furn<br>and Place ..... | Thousand Board Feet |
| Hardware, Misc. (Structure No.).....                | Lump Sum            |

If the contract contains the pay item **Structure, Timber**, the Department will not pay for miscellaneous hardware separately but will consider this to be included in the unit price for **Structure, Timber**. The cost of timber piling and excavation, necessary for construction of timber structures, is included in the unit price for **Structure, Timber**.

If the contract does not contain the item **Structure, Timber**, the Engineer will measure, and the Department will pay for timber piling in accordance with subsection [705.04](#). The cost of excavation for construction of timber structures is included in the unit price for **Timber and Lumber, Treated, Furn and Place**.

The Engineer will base measurement for **Timber and Lumber, Treated Furn and Place** on the nominal widths and thicknesses and the actual lengths of the material in the completed work.

**Section 710. WATERPROOFING AND PROTECTIVE COVERS**

**710.01. Description.** This work consists of providing and placing membrane waterproofing and protective covers.

**710.02. Materials.** Provide materials in accordance with the following:

|  |                     |
|--|---------------------|
| Water .....                            | <a href="#">911</a> |
| Joint and Waterproofing Materials..... | <a href="#">914</a> |
| Mortar and Grout .....                 | <a href="#">702</a> |

Provide one of the following waterproofing types as required.

A. **Preformed.** Preformed waterproofing membrane and expansion joint waterproofing selected from the Qualified Products List; including a manufacturer-specified surface primer.

B. **Shotcrete.** Shotcrete material consisting of a premixed, latex-modified portland cement, and fine aggregates, as recommended by the manufacturer for use as a pneumatically applied concrete; secure the Engineer’s approval, before use on the project.

**710.03. Construction.**

A. **Joint Waterproofing – Preformed.** Where concrete joints require waterproofing, use preformed waterproofing.

Provide preformed joint waterproofing at least 18 inches wide.

Apply the preformed waterproofing membrane system to the concrete surface at least 4 hours after removing the forms.

Prepare and prime the surface for at least 12 inches on each side of the joint. Complete preparatory work if the air and concrete temperatures are above 40 °F and the surfaces are dry. Clean the surface, designated for coverage, by using a solvent and scraping to remove deleterious materials, including oil, grease, old waterproofing material, and asphalt residue.

Before applying the primer, remove protrusions that could puncture the membrane, or cause a void with a diameter greater than ¾ inch. Remove dust from the concrete surface with compressed, oil-free air. Fill surface imperfections, potholes and spalls with a Department-approved epoxy mortar, mortar, or concrete and cure. Cure cement-based patching mixtures at least 24 hours before installing the membrane.

Apply the primer with a roller or brush, in accordance with the manufacturer’s recommendations, over the entire concrete surface

required for membrane coverage. Provide an additional application of primer if the membrane is not placed within the time specified by the membrane system manufacturer.

Apply the membrane in accordance with the manufacturer's recommendations. Remove the release paper from the back surface of the membrane immediately before placing. Center the membrane over the concrete joint, straight and wrinkle-free. Immediately after applying each sheet, hand roll with a roller, using pressure necessary to remove air voids and ensure complete adhesion. Overlap seams at least 6 inches.

Before backfilling, demonstrate to the Engineer that the entire surface of membrane has fully adhered to the underlying concrete surface. The Engineer may reject waterproofing membrane systems that exhibit a loss of adhesion to the concrete surface. Repair punctures, tears, wrinkles, or other imperfections in the installed membrane. Make repairs by applying a patch of membrane over the damaged material, or remove and replace the membrane. Size patches to extend 6 inches beyond the perimeter of the repair area.

**B. Expansion Joint Waterproofing – Preformed.** Apply a two-layer, preformed joint waterproofing membrane system at integral and semi-integral abutment backwall locations. Apply expansion joint waterproofing in accordance with subsection [710.03.A](#), except as modified by this subsection [710.03.B](#)

Provide a preformed waterproofing membrane that is at least 18 inches wide.

Do not apply primer to the two beveled surfaces next to the expansion joint at the interface of the abutment wall and backwall, required to receive the bond breaker tape.

Apply a bond breaker tape, or equivalent material, to the face of each beveled surface next to the expansion joint at the interface of the abutment wall and backwall, to prevent the membrane fold from adhering to these concrete surfaces.

Center the membrane over the concrete joint, making it straight and wrinkle-free, and insert it full-depth into the beveled cavity of the expansion joint to provide slack in the membrane for bridge movement.

Apply a second layer of membrane over the first layer. Do not use bond breaker tape for this second layer. Before applying the second layer of membrane, coat the entire exposed surface of the first layer of membrane, including the fold, with primer. Center the second layer of

membrane over the concrete joint, making it straight and wrinkle-free. Ensure this second layer conforms to, and fully adheres to the first layer of membrane.

### C. Deck Waterproofing – Preformed.

1. **Construction Procedure.** Prime and place the membrane when the air and concrete temperatures are above 40 °F and the surfaces are dry.

Allow concrete, including grout and repair areas, to cure for at least seven days before applying the primer. Clean the surface using a solvent, and by scraping to remove deleterious material, including oil or grease. Remove sharp protrusions by grinding. Remove old membrane material or asphalt residue using methods approved by the Engineer. Fill potholes and spalls with a diameter greater than ¾ inch with a Department-approved epoxy mortar, cement mortar, or concrete and cure as required. Correct elevation differences in the tops of box beams, such as those resulting from camber variation, by wedging with cement mortar or concrete. Sweep and clean surfaces with brooms and compressed air, as required.

After cleaning the deck, apply the primer, using a roller, brush, squeegee, or mechanical means, to the surface of the deck and 2 inches to 3 inches up the vertical face of the curb. Prime only those surfaces that can be covered by membrane the same day. Allow the primer to dry to a non-tacky condition before applying the membrane. Drying time may vary from ½ hour to 1½ hours, depending on the air temperature. Small bubbles on the primer are normal and do not affect the bond

After the primer has cured or dried, apply a Department-approved liquid fillet material to all inside corners. Apply a Department-approved mastic to locations where membrane edges will fall, including the curb face, raised expansion dams, or drain castings. Apply an 8-inch strip of the sheet membrane to the vertical surface of the curb so it comes to a height equal to the planned depth of hot mix asphalt (HMA). Place an 8-inch wide strip of sheet membrane, centered over transverse joints or cracks wider than 3/16 inch. Do not place the strip at raised steel expansion dams. Firmly press the membrane into the primer and mastic.

Starting at the low, or down-slope side of the deck, place the membrane either by hand or with equipment designed for this purpose. Shingle-lap successive strips of membrane. Place the

membrane, ensuring it is straight, wrinkle free with no bubbles or air spaces under it.

Overlap the edges and ends of the membrane at least 6 inches. At the drain spouts, cut the membrane and turn it down into the spouts or bleeder pipes. Apply a continuous bead of Department-approved mastic along the base of raised expansion dams, butt the sheet membrane up to the dam and press into the mastic.

Immediately after installation of each sheet of membrane, hand roll with a roller that weighs enough to ensure total contact with the deck. Patch torn or cut areas, or narrow overlaps, by placing sections of the membrane over the areas so the patch extends at least 6 inches beyond the defect in all directions. Roll the patch or press firmly in place and apply a Department-approved mastic to the edges.

Remove the separation sheet of plastic or paper as specified by the manufacturer, during the installation of the membrane and before the application of the HMA. Remove stones or other foreign matter found under the membrane after application and patch the area as described in this subsection [710.03.C.1](#).

Do not allow vehicles, except HMA hauling units and the approved rubber-tired paver on the completed waterproofing membrane.

- 2. Placing HMA Over Waterproofing Membrane.** Place the HMA mixture at a temperature from 250 °F to 350 °F according to section [501](#) after placing the membrane. Pave only on a clean and dry membrane surface. Use rubber-tired equipment. Inspect equipment and remove burrs on tires, stones, or sharp projections that could damage the membrane. If the rubber-tired machine skids during warm weather, broadcast fine sand or cement in the tire paths. Avoid excessive use of cement or sand that would prevent adhesion of the HMA.

Preheat paver screeds, but turn burners off during paving to avoid damaging the membrane. Deliver the HMA directly from the hauling unit to the paver. Do not stop the paver with a full hopper. Prevent build up of material in the auger. Keep the level of the HMA in the auger just below the level of the auger shaft. Do not damage the membrane when restarting paving operations. Avoid sudden stops or sharp turns with the compaction rollers.

After rolling the surface, apply a fillet or cove seal using the asphalt-mineral, fiber-solvent caulking material, supplied with the membrane. Apply the seal at the curb line to form a  $\frac{3}{4}$  inch by  $\frac{3}{4}$  inch triangular seal along the edge of the new surface, the full length of the curb.



D. **Shotcrete.** Pneumatically eject the shotcrete mixture from a mixer or gun through a hose and discharge nozzle, under regulated pressure. Add the liquid latex component at the mixer or gun, or at the nozzle, depending on equipment type and material manufacturer's recommendations.

1. **Test Panels.** Demonstrate to the Engineer, the ability of nozzle operators to correctly apply shotcrete. Use test panels, simulating job conditions, for each gun shooting position (down, horizontal, and overhead) required on the project. Use the same shotcrete material on test panels as proposed for use on the project. Use a panel 2 feet by 2 feet square and at least 3 inch thick, or the same thickness required on the project, whichever is greater. Ensure at least half the panel area has the same reinforcing steel pattern required on the project.

After shotcrete application, keep test panels continuously moist and above 40 °F for 5 days. Remove at least 5 cores from the test panels and test for compressive strength in accordance with ASTM C 39. Cut cores with a diameter of at least 3 inches meeting a length-to-diameter ratio (L/D) of at least 1.0. Adjust core strengths in accordance with ASTM C 42 if the L/D is less than 2.0. Ensure the average compressive strength of the cores is at least 85 percent of the required compressive strength with no individual core having a compressive strength below 75 percent of the required compressive strength.

Take additional cores through the reinforcing steel so the Engineer can evaluate the soundness of the shotcrete behind the steel. The Engineer will examine the cored surfaces and require additional cores or saw cuts if necessary to evaluate soundness and uniformity of deposited material. The Engineer will evaluate the test panels and cores to verify shotcrete surfaces are dense and free from laminations, voids, and sand pockets.

2. **Surface Preparation.** If applying shotcrete to protect waterproofing, perform the work immediately after the completion of waterproofing.

If using shotcrete to repair concrete members, remove unsound concrete from the existing substrate and concrete contaminated by chemicals or oils. Saw cut and repair the edges of the area required for repair, and patch to a depth of at least ½ inch. If using impact tools to remove concrete, provide tools that will not damage sound concrete surrounding and beneath the area being removed.

Use galvanized or epoxy-coated welded wire reinforcing on repairs greater than 2 inches deep. Place the reinforcing at mid-depth of the repair, and at least 1 inch below the surface. Attach the reinforcing to sound concrete with stainless steel anchoring devices spaced in a grid no greater than 18 inches by 18 inches. Use anchors that can support three times the weight of shotcrete allocated to each anchor.

Blast-clean the prepared area and remove traces of dirt, oil, and loose material. Follow with an oil-free air blast to remove abrasive material and dust.

3. **Shotcrete Placement.** Pre-wet the surface with the liquid latex component immediately before placement of shotcrete.

Balance air and material to ensure a steady flow, and to prevent "slugging" of material, plugging, and excess rebound. Apply the mortar using pneumatic equipment that sprays the mix onto the prepared surface at a high enough velocity to produce a compacted dense homogeneous mass, with no sagging or sloughing.

Place each layer of shotcrete in several passes over a section of the work area. Divide large expanses into smaller areas and apply shotcrete to its full thickness before moving to the next area. Avoid laminations during placement.

Keep the nozzle 2 feet to 6 feet from the work. Hold the nozzle as near to perpendicular to the surface as possible, and never more than 45 degrees to the surface.

Remove rebound and overspray that does not fall clear. Do not salvage or recycle rebound and overspray.

Do not apply shotcrete under the following conditions.

- a. High wind preventing proper application;
  - b. Surface temperature below 45 °F; or
  - c. Rain causing washouts or sloughing of the fresh shotcrete.
4. **Curing.** Cure shotcrete and provide temperature protection in accordance with subsection [706.03.N.3](#).
5. **Testing.** The Engineer may require cutting cores from the completed work for compression testing. If the Engineer orders tests, obtain and test at least three cores in accordance with subsection [710.03.D.1](#).

**710.04. Measurement and Payment.**

| <b>Pay Item</b>                        | <b>Pay Unit</b>         |
|--|-------------------------|
| Joint Waterproofing .....              | Square Foot             |
| Joint Waterproofing, Railroad.....     | Square Foot             |
| Shotcrete .....                        | Square Foot, Cubic Foot |
| Membrane, Preformed Waterproofing..... | Square Foot             |
| Joint Waterproofing, Expansion .....   | Square Foot             |

A. **Joint Waterproofing.** The Engineer will measure **Joint Waterproofing** by area based on a width of 18 inches and the plan length of joints requiring treatment.

B. **Joint Waterproofing, Expansion.** The Engineer will measure **Joint Waterproofing, Expansion** by area based on an 18 inch width and the plan length of joints requiring treatment. The Engineer will not measure the area of folds or overlapped material for payment. The unit price for **Joint Waterproofing, Expansion** includes the cost of preparing the concrete surfaces and installing the two-layer preformed expansion joint waterproofing membrane system.

C. **Membrane, Preformed Waterproofing.** The Engineer will measure **Membrane, Performed Waterproofing** by the area covered, with no allowance for laps, patches, the 8-inch strips over transverse joints or cracks, or the 8-inch strip applied to the vertical surface of the curb. The Engineer will not deduct the areas of expansion dams or drain spouts.

The unit price for **Membrane, Performed Waterproofing** includes the cost of cleaning the deck; applying the primer, liquid fillet material, and mastic; applying, rolling, and repairing the membrane; and applying the final cove seal mastic along the curb line.

D. **Shotcrete.** The unit price for **Shotcrete** includes the cost of surface preparation; providing, mixing, and applying shotcrete material; test panels, and coring.

E. **Removing HMA Surface.** If required, the Engineer will measure, and the Department will pay for removing HMA surface separately, as **HMA Surface, Rem** in accordance with subsection [501.04](#). The unit price for **HMA Surface, Rem** includes the cost of removing old membrane.

The Engineer will measure, and the Department will pay for scarifying, hand chipping, and patching, if required, separately in accordance with subsection [712.04](#). If the Department cannot determine the amount of scarifying, hand chipping, and patching required before removal of the

HMA surface, the Department will pay for this work by force account in accordance with subsection [109.05.D](#).

F. **Wedging Along Joints.** The Engineer will measure and the Department will pay for required wedging along joints between prestressed concrete box beams, inspected and accepted by the Department, separately as **Patching Mortar or Conc** in accordance with subsection [712.04](#).

The Engineer will measure, and the Department will pay for the HMA mixture separately in accordance with subsection [501.04](#).

## Section 711. BRIDGE RAILINGS

**711.01. Description.** This work consists of providing and placing bridge railings as shown in the contract.

**711.02. Materials.** Provide materials in accordance with the following:

|  |                     |
|--|---------------------|
| Concrete, Grade D .....                | <a href="#">701</a> |
| Concrete Curing Material.....          | <a href="#">903</a> |
| Dowels and Bar Reinforcement.....      | <a href="#">905</a> |
| Structural Steel .....                 | <a href="#">906</a> |
| Miscellaneous Metals .....             | <a href="#">908</a> |
| Tubing, Steel Railing .....            | <a href="#">908</a> |
| Hardware for Timber Construction ..... | <a href="#">908</a> |
| Structural Timber and Lumber.....      | <a href="#">912</a> |
| Preservative Treatments .....          | <a href="#">912</a> |
| Expansion Bolts.....                   | <a href="#">914</a> |
| Barrier Reflector Markers .....        | <a href="#">922</a> |

Provide Grade D concrete containing natural aggregate 6AA with a maximum absorption of 2.50 percent in accordance with ASTM C 127. Do not use slag aggregate.

### 711.03. Construction.

**A. Structural Steel, and Pipe Railings.** Shop plans for structural steel and pipe railings are not required. Construct railing in accordance with section [707](#). Adjust metal railing before bolting connections to ensure abutting joints match and align throughout the railing length.

Hot-dip galvanize steel, anchor studs, and fasteners in accordance with subsection [707.03.C.17](#). Blast clean welded post assemblies before galvanizing.

After galvanizing, do not punch, drill, cut, or weld steel railing components. Only weld end caps and longitudinal seams made by the manufacturer. If the plans do not show or imply dimensional tolerances, apply tolerances consistent with manufacturing practices and part function, including appearance.

Roll and bend tube rail sections with a hydraulic ram. Use a mandrel inside the tube rail with the hydraulic ram if the radius is less than 3 feet. Do not miter and cut, weld, or heat curve. The Engineer may reject tubes with kinks in the radius section. The Engineer will not require drop weight tear testing in accordance with ASTM E 436 on curved tube sections.

Bend rail sections before galvanizing. Provide at least 24 inches between compound curves. Provide tubes for curved sections with a wall thickness of at least  $\frac{3}{8}$  inch. Mill splice pieces to fit. Saw or mill the ends of tube sections. Cut ends true, smooth, and free of burrs or ragged edges. Cap open ends of the rail. Erect tube railing sections with the longitudinal seam weld facing downward.

Provide a continuous railing system, splicing each joint as shown on the plans. Splice rail tube sections in the same panel.

Before casting concrete, set anchor studs for railing posts using a template in accordance with subsection [706.03.L](#) and as shown on the plans for spacing railing posts. Tighten nuts for the anchor studs and fasteners to a snug tight condition in accordance with subsection [707.03.D.7.c](#).

## B. Concrete Railings.

1. **Parapet Railings.** Cast parapet railings in accordance with section [706](#). Provide smooth and tight fitting forms. Rigidly hold forms to the line and grade shown on the plans and remove without damaging the concrete. Construct moldings, panel work, and bevel strips with mitered joints. Provide true, sharp, clean-cut, finished corners, free of cracks, spalls, or other defects. Provide a rubbed surface finish to exposed vertical and top surfaces in accordance with subsection [706.03.R.2](#).
2. **Bridge Barrier Railings.** Construct bridge barrier railings in accordance with subsection [804.03](#) and subsection [706.03.J](#).
- C. **Timber and Lumber Railings.** Construct timber and lumber railing portions in accordance with section [709](#).
- D. **Removal of Aluminum Railing.** Remove aluminum tube and posts on parapet railings. Leave anchor bolts in place. Take ownership of removed material.
- E. **Bridge Railing, Thrie Beam Retrofit.** Drill holes or slots in thrie beam elements. Do not flame cut beam elements.

Core drill holes in existing concrete. Determine the location of existing reinforcement with a pachometer, or other nondestructive method, to avoid cutting existing reinforcement while coring. Avoid spalling concrete during drilling. If spalling occurs, remove loose concrete before installing bolts. Remove concrete fragments from the work area. Do not patch spalled areas.

Install nuts on bolts and studs at 5-inch slots in thrie beam expansion sections, and finger-tighten. Fully engage nuts and bolts with at least one bolt thread extending beyond nuts. Upset the first thread outside the nut with a center punch or a cold chisel, to prevent loosening. Tighten lag screws in 5-inch slots so washers fully contact beam elements, but do not impede movement due to expansion.

If thrie beam elements cover existing structure name plates, install new name plates, near the end of railings, on the fascia side. Attach name plates as shown on the plans, except make attachments with 3/8-inch diameter expansion anchored bolts.

**F. Permanent Barrier Reflective Marker.** Use barrier markers the same color as reflector marking colors required for the location. Install markers using the manufacturer's recommended adhesive and in accordance with the manufacturer's recommendations.

Remove dirt or curing compound from bridge barrier railings or concrete barriers before installing barrier markers. Install barrier markers every 50 feet, placing the first marker within 50 feet of the end of the bridge barrier railing or concrete barrier. For bridge barrier railings or concrete barriers less than 50 feet long, place a second marker within 3 feet of the opposite end. Install the markers with the top of the marker 28 inches above the roadway surface.

**711.04. Measurement and Payment.**

| <b>Pay Item</b>                              | <b>Pay Unit</b> |
|--|-----------------|
| Bridge Railing, Aesthetic Parapet Tube ..... | Foot            |
| Bridge Railing, Thrie Beam Retrofit.....     | Foot            |
| Bridge Railing, __ Tube .....                | Foot            |
| Bridge Barrier Railing, Type __ .....        | Foot            |
| Pipe Railing, (material) .....               | Foot            |
| Reflective Marker, Permanent Barrier .....   | Each            |

**A. Bridge Barrier Railing.** The Engineer will measure **Bridge Barrier Railing**, of the type required, based on plan quantities. The unit price for **Bridge Barrier Railing** includes the cost of placing steel reinforcement, providing and placing concrete, constructing joints, and curing and protecting the concrete.

The Engineer will measure and the Department will pay for reinforcing steel as specified in subsection [706.04](#).

**B. Bridge Railing, Thrie Beam Retrofit.** The Engineer will measure **Bridge Railing, Thrie Beam Retrofit**, based on plan quantities. The unit price for **Bridge Railing, Thrie Beam Retrofit** includes the cost of

attaching guardrail anchorages to bridge railing end posts and providing and installing new structure name plates. The Department will pay for reflectorized washers separately.

C. **Bridge Railing, Aesthetic Parapet Tube.** The Engineer will measure **Bridge Railing, Aesthetic Parapet Tube** based on plan quantities. The unit price for **Bridge Railing, Aesthetic Parapet Tube** includes the cost of the following:

1. Placing steel reinforcement,
2. Providing and placing concrete and tube railing,
3. Constructing joints,
4. Providing and placing anchor bolts or insert sleeves,
5. Curing and protecting the concrete,
6. Providing and placing light standard anchor bolt assemblies, and
7. Providing and placing handhole frames and lids.

The Engineer will measure and the Department will pay for reinforcing steel as specified in subsection [706.04](#).

D. **Bridge Railing Tubes.** The Engineer will measure **Bridge Railing, \_\_\_ Tube**, based on plan quantities in accordance with subsection [109.01.A](#). The unit price for **Bridge Railing, \_\_\_ Tube** includes the cost of providing and placing tube railing, anchor bolts, or insert sleeves, light standard anchor bolt assemblies, handhole frames, and lids. The Department will pay separately for concrete and reinforcement for railing end walls and brush blocks.

E. **Pipe Railing.** The Engineer will measure the length of **Pipe Railing** based on plan quantities.

F. **Reflective Marker Permanent Barrier.** The unit price for **Reflective Marker, Permanent Barrier** includes the cost of providing and installing the marker.



## Section 712. BRIDGE REHABILITATION — CONCRETE

**712.01. Description.** This work consists of removing concrete and patching or resurfacing with concrete patching, or overlay mixtures and removing, replacing, and retrofitting expansion joints and structural concrete portions of existing bridges.

**712.02. Materials.** Provide materials in accordance with the following:

|                                    |                            |
|------------------------------------|----------------------------|
| Concrete, Grade S2 and D .....     | <a href="#"><u>701</u></a> |
| Mortar and Grout .....             | <a href="#"><u>702</u></a> |
| Structures Patching Mixtures ..... | <a href="#"><u>703</u></a> |
| SFMC Overlay Mixtures .....        | <a href="#"><u>703</u></a> |
| LMC Overlay Mixtures .....         | <a href="#"><u>703</u></a> |
| Granular Material, Class II.....   | <a href="#"><u>902</u></a> |
| Fine Aggregate 2MS.....            | <a href="#"><u>902</u></a> |
| Polypropylene Fibers.....          | <a href="#"><u>903</u></a> |
| Insulating Blankets .....          | <a href="#"><u>903</u></a> |
| Latex Admixtures .....             | <a href="#"><u>903</u></a> |
| Steel Reinforcement.....           | <a href="#"><u>905</u></a> |
| Bar Reinforcement.....             | <a href="#"><u>905</u></a> |
| Anchor Bolts .....                 | <a href="#"><u>908</u></a> |
| Geotextiles.....                   | <a href="#"><u>910</u></a> |
| Water .....                        | <a href="#"><u>911</u></a> |
| Epoxy Resin Adhesive.....          | <a href="#"><u>914</u></a> |
| Epoxy Mortar .....                 | <a href="#"><u>914</u></a> |
| Mechanical Expansion Anchors ..... | <a href="#"><u>914</u></a> |

Do not use chloride admixtures. Provide Grade S2 concrete for filler walls.

Provide adhesive anchors, mechanical expansion anchors, and mechanical reinforcement splices selected from the Qualified Products List.

Provide embedded galvanic anodes selected from the Qualified Products List.

Provide Type H-1 grout for use under masonry plates, selected from the Qualified Products List.

Provide threaded reinforcing bars with threaded couplers, approved by the manufacturer for use with the product.

Provide anchor bolts and washers hot-dip galvanized in accordance with AASHTO M 232.

Provide Silica Fume Modified Concrete (SFMC) or Latex Modified Concrete (LMC) for concrete bridge deck overlay.

### **712.03. Construction.**

#### **A. Equipment.**

##### **1. Equipment for Preparation of Existing Concrete.**

- a. **Sawing Equipment.** Provide sawing equipment capable of sawing concrete to the depth required by the contract.
- b. **Scarifying Equipment.** Provide a power operated, mechanical scarifier capable of removing the concrete surface to at least  $\frac{1}{4}$  inch deep, with each pass. Attach a short ski, shoe, or other device, to the cutter head to limit the cut depth.
- c. **Blast Cleaning Equipment.** Provide blast cleaning equipment that uses abrasive or high-pressure water to remove rust scale from reinforcing bars and small chips of loosened concrete. Select dry abrasive from the Qualified Products List.
- d. **Superstructure Concrete Removal Equipment.** Obtain the Engineer's written approval for the proposed sequence and method of removal, before removing portions of the bridge superstructure. Provide equipment for removing superstructure concrete in accordance with the following:
  - i. **Removing Superstructure Concrete on Steel Beams.** For removing superstructure concrete on steel beams, the Contractor may use machine-mounted hydraulic or pneumatic equipment for full or partial deck removals, sidewalks, curbs, barriers, and railings.
  - ii. **Removing Superstructure Concrete on Prestressed Concrete I-Beams.** For removing superstructure concrete on prestressed concrete I-beams, the Contractor may use machine-mounted hydraulic or pneumatic equipment in areas on the bridge decks between prestressed concrete beams. Use manual pneumatic hammers to remove the bridge deck over prestressed concrete beams. Use manual pneumatic hammers to remove diaphragms. Limit manual pneumatic hammers to 60 pound maximum.
  - iii. **Removing Superstructure Concrete on Prestressed Concrete Spread Box Beams or 1800 Beams.** For removing superstructure concrete on prestressed concrete

spread box beams or 1800 beams, do not use machine-mounted hydraulic or pneumatic equipment on full or partial deck removals. The Contractor may use this equipment to remove sidewalks, curbs, barriers, and railings. Use manual pneumatic hammers to remove bridge deck over the prestressed concrete beams. Use manual pneumatic hammers to remove diaphragms. Limit manual pneumatic hammers to 60 pound maximum.

- iv. **Removing Superstructure Concrete on Prestressed Concrete Side-By-Side Box Beams.** For removing superstructure concrete on prestressed concrete side-by-side box beams, do not use machine-mounted hydraulic or pneumatic equipment on full or partial deck removals, or to remove sidewalks, curbs, barriers, and railings that rest directly on the prestressed concrete beams. The Contractor may use this equipment to remove sidewalks, curbs, barriers, and railings that do not rest directly on prestressed concrete beams. Use hydrodemolition or manual pneumatic hammers to remove concrete decks, sidewalks, curbs, barriers, and railings that rest directly on prestressed concrete beams. Limit manual pneumatic hammers to 60 pound maximum.
- v. **Removing Superstructure Concrete at Expansion and Construction Joints on Concrete Beam Bridges.** For removing superstructure concrete at expansion and construction joints, do not use machine-mounted hydraulic or pneumatic equipment for removing superstructure concrete around expansion or construction joints on concrete beam bridges. The Contractor may use manual pneumatic hammers, limited to 60 pound maximum.
- vi. **Removing Superstructure Concrete at Expansion and Construction Joints on Steel Beam Bridges.** For removing superstructure concrete at expansion and construction joints the Contractor may use machine-mounted hydraulic or pneumatic equipment on steel beam bridges. Limit the impact energy of machine mounted hydraulic or pneumatic hammers to a maximum rating of 300 foot-pounds, or an AEM/CIMA Tool Energy Rating of 130 foot-pounds. Use a conical or a moil point. The Engineer will not allow machine-mounted hydraulic or pneumatic hammers for removing joints within 12 inches of beam edges or within 6 inches of transverse sawcut lines.

Use machine-mounted hydraulic or pneumatic hammers before constructing bridge deck overlays. The Contractor may use manual pneumatic hammers, limited to 60 pound maximum.

## 2. Hydrodemolition Equipment.

- a. **Equipment Description.** Use equipment that operates at a noise level less than 90 dbA, as measured from a distance of 50 feet. Use potable water in hydro-demolition operations. Provide equipment shielding to prevent injury or damage from flying debris, in accordance with subsection [104.07.B](#).
- b. **Equipment Demonstration.** The Engineer will designate two trial areas on the bridge deck for the Contractor to demonstrate that equipment, personnel, and methods of operation produce results satisfactory to the Engineer.

Complete required scarification before the demonstration.

The first trial area consists of 30 square feet of sound concrete, as determined by the Engineer. Calibrate equipment to remove the sound concrete to the depth shown on the plans. Move the equipment to a second trial area that consists of deteriorated or defective concrete, and determine if the calibration for sound concrete will completely remove the unsound concrete.

If the equipment does not completely remove the unsound concrete, obtain another piece of equipment and perform another demonstration. The Engineer will not adjust the project completion date due to delays in obtaining equipment.

Begin production removal only if the Engineer determines results are satisfactory. If the Engineer determines equipment does not adequately remove concrete, the Engineer may require equipment recalibration during production work.

3. **Concrete Overlay Surface Construction Equipment.** Provide hand tools for placing freshly mixed concrete. Use a finishing machine with a self-propelled screed, at least one powered roller, augers, and vibratory pan set at a vibration rate recommended by the manufacturer. Provide a finishing machine capable of moving forward and backward under positive control.

Raise screeds to clear the screeded surface if traveling in reverse. Obtain the Engineer's approval for modifications to the finishing equipment.

Operate the screed on longitudinal screed rails, capable of carrying imposed loads between supports with a deflection no greater than  $\frac{1}{16}$  inch. Use rail sections, straight within  $\frac{1}{8}$  inch over 10 feet. Place the rail sections within  $\frac{1}{16}$  inch of the required screed grade. Attach rails to the surface to allow vertical adjustments and removal without damage to the new surface.

Use vibratory equipment to consolidate hand-finished areas and along construction joints and bulkheads. For areas with epoxy coated, or other coated reinforcement, use a vibrator with a rubber coated head.

The Contractor may use truss type vibrating screeds when conditions warrant if approved by the Engineer

#### 4. **Joint Cleaning Equipment.**

a. **Air Compressors.** Use compressors with oil-free and moisture-free air, and a nozzle pressure of at least 90 psi.

b. **Abrasive Blasting Equipment.** Use abrasive blasting equipment capable of cleaning as required, with a nozzle pressure of at least 90 psi. Use nozzles sized for the width of joint and replace them if enlarged by wear.

5. **Adhesive Injection Equipment.** Inject adhesive with positive displacement equipment, with fixed ratio and automatic mixing of two components at the nozzle. Provide equipment with drain-back plugs and a nozzle arrangement capable of adhesive injection, at a pressure no greater than 120 psi, without defacing concrete.

6. **Blast Cleaning Equipment.** Provide blast cleaning equipment with dry abrasive or high-pressure water to remove laitance, deleterious material, including old curing material and pavement marking paint. Select the abrasive from the Qualified Products List.

B. **False Decking.** Construct false decking in accordance with subsection [706.03.B](#).

C. **Superstructure Concrete Removal.** Mark out beam and diaphragm locations before beginning removal operations. If removing decks, sidewalks, curbs, barriers, and railings, do not damage the concrete and retained steel portions of the superstructure. Repair damage to retained portions to the Engineer's satisfaction at no additional cost to the Department.

If incorporating part of the deck into new construction, make a 1 inch deep saw cut on the top and bottom of the deck at the limits of removal shown on the plans.

If sawing to section the deck for removal, cut no greater than 90 percent of the full depth of the deck over the steel or prestressed concrete beams to avoid cutting the top flange.

Saw cut the front and back vertical steel reinforcement in sidewalks, curbs, barriers, and railings before removal.

On prestressed concrete spread box beams and 1800 beams, saw cut the deck between the beams full depth, parallel to the beams, and remove in sections. Remove the deck over the beams using manual pneumatic hammers.

**D. Removal or Revisions to Bridge Deck Joints.** Remove or extend and modify existing bridge deck joints. Clean structural steel exposed during concrete removal in accordance with SSPC-SP3, Power Tool Cleaning. Using a brush, coat exposed structural steel with 5 mils to 10 mils of aluminum-filled epoxy mastic. Protect the work and environment in accordance with section [715](#). Remove and reinstall portions of existing three beam guardrail to access joints for removal.

**E. Scarifying Bridge Decks.**

1. **Scarifying.** Close the structure to traffic. Scarify the concrete surface requiring overlay to at least  $\frac{1}{4}$  inch deep. If the use of a scarifier is not practical, remove concrete using hand methods. Avoid damaging steel reinforcement.

Do not scarify within 6 feet of new deck overlay until the overlay cures at least 48 hours.

Only allow construction vehicles required to conduct the work onto scarified surfaces.

2. **Determination of Unsound Concrete.** After structure scarifying and cleaning, the Engineer will mark areas of unsound concrete.

**F. Hand Chipping.** Use hand methods to remove concrete next to exposed reinforcing steel, concrete from spalled areas, unsound concrete from Engineer-marked areas, epoxy patches, hot mix asphalt (HMA) patches, and other unsound material, as determined by the Engineer.

Do not hand chip within 6 feet of new overlay until it cures at least 48 hours.

Blast clean to remove scale or accumulated rust from reinforcing steel.

1. **Hand Chipping Bridge Deck Concrete.** For areas requiring patching or leveling, remove unsound concrete and other detrimental material, as determined by the Engineer, using air chisels, scarifying machines, or milling. Blast clean the area. If directed by the Engineer, saw cut the area requiring patching or filling on decks not requiring overlay, to the required line and depth. If deep hand chipping is required, remove concrete to at least  $\frac{3}{4}$  inch below exposed steel.

Install edge forms to the grade shown on the plans, if areas requiring patching lie next to a joint. If full depth removal of deck portions is required, install false decking in accordance with subsection [706.03.B](#).

Remove loose material from area requiring patching and clean with oil-free compressed air. Flush the area with clean water under pressure and remove excess water by air blasting immediately before applying patching mixture.

Clean structural steel exposed during concrete removal in accordance with SSPC-SP3, Power Tool Cleaning. Coat exposed structural steel with 5 mils to 10 mils of brushed-on aluminum-filled epoxy mastic before recasting concrete. Protect the work and environment in accordance with section [715](#).

2. **Hand Chipping Concrete Other Than Deck Concrete.** Remove unsound or loose concrete with air hammers, or other Department-approved methods. Saw-cut areas requiring patching or filling to an edge depth of at least  $\frac{1}{2}$  inch, along a line determined by the Engineer. Remove concrete to at least 3 inches, as measured from the concrete surface. Remove concrete from exposed reinforcing steel to provide clearance of at least  $\frac{3}{4}$  inch around the steel.

Remove loose material. Blast clean, and blow out the area with oil-free compressed air.

If areas requiring patching lie next to joints, install edge forms to the line shown on the plans. Remove loose material from areas requiring patching and cleaning with oil-free compressed air. Flush the area with clean water under pressure and remove excess water by air blasting immediately before applying patching mixture. Place patches in accordance with subsection [712.03.O](#).

**G. Hydrodemolition.** Remove deck concrete and concrete patches with high-pressure water jets. If hydrodemolition is not practical, use hand methods to remove areas.

Remove HMA patches in accordance with subsection [501.03](#). Remove patches by hydrodemolition, 60-pound pneumatic hammers, or other equipment approved by the Engineer. Clean debris from the deck, before beginning the first pass of concrete hydrodemolition. If using hydrodemolition equipment to remove HMA patches, complete work before the first pass for concrete removal.

Use hydrodemolition to the limits shown on the plans or as determined by the Engineer.

If the plans show limits of hydrodemolition, make one pass of the hydrodemolisher to remove sound concrete to the depth and limits required. Avoid removing sound concrete beyond the required depth. Remove deteriorated or defective concrete within the limits required.

If the plans limit hydrodemolition to deck portions the Engineer determines contain unsound concrete, scarify the entire deck first. The Engineer will mark and measure areas determined as unsound. Make one pass of the hydrodemolisher over these areas with equipment calibrated in accordance with subsection [712.03.A.2.b](#).

The Engineer will determine and mark areas of unsound concrete remaining after the first pass, as specified in subsection [712.03.E.2](#). Remove unsound areas with a second pass of the hydrodemolisher, 60-pound pneumatic hammers, or other equipment approved by the Engineer. Make the second pass with the hydrodemolition equipment calibrated the same as for the first pass.

Remove concrete debris by hand or mechanical methods immediately after hydrodemolition. Remove debris that settles on, or adheres to, the surface of sound concrete, at no additional cost to the Department.

Avoid damage to remaining sound concrete or exposed reinforcement. If more than 3 inches of deteriorated concrete is removed, the Engineer will not allow heavy equipment, including vacuum trucks for removing concrete debris and concrete trucks, on the deck. Following debris removal, and before placing overlay, blast clean the surface with abrasive or water to remove bond-breaking residue or loose material from concrete surfaces, and rust from steel reinforcement.

Clean structural steel exposed during concrete removal in accordance with SSPC-SP3 Power Tool Cleaning, and brush on a 5-mil to 10-mil



coat of aluminum-filled epoxy mastic. Protect the work and environment in accordance with section [715](#).

Sample, test, monitor, manage, neutralize, and discharge hydrodemolition runoff water from bridge decks. Collect, filter, and dispose of runoff water generated by hydrodemolition. Obtain required permits and comply with regulations concerning runoff water disposal. Do not allow runoff water to create a hazard to the adjacent, or underlying traveled roadway surfaces. Protect existing berm slopes from scouring by water jet or runoff water. Do not allow runoff water, filtered or unfiltered, to enter storm sewers, bridge drain downspouts, or bridge approach downspouts. Do not discharge runoff water, filtered or unfiltered, into surface water, floodplains, or wetlands.

In areas with enclosed drainage systems or areas where the contract does not allow runoff discharge, collect, haul, and dispose of runoff water as a liquid industrial waste in accordance with section [107](#).

**H. End Header Replacement.** Remove the end header of bridge decks and rebuild decks and adjacent approaches in the removal area, as shown in the contract.

**I. Exposed Steel Reinforcement.** Blast clean to remove scale or accumulated rust from reinforcing steel. Supplement broken or missing reinforcement and bars that have lost  $\frac{1}{4}$  or more of the original bar diameter by splicing in new bars with a lap length of 35 bar diameters, or as directed by the Engineer. If the bond between existing concrete and reinforcing steel is destroyed, remove concrete next to the bar to at least  $\frac{3}{4}$  inch deep, except on bridge decks with lower bar mat clearances that make this impractical. Do not displace or damage exposed reinforcing steel. Remove exposed waterstops. Adjust reinforcing steel to provide cover as shown on the plans.

Wire tie exposed, untied reinforcing bar laps and intersections as follows.

1. **Bar Laps.** Tie bar laps in at least two locations. If sound concrete bonded to reinforcing bars prohibits tying bar laps, remove concrete to tie the bars as required.
2. **Bar Intersections.** Tie bar intersections at every third intersection. If sound concrete, bonded to reinforcing bars prohibits tying a bar intersection, or tying the third intersection, tie the next nearest intersection. Do not remove sound concrete bonded to reinforcing bars to tie the required bar intersections.

**J. Anchoring Reinforcing Bars or Bolts with Adhesive.** Place adhesive when the concrete and steel temperature is at least 50 °F and

rising. The Contractor may use artificial heat to warm concrete and bars or bolts. Do not heat above 180 °F.

Drill holes, remove unsound concrete and dust, fill drilled holes with adhesive, and install reinforcing bars or bolts.

Maintain concrete and steel surfaces, that the adhesive will contact, free of contamination.

1. **Anchoring Bars or Bolts.** Propose complete details of drilling, cleaning, and bonding systems for anchoring reinforcement and submit for the Engineer's approval before use. Propose a drilling method that does not cut or damage existing reinforcing steel. Prepare at least three proof test anchors in the required position, on a separate concrete block, in the presence of the Engineer. The Engineer will proof test the proposed systems. The Engineer will base approval of the anchoring system on the following criteria:

- a. Pull-out tests show that 125 percent of the bar yield strength can be developed;
- b. Bars bond to the concrete at least 90 percent of the embedded bar length and circumferential area; and
- c. Average bar slippage at yield strength does not exceed  $1/16$  inch.

Locate the steel reinforcement with a pachometer, or other Department-approved method, before drilling holes. Remove loose concrete, dust, dirt, and oil from holes by flushing with water under pressure and mechanical agitation. Blow out the holes with oil-free compressed air and dry before applying adhesive.

Clean reinforcing steel of loose scale, rust, oil, and dirt and dry before installation. Prepare adhesive for installation in the hole in accordance with the manufacturer's directions. Place adhesive in the hole to completely fill the space between bar and hole surface for the entire hole depth.

2. **Field Testing.** Conduct field testing, during the first production day, at three locations selected by the Engineer. Provide adequate notice to allow the Engineer to witness this field testing. Use a tension testing device in accordance with ASTM E 488. Provide a copy of a certified calibration for the tension testing device. Update the calibration annually. The Engineer may conduct random pull-out tests for acceptance. In order to be considered passing tests, field tests performed by the Contractor and random tests performed by the Engineer must show that 90 percent of the bar yield strength develops with less than  $1/16$  inch slip.

Repair damage to epoxy coating.

**K. Mechanical Expansion Anchored Bolts.** Propose a drilling method to ensure no damage or cuts to existing reinforcing steel. Locate steel reinforcement by a pachometer or other Department-approved method before drilling the holes. Drill holes of the required size and depth. Remove unsound concrete. Clean the hole with oil-free compressed air, brush, and clean out with air again. Do not elongate holes. The Engineer will proof test proposed anchors before use.

- 1. Anchoring Bolts.** Provide a copy of the manufacturer's product data sheet and installation procedure for the anchors, showing the ultimate load of the anchor at the required embedment depth. Prepare the proof test on a separate concrete block, or on the structure, in a location approved by the Engineer. Ensure anchors develop the proof tensile, or pull-out, loads specified in Table 712-1.

| <b>Diameter<br/>(in)</b> | <b>Load<br/>(lb)</b> |
|--------------------------|----------------------|
| $\frac{3}{8}$            | 3,500                |
| $\frac{1}{2}$            | 6,400                |
| $\frac{5}{8}$            | 10,200               |
| $\frac{3}{4}$            | 15,000               |
| $\frac{7}{8}$            | 20,800               |

- 2. Field Testing.** Conduct field testing during the first production day at three locations selected by the Engineer. Provide adequate notice to allow the Engineer to witness this field testing. Use a tension testing device in accordance with ASTM E 488. Provide a copy of a certified calibration for the tension testing device. Update the calibration annually. Ensure field tests show the anchor provides a pull-out resistance of at least 50 percent of the proof tensile load at  $\frac{1}{16}$  inch slippage. The Engineer may conduct random pullout tests at 50 percent of the proof tensile load, for acceptance.

**L. Mechanical Reinforcement Splicing.**

- 1. Preparation of Bar Ends.** Saw or shear bars requiring splicing. Straighten the ends of sheared bars. Remove burrs, paint, oil, rust, scale, or other deleterious material from surfaces. Use wire brushes, abrasive blasting, or other Department-approved methods to clean 2 inches beyond sleeve locations immediately before splicing. Obtain the Engineer's approval for bar end surface preparations before installation.

2. **Installation.** Install reinforcement splices in accordance with the manufacturer's procedure. Submit the installation procedure, including manufacturer approvals, to the Engineer for review before beginning splicing.

If using epoxy coated steel reinforcement, epoxy coat mechanical reinforcement splices in accordance with AASHTO M 284. If the installation procedure does not damage a pre-applied epoxy coating, provide epoxy coated splices. After installation, epoxy coat exposed surfaces of mechanical reinforcement splices and attached reinforcing steel, including damaged coatings and exposed threads, in accordance with subsection [706.03.E.8](#).

Protect the threads of threaded couplers with internal plastic coupler protectors, or other manufacturer-approved methods. Protect the threads on the reinforcing bars with plastic bar end protectors, or other Department-approved methods. Adjust flanged or asymmetrical couplers to minimize infringement on the required clear cover.

3. **Testing.** For swaged splices, make five test splices on the smallest and five test splices on the largest bar sizes. Provide adequate notice to allow the Engineer to witness the test splicing. Use tests to establish a splicing procedure. For other types of splices, provide two test splices on the largest bar sizes. Demonstrate to the the Engineer that splices have a tensile strength of 125 percent of the bar yield strength. For required tests, provide sample bars, 12 inches long. If the exterior of existing reinforcing steel for splicing is corroded or deformed, the Engineer may require additional qualification testing on the bars. The Department will test all test splices.

M. **Forming.** Provide forms to enable placement of concrete mixture. If approved by the Engineer, suspend forms from existing reinforcing bars using wire ties. In large removal areas, support forms by blocking from the beam flanges. Install forms for vertical patches in no greater than 4-foot high sections, with the form tops no more than 4 feet above the concrete level as the pour progresses. Remove forms upon completion of the work.

N. **Protection and Cleaning of Deck Areas to be Overlaid.** Maintain areas of removed unsound concrete and patches, free of slurry produced by wet sawing or wet scarifying. Conduct the work to ensure slurry drains away from completed areas. Remove slurry from prepared areas before resurfacing.

Before placing overlay, blast clean the deck and the edges of previously placed overlays to expose coarse aggregate and obtain a sound surface for bonding the overlay to the deck. Blast clean with abrasive or water under high pressure.

Control dust from abrasive blasting operations, as determined by the Engineer. Dust control may include the use of a cleaner abrasive or switching to water-blasting equipment for dust control.

Complete the final deck preparation and allow the Engineer time to inspect the deck condition before placing overlay. Obtain written approval from the Engineer for placing concrete overlay.

Do not allow traffic on the prepared deck before overlay placement.

Clean and wet the deck surface 1 hour before placing overlay mixture and keep surface damp throughout the pour. Remove standing water from depressions, holes, or concrete removal areas with oil-free compressed air.

**O. Mixing, Placing, Finishing, and Curing Concrete Patches.** Machine mix patching mixture with equipment specified in subsection [703.03.B](#). Provide mixture in quantities to allow placing and finishing before initial set.

Moisten surface without leaving free water, and prime the existing concrete. Place patching mixture.

On bridge decks with latex modified concrete mixes, use a stiff bristle brush to apply the initial layer of mixture onto the wetted, prepared surface and ensure vertical and horizontal surfaces receive an even coating. Limit the rate of progress so brushed material does not dry before covering with overlay material. Do not use material for brushing if no mortar remains in the mix.

For bridge decks, place the patching mixture into the area, vibrate uniformly, and finish with a wood float. After finishing, texture the patched surface to uniformly roughen the surface.

For patches on surfaces other than decks, place concrete and consolidate. The Engineer may direct the use of small hand vibrators or the vibration of the forms.

Immediately after final finishing of each patch, apply a layer of wet burlap, soaked in water for at least 12 hours, to exposed concrete surfaces. Place a 4-mil thick layer of polyethylene film over the burlap to protect the top surfaces from evaporation.

The Contractor may use membrane curing compounds for patches of non-latex modified concrete. The Contractor may leave forms in place, with burlap covering exposed areas, for curing.

Keep patches of non-latex modified concrete, covered until concrete attains a flexural strength of 550 psi, but no less than 5 days for regular strength patching mixtures, or no less than 24 hours for high-early-strength patching mixtures.

Maintain patches with regular strength latex modified concrete, continuously damp for the first 48 hours. Remove curing material at the end of the 48 hour wet cure period and allow concrete to air cure for an additional 48 hours. Maintain patches with high early strength latex modified concrete continuously damp for at least 24 hours.

If the air temperature falls below 50 °F, the Engineer may require additional curing time to ensure concrete attains a flexural strength of 550 psi. If completing concrete repairs in cold weather, protect concrete in accordance with subsection [712.03.R](#).

Do not place additional concrete on substructure concrete until substructure concrete cures for at least three days, or attains at least 70 percent of the required minimum 28-day flexural or compressive strength. Do not use mechanical attachments to substructure concrete to support forms until concrete attains at least 70 percent of the required minimum 28-day flexural or compressive strength.

Verify existing concrete strength by testing at least two beams or cylinders cured in the same environment as the sampled concrete. Conduct testing on the project. Provide adequate notice to allow the Engineer to witness the testing. The Engineer will lower the required concrete strength after reviewing engineering calculations submitted by a professional engineer licensed in the state of Michigan showing that imposed loads do not exceed 70 percent of the concrete strength at the time of load application.

**P. Mixing, Placing, Finishing and Curing Latex Modified Concrete Overlay Mixtures.** Keep equipment off patches until patches attain a flexural strength of at least 550 psi.

Form expansion joints and dams through the overlay. Install bulkheads to the required grade and profile before placing concrete mixture. Do not cast full depth across the joint.

Place screed rails and fasten to ensure finishing new surfaces to the required profile. Provide horizontally and vertically stable supporting rails. Do not treat screed rails with parting compound. Remove and

reinstall portions of existing three beam guardrail required for access to screed the deck.

Texture and finish deck surfaces to the tolerances specified in subsection [706.03.M.3](#) and subsection [706.03.M.4](#).

Proportion ingredients, and mix at the project in clean mixers. Provide concrete, uniform in composition and consistency. Produce mix at a rate that allows finishing to continue at a steady pace with final finishing completed before the formation of the plastic surface film. Brush the initial layer of mixture onto the wetted, prepared surface and ensure vertical and horizontal surfaces receive an even coating. Limit the rate of progress so brushed material does not dry before covering with overlay material. Do not use material for brushing if no mortar remains in the mix.

Place the mixture at least ¼ inch above the final grade. Consolidate and finish to the final grade. Hand finish with a float along the edge of the pour, or on small areas. Use a small quantity of latex grout to aid hand floating, if necessary. Finish joints with an edge tool, except next to metal expansion dams, curbs, previously placed lanes, and edges requiring sawing. Grind to remove minor irregularities.

After the mixture stiffens, separate screed rails and construction bulkheads from the new material by passing a pointing trowel along the inside face. Cut with the trowel the entire depth and length of rails. Do not separate metal expansion dams from the overlay.

Cover the finished surface with a single layer of clean, wet burlap when the surface can support it without deformation.

Place polyethylene film, at least 4 mils thick on the wet burlap within 1 hour of covering the concrete with burlap and wet cure the surface for 48 hours.

If the Engineer approves, the Contractor may substitute burlap-polyethylene sheets for polyethylene film. Place polyethylene side down, against the wet burlap.

At the end of the 48-hour wet cure period, remove curing material and allow the surface to air cure for an additional 48 hours. Do not allow curing water runoff to enter surface water.

**Q. Mixing, Placing, Finishing, and Curing SFMC Concrete Overlays.** Keep equipment off patches until patches attain a flexural strength of at least 550 psi.

Form expansion joints and dams through the overlay. Install a bulkhead to the required grade and profile before placing the concrete mixture. If joint placement is integral with overlay placement, cast joints full depth.

Place screed rails and fasten to ensure finishing new surfaces to the required profile. Provide horizontally and vertically stable supporting rails. Do not treat screed rails with parting compound. Remove and reinstall portions of existing thrie beam guardrail required for access to screed the deck.

Appoint a technical representative, capable of adjusting SFMC batching and mixing. The technical representative will designate a batching sequence to ensure uniform distribution of material throughout the SFMC mixture. Ensure the technical representative is present at the trial batch and the first day of SFMC placement to make recommendations and adjust the mixture.

Mix and place a 4 cubic yard trial batch at the batch plant, or at the project as directed by the Engineer, at least 3 working days before full production. Notify the Engineer of the time and location of the trial batch at least 24 hours before batching.

Proportion trial batches in accordance with the adjusted mix design, using the same materials as in the production mixture. The Engineer will consider the trial batch successful if slump test results are within 1 inch of the required range, and the air content test results are within 1.0 percent of the required range. If trial batches do not meet the requirements, discard and repeat the batching at no additional cost to the Department.

Proportion and mix SFMC using a ready mixed or central mixed batch plant in accordance with subsection [701.03](#). Discharge trucks on the project within 1 hour of charging at the plant.

Wet the prepared deck, 1 hour before placing the SFMC overlay, with a spray application of water. Use clean, oil free, compressed air to remove water collected in depressions.

Hand vibrate SFMC mixture placed in localized areas deeper than 3 inches. Draw a probe vibrator horizontally through the concrete, parallel to the transverse reinforcing bars, at intervals no greater than 18 inches. Vibrate ahead of the finishing machine. Provide a locator system to assist the operator in finding deep removal areas, and coordinate with the Engineer.

Texture and finish deck surfaces to the tolerances specified in subsection [706.03.M.3](#) and subsection [706.03.M.4](#).



Apply a continuous fog spray of water to screeded and finished concrete. Provide fogging equipment capable of spreading a fine mist over concrete surfaces without ponding water. Continue fogging behind the final floating operation until placement and activation of the wet cure system. Do not fog concrete surfaces to aid surface finishing.

Prepare clean, contaminate-free burlap by soaking in clean water for at least 12 hours before beginning concrete placement. Immediately before use, drape or suspend the burlap sheeting vertically to remove excess water. Cover concrete surfaces with wet burlap when the concrete surface can support it without deformation. Do not allow in-place burlap to dry. Do not use Burlene, or other products with impervious surfaces.

Install a network of soaker hoses over wet burlap when the concrete surface will support it without deformation. Use soaker hoses perforated throughout the lengths, within the curing limits. Use non-perforated hose outside the curing limits. Connect to a water supply that meets the requirements of section [911](#). Ensure soaker hoses apply cure water uniformly and continuously cover the entire bridge deck surface without moving the hoses. Prevent excessive localized water discharge. Demonstrate to the Engineer that soaker hose systems provide uniform coverage of the entire deck surface.

Place a layer of 4 mils thick polyethylene film over the entire deck surface and soaker hose system. Overlap seams in the polyethylene at least 10 inches. Activate the system and maintain to ensure complete and uninterrupted wet curing. Control water runoff to prevent hazard to traffic or soil erosion. Do not allow curing water runoff to enter surface waters.

Maintain the wet cure for at least seven days after concrete placement. Do not remove wet cure systems, based on 7-day compressive strengths reached in less than 7 days.

**R. Cold Weather Limitations for Placing SFMC or LMC Overlay Mixtures.** Complete overlays and other work within required temperatures. Do not place LMC or SFMC concrete after November 1.

Place overlay mixtures if the air temperature and concrete substrate are at least 40 °F and rising, and the forecast air temperature, during the curing period will remain above 35 °F. Use insulating blankets if the forecast air temperature, during the curing period will fall below 45 °F. Overlap blankets at least 12 inches. Place the insulating blankets on top of the wet curing system. Leave insulating blankets in place for the duration of the wet curing period.

If the forecast air temperature will fall below 45 °F during the remainder of the curing period, provide beams from each pour day to allow the Engineer to determine when concrete overlay attains a flexural strength of at least 550 psi. Cure for the full curing period, regardless of strength gain.

**S. Hot Weather Limitations for Placing Overlay Mixtures.** Cast concrete overlay mixtures when evaporation does not exceed 0.15 pounds per square foot per hour in accordance with Figure [706-1](#). Cast overlay concrete when air temperature remains below 85 °F. Supply Department-approved equipment for determining the relative humidity and wind velocity on the project.

**T. Construction Limitations for Placing Overlay Mixtures.** For delays no greater than 1 hour, protect the end of the concrete pour from drying with several layers of wet burlap.

For delays greater than 1 hour, install a construction dam or bulkhead. If restarting the overlay placement before the concrete cures, leave a 3-foot gap between bulkheads. Blast clean and cast the gap the next working day.

Protect freshly placed concrete from rain, as approved by the Engineer. Stop placement operations if rain starts. The Engineer may direct the removal of material damaged by rain.

For LMC overlays, keep traffic off the surface for at least 96 hours after placement. At temperatures below 55 °F, the Engineer may require additional dry curing.

Complete the continuous 7-day wet cure of SFMC overlays before casting sidewalk, curb, or barrier. Allow heavy equipment on the deck overlay only after the overlay concrete is in place at least 7 days.

Remove screed rails after the concrete takes initial set. Protect edges of new surfaces from damage during screed rail removal.

Cure overlays and repair areas for at least 48 hours before scarifying, hydrodemolition, or chipping within 6 feet. Outline repair areas with saw cuts extending to the depth of the overlay before removal and repair.

**U. Repairing Cracks by Pressure Injection.** Repair cracks as shown on the plans or directed by the Engineer.

1. **Preparation of Cracked Surfaces.** Remove leaching deposits from cracks by abrasive blasting or wire brushing, as directed by the Engineer. Apply a temporary seal, with entry ports for adhesive, along the clean, dry crack without defacing the concrete surface.

Ensure the seal contains the pumped adhesive. Spaces ports farther apart than the estimated crack depth and close enough to allow adhesive material to travel between ports.

2. **Flushing Cracks.** If directed by the Engineer, flush cracks with water by pressure washing through injection ports. Wash out concrete laitance or contaminants in the crack. Remove free water by blowing air through the crack after flushing.
3. **Temperature Limitations for Injection.** Perform injection when concrete and ambient air temperatures are above 50 °F. The Engineer may approve lower injection temperatures if the adhesive material manufacturer's recommendations support lower injection temperatures.
4. **Injection of Cracks.** Begin injection at the lower entry port and continue until adhesive is visible at the port directly above, or next to the pumping port. Stop injection and seal the port. Transfer the injector to the next port and continue injection until the crack fills. Inject from both sides of a cracked member to complete crack repair. Prevent leakage of the adhesive from the crack after injection completion.
5. **Adhesive Cure and Removal of Temporary Seal.** Cure adhesive at temperatures of at least 50 °F for the minimum cure time recommended by the manufacturer. Remove the seal or grind flush with the concrete surface. The Engineer may allow the temporary seal to remain in place for injected areas not visible.

Clean areas repaired by injection of surface contamination caused by injections.

V. **Water Repellent Treatment.** Apply penetrating water repellent treatment in accordance with subsection [706.03.S](#).

W. **Cleaning and Coating Exposed Structural Steel.** Clean and coat areas of visible rust, rust breakthrough, and blistered, peeling, or scaling paint as identified by the Engineer. Clean structural steel exposed during concrete removal in accordance with SSPC-SP3 Power Tool Cleaning, and brush coat with 5 mils to 10 mils of aluminum-filled epoxy mastic; or clean and coat in accordance with section [715](#). Protect the work and environment in accordance with section [715](#). The Engineer will inspect the following surfaces to decide the necessity of cleaning and coating:

1. The tops and edges of top flanges, and beam ends if removing the entire deck above steel beams;

2. The edges of top flanges if using metal deck forms; and
3. Metal surfaces exposed during removal of backwall portions or full deck removal.

**X. Grouting Under Masonry Plates.** Propose procedures for grouting under masonry plates to the Engineer for approval. Demonstrate to the Engineer by full-scale test, that the grout placement procedures result in 90 percent surface area contact, based on the contact areas of the masonry plate and concrete surface.

Do not begin the grouting operation until underlying concrete achieves the required compressive strength.

Form the space for grouting and clean the surface. Mix, place, and cure grout in accordance with the manufacturer's recommendations.

After curing, remove forming material to allow inspection of the grouted space. Do not apply load to the grout until cure completion.

**Y. Galvanic Anodes.** Use portland cement-based repair mortars, concrete, and bonding agents. Do not use non-conductive repair materials, including epoxy, urethane, or magnesium phosphate.

Install galvanic anodes to existing, uncoated reinforcement along the perimeter of the repair, spaced as shown on the plans. Ensure the distance between anodes does not exceed 24 inches.

Provide 3/4-inch clearance between anodes and substrate to allow repair material to encase anodes.

Secure galvanic anodes as close as possible to the patch edge using anode tie wires. Tighten tie wires to prevent free movement.

If tying anodes onto a single uncoated steel reinforcing bar, or if covering with less than 1½ inches of concrete, place anodes under the uncoated reinforcing steel. Secure anodes to uncoated reinforcing steel per manufacturer's recommendations

If 1½ inches of concrete covers the anode, the Contractor may place anodes at the intersection between two uncoated bars, and secure to each bar.

Confirm electrical connection between anode tie wires and uncoated reinforcing steel with a multi-meter. Ensure a direct current (DC) resistance of no greater than 1 ohm.

Confirm electrical continuity of exposed, uncoated reinforcing steel in the repair area. The Department will consider steel reinforcement continuous if the DC resistance equals no greater than 1 ohm. If the DC

resistance is greater than 1 ohm, establish electrical continuity with uncoated steel tie wire.

Obtain verification of installation of galvanic anodes from the Engineer before concrete placement.

**712.04. Measurement and Payment.**

| <b>Pay Item</b>  | <b>Pay Unit</b>        |
|--|------------------------|
| Scarifying .....   | Square Yard            |
| Latex Conc Surface, Rem .....                                    | Square Yard            |
| Hand Chipping, Shallow .....                                     | Square Yard            |
| Hand Chipping, Deep .....  | Square Yard            |
| Hand Chipping, Other Than Deck .....                             | Cubic Foot             |
| Hydrodemolition, First Pass.....                                 | Square Yard            |
| Hydrodemolition, Second Pass .....                               | Square Yard            |
| Structures, Rehabilitation, Rem Portions<br>(Structure No.)..... | Lump Sum               |
| End Header Replacement .....                                     | Foot                   |
| Deck Joint, Rem .....  | Foot                   |
| Bridge Joint, Revise Expansion Device.....                       | Each                   |
| Bridge Joint, Revise Compression Seal.....                       | Each                   |
| Adhesive Anchoring of Vertical Bar, __ inch .....                | Each                   |
| Adhesive Anchoring of Horizontal Bar, __ inch .....              | Each                   |
| Bolt, Adhesive Anchored, __ inch .....                           | Each                   |
| Bolt, Mechanical Expansion Anchored, __ inch .....               | Each                   |
| Reinforcement, Mechanical Splice .....                           | Each                   |
| Patch, Full Depth .....  | Cubic Yard             |
| Patching Mortar or Conc.....                                     | Cubic Foot, Cubic Yard |
| Patching Conc, (type).....                                       | Cubic Yard             |
| Patch, Forming .....   | Square Foot            |
| Bridge Joints, Clean and Seal (Structure No.) .....              | Lump Sum               |
| Flushing Cracks, Water .....                                     | Foot                   |
| Structural Crack, Repr .....                                     | Foot                   |
| Filler Wall Conc .....   | Cubic Yard             |
| Top Flanges and Beam Ends, Clean and Coat.....                   | Square Yard            |
| Bridge Deck Surface Construction .....                           | Square Yard            |
| Conc, Silica Fume Modified.....                                  | Cubic Yard             |
| Conc, Bridge Deck Ovlv .....                                     | Cubic Yard             |
| Masonry Plate, Grout.....  | Each                   |
| Embedded Galvanic Anode.....                                     | Each                   |

A. **Scarifying.** The Engineer will measure **Scarifying** to the limits shown on the plans, including joints and drain castings.

**B. Latex Concrete Surface, Removal.** The unit price for **Latex Conc Surface, Rem** includes the cost of removing latex modified concrete bridge deck surfaces to a depth of 3 inches or to the top mat of steel reinforcement. The Department will pay for removing unsound latex modified concrete at or below the top mat of steel reinforcement at the unit price for relevant hydrodemolition pay items.

**C. Hand Chipping.**

1. **Hand Chipping, Shallow.** **Hand Chipping, Shallow** applies to removing bridge deck concrete from the surface to the midpoint of the top bar of the top mat of the steel reinforcement. The Engineer will measure **Hand Chipping, Shallow** based on areas marked by the Engineer. The unit price for **Hand Chipping, Shallow** includes the cost of blast cleaning steel reinforcement and preparing the area for patching.
2. **Hand Chipping, Deep.** **Hand Chipping, Deep** applies to removing bridge deck concrete to expose steel reinforcement, from the surface to at least  $\frac{3}{4}$  inch below the bottom of exposed steel. The Engineer will measure **Hand Chipping, Deep** based on areas marked by the Engineer. The unit price for **Hand Chipping, Deep** includes the cost of blast cleaning steel reinforcement, preparing the area for patching, cleaning and coating exposed structural steel, and protecting the work and the environment during cleaning.
3. **Hand Chipping, Other Than Deck.** **Hand Chipping, Other Than Deck** applies to removing concrete, but does not apply to removing deck top surfaces, regardless of depth. The Engineer will measure **Hand Chipping, Other Than Deck** based on areas marked by the Engineer. The unit price for **Hand Chipping, Other Than Deck** includes the cost of blast cleaning steel reinforcement and preparing the area for patching.
4. **Hydrodemolition.** The Engineer will measure **Hydrodemolition, First Pass** to the limits shown on the plans, including expansion devices and drain castings.

The unit price for **Hydrodemolition, First Pass** includes the cost of removing concrete, including concrete removed during the successful hydrodemolition equipment demonstration, tying exposed steel reinforcement, cleaning and coating exposed structural steel, and protecting the work and the environment during cleaning.

The unit price for **Hydrodemolition, Second Pass** includes the cost of hand chipping to remove concrete, including latex modified concrete, below steel reinforcement.

The Department will pay for removing HMA patches as **HMA Patch, Rem** in accordance with subsection [501.04](#).

**D. Reinforcing.**

1. **Reinforcement, Steel.** The Engineer will measure, and the Department will pay for reinforcing steel as **Reinforcement, Steel** in accordance with subsection [706.04](#). The Engineer will measure dual bars of equivalent section as the required size.

The unit price for **Reinforcement, Steel** includes the cost of providing and splicing in new bars to replace corroded or removed bars. The Department will not pay for replacing reinforcement damaged by Contractor operations.

2. **Adhesive Anchoring of Vertical and Horizontal Bars.** The unit prices for **Adhesive Anchoring of Vertical Bar** and **Adhesive Anchoring of Horizontal Bar**, of the sizes required, includes the cost of providing adhesive, drilling and cleaning holes, filling holes with adhesive, installing bars, and testing.

The unit price for **Reinforcement, Steel** includes the cost of providing reinforcing bars.

The Department will pay for each bar end requiring anchoring as a separate unit.

3. **Reinforcement, Mechanical Splice.** The Engineer will measure, and the Department will pay for **Reinforcement, Mechanical Splice** by the number of units required. If increased coupler lengths compensate for inferior deformations on existing bars, the Department will increase the unit price on a pro-rated basis, based on the length of the increase in inches.

The unit price for **Reinforcement, Mechanical Splice** includes the cost of preparing test samples, preparing steel reinforcement for splicing, installing couplers, and applying epoxy coating.

The unit prices for **Reinforcement, Steel** and **Reinforcement, Steel, Epoxy Coated**, include the cost of threaded reinforcing bars used with threaded couplers.

- E. Bolt, Adhesive Anchored.** The unit price for **Bolt, Adhesive Anchored** includes the cost of providing bolts and adhesive, drilling and cleaning holes, filling holes with adhesive, installing bolts and testing.

The unit price for **Bolt, Mechanical Expansion Anchored** includes the cost of testing.

**F. Structures, Rehabilitation, Remove Portions.** The unit price for **Structures, Rehabilitation, Rem Portions** includes the cost of removing materials as shown on the plans, saw cuts required for removal, and disposal of materials in accordance with subsection [204.03.B](#).

**G. End Header Replacement.** The unit price for **End Header Replacement** includes the cost of removing and replacing end headers, decks, backwalls, and approach pavements as shown on the plans.

**H. Structural Crack, Repair.** The Engineer will measure **Structural Crack, Repr** along the length of crack injected, along one surface only. The unit price for **Structural Crack, Repr** includes the cost of preparing cracks, installing temporary seals and ports, providing and injecting the epoxy adhesive, removing temporary seals, and cleaning finished surfaces.

If the Engineer requires additional cleaning and flushing of the cracks, after placing temporary seals and entry ports, the Department will pay for this work as **Flushing Cracks, Water**.

**I. Deck Joint, Removal.** The Engineer will measure **Deck Joint, Rem** to the limits shown on the plans. The unit price for **Deck Joint, Rem** includes the cost of removing expansion and construction joints, cleaning and coating exposed structural steel, removing deck joint concrete, regardless of deck thickness and diaphragm locations, protecting the work and environment during cleaning, and removing and reinstalling portions of existing thrie beam guardrail required to remove the joint. The Department will pay for removal required beyond the limits shown on the plans as extra work.

**Bridge Deck, Joint Revise Expansion Device** and **Bridge Joint, Revise Compression Seal** will be measured as each. The Engineer will measure each joint end separately.

**J. Patching.** The Engineer will measure **Patch, Full Depth** based on the volume of the hole requiring filling. The unit price for **Patch, Full Depth** includes the cost of forming, providing, placing, consolidating, finishing, and curing patching mixture.

If using **Patch, Full Depth** in conjunction with overlay, the Department will only pay for patching the area shown on the plans. If full depth patches are required in areas not shown on the plans unit prices for **Conc, Bridge Deck Ovly** or **Conc, Silica Fume Modified** will include the cost of the concrete material required to fill the full depth patches.



For full depth patches, not shown on the plans, the Department will pay for cleaning and coating exposed structural steel, forming (excluding forming required for joint replacement), form removal, and cleanup as extra work. The Department will pay for maintaining traffic under the structure to repair the full depth patch as extra work.

The Engineer will measure **Patching Mortar or Conc** or **Patching Conc**, regardless of the type of mortar or concrete, by volume in place. The unit prices for **Patching Mortar or Conc** or **Patching Conc** include the cost of providing, mixing, placing, vibrating, finishing and curing.

The contract will specify the grade or type of patching material for **Patching Conc** pay items.

The Engineer will measure **Patch, Forming** based on the area of removed concrete. The unit price for **Patch, Forming** includes the cost of forming to retain patching material, except on full-depth patches on bridge decks.

#### K. Bridge Decks.

1. **Bridge Deck Surface Construction.** The Engineer will measure **Bridge Deck Surface Construction** within the limits shown on the plans, including expansion devices and drain castings in accordance with subsection [706.04](#). The unit price for **Bridge Deck Surface Construction** includes the cost of blast cleaning decks, and consolidating, finishing, texturing, and curing surfacing mixtures, and removing and reinstalling portions of existing thrie beam guardrails required for access to screed the deck.
2. **Concrete, Silica Fume Modified.** The Engineer will document quantities of **Conc, Silica Fume Modified**, and measure based on batch plant tickets with deductions for material wasted or rejected. The unit price for **Conc, Silica Fume Modified** includes the cost of providing and placing overlay concrete on prepared deck substrate, the initial 4-cubic-yard trial batch, and providing insulating blankets.

The Department will not pay for trial batches after the initial 4-cubic-yard trial batch.

3. **Concrete, Bridge Deck Overlay.** The Engineer will document the quantity of Silica Fume Modified Concrete Mixture (SFMC) and measure based on batch plant tickets with deductions for material wasted or rejected. The unit price for **Conc, Bridge Deck Ovlly** includes the cost of providing and placing overlay concrete on prepared deck substrate, within the limits shown on the plans, and the initial 4-cubic-yard trial batch.

The Department will not pay for trial batches after the initial 4-cubic-yard trial batch.

The Engineer will measure the quantity of Latex Modified Concrete (LMC) mixture by the surfacing mixture volume used for the partial-depth patching and overlay. The Engineer will determine the quantity from the theoretical yield of the design mix and the quantity documented on the ticket printout for cement placed and yield tests performed, and will make deductions for material wasted or rejected.

The unit price for **Conc, Bridge Deck Ovly** includes the cost of providing and placing surfacing mixture, and insulating blankets.

L. **Top Flanges and Beam Ends, Clean and Coat.** The Engineer will measure **Top Flanges and Beam Ends, Clean and Coat** based on the limits shown on the plans or determined by the Engineer. The unit price for **Top Flanges and Beam Ends, Clean and Coat** includes the cost of cleaning and prime coating top flanges and beam end areas, and protecting the work and environment during cleaning.

M. **Filler Wall Concrete.** The Engineer will measure **Filler Wall Conc** based on plan quantities. The unit price for **Filler Wall Conc** includes the cost of forming walls with weepholes and forming footings with drain holes; providing, placing, finishing, and curing concrete for filler-walls, footings, and filler wall extensions; providing and placing expansion joint filler, granular material Class II, and 4-inch concrete slab between walls; and covering drain holes with geotextile.

N. **Embedded Galvanic Anodes.** The unit price for **Embedded Galvanic Anodes** includes the cost of installing anodes in concrete. The Department will pay the Contractor after the Engineer verifies installation as required.

## Section 713. BRIDGE REHABILITATION — STEEL

**713.01. Description.** This work consists of repairing and replacing portions of structural steel bridges.

A “redundant structure” consists of supporting elements that provide an alternate stress path if one element fails or is taken out of service; the loss of supporting elements in a “nonredundant” structure will cause failure of the complete structure.

**713.02. Materials.** Provide materials in accordance with the following:

|  |                     |
|--|---------------------|
| Concrete, Grade S2.....                    | <a href="#">701</a> |
| Steel Reinforcement, Grade 60.....         | <a href="#">905</a> |
| Structural Steel.....                      | <a href="#">906</a> |
| High Strength Bolts, Galvanized A 325..... | <a href="#">906</a> |
| Structural Timber and Lumber.....          | <a href="#">912</a> |

**A. Steel for Temporary Supports.** Provide temporary hanger rods that meet the requirements of ASTM A 193 Grade B7 (AISI 4140). Provide rods with longitudinal Charpy V-notch impact values of 50 foot-pounds at 30 °F. If necessary, heat treat steel to meet the Charpy V-notch impact requirements. The Engineer will reject rods with notches, nicks, or welds.

Provide a sample 15 inches long, saw cut from each bar length used for hanger rod fabrication. Provide adequate notice to allow a Department representative to witness the removal of samples from each bar length. The Department will use these samples for tensile strength, yield strength, and impact testing. Reduce the sample length to 8 inches, for impact testing only, if providing a Certified Mill Test Report, traceable to the material. Match-mark each bar sample and corresponding remainder, by stenciling in the end cross-section.

The Engineer will base rod material acceptance on Department testing and traceable Certified Mill Test Reports.

Provide heavy hex nuts for the temporary hanger rods in accordance with ASTM A 563 Grade DH or ASTM A 194 Grade 2H, and washers in accordance with ASTM F 436.

Provide steel for temporary supports in accordance with AASHTO M 270 Grade 36 and section [906](#).

**B. Sealant for Perimeter of Beam Plates.** Select the sealant from the Qualified Products List. Provide sealant in caulking tubes.

### **713.03. Construction.**

**A. Providing and Fabricating Structural Steel.** Provide and fabricate structural steel additions and replacements for existing structures and steel portions of temporary supports in accordance with section [707](#). Submit shop drawings to the Engineer for approval before fabrication.

Measure the pin dimensions of existing link plates from center-to-center. If pin dimensions differ by more than  $\frac{1}{8}$  inch from the dimensions shown on the plans, build replacement link plates to existing dimensions instead of plan dimensions. The Engineer will direct changes to plan dimensions to fit existing dimensions.

Submit to the Engineer, a final report on the pin and hanger assemblies that lists the as-built dimensions of the new link plates and pins. Demonstrate that tolerances meet the requirements specified in subsection [707.03.C.12](#). Install bushings in accordance with subsection [707.03.C.13](#). Assemble and ship pin and link plate pairs as a unit or match mark pairs.

**B. Temporary Supports for Girder Ends.** Use plan drawings, or propose an alternate design and obtain the Engineer's approval, for temporary supports for girder ends. Base alternate designs on loads and allowable soil pressures shown on the plans. Include calculations for alternate designs in the alternate design submittal. Ensure alternate designs maintain redundancy and material safety factors specified in AASHTO LFRD Bridge Design Specifications. Ensure a professional engineer, licensed in the state of Michigan seals alternate designs.

The Department reserves the right to verify structural adequacy of fabricated temporary support systems used. Verification may include visual inspection and nondestructive testing by Department personnel. The Department may require mill test report submittals for material and shop drawings of original fabrication. Before using temporary supports, make corrections deemed necessary by the Department.

Provide hydraulic jacks with a stroke of at least 3 inches and pumps capable of extending jacks full stroke. Equip hydraulic systems with dial gauges that enable determination of the external loads.

Provide hydraulic jacks with locking rings or other positive locking devices to prevent settlement in case of hydraulic failure. Use locking devices during and after jacking cycles until placement of stable shims and removal of loads from jacks.

Maintain temporary support, including replacing supports in case of partial or complete failure. The Department reserves the right to provide

labor, materials, and supervision to restore movement of traffic if the Contractor delays or makes inadequate progress in the repair or replacement of a temporary support, at no additional cost to the Department.

1. **Column-Type Supports.** After erection, before loading temporary supports, use a plumb line to determine the horizontal offset of the top of the column from the bottom of the column. Determine the horizontal offset of the hydraulic jack from the column centerline. Measure the column and hydraulic jack offsets parallel and perpendicular to the column web. Place jacks and temporary supports at each location so individual offsets and the sum, in each measured direction, do not exceed 1 inch. Consider jack offsets positive, regardless of column offset directions.

If structure embankment (CIP) is not required by the contract, compact the natural ground 9 inches deep, to at least 95 percent maximum unit weight before placing temporary supports.

If placing temporary supports on paved shoulders or roadways, place a leveling course of 21AA aggregate, asphaltic cold-patch, or other material approved by the Engineer. Compact leveling material to 95 percent maximum unit weight before placing temporary supports.

The Engineer may direct bracing of temporary supports, based on Contractor methods for performing rehabilitation work.

Leave jacks in place until installation and operation of link plates and pins. The Contractor may disconnect lines and pumps provided the equipment remains on the project.

During the first 4 hours after loading, check hourly for settlement of temporary supports. Make subsequent settlement checks daily. To prevent girder ends from subsiding more than  $\frac{1}{16}$  inch from the original position, correct by adding shims to temporary supports.

2. **Suspension-Type Supports.** After placing stable shims, the Engineer may approve removing jacks.

Repair concrete removed for erecting temporary support or access to the girder end, as approved by the Engineer.

3. **Diaphragm-Type Supports.** Place temporary supports on substructure units as shown on the plans. Equally load and simultaneously advance hydraulic jacks placed in pairs.

Leave jacks in place until repair or replacement and operation of structural components. The Contractor may disconnect lines and pumps provided the equipment remains on the project.

Propose grouting material and placement procedures to the Engineer for approval. Place grout on substructure units to create a smooth and level bearing surface for temporary supports. Select an H-1 grout material in accordance with section [702](#). Form the space for grouting and clean the surface. Mix, place, and cure grout material in accordance with the manufacturer's recommendations. After curing, remove forming material to allow the Engineer to inspect the grouted space. Do not apply load to grout until the grout attains a minimum compressive strength of 4,000 psi.

### C. **Pin and Hanger Replacement.**

1. **Measurement of Existing Hanger Assemblies.** Take field measurements of hanger assemblies requiring replacement and submit as-built dimensions, and a drawing showing the measured span and girder end, to the Engineer.

Measure existing pin diameters, the distance between pins from center-to-center, and the length, width, and thickness of link plates.

Check girder web alignment by laying a straight edge across pin plate gaps at the top and bottom of the girder. Measure and report girder offsets.

Close lanes or shoulders to allow field measurements in accordance with the [Michigan Manual of Uniform Traffic Control Devices](#) and the contract documents. Obtain the Engineer's approval for lane and shoulder closures. Do not leave lanes or shoulders closed overnight for field measurements.

2. **Removal of Existing Hanger Assemblies.** Remove existing hanger assemblies as shown on the plans and in accordance with subsection [204.03.A.5](#) and this subsection.

If removing and replacing link plates and pins from more than one girder at a time, do not work on the same end of adjacent girders. Ensure suspenders remain operational on the girder end opposite removed link plates or pins.

Support girder ends on stable shims, without using hydraulics, before removing components. Remove two pins and two link plates in each assembly. Cut the link plates and pins for removal in accordance with the following:

- a. Cut link plates into two pieces with a sloping transverse cut that coincides with the joint opening between girder ends. If cutting link plates at the pin, position a sheet metal shield behind link plates to protect the girder.
  - b. Place a metal heat shield around pin holes before flame cutting pins. The Contractor may trim pin ends to within no less than 1 inch of girder pin plates. The Contractor may burn a hole through the center of pins to ease removal. If pin removal gouges a hole in girder pin plates, grind plates smooth before blast cleaning and coating. Obtain written approval from the Engineer for welding repair of girder pin plate holes.
3. **Installation and Coating of New Hanger Assemblies.** If end diaphragms prevent installation of new pins, flame cut an oblong hole in the web of one end diaphragm using as a cutting guide, at least a 1/8-inch thick steel hole template, clamped to the channel section. After flame cutting, grind hole edges to a surface roughness no greater than 125 micro-inches per inch root mean square (rms). Clean and coat holes and leave in the finished structure. Do not loosen or remove end diaphragms.

After removing pins, grind notches and deep pits in the girder pin plate around the periphery of the hole to a surface roughness no greater than 125 micro-inches per inch rms. Clean and coat girder ends, within 3 feet of each side of the centerline of pin holes or to the nearest stiffener, before installing new hanger assemblies. Clean and coat in accordance with section [715](#).

Assemble new hanger assemblies before removing falsework shims.

D. **Bearing Stiffeners at Temporary Supports.** Erect bearing stiffeners at temporary supports in accordance with section [707](#). Leave stiffeners in place as a permanent part of the structure. Field drill bolt holes in existing girders; do not flame cut or air arc gouge existing girders or proposed attachments. Complete field drilling before blast cleaning and prime coating faying surfaces.

Before erecting bearing stiffeners, clean and coat faying surfaces and other contact surfaces. Faying surfaces consist of surfaces internal to a connection that bear on an adjacent surface. Clean and coat faying surfaces and other contact surfaces in accordance with section [715](#).

After bolting bearing stiffeners in place, clean and coat exposed areas in accordance with section [715](#). The Contractor may perform this cleaning and coating immediately after erection or during cleaning and coating of the remainder of the girder.

**E. Retrofit Structural Steel.** Erect retrofit structural steel in accordance with subsection [707.03.D](#). Leave retrofit structural steel in place as a permanent part of the structure. Field drill bolt holes in existing steel; do not flame cut or air arc gouge the existing steel or attachments. Complete field drilling before blast cleaning and prime coating faying surfaces.

Before erecting retrofit structural steel, clean and coat faying surfaces and other contact surfaces. Clean and coat retrofit structural steel in accordance with section [715](#).

After bolting structural steel in place, clean and coat the exposed areas in accordance with section [715](#). The Contractor may perform this cleaning and coating immediately after erection or during cleaning and coating the remainder of the girder.

**F. Sealing the Perimeter of Beam Plates.** Before applying sealant, clean and dry surfaces between repair plates or angles and beams and other surfaces requiring sealant. Apply sealant around the perimeter of bolted or riveted plates or angles on steel beams, as directed by the Engineer. Apply sealant over the intermediate coat when dry to the touch.

Apply sealant when air and surface temperatures are above 40 °F. Immediately after applying sealant, tool to form a  $\frac{5}{16}$ -inch fillet and force it against contact surfaces. Completely fill pits and depressions in steel beams at the seam line with sealant, regardless of width and depth. Apply a top coat over sealant after the intermediate coat cures.

**G. Heat Straightening Damaged Structural Steel.** Heat straighten damaged structural steel under the direct on-site supervision of a specialist in heat straightening bridge structural steel. This specialist must submit written documentation of three years experience, on a continuous basis, with successfully heat straightening comparable steel structures.

Before beginning work, obtain the Engineer's approval for details of heat straightening types and methods. Notify the Engineer at least 48 hours before beginning the heat straightening work. Ensure final straightened members retain as little residual stress as possible.

If an area is exposed to precipitation, do not perform heat straightening unless the area is housed as approved by the Engineer. Apply heat at a temperature no greater than 1,200 °F and monitor with contact thermometers, pyrometric sticks, or other heat indicating devices approved by the Engineer. Supply heat indicating devices and make available to the inspector. Provide torch tips with a diameter from  $\frac{3}{4}$  inch



to 1 inch. Heat all plastic yield zones and only plastic yield zones. Use line, strip, spot, and "V", triangular, heats. Do not use a "V" angle greater than 20 degrees. Limit the base of the "V" heat to 6 inches. Heat the "V" from the apex, in a serpentine pattern to the base so only the area directly under the torch shows color. Do not force cool. After each heat straightening cycle, allow steel to cool to below 250 °F before beginning the next heating cycle.

Straighten with as little mechanical force as possible. Use constraints that do not resist contraction during the cooling phase and that do not produce local buckling of compression elements during the heating phase.

Eliminate bends, creases, folds, and dents in web plates, flange plates, angles, stiffeners, channels, gusset plates, and torn areas.

Straighten the flange plates and angles to within ¼ inch of the tilt rotation at the edges from the web, with ½ inch of sweep over 20 feet, ¾ inch at the point of impact. Straighten the web to less than ½ inch out of plumb. Reduce localized deflections in the web to no greater than ½ inch, vertically and horizontally, measured with a straight edge.

Straighten webs to the required tolerances before attaching cross frames or other lateral restraint devices. Do not force beams and girders into position and attach to cross frames to hold in position.

Do not flame cut existing structural steel, except as shown on the plans.

Grind burrs, nicks, gouges, and scrapes to 125 micro-inches per inch rms and taper to the original surface using a 1:10 slope. Provide surface quality in accordance with ASTM A 6.

Report cracks or tears in beams and girders, or in other structural steel members not shown on the plans to the Engineer. The Engineer will direct the repair methods.

Inspect completed straightening for cracks in welds, web, flanges, plates, and connections. Repair cracks by welding in accordance with subsection [707.03.D.8](#). Provide adequate notice to allow the Engineer to witness the crack repair work. Inspect and test completed straightening and repaired cracks in accordance with subsection [707.03.D.8.c](#). Perform inspection and testing at no additional cost to the Department.

**H. Rocker Realignment.** Realign tilted rockers as shown on the plans and specified in this subsection. Coordinate the rocker realignment sequencing with proposed bridge repairs as shown on the plans and approved by the Engineer.

If realigning rockers of more than one girder at a time, do not work on the same ends of adjacent girders.

Do not jack existing girder ends more than  $\frac{1}{8}$  inch above final rocker position.

Before removing rockers from girders, support girder ends on stable shims without using hydraulics.

Grind existing sole plate welds; do not flame cut or air arc gouge existing welds except as shown on the plans and approved by the Engineer.

Before welding sole plates in final position, clean and prime coat faying surfaces and other contact surfaces. Clean and coat faying surfaces and other contact surfaces in accordance with section [715](#).

Position sole plates with rockers to provide the correct rocker tilt using rocker tilt tables shown on the plans and approved by the Engineer.

Field weld existing sole plates to girder flanges in accordance with subsection [707.03.D.8](#). Inspect and test field welds in accordance with subsection [707.03.D.8.c](#).

**I. Cutting Simple Span Beam Ends.** Coordinate sequencing of beam end cutting with proposed bridge repairs, as shown on the plans and approved by the Engineer.

At each location, use a plasma cutting torch to cut no greater than  $\frac{1}{2}$  inch off each beam end to provide vertical beam ends 1 inch apart. Use a straight edge or guide to provide horizontal and vertical control during cutting of beam flanges and webs. Mark cut lines on existing beams to verify cutting operations do not damage existing sole plates and bearing stiffener welds.

Do not damage or remove welds on sole plates or bearing stiffeners. Replace damaged welds. Field weld in accordance with subsection [707.03.D.8](#) and inspect and test in accordance with subsection [707.03.D.8.c](#).

Grind burrs, nicks, gouges, and scrapes to 125 micro-inches per inch rms on cut edges.

After cutting beam ends and completing field welding, clean and prime coat exposed areas in accordance with section [715](#).

**J. Structural Steel Welded Repair.** Erect structural steel components in accordance with subsection [707.03.D](#). Remove damaged or deteriorated structural components and replace with proposed structural components as shown on the plans and specified in section [204](#).

The Contractor may remove structural steel using mechanical methods, plasma cutting, or air-arc gouging.

Do not flame cut existing structural steel except as shown on the plans.

Prepare existing structural steel to accept proposed structural components and for field welding. Preparation may include field drilling coping holes and grinding, as shown on the plans.

Field weld in accordance with subsection [707.03.D.8](#). Inspect and test field welds in accordance with subsection [707.03.D.8.c](#).

After welding structural steel in place, blast clean and prime coat exposed areas in accordance with section [715](#).

The Contractor may perform cleaning and coating immediately after erection of structural steel components, or during cleaning and coating of the remainder of the girder.

**713.04. Measurement and Payment.**

| <b>Pay Item</b>  | <b>Pay Unit</b> |
|--|-----------------|
| Structural Steel, Furn and Fab, Pin and Hanger .....       | Pound           |
| Hanger Assembly, Field Measurement .....                   | Each            |
| Hanger Assembly, Rem and Erect .....                       | Each            |
| Heat Straightening Steel (Structure No.).....              | Lump Sum        |
| Stiffeners, Furn, Fab, and Erect .....                     | Pound           |
| Structural Steel, Retrofit, Furn, Fab, and Erect .....     | Pound           |
| Support, Column, Temp .....                                | Each            |
| Support, Suspension, Temp .....                            | Each            |
| Support, Diaphragm, Temp .....                             | Each            |
| Beam Plate, Seal Perimeter .....                           | Foot            |
| Rocker, Realign .....                                      | Each            |
| Cutting Beam Ends, Simple Span .....                       | Each            |
| Structural Steel, Welded Repair, Furn, Fab, and Erect..... | Pound           |

**A. Hanger Assembly.** The unit price for **Hanger Assembly, Field Measurement** includes the cost of taking and recording measurements, maintaining traffic during measuring, and providing the Engineer with a location drawing showing the span and girder end where measurements were taken.

The unit price for **Hanger Assembly, Rem and Erect** includes the cost of the following:

1. Removing two pins, two link plates, and shear locks;
2. Blast cleaning and applying and curing coating in joint areas;
3. Installing two new link plates and two new pins;

4. Protecting completed joint areas with enclosures, if required; and
5. Protecting newly painted areas adjacent to joint areas.

The unit price for **Structural Steel, Furn and Fab, Pin and Hanger** includes the cost of structural steel required for pins and plates in rehabilitation work. The Engineer will measure steel as specified in subsection [707.04](#) for structural steel, furnish and fabricate pay items.

The Engineer will measure, and the Department will pay for structural steel required for pins and plates in new construction as specified in subsection [707.04](#) for structural steel, furnish and fabricate pay items.

The Engineer will measure, and the Department will pay for **Bushing** as specified in subsection [707.04](#).

**B. Heat Straightening Steel.** The unit price for **Heat Straightening Steel** includes the cost of attaining the required structural steel position, field welding, and nondestructive testing in accordance with subsection [707.03.D.8](#). The Department will pay for crack repair not shown on the plans as extra work.

**C. Stiffeners, Furnish, Fabricate, and Erect.** The unit price for **Stiffeners, Furn, Fab, and Erect** includes the cost of field drilling, installing bearing stiffeners on existing steel, and blast cleaning and prime coating contact surfaces.

The Engineer will measure structural steel for stiffeners as specified in subsection [707.04](#) for structural steel, furnish and fabricate pay items.

**D. Structural Steel, Retrofit, Furnish, Fabricate, and Erect.** The unit price for **Structural Steel, Retrofit, Furn, Fab, and Erect** includes the cost of field drilling, installing new structural steel on existing steel, and blast cleaning and prime coating faying and other contact surfaces.

The Engineer will measure structural steel required for retrofit as specified in subsection [707.04](#) for structural steel, furnish and fabricate pay items.

**E. Support, Temporary.** The unit price for **Support, Temp**, of the type required, includes the cost of providing, placing, maintaining, and removing materials and equipment, and concrete removal and replacement to access temporary supports. The quantity of **Support, Temp**, of the type required, indicates the number of girder ends requiring support; not the number of temporary support devices required.

**F. Rocker, Realignment.** The unit price for **Rocker, Realign** includes the cost of removing existing welds, determining correct rocker tilt, field welding, inspecting and performing nondestructive testing in accordance

with subsection [707.03.D.8](#), and blast cleaning and prime coating faying and other contact surfaces.

**G. Cutting Beam Ends, Simple Span.** The unit price for **Cutting Beam Ends, Simple Span** includes the cost of cutting existing beam ends, field welding, and performing nondestructive testing in accordance with subsection [707.03.D.8](#), blast cleaning and prime coating exposed steel, and completing the work for cutting two simple span beam ends at one location.

**H. Structural Steel, Welded Repair, Furnish, Fabricate, and Erect.** The unit price for **Structural Steel, Welded Repair, Furn, Fab, and Erect** includes the cost of removing, disposing, and replacing damaged or deteriorated structural steel components as shown on the plans, field drilling, field welding, nondestructive testing in accordance with subsection [707.03.D.8](#), and blast cleaning and prime coating structural steel components.

The Engineer will measure structural steel required for welded repair as specified in subsection [707.04](#) for structural steel, furnish and fabricate pay items.

## Section 714. TEMPORARY STRUCTURES AND APPROACHES

**714.01. Description.** This work consists of designing, constructing, maintaining, removing, and disposing of temporary structures and approaches.

**714.02. Materials.** None specified.

### 714.03. Construction.

**A. Location.** The Engineer will direct clearing of obstructions to vision along temporary roadways. Locate construction materials, equipment, and buildings to prevent interference with clear vision.

**B. Construction.** Design, construct, and maintain temporary structures to carry legal loads allowed on highways in accordance with Michigan state statutes and AASHTO *Standard Specifications for Highway Bridges*, 17<sup>th</sup> edition. Ensure a professional engineer licensed in the state of Michigan seals the design. Submit the design to the Engineer for approval.

Construct deck surfaces within a tolerance of  $\frac{1}{4}$  inch, as measured with a 10-foot straight edge. Construct deck surfaces of concrete, asphalt, or timber. Level high spots or depressions using methods approved by the Engineer.

Provide two-way structures, unless otherwise shown on the plans or directed by the Engineer.

1. **One-Way Structure.** Provide a clear roadway, at least a 12 feet wide, measured between inside curb faces, at right angles to the roadway centerline. Provide at least 13 feet between bridge railing inside faces.
2. **Two-Way Structure.** Provide a clear roadway, at least 20 feet wide, measured between inside curb faces at right angles to the roadway centerline. Provide at least 21 feet between bridge railing inside faces.

**C. Maintenance.** Maintain temporary structures and approaches in accordance with subsection [104.07](#) until contract completion or opening new structures to traffic.

Protect traffic and the work in accordance with section [812](#). Maintain temporary structures and approaches, including replacement for partial or complete failures.

The Department reserves the right to provide labor, materials, and supervision to restore movement of traffic if the Contractor delays or

makes inadequate progress in the repair or replacement of a temporary structure or approach, at no additional cost to the Department.

D. **Removal and Disposal.** Take ownership of material from temporary structures and remove from the project before contract completion. Dispose of embankment and surface for temporary approaches in accordance with subsection [205.03.P](#), except if the work requires this material, incorporate as shown on the plans or as directed by the Engineer. Remove pilings or other supports in accordance with subsection [706.03.O](#).

**714.04. Measurement and Payment.**

| <b>Pay Item</b>                            | <b>Pay Unit</b> |
|--|-----------------|
| Structures, Temp (Structure No.) .....     | Lump Sum        |
| Structures, Temp, Rem (Structure No.)..... | Lump Sum        |

The Engineer will measure **Structures, Temp** by grouping material included in the structure and measuring as a unit. The unit price for **Structures, Temp** includes the cost of designing, constructing, and maintaining temporary structures.

The unit price for **Structures, Temp, Rem** includes the cost of removing and disposing of temporary structures.

The Department will pay for approaches at the unit prices for applicable pay items. Payment for approaches includes constructing and maintaining approaches.

The Engineer will measure and the Department will pay for removing and disposing of temporary approaches as **Obliterating Roadway** in accordance with subsection [207.04](#).

## **Section 715. CLEANING AND COATING EXISTING STRUCTURAL STEEL**

**715.01. Description.** This work consists of cleaning and coating metal surfaces of existing steel structures, and containing, storing, and disposing of spent material. Spent material includes paint chips, abrasive particles, dust, and debris, resulting from cleaning operations. Metal surfaces of existing steel structures include downspouts, sign supports, and brackets; but do not include railings, chain link fencing, utility conduits, and associated brackets and hangers.

**715.02. Materials.** Provide materials in accordance with the following:

|                            |                            |
|----------------------------|----------------------------|
| Epoxy Grout.....           | <a href="#"><u>914</u></a> |
| Bridge Coating System..... | <a href="#"><u>915</u></a> |

Use a Department-approved low dusting abrasive, steel grit or shot, or a combination of these, for blast cleaning. Select low dusting abrasive from the Qualified Products List.

Use a tie coat recommended by the coating manufacturer for galvanized surfaces.

**715.03. Construction.** Do not field coat from October 1 to May 1 in Superior and North Regions, or from October 15 to April 15 in the remaining regions unless otherwise approved by the Engineer. Comply with temperature restrictions specified in section [915](#).

Refer to SSPC *Steel Structures Painting Manual*, Volume 1 and Volume 2 for definitions of cleaning criteria and other coating terms.

Provide and erect scaffolding to allow inspection of steel before and after coating. Erect scaffolding to prevent damage to the structure and comply with MIOSHA rules.

Obtain the Engineer's approval for rubber rollers, or other protective devices used on scaffold fasteners. Do not use metal rollers, clamps, or other fasteners that may mar or damage the steel or coating.

### **A. Protection of Work and Environment During Cleaning Operations.**

1. **Training Program.** Provide a documented training program covering the handling and storage of hazardous waste. Provide a copy of this program to the Engineer before beginning cleaning operations and keep a copy at the project.
2. **Worker Training.** Train every employee involved in cleaning the bridge (i.e., generating waste); or cleanup, handling, and storage of



spent material. Provide training in the management of hazardous waste, as required by the Resource Conservation and Recovery Act 42 USC 6901 et. seq. and 40 CFR 265.16. Keep training records available at the project.

3. **Hazardous Waste Contingency Plan.** Develop a contingency plan for generating, handling, and storing hazardous waste in accordance with 40 CFR Part 265, Subpart C and Subpart D. Address containment and cleanup of accidental spills or releases to the environment. List an emergency coordinator and a telephone number to reach this person 24 hours a day, 7 days a week.

Submit a copy of the contingency plan to the Engineer and keep a copy at the project.

4. **Labeling of Spent Material Containers.** Provide and place the required labeling for hazardous waste storage containers. Label containers before using for hazardous waste storage, and list the date waste is first placed into each container. Make the labels visible without moving containers. The Engineer will provide the EPA generator number required by 1994 PA 451, Part 111, Hazardous Waste Management, and Rule R299.9306, (1), (b) and (c).
5. **Weekly Inspection Log.** If temporarily storing hazardous waste on the project, maintain an inspection log of the storage area and containers. Keep the log on-site and update weekly to document inspection and security of the storage area and containers in accordance with 40 CFR 265.174.
6. **On-Site Records.** Keep the following records on-site and available until blast cleaning is completed and spent material is removed from the job:
  - a. Hazardous waste training program,
  - b. Worker training records,
  - c. Hazardous waste contingency plan,
  - d. Weekly inspection log,
  - e. Waste characterization reports, and
  - f. Waste disposal manifests.

Keep the records near the hazardous waste storage area in a conspicuous location and make available for inspection and review.

The Contractor may place on-site records in a clearly marked, closed barrel, next to the stored hazardous waste.

7. **Storage in Gondolas, Roll-off Boxes, or Barrels.** Store spent material, hazardous or nonhazardous, at the bridge site, secured and protected from weather, accidental spills, or vandalism. Locate the storage containers on a gradually sloped, free draining area, not immediately next to a traffic lane, water course, or direct drainage ditch or structure. Do not place storage containers in standing water. The Engineer will review proposed storage areas before cleaning operations begin.

Keep waste containers closed and covered, except during addition or removal of spent material. Label each container as hazardous or nonhazardous material storage and include the accumulation start date, as required.

Follow the hazardous waste contingency plan and immediately clean up spent material that spills onto the ground while depositing into storage containers.

- a. **Gondolas or Roll-off Boxes.** Cover each gondola or roll-off box with a cover integral to the gondola or box and a continuous, water repellent tarpaulin. Use support ribs, or other means to prevent water from ponding on the tarpaulin.
- b. **Barrels.** Seal barrels storing hazardous waste with bolt-locking rims. Elevate barrels on pallets and arrange in single or double rows, allowing access for inspection and viewing of the labels. Bind the rows of barrels together with rope, cable, or binding straps to prevent tipping over. Cover rows of barrels with waterproof tarpaulins, held in place in accordance with 40 CFR 264.175 (c) and 40 CFR 265, Subpart I; 1994 PA 451, Part 111, Hazardous Waste Management; and Rule R299.9306, (1), (e) and (f).
8. **Disposal of Spent Material.** Notify the Engineer of the intent to sample. Ensure that sampling is conducted by a SSPC Competent Person and is witnessed by the Engineer. Take separate samples of spent material collected and stored in waste containers, dust collected from bag house filters, and shower water. Prepare a chain of custody form for each sample. Ship samples, with their chain of custody forms, in a tamper proof container or bag sealed and witnessed by the Engineer, to a laboratory as approved by the Engineer for testing according to the Environmental Protection Agency, Toxicity Characteristic Leaching Procedure (TCLP).

Use test results to characterize the spent material, bag house dust, and shower water for disposal.

Return the chain of custody form with the test results to the Engineer. The Engineer may sample and test spent material, bag house dust, and shower water during the project.

Dispose of spent material and bag house dust characterized as hazardous waste at a licensed hazardous waste disposal facility. Dispose of spent material and bag house dust characterized as nonhazardous waste at an approved Type II landfill in accordance with 1994 PA 451, Part 115, Solid Waste Management.

Dispose of shower water characterized as a hazardous waste at a licensed hazardous waste disposal facility. Dispose of shower water characterized as nonhazardous as a liquid industrial waste at an approved licensed liquid industrial waste disposal facility in accordance with 1994 PA 451, Part 121, Liquid Industrial Wastes.

Provide copies of waste manifests and disposal receipts to the Engineer.

Dispose of spent material within 90 days from the date spent material is first placed in the container.

The Department may remove and dispose of hazardous and nonhazardous waste and back-charge the Contractor for the work if the Contractor is untimely in removing waste in accordance with 40 CFR 262; 1994 PA 451, Part 111, Hazardous Waste Management, and Rule R299.9306.

**B. Containment Requirements.**

1. **General Requirements.** Clean bridges using total enclosure. Protect pedestrians, vehicular and other traffic on or under the structure, and workers in accordance with subsection [104.07.B](#). Include a barrier system that protects against the following:
  - a. Direct, or indirect blasting of vehicles, water vessels, and pedestrians;
  - b. Abrasive material and debris falling on the traveled portions of the pavement or into waterways; and
  - c. Abrasive material and debris spreading into areas where it may create a traffic hazard.

The Contractor is responsible for damage to vehicles, persons, property, or the environment in accordance with subsection [107.07](#).

Provide total containment of portions of the bridge during cleaning and vacuuming. Contain spent material resulting from cleaning

operations. Use tarpaulins or other Department-approved material to enclose portions of the structure undergoing cleaning. Use tarpaulins made of an airtight material, and secure tightly and continuously at the seams. Do not use burlap or open web materials. Extend the enclosure from the bottom of the deck to ground level or to the level of a solid work platform, and fasten to prevent lifting or opening by the wind. Clamp seams and laps on tarpaulins or sheeting together along the length of the seams or laps to prevent material or dust from escaping the enclosed area.

Use metal halide lighting in the enclosure to illuminate active work surfaces to at least 50 foot-candles.

Design the required enclosure and provide air flow and dust filtering equipment for the design. The Engineer will evaluate the performance of the design on its ability to prevent the visible release of spent material and to provide ventilation to ensure worker safety.

Maintain negative pressure inside the enclosure to prevent spent material from leaving the enclosure during cleaning. Maintain air flow through the enclosure to provide visibility and a safe working environment for blasting operators. Provide limited air intake openings in the enclosure during the operation of air moving equipment. Filter air exhausted from the enclosure through a portable truck mounted filtering system or dust collectors. Clean filters or dust collectors before delivery to the project and before removal from the project. Obtain the required state and local air quality and noise ordinance permits for operating air-filtering equipment at the bridge site. Do not discharge dust from the filter exhaust, dust collectors, or vacuum truck.

Place ground cloths under the enclosed area and extend at least 10 feet beyond the enclosure edges, but not into open traffic lanes. Provide ground cloths with sealed seams or laps. Collect spent material that settles on ground cloths from work platforms and enclosures.

If protective devices do not serve the intended purpose, suspend work until corrected. If the Engineer determines threatening weather conditions may cause a release of spent material into the surrounding environment, the Engineer will shut down cleaning operations and require immediate clean up of spent material in the enclosure.

Prevent the release of spent material from the tarpaulins and other components of the containment enclosure during relocation or removal. Mechanically clean or vacuum the dust contaminated portions before moving. Protect workers from exposure to lead-bearing dust during moving or removal work.

2. **Bridges Over Waterways.** For cleaning bridges over waterways, provide the following measures in addition to the requirements of subsection [715.03.B.1](#):
  - a. Provide a stable barge in the water directly under the area enclosed for cleaning. Size and secure the barge to provide freeboard and stability to preclude the possibility of capsizing or sinking. Evenly distribute equipment and material loads on the barge. Extend containment enclosures to the level of the barge and secure to prevent release of spent material into the waterway. Cover the surface of the barge with ground cloths to allow collection of spent material.
  - b. If impractical to use a barge, erect a temporary work platform under containment enclosures to collect spent material. Extend containment enclosures to the level of the temporary platform and secure to prevent release of spent material. Before installation, submit plans for the proposed work platform in writing, to the Engineer for review.
  - c. Stretch a floating boom across the waterway 200 feet from the bridge, on the downstream and down wind side of the bridge. Collect, store, and dispose of spent material that accumulates at the booms as specified for other waste generated by cleaning operations.
3. **Cleanup and Storage of Spent Material.** Clean spent material in the containment enclosure daily and before prolonged work stoppage. Clean ground cloths. Immediately clean spent material released outside the enclosure in accordance with the hazardous waste contingency plan.

Place spent material in storage containers.

C. **Cleaning Structures.** Shield and protect utility pipes and conduits not requiring cleaning and coating. Notify affected utility companies at least 48 hours before beginning blast cleaning operations. Shield or mask freshly coated surfaces, railings, galvanized fencing, appurtenances, and adjacent concrete, not requiring cleaning and coating. Wire brush coated surfaces damaged by blasting or, if visibly rusted, re-clean to a near-white or bare metal condition. Vacuum and re-prime wire brushed or blast cleaned surfaces.

Remove and dispose of loose concrete from the bottom of deck slabs, fascia, concrete diaphragms, and beam perimeters at dependent backwalls. If possible, remove concrete with hand-held, non-power tools.

Before cleaning, scrape surfaces to remove dirt or debris and remove oil or grease deposits in accordance with SSPC-SP 1, Solvent Cleaning. Clean surfaces to SSPC-SP 10, Near White Blast Cleaning or SSPC-SP 11 Power Tool Cleaning to Bare Metal. Grind fins, tears, slivers, and burred or sharp edges on steel members in accordance with SSPC-SP 11 bare metal finish.

The Contractor may use scaling hammers to remove heavy scale on existing structures, but not chipping hammers.

The Engineer will use the visual standard in accordance with SSPC-VIS 1, Guide and Reference Photographs for Steel Surfaces Prepared by Dry Abrasive Blast Cleaning, SSPC-SP 10, or SSPC-VIS 3, Guide and Reference Photographs for Steel Surfaces Prepared by Hand and Power Tool Cleaning, SSPC-SP 11 that corresponds to the initial rust condition, to determine steel cleanliness.

Provide a uniform blast profile from 1 mil to 2.8 mils, measured using extra coarse replica tape, except on A 588 structures. For A 588 structures, supply a non-blasted piece of A 588 steel at least 1 foot square and ¼ inch thick and clean it on the project, using the proposed cleaning procedures. Obtain the Engineer's approval for the resulting profile before continuing.

Remove abrasive and coating residue from steel surfaces with a commercial grade vacuum cleaner equipped with a brush-type cleaning tool, or by double blowing with partial vacuuming. If using the double blowing method, vacuum the top surfaces of structural steel, including flanges, longitudinal stiffeners, splice plates, and hangers after completing double blowing. Provide an air line for blowing steel clean with an inline water trap and air free of oil and water as it leaves the air line. Maintain the steel dust free and apply prime coat within 8 hours of cleaning.

#### **D. Coating Structural Steel.**

- 1. Applying the Coating.** After the Engineer approves cleaned surfaces, spray apply the coatings using the manufacturer's recommended nozzles and pressures. Provide a dry film thickness of 4 mils to 10 mils for primer, 3.5 mils to 9 mils for intermediate, and at least 1 mil for the top coat. Vacuum accumulated dirt from primed

surfaces before applying subsequent coats. If the Engineer determines the surface unfit for further coating, scrub the surface with a commercial detergent, rinse with water, and allow to dry for at least 24 hours before continuing.

Recoat areas with less than the required minimum primer dry film thickness. Use a magnetic film thickness gauge to measure the dry film thickness. Calibrate the gauge with plastic shims, the same thickness as the minimum dry film thickness, placed on a smooth section of newly cleaned steel.

Apply the intermediate and top coat to provide complete coverage with uniform color and appearance. If the dry film thickness exceeds the maximum, sand the areas to below the maximum thickness and clean before applying subsequent coats.

If coating applications result in runs, bubbles, or sags, apply coating using multiple passes of the spray gun, and allow several minutes between each pass.

Brush out runs and sags immediately, or remove and recoat the surface. Repair bubbles, pinholes, craters, and other defects by sanding the area and applying coating.

Protect wet coating against damage from dust and other deleterious material.

Remove all dry spray by sanding.

Correct coating the Engineer determines unsatisfactory and unauthorized.

Clean galvanized components, including nuts, bolts, and washers, to SSPC-SP 1 condition, provide a tie coat, and coat with intermediate and top coats. Apply tie coat to the thickness recommended by the manufacturer.

The Contractor may brush on the tie coat.

2. **Coating Faying Surfaces and Connections.** Faying surfaces consist of surfaces internal to a connection that bears on adjacent surfaces.

Coat new connections, and disassembled connections in existing structures. Apply prime coat the same way and to the same thickness as on the adjacent structural steel. Mask faying surfaces during subsequent coating operations.

Coat slip critical connections in accordance with section [716](#).

Perform final vacuuming of the connection immediately before reassembly. If vacuuming does not remove accumulated dust and dirt, or the Engineer determines the surface unfit for bolting, clean the surface. Scrub the surface with a mild detergent solution, rinse with water, and allow it to dry before assembling connections. After assembling the connection, blast clean and coat exposed areas of the connection. Clean and coat immediately after erection, or when blast cleaning and coating the remainder of the structure.

3. **Cure Times for Coatings.** Cure coatings for the minimum cure times specified in subsection [915.04.A](#). Follow the manufacturer's recommended maximum cure time, except do not allow more than 21 calendar days between coat applications. If the maximum time between coats is exceeded, blast clean newly coated surfaces and recoat at no additional cost to the Department.
4. **Protection of Work and Environment During Coating Operations.** Protect portions of the structure, including superstructure, substructure, slope protection, and highway appurtenances from spatter and overspray of coating material. Shield utility pipes and conduits not requiring coating.

Protect pedestrian, vehicular, water vessels, and other traffic in accordance with subsection [104.07.B](#).

If protective devices do not serve the intended purpose, the Engineer may suspend work until the Contractor makes corrections.

5. **Stenciling Requirement.** When coating is complete, stencil the structure number, completion date (month and year), and coating type onto the structure. On A 588 steel structures, stencil "A 588" just above the completion date. For partial painting projects, stencil the letter P before the coating type.

Use black urethane spray paint and 4-inch numbers for stenciling.

Stencil the numbers on the outside of each fascia beam at the approaching end of the structure. Place markings at least 10 feet above ground or fill slope elevations and at least 10 feet from abutments.

If not completely coating the fascia beam, stencil the designation on the outside of each fascia beam on the approaching traffic side, in the lower right corner of the newly painted section. Place markings completely within the partial coating limits, at least 3 inches above the bottom flange and with the stenciling ending within 3 inches of the right edge of the newly painted area.



If these locations are inconsistent with the newly painted areas of the structure, the Engineer will designate the stencil location.

## 6. Solvents.

- a. **Solvent Reuse Determination Procedures.** Prepare a written Solvent Reuse Determination Procedure that complies with 1994 PA 451, Part 111, Hazardous Waste Management, and Rule R299.9202. Provide a copy of this procedure to the Engineer before performing field coating.

Include, in the Solvent Reuse Determination Procedures, at least the methods for determining if the solvent is reusable; applications for use of reusable solvent; and a statement of effectiveness of the reusable solvent in each application cited.

Include in the Solvent Reuse Determination Procedure documentation certification of agreement to:

- i. Maintain records regarding solvent reuse on a "Bridge Painting Solvent Tracking Log;"
  - ii. Handle the solvent in a manner consistent with the product status as either waste or reusable solvent;
  - iii. Reuse solvent within 1 year of the initial use; and
  - iv. Reclaim only solvent after reusing it.
- b. **General.** Determine during performance of the work and before leaving the bridge site, if solvents for cleaning and coating equipment are reusable or considered waste. Make the determination and document in accordance with Solvent Reuse Determination Procedures and the applicable federal, state, and local laws and regulations. Provide a copy of the written determination documentation to the Engineer before removing solvents from the project. Dispose of non-reusable waste solvent associated with the project.

Manage, label, contain, store, and ship solvent determined reusable in accordance with the applicable federal, state, and local laws and regulations. Provide certification (shipping paper) for reusable solvent transported from the bridge site. Manage, label, contain, store, ship, and dispose of solvent characterized as waste in accordance with the following:

- i. 1994 PA 451 Part 111, Hazardous Waste Management;
- ii. Subtitle C of the Federal Resource Conservation and Recovery Act of 1976, as amended (RCRA);
- iii. 1994 PA 451 Part 121, Liquid Industrial Waste; and

- iv. The administrative rules or regulations promulgated pursuant to these acts, and other applicable federal, state, and local laws and regulations.

**E. Removal and Replacement of End Diaphragms.** Before beginning the removal and replacement of end diaphragms, divert traffic on the bridge from the affected bay until shoring placement is complete. Place shoring to support the concrete deck during diaphragm removal. Disconnect each end diaphragm from connecting plates or angles by removing existing bolts or rivets.

Clean the diaphragm and portions of the structure inaccessible with the diaphragm in place. Apply the prime coat and allow to cure in accordance with the manufacturer's requirements for slip critical connections at 50 °F or higher. Mask faying surfaces and the top of the diaphragm top flange. Apply the intermediate coat.

After the intermediate coat is dry to the touch, coat the top of the diaphragm top flange with epoxy grout. Immediately bolt the diaphragm in place in accordance with subsection [707.03.D.7](#).

Clean the galvanized bolts to SSPC-SP 1 condition and apply a tie coat. Apply the tie coat in accordance with the manufacturer's recommended coating thickness. Coat bolts and missed areas with an intermediate coat.

Apply the top coat to the area, including behind the reinstalled diaphragms.

**F. Cleaning, Coating and Installing New Hanger Assemblies.** Select a coating system from the Qualified Products List meeting the required cure time. Use the same coating system for the joint area as for the remainder of the bridge.

If the dry film exceeds the maximum required thickness, sand to below the maximum thickness and clean before applying subsequent coats. If the maximum time between coats is exceeded, blast clean and recoat newly coated surfaces at no additional cost to the Department.

Modify girder end cleaning and coating procedures as follows for areas within 3 feet of each side of the centerline of the pin holes or the nearest stiffener.

1. Enclose joint areas in accordance with subsection [715.03.B](#) except negative pressure in the containment is not required. The Contractor may remove containment during coating and curing if the temperature is at least 50 °F.

2. Blast clean joint areas to a white metal finish, in accordance with SSPC-SP 5 White Metal Blast Cleaning(see SSPC-VIS 1 Visual Standards), with a surface profile of 1 mil to 2.8 mils.
3. Enclose and heat joint areas, as acceptable to the Engineer, to maintain steel and air temperatures at 50 °F or higher. If the ambient air temperature at least 50 °F during coating application and curing, enclosing the joint area is not required. If enclosure is required, apply three coats before removing the enclosure. Apply coating when the relative humidity is below 90 percent.
4. Spray on prime coat and cure at 50 °F or higher for at least 12 hours. Provide a dry film thickness of 4 mils to 6 mils.
5. Mask pin holes before applying the intermediate coat. Spray on the epoxy intermediate coat and allow it to cure at 50 °F or higher for at least 12 hours. Provide a dry film thickness of the intermediate coat between 3.5 mils and 6 mils.
6. After the intermediate coat cures for at least 1 hour and is dry to the touch, install the new pins and link plates. Continue curing the epoxy intermediate coat at 50 °F or higher for at least 12 hours.
7. Spray the urethane top coat over assembled joint areas when the temperature is at 40 °F or higher. Apply the final coat as soon as possible after the epoxy intermediate coat cures, but no later than 21 days. Coat the areas behind assembled link plates with urethane top coat to the extent possible. Provide complete coverage and a uniform appearance with the top coat application.
8. If cleaning and coating the remainder of the girder after the joint area, box in or cover the joint area including the new pins and link plates, before blast cleaning and prime coating girders. Remove the box or covering before top coating the girders.
9. If remainder of the girder is cleaned and coated before the joint area, prevent damage to the girder coating during the blast cleaning and coating of the 6-foot joint area. Protect painted girder as approved by the Engineer.

**715.04. Measurement and Payment.**

| <b>Pay Item</b>  | <b>Pay Unit</b> |
|--|-----------------|
| Steel Structure, Cleaning, Type 4 (Structure No.).....             | Lump Sum        |
| Steel Structure, Cleaning, Partial, Type 4<br>(Structure No.)..... | Lump Sum        |
| Steel Structure, Coating Type 4 (Structure No.) .....              | Lump Sum        |
| Steel Structure, Coating, Partial, Type 4<br>(Structure No.).....  | Lump Sum        |
| End Diaphragm, Rem and Replace.....                                | Each            |
| Protective Shield, Utility Pipe.....                               | Foot            |

A. **Steel Structure, Cleaning.** The unit prices for **Steel Structure, Cleaning, Type 4** and **Steel Structure, Cleaning, Partial, Type 4** include the cost of protecting the work and environment during blast cleaning, removing loose concrete, providing barges or temporary platforms, enclosures, handling, storage, testing, transporting, and disposal of spent material, bag house dust, and shower water, regardless of hazardous or nonhazardous. The Department will not make additional compensation for suspension of work by the Engineer.

B. **Protective Shield, Utility Pipe.** If pipes or conduits are clustered in groups of at least two, the Engineer will measure the length of the cluster. The unit price for **Protective Shield, Utility Pipe** includes the cost of shielding the utility pipe or conduit during blast cleaning and painting operations, or if required, cleaning and coating existing utility conduits, including brackets and hangers.

C. **End Diaphragm, Rem and Replace.** The unit price for **End Diaphragm, Rem and Replace** includes the cost of shoring the structure while the slab remains unsupported, providing galvanized high strength bolts, and providing and applying epoxy resin to the diaphragm flange.

The unit prices for **Steel Structure, Cleaning, Type 4** and **Steel Structure, Coating, Type 4**, or **Steel Structure, Cleaning, Partial, Type 4** and **Steel Structure, Coating, Partial, Type 4** include the cost of cleaning and prime coating diaphragms.

D. **Stenciling.** The cost of stenciling is included in the unit price for related structure cleaning and coating pay items.

E. **Steel Structure, Coating.** The unit prices for **Steel Structure, Coating, Type 4** and **Steel Structure, Coating, Partial, Type 4** include the cost of coating faying surfaces.

The unit prices for coating pay items include the cost of management, characterization, and disposal of waste solvent.

## Section 716. SHOP CLEANING AND COATING STRUCTURAL STEEL

**716.01. Description.** This work consists of shop cleaning and applying a complete coating system on new structural steel as a part of fabricating and providing structural steel; field cleaning and repairing surfaces damaged in shipping, handling, and erecting the structural steel; and repairing damaged galvanized surfaces.

Refer to Society for Protective Coatings (SSPC) *Steel Structures Painting Manual*, Volume 1 and Volume 2 for definitions of cleaning criteria and other coating terms.

If more than 500 square feet of steel surface is painted, ensure work is performed by a fabricator with an AISC Sophisticated Paint Endorsement. The Engineer will accept Society of Protective Coatings, SSPC QP3 Shop Painting Certification Program as an acceptable alternate to an AISC Sophisticated Paint Endorsement.

**716.02. Materials.** Provide materials in accordance with the following:

Bridge Coating System..... [915](#)

Use a Department-approved low dusting abrasive, steel grit or shot, or a combination of these, for blast cleaning. Select abrasives from the Qualified Products List. Provide abrasives with a gradation capable of producing a uniform profile of 1 mil to 2.8 mils using extra coarse replica tape.

Use inorganic or organic zinc-rich primer to coat faying surfaces of slip critical connections. Use the same primer on both connecting faying surfaces. Do not mix use of inorganic and organic zinc rich primers on the same connection. Use primer from the same manufacturer that supplied primer for the remainder of the structure. Use a primer meeting Class B (0.5 or greater) slip coefficient requirements of the Research Council on Structural Connections' *Specification for Structural Joints Using ASTM A 325 or A 490 Bolts*. Before coating, submit to the Engineer, a certification of testing from an independent laboratory, showing that primer meets Class B slip coefficient.

Select the sealant for perimeter of beam plates from the Qualified Products List. Supply the sealant in caulking tubes.

Select zinc-rich paint, for repairing damaged galvanized surfaces, from the Qualified Products List. Use a zinc-rich paint with a gray color closely matching the surface requiring repair.

### 716.03. Construction.

**A. Cleaning Structural Steel.** Before cleaning, remove oil or grease deposits in accordance with SSPC-SP 1, Solvent Cleaning. Clean surfaces to SSPC-SP 10, Near White Blast Cleaning. Grind surface irregularities, including fins, tears, slivers, and burred or sharp edges on steel members in accordance with SSPC-SP 11, Power Tool Cleaning to Bare Metal. The Engineer will inspect for steel cleanliness using the visual standard specified in SSPC-VIS 1 Guide and Reference Photographs for Steel Surfaces Prepared by Dry Abrasive Blast Cleaning, SSPC-SP 10 for the initial rust condition.

Provide a uniform profile of 1 mil to 2.8 mils, measured using extra coarse replica tape.

Remove abrasives from steel surfaces with a commercial grade vacuum cleaner equipped with a brush-type cleaning tool, or by double blowing with partial vacuuming. If using the double blowing method, vacuum the top surfaces of structural steel, including flanges, longitudinal stiffeners, splice plates, and hangers after double blowing. For blowing the steel clean, use an air line with an in-line water trap that delivers air free of oil and water as it leaves the air line. Maintain steel dust free and prime within 8 hours of cleaning.

Before shop coating, mask areas requiring field welding, except top flange areas receiving welded stud-shear connectors. After applying the prime coat, but before applying the intermediate coat, mask areas where welding stud-shear connectors to the top flange. Provide a primer dry film thickness for the top flange between 1 mil and 2.5 mils.

**B. Coating Structural Steel.** Load material for shipment after the shop coating has cured and the Engineer has inspected material. The Engineer will stamp the components "Recommended for Use" after loading is complete.

1. **Applying the Coating.** Apply coating in accordance with subsection [715.03.D.1](#) and subsection [715.03.D.3](#).
2. **Coating Faying Surfaces and Connections.** Faying surfaces are all surfaces internal to a connection that bear on an adjacent surface including the contact surface of bolts, nuts, and washers. Before cleaning and coating, disassemble bolted connections. Blast clean components separately. Apply a prime coat and allow to cure before reassembly. Use the same primer for both connecting surfaces. Vacuum the connection again immediately before reassembly. If the Engineer determines the surface is not clean enough for bolting, scrub the surface with a commercial detergent and rinse with water

before assembling the connection. Reassemble the connection by tightening the bolts using the turn-of-nut method in accordance with subsection [707.03.D.7.c](#).

- a. **Slip Critical Connections.** Apply the same primer to faying surfaces and filler plate surfaces. Apply prime coat to a minimum dry film thickness of 1 mil and a maximum dry film thickness determined by the slip coefficient test results in accordance with subsection [716.02](#). Apply a prime coat to the external surfaces of splice plates with a dry film thickness from 4 mils to 10 mils. Ensure the primer meets the requirements of Class B slip coefficient. Mask the faying surface during subsequent coat applications.
  - b. **Other Connections.** Apply the same prime coat to faying surfaces, other than slip critical, in accordance with subsection [715.03.D.1](#). Mask the faying surface before subsequent shop coating operations. After assembly in the field, solvent clean exposed primed splices and other bolted connection locations in accordance with SSPC-SP 1. Use the same intermediate and top coat materials as for the remainder of the structure. Apply an intermediate and top coat to exposed surfaces of the bolts, nuts, and washers in accordance with subsection [715.03.D.1](#).
  - c. **Contact Surfaces without Primer.** If painting with an epoxy intermediate coat, edge seal unprimed contact surfaces. Use a sealant designated for sealing perimeter of beam repairs selected from the Qualified Products List.
3. **Stenciling.** Apply stencils in accordance with subsection [715.03.D.5](#). Designate the coating type as 4S.
  4. **Galvanizing.** As a substitute for applying a zinc rich primer, the Department will allow hot-dipped galvanizing of structural steel members in accordance with ASTM A 123, except for surfaces internal to slip critical connections and surfaces of filler plates. Apply a zinc-rich primer coat to surfaces internal to slip critical connections and surfaces of filler plates at a minimum dry film thickness of 1 mil and a maximum dry film thickness as determined by the slip coefficient test results in accordance with subsection [716.02](#). Mask the faying surface before applying subsequent coats. Apply subsequent coats in accordance with subsection [715.03.D](#). Repair damaged galvanized surface in accordance with subsection [716.03.E](#).

Perform galvanizing using the “dry process”. Do not quench the galvanized components after galvanizing. If the contract requires a top coat on galvanized components, do not apply a chromate surface passivation. Apply a galvanizing thickness of at least 3.9 mils, or 2.3 ounces per square foot.

Ensure areas of field connections have a uniform galvanized coating thickness, free of local excessive roughness that prevents splice plates, bearings, or other field connections from making full contact.

In the shop after galvanizing, use a hand wire brush to roughen faying surfaces other than slip critical connections. Do not use powered wire brushes. Ensure field splice bolt holes are free of zinc build up. Check each hole in the shop after galvanizing to verify the hole is able to receive a drift or barrel pin with a diameter of 1.6 millimeters plus the diameter of the bolt.

After galvanizing, place structural steel in a second shop assembly in accordance with subsection [707.03.C.7](#) to check alignment of holes, sweep, and camber against the fabricator’s original recorded lay down dimensions. If approved by the Engineer, the Department will allow the fabricator’s personnel to perform this shop assembly at the galvanizer’s facility. The Engineer may waive the second lay down if the fabricator records individual beam or girder cambers and sweeps during the first lay down and the dimensions after galvanizing fall within the following tolerances:

- a. Bearing points after galvanizing are  $\pm\frac{1}{8}$  inch from the first lay down;
- b. Camber points after galvanizing are  $+\frac{1}{4}$  inch or  $-0$  inch from the first lay down; and
- c. Sweep points after galvanizing are  $\pm\frac{3}{8}$  inch from the first lay down.

If individual beams or girders exceed the listed tolerances, place the beam or girder with at least two adjacent beams or girders in lay down to check against the recorded shop assembly records in accordance with subsection [707.03.C.7](#). Ensure the fabricator records, and the Engineer witnesses, the second lay down or individual member cambers.

Stencil in accordance with subsection [715.03.D.5](#) except designate the coating type as 4GS.

**C. Handling Coated Steel.** Use care when handling coated steel in the shop and during shipment, erection, and assembly. To ensure the coating is not damaged, do not move or handle coated steel until the



coating cures. Protect the steel from binding chains with softeners approved by the Engineer. Use padded hooks and slings to hoist steel. Space diaphragms and similar pieces during shipment to prevent damage from rubbing. At the project site, store the steel components on pallets to ensure they do not rest on the ground or fall against or rest on each other. Provide shipping and project site storage details to the Engineer at the pre-fabrication meeting and obtain Engineer's approval before shipping the steel.

**D. Shop and Field Repair.** Make shop and field repairs to the coating in accordance with the coating manufacturer's recommendations, or in accordance with this section, whichever is more stringent. Submit written procedures to the Engineer and obtain Engineer's approval for shop and field repairs for approval before applying coating. For surfaces, inaccessible after erection, repair and recoat before erection. Prepare accessible steel for repairs after completion of erection work, including connections and straightening of bent steel.

1. **Cleaning.** Shop clean in accordance with subsection [716.03.A](#). Field clean in accordance with subsection [715.03.C](#).
2. **Coating.** Apply shop coats in accordance with subsection [716.03.B](#). Apply field coats in accordance with subsection [715.03.D](#), using the same coating material as applied in the shop.

**E. Repair of Damaged Galvanized Surfaces.** If damage occurs to the zinc coating during transporting, handling, or installing, repair the damage at no additional cost to the Department. Exposed underlying steel or coating thicknesses less than 50 percent of the specified thickness or thickness equivalent is considered damage.

Thickness equivalent: 1 ounce of zinc per square foot equals 1.7 mils.

For repair coating, apply a coating 1½ times the thickness or thickness equivalent specified for galvanizing on the item, but not less than 5 mils. Use zinc-based solder, zinc-rich paint, or sprayed zinc (metallizing) in accordance with ASTM A 780. Obtain the Engineer's approval before using sprayed zinc.

Clean the metal and apply the coating in accordance with Annex A1, A2, or A3 of ASTM A 780, except as modified in this subsection.

If using zinc-based solder for repair, use temperature sensitive crayons to verify the preheat temperature of the metal before depositing the zinc alloy.

If using zinc-rich paint for repair, clean the damaged surface to near-white metal before applying the paint. Apply the paint in accordance with the manufacturer's recommendations for temperature and dryness.

#### **716.04. Measurement and Payment.**

| <b>Pay Item</b>                                       | <b>Pay Unit</b> |
|---|-----------------|
| Field Repair of Damaged Coating (Structure No.) ..... | Lump Sum        |

The Engineer will measure **Field Repair of Damaged Coating (Structure No.)** as a unit for each structure. The unit price for **Field Repair of Damaged Coating (Structure No.)** includes the costs of making field repairs to the shop applied coating system; applying a prime coat to structural steel surfaces and exposed surfaces of bolts, nuts, and washers; and repairing stenciling and the coating of galvanized components that are not shop coated.

The unit price for **Structural Steel, Furn and Fab**, of the type specified, includes the cost of applying and shop repairing the complete coating system, including stenciling and approved sealants.

Repair of damaged galvanized surfaces is included in the pay item for furnishing the galvanized component.

**Section 717. DOWNSPOUTS AND DRAINS**

**717.01. Description.** This work consists of providing and installing deck drains and downspouts, adjusting existing deck drains, extending existing downspouts, and protecting deck drain systems during construction.

**717.02. Materials.** Provide materials in accordance with the following:

|                            |                     |
|----------------------------|---------------------|
| Drain Castings .....       | <a href="#">908</a> |
| Miscellaneous Metals ..... | <a href="#">908</a> |
| Downspouts .....           | <a href="#">909</a> |
| Drain Extensions .....     | <a href="#">909</a> |

**717.03. Construction.**

**A. New Construction.** Install new drain castings and downspouts at the locations and elevations shown on the plans.

**B. Adjusting Existing Deck Drains.** Adjust existing drain castings and downspouts to the new elevations shown on the plans.

**C. Downspout Replacement.** Fabricate replacement downspouts from material meeting subsection [909.08.A](#) with an inside diameter sized to fit the outside of the existing drain casting. Provide a downspout length that extends from the drain casting to 6 inches below the beams. Remove existing downspout. Attach the replacement downspout to the existing drain casting with four equally spaced, galvanized, ½-inch diameter steel cap screws, drilled and tapped into the casting. If the depth of the adjacent beams exceeds 42 inches, install a support bracket.

**D. Deck Drain Extension.** Fabricate and install deck drain extensions meeting the requirements of subsection [909.07.C](#). Center extensions beneath the existing drain opening and fasten directly to the deck.

**E. Protecting Deck Drainage Systems.** Protect existing deck drains and downspouts during construction. Prevent debris from clogging the deck drains and downspouts. Obtain the Engineer's approval for the protection method.

Before beginning work on existing bridges, conduct an inspection with the Engineer to determine the condition of deck drains and downspouts. At the completion of the project, clean the deck drains and downspouts to provide free flowing deck drains and downspouts clear of debris at no additional cost to the Department.

**717.04. Measurement and Payment.**

| <b>Pay Item</b>              | <b>Pay Unit</b> |
|------------------------------|-----------------|
| Drain Casting, Type _____    | Each            |
| Drain Casting Assembly ..... | Each            |
| Deck Drain, Adj.....         | Each            |
| Downspout Replacement .....  | Each            |
| Deck Drain, Extension .....  | Each            |

A. **Drain Casting, Type** \_\_\_\_\_. The unit price for **Drain Casting, Type** \_\_\_\_\_ includes the cost of providing and installing the drain casting.

B. **Drain Casting Assembly.** The unit price for **Drain Casting Assembly** includes the cost of providing and installing the drain casting and downspout and, if necessary, the lower bracket.

C. **Deck Drain, Adjust.** The unit price for **Deck Drain, Adj** includes the cost of adjusting the drain casting and downspout.

D. **Downspout Replacement.** The unit price for **Downspout Replacement** includes the costs of the following:

1. Taking field measurements to determine downspout size;
2. Providing hardware to fasten the downspout to the drain casting; and
3. If the depth of the adjacent beams is greater than 42 inches, providing and installing the lower bracket.

E. **Protecting and Cleaning Deck Drainage Systems.** The cost of protecting and cleaning deck drainage systems is included in the unit prices of other relevant pay items.

**Section 718. DRILLED SHAFTS**

**718.01. Description.** This work consists of providing and constructing drilled shaft foundations.

**718.02. Materials.** Provide materials in accordance with the following:

|                             |                     |
|-----------------------------|---------------------|
| Concrete, Grade S2, T ..... | <a href="#">701</a> |
| Steel Reinforcement .....   | <a href="#">905</a> |
| Casing.....                 | <a href="#">906</a> |

Provide steel reinforcement meeting the yield strength shown on the plans.

Provide Concrete, Grade S2 in dry conditions and Concrete, Grade T in under-water conditions for Drilled Shafts. Modify slump for site conditions as follows:

- A. From 6 inches to 8 inches for conditions except concrete placement under water or under drilling slurry,
- B. From 7 inches to 9 inches for concrete placed under water or under drilling slurry.

**718.03. Construction.** Review available soil boring logs from subsurface investigations. If, during construction, actual subsurface conditions differ substantially from those reported on the boring logs, notify the Engineer in writing within 48 hours of determining the discrepancy.

The complete geotechnical report, outlining the subsurface exploration conducted during the design phase, is available for review before bidding. The Department does not intend for boring log data as representation or warranties of continuity. The Department is not responsible for interpretations or conclusions drawn by the Contractor.

The Contractor may perform additional soil test borings and other exploratory procedures at no additional cost to the Department.

**A. Drilled Shaft Installation Plan.** Submit an installation plan, for the Engineer’s approval, 21 calendar days before beginning drilled shaft installation. Provide detailed information on the following:

- 1. Proposed equipment, including cranes, drills, augers, core barrels, bailing buckets, final cleaning equipment, slurry pumps, tremies or concrete pumps, and casing;
- 2. The construction sequence;
- 3. Shaft excavation methods, including proposed excavation methods through supporting and caving soil layers;

4. Methods to mix, circulate, and de-sand slurry;
5. Methods to clean shaft excavation;
6. Reinforcement placement, including support and centering methods;
7. Concrete placement, including free fall, tremie, or concrete pumping procedures;
8. Drilled shaft installation plan, including methods to prevent drilled shaft excavation spoils from entering waterways, wetlands and floodplains;
9. A fall protection plan conforming to the MIOSHA Construction Safety Standards, including a rescue plan for shafts with a diameter of at least 30 inches and at least 6 feet deep, in place before drilling; and
10. Other information shown on the plans or requested by the Engineer.

The Engineer will evaluate the drilled shaft installation plan and notify the Contractor, within 7 calendar days of receiving the plan, of additional information required and changes to meet contract requirements.

The Engineer will reject unacceptable parts of the plan. Resubmit changes for reevaluation. Drilled shaft installation plan procedures are subject to trials in the field.

The Engineer's approval does not relieve the Contractor of completing the work and is not cause for extra compensation if construction methods or equipment do not provide a satisfactorily drilled shaft.

**B. General Methods and Equipment.** Excavate for the drilled shaft, to the dimensions and elevations shown on the plans, through encountered materials. Use methods and equipment for the intended purpose and materials encountered. Control operations to prevent damage to existing structures and utilities. Use preventative measures including the selection of construction methods and procedures that prevent caving of the shaft excavation, and monitoring and controlling the excavation depth. Repair damage to existing structures or utilities, to the satisfaction of the Engineer, including engineering analysis and redesign, without extending the project completion dates, and at no additional cost to the Department. Obtain the Engineer's approval for the selected general method.

1. **Dry Construction Method.** Use the dry construction method at sites where the groundwater table and site conditions allow shaft construction in dry excavation, and where the sides and bottom of the shaft remain stable without caving, sloughing, squeezing or swelling. Ensure the Engineer can visually inspect the shaft before concrete placement.

Excavate the drilled shaft hole, remove accumulated water and loose material, and place the shaft concrete in a dry excavation. Ensure the flow rate of water into the excavation does not exceed 12 inches within 1 hour. Do not place the initial concrete if the depth of water in the bottom of the excavation exceeds 3 inches.

2. **Wet Construction Method.** Use the wet construction method at sites where dry excavation cannot be maintained during shaft concrete placement. Use water or slurry to contain seepage and groundwater movement and place concrete using a tremie or concrete pump. Maintain the stability of the excavation perimeter while advancing the excavation to the final depth, placing the reinforcing cage, and placing the shaft concrete. De-sand and clean slurry, if used.

Maintain a water or slurry fluid elevation higher than the static water table during drilling operations and inside drilled shafts not connected into the bedrock.

Unless otherwise approved by the Engineer, provide temporary surface casings for shaft alignment and position and to prevent sloughing of the top of the shaft excavation. Extend surface casings to an elevation in the shaft excavation that prevents sloughing of the surrounding soil.

3. **Dry Temporary Casing Method.** Use the dry temporary casing method where caving soils occur but casing can maintain a dry and stable excavation. In dry soil, install a temporary casing through the caving soils to the bottom of shaft. If ground water is present, install a temporary casing to an impermeable stratum. Remove excess water and soil from the casing.

Advance the casing and excavation simultaneously. Do not drill outside or below the casing through caving soil layers. Ensure the bottom of the excavation remains dry and stable until placement of the reinforcing steel and concrete. Withdraw the casing while the concrete is workable. Before withdrawing casing, increase the level of fresh concrete in the casing to ensure the upward displacement of fluid behind the casing.

4. **Wet Temporary Casing Method.** Use the wet temporary casing method where caving soils occur and a dry excavation cannot be maintained, the soil profile is permeable, and the groundwater elevation is higher than the bottom of the shaft elevation. Install the casing through caving soils to the required bottom of shaft elevation, and drill the excavation to the required dimensions. Advance the

casing and excavation simultaneously. Do not drill outside or below the casing through caving soil layers.

Maintain a positive pressure differential between the fluid level in the excavation and the groundwater elevation during drilling, excavation, and clean out. Place reinforcing steel and pump or tremie concrete to the bottom of the excavation. Displace water inside the casing with concrete. Do not pump water out of the casing.

The wet temporary casing method may include drilling slurry. Perform final cleaning of the excavation with a clean out bucket. Before and during casing removal, increase the level of fresh concrete in the casing to ensure the upward displacement of fluid behind the casing, without contaminating or displacing the shaft concrete.

5. **Construction Method Log.** Submit to the Engineer a Daily Construction Method Log during drilled shaft excavation and construction. Ensure the log includes the following information for each drilled shaft:

- a. Date (start date and completion date);
- b. Drilled shaft identification number;
- c. Location;
- d. Actual top and bottom elevation of drilled shaft;
- e. Shaft diameter;
- f. Final centerline location at top;
- g. Variation of drilled shaft from plumb;
- h. Top and bottom elevation of any permanent casing;
- i. Description of each soil and rock material encountered during excavating and the top and bottom depths or elevations;
- j. Depth drilled into bearing stratum;
- k. Top and bottom elevations of obstructions encountered;
- l. Amount of obstruction time;
- m. Depth or elevation of encountered seepage or groundwater;
- n. Record the actual volume of concrete placed with the theoretically calculated concrete volume to detect any large voids or intrusions of extraneous material; and
- o. Remarks.

C. **Construction Tolerances.**

1. **Horizontal Alignment.** Drill shafts within 3 inches of the centerlines shown on the plans at the top-of-shaft elevation.
2. **Plumb.** Ensure the bottom elevation of the drilled shaft is out-of-plumb by no more than 1 percent of the drilled shaft length, as



measured horizontally from the actual center of the shaft at the shaft design top elevation.

3. **Reinforcing Steel.** Maintain the top of the reinforcing steel cage no greater than 1 inch above and no greater than 3 inches below the required position. If the reinforcing steel cage is not within the tolerances specified, correct the position.

Do not construct additional shafts until the Engineer approves the method of reinforcing steel cage support.

4. **Top of Shaft Elevation.** Ensure the top elevation of the shaft is from +1 inch to -3 inches from the top of shaft elevation shown on the plans.

The Engineer will consider drilled shaft excavations and completed shafts, not constructed within the required tolerances, unacceptable. Correct unacceptable shaft excavations and completed shafts to the Engineer's satisfaction. Complete corrections for out-of-tolerance drilled shafts, including engineering analysis, and redesign, at no additional cost to the Department, and with no extension to the project completion dates.

- D. **Casings.** Case shaft excavations, as shown on the plans. Cut off temporary, left-in-place casing at the elevation shown on the plans.

Provide smooth, watertight, metal casings capable of withstanding handling, installation, and the pressure of concrete and the surrounding earth materials. Provide a casing with an inside diameter at least the size of the shaft. Remove casings from the excavation, except those approved by the Engineer for the permanent casing.

Attach fixtures to the top of the casings, to aid in removing temporary casings. Remove temporary casings while the concrete remains workable. Complete concrete placement in the shaft before removing temporary casing. Extract casings slowly, with the pull in-line with the shaft axis. Do not apply forces that induce moments in the shaft, detrimental to the concrete.

- E. **Slurry.** If using slurry in the drilling process, use polymer type slurry. Provide polymer slurry with viscosity and gel characteristics capable of transporting excavated material to a screening system or settling tank. Ensure the percentage and specific gravity of the material making the suspension maintains the stability of the excavation and allows concrete placement. Maintain the height of the slurry capable of preventing the excavation sides from caving and the excavation bottom from heaving.

Premix the slurry with clean, fresh water, and allow time for hydration before introducing into the shaft excavation. Agitate, circulate, and adjust the properties of the slurry to prevent slurry from “setting up” in the shaft excavation.

Perform control tests using an apparatus on the slurry to determine density, viscosity, and pH in accordance with ASTM or AASHTO standards. Ensure density, viscosity, and pH values meet the ranges specified in Table 718-1.

| <b>Property</b>                 | <b>Test Method</b>   | <b>At Time of Slurry<br/>Introduction<br/>(Emulsified Polymer)</b> | <b>At Time of Concreting<br/>in Excavation<br/>(Emulsified Polymer)</b> |
|---------------------------------|----------------------|--|---|
| Density, lb/ft <sup>3</sup>     | Density<br>Balance   | <63  | <63   |
| Viscosity, s/qt                 | Marsh Cone           | 33 – 43  | 33 – 43   |
| pH                              | pH Paper or<br>meter | 8 – 11   | 8 – 11  |
| Maximum<br>Contact Time<br>(hr) | —                    | 72   | 72  |
| Sand Content                    | API-13B-1            | <1%  | <1%   |

If de-sanding is required, do not allow the sand content to exceed 1 percent by volume in the shaft excavation, as determined by the American Petroleum Institute sand content test.

Determine density, viscosity, and pH values before and during the shaft excavation to establish a consistent working pattern.

Before placing shaft concrete, use a Department-approved slurry-sampling tool to take slurry samples from the bottom, and at mid-height, of the shaft. Eliminate heavily contaminated slurry accumulated at the bottom of the shaft.

Control slurry exiting the excavation. Contain slurry in the excavation and remove as it becomes displaced by concrete placement.

**F. Excavation.** Maintain the stability of the excavation sidewalls and extend the shaft excavation to a stratum accepted by the Engineer. Extend drilled shaft tip elevations if the Engineer determines the bearing stratum, encountered during excavation, is unsuitable or differs from the bearing stratum anticipated in the design of the drilled shaft.

Provide the Engineer access to auger cuttings of the bearing material for additional analysis. Fill shaft over-excavation with concrete at no additional cost to the Department, unless Engineer determines the

bearing stratum encountered during excavation is unsuitable or differs from the bearing stratum anticipated in the design of the drilled shaft. Fill unauthorized shaft excavations extended below required depths or elevations with concrete, at no additional cost to the Department.

Dispose of excavated material, removed from shaft excavations, in accordance with section [205](#). Keep excavated materials away from open shaft excavations. Direct surface water away from shaft excavations. Ensure excavated material does not enter waterways, wetlands or floodplains.

1. **Inspection.** Provide equipment for checking the dimensions and alignment of each permanent drilled shaft. Use the following methods to determine the dimensions and alignment with the Engineer's direction:
  - a. Check drilled shaft dimensions and alignment with reference stakes and plumb bob;
  - b. Check the dimensions and alignment of casing inserted in the excavation;
  - c. Insert a casing in shaft excavations temporarily; or
  - d. Insert a rigid rod assembly with several 90-degree offsets equal to the shaft diameter, into the shaft excavation.

After shaft excavation, provide access, lighting, and time for the Engineer to inspect the shaft if a tremie pour is not required.

Reference the depth of the shaft during drilling to marks on the Kelly Bar. Measure final drilled shaft depths with a weighted tape after final cleaning.

Clean each shaft so at least 50 percent of the base contains less than ½ inch of sediment. Do not leave more than 1½ inch of debris on the base. The Engineer will visually inspect dry excavations and inspect wet excavation by other methods to determine cleanliness.

2. **Obstructions.** Remove surface and subsurface obstructions in the length of excavation at drilled shaft locations. Obstructions may include old concrete foundations, abandoned utilities, or boulders. Use special procedures, tools, or both if unable to advance excavation using augers fitted with soil or rock teeth, drilling buckets, or under-reaming tools. Special procedures and tools include:
  - a. Chisels,
  - b. Boulder breakers,
  - c. Core barrels,
  - d. Air tools,

- e. Hand excavation,
- f. Temporary casing, and
- g. Enlarging the hole diameter.

**G. Placing Steel Reinforcement.** Place steel reinforcement in accordance with subsection [706.03.E](#).

Assemble the reinforcing steel cage, and place immediately after excavation inspection and immediately before concrete placement. If concrete is not placed immediately after the cage installation, the Engineer may direct removal of the cage before placing the concrete to verify the integrity of the excavated area and ensure removal of loose or soft material from the bottom of the excavation.

Construct the cage of longitudinal bars and lateral reinforcement consisting of spiral reinforcement, lateral ties, or horizontal bands. If overhead obstacles prevent placing the cage as a single unit, connect individual segments with couplers or by lapping steel, as approved by the Engineer. Provide a fully assembled steel reinforcement cage for inspection two working days before to the start of construction.

Tie and support the reinforcing steel to meet the required tolerances. Tie spacers at quarter points around the cage perimeter and space at intervals no greater than 5 feet along the length of the cage. If the size of the longitudinal reinforcing steel equals or exceeds a diameter of 1 inch, the Contractor may increase the minimum distance between spacing devices to 10 feet.

Use spacers to ensure a minimum annular space of 3 inches between the outside of the cage and the side of the excavation or casing. Use at least one spacer per 30 inches of the outside circumference of the cage. Place at least three spacers at each level of the cage.

Use non-corrosive spacers. The Contractor may use round plastic spacers. Do not use concrete blocks, wood blocks, or metal chairs on the sides of the shaft. The Contractor may use concrete blocks on the bottom of the shaft to maintain cover.

Support or hold down the cage to control vertical displacement during concrete placement or casing extraction. Use support, concentric with the cage to prevent the steel from racking and distorting. Check the elevation of the top of the steel cage before and after concrete placement or after casing extraction.

**H. Concrete Placement.** Do not place concrete in drilled shaft excavation before the Engineer accepts the drilled shaft excavation. Inspect the drilled shaft excavation immediately before placing the

concrete. Provide lighting capable of illuminating the reinforcing steel cage, and the sides and the bottom of the drilled shaft excavation for inspection.

For wet method construction, inspect by probing and measuring. If the top-of-shaft elevation is below ground during concrete placement, use a casing to prevent material from caving into fresh concrete.

Place concrete as soon as possible after completing excavation and placing reinforcing steel.

For dry method construction, remove loose material and accumulated water from the bottom of the excavation before placing concrete. If unable to remove water, place concrete using underwater placement methods.

For wet method construction, place concrete in one continuous operation from bottom to top of the shaft. After the concrete reaches the top of the drilled shaft, continue pumping and remove contaminated concrete until the Engineer determines acceptable quality concrete appears at the top of the shaft. Continue placing concrete through the tremie pipe until contaminated concrete flows over the top of the shaft.

Do not vibrate concrete with a vibrator. When removing the casing, ensure the force of downward flowing concrete does not deform the reinforcing steel cage.

Place concrete by free fall method, tremie, or pumping. Use a sump, or other Department-approved method to channel displaced fluid and concrete away from the shaft excavation. Recover and dispose of slurry as approved by the Engineer. Do not discharge displaced fluids into waterways, wetlands or floodplains. For concrete pours over water, provide a collar or other means to capture slurry and the top portion of the concrete slushed from the shaft.

1. **Free Fall Concrete Placement.** The Contractor may place concrete in a dry drilled shaft excavation using the free-fall method if concrete falls to the final position without striking the sides of the excavation, the reinforcing steel cage, or other obstructions. Use a centering drop chute, at least 3 feet long with the free-fall method.

If concrete placement causes the shaft excavation to cave or slough, or if concrete strikes the rebar cage or sidewall, reduce the height of free-fall, the rate of concrete flow into the excavation, or both. Do not use a shovel or other means to deflect the concrete discharged directly from the truck. Limit the free-fall distance to 80 feet.

If the Engineer determines dewatering is impractical, or concrete placement by free-fall method cannot be accomplished, place concrete using a tremie or a concrete pump.

2. **Tremie.** The Contractor may use a gravity tremie for concrete placement instead of a concrete pump in wet or dry excavations.

Use tremies with a tube of a length, weight, and diameter to discharge concrete at the shaft base elevation. Do not allow aluminum parts to contact the concrete. Use tremies with an inside diameter of at least 10 inches.

Provide tremies with smooth, clean inside and outside surfaces to allow flow of concrete and unimpeded tremie withdrawal during concreting. Use tremies with thick walls to prevent crimping or sharp bends that restrict concrete placement.

For concrete placement, use watertight tremies. Do not begin underwater concrete placement until positioning the tremie to the shaft bottom elevation. Use valves, bottom plates, or plugs to begin concrete discharge within one tremie diameter of the base. Remove plugs from the excavation or use plugs of an Engineer-approved material that does not cause defects in the shaft if not removed. Construct the discharge end of the tremie to allow the free radial flow of concrete during placement operations. Immerse the tremie discharge end at least 10 feet in concrete after beginning the concrete flow.

Place concrete continuously until shaft completion. Keep the shaft full of concrete and the tremie submerged in placed concrete. Raise the tremie as necessary to maintain the free flow of concrete and casing stability.

If withdrawal of the submerged end of the tremie interrupts concrete placement, remove the tube, reseal it at the bottom, reinsert the tube into the placed concrete by at least 10 feet, and recharge before continuing the concrete placement.

For uncased wet excavations, maintain the drilled shaft excavation full of slurry or water so water does not flow into the shaft excavation.

For cased shafts, maintain a head of concrete above the bottom of the casing to overcome hydrostatic pressure. Extract casing at a slow, uniform rate with the pull in line with the shaft axis. Monitor the concrete level in the casing during extraction. Stop the extraction and add concrete to the casing to ensure a completely full excavation upon casing removal.

Ensure the elapsed time from mixing the first concrete placed in the cased shaft to completion of casing extraction, does not exceed the time concrete maintains a slump of over 4 inches. If the elapsed time is exceeded, modify the concrete mix, the construction procedures, or both for subsequent shafts.

- 3. Pumped Concrete.** Pump concrete into wet or dry excavations, using concrete pump pipe with a diameter of at least 4 inches and constructed with watertight joints. Arrange the concrete pump equipment so vibrations do not damage fresh concrete. Arrange pipes carrying concrete from the pump to the shaft with minimal bends. Anchor pipes conveying concrete to the bottom of the drilled shaft excavation to the steel casing or other stationary objects to prevent the pipe from undulating during initial concrete placement. Do not begin concrete placement until positioning the pump line orifice at the shaft base elevation.

Do not use aluminum pipe to convey concrete. Operate the pump to produce a continuous stream of concrete without air pockets. To prevent contamination of concrete placed initially at the bottom of the shaft excavation, seal the outlet end of the pumping pipe with a diaphragm or plug flushed out when the hydrostatic pressure from the column of concrete exceeds that of the water in the shaft excavation.

Control the initial rate of concrete placement to prevent lift or displacement of the reinforcing steel cage. Use a watertight conveying system, and maintain the outlet end at least 10 feet below the top of freshly placed concrete. When concrete reaches the top of the drilled shaft column, remove laitance.

If withdrawal of the submerged end of the pump interrupts concrete placement, remove the tube, reseal it at the bottom, reinsert into the placed concrete by at least 10 feet, and recharge before continuing the concrete placement.

For uncased wet excavations, maintain the drilled shaft excavation full of slurry or water so water does not flow into the shaft excavation.

For cased excavations, maintain a head of concrete above the bottom of the casing to overcome hydrostatic pressure. Extract casing at a slow, uniform rate with the pull in line with the shaft axis. Monitor the concrete level in the casing during extraction. Stop extraction and add concrete to the casing as necessary to ensure a completely full excavation upon casing removal.

Ensure the elapsed time from mixing the first concrete placed in the cased shaft excavation to completion of casing extraction does not exceed the time concrete maintains a slump of over 5 inches. If the elapsed time is exceeded, modify the concrete mix, the construction procedures, or both for subsequent shafts.

#### 718.04. Measurement and Payment.

| <b>Pay Item</b>   | <b>Pay Unit</b> |
|---|-----------------|
| Drilled Shaft, ___ inch .....                           | Foot            |
| Drilled Shaft Equipment, Furnished (Structure No.)..... | Lump Sum        |
| Temp Casing-Left in Place .....                         | Foot            |
| Temp Casing .....                                       | Foot            |
| Permanent Casing.....                                   | Foot            |
| Obstruction Removal.....                                | Dollars         |

A. **Drilled Shafts.** The unit price for **Drilled Shaft, \_\_\_ inch** includes the cost of the following:

1. Drilled shaft excavation;
2. Temporary casings;
3. Slurry;
4. Shaft concrete;
5. Steel reinforcement cage;
6. Disposal of excavated material and slurry for construction; and
7. Preventative measures for maintaining surface water or drains free of cuttings or slurry.

B. **Casings.**

1. **Temporary Casing-Left in Place.** The unit price for **Temporary Casing-Left in Place** includes the cost of placing temporary casings left in place, as shown on the plans and cutting the casings to the elevation shown on the plans.
2. **Temporary Casing.** The unit price for **Temporary Casing** includes the cost of placing temporary casings as shown on the plans and removing the casings.
3. **Permanent Casing.** The unit price for **Permanent Casing** includes the cost of placing permanent casings as shown on the plans.

C. **Drilled Shafts.** The unit price for **Drilled Shaft Equipment, Furnished**, includes the cost of providing and removing equipment for constructing the drilled shaft and providing and removing equipment for soil and rock excavation.



D. **Obstruction Removal.** The Department will pay for removing obstructions as **Obstruction Removal** if the Contractor uses the special procedures and tools specified in subsection [718.03.F.2.](#)

The Engineer will designate obstructions for the Contractor's removal. The Department will establish a budget amount to pay for removing obstructions. If the Contractor and Engineer do not agree on a unit or lump sum price, the Engineer may order the work performed on a force account basis in accordance with subsection [109.05.D.](#)

## DIVISION 8 – INCIDENTAL CONSTRUCTION

| <b>Section</b> | <b>Title</b>  | <b>Page No.</b>     |
|----------------|---|---------------------|
| 801            | Concrete Driveways .....  | <a href="#">537</a> |
| 802            | Concrete Curb, Gutter, and Dividers .....   | <a href="#">538</a> |
| 803            | Concrete Sidewalks, Sidewalk Ramps, and Steps .....   | <a href="#">542</a> |
| 804            | Concrete Barriers, Glare Screens, and Foundations for Light Standards and Sign Supports ..... | <a href="#">546</a> |
| 805            | Hot Mix Asphalt Curb .....  | <a href="#">550</a> |
| 806            | Shared Use Paths .....  | <a href="#">552</a> |
| 807            | Guardrail, Guardrail Terminals, and Miscellaneous Posts .....                                 | <a href="#">556</a> |
| 808            | Fencing .....   | <a href="#">562</a> |
| 809            | Field Office.....   | <a href="#">568</a> |
| 810            | Permanent Traffic Signs and Supports .....  | <a href="#">571</a> |
| 811            | Permanent Pavement Markings .....   | <a href="#">588</a> |
| 812            | Temporary Traffic Control for Construction Zone Operations.....                               | <a href="#">601</a> |
| 813            | Slope Protection.....   | <a href="#">633</a> |
| 814            | Paved Ditches .....   | <a href="#">637</a> |
| 815            | Landscaping.....  | <a href="#">640</a> |
| 816            | Turf Establishment .....  | <a href="#">648</a> |
| 817            | Landscape Mowing.....   | <a href="#">660</a> |
| 818            | Dune Grass Planting .....   | <a href="#">662</a> |
| 819            | Electrical and Lighting .....   | <a href="#">663</a> |
| 820            | Traffic Signals .....   | <a href="#">685</a> |
| 821            | Preservation of Land Monuments, Control Points, and Property Corners.....                     | <a href="#">705</a> |
| 822            | Ground or Cut Shoulder Corrugations.....  | <a href="#">711</a> |
| 823            | Water Mains .....   | <a href="#">713</a> |
| 824            | Contractor Staking.....   | <a href="#">725</a> |

## NOTES

## Section 801. CONCRETE DRIVEWAYS

**801.01. Description.** This work consists of constructing reinforced, or non-reinforced concrete driveways as required by the contract.

**801.02. Materials.** Provide materials in accordance with the following:

|                               |                     |
|-------------------------------|---------------------|
| Concrete, Grade P1, P-NC..... | <a href="#">601</a> |
| Concrete, Grade S2.....       | <a href="#">701</a> |
| Curing Compound .....         | <a href="#">903</a> |
| Steel Reinforcement .....     | <a href="#">905</a> |
| Joint Materials .....         | <a href="#">914</a> |

**801.03. Construction.** Construct driveways in accordance with subsection [803.03](#), for sidewalks.

Use wire fabric reinforcement for reinforced driveways in accordance with Standard Plan R-29 Series.

**801.04. Measurement and Payment.**

| <b>Pay Item</b>                       | <b>Pay Unit</b> |
|---------------------------------------|-----------------|
| Driveway, Reinf Conc, _ inch .....    | Square Yard     |
| Driveway, Nonreinf Conc, _ inch ..... | Square Yard     |

A. **Acceptance.** Conduct concrete quality control as specified in section [604](#). The Engineer will conduct quality assurance as specified in section [605](#). The Department will pay for this work based on the quality assurance results.

B. **Driveway, Reinf Conc and Driveway, Nonreinf Conc.** The Engineer will measure and the Department will pay for **Driveway, Reinf Conc** and **Driveway, Nonreinf Conc** of the thickness required, based on the surface area of the driveway measured in place.

## Section 802. CONCRETE CURB, GUTTER, AND DIVIDERS

**802.01. Description.** This work consists of constructing the following items on the prepared base, with or without reinforcement, as required by the contract:

- A. Concrete curb, combination curb and gutter, curb nose;
- B. Valley gutter, and shoulder gutter;
- C. Down spout headers, and spillways; and
- D. Dividers.

**802.02. Materials.** Provide materials in accordance with the following:

|                          |                     |
|--------------------------|---------------------|
| Concrete, Grade P1.....  | <a href="#">601</a> |
| Concrete, Grade S2.....  | <a href="#">701</a> |
| Mortar, Type R-2 .....   | <a href="#">702</a> |
| Curing Compound .....    | <a href="#">903</a> |
| Steel Reinforcement..... | <a href="#">905</a> |
| Geotextile Liner .....   | <a href="#">910</a> |
| Lane Ties.....           | <a href="#">914</a> |
| Joint Fillers .....      | <a href="#">914</a> |

**802.03. Construction.**

A. **Preparation of Base.** Prepare the base in accordance with subsection [602.03.B](#). Construct a uniform base, compacted to 95 percent of the maximum unit weight of the base. Prepare the base and geotextile liner for concrete spillways in accordance with subsection [814.03.A](#).

B. **Placing Forms.** Place fixed forms in accordance with subsection [602.03.C](#). Use face forms, where required, to construct straight curbs with fixed forms.

If using slip forming methods, match the dimensions of the form to the dimensions of the curb shown on the plans.

C. **Placing Steel Reinforcement.** Space and fix steel reinforcement or lane ties in the correct position during concrete placement, as required.

Splice steel reinforcement bars by lapping, and securely wiring the bars with at least two ties per splice. Lap the bars at least 10 inches.

Place mesh reinforcement in accordance with subsection [602.03.E](#).

D. **Placing Concrete.** Obtain the Engineer's approval for the base before placing concrete. Moisten the base before placing concrete.

For concrete curbing constructed as an integral part of the concrete pavements, except at night headers, place concrete curbing within 30 minutes of placing the concrete for the pavement. At night headers, use ties and methods approved by the Engineer.

Construct transitions between concrete valley gutter and concrete curb and gutter as miscellaneous pavement in accordance with section [602](#).

Obtain the Engineer's approval for forms and form placement before placing concrete.

Place concrete to the required depth and spade or vibrate to ensure consolidation.

Before applying membrane curing compound, repair honeycombed areas or voids with Type R-2 mortar or remove and replace as directed by the Engineer.

E. **Joints.** Construct joints perpendicular to the surfaces of the curb, gutter or dividers, and no greater than  $\frac{1}{4}$  inch from the plan location. Seal joints in accordance with subsection [602.03.S](#).

1. **Contraction Joints and Plane-of-Weakness Joints.** Construct joints, as approved by the Engineer, to ensure a plane-of-weakness at least  $\frac{1}{4}$  the depth of the section.

2. **Expansion Joints.** Place expansion joint filler to the full depth of the joint. Recess the top of the joint filler  $\frac{1}{4}$  inch to  $\frac{1}{2}$  inch below the finished surface of the structure.

F. **Finishing.** Use finishing tools approved by the Engineer. Round the exposed edges to a  $\frac{1}{4}$ -inch radius, including transverse joints. Shape the face of the curb to produce the radii shown on the plans. Fill low spots with the same concrete mixture used in the work.

Finish exposed surfaces smooth and even, and lightly brush using a broom, brush, or burlap. Finish the gutter and top of curb to within  $\frac{3}{16}$  inch when checked with a 10-foot straightedge. Finish other exposed surfaces to within  $\frac{3}{8}$  inch of the alignment and typical cross section.

Do not add water to the concrete surface to aid finishing.

G. **Stenciling.** Stencil survey station numbers, in accordance with subsection [602.03.L](#), into the exposed surface of continuous runs of concrete curb, gutter, curb and gutter, and driveway opening, or shoulder that directly adjoins the traveled way. Stenciling curb and gutter is not required if concrete barrier is present and is stenciled in accordance with subsection [804.03.E](#).

Place stencil numbers as follows:

1. To be read from the traveled way;
2. On one side of one-way roadways (preferably the right side);
3. On both sides of the traveled way of two-way roadways; and
4. Midway up on the face of a curb or 2 inches from the back of a gutter or driveway opening.

H. **Curing.** Cure concrete curb, gutter, and dividers in accordance with subsection [602.03.M](#).

I. **Weather and Temperature Limitations.** Protect concrete curb, gutter, and dividers in accordance with subsection [602.03.T](#).

J. **Backfilling.** After the concrete gains the required strength, backfill, compact, and grade the remaining excavated areas.

**802.04. Measurement and Payment.**

| <b>Pay Item</b>                        | <b>Pay Unit</b> |
|--|-----------------|
| Curb, Conc, Det _____                  | Foot            |
| Curb and Gutter, Conc, Det _____       | Foot            |
| Valley Gutter, Conc _____              | Foot            |
| Curb and Gutter, Bridge Approach _____ | Foot            |
| Shoulder Gutter, Conc, Det _____       | Each            |
| Curb Nose _____                        | Each            |
| Downspout Header, Conc _____           | Each            |
| Driveway Opening, Conc, Det M _____    | Foot            |
| Spillway, Conc _____                   | Foot            |
| Divider, Reinf Conc, Type I _____      | Square Foot     |
| Divider, Non reinf Conc, Type _____    | Square Foot     |

A. **Concrete Acceptance.** Conduct concrete quality control as specified in section [604](#). The Engineer will conduct quality assurance as specified in section [605](#). The Department will pay for concrete required for this work based on the quality assurance results.

B. **Curb, Concrete; Curb and Gutter, Concrete; Valley Gutter, Concrete; and Curb and Gutter, Bridge Approach.** The Engineer will measure **Curb and Gutter, Conc, Det, Valley Gutter, Conc,** and **Curb and Gutter, Bridge Approach** in place along the joint of the curbing with the pavement. The Engineer will not make deductions in the pay item measured length for catch basins, inlet castings, or Detail L driveway openings. The plans will show the pay limits for **Valley Gutter, Conc**. The Engineer will divide transition areas between **Valley Gutter, Conc** and **Curb and Gutter, Conc** in half and will measure each half in the units of the adjacent item.

C. **Integral Curb and Pavement Construction.** If the Contractor chooses to construct curb as an integral part of the pavement, the Engineer will measure the curb separately. The Department will not consider payment for extras or increases in pay quantities due to the Contractor's choice to cast curbing integral with the pavement.

D. **Shoulder Gutter, Concrete.** The unit price for **Shoulder Gutter, Conc Det** includes the cost of providing and placing a geotextile liner. The plans will show the pay limits for **Shoulder Gutter, Conc Det**.

E. **Driveway Opening, Conc, Det M.** The Engineer will measure **Driveway Opening, Conc, Det M** from springline to springline.

F. **Spillway, Concrete.** The unit price for **Spillway, Conc** includes the cost of providing and placing a geotextile liner.

G. **Divider, Concrete.** The unit prices for concrete divider include the cost of steel reinforcement, if required.

H. **Backfilling.** Unless the contract includes separate pay items for backfill, the cost of backfilling is included in the unit price for related items of work.



## Section 803. CONCRETE SIDEWALK, SIDEWALK RAMPS, AND STEPS

**803.01. Description.** The work consists of constructing concrete sidewalks, sidewalk ramps, and steps.

**803.02. Materials.** Provide materials in accordance with the following:

|                                 |                            |
|---------------------------------|----------------------------|
| Sound Earth.....                | <a href="#"><u>205</u></a> |
| Concrete, Grade P2, P1 .....    | <a href="#"><u>601</u></a> |
| Concrete, Grade S3, S2 .....    | <a href="#"><u>701</u></a> |
| Granular Material Class II..... | <a href="#"><u>902</u></a> |
| Curing Compound .....           | <a href="#"><u>903</u></a> |
| Steel Reinforcement .....       | <a href="#"><u>905</u></a> |
| Pipe Railing .....              | <a href="#"><u>908</u></a> |
| Joint Fillers .....             | <a href="#"><u>914</u></a> |

**A. Steps.** Use Grade P1 or Grade S2 concrete for steps. The Department will allow precast steps if the Engineer determines that precast steps meet requirements for cast-in-place steps.

**B. Detectable Warning Surfaces.** Provide detectable warning surfaces, selected from the Qualified Products List, that contrast visually with adjacent walking surfaces, either light-on-dark or dark-on-light. Only use pre-fabricated detectable warning products, placed or grouted in newly cast concrete sidewalk ramps. The Engineer may allow the use of surface applied pre-fabricated products as retrofits on existing concrete only. Ensure surface applied products include mechanical anchors.

### **803.03. Construction.**

**A. Preparation of Base.** Excavate to the required depth and to a width that will allow forming. Remove unsuitable material below the required depth and replace with sound earth. Shape and compact the base to conform to the section shown on the plans.

**B. Forms.** Use either fixed forms or slip forms. Provide straight, full depth, un-warped forms that will resist springing during concrete placement. Firmly stake fixed forms.

**C. Placing and Finishing Concrete.** Moisten the base before placing concrete. Do not place concrete on a frozen base, or base that is unstable from excessive moisture. Place the concrete and consolidate before finishing, ensuring the area along the surfaces of the forms is also consolidated. Place and finish in a continuous operation.

If replacing gutters in addition to sidewalk ramps, transition the gutter cross section in advance of the sidewalk ramp to meet the dimension

and profile in Standard Plan R-28 Series. Use the same reinforcement pattern present in the existing gutter.

Place the railing sockets for concrete steps in the plastic concrete or drill into the hardened concrete.

Float the surface, but do not over-float, to produce a smooth surface, free from irregularities. Round the edges and joints with an Engineer-approved finishing tool.

Texture the surface of sidewalks, sidewalk ramps, driveways and steps, with a coarse broom transverse to the direction of travel.

**D. Sidewalk Joints.** Construct transverse and longitudinal expansion and plane-of-weakness joints at intervals and locations shown on the plans. Align transverse joints with like joints in adjacent slabs. Construct joints with faces perpendicular to the surface of the sidewalk and no greater than  $\frac{1}{4}$  inch from the position shown on the plans. Construct transverse joints at right angles to the centerline of the sidewalk and longitudinal joints parallel to the centerline.

Spade or vibrate and compact the concrete to fill voids at the faces of the joints. Ensure a smooth finished surface, to the required grade.

Place expansion joint filler the full depth of the joint, but slightly below the finished surface of the sidewalk.

Cut the plane-of-weakness joints into the concrete after floating. Cut plane-of-weakness joints to at least  $\frac{1}{4}$  the thickness of the sidewalk and from  $\frac{1}{8}$  inch to  $\frac{1}{4}$  inch wide. Finish the cut joint smooth, to the line required by the contract documents.

Do not seal the joints.

**E. Curing and Protection.** Cure and protect the concrete in accordance with subsection [602.03.M](#) and subsection [602.03.T](#). Allow pedestrian traffic after 48 hours.

**F. Railing for Steps.** Place the railing in the sockets and fill the space between the pipe and the socket with a non-shrink mortar or grout selected from the Qualified Products List.

**G. Backfilling.** After the concrete gains required strength, remove fixed forms and backfill with sound earth. Compact and level the backfill 1 inch below the concrete surface.

**H. Detectable Warning Surfaces.** Install detectable warning surfaces in accordance with the manufacturer's instructions and Standard Plan R-28 Series.

**803.04. Measurement and Payment.**

| <b>Pay Item</b>                    | <b>Pay Unit</b> |
|------------------------------------|-----------------|
| Sidewalk, Conc, __ inch .....      | Square Foot     |
| Sidewalk Ramp, Conc, __ inch ..... | Square Foot     |
| Detectable Warning Surface.....    | Foot            |
| Steps, Conc.....                   | Cubic Yard      |
| Railing for Steps .....            | Foot            |

A. **Concrete Acceptance.** Conduct concrete quality control as specified in section [604](#). The Engineer will conduct quality assurance as specified in section [605](#). The Department will pay for this work based on the quality assurance results.

B. **Sidewalk, Concrete.** The Engineer will measure **Sidewalk, Conc**, of the required thickness, in place.

C. **Sidewalk Ramp.** The Engineer will measure **Sidewalk Ramp, Conc, \_\_ inch** by the area of ramp and landing in place. Ramped sidewalk includes sidewalk sloped greater than the normal continuous sidewalk grades to meet the elevation of the curb opening or intermediate landing.

The unit price for **Sidewalk Ramp, Conc, \_\_ inch** includes the cost of landings, monolithic rolled curbs or side flares along the longitudinal edges of the ramp or landing, and curb and gutter openings.

The Engineer will not measure landing areas for payment if a landing, meeting the requirements of Standard Plan R-28 Series, is constructed with a proposed sidewalk or is retained with an existing sidewalk at the end of the ramp.

The Department will pay separately for replacing sidewalks, curbs, or curb and gutter outside of the area measured for **Sidewalk Ramp, Conc, \_\_ inch**.

The Department will pay for rolled curb adjacent to the non-traffic edge of parallel or combination ramps separately, only if the required height exceeds 18 inches along a continuous run.

D. **Detectable Warning Surface.** The Engineer will measure **Detectable Warning Surface** in place by length along the center of the 24 inches wide detectable warning material at required locations. If the Contractor elects to remove the existing concrete sidewalk or sidewalk ramp in conjunction with retrofitting a detectable warning device, the unit price for **Detectable Warning Surface** will include the cost of removing sidewalk, sidewalk ramp, and restoration.

E. **Steps, Concrete.** The Engineer will measure and the Department will pay for **Steps, Conc** based on plan quantities in accordance with subsection [109.01.A](#). The unit price for **Steps, Conc** includes the cost of foundation preparation, constructing forms, providing and placing steel reinforcement, providing, placing, finishing, and curing concrete, providing and placing backfill, and cleanup.

The Engineer will measure **Railing for Steps** in place by length of top rail, for each railing required. The unit price for **Steps, Conc** includes the cost of providing, fabricating, galvanizing, installing, and grouting the railing.

F. **Backfill.** Unless the contract documents include separate pay items for backfill, the unit price for other items of work will include the cost of backfilling.

## **Section 804. CONCRETE BARRIERS, GLARE SCREENS, AND FOUNDATIONS FOR LIGHT STANDARDS AND SIGN SUPPORTS**

**804.01. Description.** This work consists of constructing concrete barriers, glare screens, and foundations for light standards and sign supports.

**804.02. Materials.** Provide material in accordance with the following:

|  |                     |
|--|---------------------|
| Concrete, Grade P2.....                    | <a href="#">601</a> |
| Concrete, Grade S3.....                    | <a href="#">701</a> |
| Mortar and Grout, Type R-2, Type H-1 ..... | <a href="#">702</a> |
| Granular Material, Class II.....           | <a href="#">902</a> |
| Curing Compound .....                      | <a href="#">903</a> |
| Dowels and Bar Reinforcement.....          | <a href="#">905</a> |
| Anchor Bolts and Nuts.....                 | <a href="#">908</a> |
| Joint Materials .....                      | <a href="#">914</a> |
| Electrical Conduit.....                    | <a href="#">918</a> |
| Barrier Reflector Markers .....            | <a href="#">922</a> |

### **804.03. Construction.**

A. **Preparation of Base.** Prepare the base for concrete barrier in accordance with subsection [602.03.B](#).

#### **B. Forming.**

1. **Concrete Barrier and Glare Screen.** Use either fixed form or slip form methods, in accordance with Standard Plan R-49 Series, R-54 Series, and R-76 Series. Ensure a smooth surface with uniform appearance, located as required by the contract documents.

Form the top and faces of barrier and glare screen within a tolerance of ½ inch over 10 feet, based on the Engineer's use of a 10-foot straightedge, except at grade changes and curves. Ensure barrier or glare screen is free of high or low areas and other irregularities. Repair minor defects while the concrete is plastic, using mortar obtained by screening out the coarse aggregate from the barrier, or glare screen concrete.

2. **Light Standard Foundations and Sign Support Foundations.** Cast in place light standard and sign support foundations using fixed forms, in accordance with Standard Plan R-50 Series and Standard Plan R-51 Series. The Engineer may approve casting the footings without using forms where soil conditions allow.

### C. Reinforcing, Anchor Bolts and Dowels.

1. **Reinforcement.** Place steel reinforcement in accordance with subsection [706.03.E](#).
2. **Dowels.** Install anchor dowels as required where casting barrier separately from the base. Either set the dowels in the base while the concrete is plastic, or drill holes into the hardened concrete base and grout the dowels in place. Use non-shrinking grout selected from the Qualified Products List.

If glare screen is cast separately from the barrier, drill holes for dowels into the hardened concrete and grout the dowels in place. Use non-shrinking grout selected from the Qualified Products List.

Clean holes with oil-free compressed air before grouting dowels in place. If using hydraulic grout, wet the interior surfaces of holes just before grouting.

3. **Anchor Bolts.** Position the anchor bolts for light standards and sign supports, as required, and secure with a template. Correct improper positioning of anchor bolts as directed by the Engineer before placing the concrete. Leave the template in place for at least 24 hours after placing concrete.

D. **Finishing.** Finish barrier surfaces exposed to traffic with a smooth, uniform finish, created by a metal finishing tool, soft-bristled broom, or tools providing similar results. Correct minor blemishes and irregularities on the barrier surface with a fine textured broom.

Do not add water to the concrete surface to aid finishing. Minimize brooming to avoid gouging concrete surface or exposing aggregate.

E. **Stenciling.** Stencil survey station numbers into the traffic sides of the barrier in accordance with subsection [602.03.L](#).

F. **Curing.** Spray two coats of white membrane curing compound on concrete barrier and glare screen. Ensure a continuous uniform film of material. Obtain the Engineer's approval for the spray equipment before beginning work.

Apply each coat at a rate of at least 1 gallon per 300 square feet of surface. Apply the first coat immediately after the removal of the forms, or immediately after the free water has left the surface of the concrete for slip-form construction. Apply the second coat between 30 minutes and 2 hours after the application of the first coat.

Protect the treated surface with an unbroken film for at least 5 days. If the film is damaged during curing, including rain damage, apply a new

coat of material to the affected areas equal in curing value to the original coat.

**G. Joints.** Construct transverse joints as shown on the plans. If constructing the barrier on a concrete base or shoulder not separated by a sealed expansion joint, construct expansion joints and plane-of-weakness joints in the barrier directly over the corresponding joints in the concrete base or shoulder.

**H. Concrete Barrier Backfill.** In split barrier sections, backfill with Class II granular material, between the barrier sections and below the concrete filler slab. The Engineer may approve alternate backfill material.

Place the backfill material in layers no greater than 9 inches deep and compact. Do not backfill cast-in-place concrete barrier until the concrete attains 70 percent of the design strength.

**I. Weather and Temperature Limitations.** Protect the concrete in accordance with subsection [602.03.T](#).

**J. Permanent Barrier Reflector Marker.** Install barrier reflector markers on single face, double face, and split concrete barrier in accordance with Standard Plan R-49 Series, Standard Plan R-54 Series, and subsection [711.03.F](#).

#### **804.04. Measurement and Payment.**

| <b>Pay Item</b>                                     | <b>Pay Unit</b> |
|---|-----------------|
| Conc Barrier, Single Face, Type __ .....            | Foot            |
| Conc Barrier, Double Face, Type __ .....            | Foot            |
| Conc Barrier, Split, Type __ .....                  | Foot            |
| Conc Barrier Backfill, CIP .....                    | Cubic Yard      |
| Glare Screen, Conc .....                            | Foot            |
| Glare Screen, Conc, Split .....                     | Foot            |
| Light Std Fdn, Conc Barrier .....                   | Each            |
| Sign Support Fdn, Conc Barrier, Truss Type __ ..... | Each            |

**A. Concrete Acceptance.** Conduct concrete quality control as specified in section [604](#). The Engineer will conduct quality assurance as specified in section [605](#). The Department will pay for this work based on the quality assurance results.

**B. Concrete Barrier and Glare Screen.** The Engineer will measure concrete barrier and glare screen parallel to the centerline, including transition sections to vertical-faced barrier. The Engineer will measure **Conc Barrier, Split** and **Glare Screen, Conc, Split** in place, including tapered sections at each end of the structure, in accordance with

Standard Plan R-49 Series and Standard Plan R-76 Series. The Engineer will not deduct gaps for light standard foundations, sign support foundations, or pier columns.

The Engineer will measure glare screen end sections as full-height sections.

**C. Concrete Barrier, Double Face, Type A, and Concrete Barrier, Double Face, Type B.** The unit price for **Conc Barrier, Double Face, Type A** includes the cost of constructing **Conc Barrier, Double Face, Type A** using dowels and a widened base, as for **Conc Barrier, Double Face, Type B** as shown on Standard Plan R-49 Series.

The unit price for **Conc Barrier, Double Face, Type B** includes the cost of required dowels.

The unit price for other pay items will include the cost of the base for **Conc Barrier, Double Face, Type B**.

**D. Concrete Barrier Backfill, CIP.** The Engineer will measure **Conc Barrier Backfill, CIP** based on plan quantities in accordance with subsection [109.01.A](#). The unit price for **Conc Barrier Backfill, CIP** includes the cost of backfill placed between split sections.

The Engineer will measure, and the Department will pay for the concrete filler slab between split sections, in accordance with subsection [803.04](#), as **Sidewalk, Conc, 4 inch**. The unit price for **Sidewalk, Conc, 4 inch** includes the cost of placing the fiber joint filler.

The Department will not make deductions in these quantities for gaps for light standard foundations, sign support foundations, or pier columns.

**E. Steel Reinforcement.** The unit prices for **Glare Screen, Conc** and **Glare Screen, Conc, Split** include the cost of steel reinforcement, if required.

**F. Installing Glare Screen.** The unit prices for **Glare Screen, Conc** and **Glare Screen, Conc, Split** include the cost of drilling into the existing barrier and grouting in the steel reinforcement if a concrete glare screen is cast on top of an existing concrete barrier.



**Section 805. HOT MIX ASPHALT CURB**

**805.01. Description.** This work consists of conditioning and treating the surface shown on the plans for placing Hot Mix Asphalt (HMA) curb, and constructing HMA curb.

**805.02. Materials.** Provide materials in accordance with the following:

|                              |                     |
|------------------------------|---------------------|
| HMA Mixture .....            | <a href="#">501</a> |
| Bond Coat SS-1h, CSS-1h..... | <a href="#">904</a> |
| Asphalt Cement .....         | <a href="#">904</a> |

Construct the HMA curb with the same HMA mixture required to construct the leveling and top courses of pavement.

**805.03. Construction.** Construct HMA curb in accordance with subsection [501.03](#), and as modified by this subsection, or as shown on the plans.

**A. Equipment.** Provide equipment in accordance with subsection [501.03.A](#) and this subsection.

Provide a self-propelled, HMA vertical curbing machine capable of placing vertical curved and straight line curb. Equip the machine with templates for the required cross sections.

**B. Bond Coat.** Apply bond coat to adjacent surfaces prior to the placement of HMA curb.

**C. Placing HMA Vertical Curb.** The Engineer will not require rolling. Compact the mixture in the template form to the density required with the curbing machine. Provide a tight surface texture. Remove and replace curb that shows segregation, slumping, or misalignment, at no additional cost to the Department.

**D. Placing HMA Sloped Curb.** Use the leveling course mixture for the first stage of sloped curb construction and the top course mixture for the second stage.

The Contractor may place and compact HMA sloped curb using mainline paving equipment.

**E. Backfilling.** Delay backfilling, if required, until the mixture cures for 24 hours, except the Engineer may approve earlier backfill placement. Place and compact the backfill material, without disturbing the curb.

**805.04. Measurement and Payment.**

| <b>Pay Item</b>       | <b>Pay Unit</b> |
|-----------------------|-----------------|
| Curb Sloped, HMA..... | Foot            |

Curb Vertical, HMA.....Foot

The Engineer will measure **Curb Sloped, HMA** in place along the base of the curb face or along the flow line of the gutter, with no deductions for catch basins or inlet castings. The unit price for **Curb Sloped, HMA** includes the cost of providing and applying bond coat. The unit price for relevant surfacing quantities includes the cost of HMA mixture quantities.

The Engineer will measure **Curb Vertical, HMA** in place along the base of the curb face or along the flow line of the gutter, with no deductions for catch basins or inlet castings. The unit price for **Curb Vertical, HMA** includes the cost of providing and placing HMA mixture quantities and applying bond coat.

## Section 806. SHARED USE PATHS

**806.01. Description.** This work consists of preparing grade and constructing a concrete or Hot Mix Asphalt (HMA) shared use path.

**806.02. Materials.** Provide material in accordance with the following:

|                                      |                     |
|--------------------------------------|---------------------|
| HMA Mixture .....                    | <a href="#">501</a> |
| Concrete, Grade P2.....              | <a href="#">601</a> |
| Concrete, Grade S3.....              | <a href="#">701</a> |
| Coarse Aggregate 21AA, 21A, 22A..... | <a href="#">902</a> |
| Granular Material.....               | <a href="#">902</a> |
| Concrete Curing Material.....        | <a href="#">903</a> |
| Joint Filler .....                   | <a href="#">914</a> |

**806.03. Construction.** Construct the shared use path as shown on the plans, or directed by the Engineer.

**A. Equipment.** Provide equipment in accordance with subsection [501.03.A](#) and subsection [602.03.A](#), except as modified by the following:

1. **Hauling Equipment.** Avoid damaging the grade by limiting the size and weight of hauling units. Repair damage caused by use of oversized equipment at no additional cost to the Department.
2. **Pavers.** Use self-propelled pavers capable of extending in 1-foot increments and paving at least 8 feet wide.

The Engineer will not require an automated paver. The Contractor may use a spreader to place HMA shared use paths adjacent to paved shoulders or curb if the spreader can place shared use path pavement meeting the required tolerances.

Construct concrete shared use paths using slip form paving equipment or fixed forms with a Department-approved screed that can place shared use path pavement that meets surface tolerances. If using fixed forms, use straight, full depth forms, free of warp and capable of resisting deformation during concrete placement.

3. **Rollers.** Use tandem, steel-wheeled rollers weighing less than 3 tons. The Engineer may allow alternate rollers.

**B. Preparation of Base.** If the existing earth grade meets the requirements of the contract, compact, smooth, and trim as directed by the Engineer.

If vegetative cover and root mat is present, remove to at least 2 inches deep and dispose of the material off the right-of-way in accordance with

subsection [201.03.A.4](#). Compact, smooth, and trim the subgrade as directed by the Engineer.

Maintain the moisture content of the subgrade to provide stable support for the paver and hauling units. Aerate, water, and compact to provide support, as approved by the Engineer.

Use granular material for additional embankment. The Engineer will direct the use of aggregate to treat unstable subgrade areas.

**C. Placing and Compacting HMA Mixtures.** Place HMA mixtures in layers no greater than 3 inches deep.

Place HMA mixtures to produce a smooth, dense surface, free of irregularities. Ensure the surface is within  $\pm\frac{1}{4}$  inch of the required grade, when checked with a 10-foot straightedge, excluding vertical curves.

**D. Placing and Finishing Concrete.** Stake fixed forms. Place concrete pavement mixtures to produce a smooth, dense surface, free of irregularities. Ensure the surface is within  $\pm\frac{1}{4}$  inch of the required grade after final screeding, when checked with a 10-foot straightedge, excluding vertical curves.

Maintain a moist base, without causing the base to become muddy or soft, when placing concrete. Do not place concrete on frozen layers, or if the grade is unstable from excessive moisture. Place the concrete to the required depth and spade along the forms before finishing.

Round the edges with an approved finishing tool and broom the surface.

At driveways with curb and gutter on the drive approach, provide a curb drop to allow an opening for the shared use path. Construct the curb drop in accordance with Standard Plan R-28 Series for Sidewalk Ramp and Detectable Warning Details.

**E. Joints for Concrete.**

- 1. Transverse Plane-of-Weakness Joints.** Space transverse plane-of-weakness joints at 12-foot intervals. Saw the joint  $\frac{1}{8}$  inch wide and 1 inch deep, or form the joint with a grooving tool. Use a 6-inch wide grooving tool with a  $\frac{1}{8}$  inch radius. Saw when the concrete hardens to prevent raveling or spalling, but before random cracks develop. Do not seal the joints.
- 2. Transverse Expansion Joints.** Space full depth transverse expansion joints at 200-foot intervals. Install a  $\frac{1}{2}$ -inch thick pre-molded joint filler  $\frac{1}{4}$  inch below the surface of the concrete. The Engineer will not require joint sealing.

F. **Finish Grading.** Blade or place embankment material against the exposed edge of the shared use path. Leave the path surface free draining. Restore the disturbed area by adding topsoil, roadside seeding and mulch, or sodding in accordance with section [816](#).

#### 806.04. Measurement and Payment.

| <b>Pay Item</b>                      | <b>Pay Unit</b> |
|--------------------------------------|-----------------|
| Shared use Path, Grading .....       | Foot            |
| Shared use Path, Aggregate .....     | Ton             |
| Shared use Path, Aggregate, LM ..... | Cubic Yard      |
| Shared use Path, HMA .....           | Ton             |
| Shared use Path, Conc .....          | Square Yard     |

A. **Shared use Path, Grading.** The Engineer will measure **Shared use Path, Grading** in place, along the centerline of the path, and within the limits shown on the plans. The unit price for **Shared use Path, Grading** includes the cost of the following:

1. Excavation;
2. Compacting the grade;
3. Providing and compacting embankment;
4. Grading curb cuts for ramps and driveways;
5. Fine grading of constructed grades or existing ground that requires no further shaping than the removal of the root mat or vegetative cover; and
6. Required brushing and tree trimming and removing and disposing of excess material.

B. **Shared use Path, Aggregate.** The unit price for **Shared use Path, Aggregate** includes the cost of providing and placing the aggregate to treat areas of unstable subgrade, as determined by the Engineer.

C. **Shared use Path, HMA.** The Engineer will measure **Shared use Path, HMA** by the weight of HMA mixture used to build the path. The unit price for **Shared use Path, HMA** includes the cost of providing, placing, and compacting the HMA mixture.

D. **Shared use Path, Concrete.** Conduct concrete quality control as specified in section [604](#). The Engineer will conduct quality assurance as specified in section [605](#). The Department will pay for this work based on the quality assurance results and this subsection.

The Engineer will measure **Shared use Path, Conc** based on plan quantities in accordance with subsection [109.01.A](#). The Department will make deductions for structures, crossroads, sidewalk ramps, and other discontinuities in the shared use path paving.

E. **Slope Restoration.** Unless otherwise provided by separate pay items, the unit prices for **Shared use Path, HMA** and **Shared use Path, Conc** includes the cost of restoring finished slopes and sodded or seeded areas, disturbed by the construction of the shared use path.

F. **Sidewalk Ramps, Curb and Gutter Removal and Placement.** The Department will pay separately for placement and removal of sidewalk ramps, and curb and gutter, and other appurtenances included with these pay items, in accordance with subsection [204.04](#), and subsection [803.04](#).

## Section 807. GUARDRAIL, GUARDRAIL TERMINALS, AND MISCELLANEOUS POSTS

**807.01. Description.** This work consists of constructing, reconstructing and erecting guardrail, guard posts, guide posts, guardrail terminals, guardrail anchorages and mailbox posts, and excavating, backfilling and disposing of surplus materials.

**807.02. Materials.** Provide material in accordance the following:

|   |                     |
|---|---------------------|
| Sound Earth.....                          | <a href="#">205</a> |
| Guardrail Beam Elements and Hardware..... | <a href="#">908</a> |
| Reflectors.....                           | <a href="#">908</a> |
| Steel Posts .....                         | <a href="#">908</a> |
| Wood Posts .....                          | <a href="#">912</a> |
| Guardrail Blocks .....                    | <a href="#">912</a> |

### 807.03. Construction.

**A. Grading and Drainage.** Before constructing guardrail elements, grade the shoulder and berm to provide drainage. For approach guardrail terminals, grade to Class A slope tolerances.

Remove excess material and dispose in accordance with subsection [205.03.P](#). The Engineer may allow this material to be spread thinly over the roadway slopes, provided it does not kill vegetation or block drainage.

**B. Placing Posts.** Either drive posts or set in augered holes. For posts located within 3 feet of existing culverts, use augered holes. The Engineer will allow a  $\pm 3$ -inch tolerance in the depth of augered holes. Compact the bottom of augered holes to provide a stable foundation. Ensure the exposed portion of posts meet plan dimensions. Ensure posts are plumb, and backfill with sound earth compacted in 12-inch layers.

Remove and replace posts damaged during driving that would prevent proper functioning of the guardrail, as determined by the Engineer. Do not damage nearby structures, shoulders, or slopes during driving. Replace damaged posts and repair damage to structures, shoulders, and slopes at no additional cost to the Department.

Use the same material for all posts in a discrete run of guardrail, except where the plans require wood posts. Do not burn or weld posts in the field.

**C. Guardrail Beam Elements, Blocks and Hardware.** Erect beam guardrail to conform to the line and grade shown in the contract.

Bolt the beam elements and blocks to each post. Make splices, only at posts, by lapping in the direction of traffic. Do not burn or weld beam elements in the field. Where placing guardrail on a curve with a radius between 150 feet and 1,000 feet, tighten splice bolts before attaching to the posts.

Shop bend beam elements for curves with a radius of 150 feet or less. Identify each shop-bent curved beam element with a metal tag or permanent marking showing the radius of curvature to the nearest 5 feet as shown on Standard Plan R-60 Series.

Bolt lengths shown on the plans are based on the standard dimensions given for the materials and do not include manufacturer's tolerances. Draw bolts tight and flush with the nuts. If using wood posts, do not leave bolts for Type BD and Type TD guardrail extending more than ½ inch beyond the nuts. Do not leave bolts for other types of guardrail extending more than 1½ inch beyond the nuts.

**D. Repair of Wood Posts and Blocks.** Field treat cuts, holes, and damage to posts and blocks, that occurs after pressure treatment, in accordance with subsection [912.03](#).

**E. Repair of Damaged Galvanized Surface.** Repair zinc coating on beam elements, steel posts, and fittings damaged in transporting, handling, or erection in accordance with subsection [716.03.E](#). Make repairs to galvanized surfaces at no additional cost to the Department.

**F. Guardrail Terminals and Anchorages.** For guardrail terminals, the Engineer will allow field drilling of galvanized beam elements to attach terminal end shoes and anchor plates. Install the reflectorized obstacle marker panel on the nose of each terminal in accordance with the manufacturer's specifications.

For structure anchorages, either sleeve or core drill bolt holes through concrete. Avoid spalling concrete during coring. If spalling occurs, remove the fragments and loosened concrete before installing the bolt.

**G. Incomplete Guardrail Installations.** Within 5 calendar days, complete a continuous section of guardrail, including structure anchorages and guardrail terminals, or bridge thrie beam retrofit guardrail. This time period begins with the start of work on a continuous section of guardrail, and ends with the completion of work on a continuous section of guardrail.

Ensure adequate materials are available on the project before removing sections of guardrail or beginning new installations. Leave existing guardrail in place until preparatory work such as widening, embankment,



and other construction items are complete. To reduce exposure of unprotected areas, coordinate and expedite shoulder construction where guardrail removal and replacement will occur.

If a guardrail section cannot be completely removed or installed by the end of the working day and the exposed beam element ending would face oncoming traffic, temporarily attach a Type 2 approach terminal impact head in accordance with Standard Plan R-62 Series. An impact head must be attached, regardless of the type of beam guardrail. At the end of an incomplete thrie-beam rail section, temporarily install a thrie-beam transition and a 12½-foot length of W-beam rail in accordance with Standard Plan R-60 Series. For both thrie-beam and W-beam rail sections, slip a Type 2 impact head over the end of the last W-beam section and temporarily bolt the rail to the last post using a 5/8 inch by 9½ inch bolt with washers. At the first post down stream from the impact head, do not bolt the guardrail to the post, or block it out. Install and tighten the bolts. The Engineer will not require a cable assembly and strut. Attaching the impact head does not waive the 5-day completion requirement.

If bridge approach guardrail cannot be properly attached to the bridge railing or connected to the bridge thrie-beam retrofit guardrail, fit the free end of the rail with the required special end shoe or thrie-beam terminal connector and temporarily attach to the bridge rail in accordance with the following:

1. Fit the exposed thrie-beam retrofit beam ending that faces oncoming traffic with a thrie-beam terminal connector. Attach the terminal connector to the reinforced concrete railing. Install and tighten splice bolts. Secure the terminal connector to the railing with at least one bolt extending completely through the railing in accordance with Standard Plan R-67 Series.
2. Attach bridge approach guardrail that cannot be properly attached to the bridge railing, to a portion of reinforced concrete railing in accordance with Standard Plan R-67 Series, except that only one bolt will be required to secure the special end shoe or thrie-beam terminal connector to the railing. Install and tighten splice bolts. Extend the rail at least 3½ feet onto the bridge. If the Engineer approves, this temporary attachment may remain beyond the five-day requirement stipulated above.
3. If the area of incomplete or removed guardrail is not behind traffic control devices installed for other work, install a lighted SHOULDER WORK (W21-5) sign and lighted, steady-burn, plastic drums, spaced at maximum intervals of 100 feet to delineate the incomplete portion of the guardrail section during the time it is exposed to traffic. Place

plastic drums near the edge of the shoulder. Other traffic control devices may be required by the contract, or as directed by the Engineer.

**H. Temporary Beam Guardrail and Temporary Guardrail Terminals.**

Construct temporary beam guardrail and temporary guardrail terminals in accordance with subsection [807.03](#) for beam guardrail and guardrail terminals. The Engineer may approve the use of salvaged or new materials for temporary installations; ensure the Engineer approves, before using salvaged materials.

Remove the guardrail and terminals when no longer required. Backfill and compact the post holes in lifts no greater than 12 inches. Take possession of the materials, disassemble, and remove them from the project.

**I. Salvaging Beam Guardrail.** Remove existing single or multiple beam guardrail and posts. Backfill the post holes in layers compacted to no greater than 12 inches. Deliver the beam elements to the locations designated in the contract documents, and stack the beams neatly, according to length. Unless otherwise required by the contract documents, take ownership of posts and hardware.

**J. Mailbox Posts.** Move existing mailbox supports and mailboxes, but maintain serviceability during construction. Install a new post at the permanent location after construction is complete. Attach the existing mailbox to the post and dispose of the existing support at the property owner's option. Set mailbox posts in the ground so the top is 4 feet above the surface of the shoulder of the road or mailbox turnout. The Engineer will determine the exact height. Use posts in accordance with Standard Plan R-74 Series, and saw the top of the post level. The Engineer may approve alternate mailbox support designs that meet the criteria specified in NCHRP Report 350 or the requirements of the *AASHTO Manual for Assessing Safety Hardware* (MASH). Remove, store, and provide to the property owner, newspaper boxes and supports that interfere with construction.

**K. Guard Posts and Guide Posts.** Drive or set guard posts and guide posts in augered holes in accordance with subsection [807.03.B](#).

**807.04. Measurement and Payment.**

| <b>Pay Item</b>                  | <b>Pay Unit</b> |
|----------------------------------|-----------------|
| Guardrail, Curved, Type __ ..... | Foot            |
| Guardrail, Type __ .....         | Foot            |
| Guardrail, Backed, Det __ .....  | Each            |
| Guardrail Post, Culv .....       | Each            |

|   |      |
|---|------|
| Guardrail Approach Terminal, Type __ .....        | Each |
| Guardrail Departing Terminal, Type __ .....       | Each |
| Guardrail Anch, Bridge, Det __ .....              | Each |
| Guardrail Anch, Median .....                      | Each |
| Guardrail Buffered End .....                      | Each |
| Guardrail Reflector .....                         | Each |
| Guardrail, Type __, Temp .....                    | Foot |
| Guardrail Approach Terminal, Type __, Temp .....  | Each |
| Guardrail Departing Terminal, Type __, Temp ..... | Each |
| Guardrail Anch, Bridge, Det __, Temp .....        | Each |
| Guardrail, Salv .....                             | Foot |
| Guardrail, Mult, Salv .....                       | Foot |
| Post, Mailbox .....                               | Each |
| Post, Wood Guard .....                            | Each |
| Post, Wood Guide .....                            | Each |

A. **Blading.** The cost of grading the shoulder and berm to provide drainage and disposing of excess material is included in unit price for related items of work.

B. **Guardrail.** The Engineer will measure **Guardrail, Curved, Guardrail,** and **Guardrail, Temp** along the face of the rail, excluding terminals, end shoes, and W-beam backed guardrail that spans culverts. The unit price for **Guardrail, Curved** includes the cost of portions of guardrail with shop-bent beam elements.

The unit price for **Guardrail** includes the cost of providing and placing guardrail posts, blocks, and miscellaneous hardware.

The unit price for **Guardrail, Backed** includes the cost of providing beam elements, hardware, posts, and spacer blocks necessary to construct the span shown on the plans.

The unit prices for **Guardrail, Temp, Guardrail Approach Terminal, Temp,** and **Guardrail Departing Terminal, Temp** include the cost of removing temporary guardrail and terminals and backfilling postholes.

The Engineer will measure **Guardrail, Salvage** and **Guardrail, Multiple, Salvage** along the face of the rail (one face for multiple beams), including terminals and end shoes.

The cost of providing, installing, and removing temporary guardrail beam elements, impact heads, transition elements and hardware, and traffic control items described for incomplete guardrail installations in subsection [807.03.G.3](#) is included in the unit price for related guardrail pay items.

C. **Guardrail Terminals.** The Engineer will measure guardrail terminals to the limits shown on the plans.

The Engineer will measure, and the Department will pay for **Guardrail Approach Terminal** as individual units. The unit price for **Guardrail Approach Terminal** includes the cost of proprietary and standard elements, and hardware required for installation, including obstacle marker panel, and terminal end shoes.

The unit price for **Guardrail Departing Terminal** includes the cost of terminal end shoes.

D. **Miscellaneous Posts.** The unit price for **Post, Mailbox** includes the cost of the following:

1. Removing and relocating the existing mailbox support during construction activities;
2. Maintaining serviceability;
3. Placing a new post at the permanent location after construction activities are complete;
4. Removing the mailbox from the old support and attaching it firmly to the new post;
5. Disposing of the old support, at the property owner's option; and
6. Removing, storing, and providing the property owner existing newspaper boxes and supports.

The Engineer will measure, and the Department will pay for constructing posts on box or slab culverts in accordance with Standard Plan R-73 Series as **Guardrail Post, Culv.**

## Section 808. FENCING

**808.01. Description.** This work consists of providing and erecting, or moving existing, woven wire fence, temporary fence, protective fence, chain link fence, high-tensile wire fence, or pedestrian fencing of structures.

**808.02. Materials.** Provide materials in accordance with the following:

|  |                     |
|--|---------------------|
| Sound Earth.....                           | <a href="#">205</a> |
| Concrete, Grade P2.....                    | <a href="#">601</a> |
| Fencing Materials .....                    | <a href="#">907</a> |
| Structure Expansion Anchors and Bolts..... | <a href="#">914</a> |

A. **Protective Fencing.** Provide new or used material for temporary and protective fencing. Wood posts for protective fencing do not require preservative treatment.

B. **Fence Fabric.** Provide either zinc-coated steel, or aluminum-coated steel fabric for chain link fence. Only use PVC coated fence fabric if required.

C. **Moving and Salvaging Fence.** The Engineer may approve material salvaged from moved, temporary, or protective fencing for use as permanent fence provided it meets the requirements of section [907](#). Provide additional materials in accordance with section [907](#).

**808.03. Construction.** Erect a taut fence to the line required by the contract. Dispose of surplus excavated material and other debris in accordance with subsection [205.03.P](#). The Engineer will designate and mark trees and other vegetation to be saved. Construct the fence near designated vegetation and in naturally occurring wet areas, by hand, as directed by the Engineer.

A. **Concrete.** Place concrete within 1½ hours of introducing the mixing water. If additional time is necessary to complete concrete placement, use a retarding admixture selected from the Qualified Products List. Follow the manufacturer's recommendation for maximum initial set time. Do not retemper. The Engineer will not allow additional compensation for admixtures.

B. **Woven Wire Fence.** Use wood posts in swamps and areas of unstable soil. If the Engineer approves, substitute wood posts for steel posts in other areas, at no additional cost to the Department.

If necessary to confine livestock, erect the permanent fence before removing the existing fence.

1. **Clearing Fence Line.** Where clearing for fence is required, clear the fence line in accordance with subsection [201.03.C](#).
2. **Setting Posts.** Dig holes for wood posts in accordance with Standard Plan R-101 Series with a tolerance of  $\pm 3$  inches.

Leave at least 4½ feet of the wood post exposed. Set the wood posts plumb on the side designated for fastening the wire. Set with the butt end down. Backfill around the post with sound earth, thoroughly compacted in place.

Use a Department-approved post driver to drive steel line posts. Ensure posts are plumb. Remove and replace bent or damaged posts.

When placing posts, maintain the tops of posts at a uniform height above the ground. After erecting the fence, cut off the tops of wood posts to the required elevation.

Set an intersection post in line with intersecting fences and brace in line with the intersecting fence. Connect both intersecting fences to the intersection post.

3. **Anchoring and Bracing Wood Posts.** Anchor and brace wood posts, except intermediate line posts, in accordance with Standard Plan R-101 Series.

If using cleats to anchor wood posts, use sawed lumber with durability equal to that of the posts. Securely spike timber braces.

Install a double strand, No. 9 galvanized wire, in accordance with Standard Plan R-101 Series. Loop the cable around the end, corner, gate, angle, intersection, or intermediate braced post, and around the adjacent line post. Twist until the top of the adjacent line post is drawn back 2 inches. Secure the cable to maintain tension.

4. **Anchoring and Bracing Steel Posts.** Anchor and brace steel posts, except intermediate line posts not set in concrete, in accordance with Standard Plan R-101 Series.

Brace end and gate posts with one brace in the direction of strain. Brace corner, angle, and intermediate posts in both directions. Brace intersection posts in three directions. Fasten braces near the top of the post. At depressions and alignment angles where stresses are created that may pull the posts from the ground, set the line posts in concrete as shown on the plans.

5. **Installing Fabric and Barbed Wire.** Wrap each horizontal strand of wire around the end, corner, gate or intermediate braced post and wind around the wire leading up to the post.

Stretch the wire fabric taut and fasten it to each post with the bottom of the fabric 2 inches above the ground. Use line posts as stretching anchorage only if they are anchored in accordance with subsection [808.03.B.4](#).

Obtain the Engineer's approval for the method of splicing wires in woven wire fabric and barbed wire. Make the distance between the vertical wire stays, next to the splice, equal to the unspliced sections of woven wire fabric. Splice a woven wire and barbed wire fence only if connecting two rolls of wire. Do not make intermediate splices.

Fasten the fence fabric to each steel post with at least six wire clamps.

Attach the fence to each wood post with at least one staple for each horizontal strand. Use staples made of 9 gauge galvanized steel wire, at least 1½ inch long for soft wood, or at least 1 inch for hard wood posts.

Fasten the barbed wire to each post 3 inches to 4 inches above the fabric.

- C. **Temporary Fence.** Erect temporary fence in accordance with subsection [808.03.A](#) and subsection [808.03.B](#), except as modified by the following:

1. **Setting Posts.** Set line posts at least 2 feet and end posts at least 3 feet into the ground and do not trim the tops. The Engineer may allow the omission of intermediate braced posts.
2. **Installing Fabric.** Attach the fabric to wood posts with at least one staple for every third strand, or to steel posts with at least four wire clamps.
3. **Removing Temporary Fence.** Remove and dispose of the temporary fence, or salvage in accordance with subsection [808.02.C](#).

- D. **Protective Fence.** Place a protective fence around excavations for bridges and pump stations, and other areas of the project for public safety in accordance with subsection [104.07](#) and the plans, or as directed by the Engineer. Erect protective fence in accordance with

subsection [808.03.A](#) and subsection [808.03.B](#), except as modified by the following.

1. **Anchoring and Bracing Posts.** Anchor and brace enough posts to keep the fabric taut.
  2. **Maintaining Fence.** Maintain the protective fence until the Engineer directs its removal or accepts the project.
  3. **Removing Protective Fence.** Remove and dispose of the protective fence.
- E. **Chain Link Fence.** Erect chain link fence on steel posts set in concrete.
1. **Clearing Fence Line.** Clear and clean the fence line in accordance with subsection [808.03.B.1](#).
  2. **Setting Posts.** Set posts in concrete and brace. Install angle posts where the alignment of the fence deflects more than 10 degrees.  
  
Set an intersection post in line with intersecting fences. Connect both intersecting fences to the intersection post.  
  
Fit posts with Department-approved post caps.
  3. **Braces.** Fasten braces to the end, corner, angle, intersection, gate, and intermediate braced posts with required steel fasteners.
  4. **Installing Fabric and Top Tension Wire.** Stretch chain link fence fabric taut and fasten to each post with Department-approved fasteners. Space the fasteners no greater than 12 inches apart on the posts. Fasten the fence fabric to the tension wire, at no greater than 15-inch intervals, using fasteners fabricated from 12-gauge galvanized wire. Close fasteners to the full crimp position around the tension wire and fence fabric.
- F. **High-Tensile Wire Fence.** Construct high-tensile wire fence in accordance with subsection [808.03.A](#) and subsection [808.03.B](#). Erect the wires in accordance with the manufacturer's recommendations.
- G. **Fencing on Structures.** Construct fencing on structures in accordance with subsection [808.03.E](#). Peen, score, or upset the bolt threads of exposed nuts. Construct handrails, as shown on the plans, as part of the fencing, in accordance with section [707](#).
- H. **Moving Fence.** Remove the existing fence without damaging the materials. Set posts and anchors in the same manner and to the same depth and spacing as the original fence. Place the reset fence in at least



as good condition as the existing fence before it was moved. If the fence consists of wire fabric, draw it taut but do not overstress the salvaged materials. Replace damaged or destroyed materials at no additional cost to the Department.

**808.04. Measurement and Payment.**

| <b>Pay Item</b>  | <b>Pay Unit</b> |
|--|-----------------|
| Fence, Temp .....  | Foot            |
| Fence, Protective.....   | Foot            |
| Fence, Woven Wire with Wood Post.....                                    | Foot            |
| Fence, Woven Wire with Steel Post.....                                   | Foot            |
| Barbed Wire.....   | Foot            |
| Fence Gate, __ foot, for Woven Wire.....                                 | Each            |
| Fence, Chain Link, __ inch.....  | Foot            |
| Fence, Chain Link, __ inch, with (number) Strand of<br>Barbed Wire ..... | Foot            |
| Fence Gate, __ foot, for __ inch Chain Link Fence.....                   | Each            |
| Fence, High Tensile Wire .....   | Foot            |
| Fence, Structure .....   | Square Foot     |
| Fence, Moving .....  | Foot            |
| Fence Post .....   | Each            |
| Fence Material.....  | Foot            |

A. **Concrete Acceptance.** Conduct concrete quality control as specified in section [604](#). The Engineer will conduct quality assurance as specified in section [605](#). The Department will pay for this work based on the quality assurance results.

B. **Fence.** The Engineer will measure fence in place, and will not include gate openings in the measurement for **Fence, Temp, Fence, Woven Wire, Fence, Moving, and Fence, Chain Link**. The Engineer will measure gates separately.

The unit price for fence of the type required includes the cost of providing and installing posts, braces, fabric and hardware.

The Department will not make adjustments in price for handwork required to avoid damage to trees and vegetation designated to be saved.

If required, the Engineer will measure, and the Department will pay for barbed wire separately, unless otherwise included in the unit price for **Fence, Chain Link, \_\_ inch, with (number) Strand of Barbed Wire**.

C. **Temporary and Protective Fence.** The Department will not pay separately for protective fence required in accordance with subsection [104.10](#).

If the Engineer directs, or the plans show the use of protective fence, the unit price for **Fence, Protective** includes the cost of providing and placing.

The unit prices for **Fence, Temp** and **Fence, Protective** include the cost of providing, erecting, maintaining, removing, and disposing of fence.

The Engineer will not deduct openings from measurements for **Fence, Protective**. The Engineer will not measure gates separately.

D. **Fence, Structure.** The unit price for **Fence, Structure** includes the cost of providing and installing posts, braces, and fabric, and all supporting, connecting, and auxiliary elements, including handrails if shown on the plans, for the erection of fences on existing or new structures.

E. **Fence, Moving.** The Engineer will measure **Fence, Moving** in place, at its new location. The unit price for **Fence, Moving** includes the cost of moving the fence and installing it in its new location. The unit price also includes replacing posts or fabric damaged or destroyed by the Contractor's removal operation.

The Department will pay for new posts or new fence material, if shown on the plans or required by the Engineer, at the contract unit price for these items. If the contract does not include new post or new fence material pay items, the Department will pay for these as extra work.

## Section 809. FIELD OFFICE

**809.01. Description.** This work consists of providing, equipping, and maintaining field offices for the Engineer for the duration of the contract.

**809.02. Materials.** None specified.

**809.03. Construction.** The Engineer will determine if the office is required and when it is needed on the project. The Engineer may terminate use of the field office during seasonal suspension of work.

Place the field office as directed by the Engineer. Provide access and parking as required by the Engineer. Maintain access and parking, including grading, gravel, and snow removal.

**A. General Requirements for Field Offices.** Provide field offices in accordance with the MIOSHA standards for the performance of required activities and tests.

Provide a Department-approved weatherproof trailer, building, or space within an existing building. Provide and maintain this space for the exclusive use of the Engineer as a field office for activities and field testing until the project is complete.

The Department will provide office furniture, other than that required by the contract documents. Provide a field office that conforms to local building codes requiring handicap access for temporary office use.

Provide the following:

1. Heating and air-conditioning equipment that will maintain a temperature between 70 °F and 80 °F during working hours.
2. At least two wall-mounted electrical power outlets per room that conform to local electric codes for office use.
3. At least two 75-Watt electric lights per room.
4. Water and telephone service.
5. A floor to ceiling height of at least 7 feet.
6. At least 6 feet of rigidly constructed, 30 inch wide counter.
7. At least one sash, hinged or sliding window per room.
8. Locks, bars, window locks, or a security system.
9. First-aid kits, smoke detectors, and fire extinguishers required by local fire and safety authorities. Maintain fire extinguishers and smoke detectors.

Equip the office with a metal-covered board or steel plate, 48 inch by 48 inch. Provide a gas or liquid-fueled stove for heating and drying aggregate, with at least two burners and the required fuel. Provide for

storage and usage of the fuel in accordance with the Michigan State Police, Fire Marshal Division. Provide exhaust vents and hoods.

### B. Specific Requirements for Each Class of Field Office.

1. **Field Office — Class 1.** Provide a building at least 1,000 square feet or trailer at least 14 feet by 70 feet. Provide hook-ups to sanitary sewer and water facilities, electric service, heating and cooling equipment, and telephone service. Provide pressurized water facilities, potable water, and indoor plumbing. Provide at least three separate telephone lines with different phone numbers, for facsimile, computer modem, and telephone. The Department will provide the office phones and system. Partition the floor space to provide three offices, a conference room, and a restroom. Provide a restroom with at least one sink with hot and cold water, and a toilet. Provide and maintain parking for at least 12 vehicles.
2. **Field Office — Class 2.** Provide a building of at least 600 square feet or a trailer at least 12 feet by 50 feet. Provide a prefabricated outdoor sanitary facility, pressurized water for testing, and bottled water for drinking. Provide hook-ups for electric service, heating and cooling equipment, and telephone service. Regularly replenish the bottled water supply, and clean and maintain the sanitary facility. Provide at least one telephone line with a fully operational standard telephone. Partition the floor space to provide at least two offices. Provide and maintain parking for at least eight vehicles.
3. **Field Office — Class 3.** Provide a building of at least 365 square feet or trailer of at least 8 feet by 45 feet. Provide a prefabricated, outdoor sanitary facility, pressurized water for testing, and bottled water for drinking. Provide hook-ups for electric service, heating and cooling equipment, and telephone service. Regularly replenish the bottled water supply, and clean and maintain the sanitary facility. Provide at least one telephone line with a fully operational standard telephone. Partition the floor space to provide at least two offices. Provide and maintain parking for six vehicles.

### 809.04. Measurement and Payment.

| <b>Pay Item</b>                 | <b>Pay Unit</b> |
|---------------------------------|-----------------|
| Field Office, CI _____          | Month           |
| Field Office, Utility Fees..... | Dollar          |

A. **Field Office, CI.** The unit price for **Field Office, CI** \_\_\_ includes the cost of setup, providing access, grading, maintaining, plowing snow, utility hook-up charges, and monthly water and sanitary service fees. The Engineer will measure **Field Office, CI** \_\_\_ in full months for the time

required. The Department will pay for this item on a monthly basis, with the first pay estimate following the first full month of occupancy. Any use of the field office, by the Department, during the month will constitute a full month. The Contractor is responsible for paying taxes, and providing required permits and insurance for field-office-occupancy by Department personnel.

If the Department provides other facilities for use as a field office, the Department will not pay for **Field Office, CI** \_\_\_\_.

If the contract does not include a pay item for **Field Office, CI** \_\_\_\_, and the Department requires the Contractor to provide a field office, the Department will consider it extra work in accordance with subsection [103.02.E](#).

**B. Field Office, Utility Fees.** The Department will establish a budget for **Field Office, Utility Fees** in advance of the project. The unit price for **Field Office, Utility Fees** includes the cost of monthly usage fees for electricity, gas, telephone service and charges, and fuel for the stove. The Contractor will pay all utility hook-up charges and monthly water and sanitary service fees. The Department will reimburse the Contractor for monthly usage fees for electricity, gas, and telephone charges incurred by the Department. The Department will reimburse the Contractor monthly, for field office utility fees, at invoice costs, with the first pay estimate after receipt of paid invoices from the Contractor. The Department will not allow mark ups.

If the Engineer terminates use of the field office during seasonal suspension of work, the Department will continue to reimburse the Contractor for **Field Office, Utility Fees** during the suspension.

## Section 810. PERMANENT TRAFFIC SIGNS AND SUPPORTS

**810.01. Description.** This work consists of providing, fabricating, and erecting traffic signs and supports in accordance with the [Michigan Manual on Uniform Traffic Control Devices \(MMUTCD\)](#), the [Michigan Standard Highway Signs Manual](#), and the [Department Sign Support Standards](#).

### A. Terminology.

**Defect.** Physical imperfections affecting function, performance, or durability of a sign or support. Defects include dents, scratches, nicks, blemishes, mottles, dark spots, scuffs, streaks, warpage, sheeting lift, and bolt head dimples.

**Patch.** A small piece of reflective sheeting material used to cover a defect or imperfection on a sign surface.

**Post Spacing.** Center-to-center distance between posts.

**Substrate.** Material to which sheeting is applied (wood or aluminum).

**Warp.** Deformation caused by bending or twisting in posts or substrate.

**Wedge.** Tapered hardwood used to secure wood posts in sleeves.

**810.02. Materials.** Provide materials in accordance with the following:

|   |                     |
|---|---------------------|
| Concrete, Grade P2, P1 .....              | <a href="#">601</a> |
| Concrete, Grade S2.....                   | <a href="#">701</a> |
| Curing Compounds.....                     | <a href="#">903</a> |
| Steel Reinforcement.....                  | <a href="#">905</a> |
| Structural Steel .....                    | <a href="#">906</a> |
| Anchor Bolts and Nuts.....                | <a href="#">908</a> |
| Electrical Conduit.....                   | <a href="#">918</a> |
| Permanent Traffic Signs .....             | <a href="#">919</a> |
| Sign Supports and Mounting Hardware ..... | <a href="#">919</a> |

Provide Grade P1 or Grade S2 concrete for cantilever and truss sign support foundations. Provide Grade P2 concrete for other sign support foundations.

Ensure production of structural steel required for cantilevers, trusses, mast signal arm poles or dynamic message sign support structures, by structural steel plants certified by the American Institute of Steel Construction for the Category Bridge and Highway Metal Components.

**810.03. Construction.** Before beginning excavation or post driving operations, determine the location of underground utilities as specified in section [107](#).

Place signs at the bottom height shown on the Sign Support Standards or as required.

Repair zinc coating on sign supports, damaged during transportation, handling, or erection, in accordance with subsection [716.03.E](#), and at no additional cost to the Department.

#### A. Dimensional Information.

1. **Trusses and Cantilevers.** Fabricate steel cantilevers and steel trusses in accordance with the Sign Support Standards and as required.
2. **Steel Column Breakaways and Bridge Sign Connections.** Confirm the correctness of breakaway heights, bridge sign connection strut lengths, and other dimensions for fabrication in the field. Ensure the Engineer approves the confirmed dimensions before starting fabrication.
3. **Signs.** Fabricate signs in accordance with the Michigan Standard Highway Signs book and as required.

#### B. Delineators.

1. **Installing Steel Posts.** Drive steel posts plumb into the ground. Do not bend the post or damage the top.
2. **Installing Flexible Delineator Posts.** Install flexible delineator posts with the required anchoring accessories, in accordance with the post manufacturer's directions. Do not bend or damage the posts.

Install the flexible post plumb with its reflective sheeting perpendicular or radial to oncoming traffic. Replace posts or sheeting damaged during installation at no additional cost to the Department.

3. **Reflectors.** Mount reflectors as shown on the Standard Plan R-127 Series. For steel post delineators, use fasteners to hold reflectors firmly to the post, attached with a hand or pneumatic blind rivet gun capable of applying the solid pin. After swaging the collar material into the annular grooves of the pin, form a vandal resistant, locked fastener. Apply the reflective sheeting for the flexible delineator in accordance with the manufacturer's specifications.

**C. Steel Post Sign Supports and Square Tubular Steel Sign Supports.** Drive or embed posts to ensure sign faces and supports are within  $\frac{3}{16}$  inch of plumb over 3 feet. Place posts within 2 percent of the plan distance, as measured from center-to-center of posts.

Do not damage the top of posts during driving. Install steel sign supports and square tubular steel sign supports in accordance with the Sign Support Standards.

**D. Wood Post Sign Supports.** Erect wood sign support posts to ensure sign faces and supports are within  $\frac{3}{16}$  inch of plumb over 3 feet. Place the posts within 3 percent of the plan distance, as measured from center-to-center of posts.

For wood post sign supports that do not require pre-drilled holes, place the end with the most severe strength defects on the top. The Engineer will not require forms for concrete, provided the Contractor prevents earth from falling into the limits of the excavation.

The Contractor may use tubular shells in soils where augered holes will not stay open.

**E. Installing Steel Posts Through Concrete.** If installing steel sign posts, including square tubular steel sign supports or steel delineator posts through existing concrete, drill or sawcut a separate hole through the concrete for each post. Drill or cut post holes no greater than 1 inch larger than the largest cross-sectional dimension of the post. After drilling or sawing, remove the concrete debris from the hole. Clean and dry the area around the hole. Insert the galvanized steel post into the hole and embed to a depth of  $3\frac{1}{2}$  feet below the top of concrete grade. Fill the hole around the post with a silicone sealer.

If installing posts in new concrete, the Contractor may form holes before placing the new concrete.

**F. Installing Wood Posts Through Concrete.** If installing wood sign posts through existing concrete, drill or sawcut a separate hole through the concrete for each post. Drill or cut postholes to a diameter of at least 18 inches. After drilling or sawing, remove the concrete debris from the hole. Clean and dry the area around the hole. Center the galvanized steel sleeve and wood post in the hole.

If installing wood posts in new concrete, the Contractor may form holes before placing the new concrete.

**G. Sign Band.** Provide and install bands to fasten a single sign or route marker cluster bracket to the supports in accordance with the Sign Support Standard SIGN 740, or as directed by the Engineer.



**H. Concrete Glare Screen and Concrete Median Barrier Connections.** Provide and install sign supports on concrete glare screen or concrete median barrier in accordance with the Sign Support Standards. Place supports so the sign face and post are within  $\frac{3}{16}$  inch of plumb over 3 feet.

**I. Foundations for Steel Column Breakaway Sign Supports.** Auger the holes for supports. The Engineer will not require concrete forms, provided the Contractor prevents earth from falling into the limits of excavation.

The Contractor may use tubular shells in soils where augured holes will not stay open.

Place the concrete in accordance with subsection [706.03.H](#). Hold the stub column in position with a template for at least 24 hours after placing the concrete. Construct the foundation with the top elevation as shown on the Sign Support Standards or as required.

**J. Foundations for Cantilever Sign Supports and Truss Sign Supports.** If opening the project or section to traffic before or during construction of cantilever sign support and truss sign support foundations, provide temporary traffic control devices in accordance with section [812](#). Maintain the temporary traffic control devices at each foundation until completion of the foundation, backfill, and, if required, guardrail installation. Construct the foundation to the top elevation shown on the Sign Support Standards or as required.

1. **Excavation.** Excavate in accordance with subsection [206.03.A](#).

2. **Forms.** Construct forms in accordance with subsection [706.03.D](#).

The Contractor may omit forms for footings or foundation portions more than 6 inches below the finished earth grade, if the earth outside the neat lines of the foundation shown on the plans does not intrude into the excavation.

3. **Hand Chipping.** Remove unsound or loose concrete with air hammers or other Engineer-approved methods. Salvage existing steel reinforcement in the wall or barrier. Saw-cut the area, designated for removal to at least  $\frac{1}{2}$  inch deep, along a line determined by the Engineer.

Remove the concrete around truss anchor bolts to an area at least 3 inches beyond the perimeter of the bolt pattern and 3 inches below the embedded depth of the bolts, as shown on Sign Support Standard SIGN-610. Remove the concrete from exposed reinforcing steel to provide a clearance of at least  $\frac{3}{4}$  inch behind the steel.

Remove loose material, and blast clean the exposed surfaces and existing steel reinforcements. Blow out the area with oil-free compressed air.

4. **Existing Steel Reinforcement.** Treat exposed steel reinforcement in accordance with subsection [712.03.I](#).
5. **Placing Steel Reinforcement.** Place steel reinforcement in accordance with subsection [706.03.E](#).
6. **Setting Anchor Bolts and Placing Concrete.** Position anchor bolts in accordance with subsection [810.03.N.1](#). Place concrete, strike off the seat, and finish smooth and horizontal. Do not erect the cantilever or truss sign support until the concrete attains 70 percent of the minimum 28-day compressive strength, or until test beams attain a flexural strength of 500 psi.
7. **Surface Finish.** Finish exposed surfaces in accordance with section [706](#).
8. **Curing.** Use a white membrane curing compound, except during cold weather. In cold weather, protect the concrete in accordance with subsection [706.03.N](#).
9. **Backfilling.** Ensure the Engineer approves the backfill material and compaction method before placing backfill. Backfill in accordance with subsection [206.03.B](#). Place and compact backfill around the foundation in layers no greater than 9 inches thick
- K. **Drilled Piles for Cantilever Foundations.** Construct drilled piles for cantilever foundations in accordance with section [705](#).
- L. **Cantilever Sign Supports.** Transport and handle cantilever sign supports without damaging the members. Erect the sign supports in accordance with the following sequence.
  1. Place bottom leveling nuts and washers on the anchor bolts, ½ inch above the concrete foundation. Bring the nuts level with the highest nut above the foundation. Ensure the clearance from the concrete foundation to the bottom leveling nuts does not exceed 1 inch.
  2. Place the upright, without attaching the arms, on the leveled bottom nuts and washers.
  3. Apply beeswax, or an equivalent, to the top nut bearing faces and threads. Place the top nuts and their corresponding washers onto the two anchor bolts that lie perpendicular to, and onto the two anchor bolts that lie parallel to, the sign face in its final position. Loosely snug tighten.

4. Adjust the nuts perpendicular and parallel to the sign face, in its final position, to level the column base plate.
5. Place remaining top nuts and washers on the anchor bolts and loosely snug tighten.
6. Tighten bottom nuts and top nuts in accordance with subsection [810.03.N.2.](#)
7. Place the arms, without the sign, on the erected column. Tighten bolts in accordance with the turn-of-the-nut method specified in subsection [707.03.D.7.c.](#) Discard nuts and bolts loosened or removed after full tightening. The Engineer will not require replacement of tightened bolts, loosened by tightening adjacent bolts.
8. Place the sign panel on the erected arms. Field drill holes in the aluminum mounting supports that receive the sign panel mounting U-bolts to ensure the final position of the sign panel is level.
9. Check the anchor bolt nuts connecting the column base to the concrete foundation in accordance with subsection [810.03.N.2.e.](#) Ensure the Engineer approves field welding.

**M. Truss Sign Supports.** During transportation of truss sign supports, place two 4 inches by 4 inches wood timbers against each other on the truck bed at each end of the truss section no greater than 2 inches from the truss box flanges.

Tie each end of the truss box to the truck bed using nylon slings. Tie the top and bottom of the truss box, or both cords, to the truck bed. Do not tie the truss box to another object.

Secure the truss and deliver it to the project. Unless otherwise directed by the Engineer, construct the truss box at the location shown on the plans.

At the project, store the truss sign support on a level surface, away from traffic. Provide 4 inches by 4 inches wood timbers at each end and the mid-span of each truss sign support section.

Do not lift the truss box by chains or internal truss members. Use nylon slings that wrap the entire cross section and provide at least a two-point pickup, for handling the truss, truss sections, and end supports.

Before tightening the flange bolts, bring bearing surfaces into full contact in the relaxed position.

Plumb the end supports using anchor bolt leveling nuts.

Ensure the Engineer approves field welding.

During erection, load the truss to prevent vibration. If the roadway is open to traffic, load the truss by installing the permanent signs or blank sign panels.

If the roadway is closed to traffic, the Contractor may load the truss with sandbags. Fasten temporary loads and leave in place until installation of permanent signs.

**N. Anchor Bolts for Cantilever and Truss Sign Supports, Light Standards, Dynamic Message Sign Structures and CCTV Poles, Tower Lighting Units and Mast Signal Arm Poles.**

1. **Anchor Bolt Installation.** Place and hold anchor bolts plumb and aligned using a steel template. Secure the template before placing the concrete base and leave in place at least 24 hours after concrete placement. Leave the support cage in the concrete foundation.

The Engineer will reject a base if the anchor bolts are out of position, or greater than 1:40 out-of-plumb. Do not bend anchor bolts to straighten, or move into position, or alter the base.

2. **Anchor Bolt Tightening.** Bring bottom leveling nuts to full bearing on the bottom of the base plate. Keep the bottom of the leveling nuts as close to the concrete base as possible, and no greater than 1 inch above the top of the concrete base.

Thread leveling nuts onto anchor bolts so the bolt extends at least  $\frac{1}{4}$  inch above the top nut in the tightened position.

Apply beeswax, or an equivalent, to the top nut bearing face and threads before placing on the anchor bolt. Tighten top nuts to a snug condition, defined as follows:

**Snug Condition.** The tightness attained by the full effort of a person using a wrench with a length 14 times the diameter of the anchor bolt, but at least 18 inches. Apply the full effort as close to the end of the wrench as possible. Pull firmly by leaning back and using entire body weight on the end of the wrench until the nut stops rotating. Use at least two separate tightening passes. Sequence the tightening in each pass so the opposite side nut will be tightened until all the nuts in that pass are snug.

Check the snug tightness, using an Engineer-approved method, of both the top and leveling nuts in the presence of Department personnel after completing nut snugging, but before applying a hydraulic wrench. Ensure snugged nuts meet the torque requirements in Table 810-1:

| <b>Table 810-1<br/>Anchor Bolt Required Torque</b> |                            |                |
|--|----------------------------|----------------|
| <b>Bolt Diameter<br/>(in)</b>                      | <b>Torque<br/>(ft-lbs)</b> |                |
|  | <b>Minimum</b>             | <b>Maximum</b> |
| 1  | 100                        | 200            |
| 1¼   | 200                        | 400            |
| 1½   | 300                        | 600            |
| 1¾   | 400                        | 600            |
| 2  | 500                        | 700            |
| 2¼   | 700                        | 900            |
| 2½   | 800                        | 1,000          |

Ensure the top nut and leveling nut bear fully on the base plate. If a gap exists between the top, or leveling nut and the base plate, add a stainless steel, beveled, Type 304 washer, the same diameter as the hardened washer. Retighten the nuts in the bolt pattern in accordance with this subsection. Remove and re-erect the structure to install beveled stainless steel washers, at no additional cost to the Department.

Use a hydraulic wrench to rotate the top nuts an additional one-third turn. Tighten the nuts in two separate passes, turning the nuts in equal increments with each pass. Use a tightening sequence to ensure the nut opposite the tightened nut is subsequently tightened. Do not allow the leveling nuts to rotate during top nut tightening.

Check the tightness of the nuts in the presence of Department personnel at least 48 hours after the additional ⅓ turn. Apply a torque to the nuts in accordance with Table 810-2.

| <b>Table 810-2<br/>Anchor Bolt Final Turn Required Torque</b> |                                    |
|---|------------------------------------|
| <b>Bolt Diameter<br/>(in)</b>                                 | <b>Minimum Torque<br/>(ft-lbs)</b> |
| 1   | 300                                |
| 1¼  | 630                                |
| 1½  | 1,120                              |
| 1¾  | 1,820                              |
| 2   | 2,770                              |
| 2¼  | 4,010                              |
| 2½  | 5,550                              |

Ensure the bottom leveling nuts contact the base before applying the torque.

Ultrasonically test the base installation before erection of sign supports to verify the absence of flaws. The Department will reject the entire base installation if reflectors provide an indication rating

less than 15 decibels. Replace Department-rejected base assemblies at no additional cost to the Department.

The Department will ultrasonically test the bolts for acceptance. The Department will also test the nuts and washers for tightening. Ultrasonic testing and calibration procedures, used by the Department for final acceptance, are available upon request.

Tighten the nuts or washers, determined loose by the Department during acceptance procedures, in accordance with this subsection. The Engineer will determine if removal, disassembly, or re-erection of the structure is necessary. If the Department determines nuts require tightening, after initial installation, remove and reinstall nuts and washers and, if the Engineer determines necessary, remove, disassemble, and re-erect the entire structure at no additional cost to the Department.

**O. Bridge Sign Connections.** Construct steel and concrete bridge sign connections in accordance with the Sign Support Standards or as required.

Use flush-type expansion anchors of the size and shape shown on the plans, and selected by the Department from the Qualified Products List in accordance with subsection [914.10](#).

**P. Bolt Replacement in Retained Bridge Mounted Sign Connections.** Replace bolts connecting the bracket, sign, diaphragm and hanger to the sign connection. Do not replace bolts in concrete bridge beams and concrete deck fascia.

Provide connection hardware in accordance with subsection [906.06](#).

Remove and replace bolts, nuts, flat washers and lock washers that connect the bolted bridge sign connection bracket to the bridge structure fascia beam, one at a time. Replace the bolts in accordance with subsection [707.03.D.7](#), and tighten using the turn-of-nut tightening method in Table [707-4](#).

**Q. Overhead Lane Assignment Structures.** Construct overhead lane assignment structures in accordance with the Sign Support Standard SIGN-760. After placement of foundations, steel poles, and steel cables, erect the overhead lane assignment signs in accordance with the following:

1. Connect two angles to each sign; one on the top and one on the bottom;
2. Assemble the cable clamps, oval eye bolts, threaded rod, nuts, and washers on the top side of each sign; and

3. Hang the signs from the top cable and attach the bottom plate to the lower cable using cable clamps.

**R. Signs.** Provide complete signs, free of defects. Provide reflectorized sign faces, smooth and free of dents, wrinkles, and other defects. Provide signs with uniform color and brightness, free of warps or other deformations, and without mottling, streaks, or stains. Replace signs that do not meet the size, font, or legend layout requirements. Replace signs with unacceptable wrinkles, as determined by the Engineer.

The Engineer will allow no more than three patches per sign. Use patches made of the same material as the sign. Extend patches  $\frac{9}{16}$  inch beyond the outer edges of the defect. The Engineer will determine the maximum patch size. Do not patch more than 2 percent of the total number of signs per project. For projects with 100 signs or fewer, the Engineer will determine the maximum number of patched signs.

The Engineer will provide date stickers to the Contractor at the preconstruction meeting.

At the time of installation, place a date sticker on the back lower portion of the signs. Ensure the date sticker is fully visible after installation.

Store signs, delivered for use on the project, in accordance with the sheeting manufacturer's recommendations. Replace or repair signs damaged, discolored, or defaced during fabrication, transportation, storage, or erection.

Position and fasten signs to the support. Tighten bolts, including nylon washers, in contact with reflective sheeting in accordance with the reflective sheeting manufacturer's recommendations. Erect signs clean and free of substances that would hide or obscure portions of the sign face.

Along roadways open to traffic, cover signs with messages not immediately applicable. Cover signs in accordance with subsection [812.03.D.2.](#)

If replacing existing signs on project sections open to traffic, remove existing signs after erecting new signs visible to motorists. Remove replaced signs and supports from the right-of-way within 7 days. Remove signs and supports in accordance with subsection [810.03.T.](#) Leave existing overhead signs in place until the installation of new signs. Retain existing signs, not shown on the plans, unless otherwise directed by the Engineer.

Do not install signs behind obstructions. Prune vegetation obstructing signs.

Remove packaging and protective materials from sign panels and clean the exposed sign faces in accordance with the manufacturer's specifications. Remove and dispose of excess material. If sign construction disturbs the site, level and repair the area.

Install signs and supports in accordance with the tolerances specified in this subsection.

1. **Extra Holes.** The Engineer will allow no more than two extra holes per sign. Patch extra holes on the front and back sign surfaces. Use patch material of the same reflectivity, color, and age as the reflective sheeting on the sign. Apply patches in accordance with the sheeting manufacturer's recommendations.
2. **Offset.** Erect signs within 2 feet of the location shown on the plans, but do not erect signs closer to the edge of the traveled roadway than the distance shown on the plans.
3. **Bottom Height.** Erect signs with the bottom height in rural areas within  $\pm 6$  inches of the height shown on the plans, and in urban areas, within 6 inches above the bottom height shown on the plans.
4. **Sign Location.** Do not change the location of regulatory, gore, and no passing zone signs, and signs on cantilevers, trusses, and bridge connections without the Engineer's approval.

Place advance warning signs  $\pm 10$  feet longitudinally from the location shown on the plans. Place the advance warning signs at least the minimum longitudinal distance specified in the [MMUTCD](#).

Place other signs within  $\pm 20$  feet, longitudinally, of the location shown on the plans.

5. **Gaps.** Ensure gaps between plywood sheets do not exceed  $\frac{1}{16}$  inch.
6. **Wedges.** Limit wedge thickness to between  $\frac{3}{4}$  inch and 1 inch.
7. **Unacceptable Wrinkles.** Replace signs with the following defects:
  - a. Wrinkles ending at an outside edge of the sign,
  - b. Wrinkles greater than 3 inches long, or
  - c. Wrinkles that split or damage the sheeting.
8. **Installing Department Supplied Sign.** Transport signs, supplied by the Department, from the location shown on the plans to the project.



Notify the Department contact person at least 72 hours before picking up the sign.

**T. Removal of Signs and Sign Supports.** Remove cantilever and truss sign supports using the methods required for erecting the supports. Remove, haul, and stockpile Type I signs, cantilevers, trusses, column breakaways, bridge connections, and all associated attaching or fastening hardware at the offsite location required. Coordinate delivery of salvaged items with the Department contact person at least 72 hours before transporting.

Take ownership of remaining signs, supports, and associated attaching or fastening hardware.

Pull, do not cut, sign supports requiring removal or replacement. If the Engineer determines posts or columns cannot be pulled, cut off at least 12 inches below grade and fill the hole.

Remove bridge sign connections, welded to steel beams, by flame cutting. Leave a ¼-inch projection from the web. Grind the projection flush with the surface of the web to a surface roughness no greater than 250 micro inches per inch root mean square. Coat the surface with an Engineer-approved zinc-rich primer after grinding.

To remove bridge sign connections, bolted to steel beams, dismantle the bridge sign in reverse order from installation. If replacing an existing sign support, fill unused holes in bridge beams with galvanized high strength bolts, installed in accordance with subsection [707.03.D.7](#).

If removing trusses or cantilevers, separate the truss box or cantilever arms without damaging the unit. Remove the truss box or cantilever arms before removing end supports. Remove end supports in reverse order from installation. Do not torch cut uprights of the end supports for removal. Do not scratch, scorch, or nick the cantilever or truss members.

**U. Removal of Sign Support Foundations.** Remove foundations to 12 inches below the ground surface and backfill in accordance with subsection [204.03.C](#). If the contract documents require complete removal of a foundation, remove sign support foundations in accordance with subsection [204.03.A.3](#) and backfill in accordance with subsection [204.03.C](#).

Dispose of concrete and other deleterious material in accordance with subsection [205.03.P](#). Topsoil, seed, and mulch the removal area in accordance with subsection [816.03](#).

**V. Erection of Salvaged Sign Supports and Signs.** Handle and store signs and sign supports, salvaged for use on the project, in accordance

with subsection [810.03.R](#). Transport, store, and erect salvaged supports and signs in accordance with subsection [810.03.T](#). Replace salvaged signs with damage or defects with new signs, at no additional cost to the Department.

#### 810.04. Measurement and Payment.

| <b>Pay Item</b>   | <b>Pay Unit</b> |
|---|-----------------|
| Delineator Reflector.....   | Each            |
| Post, Delineator.....   | Each            |
| Post, Flexible, Delineator.....                                       | Each            |
| Delineator, Reflective Sheeting, __ inch × __ inch, (color).....      | Each            |
| Post, Steel, __ pound.....  | Foot            |
| Post, Wood, __ inch × __ inch.....                                    | Foot            |
| Post, Wood, __ inch × __ inch, Direct Embedment.....                  | Foot            |
| Post Hole Through Conc for Wood Post.....                             | Each            |
| Post Hole Through Conc for Steel Post.....                            | Each            |
| Band, Sign.....   | Each            |
| Glare Screen Connection, Conc.....                                    | Each            |
| Median Barrier Connection, Conc.....                                  | Each            |
| Median Barrier Connection, Conc, Perforated Steel<br>Square Tube..... | Each            |
| Glare Screen Connection, Conc, Perforated Steel<br>Square Tube.....   | Each            |
| Perforated Steel Square Tube Breakaway System.....                    | Each            |
| Fdn, Breakaway, W8 × (wt/ft).....                                     | Each            |
| Fdn, Cantilever, Type __.....   | Each            |
| Fdn, Truss, Type __.....  | Each            |
| Fdn, Truss Sign Structure Type __, __ inch Dia,<br>Cased.....         | Foot            |
| Fdn, Truss Sign Structure Type __, __ inch Dia,<br>Uncased.....       | Foot            |
| Fdn, Cantilever Sign Structure Type __, __ inch Dia,<br>Cased.....    | Foot            |
| Fdn, Cantilever Sign Structure Type __, __ inch Dia,<br>Uncased.....  | Foot            |
| Column, Breakaway, W8 × (wt/ft).....                                  | Each            |
| Cantilever, Type __.....  | Each            |
| Truss, Type __, __ foot.....  | Each            |
| Sign, Type __.....  | Square Foot     |
| Bridge Sign Connection, Conc, Type __.....                            | Each            |
| Bridge Sign Connection, Steel, Type __.....                           | Each            |
| Bridge Sign Connection, Bolt Replacement.....                         | Each            |
| Overhead Lane Assignment Structure.....                               | Each            |

|  |            |
|--|------------|
| Installing MDOT Supplied Sign, Type __ ..... | Each       |
| Sign, Type __, Rem.....                      | Each       |
| Fdn, Wood Support, Rem.....                  | Each       |
| Fdn, Entire, Cantilever, Rem .....           | Cubic Yard |
| Fdn, Entire, Truss, Rem .....                | Cubic Yard |
| Fdn, Column Breakaway, Rem .....             | Each       |
| Fdn, Cantilever, Rem.....                    | Each       |
| Fdn, Truss, Rem.....                         | Each       |
| Cantilever, Rem.....                         | Each       |
| Truss, Rem .....                             | Each       |
| Bridge Sign Connection, Type __, Rem.....    | Each       |
| Transporting Salv MDOT Materials .....       | Lump Sum   |
| Cantilever, Type __, Erect, Salv.....        | Each       |
| Truss, Type __, __ foot, Erect, Salv .....   | Each       |
| Sign, Type __, Erect, Salv .....             | Each       |
| Truss Fdn Anchor Bolts, Replace.....         | Each       |

The unit prices for fabricated items include the cost of providing dimensional information for the relevant fabricated item.

**A. Sign Posts.**

1. **Post, Steel or Post, Wood.** The Engineer will measure sign supports to the nearest commercial length required. The Department will not pay for the portion of posts installed deeper than the depth shown on the plans, unless authorized by the Engineer.

The unit price for **Post, Wood**, of the type required, includes the cost of providing and installing wood post sign supports set in a sleeve in concrete.

2. **Post Holes Through Concrete for Steel Posts or Post Holes Through Concrete for Wood Posts.** The unit prices for **Post Hole Through Conc for Steel Post** and **Post Hole Through Conc for Wood Post** include the cost of drilling or saw cutting a hole in existing concrete, silicone sealer, cleaning the site, and replacing damaged concrete.

If installing posts in new concrete, the unit prices for **Post Hole Through Conc for Steel Post** and **Post Hole Through Conc for Wood Post** include the cost of the optional method of forming.

**B. Foundation.**

1. **Foundation, Truss Sign Structure and Foundation, Cantilever Sign Structure.** The Engineer will measure **Fdn, Truss Sign Structure** and **Fdn, Cantilever Sign Structure**, of the diameter

required, from the bottom of the drilled shaft to the top of the finished foundation.

The unit prices for **Fdn, Truss Sign Structure Type \_\_, \_\_ inch Dia, Cased** and **Fdn, Cantilever Sign Structure Type \_\_, \_\_ inch Dia, Cased** include the cost of concrete, slurry, steel reinforcement, permanent casings, excavation, and disposal of excavated material.

2. **Foundation, Truss Sign Structure, Uncased and Foundation, Cantilever Sign Structure, Uncased.** The unit prices for **Fdn, Truss Sign Structure, Type \_\_, \_\_ inch Dia, Uncased** and **Fdn, Cantilever Sign Structure, Type \_\_, \_\_ inch Dia, Uncased**, include the cost of concrete, steel reinforcement, slurry, temporary casings, excavation, and disposal of excavated material.

C. **Bridge Sign Connections.** The unit prices for bridge sign connection pay items include the cost of locating connections and constructing and installing the sign supports.

The unit price for **Bridge Sign Connection, Bolt Replacement** includes the cost of bolted bridge connections, including retained diaphragms and hangers on steel bridges, and removing and replacing bolts and associated hardware. Removed bolts and hardware become the property of the Department.

D. **Retaining Wall Connection.** The unit price for **Retaining Wall Connection**, of the type required, includes the cost of installing the sign supports.

The unit price for **Sign**, of the type required, includes the cost of installing signs on supports.

E. **Overhead Lane Assignment Structure.** The unit price for **Overhead Lane Assignment Structure** includes the cost of constructing the foundations for installing structures and lane assignment signs.

F. **Signs.** The Engineer will not deduct corner radii or mounting holes when determining the area of sign faces. The Engineer will calculate the area using the smallest circumscribing rectangle. The Engineer will calculate the area of triangular signs using the area of the circumscribing triangle.

The unit price for **Sign**, of the type required, includes the cost of attaching devices and hardware, including H-brackets, fabricating and erecting signs, pruning vegetation, and site cleanup in accordance with subsection [810.03.R](#).

The Engineer will measure individual sign bands for payment. The unit price for **Band, Sign** includes the cost of furnishing and installing each sign band regardless of the number of bands required per sign installed.

The unit price for **Sign, Type II** includes the cost of fabricating signs, workmanship, repair, and sealing plywood edges in accordance with subsection [919.02.A.2](#).

Before final acceptance, replace or repair approved for use, and in-use traffic sign installations, which are damaged by conditions not caused by the Contractor, as directed by the Engineer.

The Department will pay for replaced items at the contract unit price unless the Contractor justifies that the elapsed time between initial installation and the replacement installation warrants a price adjustment in accordance with section [103](#). The Department will pay for repaired items as extra work.

**G. Certification of Structural Steel Plants.** The Department will not pay for costs incurred for the certification of structural steel plants. The Department will not consider claims by the Contractor or Fabricator for delays and inconvenience associated with the certification process.

**H. Installing MDOT Supplied Sign.** The unit price for **Installing MDOT Supplied Sign**, of the type required, includes the cost of loading the sign at the location shown on the plans, transportation, sign mounting hardware, and installation.

**I. Removal of Signs and Foundations.** The unit price for **Sign, Rem**, of the type required, includes the cost of removing supports, sign bands, concrete glare screen connections, or concrete median barrier connections, attaching or fastening hardware, and removing signs from supports and stacking by shape and size.

The unit prices for **Cantilever, Rem** and **Truss, Rem** include the cost of removing cantilever or truss supports.

If the contract does not include a pay item for **Bridge Connection, Rem**, of the type required, the unit price for **Sign, Rem**, of the type required, includes the cost of bridge connection removals.

The unit prices for constructing or removing foundations include the cost of placing topsoil, seeding, and mulch and restoring the area.

**J. Transporting Salvage MDOT Materials.** The unit price for **Transporting Salv MDOT Materials** includes the cost of loading, transporting, unloading, and stacking salvaged materials at the off-site location shown on the plans or directed by the Engineer.

K. **Cantilever, Erect, Salvage and Truss, Erect, Salvage.** The unit prices for **Cantilever, Erect, Salv** and **Truss, Erect, Salv**, of the types required, include loading, transporting, unloading, storing, and erecting the salvaged sign support on a new or existing foundation, as shown on the plans.

L. **Sign, Erect, Salvage.** The unit price for **Sign, Erect, Salv**, of the type required, includes the cost of storing signs after removal, loading, transporting, unloading, erecting the salvaged sign on a new sign support, or existing sign support, as shown on the plans, and attaching devices, and hardware, including brackets.

The Department will pay separately for new sign supports.

**Section 811. PERMANENT PAVEMENT MARKINGS**

**811.01. Description.** This work consists of providing and applying retroreflective permanent pavement markings in accordance with the [Michigan Manual on Uniform Traffic Control Devices](#). Provide markings, shapes, spacing, and dimensions that conform to the [MDOT Pavement Marking Standard Plans](#).

**811.02. Materials.** Provide materials in accordance with the following:

- Glass Beads ..... [920](#)
- Waterborne Pavement Marking Material..... [920](#)
- Low Temperature Waterborne Pavement Marking Material ..... [920](#)
- Regular Dry Pavement Marking Material ..... [920](#)
- Cold Plastic Pavement Marking Material..... [920](#)
- Thermoplastic Pavement Marking Material..... [920](#)
- Sprayable Thermoplastic Pavement Marking Material..... [920](#)
- Polyurea Pavement Marking Material ..... [920](#)

Provide the Material Safety Data Sheets to the Engineer for required materials and supplies. Dispose of unused material and containers in accordance with the Federal Resource Conservation Recovery Act (RCRA) of 1976 as amended, and 1994 PA 451, Part 111 Hazardous Waste Management.

Provide samples of permanent pavement marking materials on Department request.

**811.03. Construction.**

**A. Equipment.** Apply longitudinal lines with certified self-propelled pavement marking equipment. The Engineer may approve other equipment for special markings or areas inaccessible to self-propelled pavement marking equipment.

Provide self-propelled equipment certified by the Department in accordance with the Equipment Certification Guidelines for Pavement Markings. Certification is effective for 2 years. Operate marking equipment at no greater than the certified speed. The Engineer will assume a striping, operating above the certified working speed, has operated at that speed for the entire day.

The Department may inspect the equipment at any time.

Use equipment capable of uniformly applying material to the required length and width.

Provide equipment for placing centerlines, capable of applying three, 4-inch minimum width lines on a two-lane road in one pass. If applying multiple centerlines, use three spray guns positioned 6 inches on center. For two lane freeways, apply the lane line from the left lane. For freeways with at least three lanes, apply the right lane line with the right edgeline.

Use an easily adjusted, dashing mechanism to retrace existing lane or centerline markings.

Use a self-propelled pavement marker capable of marking pavement in either direction on a roadway. Use a continuous skip cycle. Do not zero or return the cycle control unit to the beginning or start of a new cycle.

Provide a distance meter to measure the length of each line.

The Engineer may check the calibration of metering devices at any time. If the Engineer determines the equipment is unsatisfactory, use other methods approved by the Engineer.

Use equipment for placing hot-applied thermoplastic and sprayable thermoplastic material that can maintain the temperature recommended by the material manufacturer.

Allow time for the Engineer to inspect traffic control devices as shown in the pavement marking convoy typicals. Correct traffic control devices not approved by the Engineer before continuing. If applying markings on a roadway closed to traffic, the traffic control devices specified in the pavement marking convoy typicals are not required, unless otherwise directed by the Engineer.

**B. General.** The Department will not provide storage buildings or space for permanent pavement marking equipment or materials.

If specified on the plans, layout the permanent pavement markings. Otherwise, witness, log and lay out permanent pavement markings to replace in kind. When layout is complete, contact the Engineer to review the layout work before applying permanent pavement markings.

Before applying pavement markings, ensure the pavement surface is clean and dry. Air blast to remove material that prevents pavement markings from adhering to the pavement surface. Remove debris or dead animals from the line track.

For solid lines, apply 4 inch and 6 inch lines, no greater than  $\frac{1}{4}$  inch wider than the required width. Apply solid lines with no gaps or spaces. Apply a double line as either two solid lines or one solid line and one broken line.



For new broken lines, apply 12½-foot long lines, no greater than 4 inches longer than the required length. Leave a 37½-foot gap between new broken lines. Continue this 50-foot cycle of broken line and gap, as shown on the plans. Apply new lines at the required location within a lateral tolerance of 1 inch.

When applying centerline and lane lines on new construction, retrace at least five existing adjacent skips to match the existing pavement marking cycle.

Retrace existing pavement markings using lines equal to the width and length of the original markings. For existing 4-inch, 6-inch, 8-inch, or 12-inch wide lines, retrace no greater than ¼ inch wider than the existing line. If existing lines exceed the nominal widths, ensure the total line widths, existing and retraced, do not exceed 5 inches, 7 inches, 9 inches, and 13 inches.

For existing 12½-foot broken lines, place the retraced line to a longitudinal tolerance of no greater than 4 inches longer than the existing line. If existing lines exceed 12½ feet long, ensure broken line lengths for existing and retraced lines do not exceed 13 feet.

Mix liquid materials during application. Do not thin materials. Uniformly apply pavement marking material at the rates shown in Table 811-1.

| Binder Type                | Thickness (mil) | Binder volume & Bead weight | Line Type |      |      |       |       |       |       |       |  |  |  |  |
|----------------------------|-----------------|-----------------------------|-----------|------|------|-------|-------|-------|-------|-------|--|--|--|--|
|                            |                 |                             | Broken    |      |      |       |       |       | Solid |       |  |  |  |  |
|                            |                 |                             | 4 in      | 6 in | 8 in | 12 in | 4 in  | 6 in  | 8 in  | 12 in |  |  |  |  |
| Waterborne                 | 15              | Binder (gal)                | 4         | 6    | 8    | 12    | 16    | 24    | 32    | 48    |  |  |  |  |
|                            |                 | Bead (lb)                   | 32        | 48   | 64   | 96    | 128   | 192   | 256   | 384   |  |  |  |  |
| Low Temperature Waterborne | 15              | Binder (gal)                | 4         | 6    | 8    | 12    | 16    | 24    | 32    | 48    |  |  |  |  |
|                            |                 | Bead (lb)                   | 32        | 48   | 64   | 96    | 128   | 192   | 256   | 384   |  |  |  |  |
| Regular Dry                | 15              | Binder (gal)                | 4         | 6    | 8    | 12    | 16    | 24    | 32    | 48    |  |  |  |  |
|                            |                 | Bead (lb)                   | 24        | 36   | 48   | 72    | 96    | 144   | 192   | 288   |  |  |  |  |
| Thermoplastic              | 90              | Binder (lb)                 | 435       | 653  | 870  | 1,305 | 1,740 | 2,610 | 3,480 | 5,220 |  |  |  |  |
|                            |                 | Bead (lb)                   | 50        | 75   | 100  | 150   | 200   | 300   | 400   | 600   |  |  |  |  |
| Sprayable Thermoplastic    | 30 (c)          | Binder (lb)                 | 140       | 210  | 280  | 420   | 560   | 840   | 1,120 | 1,680 |  |  |  |  |
|                            |                 | Bead (lb)                   | 50        | 75   | 100  | 150   | 200   | 300   | 400   | 600   |  |  |  |  |
| Polyurea                   | 20              | Binder (gal)                | 6         | 8    | 11   | 17    | 22    | 33    | 44    | 66    |  |  |  |  |
|                            |                 | Bead (lb)                   |           |      |      |       |       |       |       |       |  |  |  |  |

As directed by the manufacturer

a. Binder yield indicates the amount to produce the required mil thickness without drop on beads.  
b. Bead yield indicates the amount of drop on beads required for the given binder.  
c. Apply drop on beads for a final thickness of 40 mil.

The Engineer will determine the application rates by dividing the quantity of material used by the length of the line placed. The Engineer may check application rates at start up, and during work, without prior notice to the Contractor.

Load pavement marking materials on the pavement marking machine without interfering with, or delaying traffic. Operate striping equipment to prevent traffic from crossing the uncured markings. Prevent vehicles from being sprayed.

Position bead guns to direct beads into the line material and provide a uniform application of beads.

If applying markings in off-road areas open to traffic, including rest areas, roadside parks, or car pool lots, maintain traffic to prevent vehicles from crossing the uncured markings.

The Department does not require glass beads for waterborne pavement marking material if marking rest areas, roadside parks, and car pool lots.

Apply sharp, well-defined markings, free of uneven edges, overspray, or other visible defects, as determined by the Engineer. Ensure pavement marking lines are straight, or of uniform curvature. Pavement markings are subject to inspection by the Engineer in accordance with the Pavement Marking Inspection Guidelines. Remove pavement markings outside the required tolerances and re-apply in the correct locations. Re-apply unprotected pavement markings damaged by traffic and remove tracked lines at no additional cost to the Department.

**C. Removal.** If required, remove existing longitudinal pavement markings on old pavement or curing compound on new concrete in accordance with subsection [812.03.F](#).

If removing special markings, including legends, symbols, arrows, crosswalks, and stop bars, install the new markings within 5 working days.

If removing cold plastic markings, collect and dispose of removed material.

**D. Application, Temperature and Seasonal Restrictions.** Ensure the material application rates in Table [811-1](#), the temperature and seasonal application restrictions in Table [811-2](#), and the additional requirements detailed in this subsection for specific materials are met when applying any material, unless directed by the Engineer. Document moisture testing and provide results to the Engineer.

1. **Waterborne.** The Engineer will not decide the suitability of specific days for the application of waterborne paint. Re-apply lines washed away or otherwise damaged by rain at no additional cost to the Department.

The Contractor may place waterborne pavement markings immediately on new Hot Mix Asphalt (HMA) pavement.

2. **Low Temperature Waterborne.** If seasonal limitations prevent placement of waterborne paint, the Engineer may approve low temperature waterborne paint.

Wait at least 30 days after placing the pavement surface before applying low temperature waterborne pavement markings to new HMA wearing surface. The Engineer may waive the 30-day waiting period.

3. **Regular Dry Paint.** If seasonal limitations prevent the placement of waterborne paint, the Engineer may approve regular dry paint.

Wait at least 14 days after placing the pavement surface before applying regular dry pavement markings to new HMA wearing surface. The Engineer may waive the 14-day waiting period.

4. **Cold Plastic.** Prepare the pavement surface and apply the cold plastic tape in accordance with the manufacturer's specifications.

Remove curing compound from new concrete surfaces before applying cold plastic tape. For pavements with two or more layers of existing overlay cold plastic marking material or any other non-compatible materials, remove the existing marking material before installing the new cold plastic markings.

Install cold plastic tape legends, crosswalks, and stop bars, as shown on the standard plans, unless otherwise required in the plans.

- a. **With Contact Cement.** Apply contact cement recommended by the cold plastic marking manufacturer and approved by the Department. Mix contact cement during application. Do not thin the contact cement. Allow time for solvents to evaporate from the adhesive before applying the cold plastic marking. Apply the contact cement by a method recommended by the manufacturer and ensure it is beneath the entire marking.

Provide non-adhesive backed cold plastic for stop bars and crosswalks. Provide adhesive backed cold plastic for all other special markings.

Immediately after placement, roll transverse and special markings at least four times with a roller weighing at least 200 pounds. The Engineer will not require additional rolling for longitudinal applications if the equipment for installing the line is equipped with a roller.

- b. **Primerless – Without Surface Preparation Adhesive.** Ensure dry weather for at least 24 hours, and a dry pavement surface before applying the primerless cold plastic tape marking. Clean the pavement surface using an air compressor with at least 185 cfm air flow and 120 psi. On all pavement surfaces, prevent damage to transverse and longitudinal joint sealers.

Immediately after placement, roll transverse and special markings at least six times with a roller weighing at least 200 pounds. The Engineer will not require additional rolling for longitudinal applications if the equipment installing the line is equipped with a roller.

- c. **Primerless – With Surface Preparation Adhesive.** Use surface preparation adhesive on all primerless cold plastic tape as recommended by the manufacturer or as shown on the plans.

Ensure dry weather for at least 24 hours, and a dry pavement surface before applying the primerless cold plastic tape marking. Clean the pavement surface using an air compressor with at least 185 cfm air flow and 120 psi. On all pavement surfaces, prevent damage to transverse and longitudinal joint sealers.

Immediately after placement, roll transverse and special markings at least six times with a roller weighing at least 200 pounds. The Engineer will not require additional rolling for longitudinal applications if the equipment installing the line is equipped with a roller.

5. **Thermoplastic.** Ensure the pavement is free of excess surface and subsurface moisture that may affect bonding. The Engineer will not decide the suitability of specific days for the application of thermoplastic.

Heat and apply the thermoplastic material within the temperature range recommended by the manufacturer.

6. **Sprayable Thermoplastic.** Ensure the pavement is free of excess surface and subsurface moisture that may affect bonding. The Engineer will not decide the suitability of specific days for the application of thermoplastic.

Heat and apply the sprayable thermoplastic material within the temperature range recommended by the manufacturer.

7. **Polyurea.** Ensure the pavement is free of excess surface and subsurface moisture that may affect bonding. The Engineer will not decide the suitability of specific days for the application of thermoplastic.

Surface preparation requirements for special, and longitudinal polyurea pavement markings depend on surface conditions.

Prepare new HMA surfaces and HMA surfaces open to traffic for 10 days or less with no oil drips, residue, debris, or temporary or permanent markings, by cleaning the marking area with compressed air.

Prepare new PCC surfaces and PCC surfaces free of oil drips, residue, and debris, temporary, or permanent markings, by removing the curing compound from the area required for pavement markings.

Prepare existing HMA or PCC surfaces that do not have existing markings, but may have oil drip areas, debris, or both, by scarifying the marking area using non-milling grinding teeth or shot blasting. The Engineer will allow the use of water blasting to scarify the marking area on PCC surfaces.

Prepare existing HMA or PCC surfaces with existing non-polyurea markings by completely removing non-polyurea markings.

Prepare existing HMA or PCC surfaces with existing polyurea marking and that may have oil drip areas, debris, or both, by using the following methods:

- a. Clean the marking area with compressed air if markings are replaced every 2 years and no visible oil drip areas or visible chipping or spalling of the existing marking exist;
- b. Scarify the marking area using non-milling grinding teeth or shot blast if markings are replaced every 2 years and visible oil drip areas, chipping or spalling of the existing markings exist; or
- c. Completely remove existing pavement markings if markings are replaced every 4 years.

| <b>Material</b>   | <b>Minimum Air Temperature (°F) (b)</b> | <b>Minimum Pavement Temperature (°F) (c)</b> | <b>Start Date</b> | <b>End Date</b> |
|---|---|--|-------------------|-----------------|
| Waterborne  | 50                                      | 50   | May 1             | Oct. 15         |
| Low Temperature Waterborne  | 35                                      | 35   | Oct. 1            | May 1           |
| Regular Dry   | 25                                      | 25   | Oct. 1            | May 1           |
| Cold Plastic Tape – with Contact Cement   | 60                                      | 60   | May 1             | Oct. 15         |
| Cold Plastic Tape – Primerless – without Surface Preparation Adhesive   | 60                                      | 60   | Jun. 1            | Sept. 1         |
| Cold Plastic Tape – Primerless – with Surface Preparation Adhesive  | 40                                      | 40   | Apr. 15           | Nov. 15         |
| Thermoplastic   | 50                                      | 50   | May 1             | Oct. 15         |
| Sprayable Thermoplastic   | 50                                      | 50   | Apr. 15           | Nov. 15         |
| Polyurea  | 40                                      | 40   | Apr. 15           | Nov. 15         |
| a. See text for more detailed information.<br>b. Temperature must meet minimum and be rising.<br>c. Pavement must be dry. |   |  |                   |                 |

**E. Second Application.** If the contract requires a second application of permanent pavement markings, complete two applications regardless of initial pavement marking conditions. Complete the second application from 14 days to 60 days after initial application in the same calendar year.

The Contractor may apply the second application before the required 14 days if previously approved by the Engineer.

**F. Call Back Painting.** The Engineer will provide a list of locations and limits for call back pavement marking painting, and will direct the order that the Contractor may paint the locations.

Begin call back painting work within seven days of the Engineer's notification.

**G. Shoulder Rumble Strip Marking (SRSB).** Apply markings 4 inches wide within the shoulder rumble strips as shown on the plans or directed by the Engineer. Ensure a gap of 8 inches to 10 inches between the edge line and the SRSB.

Apply solid lines for SRSB. If possible, apply the 6-inch edge line and the 4-inch SRSB in the same pass.

Retrace existing SRSM with lines of equal width. For existing 4-inch wide lines, retrace no greater than ¼ inch wider than the existing line. If the existing line exceeds a width of 4 inches, ensure the existing and retraced SRSM total line width is no greater than 5 inches wide. If possible, retrace the 6-inch edge line and the 4-inch SRSM in the same pass.

**H. Raised Pavement Marker (RPM) Removal.** Remove RPM with Department-approved equipment. During removal, do not disturb pavement more than 3 inches below the surface or more than 3 inches from the perimeter of the marker casting. The Engineer will stop marker removal if damage to the pavement exceeds these limits.

The Engineer will require patching, regardless of milling requirements, unless the Engineer determines damaged areas do not pose a hazard to traffic. Use leveling mix to patch concrete and HMA pavement that require HMA overlay.

Use a prepackaged, hydraulic, fast-set material for patching structural concrete, from the Qualified Products List for patching concrete pavement not requiring overlay. Patch concrete pavement, not requiring overlay in accordance with the patch material manufacturer's specifications.

Patch HMA pavement, not requiring overlay, with the epoxy adhesive used to attach raised pavement markers to the pavement.

Clean and dispose of debris from RPM removal and patching operations.

#### **811.04. Measurement and Payment.**

| <b>Pay Item</b>   | <b>Pay Unit</b> |
|---|-----------------|
| Pavt Mrkg, Waterborne, __ inch, (color).....                                    | Foot            |
| Pavt Mrkg, Waterborne, 2nd Application __ inch, (color).....                    | Foot            |
| Pavt Mrkg, Waterborne, for Rest Areas, Parks, &<br>Lots, __ inch, (color) ..... | Foot            |
| Pavt Mrkg, Regular Dry, __ inch, (color) .....                                  | Foot            |
| Pavt Mrkg, Regular Dry, 2nd Application, __ inch, (color) .....                 | Foot            |
| Pavt Mrkg, Thermopl, __ inch, (color) .....                                     | Foot            |
| Pavt Mrkg, Thermopl, __ inch, Crosswalk.....                                    | Foot            |
| Pavt Mrkg, Thermopl, __ inch, Stop Bar .....                                    | Foot            |
| Pavt Mrkg, Thermopl, __ inch, Cross Hatching, (color) .....                     | Foot            |
| Pavt Mrkg, Sprayable Thermopl, __ inch, (color).....                            | Foot            |
| Pavt Mrkg, Ovly Cold Plastic, __ inch, (color) .....                            | Foot            |
| Pavt Mrkg, Ovly Cold Plastic, __ inch, Stop Bar .....                           | Foot            |
| Pavt Mrkg, Ovly Cold Plastic, 12 inch, Crosshatching,<br>(color).....           | Foot            |



|   |             |
|---|-------------|
| Pavt Mrkg, Ovly Cold Plastic, ___ inch, Crosswalk.....                | Foot        |
| Pavt Mrkg, Ovly Cold Plastic, (legend).....                           | Each        |
| Pavt Mrkg, Ovly Cold Plastic, (symbol) .....                          | Each        |
| Pavt Mrkg, Polyurea, ___ inch, Crosswalk.....                         | Foot        |
| Pavt Mrkg, Polyurea, ___ inch, Stop Bar .....                         | Foot        |
| Pavt Mrkg, Polyurea, ___ inch, Cross Hatching.....                    | Foot        |
| Pavt Mrkg, Polyurea, ___ inch, (color) .....                          | Foot        |
| Pavt Mrkg, (material), 4 inch, SRSM, (color).....                     | Foot        |
| Pavt Mrkg, (material), 4 inch, SRSM, 2nd Application,<br>(color)..... | Foot        |
| Rem Curing Compound, for Spec Mrkg .....                              | Square Foot |
| Rem Curing Compound, for Longit Mrkg ___ width .....                  | Foot        |
| Rem Spec Mrkg.....  | Square Foot |
| Call Back, Mobilization .....   | Each        |
| Call Back, Intermediate Transportation.....                           | Mile        |
| Rem Raised Pavt Marker .....  | Each        |
| Witness, Log, Layout, Max. __, \$1,000.00.....                        | Dollars     |

A. **General.** The Engineer will not measure the skips in dashed lines. The cost of traffic control and mobilization is included in the unit prices for other pavement marking placement pay items.

The cost of collecting and disposing of residue generated by the removal of cold plastic pavement markings and curing compound is included in the unit prices for other removal pay items.

The cost of glass beads is included in the unit prices for other pavement marking material.

The Department will not pay separately for the contact cement and adhesives for longitudinal lines, legends, symbols, arrows, crosswalks, or stop bars.

The Department will not pay for markings placed by equipment operated at speeds higher than the certified speed.

The Department will not assess liquidated damages if the 30-day waiting period for placing low temperature waterborne paint is in effect and the project is complete. The Department will not assess liquidated damages if the 14-day waiting period for regular dry paint is in effect and the project is complete.

The unit price for **Rem Curing Compound** includes the cost of preparing new PCC for marker application by removing the curing compound.

The Engineer will calculate pay adjustment as required by the contract when regular dry paint or low temperature waterborne paint are

substituted for waterborne paint due to seasonal limitations. The adjustment applies only to projects that have completion dates after October 1, or have approved extensions of time without liquidated damages beyond October 1. Contractors who are in liquidated damages after October 1 are not eligible for the price adjustment.

**B. Delayed Acceptance.** The Department will not pay for corrective action required for delayed acceptance, including removal and replacement of failed pavement markings.

The Department will delay final acceptance of completed pavement marking work for 60 days. During this 60-day delayed acceptance period, the Department will inspect the markings at its discretion. The Department will not accept pavement markings if less than 90 percent of the original marking remains, and will require the Contractor to replace the markings immediately. The Department will not consider pavement markings, damaged by snowplow operations, as failed.

Provide the Department with a maintenance bond equal to 90 percent of the value of the pavement marking work performed so the Department can accept the project for final payment before the end of the 60-day delayed acceptance period. Ensure the bond is in effect when the balance of the contract work is completed.

**C. Call Back.** The unit price for **Call Back, Mobilization** includes the cost of traveling to the first call back painting location.

The Engineer will measure **Call Back, Intermediate Transportation** based on the map distances. The unit price for **Call Back, Intermediate Transportation** includes the cost of traveling between intermediate locations.

**D. Pavement Marking Removal.** The Engineer will measure the full removal of special markings based on the Pavement Marking Standard Plans. The Department will pay for partial removal of special markings based on the dimensions of the actual removal area. If full removal of pavement markings is required, the unit prices for **Rem Spec Mrkg** or **Pavt Mrkg, Longit, 6 inch or Less Width, Rem**, and **Pavt Mrkg, Longit, Greater than 6 inch Width, Rem** include the cost of the removal in accordance with subsection [812.04.N](#).

If the Contractor removes multiple layers of pavement marking materials, the Department will not pay separately for material removed beyond the first layer.

**E. Material Deficiency.** The Engineer will compute the quantity of pavement marking material and glass beads applied per unit of

## 811.04

measurement at the end of each work day. The Engineer may include an applied length of less than 10 miles in the next day's measurement. The Engineer will determine the material usage based on field measurements and the required application rate specified in Table [811-1](#).

The Department will reduce the unit price for pavement marking material for material shortages in direct proportion to the deficient material quantity, up to 6 percent. If the daily deficiency of pavement marking material, or beads, is greater than 6 percent, the Department will consider the day's work unsatisfactory and will direct the Contractor to reapply the day's markings to the thickness required by the contract, at no additional cost to the Department.

## **Section 812. TEMPORARY TRAFFIC CONTROL FOR CONSTRUCTION ZONE OPERATIONS**

**812.01. Description.** This work consists of protecting, regulating, warning, guiding, and maintaining traffic through and around the Construction Influence Area (CIA). This work includes furnishing, operating, and removing traffic control devices.

The Department will provide, install, and maintain traffic control devices outside the CIA.

**812.02. Materials.** Provide material in accordance with the following:

|                                       |                     |
|---------------------------------------|---------------------|
| Temporary Traffic Signs .....         | <a href="#">922</a> |
| Channelizing Devices .....            | <a href="#">922</a> |
| Temporary Pavement Markings .....     | <a href="#">922</a> |
| Lighting Devices .....                | <a href="#">922</a> |
| Temporary Traffic Signals .....       | <a href="#">922</a> |
| Traffic Regulator Equipment.....      | <a href="#">922</a> |
| Portable Changeable Message Sign..... | <a href="#">922</a> |
| Temporary Concrete Barrier.....       | <a href="#">922</a> |
| Temporary Attenuation.....            | <a href="#">922</a> |
| Conspicuity Tape.....                 | <a href="#">922</a> |

### **812.03. Construction.**

**A. Contractor Notification.** Notify the Engineer at least 72 hours, or as otherwise required by the contract, before starting work or installing initial traffic control devices on the project.

**B. Changes in Stage Construction Plans.** Provide written notice to the Engineer before making changes in stage construction. If the Department accepts the changes, the Engineer will provide written approval to the Contractor.

**C. Deficient Traffic Control Operations.** The Engineer will give written notification to the Contractor of deficient, inadequate, or improperly placed traffic control devices, or unsafe conditions within the CIA. This notification will include a statement of the required corrective action and timeframe for completion of the corrective action. Failure to make corrections within the timeframe required may result in the following actions by the Engineer:

1. Stop work on the project until the Contractor completes corrective action; and
2. Order corrective action by others in accordance with subsection [107.07](#), subsection [108.05](#), and in the interest of public safety.

**D. Placing Traffic Control Devices.** Provide and maintain traffic control devices meeting the requirements in the ATSSA Quality Guidelines for Work Zone Traffic Control Devices.

Apply and place traffic control devices within the CIA in accordance with the [MMUTCD](#), as shown on the plans, or as directed in writing by the Engineer.

Do not place commercial or Contractor identification signs within the highway right-of-way.

Display only traffic control devices relevant to conditions. Cover, remove, modify, or move existing temporary or permanent signs with inapplicable legends. Do not place temporary signs not in use, with the sign face parallel to traffic.

Inspect traffic control devices daily to ensure devices are relevant, in place, positioned, aligned, and oriented as required. Record inspections and make the records available to the Engineer upon request. The Department may take possession of the inspection records at project completion.

Maintain lights on traffic control devices in working order at all times without direction from the Engineer.

Ensure the actions of subcontractors regarding the condition, placement, maintenance, and removal of traffic control devices on the project are as required.

Remove temporary traffic control devices from the project if no longer required.

Temporary traffic control devices provided by the Contractor will remain the property of the Contractor.

1. **Temporary Signs.** Mount signs of 20 square feet or less on portable or ground driven sign supports. Mount larger signs on ground driven supports. Place ground driven sign systems as described in Standard Plan WZD-100 Series, or use another NCHRP-350 or the AASHTO *Manual for Assessing Safety Hardware* (MASH) accepted design.

Mount signs at a bottom height of at least 5 feet above the near edge of pavement and at least 5 feet above ground. If placing a sign behind a retaining wall, provide a bottom height of at least 5 feet above the top of the wall and provide a minimum height above the ground behind the wall to ensure visibility.

If erecting signs behind a curb, or within 6 feet of a pedestrian walkway, mount signs at a bottom height of at least 7 feet above ground.

For ground driven signs, if a secondary sign is required, mount the secondary sign below the primary sign with a bottom height 1 foot less than the bottom height required.

For portable signs requiring a secondary sign, mount on separate supports, at the required bottom height. Mount the primary portable sign above the secondary sign on separate supports. The Engineer will allow portable sign clusters if the total area measures no greater than 20 square feet.

Erect signs with supports vertical and the legend or symbol horizontal. Ensure signs do not vary from plumb by more than 2 inches over 4 feet.

The Department will allow the use flexible, roll-up signs only during daylight hours. The Department will not allow the use mesh signs.

Place and operate one Type A warning light, equipped with a one-way lens, on 4 feet by 4 feet diamond warning signs when required for that device by the FHWA Work Zone Acceptance letter.

For shoulders with no barrier walls, if removing temporary signs on portable supports, remove the sign stands from the uprights. Lay the sign flat, off the shoulder, and place the uprights facing downstream from traffic. Remove support stands and ballasts from the shoulder.

For shoulders with barrier walls, if removing temporary signs on portable supports, remove the sign stands from the uprights, and place against the barrier wall. Place the uprights facing downstream from traffic and place support stands and ballasts close to the barrier wall. Do not place sign covers on temporary sign systems on portable supports located on shoulders with no barrier walls.

Cover temporary signs on portable supports that straddle barrier wall, required to remain on the project while not in use. Remove sign covers from the roadway, or store against the barrier wall, when not in use.

For locations with guardrail, if conditions require temporary removal of temporary signs on portable supports, remove the sign stands from the uprights. Lay the sign behind the guardrail, and place support stands and ballasts close to the guardrail.

Do not obstruct or interfere with attenuation devices when storing temporarily removed temporary signs on portable supports.

2. **Sign Covers.** For permanent signs, other than overhead signs and signs larger than 60 square feet, cover the entire front of the sign panel. Mount the sign coverings using Department-approved methods to avoid damaging the sign sheeting. Do not apply fastening devices or covers directly to the reflective sheeting. Use spacers that provide 2 inches of air space between the cover and the sign face to protect the sheeting from damage.

Install Type I sign covers on Type I signs shown in the contract, to obscure conflicting information. Submit shop drawings of the Type I sign covers to the Engineer, and obtain the Engineer's approval, before covering Type I signs on the project.

For temporary signs on fixed supports, cover the entire sign legend.

Do not use burlap or similar material to cover Department owned signs. The Contractor may use soft covers on other temporary signs.

Do not use sign plaque overlays that alter part of the legend or symbol.

3. **Sign Supports.** Place and construct sign supports to resist swaying, turning, or displacement. Provide fixed sign posts in accordance with subsection [919.04](#), except the Engineer will allow painted or galvanized steel posts.

Mount construction signs on portable sign support standards only if signs are to remain in place for 3 days or less, or as allowed by the Engineer if fixed supports are not possible.

4. **Supplemental Weights.** Maintain traffic control devices upright and aligned during use. Use sandbags, or a Department-approved alternate as supplemental weights to achieve stability.
5. **Channelizing Devices.** Install the lead-in signing and lighted arrow before installing channelizing devices. Install channelizing devices in the direction of traffic flow. Remove channelizing devices in the opposite direction of traffic flow. The reflective sheeting for all channelizing devices within the project limits must be the same ASTM type for the life of the project. Do not mix drums and cones within a traffic control signing sequence. Where lane closures are already in place, use the same type of channelizing devices to extend the closures.

The Engineer will allow the use of traffic cones only in the daytime. Ensure cones remain upright, in place, and do not interfere with traffic. If necessary, double-stack or weight the cones, without creating a hazard to traffic.

Use plastic drums with attached lights at night. Provide one Type D warning light on each plastic drum. Fasten the warning light to the top of the drum in accordance with subsection [922.07](#). Stand the plastic drums upright and stabilize them with weight to prevent overturning. Do not mount signs on drums.

6. **42-inch Channelizing Devices.** Provide and install 42-inch high, retro-reflective plastic channelizing devices as shown on the plans, or directed by the Engineer.

a. **Daytime Use.** The Department will allow the daytime use of 42-inch channelizing devices for the following:

- i. Pavement marking, chip seal, microsurface, and crack-filling projects;
- ii. Projects of any duration where the use of plastic drums restricts proposed lane widths to less than 11 feet, including shy distance; or
- iii. Operations of 12 hours or less.

The Department will allow the daytime use of 42-inch channelizing devices on tapers or tangents provided the distance between devices in feet is no greater than 1 times the work zone speed limit in mph in the tapers and 2 times the work zone speed limit in mph in the tangents.

b. **Nighttime Use.** The Department will allow the nighttime use of 42-inch channelizing devices, in the tangent area only, on CPM pavement marking of any duration where the use of plastic drums restricts proposed lane widths to less than 11 feet, including shy distance. Place the devices a maximum distance of 50 feet apart. Do not attach lights.

Place lighted plastic drums in the taper area, ensuring the device spacing does not exceed 1 times the work zone speed limit.

7. **Lighted Arrows.** If closing lanes, place a Type C lighted arrow on the shoulder at the beginning of the channelizing device taper. Ensure a bottom height of at least 7 feet for Type C panels. For narrow or non-existent shoulders, place the lighted arrow panel behind the channelizing devices as near the beginning of the taper



as physically possible. Place the lighted arrow panel level and visible to oncoming traffic.

Ensure the arrow remains clearly legible at distances from 2,500 feet to 200 feet, from all traffic lanes and roadway entrances. Do not place the lighted arrow on a horizontal or vertical curve that might interfere with this legibility requirement. The Engineer will verify the legibility distances on a sunny day and a clear night.

If the lighted arrow is in use, secure the tires on the ground with wheel chocks, or elevate the trailer with the bottom of the tires above the ground. If the lighted arrow is not in use, park the device in accordance with subsection [812.03.G.5](#).

If the contract includes Type C lighted arrows, standby as a pay item, make a lighted arrow available for immediate use as a replacement unit. Locate the standby lighted arrow at the project or at a location approved by the Engineer.

8. **Type III Barricade.** Use Type III barricades to accentuate delineation or warning, and for total or partial road closures. For complete road closures, extend the barricades, with no gaps, across the roadway and shoulders, or from curb to curb.

Light Type III barricades during hours of darkness with two, Type C or Type D warning lights, fastened to the uprights above the top rail, provided these warning lights each weigh 3.3 pounds or less. Place construction signs, at the Type III barricades, behind the barricades on independent supports. Place the bottom of the signs above the top rail of the barricade. Ensure stripes on the retro-reflective sheeting slope downward in the direction of traffic. Place sheeting on both sides of Type III barricades if traffic approaches the barricade from both directions.

Do not place Type III barricades parallel to approaching traffic.

If through traffic is prohibited, use Type III barricades, including the required construction signs and lights. Arrange barricades and erect signs to allow the passage of local traffic and discourage through traffic. Install a sign with the required legend concerning permissible use by local traffic only.

9. **Temporary Concrete Barrier.** Place temporary concrete barriers before diverting traffic, or beginning work. Provide clean barriers, in sound structural condition. If placing temporary concrete barrier sections on the pavement, clean the pavement of any material that would reduce the friction between the barrier section and the

underlying pavement. During barrier installation, protect traffic by using or installing standard warning and channelizing devices. After placing end treatment, place barriers in the direction of the flow of traffic. Remove barriers in the direction opposite to traffic flow.

Link sections together, and pull barrier sections to fully engage the connection between sections. Ensure the gap between barrier sections, with the end-attachments fully engaged, does not exceed 4 inches. Maintain the barrier with end-attachments engaged and within 2 inches of the alignment shown on the plans.

Install Type B high intensity lights on temporary concrete barriers in accordance with Standard Plan R-126 Series.

If incomplete concrete barrier installations or removals expose barrier blunt ends to traffic inside the clear zone for more than 8 hours, make these ends crashworthy in accordance with Standard Plan R-126 Series, or as directed by the Engineer.

Install barrier reflector markers on the temporary concrete barrier. Remove dirt and other material that could diminish adhesion from the barrier before installing the reflectors. Install reflectors using the manufacturer's recommended adhesive and installation procedures. Install the reflector near the center of the barrier section and at a height of 18 inches  $\pm$ 1 inch from the bottom of the barrier section to the top of the reflector. Provide a maximum longitudinal spacing of 20 feet. Ensure the color of the reflector matches the color of the edgeline pavement marking in that location.

If relocating or adjusting temporary concrete barrier, leave the existing reflector markers on concrete barrier intact if they are undamaged and the color is as required. If the reflector color is not as required, replace with the correct color reflector. Clean barrier reflector markers before placing the barrier back in operation.

Replace temporary concrete barrier sections structurally damaged during handling or by traffic. Repair non-structural damage that affects the performance of the section, using Department-approved concrete or mortar mix, if directed by the Engineer.

Remove and replace damaged barrier reflector markers. Position replacement markers directly in front of the damaged marker.

10. **Temporary Concrete Barrier Ending.** Place the temporary concrete barrier ending in accordance with Standard Plan R-126 Series and this subsection. Repair or replace damage to temporary concrete barrier endings.

- a. **Detail 1.** Place the sloped temporary concrete barrier ending section as required for temporary concrete barrier placement.
- b. **Detail 2.** Install impact attenuation systems in accordance with the manufacturer's specifications. Do not use a sloped end section in combination with a Detail 2 ending.

Install sand module attenuator components as shown on Standard Plan WZD-175 Series. Install sand module attenuators as shown on the plans, as directed by the Engineer, or both.

Place attenuation systems on concrete, HMA, or compacted aggregate surface in accordance with the manufacturer's specifications. If the required base does not exist, construct the base pad, foundation, anchor block, and backup unit in accordance with the manufacturer's specifications. Install the unit and connect to the backup and the front anchoring system as required.

Provide and install an object marker as shown on Standard Plan WZD-150 Series. Do not attach unapproved appurtenances to the attenuator.

Ensure an individual trained by the manufacturer in the installation of impact attenuator systems, is present during attenuator installation. The Department will not provide this individual.

Install the following in accordance with the manufacturer's specifications:

- i. Attenuator transition assemblies,
- ii. Transition panels,
- iii. End panels, and
- iv. Other miscellaneous accessories required for connecting the attenuator to concrete barriers.

Provide written certification to the Engineer verifying attenuator installation as shown on the plans, and in accordance with the manufacturer's specifications.

If using temporary anchors in new or existing pavement, remove anchors to at least 1 inch below final pavement grade and backfill with an epoxy material approved by the Engineer. For temporary anchors in temporary pavement, remove temporary anchors flush with the paved surface.

If concrete pads contain steel reinforcement, use equipment capable of drilling or coring through steel reinforcement to obtain the required depth for the concrete anchors.

Place cable anchorages and backups to meet the required attenuator alignment.

If the Engineer directs the replacement, repair, or realignment of attenuators, respond within 24 hours. If the Contractor fails to respond, or fails to complete repair work within 48 hours after notification, the Engineer may assign the work to others at the Contractor's expense.

- c. **Detail 3.** Ensure the temporary concrete barrier sections that extend past, and make contact with existing guardrail, are standard, full height sections. Do not use a sloped end section in combination with a Detail 3 ending.
- d. **Detail 4.** Install Detail 4 endings in accordance with subsection [812.03.D.10.b](#) and this subsection.

Refer to Standard Plan R-126 Series, Detail 4 to determine the offset between the toe of the existing concrete barrier wall and the attenuator.

Do not use a sloped end section in combination with a Detail 4 ending.

- e. **Detail 5.** Install Detail 5 endings in accordance with subsection [812.03.D.10.b](#) and this subsection.

Use an NCHRP 350, Test Level 3, or MASH accepted attenuation system.

Do not use a sloped end section in combination with a Detail 5 ending.

- 11. **Temporary Pavement Marking.** The requirements for placing temporary pavement markings differ depending on the situation involved.

Place 4-foot dashes spaced 50 feet apart, from center-to-center of the markings, when temporary pavement markings are placed in the configuration of permanent markings and traffic is driving in its normal lanes. However, place solid markings, not 4-foot dashes, to temporarily mark a solid edgeline.

When temporary pavement markings are used to facilitate traffic shifts or when used to delineate traffic in other than its normal lanes,

or both, place markings in the same configuration as permanent markings in accordance with section [811](#). However, the Contractor may substitute 4-inch wide markings where 6-inch wide markings are called for and 8-inch wide markings where 12-inch wide markings are called for. Place solid lines where solid line permanent markings are called for. Place skip or dotted lines at the normal length and with the normal gap.

- a. **Temporary Pavement Marking – Type R.** Use temporary pavement marking Type R (removable tape) when temporary pavement markings must be placed on finished pavements and are not in the exact location as future permanent markings or at the discretion of the Engineer when temporary markings must be removed during the life of a project. Select Type R markings from the Qualified Products List.

Replace Type R tape that fails, as directed by the Engineer, at no additional cost to the Department.

When Type R tape is used as a 4-foot dash to temporarily mark finished pavement prior to the placement of permanent markings, offset it one foot from the permanent marking so that the permanent markings can be placed prior to the removal of the 4-foot dashes. Do not use 4-foot dashes to temporarily mark a solid edgeline.

Between April 15 and November 1, place Type R tape not used as a 4-foot dash according to the manufacturer's specifications for existing temperature and pavement condition. Use temporary pavement marking Type NR when temporary pavement marking must be placed between November 1 and April 15, or if the removal of the temporary marking will occur after December 1.

- b. **Temporary Pavement Marking – Type NR.** Use temporary pavement marking Type NR (tape or paint) when temporary pavement markings must be placed on pavement to be removed or replaced during construction or when temporary markings line up exactly with the placement of permanent markings and the temporary pavement marking material is compatible with the material specified for the permanent markings. Select Type NR markings from the Qualified Products List.

Place Type NR markings in accordance with section [811](#).

Place Type NR markings, used as a 4-foot dash to temporarily mark finished pavement prior to the placement of permanent

markings, in the exact location as the permanent marking such that its removal is not necessary. Only use Type NR markings compatible with the permanent pavement marking material specified on the project as a 4-foot dash. Do not use 4-foot dashes to temporarily mark a solid edgeline.

- c. **Temporary Raised Pavement Markings.** Select temporary raised pavement markers (TRPM) from the Qualified Products List.

Remove TRPM before applying subsequent layers of HMA or if they are no longer in the proper configuration for the associated pavement markings in use.

Install TRPM – Type 1, in accordance with the manufacturer's specifications, on chip seal projects.

Install TRPM – Type 3, in accordance with the manufacturer's specifications, to supplement Type R or Type NR temporary pavement marking as directed by the Engineer on the following:

- i. Tangent sections,
- ii. Traffic transitions,
- iii. Run-arounds, and
- iv. Crossovers.

12. **Pavement Marking Cover.** Provide and install temporary pavement marking cover, Type R, preformed black or gray tape, to cover existing pavement markings, as shown on the plans or directed by the Engineer. Use black pavement marking cover on HMA pavement, and gray pavement marking cover on portland cement concrete (PCC) pavement, in accordance with manufacturer's specifications. Do not use heat, solvents, or other additional adhesive to install pavement marking cover.

Ensure the tape completely masks the existing marking.

Replace pavement marking covers that come loose, or that do not meet contract requirements, as directed by the Engineer, and at no additional cost to the Department.

13. **Temporary Traffic Signals.** At least 14 days before starting construction on temporary traffic signals, contact the utility company and apply for temporary electric service. Provide electric service on the project and arrange for electric service removal when the project is complete.

Ground equipment with a resistance no greater than 10 ohms.

Perform work on signals in accordance with the contract, and to the requirements of the National Electrical Safety Code, the NEC, and the MDLEG for those items not identified in the contract.

Use signal lamps with brass bases in accordance with ITE Standards.

Use the type of traffic signal controller shown on the plans. Before using a traffic signal controller other than as shown on the plans, obtain the Engineer's approval. Provide the Engineer-approved, alternate controller at no additional cost to the Department.

Provide, install, operate, inspect, maintain, disconnect, cover, and remove temporary traffic signals, and the required equipment and materials. Provide electric service equipment and the required wiring between the secondary service terminal, provided by the utility company, and the signal controller.

Place hoods over, or cover, signals until they are placed in service.

Install the required traffic signal timing for operating the temporary traffic signals.

Adjust traffic signal timing, as directed by the Engineer, to ensure the temporary traffic signal is operational. If the Engineer requires traffic signal timing changes, the Engineer will provide the locations and a signal-timing permit, for implementing the approved timing changes.

Maintain traffic signals installed or modified for construction for the duration of the project to ensure the signals perform as required. Disconnect and cover the signals when closing the roadway to traffic, as directed by the Engineer. Remove the temporary signals at the end of the contract.

Test equipment in operation, as a complete installation. Include sequence of operation, continuity, voltage, and ground resistance readings. Provide results of these tests to the Engineer before placing the installation into service.

Notify the Engineer before placing traffic signal installations in service.

The Department will not allow the substitution of a portable traffic signal system where temporary traffic signals are required.

14. **Temporary Portable Traffic Signal (PTS) System.** Provide the temporary portable traffic signal (PTS) system as shown on the plans. Each PTS system consists of two trailer-mounted, solar powered portable traffic signals with battery back-up.

Provide, install, program, and activate the signal system at the initial location. Provide hardware or radio communication. Operate, inspect, maintain, clean, relocate, reactivate, reprogram, and remove the PTS system from the project.

Check the PTS system for required operation at 12-hour intervals when in use on the project. If PTS system failure occurs, provide traffic regulators to control traffic until the PTS system is operational. If the PTS system fails a second time within 30 calendar days of the first failure, remove the PTS system from the project and provide traffic regulators until the replacement PTS system is installed, activated, and operating as required.

The Contractor is responsible for repair or replacement of the PTS system.

Locate one system trailer on each end of the closure, on the shoulder, outside the travel lane. After positioning the trailer, rest the tires on the ground with wheel chocks or elevate the trailer, with the bottom of the tires above the ground. Delineate each trailer using three plastic drums wrapped with high intensity reflective sheeting.

If existing guardrail prevents a trailer from sitting completely on the shoulder, place PTS system in accordance with subsection [812.03.D.14.a](#) and subsection [812.03.D.14.b](#).

- a. **Open Lane Approach Side.** On the open lane approach side, if existing guardrail prevents the trailer from sitting completely on the shoulder, complete the following:
  - i. Remove one panel of guardrail at the required PTS trailer location, at least 100 feet from the end of the temporary concrete barrier.
  - ii. Slide the PTS trailer into the gap so the left tire is on the shoulder and the signal does not encroach into the open lane.
  - iii. Place an ET Type or SKT Type extruder ending on both blunt guardrail ends.
  - iv. After removing trailers, restore the guardrail to the original condition in accordance with section [807](#).
- b. **Closed Lane Approach Side.** On the closed lane approach side if existing guardrail prevents the trailer from sitting completely on the shoulder, complete the following:
  - i. Remove one extra guardrail panel where the temporary concrete barrier runs through the guardrail.



- ii. Slide the PTS trailer into the extra opening in front of the temporary concrete barrier where it runs through the guardrail so the left tire is on the shoulder and the signal does not encroach into the open lane.
  - iii. After removing trailers, restore the guardrail to the original condition in accordance with section [807](#).
  - iv. No extruder ending is required on the closed lane approach side.
15. **Portable Changeable Message Signs.** Use portable changeable message signs (PCMS) as required. Delineate a deployed PCMS using three lighted plastic drums wrapped with high intensity reflective sheeting. Set lights to flash mode. If the PCMS is in use, rest the tires on the ground with wheel chocks or elevate the trailer, with the bottom of the tires above the ground. If a PCMS is not needed, turn it off and remove it from the immediate traffic area in accordance with subsection [812.03.G.5](#).

The Department will allow use of PCMS for either advance time notification for future events including closures and planned maintenance work or information including detours or alternative routes during current events; incident management; construction zone backups; or similar conditions.

Do not use generic, non-emergency safety messages. If power to the PCMS is lost, use the message "Drive Safely" only as a default message. Ensure message sequences consist of no greater than two messages with a 2-second display time for each message.

Do not use PCMS for the following:

- a. Replacing [MMUTCD](#) required static signing or pavement markings;
  - b. Replacing a lighted arrow;
  - c. Advance notice of new traffic signals or signs; or
  - d. Advertising.
- E. **Sign Removal (Permanent Signs).**
- 1. **Department-owned Permanent Signs.** Remove Department-owned permanent signs and supports as necessary to prevent damage. Remove, handle, store, and reinstall the signs in accordance with Department and manufacturer's requirements. Store the permanent signs outside the work area at a site within the CIA, as directed by the Engineer. Reinstall Department-owned permanent signs and supports within one day of completing the

work, in accordance with section [810](#), unless otherwise directed by the Engineer,

Replace signs, supports, or foundations, damaged by Contractor operations at no additional cost to the Department.

2. **Permanent Signs Owned by Local Agencies.** Remove locally owned signs and supports before starting work in the area. Remove, handle, and store signs in accordance with the manufacturer's requirements. Store the permanent signs outside the work area within the CIA, as directed by the Engineer. The local agency that owns the sign is responsible for sign and support replacement and related costs.
3. **Logo Signs or Tourist Oriented Directional Signs.** Date stickers on the back of the signs identify Logo Signs and Tourist Oriented Directional Signs. Contact Michigan Logos, Inc. at (888) 645-6476 to arrange for removal, storage, and reinstallation of Logo Signs or Tourist Oriented Directional Signs within the CIA. Provide Michigan Logos, Inc. with at least two weeks notice.

F. **Pavement Marking Removal.** Remove pavement markings that conflict with proposed temporary traffic markings before making any changes in the traffic pattern. Place temporary pavement markings when removing or obscuring pavement markings for more than 24 hours before a change in the traffic pattern. Place Type R markings in accordance with subsection [812.03.D.11](#) before the close of the workday.

Do not use paint or bituminous bond coat to cover existing and inappropriate pavement markings. The Contractor may use tape only when authorized by the Engineer.

Use a vacuum attachment operating concurrently with the blast cleaning operation to remove residue and dust when removing markings by blast cleaning within 10 feet of an open lane. Properly dispose of collected residue and dust.

1. **Removal of Less than 5,000 Feet of Pavement Markings per Stage.** Obtain the Engineer's approval for one of the following removal methods and minimize damage to the surface texture of the pavement during removal.

Use one or more of the following removal methods:

- a. Sandblasting using air or water;
- b. Shot blasting;
- c. High-pressure water;

- d. Steam or superheated water; or
- e. Mechanical devices such as grinders, sanders, scrapers, scarifiers, and wire brushes.

Immediately clean up any debris generated. The Department will not require continuous vacuuming equipment for pavement marking removal of less than 5,000 feet per stage.

2. **Removal of Greater than 5,000 Feet of Pavement Markings per Stage.** Remove pavement markings using self-propelled truck mounted removal equipment. The equipment must be capable of continuously vacuuming up the removal debris. If the removal equipment cannot collect all removal debris, operate a self-propelled sweeper immediately behind the removal equipment.

Obtain the Engineer's approval for one of the following removal methods and minimize damage to the surface texture of the pavement during removal:

- a. Use self-propelled truck mounted removal equipment, except do not use water blasting for marking removal on asphalt pavement;
- b. Use self-propelled truck mounted removal equipment for marking removal on concrete surfaces to be removed during construction; or
- c. Use a self-propelled truck mounted water blaster for marking removal on concrete surfaces to remain in place.

**G. Maintaining Traffic Along Project.** Maintain traffic along the project in a safe and orderly manner.

1. **Traffic Maintained by Part-Width Intersection Construction.** If part-width construction is required, construct the new pavement on half an intersection at a time. Maintain through traffic on the remaining half intersection and shoulders. The contract may require temporary widening and surfacing of the shoulders.
2. **Access Provisions for Pedestrians and Local Traffic.** Use temporary roadways, culverts, railroad crossings, bridges, and other means approved by the Engineer to provide local traffic access to property adjacent to the project. Obtain the Engineer's approval for temporary culvert material, before placement. Provide railroad crossings for local traffic in accordance with subsection [107.20](#).

Use pavement gaps or other means approved by the Engineer to maintain two-way traffic across intersections. Provide a clear roadway on the cross road, at least 20 feet wide. The Engineer may

vary the pavement gap lengths based on the types of vehicles passing through the intersection.

The Engineer may allow closing a minor road or street intersection, with the approval of the local government agency.

Maintain pedestrian mobility within the CIA, as required by the contract. If access cannot be accommodated, provide temporary modifications or a clearly marked detour.

3. **Traffic Maintained on Shoulder.** If the contract requires maintenance of traffic on the shoulder, improve the shoulder as shown on the plans.

Sweep shoulder and remove debris throughout the time the shoulder is used to maintain traffic. Properly dispose of collected debris.

Maintain the shoulder as required. Ensure the availability of labor, material, and equipment to immediately repair and reconstruct the shoulder. Apply surfacing material and dust palliatives as directed by the Engineer.

4. **Shoulders Under Construction.** Ensure shoulder areas adjacent to open traffic lanes are in a safe and usable condition during non-working hours. Provide the following signs and channelizing devices:
  - a. Install one W21-5, 48 inch by 48 inch "Shoulder Work" sign before the beginning of the unsatisfactory shoulder.
  - b. Install the relevant W8-9a "Shoulder Drop-Off," W8-4 "Soft Shoulder," or W8-4a "Rough Shoulder" signs before the unsatisfactory shoulder and at no greater than 2,000-foot intervals along the non-compliant shoulder.
  - c. Place plastic drums on the taper, as required by [MMUTCD](#), Part 6, for shoulder closures, at the location where the unsatisfactory shoulder begins.
  - d. Place channelizing devices at intervals directed by the Engineer along the length of the affected shoulder without encroaching on the required minimum lane width. Place the bases of channelizing devices at the same height as the travel lane.
5. **Storage Restrictions for Vehicles, Equipment, and Materials.** Park vehicles and store material in areas that provide minimum exposure to pedestrian and vehicular traffic.
  - a. **Working Hours.** During working hours, park workers' vehicles, idle construction equipment, and stored materials that cannot be removed from the project as follows:

- i. At least 20 feet behind curb faces on roadways with barrier curb; and
  - ii. At least 30 feet from the pavement edge on roadways with shoulders or mountable curbs.
- b. **Non-working Hours.** During non-working hours, remove workers' vehicles, and obtain the Engineer's approval to store idle construction equipment and materials that cannot be removed from the project as follows:
- i. At least 30 feet from the traffic lanes, if topography and right of way allow; or
  - ii. Less than 30 feet from the traffic lanes if delineated by signs, lights, barricades, or concrete barriers.

The Department will not make additional payment for devices used to delineate stored equipment and material.

6. **Maintaining Lights.** Do not mix different light styles or designs on a project.

Position and maintain Type A, Type C, and Type D lights to ensure visibility on a clear night from a distance of 3,000 feet. Ensure the visibility of Type B, high intensity lights on a sunny day from a distance of 1,000 feet when the sun is not directly on or behind the light. Replace the power source if lights do not meet the visibility requirements. Provide and maintain Type C and Type D LED lights that at least meet the requirements in the [MMUTCD](#) and maintain the intensity requirement of 2 candelas in the field.

Ensure lights work at the time of initial installation and at stage changes during the project. During the project, ensure at least 95 percent of the total number of active lights, work. Ensure that no more than three adjacent lights are non-operational at any time.

Change power sources when directed by the Engineer. Replace damaged or non-functioning lights at no additional cost to the Department.

7. **Cleaning Traffic Control Devices.** Clean barrier reflectors, plastic drums, signs, barricades, and attached lights in operation on the project to ensure they meet required luminosity. Adjust cleaning frequency based on the exposure of the traffic control devices to unfavorable environmental conditions and the dirt accumulated on the devices.
8. **Traffic Regulators.** Provide traffic regulators for each direction of approaching traffic on primary and intermediate roads, if the

movement of traffic is restricted to alternating one-way traffic through the construction area. The Engineer may require intermediate traffic regulators.

Equip traffic regulators with the following:

- a. High-visibility safety apparel;
- b. "Stop/Slow" or "Stop/Stop" sign paddles; and
- c. A two-way radio system and a standby back-up system, if traffic regulators are not visible to each other.

Notify and advise traffic regulators of information required to maintain traffic. Illuminate traffic regulator stations at night with an average luminance of 50 lux.

Provide traffic regulators and other traffic control devices, as approved by the Engineer, to move materials and equipment that may interfere with traffic. The Department will not make additional payment for providing traffic regulators and other traffic control devices necessary only for the Contractor's convenience.

Ensure persons designated to regulate traffic receive training, no more than 12 months before performing traffic-regulating operations, on proper traffic regulating procedures. Ensure this training consists of at least viewing the video "Safely Regulating Traffic in Michigan" and reading the current MDOT handbook, [Traffic Regulators Instruction Manual](#). Maintain documentation on persons trained and dates trained and provide to the Engineer upon request.

9. **Traffic Regulating Operations.** Ensure traffic regulating operations do not exceed 2 miles or stop traffic for more than 10 minutes at a time, unless otherwise directed by the Engineer.

H. **Lighting for Night Work.** Provide, install, and maintain fixed, portable, or equipment-mounted lighting systems to allow workers and inspectors to perform nighttime operations and inspections. Provide a power source capable of operating the lighting system.

Provide lighting and perform night work in accordance with subsection [706.03.1.2](#) and the contract. Submit a lighting plan to the Engineer for review and approval, before starting night work.

Provide lighting as specified in the current edition of [MMUTCD](#), Part 6. Ensure lighting does not cause glare, shine, or directly face the eyes of oncoming drivers. After initial setup, drive through and observe the lighted area from each direction on the main roadway. Adjust lighting alignment if lights cause glare, shine, or directly face the eyes of oncoming drivers.

Provide backup lighting that meets specifications for the primary system to replace failed lights and equipment during nighttime operations. Maintain the backup equipment on the project and ensure availability during nighttime operations.

The Engineer will suspend nighttime operations, except traffic control, if lighting does not meet contract requirements.

1. **Chip Seal Surface Treatment and HMA Construction.** Maintain traffic during the placement of chip seals and HMA.

1. **General.** Complete rolling and allow the surface to cool before allowing traffic on chip seal treated and HMA surfaces. If shoulders cannot be used for two-way traffic, arrange for alternating one-way traffic around the roadway section being surfaced. Provide traffic control devices and traffic regulators to keep traffic off surfaced roadway sections and to provide safe travel.

If conditions allow, and if the Engineer approves, route traffic away from sections of roadway being surfaced. Provide and maintain temporary routes in a condition approved by the Engineer, and at no additional cost to the Department.

2. **Chip Seal Surface Treatment.** Unless closing the road to traffic, treat half of the road width at a time. Do not allow traffic on the treated section of roadway for at least 30 minutes after completion of cover material application and rolling.

If shown on the plans, provide a traffic regulator to direct alternating one-way traffic in accordance with subsection [812.03.G.8](#).

3. **Aggregate Surface and HMA.** To handle traffic during aggregate surface and HMA applications, divide the project into sections. The Engineer will determine the length of these sections. Keep traffic off the work area of each section during surface preparation, bond coat application, HMA placement, and rolling. Complete each section and open it to traffic, before closing the next section. Provide local traffic access to property along the project.

During darkness, place and maintain lighted plastic drums wrapped with high intensity reflective sheeting to protect traffic. For windrow sections in the center of the travel way, install lighted plastic drums wrapped with high intensity reflective sheeting at the ends, along each side, and at the end of breaks where traffic passes through or crosses the windrow. Alternate the placement of drums along each side with no greater than 150 feet between the drums.

4. **Protection of Uncured Pavements.** Keep traffic off new HMA pavement by installing cones or drums on the tangent in addition to the traffic control devices specified in the [MMUTCD](#). Install additional cones or drums to separate the traffic lane from the closed lane and conduct paving operations in the sequences shown in the contract. After finish rolling, or as directed by the Engineer, install at least two cones across each resurfaced lane at no greater than 600 foot intervals. Place additional cones or drums at crossroads and commercial driveways to direct the traffic to open travel lanes.

After completing compaction, if the air temperature is below 70 °F, open the pavement to traffic. If the air temperature is from 70 °F to 80 °F, keep traffic off the pavement for an additional hour. If the air temperature is greater than 80 °F, keep traffic off the pavement for 2 hours.

5. **Staggered Lane Endings with Vertical Longitudinal Joints.** To avoid uneven longitudinal joints, surface lanes within one load of the same ending point at the end of the day's operation. The center lanes of two-way pavements with an odd number of lanes are excluded from this requirement.

Before starting HMA paving operations, furnish the required signs for emergency signing in case staggered lane endings, causing uneven longitudinal joints, must remain open to traffic overnight.

If uneven longitudinal joints remain open overnight, maintain traffic in accordance with the following:

- a. If the points of ending of adjacent lanes are at least 250 feet apart, install temporary signs as required; and
  - b. If the points of ending of adjacent lanes are less than 250 feet apart, install lighted drums at 30-foot intervals along the length of each side of the affected pavement, and place W21-4 "Road Work Ahead" signs ahead of the pavement area.
6. **Tapered Overlapping Longitudinal Joints.** Unless delayed by inclement weather or otherwise approved by the Engineer, do not expose the tapered overlapping longitudinal joints to traffic for longer than 24 hours after placement. If using a tapered joint, place 48 inch by 48 inch W8-9b "Uneven Lanes" signs before, and at no greater than 2,000-foot intervals along the length of, the joint before allowing traffic on the paved lane. Place at least two W8-9b "Uneven Lanes" signs in each direction. Leave these signs in place until the adjacent lane is constructed to the same elevation.



**J. Conspicuity Tape for Vehicles and Equipment in Work Zones.**  
 Equip vehicles and equipment in the work zone, and vehicles delivering materials or equipment to the project, with red and white conspicuity tape.

Apply one 2-inch wide horizontal stripe of conspicuity tape along at least 50 percent of each side of, and across the full width of the rear of the vehicle or equipment.

Delineate lighted arrow trailers and portable changeable message signs with 2 inch wide red and white conspicuity tape on each of the four sides where tape application is practical.

**812.04. Measurement and Payment.**

| <b>Pay Item</b>   | <b>Pay Unit</b> |
|---|-----------------|
| Minor Traf Devices .....  | Lump Sum        |
| Traffic Regulator Control .....   | Lump Sum        |
| Sign, Type __, Temp, Prismatic, Furn .....                                | Square Foot     |
| Sign, Type __, Temp, Prismatic, Oper .....                                | Square Foot     |
| Sign Cover .....  | Each            |
| Sign Cover, Type 1 .....  | Each            |
| Lighted Arrow, Type __, Furn .....  | Each            |
| Lighted Arrow, Type __, Oper .....  | Each            |
| Lighted Arrow, Type C, Standby .....                                      | Each            |
| Sign, Portable, Changeable Message, Furn .....                            | Each            |
| Sign, Portable, Changeable Message, Oper .....                            | Each            |
| High Intensity Light, Type B, Furn .....                                  | Each            |
| High Intensity Light, Type B, Oper .....                                  | Each            |
| Plastic Drum, High Intensity, Furn .....                                  | Each            |
| Plastic Drum, High Intensity, Oper .....                                  | Each            |
| Plastic Drum, High Intensity, Lighted, Furn .....                         | Each            |
| Plastic Drum, High Intensity, Lighted, Oper .....                         | Each            |
| Channelizing Device, 42 inch, Furn .....                                  | Each            |
| Channelizing Device, 42 inch, Oper .....                                  | Each            |
| Barricade, Type III, High Intensity, Furn .....                           | Each            |
| Barricade, Type III, High Intensity, Oper .....                           | Each            |
| Barricade, Type III, High Intensity, Lighted, Furn .....                  | Each            |
| Barricade, Type III, High Intensity, Lighted, Oper .....                  | Each            |
| Barricade, Type III, High Intensity, Double Sided, Furn .....             | Each            |
| Barricade, Type III, High Intensity, Double Sided, Oper .....             | Each            |
| Barricade, Type III, High Intensity, Double Sided,<br>Lighted, Furn ..... | Each            |
| Barricade, Type III, High Intensity, Double Sided,<br>Lighted, Oper ..... | Each            |

|   |          |
|---|----------|
| Conc Barrier, Temp, Furn.....                                   | Foot     |
| Conc Barrier, Temp, Oper .....                                  | Foot     |
| Conc Barrier, Temp, Adj.....                                    | Foot     |
| Conc Barrier, Temp, Relocated.....                              | Foot     |
| Conc Barrier Reflector Replacement.....                         | Each     |
| Conc Barrier Ending, Temp, Detail __, Furn .....                | Each     |
| Conc Barrier Ending, Temp, Detail __, Oper.....                 | Each     |
| Conc Barrier Ending, Temp, Detail __, Adj .....                 | Each     |
| Conc Barrier Ending, Temp, Detail __, Relocated .....           | Each     |
| Pavt Mrkg, Type R, 4 inch, (color), Temp.....                   | Foot     |
| Pavt Mrkg, Type NR, Tape, 4 inch, (color),Temp.....             | Foot     |
| Pavt Mrkg, Type NR, Paint, 4 inch, (color), Temp.....           | Foot     |
| Raised Pavt Marker, Temp, Type __, (color), Monodirectional.... | Each     |
| Raised Pavt Marker, Temp, Type __, (color), Bidirectional.....  | Each     |
| Pavt Mrkg, Longit, 6 inch or Less Width, Rem .....              | Foot     |
| Pavt Mrkg, Longit, Greater than 6 inch Width, Rem.....          | Foot     |
| Pavt Mrkg Cover, Type R, (color).....                           | Foot     |
| Part Width Intersection Construction.....                       | Each     |
| Dust Palliative, Applied.....                                   | Ton      |
| Culv, Temp .....  | Each     |
| TS, Temp, Furn .....  | Each     |
| TS, Temp, Oper .....  | Each     |
| PTS System, Temp, Furn .....                                    | Each     |
| PTS System, Temp, Oper .....                                    | Each     |
| Ltg for Night Work.....   | Lump Sum |

If the contract does not include pay items for improving the shoulder to maintain traffic, the Engineer will measure, and the Department will pay for shoulder improvements as extra work.

The Department will pay for additional traffic control devices if changes benefit the Department. The Department will not pay for additional devices required for the Contractor's convenience unless the Contractor can show a benefit to the Department.

**A. Damage Compensation.** Notify the Engineer of damaged temporary traffic control devices. Before replacement and disposal, allow the Engineer to verify the condition of damaged temporary traffic control devices eligible for payment. The Department will pay as follows, for replacing temporary traffic control devices or equipment damaged by vehicular traffic, other than the Contractor's vehicles and equipment, to the extent that replacement is required:

1. The **Furnished** unit price for devices paid for as furnished pay items;
2. The unit price for devices not paid for as **Furnished**;

3. The manufacturer's invoice cost for devices required by the Engineer and not included in the unit price for other relevant pay items;
4. One-third of the unit price for replacement pay items **Barricade, Type III, High Intensity** or **Barricade, Type III, High Intensity, Double Sided** required by the Engineer for each damaged board or panel;
5. The manufacturer's invoiced cost for damaged equipment included in a lump sum pay item for maintaining traffic.

**B. Cleaning Traffic Control Devices.** The unit prices for traffic control devices include the cost of cleaning traffic control devices.

**C. Furnished Pay Items.** For pay items designated as furnished, the Engineer will measure, and the Department will pay for the maximum number of units required by the Engineer at one time on the project.

The Engineer will measure **Sign, Type \_\_, Temp, Prismatic, Furn** as the total area of the maximum number of signs with dissimilar sign legends in use, at one time on the project. The unit price for **Sign Type \_\_, Temp, Prismatic, Furn** includes the cost of portable and driven sign supports.

The unit prices for furnished pay items include the cost of the following:

1. Providing the item in operable condition with required equipment, supplemental weights, hardware, and labor;
2. Initially installing the item; and
3. Replacing items damaged by vehicular traffic other than by the Contractor's vehicles or equipment.

The Department will pay for furnished pay items once per project when placed into operation, unless the Engineer approves a price adjustment for an authorized extension of time.

**D. Operated Pay Items.** For pay items designated as operated, the Engineer will measure, and the Department will pay for the maximum number of units required by the Engineer at one time on the project.

The Engineer will measure **Sign, Type \_\_, Temp, Prismatic, Oper** as the total area of the maximum number of signs with dissimilar sign legends in use, at one time on the project.

The unit prices for operated pay items, with the exception of **Conc Barrier, Temp Oper** and **TS, Temp, Oper**, include the cost of the following:

1. Operating;
2. Inspecting, and maintaining;

3. Relocating; and
4. Removing the item from the project.

**E. Minor Traffic Devices and Traffic Regulator Control.** The Department will make partial payments for **Minor Traf Devices** and **Traf Regulator Control** in accordance with Table 812-1. The Department will not allow claims for additional compensation for inconvenience or delay caused by Department-performed routine maintenance operations.

| <b>Partial Payment Schedule for Minor Traffic Devices and Traffic Regulator Control</b> |   |
|---|---|
| <b>Percent of Original Contract Amount Earned</b>                                       | <b>Total Percent of Unit Price Paid</b> |
| First Use   | 50                                      |
| 50  | 75                                      |
| 90  | 100                                     |

1. **Minor Traffic Devices.** The unit price for **Minor Traf Devices** includes the cost of the following:
  - a. Providing, installing, maintaining, relocating, and removing traffic cones and other traffic devices, not shown on the plans;
  - b. Maintaining local traffic;
  - c. Removing, storing, and reinstalling Department-owned permanent signs and supports; and
  - d. Installing reflective conspicuity tape on vehicles and equipment.
2. **Traffic Regulator Control.** The unit price for **Traf Regulator Control** includes the cost of the following:
  - a. Providing personnel;
  - b. Providing and operating equipment; and
  - c. Providing traffic regulator training in accordance with subsection [812.03.G.8.](#)

**F. Temporary Roadway and Approaches.** The Department will pay separately for constructing and maintaining temporary roadways and approaches using the following relevant pay items:

1. Earth excavation,
2. Temporary culverts,
3. Temporary structures,
4. Temporary traffic control device,
5. Surfacing material, and
6. Dust palliatives.

**G. Sign Cover.** The Department will pay for the maximum number of sign covers required, at one time on the project. The unit price for **Sign**

**Cover** includes the cost of furnishing, installing, removing, and relocating the sign covers.

The Engineer will only measure approved materials and hardware for payment.

The unit price for **Sign Cover, Type I** includes the cost of providing shop drawings, fabricating, furnishing, installing, removing, and relocating sign covers.

H. **Lighted Arrow, Type C, Standby.** The Department will pay for **Lighted Arrow, Type C, Standby** only if the pay item is shown on the plans. The cost of providing a fully operable unit and placing it on standby, readily available to replace a damaged unit, is included in the unit price for **Lighted Arrow, Type C, Standby**. The Department will only pay once for the standby unit during the project.

The Department will allow the use of the standby unit to replace a unit removed from service for maintenance, but will not pay for replacing the standby unit.

I. **Sign, Portable, Changeable Message, Operated.** The unit price for **Sign, Portable, Changeable Message, Oper** includes the cost of programming and operating the signs in accordance with subsection [812.04.E](#). The Department will pay separately for the cost of delineating each trailer with three plastic drums as **Plastic Drums, High Intensity, Lighted, Furn** and **Plastic Drums, High Intensity, Lighted, Oper**.

J. **Plastic Drums, High Intensity, Lighted, Furnished.** The unit price for **Plastic Drums, High Intensity, Lighted, Furn** includes the cost of providing and installing drums, each with supplemental weights and one Type D light.

K. **Barricade, Type III, High Intensity, Lighted, Furnished and Barricade, Type III, High Intensity, Double Sided, Lighted, Furnished.** The unit prices for **Barricade, Type III, High Intensity, Lighted, Furn**, and **Barricade, Type III, High Intensity, Double Sided, Lighted, Furn** include the cost of providing and installing barricades, each with supplemental weights, and two Type C or Type D lights.

L. **Concrete Barrier, Temporary.**

1. **Furnish Barrier.** The unit price for **Conc Barrier, Temp, Furn** includes the cost of providing and installing concrete barriers in the initial location with barrier reflector markers attached.

The Engineer will measure and the Department will pay for providing and installing one **Type B High Intensity Light, Furn** and

one **Type B High Intensity Light, Oper** on the concrete barrier approaching taper or tangent breakpoint, as shown on in the plans or Standard Plan R-126 Series.

2. **Operate Barrier.** The unit price for **Conc Barrier, Temp, Oper** includes the cost of operating, maintaining, and removing concrete barrier from the project.
3. **Adjust Barrier.** The unit price for **Conc Barrier, Temp, Adj** includes the cost of moving the temporary concrete barrier and tapers, including barriers and tapers located outside the roadbed, laterally to a new alignment on the same roadbed.
4. **Relocate Barrier.** The Engineer will not measure a temporary concrete barrier move as **Conc Barrier, Temp, Relocated** if it involves work defined in subsection [812.04.L.3](#).

The unit price for **Conc Barrier, Temp, Relocated**, includes the cost of relocating temporary concrete barrier longitudinally on the same roadbed, or to another roadbed, including temporarily storing the barrier. Temporary storage of the barrier includes removing, loading and hauling the barrier to a temporary storage site followed by reloading, hauling, and re-installation in the new location.

5. **Barrier Reflector Replacement.** The unit price for **Conc Barrier Reflector Replacement** includes the cost of removing damaged markers from temporary concrete barrier sections after initial placement, and providing and installing new barrier reflectors.
- M. Temporary Concrete Barrier Ending.** The Engineer will measure and the Department will pay for temporary concrete barrier endings specified for Detail 1 and Detail 3 as **Conc Barrier, Temp**. The Department will pay for removing and reconstructing guardrail required for Detail 3 in accordance with section [807](#).

The Engineer will measure, and the Department will pay for temporary concrete barrier endings specified for Detail 2, Detail 4, and Detail 5 in accordance with subsection [812.04.M.1](#) through subsection [812.04.M.4](#).

1. **Furnish Barrier Ending.** The unit price for **Conc Barrier Ending, Temp, Furn** includes the cost of the following:
  - a. Providing and delivering attenuators to the project as shown on the plans, or directed by the Engineer;
  - b. Constructing attenuator base pads, foundations, anchor blocks, and backup units;
  - c. Installing the hardware, appurtenances, and attenuators;

- d. Connect the unit to the backup and to the front anchoring system;
  - e. Providing and installing transition assemblies, transition panels, end panels, and other miscellaneous accessories for connecting to concrete barrier;
  - f. Ensuring an individual, trained by the manufacturer in the installation of impact attenuator systems, is present during attenuator installation; and
  - g. Providing and installing an object marker to the nose of the attenuator.
2. **Operate Barrier Ending.** The unit price for **Conc Barrier Ending, Temp, Oper** includes the cost of the following:
- a. Repairing the attenuator during construction;
  - b. Removing the attenuator from the existing location;
  - c. Removing attenuator base pads, foundations, anchor blocks and backups units from the existing location;
  - d. Constructing new attenuator base pads, foundations, anchor blocks, and backups at the new location;
  - e. Transporting and reinstalling the attenuator in accordance with the manufacturer's specifications at the new location;
  - f. Ensuring an individual trained by the manufacturer in the installation of impact attenuator systems, is present during attenuator installation;
  - g. Removing and disposing of the attenuators; and
  - h. Removing and disposing of attenuator base pads, foundations, anchor blocks, backups, and associated hardware.
3. **Adjust Barrier Ending.** The unit price for **Conc Barrier Ending, Temp, Adj** includes the cost of moving the temporary concrete barrier ending, including those located outside the roadbed, laterally to a new alignment on the same roadbed.
4. **Relocate Barrier Ending.** The unit price for **Conc Barrier Ending, Temp, Relocated** includes the cost of moving temporary concrete barrier longitudinally on the same roadbed, or to another roadbed including temporarily storing the barrier ending. Temporary storage of the barrier endings includes removing, loading and hauling the endings to a temporary storage site followed by reloading, hauling, and re-installation in the new location.
- N. **Temporary Pavement Markings.**
- 1. **General.** The Department will pay for the removal of longitudinal markings as **Pavt Mrkg, Longit, Rem**, of the width required. The

unit prices for **Pavt Mrkg, Longit, Rem** pay items include the cost of removing existing longitudinal permanent markings and temporary Type NR markings, including tapers, and transitions.

The Department will pay for removing special markings as **Rem Spec Mrkg**, in accordance with subsection [811.04.D](#).

The Engineer will measure temporary pavement markings, of the type required, as the actual length of equivalent 4-inch line placed. The Engineer will not measure the skips in dashed lines regardless of the type or width of markings.

The Department will not pay separately for removing markings that do not meet the requirements of subsection [922.06](#).

2. **Non-Removable (Type NR) Pavement Markings.** The unit price for the relevant **Pavt Mrkg, Temp, NR** pay items include the cost of providing and placing temporary pavement markings.
  3. **Removable (Type R) Pavement Markings.** The unit prices for **Pavt Mrkg, Type R, 4 inch, (color), Temp** and **Pavt Mrkg Cover, Type R, (color)** include the cost of providing, placing, removing and disposing of temporary pavement marking.
  4. **Temporary Raised Pavement Markers.** The unit prices for **Raised, Pavt Marker, Temp** pay items include the cost of providing, installing, maintaining, removing and disposing of raised pavement markers.
- O. **Part Width Intersection Construction.** The Engineer will measure, and the Department will pay for **Part Width Intersection Construction** by the number of intersections required by the contract. The Engineer will measure intersections as one unit regardless of the number of legs or the number of construction stages.

The unit price for **Part Width Intersection Construction** includes the cost of providing additional temporary traffic control measures and operations specified for the work performed in the intersection.

The Department will pay separately for earth excavation, temporary traffic control devices, surfacing materials, and dust palliatives for the construction and maintenance of temporary roadways required for part width intersection construction.

P. **Dust Palliative.** The Engineer will measure, and the Department will pay for **Dust Palliative, Applied** by weight of calcium chloride, based on the concentration of solids or solution delivered, as indicated on the delivery report or as determined by testing.



The Engineer will not measure additives combined with the gravel before, or at the time of gravel surface placement for payment as **Dust Palliative, Applied**.

**Q. Culvert, Temporary.** The unit price for **Culv, Temp** includes the cost of constructing and maintaining temporary culverts, and removing them before project completion.

**R. Traffic Signal (TS), Temporary.** The Department will reimburse the Contractor, based on paid utility company invoices, for the cost to provide secondary service on the project. Reimbursable costs include the cost of installing and removing wood poles, wiring, transformers, and electricity for the signals.

A signal system required to maintain one lane of traffic on a bi-directional roadway is considered one location.

The unit price for **TS, Temp, Furn** includes the cost of providing and installing all components required to provide a complete and operating unit, per location shown on the plans.

The unit price for **TS, Temp, Oper** includes the cost of the following for each temporary traffic signal within the project limits:

1. Operating, including signal timing changes directed by the Engineer;
2. Inspecting;
3. Maintaining;
4. Disconnecting;
5. Covering; and
6. Removing the temporary traffic signals.

**S. Portable Traffic Signal (PTS) System.** The Department will not make additional payments for traffic regulating, signing arrow boards, and lighting systems for traffic regulator stations operated at night due to a temporary PTS system failure.

**1. Furnish PTS System.** The unit price for **PTS System, Temp, Furn** includes the cost of the following:

- a. Providing, installing, programming, and activating temporary PTS systems in the initial required location;
- b. Two trailer-mounted, solar powered portable traffic signals with battery back-up;
- c. Radio linked communications with hardwire capabilities and conflict monitoring; and
- d. Removing or modifying guardrail to place trailers.

2. **Operate PTS System.** The unit price for **PTS System, Temp, Oper** includes the cost of the following:
- a. Operating;
  - b. Inspecting, and maintaining;
  - c. Delineating with conspicuity tape;
  - d. Relocating, reactivating, and reprogramming;
  - e. Removing the system from the project;
  - f. Removing or modifying guardrail; and
  - g. Replacing guardrail.

The Department will pay separately for the cost of delineating each PTS trailer with three plastic drums as **Plastic Drums, High Intensity, Furn** and **Plastic Drums, High Intensity, Oper**.

T. **Lighting for Night Work.** The unit price for **Ltg for Night Work** includes the cost of submitting a lighting plan and providing, installing and maintaining lighting for the entire project. The Department will not make adjustments in the lump sum price, regardless of the number or type of lighting systems required to complete night work in accordance with subsection [812.03.H](#), and as directed by the Engineer.

U. **Price Adjustments for Authorized Extensions of Time.** The Department will not adjust the unit price for **TS, Temp, Furn** for authorized extensions of time.

The Department will not make price adjustments for temporary traffic control devices during authorized extensions of time if liquidated damages are assessed in accordance with subsection [108.07](#) and subsection [108.08](#). If liquidated damages are not assessed, the Department will adjust unit prices for the following:

1. **TS, Temp, Oper;**
2. **PTS System, Temp, Oper;**
3. Items designated as Furnished, Operated, or Standby, unless otherwise specified; and
4. Items measured as lump sum if they are used or required on the worksite during authorized extensions of time except that **Minor Traf Devices** will not be adjusted when conspicuity tape is the only minor traffic control device in service or required during the authorized extension of time.

The Department will use the following formula to calculate the unit price adjustments using either calendar or working days for both original contract time and additional days:

$$\left(\frac{a}{b}\right)c = \textit{adjustment}$$

Formula 812-1

Where:

$a$  = Additional days an item was in use or on standby during the authorized extension of time,

$b$  = Original contract time, and

$c$  = Original unit price.

If an authorized extension of time extends a work day project into the next construction season, including seasonal shutdown periods during which a traffic control item is on standby or in use, the Department will apply the following extensions. For seasonal shutdown periods, the original contract time will be the calendar days between the first work day and the expiration of the original contract completion. The Department will determine the number of additional days the item is on standby or in use in calendar days.

## Section 813. SLOPE PROTECTION

**813.01. Description.** This work consists of constructing precast and cast-in-place concrete slope paving, including plain, heavy, and grouted riprap, and associated headers.

**813.02. Materials.** Provide materials in accordance with the following:

|   |                     |
|---|---------------------|
| Concrete, Grade P2.....                   | <a href="#">601</a> |
| Mortar, Type R-3 .....                    | <a href="#">702</a> |
| Cement .....                              | <a href="#">901</a> |
| Granular Material Class II.....           | <a href="#">902</a> |
| Curing Compound .....                     | <a href="#">903</a> |
| Steel Reinforcement .....                 | <a href="#">905</a> |
| Geotextile Liner .....                    | <a href="#">910</a> |
| Precast Concrete Slope Paving Blocks..... | <a href="#">913</a> |
| Riprap .....                              | <a href="#">916</a> |
| Heavy Riprap.....                         | <a href="#">916</a> |

Provide a retarding admixture, selected from the Qualified Products List, if additional time is required between adding water to the concrete mixture, and placing the concrete, but do not exceed the manufacturer's recommended maximum initial set time.

### 813.03. Construction.

**A. Base Preparation.** Excavate or fill to the required subgrade. Compact and shape the subgrade for the following:

1. The bottom of the riprap,
2. Precast and cast-in-place concrete slope paving, or
3. The bottom of the granular material layer.

Dispose of the surplus excavated subgrade material in accordance with subsection [205.03.P](#). Trim the subgrade to the Class A slope tolerances specified in subsection [205.03.N](#). Construct the granular material layer in accordance with subsection [301.03](#) except, compact the material to at least 90 percent of the maximum unit weight.

**B. Precast Concrete Slope Paving.** Place precast concrete for slope paving in accordance with the weather and temperature limitations specified in subsection [602.03.T](#). Place the precast units on a layer of granular material base. Fill the joints between precast units with Type R-3 mortar. Ensure the edges of the precast units are moist when placing the mortar. Place mortar beginning at the lower end of the joints and proceeding to the upper end of the joints. Completely fill the joints between the precast units after consolidation. Remove excess mortar

from the surface of the slope paving. Cure and protect the mortar in accordance with subsection [813.03.C.3](#).

**C. Concrete Slope Paving.**

1. **Forms.** Use wood or metal forms, straight and free of warp, and capable of resisting deflection during concrete placement. Form the concrete full depth. Stake forms, including slab division forms, to the required line and grade. Provide straight and continuous slab division joints. Form blocks of the dimensions shown on the plans.
2. **Placing and Finishing Concrete.** Place concrete in accordance with the weather and temperature limitations specified in subsection [602.03.T](#). Wet the base immediately before concrete placement. Place concrete to the required depth in a continuous operation.

Place concrete within 1½ hours of introducing the mixing water in the mix. Do not re-temper.

Consolidate the concrete along the faces of the forms. Tamp the concrete surface to remove voids and strike off with a strike board to the required grade and cross section.

Finish the concrete surface with a wood float. Round the edges and joints to a ¼-inch radius with a Department-approved finishing tool. Remove edging and finishing tool marks with a float and soft bristle brush.

3. **Curing and Protection.** Cure the concrete for at least four days by keeping the concrete surface continuously wet, or by applying a transparent membrane curing compound specified in subsection [903.07.A](#).

**D. Slope Paving Headers.** Use forms for slope paving headers in accordance with subsection [813.03.C.1](#).

If concrete placement is required below the elevation of the slope paving subgrade, or granular material layer, the Contractor may cast the concrete neat to the earth, as approved by the Engineer.

Place steel reinforcement in accordance with subsection [802.03.C](#). Place and finish slope paving header concrete in accordance with subsection [813.03.C.2](#). Cure slope paving header concrete in accordance with subsection [813.03.C.3](#).

**E. Riprap.** Place geotextile liner under the riprap. Place the liner in a key trench at the toe of the slope if the riprap ends at or below a high water elevation. After the riprap is in place, anchor the geotextile in a key trench at the tops of slopes with a ratio of 1:3 or steeper. Construct

the upper key trench to 1½ feet deep, or three times the minimum riprap dimension, whichever is greater. Provide a setback between the top of the slope and the upper key trench at least equal to the trench depth. Backfill the upper trench with riprap material unless otherwise directed by the Engineer.

Overlap geotextile seams by at least 2 feet. If laying geotextile horizontally, start at the bottom of the slope and shingle lap additional layers to direct surface runoff. Place riprap onto the geotextile without dumping or dropping riprap into place.

1. **Plain Riprap.** Begin the riprap placement in the trench at the toe of the slope and progress upward. Place individual stones, embedding each stone into the slope, and interlock against adjoining stones. Place random and well-broken joints between consecutive rows of stones. Compact the riprap as construction progresses. Unless using precast concrete blocks, ensure riprap is at least 8 inches thick measured perpendicular to the slope.
2. **Grouted Riprap.** Construct grouted riprap in accordance with subsection [813.03.E.1](#). Fill the spaces between the stones with Type R-3 mortar. Place the mortar from joint bottom to top and completely fill the voids between the stones after consolidation. Leave the top surface of the stone exposed. Immediately remove excess mortar with a stiff brush. Cure and protect grouted riprap in accordance with subsection [813.03.C.3](#).
3. **Heavy Riprap.** Construct heavy riprap in accordance with subsection [813.03.E.1](#). Unless using precast concrete blocks, construct heavy riprap at least 16 inches thick, measured perpendicular to the slope. If using broken pavement, place in two layers with staggered joints and fill voids with smaller pieces of broken pavement, as approved by the Engineer.

#### **813.04. Measurement and Payment.**

| <b>Pay Item</b>                 | <b>Pay Unit</b>  |
|---------------------------------|------------------|
| Slope Paving, Precast Conc..... | Square Yard      |
| Slope Paving, Conc.....         | Square Yard      |
| Slope Paving Header.....        | Foot             |
| Riprap, Grouted.....            | Square Yard      |
| Riprap, Plain.....              | Square Yard, Ton |
| Riprap, Plain, LM.....          | Cubic Yard       |
| Riprap, Heavy.....              | Square Yard, Ton |
| Riprap, Heavy, LM.....          | Cubic Yard       |

A. **Concrete Acceptance.** Conduct concrete quality control as specified in section [604](#). The Engineer will conduct quality assurance as specified in section [605](#). The Department will pay for this work based on the quality assurance results.

B. **Slope Paving.** The unit prices for slope paving pay items include the cost of admixtures and excavation and disposal of surplus materials. The unit prices for slope paving pay items also include the cost of granular material, unless the plans include the pay item Granular Material.

C. **Slope Paving Header.** The Engineer will measure **Slope Paving Header** in place, including both sides and the toe.

D. **Riprap.** The unit prices for the relevant riprap pay items include the cost of the following:

1. Providing and placing the geotextile liner;
2. Excavating and disposing of surplus materials; and
3. Constructing riprap headers and trenches.

## Section 814. PAVED DITCHES

**814.01. Description.** This work consists of constructing paved ditches using cobble, concrete, or Hot Mix Asphalt (HMA).

**814.02. Materials.** Provide materials in accordance with the following:

|                          |                     |
|--------------------------|---------------------|
| HMA Mixture .....        | <a href="#">501</a> |
| Concrete, Grade P2.....  | <a href="#">601</a> |
| Mortar, Type R-3 .....   | <a href="#">702</a> |
| Curing Compound .....    | <a href="#">903</a> |
| Steel Reinforcement..... | <a href="#">905</a> |
| Geotextile Liner .....   | <a href="#">910</a> |
| Cobblestones.....        | <a href="#">916</a> |

**A. HMA Paved Ditches.** Provide HMA with an air void content of no greater than 2 percent and performance Grade 52-34 asphalt cement. Obtain the Engineer's approval for the HMA mixture in accordance with section [501](#).

**B. Concrete Paved Ditches.** Provide a retarding admixture, selected from the Qualified Products List, if placing concrete more than 1½ hours after adding water to the concrete mixture, but do not exceed the manufacturer's recommended maximum initial set time.

### 814.03. Construction.

**A. Preparation of Base.** Excavate, shape, and compact the base to the required cross section and elevation. For concrete paved ditches, excavate to allow for installing and bracing forms. Dispose of surplus excavated material in accordance with subsection [205.03.P](#).

If required, line the width of the ditch bottom, as shown on the plans, with geotextile. Do not use longitudinal seams. Begin placement at the down slope end of the ditch and shingle lap geotextile at least 2 feet.

**B. Plain Cobble Ditch.** Place cobblestones or broken concrete on the prepared base with the longest dimensions parallel with the centerline of the ditch and smallest faces upward. Place the outer rows first, using the larger stones. Place the stones or broken concrete by hand and stagger the joints. Use a tamper of at least 30 pounds to uniformly bed cobble stones and broken concrete in the base.

**C. Grouted Cobble Ditch.** Place mortar with a mason's trowel.

Begin work at the lowest elevation of the ditch. Place a layer of mortar on the prepared base to embed the lower half of the cobblestones or broken concrete and fill the spaces between the stones with mortar.



Place the stones or broken concrete in accordance with subsection [814.03.B](#). Add and consolidate mortar to fill voids to within 1 inch of the top of the stones or pieces of broken concrete, leaving the top surface exposed. Cure and protect the grout in accordance with subsection [814.03.E.5](#).

**D. HMA Paved Ditch.** Do not place HMA on frozen material. Place the HMA mixture on the prepared base to a thickness of at least 2 inches, and to at least 220 pounds per cubic yard. Cover the ditch bottom and side slopes.

Place HMA using mechanical or hand methods, as approved by the Engineer. Compact the material using a roller, mechanical compactor, or hand tamper. Check the ditch grade during paving to ensure drainage.

**E. Concrete Paved Ditches.**

1. **Forms.** Use wood or metal forms, straight and not warped, and capable of resisting deflection during concrete placement. Provide forms with a vertical face equal to the required concrete thickness.

If concrete placement is required below the ditch subgrade, the Contractor may cast the concrete neat to the earth, as approved by the Engineer.

2. **Steel Reinforcement.** Place steel reinforcement in accordance with subsection [802.03.C](#).

3. **Placing and Finishing Concrete.** Place concrete in accordance with the temperature and weather limitations specified in subsection [602.03.T](#). Wet the base immediately before placing concrete. Consolidate the concrete along the faces of the forms and next to the joints. Tamp the concrete surface to remove voids, strike off, and float to the required grade and cross section. Do not retemper the concrete.

Round the edges and joints of the pavement to a ¼-inch radius with a Department-approved finishing tool. Remove edging and finishing tool marks with a float and soft bristle brush.

4. **Joints.** Construct plane-of-weakness joints in accordance with subsection [803.03.D](#).

5. **Curing and Protection.** Cure the concrete for at least 4 days by keeping it continuously wet, or applying a transparent membrane curing compound specified in subsection [903.06.B](#).

**814.04. Measurement and Payment.**

| <b>Pay Item</b>             | <b>Pay Unit</b> |
|-----------------------------|-----------------|
| Ditch, Plain Cobble .....   | Square Yard     |
| Ditch, Grouted Cobble ..... | Square Yard     |
| Paved Ditch, HMA .....      | Square Yard     |
| Paved Ditch, Conc.....      | Square Yard     |

Conduct concrete quality control as specified in section [604](#). The Engineer will conduct quality assurance as specified in section [605](#). The Department will pay for **Paved Ditch, Conc** based on the quality assurance results and this section.

The cost of concrete or grout admixtures is included in the unit price of related paved ditch pay items.

The Engineer will measure cobble and paved ditch items in place.

The cost of providing and placing geotextile liner, and removing and disposing of surplus materials for the installation of the liner, cobble, HMA, and concrete is included in the unit prices for related cobble and paved ditch items.

## Section 815. LANDSCAPING

**815.01. Description.** This work consists of providing and planting trees, shrubs, and other plants, including replacements, classified as nursery stock. The Engineer may inspect, select, and reject plants anytime through the second year of the establishment period.

**815.02. Materials.** Provide materials in accordance with the following:

|                               |                     |
|-------------------------------|---------------------|
| Topsoil .....                 | <a href="#">917</a> |
| Peat Moss.....                | <a href="#">917</a> |
| Compost .....                 | <a href="#">917</a> |
| Fertilizer .....              | <a href="#">917</a> |
| Water .....                   | <a href="#">911</a> |
| Nursery Stock.....            | <a href="#">917</a> |
| Mulching Materials.....       | <a href="#">917</a> |
| Tree Wrapping Materials ..... | <a href="#">917</a> |
| Balling Material .....        | <a href="#">917</a> |
| Wire .....                    | <a href="#">917</a> |
| Hose .....                    | <a href="#">917</a> |
| Stakes.....                   | <a href="#">917</a> |

### 815.03. Construction.

**A. Prepared Soil.** Use prepared soil for landscaping, consisting of a uniform mixture of topsoil, peat moss or compost, and fertilizer. Proportion the prepared soil so that 1 cubic yard of the prepared soil contains  $\frac{3}{4}$  cubic yard topsoil,  $\frac{1}{4}$  cubic yard of peat moss or compost, and chemical fertilizer as specified in subsection [917.10.A.1](#).

Thoroughly mix the component materials before final placement.

**B. Site Preparation.** Excavate holes, centered at staked locations, to a diameter that allows 18 inches of prepared soil beyond the ends of bare roots or root balls. The Engineer will approve variance in the size of planting holes as soil conditions or plant requirements dictate. Set the root ball on undisturbed soil at the required depth.

Remove excavated material from the site and dispose of it outside the right-of-way in accordance with subsection [205.03.P](#). Backfill the planting holes with prepared soil the same day they are dug.

**C. Preparation of Shipments.** Label a sample of each plant species and variety. Provide balled and burlapped or container-grown plants unless otherwise required.

Prepare nursery stock for shipment in accordance with the current ANSI Z60.1 requirements and enclose or cover during transportation to prevent drying.

1. **Balled and Burlapped Stock.** In preparation for spring planting, complete balling and burlapping before bud break. In preparation for planting deciduous plants in the fall, do not begin balling until after the plants begin to harden off. Dig and pack balled and burlapped stock immediately before shipment. Dig, prepare, and transport plants to provide and retain a firm ball of earth. Protect the root balls with wet straw, mulch, or other material approved by the Engineer. Protect the root balls from rain or sudden changes in the weather. The Engineer will not accept trees or plants if root balls are loosened or broken.
  2. **Container Grown Stock.** Ensure container grown stock is grown in the container for at least one growing season. The Engineer will not accept plants, other than ground cover plants, with pot-bound root ends.
  3. **Bare Root Stock.** Do not injure or remove fibrous feeder roots when digging and packing bare root stock. Maintain the root moisture while transporting the stock to the planting site.
- D. **Seasonal Limitations.** Plant deciduous plants from March 1 to May 15 and from October 1 until the prepared soil freezes. If unusual planting conditions exist or if using container-grown material, the Engineer may alter these planting seasons.

Plant evergreen plants from March 1 to June 1.

E. **Care of Plants Before Planting.** Immediately following delivery and inspection at the project, heel-in plants with exposed roots in moist soil. Protect heeled-in plants and keep their roots moist until planted. Use a protected, shaded area, or a well-ventilated enclosure for the healing-in grounds.

Keep the roots of planting stock moist and protected.

Protect tree trunks and branches from injury. The Engineer may reject injured trees.

F. **Planting.** Do not begin planting until water is available at the project. Water-in plants as they are planted. Water-in the prepared soil around the root ball and roots and firm the soil at intervals during the planting process. Saturate the prepared soil in the planting hole.

1. **Plants Located on Slopes.** For plants located on slopes, construct a berm of prepared soil half way around each plant on the down slope side. Construct the berm of prepared soil with an inside diameter equal to the planting hole diameter, and no greater than 6 inches high. Do not make the base of the berm more than 18 inches wide.
2. **Balled and Burlapped Stock.** Set plants plumb. Plant balled and burlapped stock so the depth, after settling, compared to the surrounding ground surface is the same as the depth at the original location of the balled stock. Water-in the prepared soil and eliminate air pockets by tamping the soil at intervals under and around the ball. Do not damage the root ball during tamping operations. After backfilling and tamping the plant hole to half the required depth, remove the burlap and lacing from around the trunk and the upper half of the ball. Continue backfilling the hole with prepared soil until the soil is flush with the ground surface after compaction.
3. **Container Grown Stock.** Remove container grown plants from the containers at the time of planting. Plant container grown stock in accordance with subsection [815.03.F.2](#). The Engineer may reject plants with a broken or loosened root and soil ball mass.
4. **Bare Root Stock.** Preserve the root growth on bare root stock. Do not prune the roots except to remove broken or damaged roots. Plant bare root stock so the depth, after settling, compared to the surrounding ground surface is the same as the depth at the original location of the bare root stock. Hold the exposed roots in the required position with the roots spread out during backfilling and compacting.
5. **Mulching.** After backfilling is complete, place from 5 inches to 6 inches of shredded bark over the plant hole area.
- G. **Pruning Branches.** Ensure an arborist, certified by the International Society of Arboriculture, prunes branches before planting. Do not use pruning paint.
  1. **Deciduous Trees.** Prune deciduous trees to remove dead wood and broken branches. The Engineer may require additional pruning. Prune so that the crown height is one-half the trunk height. Do not cut the primary leader back, unless otherwise required. Cut branches in accordance with ANSI A 300.
  2. **Deciduous Shrubs.** Ensure healthy, symmetrical growth of new wood by pruning deciduous shrubs to remove dead wood and broken branches, thin out canes and cut back or remove

asymmetrical branches and other growth. Prune shrubs to form an outline conforming to the general shape of the shrub type.

3. **Evergreen Trees and Shrubs.** Prune evergreens to remove broken or damaged branches.

H. **Wrapping Deciduous Trees.** Wrap deciduous trees within one week after planting. Wrap the trunk, beginning at the base, just above the roots, below the normal ground line, and extend upward in a spiral with an overlap of half the width of the wrapping strip. Cover the portion of the wrapping below the finished grade with soil. Hold the paper in place with masking tape in at least 5 locations, including the top and bottom of wrapping. Overlap the tape at least 4 times in each of the 5 locations.

I. **Clean Up.** Upon completion of planting, immediately clean up, remove, and dispose of surplus material off site. Repair ruts and turf damage resulting from the planting operation and re-establish turf in these areas in accordance with subsection [816.03](#) and as directed by the Engineer. Complete clean up before June 1.

J. **Watering and Cultivating.** In addition to the watering-in required at the time of planting, water, cultivate, and remove grass and weeds around each plant at least 5 times during each of the two growing seasons of the establishment period. The Engineer may add or subtract watering as conditions warrant. Notify the Engineer at least 3 days before each watering.

During each watering and cultivation, remove grass and weeds within the mulch ring. Cut grass to 3 inches high, 12 inches beyond the outside perimeter of the mulch ring. Inspect landscaping and remove insect infestations or disease damage to the plants and prune dead wood.

During the first and second watering of the second growing season, use a nitrogen-enriched solution as specified in subsection [917.10.A.2](#). Apply fertilizer before July 7.

At the first watering of the second growing season, remove and dispose of the guying material, wrapping material, identification tags, and inspection tags. At the final watering, replenish the mulch around the plants to a depth of 5 inches to 6 inches.

1. **Watering with Probe.** Water with a probe that meets the following requirements:
- Is long enough to extend to the depth of the root ball;
  - Has a diameter no greater than 1 inch;
  - Has a closed pointed end with holes in the lower 4 inches; and

- d. Is equipped with a control valve for regulating water pressure and volume.

Insert the probe next to the root ball in at least three equally spaced locations around the plant. Adjust the pressure so little or no run-off occurs before placement of the required amount of water. After extracting the probe, close or fill holes remaining in the soil.

2. **Quantity of Water.** Use the following volumes of water for the specified plants:
  - a. For shade trees, 35 gallons per watering;
  - b. For intermediate plants and evergreen trees, 20 gallons; and
  - c. For shrubs, 5 gallons.
3. **Watering and Cultivating Periods.** Water and cultivate during each of the following periods:
  - a. From June 1 to June 15,
  - b. From June 23 to July 7,
  - c. From July 15 to July 29,
  - d. From August 4 to August 18, and
  - e. From September 5 to September 19.

K. **Bracing and Guying.** Brace or guy deciduous trees immediately after wrapping. Brace or guy evergreen trees and bare-rooted deciduous trees immediately after planting.

1. For evergreen trees, use at least the following number of stakes:
  - a. For trees higher than 6 feet, 3 stakes; and
  - b. For trees 6 feet high or less, 2 stakes;
2. For bare-root stock, use at least 2 stakes;
3. For balled stock, use at least the following number of stakes:
  - a. For low-headed trees, 1 stake (the Engineer may omit); and
  - b. For deciduous clump trees, 2 or 3 stakes;
4. For balled stock, deciduous, but not low-headed trees use at least the following number of stakes:
  - a. For calipers greater than 4 inches, 3 stakes;
  - b. For calipers from 2 inches to 4 inches or at least 8 feet high, 2 stakes; and
  - c. For calipers less than 2 inches or less than 8 feet high, 1 stake.

Place one stake on the west side of the plant. If using two stakes, position them on opposite sides of the trunk and secure each stake to the trunk at two-thirds the height of the tree. If three stakes are required, use the tripod method of guying.

To avoid the root ball, anchor the tree by driving stakes no closer than 1 foot from the trunk. Drive stakes parallel to the trunk to within 4 inches of the lower main branches remaining after pruning. Maintain bracing stakes at a uniform height for similar plant or tree sizes throughout the project. Attach the top of the stake to the trunk with No. 11 wire and form a figure-eight shape around the stake and trunk. Encase the wire loop that contacts the tree trunk with sections of hose that extends 6 inches beyond either side of the trunk. Twist guy wires so they do not restrict normal trunk growth and the trunk can move laterally 1 inch to 2 inches. For deciduous clumps, attach each stem to a support stake.

Use three No. 11 wires for the tripod method of tree guying. Encircle the trunk with one end of each guy wire. Encircle the trunk of deciduous trees just above the lower main branches and evergreen trees at a point two-thirds the height of the tree. Encase the wire encircling the trunk in hose that extends 6 inches beyond either side of the trunk. Fasten the other end of each guy to stakes equally spaced around the tree. Place the stakes away from the tree a distance equal to three-quarters the vertical distance from the ground to where the guys are fastened to the trunk. Notch the anchor stakes to prevent the wire from slipping. Drive stakes to at least 18 inches deep and at an angle so the tops point away from the tree.

For the duration of the contract, replace blown down trees or trees damaged by improper bracing or guying at no additional cost to the Department.

Brace or guy replacement plants, planted at the beginning of the second growing season. Maintain guying and wrapping material until project completion, and then remove.

**L. Period of Establishment.** The contract requires an establishment period beginning at the completion of the initial planting and extending through the following two growing seasons. A growing season is the months of June, July, and August.

Provide plants in a healthy growing condition at the start of the establishment period. The Engineer will inspect the plants at the end of the first and second growing seasons to determine acceptability. The Engineer will consider plants unacceptable if they are dead, missing, unhealthy, or otherwise unsatisfactory at the time of inspection, or not planted as required.

Remove dead evergreen plants before winter. Plant replacement plants in accordance with subsection [815.03.F](#), before May 10 of the following spring planting season. Water replacement plants, planted after the first



growing season, at the same time and in the same manner as the other plants receiving their second season watering.

Unacceptable plants identified by the Engineer at the end of the second growing season do not require replacement. Remove these plants along with guying materials and dispose of removed plants and guying material off the project.

**815.04. Measurement and Payment.**

| <b>Pay Item</b>   | <b>Pay Unit</b> |
|---|-----------------|
| Site Preparation, Max. (dollar).....                        | Lump Sum        |
| (Botanical Name).....                                       | Each            |
| Watering and Cultivating, First Season, Min. (dollar).....  | Lump Sum        |
| Watering and Cultivating, Second Season, Min. (dollar)..... | Lump Sum        |

A. **Site Preparation.** The unit price for **Site Preparation, Max (dollar)** includes the cost of digging holes, providing prepared soil, backfilling holes, and disposing of excess excavated material.

B. **Plants.** The Engineer will measure plants by the units shown on the plans and methods specified in ANSI Z 60.1. The Department will not pay for the pay item, **(Botanical Name)** until the plant is pruned, planted, watered-in, wrapped, braced or guyed, and mulched.

The Department will not make additional payments for replacement plants.

**C. Watering and Cultivating.**

1. **First Season.** The Department will pay 20 percent of the lump sum price for **Watering and Cultivating, First Season, Min. (dollar)** at the completion of each of the five watering and cultivating operations. Payment for **Watering and Cultivating, First Season, Min. (dollar)** includes the cost of the following:

- a. One watering and cultivating operation;
- b. Providing and mixing fertilizer with the water as required; and
- c. Removal and disposal of unacceptable plants.

2. **Second Season.** The Department will pay for **Watering and Cultivating, Second Season, Min. (dollar)** as a lump sum at the completion of the second growing season. The unit price of **Watering and Cultivating, Second Season, Min. (dollar)** includes the cost of the following:

- a. Five watering and cultivating operations;
- b. Providing and mixing fertilizer with the water;
- c. Removal and disposal of unacceptable plants; and

- d. Removal of guying material identified by the Engineer at the end of the second growing season.

For each unacceptable plant identified, the Engineer will calculate a 50 percent reduction in the unit price for the relevant **(Botanical Name)** pay item, and will deduct that amount from the pay item, **Watering and Cultivating, Second Season, Min. (dollar)**.

3. **Supplemental Watering.** The Department will pay for supplemental watering, in addition to the 10 watering operations required, at 20 percent of the associated lump sum contract unit price. The Department will reduce the relevant lump sum contract unit price by 20 percent for each deleted watering.

## Section 816. TURF ESTABLISHMENT

**816.01. Description.** This work consists of conducting soil tests, preparing the soil, and placing sod or seed and mulch to permanently stabilize disturbed areas as shown on the plans. Establish turf in accordance with this section, the [MDOT SESC Manual](#), and as directed by the Engineer.

The following terms apply to this section.

**Mulch Anchor.** A glue type material sprayed over mulch to hold it in place.

**Broadleaf Weed.** Weeds described by the Engineer as target weeds controlled by spraying. Broadleaf weeds include, but are not limited to, dandelion, clovers, thistles, and ragweed,

**Compost.** A mature and stabilized, humus-like material derived from the aerobic decomposition of yard clippings, leaves, and brush with a diameter less than 4 inches.

**Dormant Seeding.** Seeding placed in late November and December when plant growth ends for the season. Seeds are placed on unfrozen ground and mulched to lie dormant over winter and germinate the following spring.

**Friable.** Easily crumbled or pulverized soil.

**Friable Condition.** Soil in a “friable condition” is a crumbled, pulverized, worked-up, loosened, or cultivated soil, free of lumps and clods detrimental to seeding and sodding operations.

**Humus.** A brown or black material formed by the decomposition of vegetable or animal matter. The organic portion of soil, essential to fertility.

**Hydroseeding.** Spraying seed combined with water onto the prepared seed bed.

**Muck.** Organic matter consisting of decomposed plant material accumulated under conditions of excessive moisture. If organic remains are not identifiable as plant form, it is considered muck.

**Mulch.** Material placed over seeding to improve germination by conserving moisture, moderating the soil temperature, and protecting the seed and soil from water and wind erosion.

**Peat.** Organic matter consisting of undecomposed or slightly decomposed plant material accumulated under conditions of

excessive moisture. If organic remains are identifiable as plant form, it is considered peat.

**Target Weed.** Weeds that the Engineer identifies for removal by spraying or other methods.

**816.02. Materials.** Provide materials in accordance with the following:

|                      |                     |
|----------------------|---------------------|
| Compost .....        | <a href="#">917</a> |
| Topsoil .....        | <a href="#">917</a> |
| Fertilizer .....     | <a href="#">917</a> |
| Seed .....           | <a href="#">917</a> |
| Sod .....            | <a href="#">917</a> |
| Mulch .....          | <a href="#">917</a> |
| Mulch Anchoring..... | <a href="#">917</a> |
| Mulch Netting.....   | <a href="#">917</a> |
| Mulch Blankets ..... | <a href="#">917</a> |
| Weed Control.....    | <a href="#">917</a> |
| Water .....          | <a href="#">911</a> |

**816.03. Construction.**

A. **Topsoiling.** Before placing topsoil, prepare the foundation. Provide, place, and spread humus bearing topsoil, compost, or both. Use topsoil from within the project limits or from off-site sources.

1. **Preparation of Earth Bed.** Seven to ten days before preparing earth bed, including areas previously mulched or rye seeded for temporary erosion control, kill existing vegetation by spraying with the non-selective herbicide Glyphosate.

Construct the earth bed to the required grade and trim. Just before placing topsoil or compost, harrow all earth beds, including areas previously mulched or rye seeded for temporary erosion control, into a friable condition with a disk, a spring tooth drag or a spike tooth drag a minimum of 3 inches deep.

Leave horizontal soil impressions from equipment, across the face of the slope.

2. **Placing Topsoil.** Cover areas requiring seeding or sodding with topsoil, compost, or both, except for slopes constructed of topsoil, muck or peat.

Spread topsoil, compost, or both on the prepared areas at least 3 inches deep. Pulverize large clods and lumps. Rake out rocks with a diameter greater than 2 inches, roots, litter, and deleterious

material. Dispose of raked out material in accordance with subsection [205.03.A.3](#) and subsection [205.03.P](#).

Incorporate topsoil and compost into the upper 2 inches of the conditioned earth bed. Do not work topsoil or compost if wet.

3. **Surplus Excavated Topsoil or Salvaged Topsoil.** The Engineer will direct stockpiling surplus excavated or salvaged topsoil within the right-of-way. Leave the stockpile with an aesthetically pleasing appearance, as approved by the Engineer.

**B. Chemical Fertilizer Nutrient.** Conduct soil tests to determine the need for fertilizer containing phosphorus. Provide and place fertilizer as indicated by soil tests.

In areas requiring sod, uniformly apply granular fertilizer before laying the sod.

Uniformly apply granular fertilizer, free of lumps, on the prepared seed and sod bed and incorporate into the upper 1 inch to 2 inches of the topsoil and compost by light disking or harrowing.

Apply the required class of fertilizer to the required locations at the following application rates:

1. For Class A fertilizer, evenly apply 228 pounds per acre on a prepared seed bed.
2. For Class B fertilizer, evenly apply 120 pounds per acre on a prepared seed bed.
3. For Class C fertilizer, evenly apply 80 pounds per acre on established turf.

If using the hydroseeding method, constantly agitate the seed-fertilizer mixture. Do not disk or harrow after placement. Apply fertilizer mixed with seed within 1 hour of mixing.

Remove excess fertilizer from impervious surfaces adjacent to prepared seed and sod beds by sweeping back into beds. Do not use water to flush excess fertilizer into storm drains or surface water.

**C. Seeding.** Obtain the Engineer's approval for topsoil placement prior to seeding. Provide each seed species selected from the Qualified Products List. Do not broadcast or hydroseed during windy conditions, or conditions that would prevent seed placement as required. Apply turf and specialty seed mixtures in accordance with the mix ratios and seeding rates in Table [816-1](#) and Table [816-2](#).

## 1. Permanent Seeding.

- a. **Sowing.** Harrow the topsoil or compost, at least 3 inches deep, immediately before seeding. Harrow using a disk, spring tooth drag, spike tooth drag, or other equipment, approved by the Engineer and designed to prepare the soil to a friable condition. Harrow horizontally, across the face of the slope. In areas requiring a Turf Loamy to Heavy (THM) seed mixture, grade the seed bed to a Class A slope as specified in subsection [205.03.N](#).

While the seed bed is in a friable condition, sow seed with or following the application of fertilizer. Sow seed before applying mulch. Sow or resow the seed mixture, providing uniform coverage, at the rate specified in Table [816-1](#) or Table [816-2](#).

Sow using mechanical drills, hydroseeders, or by broadcasting. In areas with 1:4 slopes, or flatter, use mechanical drills.

The Department will allow hydroseeding on slopes steeper than 1:4 provided the Engineer determines the seeding equipment is effective and attains required results.

Empty the hydroseeder tank within 1 hour of introducing the seed and fertilizer to the tank. Dispose of seed that remains in the tank mixed with water for longer than 1 hour.

Broadcast in areas requiring resowing, or in areas not accessible to a drill or hydroseeder.

The Engineer will visually inspect areas sown by broadcast or hydroseed for uniformity of application. Resow areas that do not have an average of two seeds per square inch, at no additional cost to the Department.

- b. **Setting the Seed.** Lightly compact or rake areas sown by hydroseed or broadcast methods to incorporate the seed into the top ½ inch of the topsoil. Immediately after setting the seed, mulch in accordance with subsection [816.03.E](#) and subsection [816.03.F](#).

| <b>Symbol for Turf Seed Mixture</b> | <b>Soil Type</b>       | <b>General Location</b>                             | <b>Seed Rate</b> | <b>Salt Tolerance</b> |
|-------------------------------------|------------------------|---|------------------|-----------------------|
| TDS (Turf Dry Sandy)                | Dry sandy to sand loam | Rural or urban                                      | 220 lb/acre      | Low to medium         |
| THV (Turf Heavy Soil)               | Heavy                  | Rural   | 220 lb/acre      | Medium to high        |
| TUF (Turf Urban Freeway)            | All types              | Urban freeways, blvds., service roads, city streets | 220 lb/acre      | Low to high           |
| TGM (Turf Medium to Heavy Soil)     | Medium to heavy        | All   | 220 lb/acre      | Low                   |
| THM (Turf Loamy to Heavy)           | Loamy to heavy         | Residential and business turf                       | 220 lb/acre      | Low to medium         |

| <b>Symbol for Seed Mixture</b>            | <b>Soil Type</b> | <b>General Location</b> | <b>Seed Rate</b> | <b>Salt Tolerance</b> |
|---|------------------|-------------------------|------------------|-----------------------|
| <b>Mixture for Upland Areas</b>           |                  |                         |                  |                       |
| ES<br>(Environmental Seeding)             | All              | Upland Areas            | Table 917-1      | N/A                   |
| <b>Temporary Seeding Mixtures</b>         |                  |                         |                  |                       |
| CR (Cereal Rye, <6 mos)                   | All              | All                     | 70 lb/acre       | N/A                   |
| TSM 6/24<br>(Temporary seeding, 6–24 mos) | All              | All                     | 100 lb/acre      | N/A                   |
| TSM 24+<br>(Temporary seeding, >24 mos)   | All              | All                     | 200 lb/acre      | N/A                   |

2. **Temporary Seeding.** Obtain the Engineer's approval for temporary seeding. Place temporary seed only for erosion control or temporary soil stabilization. Do not temporarily seed slopes 1:3 or steeper after placing topsoil; permanently seed these slopes. Sow temporary seed in accordance with subsection [816.03.C.1](#). Before project completion, replace temporary seeding with permanent seeding as shown on the plans or directed by the Engineer.
3. **Dormant Seeding.** The Engineer will allow dormant seeding in limited areas. Obtain the Engineer's approval for dormant seeding. Dormant seed in accordance with subsection [816.03.C.1](#).

#### 4. **Seasonal Limitations.**

- a. **Permanent Seeding.** Permanently seed the following locations during the specified periods:
  - i. Southern Lower Peninsula. South of the north boundary of Township 20 North; April 15 through October 10.
  - ii. Northern Lower Peninsula. North of the north boundary of Township 20 North; May 1 through October 1.
  - iii. Upper Peninsula. May 1 through September 20.
- b. **Dormant Seeding.** Dormant seed the following locations during the specified periods:
  - i. Southern Lower Peninsula. South of the north boundary of Township 20 North; after November 15, but not on frozen ground.
  - ii. Upper Peninsula and Northern Lower Peninsula. North of the north boundary of Township 20 North; after November 1, but not on frozen ground.
- c. **Temporary Seeding.** Temporary seed in accordance with the seasonal limitations specified in subsection [816.03.C.4.a.](#)

5. **Inspection.** The Engineer will inspect the seeded turf to ensure the end product is well established, weed free, growing, vigorous, and contains the species required by the seeding mixture.

The Engineer will approve slopes as the Contractor completes permanent restoration on cut slopes, embankment slopes, or portions of slopes. The Engineer will consider each cut or embankment slope, on each side of the roadway, separately for approval.

If the Engineer requires weed control, complete work in accordance with subsection [816.03.J.](#) If using hay mulch, provide weed control at no additional cost to the Department.

- D. **Sodding.** Prepare the topsoil surface, provide and place the sod, and dispose of surplus material. Grade areas required for sodding to Class A slopes in accordance with subsection [205.03.N.](#)

Immediately before laying sod, harrow the topsoil, at least 3 inches deep using a disk, spring tooth drag, spike tooth drag, or other equipment designed to condition the soil. Obtain the Engineer's approval for harrowing equipment. Harrow horizontally across the face of slopes.



Dampen the earth bed before laying the sod. Water the sod immediately after placement, in accordance with subsection [816.03.I](#). The Engineer will reject sod that has dried out.

Protect sod until placement. Lay sod within 24 hours after cutting. Do not handle sod with pitch forks, or dump from vehicles. Do not place frozen sod, or place sod on frozen soil. Unless otherwise approved by the Engineer, do not place sod in June, July, or August.

Place sod as shown on Standard Plan R-100 Series. Stagger the transverse joints of the sod strips and lay parallel to the flow of water on slopes and in ditches. Place strips with tight joints. Lay sod starting at the base of the slope and work up the slope. Turn edges of sodded areas into the ground and cover with a layer of earth or shoulder material. Compact this material to allow the surface water to flow over the edge of the sod. Butt the edges of sod firmly against, and level with, paved surfaces.

Work from ladders or treaded planks if necessary to prevent the displacement of sod during sodding operations. Compact sod by tamping immediately after placement. Tamp to a smooth, even surface free of bumps and depressions. If Class A slopes are required, finish the sodded surface to a lawn-like appearance. On slopes steeper than 1:3, use wooden pegs to secure the sod. Space pegs no greater than 2 feet apart and drive flush with the sod surface.

**E. Mulching.** Provide, spread, and anchor mulch material. Place mulch within one calendar day after seeding.

Do not mulch during winds that prevent placement and anchoring of the mulch.

Place mulch to allow sunlight to penetrate and air to circulate, but thick enough to shade the ground, conserve soil moisture, and prevent or reduce water and wind erosion.

Spread mulch over the surface to a uniform thickness with an application rate of 2 tons per acre. If the Engineer allows dormant seeding, spread the mulch with an application rate of 3 tons per acre. After seed germinates and turf is established, apply herbicide in accordance with subsection [816.03.J](#). Apply herbicide to hay mulch at no additional cost to the Department.

Maintain the mulched areas and repair areas damaged by erosion, traffic, fire, or other causes, before partial or final acceptance. Replace displaced mulch. Repair or replace damaged mulch areas at no

additional cost to the Department, unless otherwise provided by subsection [107.11](#) or section [208](#).

Replace and anchor mulch that blows away or becomes displaced, for reasons attributable to the Contractor, as directed by the Engineer and at no additional cost to the Department.

**F. Mulch Anchoring.** Provide a mulch anchoring material selected from the Qualified Products List. Spray mulch anchoring immediately after placing mulch. Do not spray if wind prevents the required placement of adhesive. Protect traffic, signs, structures, and other objects from the tackifier material. Immediately remove overspray.

Mix and apply latex base, recycled newsprint, wood fiber, guar gum, and other mulch tackifier material as follows:

1. **Latex-Base.** Mix 15 gallons of adhesive, or the manufacturer's recommended adhesive volume, whichever is greater, with at least 250 pounds of recycled newsprint and 375 gallons of water.
2. **Recycled Newsprint.** Mix 750 pounds of recycled newsprint with 1,500 gallons of water.
3. **Wood Fiber.** Mix 750 pounds of wood fiber with 1,500 gallons of water.
4. **Guar Gum.** Mix 50 pounds of dry adhesive and at least 250 pounds of recycled newsprint with 1,300 gallons of water.
5. **Other Tackifiers.** Mix 100 pounds of dry adhesive, or the manufacturer's recommended adhesive volume, whichever is greater, with at least 250 pounds of recycled newsprint and 1,300 gallons of water.

**G. Mulching Netting.** Place netting over mulch and secure with net anchors.

Spread the netting over the mulch, allowing work space between adjacent widths. Then, pull the edges of adjacent widths together and hold in place with net anchors. Space net anchors no greater than 2½ feet apart along the edges, joints, and centerline of the net, in accordance with the manufacturer's recommendation. Do not place the netting in direct contact with the ground. Butt the ends of each width of netting together and hold in place using net anchors at each corner and at the center of the netting.

Do not allow foot traffic or equipment over the netting after placement, except for repair work. Replace torn or damaged netting.

If using dormant seeding methods, apply mulch netting in addition to the mulch adhesive, at no additional cost to the Department.

**H. Mulch Blankets.** Provide, install, and anchor mulch blankets. Provide mulch blankets selected from the Qualified Products List. Place mulch blankets within one calendar day after seeding. Secure with net anchors. Place and anchor blankets in accordance with the minimum requirements specified in this subsection or the manufacturer's specifications, whichever is greater.

Overlap blanket edges by 2 inches and shingle lap blanket ends with a 6-inch overlap. Place net anchors along joint edges and blanket centerlines no greater than 2 feet apart. In waterways, shingle lap blankets with an overlap of 12 inches on the downslope edge. Place blankets on backslopes perpendicular to the roadbed. On foreslopes, lay the first strip adjacent to the road, parallel to the road. Lay the remainder of the strips on foreslopes parallel or perpendicular to the road. If installing blankets from the top of the slope, do not allow them to free fall down the slope.

1. **High Velocity Blankets.** Use high velocity blankets on slopes of 1:2 or steeper and on ditch bottoms, including 12 inches up the front and back slopes.

The Contractor may substitute high velocity blankets for mulch blankets at no additional cost to the Department.

2. **Mulch Blankets.** Use mulch blankets on slopes of less than 1:2, next to shoulders, and behind curbs. Place mulch blankets with the netting on top and mulch fibers contacting the soil.

The Contractor may only use mulch blankets on ditch bottoms with ditch gradients no greater than 1.5 percent.

**I. Water.** Provide and apply water to sodded and seeded areas at the required rates. The Engineer may require additional watering based on the season and weather conditions.

1. **Sod.**
  - a. Water the earth bed with at least 3½ gallons per square yard before laying the sod;
  - b. Apply at least 27 gallons per square yard after placing the sod;
  - c. Apply an additional 6 gallons per square yard within 8 hours after placing the sod; and
  - d. Apply 3½ gallons per square yard of sod, five times at three to four day intervals.

## 2. Seed.

- a. Water seeded areas, at 3½ gallons per square yard, as determined by the Engineer; and
- b. Continue watering regularly to prevent seeds and seedlings from drying out.

J. **Weed Control.** Provide and apply herbicides as directed by the Engineer. Submit the name and application rate of the herbicide to the Engineer, and obtain the Engineer's approval before applying.

To apply herbicides, use a commercial herbicide applicator, licensed in the State of Michigan, and certified by the Michigan Department of Agriculture in the required category. Use application procedures and materials in accordance with federal, state, and local regulations.

Before spraying, allow inspection of, and obtain the Engineer's approval for, the spraying equipment. Demonstrate to the Engineer that equipment and operators can apply an even and controlled layer of herbicide within the required target area. Use equipment that meets federal, state, and local safety requirements.

Spray target weeds in the newly seeded turf after the new turfgrass is established and will withstand herbicide application.

Control target weeds from 14 days to 21 days after spraying. Apply additional weed control if the first application fails.

Preserve and protect property adjacent to the roadway or work area from injury. Repair damage arising from acts or omissions in the performance of the work, at no additional cost to the Department.

## 816.04. Measurement and Payment.

| <b>Pay Item</b>                           | <b>Pay Unit</b> |
|---|-----------------|
| Compost Surface, Furn, LM .....           | Cubic Yard      |
| Compost Surface, Furn, __ inch.....       | Square Yard     |
| Topsoil Surface, Salv, LM.....            | Cubic Yard      |
| Topsoil Surface, Salv, __ inch.....       | Square Yard     |
| Topsoil Surface, Furn, LM .....           | Cubic Yard      |
| Topsoil Surface, Furn, __ inch .....      | Square Yard     |
| Fertilizer, Chemical Nutrient, CI __..... | Pound           |
| Seeding, Mixture __.....                  | Pound           |
| Sodding.....                              | Square Yard     |
| Mulch .....                               | Square Yard     |
| Mulch Anchoring.....                      | Square Yard     |
| Mulch Netting.....                        | Square Yard     |
| Mulch Blanket .....                       | Square Yard     |

|                                    |             |
|------------------------------------|-------------|
| Mulch Blanket, High Velocity ..... | Square Yard |
| Water, Sodding/Seeding.....        | Unit        |
| Weed Control.....                  | Acre        |

A. **Compost.** The Engineer will measure **Compost Surface, Furn LM**, at the source, before hauling to the project.

The Engineer will measure **Compost Surface, Furn**, \_\_ inch in place.

B. **Topsoil.** The Engineer will measure **Topsoil Surface, Salv, LM** at the source, before placement at the final location.

The Engineer will measure **Topsoil Surface, Salv**, \_\_ inch in place.

The Engineer will measure **Topsoil Surface, Furn, LM**, at the source, before hauling to the project.

The Engineer will measure **Topsoil Surface, Furn**, \_\_ inch in place.

C. **Fertilizer, Chemical Nutrient.** The Engineer will measure **Fertilizer, Chemical Nutrient, CI** \_\_, of the type required, by the weight of nutrient in the fertilizer. The Engineer will determine the weight of chemical fertilizer nutrient for payment using the following formula:

$$T = W \times \sum N \qquad \text{Formula 816-1}$$

where:

*T* = The weight of chemical fertilizer nutrients applied,

*W* = Total fertilizer weight applied, and

*N* = The percentages of nutrients contained in the fertilizer used.

The unit price for **Fertilizer, Chemical Nutrient, CI** \_\_ includes the cost of conducting soil test to determine need for phosphorus before applying fertilizer.

D. **Sod.** The Engineer will measure **Sodding** in place.

E. **Mulching Material.** The Engineer will measure the following types of **Mulch Blanket** in place:

1. Excelsior mulch blankets,
2. Straw mulch blankets,
3. High velocity excelsior mulch blanket, and
4. High velocity straw mulch blanket.

For straw mulch, marsh hay mulch, or hay mulch, provide the Engineer with tickets, in triplicate, at the time of delivery, showing the number of

bales and weight of each load. Weigh the mulch on scales in accordance with subsection [101.04.F](#) and subsection [109.01.B.6](#).

The unit price for **Mulch** includes providing and spreading straw mulch, or marsh hay mulch, at the rate shown on the plans. The Department will not make adjustments if the Engineer allows the use of hay. If the Engineer allows dormant seeding, the Department will pay for mulching it at 1.5 times the unit price for **Mulch**.

The unit price for **Mulch Blanket, High Velocity** includes the cost of providing, placing, and anchoring the blankets.

The unit price for **Mulch Blanket** includes the cost of providing, placing, and anchoring the blankets. If the Contractor substitutes **Mulch Blanket, High Velocity** for **Mulch Blanket**, the Department will pay for the substitution at the unit price for **Mulch Blanket**.

The Engineer will measure **Mulch Anchoring** in place. The unit price for **Mulch Anchoring** includes the cost of providing and spraying the tackifier.

The Engineer will measure **Mulch Netting** in place. The unit price for **Mulch Netting** includes the cost of providing, placing, and anchoring netting.

F. **Water, Sodding and Seeding.** The Engineer will measure **Water Seeding/Sodding** in units; each unit is equal to 1,000 gallons.

G. **Weed Control.** The Engineer will measure **Weed Control** in place.

H. **Seeding, Mixture.** The Engineer will measure **Seeding Mixture** of the type required, in pounds of seed applied.

## Section 817. LANDSCAPE MOWING

**817.01. Description.** This work consists of picking up and properly disposing of litter, and mowing in accordance with state of Michigan regulations and local mowing ordinances.

**817.02. Materials.** None specified.

### **817.03. Construction.**

**A. Equipment.** Mowing equipment includes tractor drawn grass cutting equipment, and other power or hand equipment required to complete the work. Do not create a hazard, hindrance or delay to the public, or damage to the roadside.

Use equipment in good repair and maintain it to produce a neat, clean, and sharp cut to the grass. Do not use equipment that pulls or rips grass or otherwise damages the turf. Use equipment that can cut to 3 inches above the ground. Equip mowers with guards to prevent debris from being thrown from under the cutter.

The Department is not responsible for damage to the Contractor's equipment due to obstacles encountered during the work.

**B. Mowing and Trimming.** The Engineer will specify areas for mowing. Pick up, remove, and dispose of litter each day before mowing.

Hand trim, if required, next to walls, fences, curbs, poles or other fixed objects within the mowing area.

Mow landscaped areas to 3 inches high and roadside areas to 5 inches high. Cut hand trimming at walls and curbs flush to adjacent concrete or sidewalk.

**C. Repairing Damage.** Preserve and protect public or private property, along and adjacent to the roadway, and repair damage and injury that result from the performance of the work.

Immediately repair damage to signs, posts, light fixtures, handholes, and delineators. Repair damage to vegetation and ruts on turf areas, as directed by the Engineer.

Complete repairs in accordance with section [816](#) and section [917](#). Only seed during the seasonal limitation periods.

Replace damaged landscape plant material, in kind, in accordance with section [815](#) and section [917](#).

**817.04. Measurement and Payment.**

| <b>Pay Item</b> | <b>Pay Unit</b> |
|-----------------|-----------------|
| Mowing .....    | Acre            |

The unit price for **Mowing** includes the cost of trimming, litter and trash pick up and disposal, and repairing or replacing damaged vegetation.



**Section 818. DUNE GRASS PLANTING**

**818.01. Description.** This work consists of providing and planting native dune grass on slopes or other required areas.

**818.02. Materials.** Provide dune grass plants (Ammophila) from commercial sources in Michigan and obtain the Engineer’s approval of materials before planting.

**818.03. Construction.**

**A. Transporting Plants.** Maintain the moisture of the plants and protective material until planting.

**B. Planting.** Provide plants with at least one live rhizome and sufficient root stock to ensure continued growth following the transplant. Plant randomly, no greater than 12 inches between plants. Insert a shovel or planting iron into the soil at least 8 inches deep. Open the holes for planting using a single forward movement of the shovel or planting iron. Place the plant in the resulting opening with the crown slightly below the surrounding ground. Do not allow dry surface sand to enter the freshly opened hole. Remove the shovel or planting iron and foot-tamp the soil around the plant. Do not trim the plant. Mulch slopes, if required, before planting in accordance with subsection [816.03.E](#).

Do not disturb dune grass growing outside the limits of earth disturbance on the project.

**C. Seasonal Limitations.** Plant dune grass after September 1 and before the ground freezes.

**818.04. Measurement and Payment.**

| <b>Pay Item</b>           | <b>Pay Unit</b> |
|---------------------------|-----------------|
| Dune Grass Planting ..... | Square Yard     |

The Engineer will measure **Dune Grass Planting** by the area of actual ground surface planted.

## Section 819. ELECTRICAL AND LIGHTING

**819.01. Description.** This work consists of providing operating electrical and lighting units; removing, salvaging, or disposing of existing electrical and lighting components; excavating, backfilling, restoring the site; and disposing of waste excavated material. Complete this work in accordance with this section, section [820](#), and the contract and to the requirements of the NEC, the National Electrical Safety Code, and the Michigan Department of Labor and Economic Growth for those items not identified in the contract.

Provide personnel experienced and qualified to perform the work required. Ensure the on-site presence of a licensed journeyman electrician supervisor for the electrical system installation and during electrical construction. Contact the Michigan Department of Labor and Economic Growth for electric service inspection and pay the applicable fees.

**819.02. Materials.** Provide material in accordance with the following:

|  |                     |
|--|---------------------|
| Concrete, Grade S2.....                    | <a href="#">701</a> |
| Granular Material Class II.....            | <a href="#">902</a> |
| Coarse Aggregate 17A.....                  | <a href="#">902</a> |
| Light Standard and Tower Anchor Bolts..... | <a href="#">908</a> |
| Conduit .....                              | <a href="#">918</a> |
| Electrical Grounding System .....          | <a href="#">918</a> |
| Electrical Wire and Cable .....            | <a href="#">918</a> |
| Direct Burial Cable.....                   | <a href="#">918</a> |
| Equipment Grounding Conductor.....         | <a href="#">918</a> |
| Handholes .....                            | <a href="#">918</a> |
| Light Standard Foundation .....            | <a href="#">918</a> |
| Light Standard .....                       | <a href="#">918</a> |
| Luminaires .....                           | <a href="#">918</a> |
| Wood Poles .....                           | <a href="#">918</a> |
| Tower Lighting Unit.....                   | <a href="#">918</a> |

### A. Conduit.

1. **Direct Burial Application.** Provide a smooth surface conduit of one of the following types, for direct burial applications:
  - a. Galvanized steel conduit;
  - b. Smooth-wall, Schedule 40 rigid (PVC);
  - c. Smooth-wall, Schedule 80 rigid (PVC);
  - d. Smooth-wall, coilable, Schedule 40 (PE);
  - e. Smooth-wall, coilable, Schedule 80 (PE); or

f. Rigid fiberglass.

Provide Schedule 80 conduit for traffic signal work.

2. **Jacking and Boring Application.** Provide Schedule 80 PVC or Schedule 80 polyethylene conduit for jacking and boring operations.
3. **Directional Boring Application.** Provide Schedule 80 coilable polyethylene conduit for directional boring.
4. **Encased Conduit Application.** Provide Schedule 40 conduit for encased conduit and provide Grade S2 concrete made with 17A coarse aggregate in accordance with section [701](#).
5. **Conduit on Structure Application.** Provide Schedule 80 PVC or rigid fiberglass conduit on structures.

B. **Cable.** Provide the number of stranded copper conductors for overhead and underground cables shown on the plans, or directed by the Engineer.

### 819.03. Construction.

A. **Conduit.** Build straight conduit runs. If the contract requires sweeps, use the largest radius that will fit the work space available for each sweep.

Provide conduit fittings and use methods of joining conduits, including conduit cement, in accordance with current NEC methods. If the NEC does not clearly describe the method, install the conduits in accordance with the manufacturer's recommendation. Obtain the Engineer's approval of installation methods before beginning work.

Attach end bells on the ends of conduits entering handholes to prevent damage to the cable.

Install continuous coilable conduit between handholes.

Extend conduit, not terminating in structures such as manholes, handholes, or foundations, 2 feet beyond pavement limit unless otherwise required. Plug unoccupied conduit.

Ensure new conduit, inserted into existing manholes or handholes, does not interfere with racking, training of cables, or both. Do not disturb existing cables.

1. **Bends.** Bend conduit to the radii specified in the current NEC requirements. For conduit entering foundations or cable pole envelopes, provide conduit with factory bends.

2. **Excavation.** Excavate the conduit trench to provide an earth cover of at least 30 inches over the finished conduit.
3. **Drainage.** Grade the trench to provide drainage to handholes.
4. **Grades.** Stake conduit grades at no greater than 50-foot intervals, or as directed by the Engineer. Create a grade that slopes at least 4 inches over 100 feet to the lowest manhole or handhole, or from the middle of the conduit run toward both holes.
5. **Backfill.** Place Class II granular material and tamp before placing conduit.

Backfill trenches outside the roadbed with excavated material, suitable for backfill, as determined by the Engineer. If excavated material is unsuitable, backfill the trenches with Class II granular material in accordance with section [204](#).

Backfill trenches within the limits of the roadbed with Class II granular material in accordance with section [204](#).

6. **Supports.** Provide support for conduit running through holes built over or into existing duct. If ducts are built into an existing handhole, build a 4-inch tapered pocket into the wall. Build new service ducts into existing handholes without interfering with cable racking. Install required inserts.
7. **Clearances.** Do not allow conduit or concrete encasement to contact obstructions. Provide a vertical clearance of 9 inches, except provide at least 12 inches of clearance for conduit running parallel to water lines, gas mains, and other underground structures not part of the electrical system.

The Engineer and the owner of the obstruction will determine the method of protection if the Contractor cannot provide the required 12-inch clearance.

8. **Clearing.** After installing conduit runs, pull a mandrel 12 inches long, or shorter for conduit runs with bends, and with a diameter  $\frac{1}{2}$  inch smaller than the conduit. Attach a swab or cleaning device designed to clear the conduit, to the mandrel. Notify the Engineer before performing clearing work.
9. **Encased Conduit.** Encase conduit runs in Grade S2 concrete. Space adjacent conduits, at least 1 inch apart and fill the space with concrete. Provide a conduit encasement with at least 3 inches of concrete around the conduit. If steel reinforcement is required, separate the reinforcing bars from the conduits with 2 inches of

concrete. Provide at least 3 inches of concrete cover between the reinforcing bars and the surface of the encasement. Stagger conduit joints vertically.

Use concrete, plastic, or bituminized fiber as separators, spacers, blocks, or supports that will remain in the finished concrete encasement. If installing 20-foot lengths of conduit, place spacers no greater than 7 feet apart. If installing 10-foot lengths of conduit, place spacers no greater than 5 feet apart.

Prevent the conduit bank from floating after concrete placement by anchoring the bank to stakes at intervals no greater than 10 feet apart in firm soil and no greater than 5 feet apart in loose soil.

Ensure the concrete fully encases the conduit.

- a. **Tier by Tier Method.** Grade the trench and place a foundation of concrete at least 3 inches thick in the bottom of the trench. If steel reinforcement is required, place the concrete at least 5 inches thick with reinforcing bars in place. Lay the bottom tier of conduits, separated by spacers. Fill the space between conduits with concrete and cover the conduits to the height of the next conduit tier. Construct succeeding tiers as specified for the first tier. Ensure continuous placement of successive tiers of conduit with interruptions no greater than 45 minutes.
- b. **Build-Up or Monolithic Methods.** Grade the trench and place masonry supports at intervals from 3 feet to 5 feet apart, or a foundation of concrete at least 3 inches thick in the bottom of the trench. If steel reinforcement is required, place the concrete at least 5 inches thick with the reinforcing bars in place. Place the conduit using plastic or concrete separators, to erect a rigid, self-supporting structure of conduit. Place the concrete to fill the spaces between the conduits completely, without damaging or displacing them.

Ensure the Engineer inspects conduit before encasing in concrete.

Place a coupling on the ends of conduit and install a removable plug. Sheet and brace the trenches as required. Support pipes or other structures exposed in the trenches as required to prevent damage.

10. **Directional Bore.** Bore by augering or jacking a steerable rod and pulling back a cone reamer that expands the soil or a wing cutter that cuts a hole to the required diameter. Use a reamer or wing cutter

with a diameter no greater than 2 inches larger than the conduit, as shown on the plans.

The Contractor may use a drilling fluid of water and bentonite in directional drilling. The Contractor may use a polymer for lubrication in the drilling fluid.

Place directional bore or drill equipment and supplies so they do not interfere with traffic or with the use of adjacent property. Locate equipment and supplies a minimum distance from the edge of pavement as directed by the Engineer. Place access pits in the location of handholes, at the boring termination points, as shown on the plans or directed by the Engineer.

## 11. Jacking and Boring.

- a. **Compaction Auger (packer, expander).** Auger a rotating stem under the roadway then pull back a series of graduated cones that displace the soil to obtain the required diameter.
- b. **Hydraulic Push Rods or Stem (pipe puller, packer).** Push rods or stems under the roadway with a hydraulic ram and pull a series of graduated cones that displace the soil to obtain the required diameter.
- c. **Other Methods.** The Engineer may approve other jacking and boring methods before construction. Do not jet, or use water or air ahead of the casing.

The Contractor may use air rams longitudinally in the right-of-way, but may use under roadways only if approved by the Engineer.

Before jacking and boring, excavate a starter alignment trench to the elevation of the proposed conduit. Excavate a length of level trench at least 15 feet long for trenches up to 4 feet deep, and increase the trench length 5 feet for each additional 1 foot of depth.

Use guide rails, sills, or other positive alignment devices to start the crossing. Restrain drive rods against horizontal and vertical movement.

If using heads to develop an opening with a diameter greater than 2 inches, develop openings by increasing the head size in 1-inch increments.

If the highway is super-elevated, start the bore from the lower side of the pavement.

The Engineer will determine if conditions warrant the use of sheeting and bracing. Use sheeting and bracing for boring as directed by the Engineer if access pits are located within the 1:1 slope from the edge of paved surfaces or back of curbs.

Place access pits in the location of handholes, at the boring termination points, as shown on the plans or directed by the Engineer.

Provide the bore and jack record sheet or log if requested by the Engineer.

Control ground water entering the excavation from seepage layers and lenses or pockets of saturated material from inside the excavation using drainage, bailing, pumping, or other methods. Do not remove or disturb adjacent soil while draining the ground water.

If ordinary methods of drainage prove unsatisfactory, as determined by the Engineer, drain excavations as required.

**12. Record Drawings.** Within five days after completing conduit work, or installing working cables, provide a record drawing to the Engineer. Show deviations from the original plans. Measure the lengths from the inside walls of the handholes and the center of post foundations and cable poles.

**B. Electrical Wire and Cable.** The Contractor may energize electrical wire and cables with a voltage no greater than 250 Volts alternating current (VAC).

Permanently tag wires and cables, in manholes, handholes, and cabinets at the points of entrance, exit, splicing, and termination. Label wires and cables to indicate the source and use of each. Tag wires and cables in manholes and handholes with a stamped brass tag.

Provide wires and cables with an additional length of at least 10 feet in each manhole and handhole.

Seal cable ends where the plans show coiling of cable.

Cut and remove cables within handholes and manholes for abandoned underground cables as shown on the plans.

Permanently label detector wiring harnesses at the connector with the source and use.

Do not splice signal cables or interconnect cables for traffic signals unless indicated in the plans.

C. **Direct Burial Cable.** Provide and install single conductor, direct burial cable.

1. **Approval.** Unless otherwise specified in the contract, the Department is the agency responsible for maintaining direct burial cable facilities. Provide certified test reports to the maintaining agency upon request.
2. **Installation.** Install direct burial cable as shown on the plans and in accordance with the manufacturer's recommendations. Do not drag cable on the ground. Do not splice cable underground. Install cable in continuous runs between manholes, handholes, or foundations.
3. **Location.** Install direct burial cable parallel to the edge of pavement, along the shoulder edge, clear of guardrail locations. Place cable in a straight line between visible reference points such as handholes or light standards.
4. **Excavation.** After compacting the subbase in the shoulder area to at least the elevation of the top of the base course, cut a trench at least 10 inches deep along the shoulder edge for placement of the direct burial cable.

Remove rocks or other sharp objects from the trench. Lay the cable in the trench.

Install marking tape from 6 inches to 18 inches above underground conduit or cable. Do not install marking tape above jacked and bored conduit. The Department will provide the marking tape.

Provide 3 feet of cover over direct burial cable installed outside the shoulder.

5. **Cable Installed In Conduit.** If installing direct burial cable in conduit, use clean conduit, free of rough spots.

Avoid damage to insulation and cable jackets during installation.

When required, use lubricating compounds approved by the cable manufacturer. Use UL listed, non-injurious lubricants, on conduits, conductors, insulations, or jackets.

Provide slack in each run of cable.

Group multiple wires, trained through a box, manhole or handhole, by circuit. Bundle them using cable ties, and support them to reduce pressure or strain on cable insulation. Bend wire and cable in accordance with the manufacturer's recommended bending radius, during installation and in permanent placement.



Use a cable pulling apparatus with no sharp edges or protrusions.

6. **Testing.** Test direct burial cable for continuity, shorts, and grounds after installation and backfill. Replace cables that fail field tests with new cable at no additional cost to the Department.

D. **Equipment Ground Conductor.** Provide and install equipment grounding conductors (bare or THHN) to provide a continuous grounding of equipment throughout the electrical system. Install equipment grounding conductors and connect to light standard shafts, span wire, and ground rods to construct a continuous connection from the control cabinet to the light standards.

If installing conductors directly in earth with no conduit protection, the Contractor may use a bare conductor. Install the conductor 4 inches above the electric cable.

If installing the conductors in conduit, insulate the conductor and color code with green. Avoid damaging the conductor during installation.

Extend equipment ground conductor runs individually to the ground bus of the lighting controller.

E. **Handholes.** Provide and install, remove, salvage, reconstruct, abandon or adjust handholes, including covers and fittings as shown on the plans.

If the plans show existing cables maintained in new handholes, break and remove conduit and concrete encasements to the walls of the new handhole. Extend existing cables, train, rack, and support on the walls of the handhole.

1. **Remove or Abandon.** Remove handholes completely or abandon in accordance with section [204](#).
2. **Adjust.** Adjust handholes in accordance with section [403](#).
3. **Reconstruct.** Reconstruct handholes in accordance with section [403](#). Use existing frames and covers, unless otherwise directed by the Engineer.
4. **Installation.** Ensure handholes are flush with the pavement surface and 1 inch above grade outside paved areas. Install the frame and cover flush with the top of the handhole.

Use cast-in-place or precast reinforced concrete handholes.

Make the inner surface of reinforced handholes smooth. Sandblast castings. Cast handholes free of pouring faults, blow holes, cracks, and other imperfections. Cast handholes sound, true to form and

thickness, clean, and finished. Coat the castings with coal tar pitch varnish.

Provide and install cable racks and hooks.

Plug unused conduit entrances and conduit openings for future use by others with removable plastic plugs or other plugs approved by the Engineer.

Remove rubbish, construction debris, and water from handholes. Grout conduits from outside the handholes to inside the handholes.

5. **Excavation.** Excavate to the diameter and depth for installing handholes at locations shown on the plans.
6. **Drainage.** Cast drain holes at the bottom of the handhole. Ensure drainage of handholes installed over underground conduits and on bridge decks.
7. **Backfill.** Install the handhole on Class II Granular Material. The Engineer will determine if excavated material meets the backfill requirement. Use Class II granular material if the Engineer determines excavated material does not meet the backfill requirement.

#### F. **Light Standard Foundation.**

1. **General.** Install light standard foundations as shown on the standard plans.
2. **Remove.** Remove foundations in accordance with section [204](#) and restore the site as directed by the Engineer.
3. **Installation.** Drill foundation holes with an auger of the same diameter as the foundation. If the diameter of the auger cannot accommodate the planned foundation size, excavate the hole.

Do not use construction rubble, broken sidewalk, or other deleterious material in place of concrete in the foundation. The Engineer will not accept cracked or otherwise deformed foundations.

Obtain the Engineer's approval before placing foundations. Secure steel reinforcement, raceway conduits, and anchor bolts to each other in the augured hole to prevent displacement during concrete placement. Position anchor bolts accurately. Maintain the vertical alignment of anchor bolt projections on top of the foundation. Space the anchor bolts on the bolt circle and parallel to the curb. Place the lower portion of the foundation without forms, if the soil is stable and

the hole remains open. For unstable soil conditions, subject to cave-in, use forms for the entire depth of the hole for the foundation.

Form the upper 12 inches of the foundation and provide a smooth finish and a horizontal top surface.

Cure the foundations 7 days before installing bases and standards.

Backfill with Class II granular material. The Engineer will determine if excavated material meets the backfill requirement. If the Engineer determines excavated material does not meet the backfill requirement, use Class II granular material.

**G. Light Standard.** Install light standards, consisting of the light standard shaft and light standard arm, on new foundations, bridges, retaining walls, concrete barrier walls, frangible transformer bases, or other structures. Use new or salvaged materials.

1. **Submittals.** Submit Test Data Certifications for fabricated light standard and frangible transformer bases.

Before installation, submit a complete set of light standard installation shop drawings, including fabrication drawings, to the Engineer for approval.

Provide final approved shop drawings to the Engineer. Include contract and project numbers on the drawings.

2. **Shipping.** Provide clean shafts, free of scratches, dents, or similar disfiguring marks.

Provide round standards with a uniform finish. Provide protection for the standards during shipping, handling, storage, and erection.

Repair galvanized coating on light standard components, damaged in transportation, handling, or erection, in accordance with subsection [716.03.E](#), and at no additional cost to the Department.

3. **Testing.** At the Engineer's option, conduct testing as follows:
  - a. Apply a 250-pound vertical load within 3 inches of the luminaire end of the bracket arm.
  - b. The standard must sustain the 250-pound load without collapsing or rupturing portions of the standard assembly.
  - c. The test load may permanently deform the bracket arm, provided no part collapses, ruptures, tears apart, or fails, causing the weight to fall to the ground.

- d. Replace bracket arms deformed by the test load. The Engineer will measure replacement bracket arms for payment provided the original bracket arms meet or exceed all test parameters.
4. **Light Standard Frangible Base.** Provide and install, or remove, light standard frangible bases.

- a. **Light Standard Frangible Base – Remove.** Remove the frangible base from the foundation. Take ownership of the removed frangible base.
- b. **Construction.** Install frangible transformer bases on concrete foundations. Finish the top surface of the concrete foundation level to within  $\frac{1}{4}$  inch over 10 feet of level. The Engineer will not allow the use of steel shaft foundations. Mount the frangible base directly on the concrete foundation and secure to the anchor bolts in accordance with manufacturer's specifications. Use lock washers. Do not use leveling nuts. Mount the frangible transformer base to the concrete foundation so the tabs project at least  $\frac{1}{2}$  the anchor bolt diameter beyond the nut. Complete the anchor bolt installation and tightening in accordance with subsection [810.03.N](#).

Tighten bolts connecting the pole to the frangible base in accordance with subsection [707.03.D.7](#). Use lock washers. Do not use bolt or nut covers.

Use a beveled washer to compensate for slopes greater than  $\frac{1}{4}$  inch over 10 inches level on surfaces in contact with the bolt head and nut in accordance with subsection [810.03.N](#).

- c. **Inspection.** Notify the Engineer, in writing, to request final inspection of light standard frangible bases. The Engineer will schedule and complete the inspection within 21 calendar days from receipt of the written request. The Engineer will arrange for the inspection in accordance with subsection [707.03.D.7.c](#), subsection [810.03.N](#), and subsection [819.03](#).
- d. **Reporting.** The Structural Fabrication Engineer will notify the Engineer within the 21 calendar day inspection period about the acceptance or rejection of items. The Structural Fabrication Engineer will provide written inspection reports to the Engineer within the 21 calendar day inspection period.

Correct rejected items in accordance with subsection [707.03.D.7.c](#), subsection [810.03.N](#), and subsection [819.03](#) at no additional cost to the Department.

5. **Light Standard Arm.** Provide and install, or remove, light standard arms, including bracket arm assemblies.
  - a. **Light Standard Arm — Install.** Install light standard arms, provided by the Engineer, on the required light standard shafts.
  - b. **Light Standard Arm — Install Salvaged.** Install light standard arms, salvaged in accordance with subsection [819.03.G.5.d](#), on the required light standard shafts.
  - c. **Light Standard Arm — Remove.** Remove light standard arms from the shaft. Take ownership of removed light standard arms.
  - d. **Light Standard Arm — Remove and Salvage.** Remove and salvage light standard arms from the shaft. Transport light standard arms and hardware to a storage location, if required, as shown on the plans or otherwise directed by the Engineer.  
  
Replace parts of light standard arms, damaged during disassembly, handling, or storage operations, at no additional cost to the Department.
  - e. **Light Standard Arm.** Provide and install light standard arms on the required light standard shafts.
6. **Light Standard Shaft.** Provide and install, or remove light standard shafts. The light standard shaft includes the shaft, anchor base, associated hardware, and No. 8 pole wire extending from the fusing at the base of the pole to the luminaire. Install two wires for each luminaire.
  - a. **Light Standard Shaft — Install.** Install light standard shafts, provided by the Engineer, on the required light standard foundations.
  - b. **Light Standard Shaft — Install Salvaged.** Install light standard shafts, salvaged in accordance with subsection [819.03.G.6.d](#), on the required light standard foundations.  
  
Replace parts of light standard shafts damaged during reassembly, at no additional cost to the Department.
  - c. **Light Standard Shaft — Remove.** Remove light standard shafts from the foundations. Take ownership of removed light standard shafts.
  - d. **Light Standard Shaft — Remove and Salvage.** Remove and salvage light standard shafts from the foundations. Transport

light standards and hardware to a storage location, if required, as shown on the plans or otherwise directed by the Engineer.

Replace parts of light standard shafts, damaged during disassembly, handling, or storage operations, at no additional cost to the Department.

- e. **Light Standard Shaft — Single, Double, or No Arm.** Provide and install light standard shafts of the length required for single, double, or no arm light standards on the light standard foundations shown on the plans. If the plans show no arm light standard shafts, include the tenon at the top of the pole with the light standard shaft.
7. **Installation Details.** Install the light standards to a vertical position for the upper one-third of the shaft with the bracket arm and luminaire attached. Erect bracket arms at right angles to the edge of pavement. Install light standards so the handhole faces away from oncoming traffic. On barrier wall and bridge installations, install the handhole facing, and accessible from, the roadway.

Splice wire at access points, including handholes or access holes located on the shaft of the light standards. Loop direct burial wire up into the standards and make connections at the handholes.

Bond joints, insulate, and tape in accordance with the manufacturer's specifications for the type and cable voltage class. Use lug connectors or solder with non-corrosive flux for bonding joints. Use UL-approved plastic tape. Provide moisture-proof joints, insulated for the required voltage. Submit, to the Engineer for approval, samples of pre-insulated, solderless connectors, or mechanical connectors requiring special tools.

The Contractor may install luminaires with the light standards.

If installing luminaires with light standards, repair interior and exterior damage to the luminaires before operation, at no additional cost to the Department.

Ground the light standards in accordance with the current NEC requirements unless the local agency requirements exceed NEC grounding practices.

- H. **Luminaires.** Provide and install, or remove and salvage luminaires. Use new or salvaged luminaires, as shown on the plans.
1. **General.** Provide luminaires of the type, size and lighting distribution pattern shown on the plans.

Individually package luminaires for shipment.

Paint the hood and refractor supporting member of cobra head luminaires gray.

2. **Submittals.** Provide the Engineer with a drawing showing a general diagram of the luminaire unit and the assembly and installation method.

Provide a General Certification for luminaires.

3. **Luminaire.** Install luminaires of the size, type, and lighting distribution shown on the plans.
  - a. **Luminaire — Install Salvaged.** Install luminaires, salvaged in accordance with subsection [819.03.H.3.c](#), on the light standard shaft and arm shown on the plans.
  - b. **Luminaire — Remove.** Remove luminaires from the shaft and arm. Take ownership of the removed luminaires.
  - c. **Luminaire — Remove and Salvage.** Remove and salvage luminaires from the shaft and arm. Transport the luminaires and hardware to a storage location, if required, as shown on the plans or otherwise directed by the Engineer.

Replace parts of the luminaires damaged during disassembly, handling, or storage operations, at no additional cost to the Department.

4. **Installation.** Clean the luminaire reflector and glassware after installation in accordance with the manufacturer's recommendations.
- I. **Tower Lighting Unit.** Construct tower lighting unit foundations in accordance with subsection [810.03.J](#) and subsection [810.03.K](#). Provide and install tower lighting units with steel shafts and base plates, head frame assemblies, luminaire mounting rings, luminaires with ballasts and lamps, lowering devices, fused safety switches, lightning arresters, rodent screens, and related items to mount operating tower lighting units on foundations.
1. **Submittals.** Before fabrication, submit three copies of complete tower lighting unit shop drawings, including welding details, to the Engineer for approval. Include contract and job numbers.

Provide three sets of the approved drawings to the Engineer.

Submit a Test Data Certification covering the material used by the fabricator in the fabrication of the lighting installation. The Engineer may request check tests on certified material.

Submit the manufacturer's certification of the tower lighting unit design. Submit three copies of design calculations for the following:

- a. Stress sized components of luminaire mounting rings,
  - b. Head frame assembly lowering devices,
  - c. Poles at joints, and
  - d. Sections through handholes and anchor bases.
2. **Shipping.** Repair galvanized poles and related components, damaged in transportation, handling or erection, in accordance with subsection [716.03.E](#), at no additional cost to the Department.
3. **Installation.** Obtain the Engineer's approval for the pole assembly method before beginning the work.

After raising the luminaires to the normal operating position, ensure the center of the apparent light source of each luminaire is within 2 feet of the nominal mounting height, as measured from the top of the foundation.

Provide and erect the pole without field welds.

Field assemble sectional poles before erecting on the foundations.

During the final assembly, place the pole on aligned supports and apply force to seat each splice. Use axial or concentric compressive loading applied by hydraulic jacks, turnbuckles, or cable coffering hoists, to obtain the last 3 inches of the lap. To ensure required lapping of the joint, place a temporary circumferential mark outside the lower tube. Mark the lower tube a distance of  $1\frac{1}{2}$  times the diameter plus 12 inches from the top. Consider the joint tight, when the bottom of the overlapping section is within 12 inches, measured equally around the pole, of the temporary mark.

Erect the tower lighting unit so the horizontal offset at the top of the pole is within 4 inches of the true vertical position with respect to the base of the pole, and the offset at the midpoint of the pole is equal to or less than one-quarter of the offset position at the top of the pole. Install a rodent screen at the base of the pole, galvanized in accordance with ASTM A 123.

The Engineer will direct when and how to determine pole alignment after erection.

4. **Field Test.** After anchoring the tower shaft in place, notify the Engineer to arrange for MDOT personnel to witness the raising and lowering of the luminaire ring. Raise and lower the ring at least three times.



Raise the ring to the working position and visually check to verify horizontal position. Energize the lamps and allow them to burn for at least 15 minutes before lowering. After lowering, inspect the ring for cable tension, levelness, hardware tightness, electrical connections, and power cord adjustments. Adjust the unit to ensure required operation of the lowering device and electrical system.

If the operation of the ring requires more adjustments after the required tests, raise the ring until operational deficiencies are corrected.

The Engineer will document successful completion of this field test before approving of the tower for operation.

**J. Wood Pole.** Provide and install, relocate, or remove wood poles and associated hardware for supporting span wire and bracket arm mounted traffic signals, and guying the pole if required.

Tamp the earth replaced around new or relocated poles. Fill, tamp, and level holes after removing poles. Use hot dip galvanized turnbuckles, tension tie bars, and associated steel hardware in accordance with ASTM A 153.

Set wood poles to the minimum depths specified in Table 819-1:

| <b>Table 819-1<br/>Wood Pole Lengths and Depths</b> |              |
|---|--------------|
| <b>Pole Length</b>                                  | <b>Depth</b> |
| 35 ft Class 4 pole                                  | 6 ft         |
| 40 ft Class 4 pole                                  | 6 ft         |
| 45 ft Class 4 pole                                  | 6½ ft        |
| 50 ft Class 4 pole                                  | 7 ft         |
| 55 ft Class 4 pole                                  | 7½ ft        |
| 60 ft Class 4 pole                                  | 8 ft         |

**819.04. Measurement and Payment.**

| <b>Pay Item</b>   | <b>Pay Unit</b> |
|---|-----------------|
| Conduit, Rem.....   | Foot            |
| Conduit, Encased, (number), __ inch.....                  | Foot            |
| Conduit, Directional Bore, (number), __ inch.....         | Foot            |
| Conduit, DB, (number), __ inch.....                       | Foot            |
| Conduit, (type), __ inch, Structure.....                  | Foot            |
| Conduit, (type), __ inch.....                             | Foot            |
| Conduit, Schedule (number), __ inch.....                  | Foot            |
| Conduit, Jacked Bored, (number), __ inch.....             | Foot            |
| DB Cable, 600 Volt, 1/C# (size).....                      | Foot            |
| DB Cable, in Conduit, 600 Volt, (number) 1/C# (size)..... | Foot            |

|   |      |
|---|------|
| DB Cable, in Conduit, 600 Volt, 1/C# (size) .....         | Foot |
| DB Cable, in Conduit, Rem .....                           | Foot |
| Cable, Rem.....   | Foot |
| Cable, (type), Rem .....                                  | Foot |
| Cable Pole, (type), Disman.....                           | Each |
| Cable, P.J., 600 Volt, 1, (size) .....                    | Foot |
| Cable, Sec, (volt), (number), (size) .....                | Foot |
| Cable, Sec, (type), (number), (size) .....                | Foot |
| Cable, Shielded, (volt), (number), (size), (type) .....   | Foot |
| Cable, St Ltg, (volt), (number), (size), (type).....      | Foot |
| Cable, Equipment Grounding Wire, 1/C# (size) .....        | Foot |
| Elec Serv, Rem.....                                       | Each |
| Hh, (type).....   | Each |
| Hh, (type), (size) .....                                  | Each |
| Hh, (work).....   | Each |
| Light Std Fdn .....                                       | Each |
| Light Std Fdn, Rem.....                                   | Each |
| Light Std, Frangible Transformer Base .....               | Each |
| Light Std, Frangible Transformer Base, Rem.....           | Each |
| Light Std Arm, (work).....                                | Each |
| Light Std Arm, __ foot.....                               | Each |
| Light Std Shaft, (work).....                              | Each |
| Light Std Shaft, Square, __ foot .....                    | Each |
| Light Std Shaft, 30 foot or less .....                    | Each |
| Light Std Shaft, __ foot to __ foot.....                  | Each |
| Light Std Shaft, 30 foot or less, Single Arm.....         | Each |
| Light Std Shaft, __ foot to __ foot, Single Arm .....     | Each |
| Light Std Shaft, 30 foot or less, Double Arm .....        | Each |
| Light Std Shaft, __ foot to __ foot, Double Arm.....      | Each |
| Luminaire .....   | Each |
| Luminaire, (work).....                                    | Each |
| Luminaire, (watt) High Pressure Sodium.....               | Each |
| Luminaire, (watt) High Pressure Sodium, Spec .....        | Each |
| Luminaire, (watt) High Pressure Sodium, Rectangular ..... | Each |
| Tower Ltg Unit, __ foot (Number) Luminaire .....          | Each |
| Tower Ltg Unit, Fdn Cased.....                            | Foot |
| Tower Ltg Unit, Fdn Uncased.....                          | Foot |
| Wood Pole .....   | Each |
| Wood Pole, Cl __, __ foot.....                            | Each |
| Wood Pole, Rem .....                                      | Each |
| Wood Pole, Fit Up, (type) .....                           | Each |
| Concrete Pole, Fit Up, (type) .....                       | Each |
| Steel Pole, Fit Up, (type) .....                          | Each |

Unless otherwise required, the unit prices for the pay items listed in this subsection include the cost of excavation, granular material, backfill, disposal of waste excavated material, and reestablishing turf in kind.

**A. Conduit.** The Engineer will measure conduit in place, from the inside walls of manholes, and the centers of handholes, post foundations, and cable poles.

The unit prices for **Conduit, Rem; Conduit, (type), \_\_\_ inch** and **Conduit, DB, (number), \_\_\_ inch** include the cost of installing or removing the type, number, and size of direct buried conduit shown on the plans, and installing marking tape.

The unit price for **Conduit, (type), \_\_\_ inch, Structure** includes the cost of providing and installing the conduit components, hardware, and other appurtenances required.

The unit price for **Conduit, Jacked Bored, (number), \_\_\_ inch** includes the cost of installing rigid metal, or Schedule 80 PVC conduit.

The unit price for **Conduit, Directional Bore, (number), \_\_\_ inch** includes the cost of installing Schedule 80 polyethylene conduit.

The unit price for **Conduit, Encased, (number), \_\_\_ inch** includes the cost of the following:

1. Installing conduits,
2. Installing sheeting and bracing,
3. Removing boring pits, and
4. Filling voids.

The unit price for **Conduit, Schedule (number), \_\_\_ inch** includes the cost of installing conduit approved for direct burial applications, as specified in subsection [819.02.A.1](#), and installing marking tape.

**B. Direct Burial Cable.** The Engineer will measure cables in place for the total length of the required conductors, single, multiple, or both.

The Engineer will measure direct burial cable, at grade, between centers of handholes, light standards, and poles.

The Engineer will not measure the following cable portions:

1. Looping,
2. Sag,
3. Trainers,
4. Splicing,
5. Racking,
6. Slack length, or

7. Length inside equipment.

The Engineer will measure the vertical length of cable from 2½ feet below grade to the pot head or service head at cable poles.

The unit prices for the relevant direct bury cable pay items include the cost of marking tape, bonding, tagging, and making splices, terminations, and connections.

The unit price for **DB Cable, in Conduit, 600 Volt, 1/C# (size)** includes the cost of pulling the cable in the conduit.

The unit price for **DB Cable, In Conduit, Rem** includes the cost of removing cables from the existing conduit.

**C. Cable, Removal.** The unit prices for **Cable, Rem** and **Cable, \_\_, Rem** include the cost of dead ending, circuit cutting, installing guying, work required to leave circuits operable, and disposing of the removed cables, wire, hardware, and other appurtenances.

The unit prices for other items of work include the cost of abandoning cables and conduit.

**D. Cable, Pole Dismantle.** The unit price for **Cable, Pole, \_\_, Disman** includes the cost of dismantling and off-site disposal of the following:

1. Riser pipe,
2. Cross arms,
3. Lightning arrestors,
4. Pot heads,
5. Cutouts,
6. Molding,
7. Weather cap,
8. Concrete encased bend, and
9. Other related materials.

**E. Cable, P.J.; Cable, Section; Cable, Shielded, and Cable, Street Lighting.** The Engineer will measure **Cable, P.J., Cable, Sec, Cable Shielded,** and **Cable, St Ltg,** of the type required, including the number and size of conductors, in place from centers of manholes or handholes and between wood poles, and will add 10 feet of cable for every handhole.

The unit prices for **Cable, P.J., Cable, Sec, Cable Shielded,** and **Cable, St Ltg,** of the type required, include the cost of the following:

1. Racking in manholes and handholes;
2. Bonding and tagging cables in manhole and handhole identifications;
3. Making splices and connections;

4. Cutting cable and re-splicing for service to traffic signals; and
5. Providing and installing the cable components, hardware, and other appurtenances required.

**F. Cable, Equipment Grounding Wire.** The Engineer will measure **Cable, Equipment Grounding Wire, 1/C# (size)** in a straight line between changes in direction and to the centers of light standards and the control cabinet. The Engineer will measure only one equipment grounding conductor if more than one circuit conductor run is installed in conduit.

The unit price for **Cable, Equipment Grounding Wire, 1/C# (size)** includes the cost of the following:

1. Installing grounding conductor in conduit,
2. Vertical conductors and required slack,
3. Bonding,
4. Tagging, and
5. Making splices and connections.

For traffic signals, the Department considers equipment grounding incidental to electrical work and will not pay for it separately.

**G. Electrical Service, Removal.** The unit price for **Elec Serv, Rem** includes the cost of returning the meter to the local utility company, and disposing of the removed concrete encased conduit, cables, hardware, and other appurtenances.

**H. Handholes (Hh).** The unit prices for handhole pay items include the cost of removing concrete encasement and conduit where new manholes or handholes access an existing conduit run as indicated on the plans, and installing cable racks and hooks.

The Department differentiates between **Hh, (type)** and **Hh, (type), (size)** based on the size, and type of material to construct the handhole.

The unit prices for **Hh, (type)** and **Hh, (type), (size)** include the cost of the frame and cover, ground rods, and treated wood foundations.

The Department will differentiate **Hh, (work)** pay items by the activities required to complete the work. The following pay items are **Hh, (work)** pay items:

1. **Handhole Adjust.** The unit price for **Hh, Adj** includes the cost of using existing frames and covers.
2. **Handhole Abandon.** The Engineer will measure **Hh, Abandon** by planned quantities. The unit price for **Hh, Abandon** includes the

cost of removing the frame and cover, and breaking down the wall structure.

The unit price for **Hh, Access** includes the cost of installing the following:

- a. Access handhole openings and covers in existing steel poles,
- b. Additional hardware,
- c. Reinforcing frames,
- d. Stainless steel screws, and
- e. Other material required to complete the work.

3. **Handhole Reconstruct, Remove, and Salvage.** The unit price for **Hh, Reconst** includes the cost of using existing frames and covers.

The unit price for **Hh, Rem** includes the cost of removing the handhole and restoring the site.

The unit price for **Hh, Salvage** includes the cost of installing salvaged handholes.

- I. **Light Standard Foundation.** The unit price for **Light Std Fdn** includes the cost of providing and installing the anchor bolts, conduit, hardware, and other appurtenances required.

The unit price for **Light Std Fdn, Rem** includes the cost of removing and disposing of foundations.

The Engineer will withhold 40 percent of the total contract value for **Light Std, Frangible Transformer Base** and **Light Std Fdn** until completion of inspection and reporting requirements specified in subsection [819.03.G.4.](#)

- J. **Light Standard Arm.** The unit price for **Light Std Arm**, of the size required, includes the cost of removing, installing, or salvaging light standard arms.

1. **Light Standard Shaft.** The unit price for light standard shaft pay items include the cost of installing the light standard shaft on the foundation or frangible transformer base, and providing street lighting circuit cable cutting, and splicing.
2. **Luminaire.** The unit price for **Luminaire** includes the cost of the following:
  - a. Luminaire,
  - b. Lamp,
  - c. Wiring,
  - d. Other material, and

e. Providing connections for making luminaire operational.

The unit price for **Luminaire (watt), High Pressure Sodium** includes the cost of providing and installing the complete luminaire, including the ballasts, lamps, and associated hardware and wiring.

**K. Tower Lighting.** The unit price for **Tower Ltg Unit, \_\_ foot, \_\_ Luminaire** includes the cost of the following:

1. Erection,
2. Aligning plumb,
3. Anchoring to the foundation,
4. Electrically wiring for operation, and
5. Testing of the unit.

The Engineer will measure **Tower Ltg Unit, Fdn Cased** and **Tower Ltg Unit, Fdn Uncased** vertically from the bottom to the top of the shaft. The unit prices for **Tower Ltg Unit, Fdn Cased** and **Tower Ltg Unit, Fdn Uncased** include the cost of providing and installing the anchor bolts, conduit, casing, hardware, and other appurtenances required.

**L. Wood Pole.** The unit price for **Wood Pole** includes the cost of providing and installing pole markers, additional support, components, hardware, and other appurtenances required, and transferring wires from old to new poles.

The unit price for **Wood Pole, Cl \_\_, \_\_ foot** includes the cost of guying wood poles of the required class.

The Engineer will measure **Wood Pole, Rem** based on plan quantities.

The unit price for **Wood Pole, Rem** includes the cost of removing and storing, if required, poles, concrete, pole bases and hardware.

The unit price for **Wood Pole, Fit Up** includes the cost of arranging wire on poles, and providing and installing the components, wires, hardware, and other appurtenances required.

**M. Concrete Pole, Fit Up.** The unit price for **Concrete Pole, Fit Up** includes the cost of providing and installing the conduit, wires, hardware, and other appurtenances required.

**N. Steel Pole, Fit Up.** The unit price for **Steel Pole, Fit Up** includes the cost of providing and installing the conduit, wires, hardware, and other appurtenances required.

## Section 820. TRAFFIC SIGNALS

**820.01. Description.** This work consists of providing required components to complete the following:

- A. Provide complete, operating traffic and pedestrian signals, span wires, strain poles, pedestals, illuminated case signs, traffic loops, and digital loop detectors and cabinets;
- B. Remove, salvage, or dispose of traffic and pedestrian signals, span wires, mounting assemblies, strain poles, pedestals, illuminated or non-illuminated case signs, traffic loops, and digital loop detectors, controller, and cabinets;
- C. Relocate or re-install, on the project, existing traffic control equipment, traffic and pedestrian signals, mounting assemblies, strain poles, pedestals, illuminated or non-illuminated case signs, and digital loop detectors, controller, and cabinets removed;
- D. Excavate, backfill, restore the site in kind, and dispose of excess or unsuitable material;
- E. Take ownership of and properly dispose of removed material not identified for salvage; and
- F. Store salvaged equipment in a protected and clean environment before installation on the project.

Provide qualified individuals to supervise and complete this work.

The Department uses the abbreviations in Table 820-1 for traffic signals on the plans and in these specifications.

| Abbreviation | Definition   |
|--------------|--|
| TS           | Traffic signal, pedestrian signal, and flasher signal designated by a number |
| LTGA         | Left-turn green arrow  |
| RTGA         | Right-turn green arrow   |
| STGA         | Straight-through green arrow   |
| CS           | Case sign  |
| LED          | Light Emitting Diode   |

**820.02. Materials.** Provide materials in accordance with the following:

|   |                     |
|---|---------------------|
| Anchor Bolts .....                                      | <a href="#">908</a> |
| Span Wire .....   | <a href="#">921</a> |
| Traffic Loop.....                                       | <a href="#">921</a> |
| Vehicular Traffic Signals and Mounting Assemblies ..... | <a href="#">921</a> |
| Pedestrian Signals .....                                | <a href="#">921</a> |
| Traffic Signal Strain Pole .....                        | <a href="#">921</a> |
| Traffic Signal Pedestal.....                            | <a href="#">921</a> |



|                                 |                     |
|---------------------------------|---------------------|
| Illuminated Case Signs.....     | <a href="#">921</a> |
| Non-Illuminated Case Signs..... | <a href="#">921</a> |
| Digital Loop Detector.....      | <a href="#">921</a> |
| Steel Truss Arms.....           | <a href="#">921</a> |
| Service Disconnects.....        | <a href="#">921</a> |
| Concrete Grade S2.....          | <a href="#">701</a> |
| Handholes.....                  | <a href="#">918</a> |

Secure the Engineer's approval for components of vehicular traffic signals and mounting assemblies not shown on the plans, or not specified in subsection [918.04](#).

### **820.03. Construction.**

**A. Span Wire.** Install span wire, guys, and required fittings as shown on the plans or as directed by the Engineer.

If the Contractor requests to replace span wires that are shown on the plans to be installed or replaced by the utility company, the Department will consider this a change to facilitate ease of construction by the Contractor. Obtain prior approval from the utility company and perform work at no additional cost to the Department.

Obtain the approval of the Engineer before changing span wires.

Install new anchor guys on an angle as indicated on the plans, and include a porcelain strain insulator, unless otherwise required. Strain insulators are not required for strut guys.

**B. Vehicular Traffic Signals, Pedestrian Signals, and Mounting Assemblies.** Obtain the Engineer's approval before removing existing TS equipment. Remove, install, or relocate LED signals and mounting assemblies. Remove the signals in stages, or when the Engineer determines alternate signals are adequate.

Provide LED signal modules that do not require special tools for installation. Ensure the LED modules fit into existing traffic signal housings without modifying the signal housing.

To install the LED module when retrofitting assemblies, remove the existing lamp, socket assembly, gasket, and reflector. Connect the LED module to the existing terminal block. The Engineer will not allow the use of screw-in type products.

Assemble TS heads and wire with fittings and color-coded wire in accordance with the specifications, and as shown on the plans.

Install new TS cable to existing TS heads as required due to the relocation or removal and installation of the TS controller and cabinet as indicated on the plans.

Hang the suspension TS in a vertical plane, face the heads as required, tighten lock nuts, and seal the top of the traffic signal with a construction grade silicone sealant.

If TS span adjustments by the local utility company are required to maintain the TS mounting height, coordinate with and provide at least 48 hours notice to the local utility company before starting work.

For bracket arm signals, drill a hole in each standard, at each required location, to allow the cable to pass through the bracket-arm cable-entrance inlet. If required, drill two holes in the standard to allow the signal cable to loop into the lower bracket and out the upper bracket. Install the bracket arm signals vertically on the standards, face signals as required, and tighten the lock nuts.

Grease TS fittings with a non-oxide type grease.

Use dead-end galvanized steel stand grips on guy wires.

Connect wires with Engineer-approved nylon insulated, solderless connectors, and tape with at least two layers of friction tape, half-lapped.

Construct overhead lines in accordance with the contract. Refer to subsection [819.01](#) for those items not identified in the contract.

Use signal lamps with brass bases in accordance with ITE standards.

Take ownership of and properly dispose of removed material not identified for salvage. Store and dispose of removed material identified for salvage as directed by the Engineer.

Field paint TS bracket arms as required.

The Department will set the timing and offset of the signals as required unless otherwise indicated on the plans. The Department will put them into operation.

Install cables on poles or in ducts, as shown on the plans.

Install signal cables in a continuous length from the controller to each signal, unless otherwise shown on the plans. Pull the cable through the ducts without damage or kinks. Train cables near the top of the wall, manhole, or handholes. Bend cable without damage.

Bundle cables and secure to the wall of the manhole or handhole with galvanized A and J anchors, or an Engineer-approved equal. Provide supports at no greater than 2 foot spacing.

Extend the sheath of the traffic signal cables into the signal traffic heads and at least 1 inch into the controller cabinet. Strap traffic signal cables inside the controller cabinet. Tag and stamp each traffic signal cable as required with a stamped brass tag.

Maintain present traffic signal service with minimal interruptions during traffic signal equipment relocation. Notify the Department 7 working days before relocating controllers or shutting down other traffic signals.

Provide pedestrian signal units with housing, visors, optical units, mounting brackets, lamps, and wiring.

Notify the Engineer and the local utility responsible for maintaining and operating, and providing power to the traffic signal, when adding or removing a traffic signal load from service.

Use only salvaged traffic signals previously installed as new traffic signals unless otherwise directed by the Engineer.

Bag and unbag temporary or final traffic and pedestrian signal displays and case signs as shown on the plans as part of the installation of traffic signals, unless otherwise directed by the Engineer.

**C. Traffic Signal Strain Pole and Traffic Signal Pedestal.** Provide traffic signal pedestal equipment for mounting traffic and pedestrian signals and pedestrian pushbuttons, as shown on the plans.

Provide anchor base type steel strain poles, including anchor bolts and associated hardware, as shown on the plans, to support span wire and bracket arm mounted traffic signals.

Orient the pole on the foundation so the handhole is located on the shaft, perpendicular to the resultant span direction for box spans, perpendicular to the span direction for diagonal spans, or as directed by the Engineer.

Ground the pole as shown on the plans.

Rake poles so the upper one-third of the shaft is vertical when loaded.

Install the pole to orient the foundation and anchor bolts as shown on the plans, or directed by the Engineer.

Tighten top anchor bolt nuts, snug, in accordance with subsection [707.03.D.7.c.](#)

Remove steel or concrete poles as shown on the plans. Remove the foundation of embedded steel pole to the elevation required to remove the pole, as directed by the Engineer.

**D. Foundations.** Remove or install foundations for steel strain poles, mast arm standards, pedestals, or traffic signal controller cabinets as shown on the plans or directed by the Engineer.

1. **Concrete Placement.** Provide Grade S2 concrete for the foundations of mast arm standards, steel strain poles, pedestals, or traffic signal controllers, in accordance with section [701](#). Construct foundations as shown on the plans, in accordance with the signal construction details, or as directed by the Engineer.

Do not use salt or other chemicals to prevent the concrete from freezing.

Do not use construction rubble, broken sidewalk, or other deleterious material in place of concrete. Replace cracked or otherwise defective foundations, as determined by the Engineer, at no additional cost to the Department.

Compact concrete, during and immediately after depositing, using required tools. Ensure the concrete completely fills the form or excavation and fully encases the reinforcement and embedded fixtures. Produce a dense, waterproof concrete, free of voids and honeycomb.

Cure foundation concrete at least 7 days before installing standards.

Maintain temporary enclosures and other protection for concrete for at least 24 hours after removing the heating source.

2. **Foundation and Pad Construction.** Construct strain pole foundations, cased or uncased, in accordance with subsection [810.03.J](#), subsection [810.03.K](#), and subsection [820.03.D](#).

Locate the foundation as shown on the plans, unless otherwise directed by the Engineer.

Obtain the Engineer's approval before placing foundations. Place the lower portion of the foundation without forms, unless the soil is subject to caving and the Engineer approves the use of forms. Use forms to shape the upper part of the foundation. Place concrete and finish the top surface of the foundation at the elevation shown on the plans or directed by the Engineer.

Place base mount controller foundations using forms to shape the foundation as shown on the plans, and the signal details. Ensure the

top surface of the controller foundation is horizontal, finished with a smooth straight surface, free of irregularities. Place the controller cabinet flush with the foundation. Ensure gaps between the foundation and the controller cabinet do not exceed  $\frac{1}{8}$  inch, or as directed by the Engineer.

Place the concrete pad adjacent to the foundation in front of the controller cabinet door as shown on the plans, or directed by the Engineer.

Place concrete in the forms in layers, compact, and finish the concrete to the thickness shown on the plans. Construct a continuous pad between expansion joints. After placing the concrete within forms, use a screed, guided by the forms, spread the concrete and compact.

Protect foundations to prevent injury to pedestrians, motorists, and project personnel until installation of the standards.

Install ground rods and ground wires. Connect the ground wire to the ground rod with a copper-clad, steel, solderless type clamp. Ensure electrically solid and mechanically secure connections.

3. **Backfill and Restoration.** Place backfill in compacted layers no greater than 12 inches thick. Compact layers to at least 95 percent of the maximum unit weight. Place backfill in accordance with section [206](#).

Restore disturbed areas in kind in accordance with section [816](#). Dispose of non-hazardous, contaminated material from drilled shafts, or other foundations as required.

- E. **Illuminated Case Signs.** Wire internally illuminated LED and changeable message case signs with color-coded wire in accordance with the owner's specifications, and as shown on the plans.

Assemble case signs with fittings wired.

Make wire connections with Engineer-approved solderless connectors and tape with at least two layers of friction tape, half-lapped.

- F. **Non-Illuminated Case Signs.** Install, remove, or salvage non-illuminated case signs, including connecting hardware as shown on the plans.

- G. **Electrical Wire and Cable.** Provide, install, and remove traffic signal wires and cable in accordance with section [819](#). Place marking tape from 6 inches to 18 inches above installed underground conduit or cable, except for jack and bored conduit or directional bore conduit. The

Department will provide marking tape with the MDOT logo and telephone number on it.

#### H. **Electrical Service Requirements.**

1. **Overhead Service Connection.** For installing secondary electric service racks on steel poles as shown on the plans, or directed by the Engineer, provide and install a pole band and the required hardware for the local utility company.
2. **Service Disconnect.** Install stainless steel service disconnect switches as shown on the plans. Provide NEMA, Heavy Duty (HD), fusible quick make, quick break type disconnect switches with full cover interlock. Provide NEMA 4X enclosures, unless otherwise required. The Department will provide means for padlocking the operating handles in the open or closed position. Provide Single Pole Single Throw (SPST) switches with a voltage rating and current carrying capacity shown on the plans or directed by the Engineer.

Ensure the service disconnect is marked and rated.

3. **Metered Service.** On wood poles, connect the meter socket to the service disconnect using at least 1½-inch diameter Schedule 80 PVC or galvanized metal conduit. On steel poles, connect the wiring between the meter socket and the service disconnect on the inside of the pole. If directed by the Engineer, run conduit on the outside of the pole. Support the conduit using two-hole galvanized support brackets, spaced no greater than 3 feet apart. Bond the conduits and equipment as required by the NEC, utility company, and the contract documents. Use waterproof elbows with removable covers to enter and exit meters, service disconnects, and controllers.

Contact the local power company shown on the plans to coordinate removal of metered service and power feed. Perform removal work in accordance with the NEC, the contract document requirements, and the local power company standards.

1. **Conduit.** Provide, install, relocate, and remove direct buried and encased conduit and associated fittings in accordance with section [819](#).

The Contractor may submit an alternate method for conduit installation to the Engineer. Obtain the Engineer's approval for the alternate method before proceeding. Complete alternate conduit installation at no additional cost to the Department.

Join conduit pipe fittings and bends with an Engineer-approved PVC conduit cement.

To repair conduit under pavement, sidewalks, or earth, locate the conduit break, replace, and sleeve a new conduit section. Repair the concrete encasement, and restore the site. Use smooth wall, Schedule 80, rigid (PVC) conduit, or coilable, Schedule 80 (PE) conduit in accordance with section [819](#).

Locate conduit breaks using exploratory trenching techniques. Excavate a trench at least 1 foot on each side of the damaged conduit section to perform the rehabilitation.

Remove the section of broken conduit and replace with new conduit. Ensure the new conduit overlaps the existing conduit by at least 3 inches on each end. Connect the new and existing conduit using the manufacturer-recommended coupling and adhesive to form a waterproof seal. If existing conduit is encased, encase the new conduit in Grade P1 concrete as specified in section [601](#).

**J. Wood Pole.** Provide, install, relocate, and remove wood poles in accordance with section [819](#).

**K. Traffic Loop.** The Engineer may change the location of traffic loops.

Center loops in traffic lanes unless otherwise shown on the plans, or directed by the Engineer. Place loops so they do not enclose joints, cracks, manholes, handholes, and other castings and ferrous material. Obtain the Engineer's approval of loop location changes.

Cut slots in the pavement in accordance with subsection [603.03](#). Use high-pressure water and air to clean and dry slots before placing traffic loop wire. Remove dirt, dust, oil, and grease, from the slot, that could prevent bonding of the sealant. Remove dirt, dust, debris, and standing water from the adjacent pavement to avoid contaminating the slot during loop installation.

Lay wire in the slot, and reduce the sharpness of bends. Leave the wires loose in the slot.

Ensure wire in the loop and lead-in is free of kinks, abrasions, and punctures. Use required tools to prevent damage to the loop wire. Do not use screwdrivers and sharp instruments.

Use four turns of wire in loops no greater than 6 feet by 10 feet. Use three turns of wire for loops greater than 6 feet by 10 feet. Twist loop lead-ins with at least two turns per foot to prevent mechanical movement between individual wires.

Bring loop lead-ins into handholes at the time of loop installation and protect against damage. Tape the ends to prevent water from entering the wire.

If sealing detector loops, ensure the roadway surface temperature is at least 40 °F for at least 12 hours after sealant application. Place sealant in accordance with the manufacturer's instructions. Do not mix sealant with solvents, thinners, or other solids. Apply sealant when the ambient temperature is from 40 °F to 100 °F. Allow the sealant to cure before placing a layer of paving over the loops.

Place the loop wires at least ½ inch below the surface of the slots in the pavement, and fill the slots with sealant. If required, use soft restraints to hold the wires ½ inch below the surface. Place the sealant flush with the road surface. Before the sealant sets, strike-off surplus sealant. Do not use solvents to clean sealant off pavement. The Engineer will determine when to open the sealed areas to traffic.

Provide at least a 1 megaohm resistance to ground the loop and lead-in. In the absence of circuit grounds, provide a temporary ground by driving a ground rod.

Test each loop for continuity at the handhole, and ensure the resistance does not exceed 1.5 ohms.

**L. Digital Loop Detector.** Install a rack mounted, digital loop detector in the controller and cabinet with the number of channels shown on the plans, or as directed by the Engineer.

**M. Site Restoration and Waste Disposal.** Restore the site and dispose of waste as directed by the Engineer, and in accordance with subsection [205.03](#).

**N. Handholes.** Install precast concrete handholes of the design and dimensions shown on the plans.

**O. Traffic Signal Controller and Cabinets.** Secure the traffic signal controller cabinet as shown on the plans for pole or base mounted cabinets.

Provide the Department two copies of the manufacturer's specifications for the controller, and outline the special details, features, or changes in design operation. Provide the Department one complete wiring diagram, parts list, assembly drawings, and maintenance manual for the controller.

Provide traffic signal controllers capable of accepting the required timing.



Ground traffic signal installations with solid state controllers at each span contact pole. Ensure the ground has a measured resistance no greater than 10 ohms.

**P. Vertical Exploratory Investigation.** Conduct exploratory investigation to expose and verify the location and elevation of existing traffic signal conduit or utilities in accordance with the contract. Start trenching operations after MISS DIG System, Inc. or the owner stakes the utilities. Repair utilities, damaged during excavation, before backfilling.

Backfill exploratory trenches within 24 hours of excavating, or as directed by the Engineer. Place backfill material in the exploratory trenches after the Engineer approves sections for backfilling. Ensure the Engineer approves materials and method for replacing pavement.

**Q. Warning Sign.** Install or remove warning signs equipped with traffic signal sign opticals, including sign supports, as shown on the plans. Provide a sign legend and sign optical lens size as shown on the plans and in accordance with the [MMUTCD](#), Special Sign Details, and signal construction details.

Install or remove sign optical lenses on existing signs as shown on the plans or directed by the Engineer.

**R. Removing and Salvaging TS, Antenna.** Remove TS antennae or install salvaged TS antennae, removed from the project, as shown on the plans or directed by the Engineer.

**S. Removing Emergency Pre-emption.** Remove emergency pre-emption or install salvaged emergency pre-emption, removed from the project, as shown on the plans or directed by the Engineer.

**T. Steel Truss Arms.** Remove or install steel truss arms for video detection cameras or radio antennae, and related equipment as shown on the plans or directed by the Engineer. Install truss arms following the installation of other traffic signal equipment, including span wire, signal heads, and strain poles, to accommodate truss arm adjustments, as directed by the Engineer. Install truss arms in accordance with the NEC and NESC.

Where adjustment of steel truss arms is required, take responsibility for the premature installation of the truss arms at no additional cost or time to the Department.

**820.04. Measurement and Payment.**

| <b>Pay Item</b>   | <b>Pay Unit</b> |
|---|-----------------|
| TS, (number) Way (type) Mtd .....                                   | Each            |
| TS, (number) Way (type) Mtd, Salv .....                             | Each            |
| TS, (number) Way (type) Mtd, (arrow type).....                      | Each            |
| TS, (number) Way (type) Mtd, (arrow type), Salv .....               | Each            |
| TS, 4th Level (arrow type) .....                                    | Each            |
| TS, 4th Level (arrow type), Salv .....                              | Each            |
| TS, (number) Way (type) Mtd (LED) .....                             | Each            |
| TS, (number) Way (type) Mtd, (type) (LED) .....                     | Each            |
| TS, (number) Way (type) Mtd (LED) Retrofit Assembly .....           | Each            |
| TS, (number) Way (type) Mtd, (type) (LED) Retrofit<br>Assembly..... | Each            |
| TS, 4th Level, __ (LED) .....                                       | Each            |
| TS, 4th Level, __ (LED) Retrofit Assembly.....                      | Each            |
| TS, 4th Level Arrow, Rem .....                                      | Each            |
| Louver .....  | Each            |
| TS, (type) Mtd, Rem .....   | Each            |
| TS, Pedestrian, (number) Way (type) Mtd.....                        | Each            |
| TS, Pedestrian, (number) Way (type), Salv.....                      | Each            |
| TS, Pedestrian, (number) Way (type) Mtd (LED) .....                 | Each            |
| TS, Pedestrian, (number) Way (type) Mtd (LED)<br>Countdown .....    | Each            |
| TS, Pedestrian, (type) Mtd, Rem.....                                | Each            |
| TS, Lens, Pedestrian Sym.....                                       | Each            |
| TS, Lens .....  | Each            |
| TS, Lens, Rem.....  | Each            |
| TS, Lens, Salv .....  | Each            |
| TS, Antenna.....  | Each            |
| TS, Antenna, Rem .....  | Each            |
| TS, Antenna, Salv.....  | Each            |
| Pushbutton .....  | Each            |
| Pushbutton and Sign .....   | Each            |
| Pushbutton, Rem.....  | Each            |
| Conc Pole, Rem .....  | Each            |
| Steel Pole, Rem (Embedded).....                                     | Each            |
| Strain Pole, Steel, Anchor Base, __ foot.....                       | Each            |
| Strain Pole, Steel, Anchor Base, __ foot, Salv .....                | Each            |
| Steel Pole, Rem.....  | Each            |
| Strain Pole, Steel, Anchor Fdn .....                                | Each            |
| Strain Pole Fdn, Cased .....  | Foot            |
| Strain Pole Fdn, Uncased.....                                       | Foot            |
| Fdn, Rem.....   | Each            |

|   |        |
|---|--------|
| Pedestal, Fdn .....   | Each   |
| Pedestal Fdn, Rem .....   | Each   |
| Pedestal, Alum .....  | Each   |
| Pedestal, Alum, Salv .....  | Each   |
| Pedestal, Rem .....   | Each   |
| Case Sign, (number) Way, __ inch × __ inch .....                              | Each   |
| Case Sign, (number) Way, __ inch × __ inch, Salv .....                        | Each   |
| Case Sign, Disappearing Legend, __ inch × __ inch .....                       | Each   |
| Case Sign, Disappearing Legend, __ inch × __ inch, Salv .....                 | Each   |
| Case Sign (LED), (number) Way, __ inch × __ inch .....                        | Each   |
| Case Sign (LED), (number) Way, __ inch × __ inch,<br>Retrofit Assembly .....  | Each   |
| Case Sign (LED), Changeable Message, (number) Way,<br>__ inch × __ inch ..... | Each   |
| Case Sign Panel .....   | Each   |
| Case Sign, Rem .....  | Each   |
| Case Sign Panel, Rem .....  | Each   |
| Case Sign Panel, Salv .....   | Each   |
| Case Sign, (number) Way, __ inch × __ inch,<br>Non-Illuminated .....          | Each   |
| Case Sign, Non-Illuminated, Salv .....  | Each   |
| Case Sign, Non-Illuminated, Rem .....   | Each   |
| Keep Rt Sign, Rem .....   | Each   |
| Serv Disconnect .....   | Each   |
| Serv Disconnect, Rem .....  | Each   |
| Serv Disconnect, Salv .....   | Each   |
| Span Wire .....   | Each   |
| Span Wire, Rem .....  | Each   |
| Anchor Guy .....  | Each   |
| Strut Guy .....   | Each   |
| Pole Guy .....  | Each   |
| Traf Loop .....   | Each   |
| Traf Loop, (type) .....   | Each   |
| Digital Loop Detector .....   | Each   |
| Loop Detector, Rem .....  | Each   |
| Digital Loop Detector, Salv .....   | Each   |
| Riser .....   | Each   |
| Riser, Rem .....  | Each   |
| Power Co. (Est Cost to Contractor) .....                                      | Dollar |
| Conduit Repr, Under Pavt .....  | Foot   |
| Conduit Repr, Under Sidewalk or Earth .....                                   | Foot   |
| Controller and Cabinet, Rem .....   | Each   |
| Controller and Cabinet, Salv .....  | Each   |

|  |      |
|--|------|
| Controller Fdn, Base Mount.....          | Each |
| Controller Fdn, Rem .....                | Each |
| Cabinet, Rem.....                        | Each |
| Cabinet, Salv .....                      | Each |
| Vertical Exploratory Investigation ..... | Foot |
| Metered Serv .....                       | Each |
| Metered Serv, Rem .....                  | Each |
| Warning Sign .....                       | Each |
| Warning Sign, Rem .....                  | Each |
| Sign Optical (LED).....                  | Each |
| Bracket, Truss, with ___ foot Arm .....  | Each |
| Bracket, Truss, Rem.....                 | Each |
| Emergency Pre-emption, Rem .....         | Each |
| Emergency Pre-emption, Salv.....         | Each |
| Sign Optical, Rem.....                   | Each |

A. **General.** Unless otherwise required, the Engineer will measure traffic signal pay items based on plan quantities in accordance with subsection [109.01.A](#).

Pay items specified in this subsection, except removal items, include all components required to provide complete and functioning traffic signals.

In addition to specific work for individual pay items, the unit prices for work specified in this subsection include the following:

1. Excavation and backfill, including backfilling for removed items;
2. Turf restoration;
3. Storage and disposal of waste material;
4. Placing marking tape; and
5. Changes in the method of conduit installation requested by the Contractor.

B. **Traffic Signals.** The unit prices for relevant pay items for installing, salvaging as required, and removing traffic signals include the cost of storing and disposing of materials, and providing and installing traffic signal heads, lamps, brackets, hardware, cable, and other material required to complete the work.

The unit prices for the relevant traffic signal pay items include the cost of installing new TS cable from the TS head to the TS controller and cabinet as shown on the plans; coordinate with local utility companies in TS span adjustments; and stemming signal heads to maintain 17 foot under-clearance, from bottom of signal bracket to road surface for each span wire mounted signal head.

The Engineer will measure, and the Department will pay separately for **Louvers**, based on the number of louvers required for a signal face. The cost of installing louvers is included in the unit price for the relevant traffic signal pay item.

The Engineer will measure, and the Department will pay separately for **Louvers**, based on the number of louvers required for a signal face. The cost of installing louvers is included in the unit price for the relevant traffic signal pay item.

The unit price for **TS, Rem** includes the cost of removing traffic signals and pedestrian signals.

The unit price for **TS, Pedestrian** includes the cost of pedestrian traffic signal heads, including salvaged heads.

The unit price for **TS Lens, Pedestrian Sym** includes the cost of providing and installing the new lenses.

The unit price for **TS Lens** includes the cost of installing traffic signal lenses.

The unit price for **TS Lens, Rem** includes the cost of removing traffic signal lenses.

The unit price for **TS Lens, Salv** includes the cost of installing salvaged traffic signal lenses.

The unit prices for **Pushbutton** and **Pushbutton and Sign** include the cost of providing and installing pushbutton and sign.

The unit price for **Pushbutton, Rem** includes the cost of removing the pushbutton, sign, and cables.

The Department will pay separately for **Traffic Signal Retrofit Assembly**, but the cost of removing the existing lamp, socket assembly, gasket and reflector, and installing the LED traffic signal module without modifying the existing signal housing is included in the unit prices for relevant traffic signal pay items.

C. **Strain Poles.** The unit price for **Strain Pole, Steel, Anchor Base** includes the cost of installing steel standards, including salvaged standards, on the foundation and raking the standard.

The unit price for **Strain Pole, Steel, Anchor Fdn** includes the cost of form work for foundation excavation, constructing foundations and installing conduit bends, grounding, and grounding rods.

The Engineer will measure **Strain Pole Fdns, Cased** and **Strain Pole Fdns, Uncased** vertically from the bottom of the foundation and shaft to

the top of the shaft. The unit prices for **Strain Pole Fdns, Cased** and **Strain Pole Fdns, Uncased** include the cost of installing conduit bends, grounding, grounding rods, and steel casing for foundation excavation.

The unit price for **Steel Pole, Rem** includes the cost of removing the steel pole, hardware, fittings, wiring, grounding, ground rods, and conduits.

The Engineer will measure **Steel Pole, Rem (Embedded)** as shown on the plans in accordance with subsection [109.01.A](#). The unit price for **Steel Pole, Rem (Embedded)** includes the cost removing the steel pole with foundation, hardware, conduit, and other material required to complete the work, and backfilling the hole with granular material.

The unit price for **Fdn, Rem** includes the cost of removing pole foundation and backfilling the hole with granular material.

**D. Pedestals.** The unit price for **Pedestal, Alum** includes the cost of installing pedestals, including salvaged pedestals, fittings, ground rods, and ground wire.

The unit price for **Pedestal, Fdn** includes the cost of excavating and constructing new concrete foundations and installing grounding and ground rods.

The unit price for **Pedestal, Rem** includes the cost of removing pedestals and associated hardware.

The unit price for **Pedestal Salv** includes the cost of installing salvaged pedestals, hardware, fittings, connectors, wiring, service cables, grounding, ground rods, and conduits.

The unit price for **Pedestal Fdn, Rem** includes the cost of removing the pedestal foundation, hardware, conduit, and other material required to complete the work. Backfilling the hole with granular material is included in the pay item.

The unit price for **Pushbutton Pedestal, Alum** includes the cost of installing the aluminum pushbutton pedestal assembly, installing hardware, fittings, grounding, ground rods, and conduits.

The unit price for **Pushbutton Pedestal, Rem** includes the cost of removing the pedestal assembly and hardware.

**E. Case Signs, Illuminated or Non-Illuminated, Changeable Message.** The unit prices for installing, salvaging as required, and removing the relevant case sign pay items for internally illuminated or changeable message signs include the cost of the signs, lamps, brackets, hardware, cable, and other material required to complete the

work. The relevant case sign pay items for non-illuminated signs include the cost of the signs, retroreflective panels, and other materials required to complete the work.

1. **Case Sign Panel.** The unit price for **Case Sign, Panel** includes the cost of installing the case sign panel, or retroreflective case panels.
2. **Case Sign Removal.** The unit price for **Case Sign, Rem** includes the cost of removing illuminated, changeable message, and non-illuminated case signs.
3. **Case Sign Panel Removal.** The unit price for **Case Sign Panel, Rem** includes the cost of removing case sign panels.

F. **Service Disconnect.** The unit prices for installing, salvaging as required, and removing the relevant service disconnect pay items include the cost of the service disconnect (salvaged as required), fuses, brackets, hardware, cable, conduit, and other material required to complete the work.

The unit price for **Serv Disconnect, Rem** includes the cost of removing the disconnect, connectors, wiring, grounding, and ground rods.

The unit price for **Serv Disconnect, Salv** includes the cost of installing the salvaged service disconnect.

G. **Metered Service.** The unit prices for installing and removing the relevant metered, service pay items include the cost of material required by the local utility company and the NEC, and providing and installing the meter, meter sockets, brackets, hardware, cable, conduit and other material required to complete the work.

The unit price for **Metered Serv** includes the cost of returning the meter to the local utility company, storage, or disposal of removed material.

The unit price for **Metered Serv, Rem** includes the cost of removing the meter and meter socket.

The lump sum pay item, **Power Co. (Est. Cost to Contractor)** includes the cost of reimbursing the Contractor for payments made to the power company for providing electrical power at the locations shown on the plans. The Department will estimate the reimbursement costs to the Contractor and establish a lump sum price as shown on the plans. The Engineer will measure and the Department will pay the Contractor for power company invoices paid, as submitted to the Engineer.

The Contractor is responsible for scheduling and coordinating installation, and payment with the Engineer.

The unit prices for the relevant pay items include the cost of installing overhead service connections.

H. **Span Wire.** The unit price for **Span Wire** includes the cost of installing new span wire, insulators, guys, and anchors.

The Department considers the cost of changing out span wires, as requested by the Contractor, an accommodation to the Contractor at no additional cost to the Department.

The unit price for **Span Wire, Rem** includes the cost of removing span wire, guys and associated hardware, and disposing of these items off the project.

I. **Anchor Guy, Strut Guy, and Pole Guy.** The Engineer will measure the required sizes of **Anchor Guy, Strut Guy, and Pole Guy** as a unit. The unit prices for **Anchor Guy, Strut Guy, and Pole Guy** include the cost of installing the guy wire, anchor rod, anchor, strut, and hardware.

J. **Traffic Loop.** The unit prices for **Traf Loop** and **Traf Loop (type)** include the cost of the following:

1. Sawing the slots in the pavement;
2. Making expansion joints;
3. Installing wires in the saw slots;
4. Placing caulking in ends of conduit;
5. Placing sealant and the shielded cable in conduit from its connection to the loop wire in the handhole to the traffic signal controller or digital loop detector cabinet; and
6. Connecting the cabinet to the loop detector.

K. **Digital Loop Detector.** The unit prices for **Digital Loop Detector** and **Digital Loop Detector, Salv** include the cost of installing the following:

1. Connections in existing cabinets;
2. Digital loop detectors, including salvaged loop detectors; and
3. Cables to loop terminals in handholes.

The unit price for **Loop Detector, Rem**, if a stand-alone item, includes the cost of removing the loop detector.

L. **Riser.** The Engineer will measure the required type of **Riser** as a unit. The unit price for **Riser** includes the cost of installing PVC Schedule 80 or galvanized rigid metal pipe riser, weather head, wire arrangements on poles, and associated hardware.

The unit price for **Riser, Rem** includes the cost of removing risers, weather heads, hardware, and fittings.



**M. Conduit Repair under Pavement.** The Engineer will measure **Conduit Repr, Under Pavt** based on plan quantities in accordance with subsection [109.01.A](#). The unit price for **Conduit Repr, Under Pavt** includes the cost of the following:

1. Locating the conduit break;
2. Repairing and sleeving new conduit sections; and
3. Repairing the concrete encasement.

The Engineer will measure, and the Department will pay for, pavement removal and replacement in accordance with the standard specifications and pay items for that work.

**N. Conduit Repair under Sidewalk or Earth.** The Engineer will measure **Conduit Repr, Under Sidewalk or Earth** based on plan quantities in accordance with subsection [109.01.A](#). The unit price for **Conduit Repr, Under Sidewalk or Earth** includes the cost of the following:

1. Locating the conduit break;
2. Repairing and sleeving new conduit sections; and
3. Repairing the concrete encasement.

The Engineer will measure, and the Department will pay for, sidewalk removal and replacement in accordance with standard specifications and pay items for that work.

**O. Controllers and Cabinets.** The unit prices for removing controllers and cabinets, and installing salvaged controllers and cabinets include the cost of removing brackets, hardware, fittings, connectors, cables, grounding, conduits, and other material.

The unit prices for **Controller and Cabinet, Rem** and **Cabinet, Rem** include the cost of removing the digital loop detector as required, wiring, ground rods, and storing or disposing of removed material.

The unit prices for **Controller and Cabinet, Salv** and **Cabinet, Salv** include the cost of installing ground rods and reconnecting wiring.

The unit price for **Controller Fdn, Base Mount** includes the cost of placing and compacting backfill, and installing conduit bends and ground rods.

The unit price for **Controller Fdn, Rem** includes the cost removing traffic signal controller foundations, controller pads, wiring, and ground rods.

**P. Vertical Exploratory Investigation.** The Engineer will measure **Vertical Exploratory Investigation** in accordance with the contract.

**Q. Warning Signs.** The unit prices for installing and removing the relevant **Warning Sign** or **Sign Optical (LED)** pay items include the cost of the storing and disposing of materials and providing and installing warning signs, supports, opticals, hardware, cable conduit and other material required to complete the work.

The unit price for **Warning Sign, Rem** includes the cost of removing warning signs, sign supports, and sign opticals with assembly.

The unit price for **Sign Optical (LED)** includes the cost of installing LED traffic signals, and sign opticals with assembly.

The unit price for **Sign Optical, Rem** includes the cost of removing sign opticals with assembly.

**R. Bracket Truss.** The unit price for **Bracket, Truss, with \_\_\_ foot Arm** includes the cost of installing brackets, hardware, fittings, connectors, ground rods, ground wire, and grounding.

The unit price for **Bracket, Truss, Rem** includes the cost of removing brackets, hardware, fittings, connectors, ground rods, ground wire, and grounding.

**S. TS Antenna.** The unit prices for installing, salvaging as required, and removing the relevant **TS, Antenna** pay items include the cost of the antenna (salvaged as required), surge protection, brackets, hardware, cable, conduit and other material required to complete the work.

The unit price for **TS, Antenna, Rem** includes the cost of removing antenna, wiring, cable from controller, grounding, and ground rods.

The unit price for **TS, Antenna, Salv** includes the cost of installing salvaged antennae.

**T. Emergency Pre-emption.** The unit prices for removing and installing the salvaged emergency pre-emption pay items include the cost of the traffic signal pre-emption equipment, associated with intersection traffic signal control devices, pre-emption units and confirmation lights facing one or more directions, brackets, hardware, cable, conduit and other material required to complete the work.

The unit price for **Emergency Pre-emption, Rem** includes the cost of removing the traffic signal pre-emption equipment for emergency vehicles, as associated with intersection traffic signal control devices, pre-emption units facing one or more directions, and confirmation lights facing one or more directions.

The unit price for **Emergency Pre-emption, Salv** includes the cost of installing the salvaged traffic signal pre-emption equipment, as associated with intersection traffic signal control devices, pre-emption units facing one or more directions, and confirmation lights facing one or more directions

U. **Concrete Pole Removal.** The unit price for **Conc Pole, Rem** includes the cost of removing concrete poles, hardware, fittings, connectors, wiring, grounding, ground rods, and conduits.

## Section 821. PRESERVATION OF LAND MONUMENTS, CONTROL POINTS, AND PROPERTY CORNERS

**821.01. Description.** This work consists of preserving the corners and control points as shown on the plans, identified in the contract, or directed by the Engineer. These corners and control points are defined in subsection [821.01.A](#). The Department considers the terms point and corner synonymous when used in this section.

### A. Definitions.

**Public Land Survey System Corners.** Section Corners,  $\frac{1}{4}$  Section Corners, Center of Sections, and Meander Corners.

**Property Controlling Corners.** Corners that control boundaries for several parcels of land and include  $\frac{1}{4}$  –  $\frac{1}{4}$  ( $\frac{1}{16}$ ) Corners, Property Corners, Subdivision Corners and Subdivision Block Corners.

**Alignment Control Points.** Points of Curvature (PCs), Points of Tangent Intersections (PIs), Points on Tangents (POTs), Points on Tangents in Curve Areas (POCTs), and Points on Curve Centerline (POCs). Alignment Points may be Property Controlling Corners.

**Geodetic Control Points.** Horizontal or Vertical Control Monuments are published by the National Geodetic Survey as part of the National Spatial Reference System (NSRS).

**B. Administrative Requirements.** In accordance with 1980 PA 299, perform work to verify point positions, evaluate, witness, place points, and report, under the direct supervision of a professional surveyor licensed in the State of Michigan. Use employees of the professional surveyor, or surveying firm to perform this work.

Coordinate with the licensed professional surveyor during construction activities to schedule the work, including the following:

1. Verification of preliminary point positions;
2. Setting of temporary witnesses;
3. Installing monument boxes in paved areas; and
4. Final placement of preservation points.

Ensure the licensed professional surveyor notifies the Engineer of the completion of the required preliminary verification and witnessing work before beginning construction activities on the project.

Witness corners and points identified as “Preserve” with straight-line witnesses before beginning construction. Reestablish the corners and points in accordance with this section and 1970 PA 74.

The plans will identify Vertical Control Monuments published by the National Geodetic Survey (NGS), as part of the National Spatial Reference System, that may be disturbed or destroyed during construction as “Preserve-Vertical”. Transfer or reference the original benchmark elevation of these monuments before the start of construction. Follow the procedures established in the NGS Benchmark Reset Procedure guidelines for transferring, referencing, resetting, and documenting a National Geodetic Survey Vertical Control Monument, found at the following website address:

[http://www.ngs.noaa.gov/heightmod/Leveling/Manuals/Benchmark\\_9\\_13\\_07.pdf](http://www.ngs.noaa.gov/heightmod/Leveling/Manuals/Benchmark_9_13_07.pdf)

The guidelines are also available through the National Geodetic Survey website. Contact the appropriate MDOT Region Surveyor and the NGS State Geodetic Advisor to discuss before beginning field work.

Submit the required data for each monument to the MDOT Region Surveyor and the NGS State Geodetic Advisor for review.

Upon completing the requirements of this section and 1970 PA 74, for each corner and point identified as “Preserve”, ensure the licensed professional surveyor submits, to the Department, two copies of a “Land Corner Recordation Certificate,” approved by the Michigan State Board of Professional Surveyors for Section 5 of Act 74. Do not document more than four survey points on each form. Submit one copy of the “Land Corner Recordation Certificate” to the Engineer and mail one copy to the MDOT Region Survey Manager.

For Public Land Survey System Corners or previously recorded Property Controlling Corners preserved under this provision, ensure the licensed professional surveyor records a Land Corner Recordation Certificate in the Register of Deeds Office in the County where the corner is located. Transmit the two copies of the Land Corner Recordation Certificate with the Register of Deeds recording stamp with the Liber and Page or File Number where the certificate is recorded. Review, with the licensed professional surveyor, the positions of corners within and near the construction limits identified on the plans as “Protect”. Mark these positions to prevent their disturbance. If a corner is in danger of being disturbed, identify and witness the corner with straight-line witnesses before construction, using the same method as for corners identified as “Preserve”.

Corners identified as “Protect”, but witnessed and left undisturbed, do not require remonumentation. Maintain documentation of witnesses for payment purposes.

Ensure the licensed professional surveyor submits, to the Department, two copies of a list of corners identified as “Protect,” indicating the corners witnessed by the professional surveyor. List corners, identified as “Protect,” as “not witnessed”, if outside the construction area, not in danger of disturbance, and not witnessed. Include, in the list identifying “Protect” corners, a statement indicating that the corners were found undisturbed after construction. Ensure the licensed professional surveyor signs, seals, and dates the statement.

Complete the work and submit the documentation within four weeks after the completion of construction work.

**821.02. Materials.** Provide and install monument box castings, as required by law, at survey points shown on the plans, or directed by the Engineer.

Provide and install a monument to mark the location of a replaced Plat Block Corner or Plat Corner not located in pavement or other hard surfaces. This monument must consist of a precast concrete cylinder 4 inches in diameter, 36 inches in length, and have a ½-inch rebar protruding 1 inch from the center of the cylinder. Other monuments must be at least ½ inch in diameter and at least 18 inches long.

Ensure that monuments possess a magnetic field and are legibly capped showing the license number of the professional surveyor.

**821.03. Construction.** Reestablish the horizontal position of monuments within 0.02 foot of the original position.

Install points in paved surfaces in monument boxes. Install points located outside of paved surfaces and within gravel roadways, including gravel shoulders, at least 6 inches below the gravel surface. Install points, located outside of paved surfaces, and outside of unpaved roadways, flush with the ground. Drill and grout points located on rock outcroppings into solid rock to at least 8 inches deep.

Install monument boxes in accordance with Standard Plan R-11 Series. Reinstall old monument boxes if the monument boxes meet the requirements of Standard Plan R-11 Series.

Use coring, after completion of paving operations, to place new monument boxes in pavement areas. Obtain the Engineer’s approval of coring equipment before starting the work. Use a core diameter no greater than 1 inch larger than the largest diameter of the monument

box. Grout the monument box in place using non-shrink grout to the full depth, as approved by the Engineer. Do not place the grout in the monument box. Do not place granular material more than 0.1 foot above bottom of the monument box frame. Install monument boxes so neither the box nor the cover extends above the pavement surface and so no part is more than 0.02 foot below the pavement surface. Compact the material at the base of the box before placing the box.

Prevent the reset monument or cap from touching the side of the monument box. Position the center of the monument within 0.25 foot of the center of the monument box. Position the top of the monument from 0.1 foot to 0.5 foot below the top of the monument box.

Before construction, measure the distance from the corner position to existing record witnesses to within  $\pm 0.01$  foot to verify and establish the "Preserve" corner position. Document the record and measured distances to existing witnesses on the Land Corner Recordation Certificate.

To preserve existing points, place temporary witnesses with straight-line witnesses before construction begins. Place at least four hubs with tacks, two on each side of the roadway, outside potential construction activity limits, at right angles to the roadway centerline. Determine precise measurements from the corner to points on the temporary witness line. Document this information in Section B of the Land Corner Recordation Certificate.

If not measuring temporary witness points directly from the corner, make check measurements to ensure the accuracy of the directly measured witness. Submit a copy of the field notes for these check measurements to the Department.

During remonumentation, check and compare straight-line witnesses with the record measurements. For deviations from the record measurements, document the new measurement and the record measurement, and the method for resolving the deviations in remonumentation, in Section B of the Land Corner Recordation Certificate.

Preservation of existing points includes documenting at least four newly established or recovered permanent record witness points expected to remain for five years after construction.

Locate witnesses in at least three separate quadrants from the corner monument. Orient witness points from the corner position by bearing to the nearest 5 degrees, and distance to within 0.01 foot.

Record, in Section C of the Land Corner Recordation Certificate, a detailed description of the monument, noting the monument box if required, the designation of the monument (PC, PI, PT, POT, and stationing), and a complete description of the remaining witnesses.

For Alignment Points and Geodetic Control Points, record the control section, job number, route name, point designation, and stationing in item "3. Miscellaneous" on the Land Corner Recordation Certificate.

#### **821.04. Measurement and Payment.**

| <b>Pay Item</b>                       | <b>Pay Unit</b> |
|---------------------------------------|-----------------|
| Monument Preservation .....           | Each            |
| Monument Preservation, Vertical ..... | Each            |
| Monument Box .....                    | Each            |
| Protect Corners .....                 | Each            |
| Monument Box Adjust .....             | Each            |

A. **Monument Preservation.** The Engineer will measure **Monument Preservation** by the number of monuments, public land survey corners, property controlling corners, and highway alignment control points preserved. The unit price for **Monument Preservation** includes the cost of the following:

1. Preliminary position verification;
2. Temporary witnessing;
3. Providing and installing new monument and permanent witnessing;
4. Recording the Land Corner Record Certificate in accordance with 1970 PA 74;
5. Providing the required documents;
6. Preparation work;
7. Traffic maintenance;
8. Cleanup; and
9. Site restoration.

B. **Monument Preservation, Vertical.** The Engineer will measure **Monument Preservation, Vertical** by the number of vertical geodetic control points preserved. The unit price for **Monument Preservation, Vertical** includes the cost of the following:

1. Preparation work,
2. Traffic maintenance,
3. Cleanup,
4. Site restoration, and
5. Other costs associated with this work.



C. **Monument Box.** The unit price for **Monument Box** includes the cost of removing existing monument boxes, and providing and installing the monument box castings and monument box cover.

D. **Protect Corners.** The unit price for **Protect Corners** includes the cost of verifying point positions before and after construction, witnessing before construction, and documentation.

E. **Monument Box Adjust.** The unit price for **Monument Box Adjust** includes the cost of providing and installing monument box adjusting rings, and raising or lowering monument boxes to a position flush with the final paved grade.

If the adjustment process disturbs the location of a monument, the unit price for **Monument Box Adjust** includes the cost of verifying the preliminary position, temporary witnessing, permanent witnessing, recording the Land Corner Record Certificate in accordance with 1970 PA 74, and providing the required documents.

## Section 822. GROUND OR CUT SHOULDER CORRUGATIONS

**822.01. Description.** This work consists of milling or diamond grinding corrugations (rumble strips) into finished hot mix asphalt (HMA) or concrete highway shoulders.

**822.02. Materials.** None specified.

### 822.03. Construction.

**A. Equipment.** Demonstrate to the Engineer the ability to achieve the desired surface inside each depression without tearing or snagging the asphalt surface, or spalling the concrete surface. Begin production work after the Engineer approves the demonstrated process.

Use a rotary-type cutting tool equipped with the following:

1. Cutting tips arranged in a pattern that provides smooth cut depressions;
2. Independently suspended cutting heads to allow the tool to self-align with the slope of the shoulder and irregularities in the shoulder surface; and
3. Guides to provide consistent alignment of each cut in relation to the roadway and to provide uniformity and consistency throughout the project.

**B. Construction.** Grind or cut corrugations to the dimensions and patterns shown on Standard Plan R-112 Series. Align the cross slope at the bottom of the depressions to match the cross slope of the shoulder.

If corrugations are required on concrete shoulders and the method of installation is not shown on the plans or directed by the Engineer, construct corrugations by grinding, cutting, or forming.

Allow 72 hours after placement of HMA before grinding or cutting corrugations in HMA shoulders.

Prevent the grinding residue from being blown or tracked by traffic, or blown by wind. Do not allow residue to flow across lanes open to traffic or into gutters or drainage structures.

Clean the shoulder and pavement at the end of each day using an Engineer-approved method.

### 822.04. Measurement and Payment.

| <b>Pay Item</b>                                  | <b>Pay Unit</b> |
|--|-----------------|
| Shoulder Corrugations, Ground or Cut, HMA.....   | Foot            |
| Shoulder Corrugations, Ground or Cut, Conc ..... | Foot            |

822.04

The Engineer will measure corrugations along the outside edge of each shoulder where corrugations are actually placed. The cost of the work to complete corrugations, including containment or collection of grinding residue is included in the unit prices for related pay items.

## Section 823. WATER MAINS

**823.01. Description.** This work consists of excavating, installing, testing, disinfecting, and backfilling ductile iron water mains and appurtenances, and providing as built plans of the completed work.

**823.02. Materials.** Provide materials in accordance with the following:

|  |                     |
|--|---------------------|
| Pipe.....                              | <a href="#">923</a> |
| Water Services .....                   | <a href="#">923</a> |
| Gate Wells .....                       | <a href="#">923</a> |
| Gate Valves .....                      | <a href="#">923</a> |
| Tapping Valves.....                    | <a href="#">923</a> |
| Valve Boxes and Curb Boxes.....        | <a href="#">923</a> |
| Corporation Stops and Curb Stops ..... | <a href="#">923</a> |
| Service Saddles.....                   | <a href="#">923</a> |
| Fire Hydrants .....                    | <a href="#">923</a> |
| Backfill Material .....                | <a href="#">902</a> |
| Polyethylene Encasement.....           | <a href="#">923</a> |

**823.03. Construction.** Install pipe materials required by the contract in accordance with AWWA Standards.

**A. General.** The plans show the locations of existing utilities in accordance with available data. If the work requires precise information on the location of existing utilities, the Contractor will expose utilities shown on the plans to determine the actual locations.

Do not disturb or cut into existing in-service water mains. If the operation of valves in existing water mains is required, notify the Engineer in advance so the Engineer may give the Municipality 3 working days advance notice. Coordinate scheduling of water main connections with the Municipality. Secure the Engineer's approval of the schedule before beginning the work. The Municipality is responsible for customer notifications.

The Municipality will open or close valves, as required to perform the work, without charge to the Contractor. In case of an emergency, the Contractor, with the approval of the Engineer, may operate valves to resolve the emergency.

Minimize the out of service time for existing water mains. Make connections at night, on Sundays, or on holidays, as conditions require or as approved by the Engineer. Minimize interference with the water supply if abandoning existing water mains and incorporating new water mains into the water system.

**B. Trench Excavation.** Excavate water main trenches to the lines and grades shown on the plans in accordance with modifications approved by the Engineer, or to meet or bypass existing utility structures. Excavate trenches to the depths shown on the plans to provide at least 5½ feet of cover from top of water main to the final grade. Excavate trenches to the widths shown on Standard Plan R-83 Series.

Excavate the bottom of the trench to the required grade to allow 6 inches of bedding for the pipe. Do not block under the pipe.

Maintain trenches for water mains free of ground or surface water by pumping or as otherwise approved by the Engineer.

Install, and later remove, temporary timber bracing, as required to prevent movement or damage to new or existing water mains or adjacent utilities.

During backfilling, carefully remove supports for sheeted and braced excavations to prevent earth banks or adjacent streets from collapsing.

The Contractor may leave sheeting and bracing in place during backfilling and remove after completing backfilling operations. The Contractor may leave sheeting and bracing in place, if approved by the Engineer and the Contractor cuts it off 5 feet below the ground surface.

**C. Disposal.** Dispose of waste material as specified in section [205](#).

**D. Laying the Pipe.** Install the pipe joint restraint system in accordance with the manufacturer's recommendations. Assemble the pipe in the trench. If deflections at joints are required by changes in grade, alignment, or to plumb valve stems, ensure deflections of bell and spigot joints do not exceed the manufacturer's recommendations. Ensure the deflection at the joints of mechanical joint fittings does not exceed three-quarters of the maximum deflection recommended by the joint manufacturer or that allowed by AWWA C600, whichever is less. Do not store or leave tools or other objects in the pipe.

Provide joint restraint at fittings and deflections of 11¼ degrees and larger. Provide joint restraint in accordance with the Joint Restraint Schedule shown on the plans.

The Engineer may require thrust blocks in accordance with the Municipality's standards, or if making connections to existing water mains.

Construct thrust blocks to bear on undisturbed earth. Perform the work, including cold weather protection, in accordance with section [706](#).

**E. Abandoning Water Mains.** Remove and dispose of abandoned pipe, gate boxes, or other appurtenances, as necessary for placement of a new water main at no additional cost to the Department. Remove portions of gate boxes to at least 3 feet below the pavement surface under the road, and to at least 12 inches below the planned grade outside the road. If the Engineer determines abandoned mains may remain in place, block the ends of the abandoned mains with concrete. If shown on the plans or directed by the Engineer, fill abandoned water mains with non-structural flowable fill.

**F. Valves.** Set and join valves to the water mains as required for cleaning, laying, and jointing the required type of pipe, as shown on the plans. Install valves as required by the contract, or as approved by the Engineer. Place the valve stems plumb. Install self-supporting valves that do not bear on the pipe.

**G. Live Taps.** Hand-chlorinate tapping sleeves and gate valves before installation. Perform a wet tap into live water mains according to the manufacturer's recommended procedures.

**H. Valve Boxes.** Provide valve boxes that do not transmit shock or stress to the valve. Place valve boxes plumb over the operating nut of the valve, with the box cover flush with the pavement, or as approved by the Engineer. Provide firm support for valve boxes.

**I. Adjusting and Reconstructing Water Shutoffs or Gate Boxes.** Adjust and reconstruct water shutoffs or gate boxes to the final grade or as approved by the Engineer. Replace shutoff or gate box materials damaged during adjustment or reconstruction, as determined by the Engineer.

**J. Water Services.** Construct water services from the distribution main to the right-of-way line, or as approved by the Engineer.

Construct the service pipe with at least 5 feet of cover.

Make all service connections, and transfers. Maintain and protect, at no additional cost to the Department, existing service connections requiring transfer, but not shown on the plans, until reconnection or disposal.

If relocating a portion of water service, shut down the water service by freezing, or other method approved by the Engineer.

**K. Gate Wells.** Build gate wells as shown in the contract and in accordance with section [403](#). Mix mortar for masonry work in quantities that will be used before initial set. Do not use mortar that requires retempering.

Position the valve nut to allow access through the opening in the manhole. Construct wells to allow minor valve repairs. Protect the valve and pipe from impact where passing through the well walls.

**L. Water Mains, Cut and Plug.** If the plans show cutting and plugging water mains, arrange for the Municipality to shut down the main. Remove the section of pipe and plug the water main as shown on the plans or approved by the Engineer. Construct the required thrust block and complete backfilling operations.

**M. Fire Hydrants.** Set fire hydrants at the locations shown on the plans, or as coordinated with the Municipality and directed by the Engineer. Equip the hydrant with auxiliary valves, as shown on the plans. Stand hydrants plumb, with nozzles parallel, or normal to the curb, and with the pumper nozzle normal to the curb. Place the nozzles at the height specified by the manufacturer, and at least 16 inches above the curb grade, or as approved by the Engineer.

Paint hydrants in accordance with the Municipality's standard requirements.

**N. Fire Hydrant Removal.** If the plans show removal of a fire hydrant, remove the entire hydrant assembly, including the following:

1. Auxiliary gate valve and box, unless otherwise approved by the Engineer;
2. Internal valve assembly;
3. Top bonnet;
4. Standpipe; and
5. Hydrant inlet body, if not encased in concrete.

If the Engineer approves leaving the auxiliary gate valve and box in place, remove to at least 3 feet below the pavement surface under the road, or at least 12 inches below planned grade outside the road.

Stockpile the removed material at a location approved by the Engineer. The Municipality will maintain ownership of the hydrant, and will remove the assembly from the project site.

**O. Relocating Fire Hydrants.** If the plans show relocating a hydrant, arrange for the Municipality to shut down the existing main. Remove the hydrant and reinstall at the required location. Add extension sections as necessary to adjust the hydrant to the required elevation. Reconnect the hydrant to the water main by shutting down the main, tapping a new hydrant outlet, or using the existing outlet. Install piping as required.

**P. Abandoning Gate Wells.** Abandon existing gate wells in accordance with section [203](#). Salvage the cover if requested by the Municipality.

**Q. Gate Wells, Remove.** Remove existing gate wells in accordance with section [203](#) and salvage existing gate valve. Stockpile the removed material at a location approved by the Engineer. The Municipality will maintain ownership of the gate valve, and will remove it from the project site.

**R. Miscellaneous Fittings.** Install the following at the locations shown on the plans and in accordance with good construction practices:

1. Elbows,
2. Tees,
3. Corporation stops,
4. Blow offs,
5. Pipe adapters,
6. Pipe couplings,
7. Threaded rods,
8. Retaining glands, and
9. Other miscellaneous fittings.

**S. Backfill.** Protect trench backfill material against freezing, or thaw frozen material before using. Backfill in accordance with Standard Plan R-83 Series.

Place backfill around the pipe, and to 12 inches above the pipe, in horizontal layers no greater than 6 inches deep. Compact each successive layer by tamping. Completely fill and compact spaces beneath the pipe. During backfill operations around the pipe, avoid damaging pipe joints and coating, or displacing the pipe from its original position.

**T. Hydrostatic Testing.** Perform hydrostatic testing of water mains in accordance with AWWA C600.

Ensure Municipality personnel witness pressure testing. Give the Municipality personnel at least 1 full working day notice before testing.

Provide the personnel, temporary timber bracing, plugs, test pumps, temporary connections to the Municipal water system, and other required apparatus. Provide the water for hydrostatic testing if not available from the Municipality. Water must be from a measurable source in order to determine leakage.

Before applying test pressure, expel air from the pipe. To expel air, make taps at the highest elevation points in the pipe. Plug these



openings before the test with tight threaded brass plugs. Pressure test each section of water main in increments of no greater than 1,000 feet. Do not perform testing against a closed valve that is in service.

Maintain test pressure at 150 psi by pumping water into the pipe for at least 2 hours. Leakage, as measured by the quantity of water pumped into the pipe to maintain 150 psi during the test period, must not exceed the allowable leakage.

Allowable leakage is determined using Formula 823-1.

$$L = \frac{SD\sqrt{P}}{148,000} \quad \text{Formula 823-1}$$

Where:

$L$  = allowable leakage in gallons per hour,

$S$  = length of pipe in feet,

$D$  = Actual pipe diameter in inches, and

$P$  = 150 psi.

If leakage above the allowable limit occurs during hydrostatic testing, remove backfill to expose pipe and repair the joints and service taps. Repeat testing after repairs are complete.

Correct visible leaks regardless of the amount of leakage. Replace faulty pipes, fittings, gate valves, or other accessories disclosed by testing. Repeat the test until the pipes, fittings, gate valves, and other accessories meet the requirements.

**U. Disinfection, Flushing and Bacteriological Testing.** Disinfect the water main in accordance with AWWA C651 and applicable MDNRE regulations after successful hydrostatic testing.

Disinfect and flush new, and portions of existing, water mains as required by the MDNRE.

Use blow offs, fire hydrants, or other means as shown on the plans or approved by the Engineer to flush water mains. Provide hoses and other equipment and arrange a means of disposing of the water without damaging the work or adjacent property.

The Department prefers the continuous feed method for disinfecting mains but the Engineer may approve other methods. Use the continuous feed method with chorine added simultaneously with the water. Add chlorine or liquid hypochlorite to meet the requirement of at

least 25 milligrams per liter of chlorine. Slowly add the water to the main and allow to stand for at least 24 hours. At the end of the 24-hour period, ensure the chlorine residual is a minimum of 10 milligrams per liter. If not met, re-chlorinate and flush the water main until a minimum 10 milligrams per liter residual remains after 24 hours.

After completing disinfection, initially flush the water mains with water at a velocity of at least 2½ feet per second to replace the entire volume of chlorinated water in the pipeline. After initial flushing, perform final flushing until the residual chlorine content meets the standard level for the water distribution system. The Municipality may require a waiting period after flushing and before bacteriological sampling.

Dispose of chlorinated water in accordance with applicable state and local requirements. If necessary, apply a reducing agent to the water to neutralize the chlorine and create a chlorine residual of no greater than 1 ppm.

After flushing, perform bacteriological testing in accordance with AWWA C651 and MDNRE requirements. Test chlorine residuals before taking each bacteriological sample. Ensure the chlorine residual is less than 0.5 milligrams per liter before taking a bacteriological sample. Collect samples from each branch of pipe in the presence of the Engineer and Municipality personnel. The Municipality will be responsible for the transportation of the samples to a State of Michigan approved lab for testing. Two consecutive bacteriologically safe tests at 24-hour intervals for each section of pipe are required. Acceptable tests are negative for bacteria and as otherwise defined by AWWA C651 and MDNRE regulations.

If a bacteriological test fails, repeat disinfection, flushing, and testing.

**V. As-Built Plans.** Prepare as-built plans as work progresses. Provide two complete sets of as-built plans to the Engineer within 30 days following completion of water main work. Include, in the as-built plans, the following information:

1. Pipe sizes,
2. Pipe locations,
3. Fittings,
4. Valve locations,
5. Hydrant locations,
6. Service tap locations, and
7. The locations of underground obstructions that required relocation of the water main installation.

W. **Polyethylene Encasement.** Install polyethylene encasement on water mains and fittings in accordance with the manufacturer's installation instructions and ANSI A21.5 or AWWA C105.

**823.04. Measurement and Payment.**

| <b>Pay Item</b>                          | <b>Pay Unit</b> |
|--|-----------------|
| Water Main, DI, __ inch, Tr Det __ ..... | Foot            |
| Gate Valve, __ inch .....                | Each            |
| Live Tap, __ inch x __ inch.....         | Each            |
| Gate Valve and Box, __ inch .....        | Each            |
| Gate Well, __ inch dia .....             | Each            |
| Water Main, __ inch, Cut and Plug.....   | Each            |
| Fire Hydrant.....                        | Each            |
| Hydrant, Rem .....                       | Each            |
| Hydrant, Relocate, Case __ .....         | Each            |
| Gate Well, Abandon .....                 | Each            |
| Gate Well, Rem .....                     | Each            |
| Water Serv.....                          | Each            |
| Water Serv, Long.....                    | Each            |
| Water Serv, Conflict.....                | Each            |
| Water Shutoff, Adj, Temp Case __.....    | Each            |
| Gate Box, Adj, Temp, Case __.....        | Each            |
| Water Shutoff, Reconst, Case __.....     | Each            |
| Gate Box, Reconst, Case __.....          | Each            |
| Water Shutoff, Adj, Case __.....         | Each            |
| Gate Box, Adj, Case __.....              | Each            |
| Polyethylene Encasement.....             | Foot            |

A. **Water Main, DI.** The Engineer will measure **Water Main, DI**, of the sizes and trench details required, along the centerline of the pipe, with no deductions for fittings. The unit price of **Water Main, DI** includes the cost of the following:

1. Excavation and backfill;
2. Dewatering operations (trench and/or pipe);
3. Provide temporary water system to maintain service during construction;
4. Hydrostatic testing;
5. Disinfecting and flushing the water main and bacteriological testing;
6. All material, labor and equipment necessary to remedy an unsatisfactory hydrostatic test, including removing and replacing any backfill;

7. Providing and installing fittings, gaskets, bracing or sheeting, blocking and miscellaneous items for installing pipe and reconnecting to the Municipal Water System;
8. Material, labor, and equipment to remedy unsatisfactory hydrostatic tests, including removing and replacing backfill;
9. Live taps, used at the Contractor's option to expedite connecting to an existing water main; and
10. Preparing and providing as-built plans.

The Department may withhold payment until the Engineer accepts the as-built plans.

The cost of dewatering of trenches, pipe, or both associated with alterations to the Municipal Water System, is included in the unit price for relevant items of work.

The cost of excavating, disposing of excess material, and providing, placing, and compacting the backfill, is included in the unit price for related items of work.

The cost of removing or abandoning existing water mains, gate valve boxes, and other appurtenances to provide clearance for the proposed water main or roadway, is included in the unit price for relevant items of work.

The Department will pay separately for Non-Structural Flowable Fill.

#### **B. Gate Valves, Gate Boxes, Live Taps and Water Shutoffs.**

1. The unit prices of **Gate Valve**, and **Gate Valve and Box**, of the types and sizes required, include the cost of providing and installing the valve and valve box, complete and ready for use.
2. The unit price for **Live Tap**, of the size required, includes the cost of providing and installing the valve, tapping sleeve, all necessary restraints, and valve box, complete and ready for use. This work includes the complete live tapping procedure.
3. The Engineer will measure and the Department will pay for **Gate Box, Adj, Case \_\_** and **Water Shutoff, Adj, Case \_\_** of the case required, as follows:
  - a. Case 1 refers to structures located in hard surfaced travel areas and unit price includes saw cutting, removing and replacing existing pavement, curb, or curb and gutter, and adjusting the water shutoff or gate box to final grade.

- b. Case 2 refers to structures located outside existing pavement, curb or curb and gutter and unit price includes restoring disturbed vegetated or sidewalk areas.
4. The Engineer will measure and the Department will pay for **Gate Box, Reconst, Case \_\_** and **Water Shutoff, Reconst, Case \_\_** of the case required, as follows:
- a. The unit prices for **Gate Box, Reconst, Case \_\_** and **Water Shutoff, Reconst, Case \_\_** of the case required, include the cost of providing and placing new sleeves, castings, and other materials above the existing valve.
  - b. Case 1 refers to structures located in hard surfaced travel areas and in addition to costs shown in subsection [823.04.B.4.a](#) unit prices include saw cutting, removing and replacing existing pavement, curb, or curb and gutter, and adjusting the water shutoff or gate box to final grade.
  - c. Case 2 refers to structures located outside existing pavement, curb or curb and gutter and in addition to costs shown in subsection [823.04.B.4.a](#) unit prices include restoring disturbed vegetated or sidewalk areas.
5. **Gate Box, Adj, Temp, Case \_\_**, or **Water Shutoff, Adj, Temp, Case \_\_**, will be measured and paid for if temporarily lowering the water shutoff or gate box. The unit prices for these **Temp, Case \_\_** pay items include the costs described for Case 1 pay items and the cost of temporary lowering work.

The Department will pay for replacing damaged gate boxes or water shutoffs, in accordance with subsection [823.03.1](#) as the relevant gate box or water shutoff adjustment pay item. If the Engineer determines gate boxes or water shutoffs were in poor condition, or damaged despite Contractor precautions, the Department will pay for the work as the relevant gate box or water shutoff reconstruct pay item.

**C. Gate Well.**

- 1. The unit price for **Gate Well**, of the diameter required, includes the cost of the concrete footing and up to 10 feet of structure depth. Any cover placed on the gate well will be paid for as **Drainage Structure Cover** as specified in section [403](#).
- 2. The unit price for **Gate Well, Abandon** includes the cost of abandoning the structure, and salvaging the valves, if requested by the Municipality.

3. The unit price for **Gate Well, Rem** includes the cost of removing the structure and salvaging valves for the Municipality.

D. **Water Service. Water Serv** refers to services no greater than 30 feet long. **Water Serv, Long** refers to services greater than 30 feet long. **Water Serv, Conflict** refers to relocating only a portion of a water service. Services with a diameter larger than 2 inches will be measured and paid for as water mains.

The unit prices for **Water Serv, Water Serv, Long** and **Water Serv, Conflict** include the cost of the following:

1. Earth excavation;
2. Removing pavement;
3. Replacing pavement;
4. Jacking and boring;
5. Providing and installing type K copper tubing, service saddle, corporation stops, service stops, and service boxes;
6. Disinfecting;
7. Providing, placing, and compacting backfill; and
8. Miscellaneous material, equipment, or operations.

The Department will pay for additional service connections, not shown on the plans, but maintained, protected, and reconnected or disposed of by the Contractor as **Water Serv**, or **Water Serv, Long**.

The pay item **Water Serv, Conflict** will apply only to portions of water services requiring relocation due to direct conflict with utilities, other items of work, or as otherwise approved by the Engineer. The Department will pay for all other relocations requiring replacement of corporation or service stops as **Water Serv** or **Water Serv, Long**.

E. **Water Main, Cut and Plug**. The unit price for **Water Main, Cut and Plug** includes the cost of cutting the existing water main, providing and placing the required plug, and thrust blocks.

F. **Fire Hydrant**. The unit price for **Fire Hydrant** includes the cost of providing and installing the hydrant, including the coarse gravel and concrete base, at the locations shown on the plans in a ready-for-use condition.

The Department will pay separately for auxiliary valves, or other items included in the contract as separate pay items.

The unit price for **Hydrant, Rem**, includes the cost of breaking down the auxiliary gate valve, gate box, the hydrant assembly, backfilling, and plugging the opening in the existing main.

The unit price for **Hydrant, Relocate, Case** \_\_ of the case required, includes the cost of vertically adjusting the relocated hydrant to final grade and the following:

1. Case 1 includes the cost of removing the hydrant, extending the existing hydrant lead from the gate valve, reinstalling the hydrant in a ready-for-use condition, adjusting the existing gate box and hydrant to final grade, and providing and installing sleeves, fittings, and thrust blocks or joint restraints.
2. Case 2 includes the cost of removing the existing hydrant, gate valve and box, and reinstalling the hydrant and gate valve in a ready-for-use condition, adjusting the existing gate box and hydrant to final grade, and providing and installing the cutting-in-sleeve, pipe coupling, tee, elbow, thrust blocks or joint restraints. If used at the Contractor's option, the cost of Live Taps is included in the unit price for **Hydrant, Relocate, Case 2**.

The Department will pay separately for Live Taps and additional pipe greater than 10 feet, where detailed on the plans.

## Section 824. CONTRACTOR STAKING

**824.01. Description.** This work consists of contractor staking on the project, and developing grades and field notes from data shown on the plans. Provide these grades to the Engineer after calculation and at least 48 hours before beginning related work, or as requested by the Engineer.

The Contractor may request printouts of profile grades shown on the plans and other information related to the development of the grades. This information may not be complete or accurate. Do not use this information as a basis for claim relating to plan errors and omissions.

Submit, for the Engineer's approval, the crew chief's resume, including ability, experience, and education.

**824.02. Materials.** Provide stakes, planed on both sides, of the following minimum dimensions and type:

- A. Grade stakes 1 inch by 2 inches by 36 inches, light colored hardwood;
- B. Slope stakes 1 inch by 4 inches by 24 inches, light colored hardwood; and
- C. Pavement stakes 1 inch by 4 inches by 36 inches, light colored hardwood.

### **824.03. Construction.**

A. **Control Points.** Witness horizontal control points, including curvature points, tangent deflections, and spiral controls for reestablishment of line and distance to within 0.02 foot. Ensure the measured distance between control points checks with a precision of 1 in 5,000 for road work and 1 in 10,000 for bridge work. Maintain at least three witnesses for each control point, each visible from the other, during construction.

B. **Benchmarks.** Run a level circuit over the entire project to check plan benchmarks and establish new benchmarks. Loop benchmarks with at least three benchmarks in the loop and check within 0.01 foot. During grading, check into benchmarks, within 0.03 feet, at 1,000-foot intervals. Advise the Engineer of bench elevation corrections due to out-of-tolerance checks. Maintain at least two benchmarks at each structure during construction.

C. **Slope Stakes, Subgrade Stakes, Undercut Stakes, Clearing Stakes.** Provide slope stakes, subgrade stakes, undercut stakes and clearing stakes at 50-foot intervals or as agreed by the Engineer, and at



break points due to subgrade transitions, including superelevation transitions and ramp transitions. The Engineer may request subgrade stakes for subgrade inspection, after topsoil stripping and before beginning subsequent grading operations. The Engineer will mark and determine individual tree removal.

**D. Pavement Stakes.** After placing and rough grading the subbase, provide pavement stakes as follows:

1. Place stakes at 50-foot intervals on tangent sections and on curves with radii of at least 1,150 feet.
2. Place stakes at 25-foot intervals on curves with radii of less than 1,150 feet.
3. In addition to yield stakes, set stakes to determine wedging limits for hot mix asphalt pavement. This may include taking cross sections in questionable areas, as determined by the Engineer.

Use pavement grade stakes for finish grading of the subbase, base course, and pavement. Check stakes for grade, realign, and tack before beginning paving operations. Determine the offsets required for Contractor operations and obtain the Engineer's approval.

**E. Drainage Stakes.** Provide grade and location stakes for culverts, sanitary sewers, storm sewers, subsurface drains, drainage structures, sanitary structures, and outlets to ensure positive drainage. Secure the Engineer's approval for adjustments in location and grade for drainage items.

Before installing underdrains, submit a plan for underdrain outlets to the Engineer for approval, including the following information:

1. Distance between outlets;
2. Low point of vertical curves; and
3. Comparison between clay grade, the underdrain grade, the outlet grade, and the ditch grade at each outlet location.

**F. Miscellaneous Staking.** Provide staking for the following:

1. Pump stations,
2. Curb and gutter,
3. Sidewalk,
4. Watermains,
5. Retaining walls,
6. Siphons,
7. Sound walls,
8. Barrier walls,
9. Junction chambers,

10. Guardrail,
11. Sign structures,
12. Signs,
13. Structure under clearance,
14. Crossovers,
15. Restoration items,
16. Erosion control items, and
17. Other staking required to construct the project.

**G. Utility Staking.** Provide bridge and roadway location grades and layout of contract work for use by the utility companies to relocate facilities within the project right-of-way.

**H. Muck Stakes.** Provide muck stakes in accordance with the following, or as modified by the Engineer:

1. Place centerline stakes in accordance with subsection [824.03.D.1](#), and subsection [824.03.D.2](#).
2. Place offset stakes at no greater than 50-foot intervals to provide information for construction and determining pay quantities.
3. Ensure each stake displays stationing, offset distance, and ground elevation.
4. To determine the depths of replaced muck, establish a grid, as directed by the Engineer, to establish the amount of peat excavation. A normal grid consists of one cross section every 50 feet along the centerline between the 1:1 slope intercept with the original ground, as shown on the standard plans for treatment of peat marshes.

**I. Temporary Signs.** Place temporary sign stakes or markings as shown on the plans, and to maintain traffic as required. Notify the Engineer after completing temporary staking and marking, before installing temporary signs.

**J. Bridge Approaches.** Develop grades and field notes to construct bridge approaches from data shown on the plans.

**K. Bridge Substructure.** Upon completion of foundation excavation, the Engineer will verify the foundation line and grade.

Carry the line and grade to the bridge seat elevation, aligning and dimensioning forms, and staking substructure work including footing embankment or excavation, pile layout, footings, abutment wall, and anchor bolts.

Before casting pier caps or abutment walls, the Engineer will verify the line, grade, and span lengths. Make adjustments at no additional cost to the Department.

L. **Bridge Superstructure.** Set the following grades required to complete the structure:

1. Deck and rail grades,
2. Screed,
3. Haunch,
4. Bulkhead,
5. Sidewalk,
6. Curb,
7. Fascia,
8. Barrier grades, and
9. Other grades required.

Determine beam elevations, existing deck elevations, or both, to calculate final deck grades, including those for overlay projects. Provide final deck grades and associated calculations to the Engineer before setting the rail grades.

Obtain the Engineer's approval before adjusting the screed to obtain proper slab depth, steel cover, ride quality, drainage, or cosmetic appearance. Provide the Engineer other bridge superstructure grades requiring adjustment before use and stake at no additional cost to the Department. The Department will pay for Engineer directed changes as extra work.

Provide structure clearance measurements to the Engineer for new construction or improvements of existing roadways or structures.

M. **Bridge Overlays.** On overlay projects, determine finished deck grades referenced to a proposed deck profile, and obtain the Engineer's approval before setting expansion joint devices. Set expansion joint grades along the centerline of the expansion joint device in accordance with the proposed deck cross section.

Base the profile at break points across the bridge deck section and at no greater than 25-foot intervals on elevations taken on the existing concrete deck. If the existing deck includes a bituminous overlay, take the existing elevations after removing the bituminous overlay. Unless otherwise shown on the plans, match the proposed deck cross slopes to existing deck cross slopes.

Correct irregularities in existing profile cross section and slope to achieve ride quality and drainage. In determining bridge deck elevations, consider scarifying depths, hydro-demolishing depths, and the minimum thickness of overlay material to avoid overlay material quantity overruns. Calculate the quantity of overlay material required to construct the deck

to the elevations shown on the plans and submit calculations to the Engineer before beginning construction.

**N. Site Adjustments.** Review the plans. Develop grades and notes, after performing checks on the project. If deviations from the plans occur, immediately notify the Engineer and propose a solution. The Engineer will determine the actual solution and provide timely direction.

**O. Final Measurement.** Provide detailed measurements, sketches, and computations of final measurement for earthwork, undercuts, muck excavation, swamp backfill, sand subbase, and topsoil stripping.

**P. Construction Survey and Staking Measurements.** Provide construction surveying and staking to the tolerances specified in Table 824-1.

| <b>Table 824-1<br/>Construction Survey and Staking Tolerances</b>  |  |  |
|--|--|--|
| <b>Type</b>  | <b>Horizontal</b>  | <b>Vertical</b>  |
| Bench Loops  | 1,000 ft (maximum); 100 ft (minimum) between benchmarks              | 0.01 ft (maximum)  |
| ROW Stakes   | 0.01 ft (maximum)  | —  |
| Clearing Stakes  | 0.10 ft (maximum)  | —  |
| Slope, Subgrade, Utility Tunnel, and Miscellaneous Stakes  | 0.10 ft (maximum)  | 0.03 ft (maximum)  |
| Pavement, Drainage and Bridge Stakes   | 0.01 ft (maximum)  | 0.01 ft (maximum)  |
| Cross Sections   | 25 ft (minimum) left and right; 50 ft (minimum) along centerline (a) | 0.10 ft (maximum) on ground shots; 0.01 ft (maximum) on others |
| a. Distances shown are minimum allowable distances between cross section stakes left and right of centerline and along centerline. |  |  |

**Q. Preserving Stakes.** Preserve completed staking, as required for Engineer inspection of construction work. Maintain the dimensions, grades, and elevations of the work after the Engineer's inspection and approval of the layout.

Replace lost or destroyed stakes or benchmarks. Ensure the Engineer verifies replacement stakes or benchmarks.

Preserve stakes set by the Engineer. Replace stakes destroyed by Contractor operations at the Engineer's earliest convenience, at no additional cost to the Department.

Unless otherwise required, locate, preserve, and witness government monuments within the project. Ensure a registered land surveyor reestablishes monuments destroyed by Contractor operations or

negligence, as soon as possible and at no additional cost to the Department. Ensure placement of monumentation in accordance with section [823](#). If the surveying is incomplete, the Engineer will hire a registered land surveyor to complete the work, and all associated costs will be charged to the Contractor.

The Department will not pay for work dependant on lost or destroyed stakes until the Contractor replaces the stakes. The Department will not allow claims for damages caused by the Contractor's replacement of required stakes or benchmarks.

**R. Plan Errors.** Immediately notify the Engineer of a plan error. Document and submit to the Engineer, the efforts and the steps to correct a plan discrepancy. The Engineer will determine the solution and decide if the Contractor or the Department will provide staking for corrective action.

If a plan error results in extra work, the Engineer will issue a work order directing corrective action. Time for staking begins when the crew begins work detailed on the work order, including time for calculations and plotting. Provide written notification to the Engineer when work begins and ends.

**S. Extra Work.** For extra work, the Engineer will provide grades, calculations, or both. The Engineer will determine if the Contractor or the Department will perform required staking.

**T. Staking Changes.** The Engineer will resolve and approve staking changes within 2 working days. The Department will not allow claims for damages or extensions of time during the resolution and approval period for staking changes unless the Contractor shows the changes adversely affect the critical operation and fall outside the approved Contractor Quality Control Plan.

Before making Contractor initiated staking changes, including staking changes resulting from plan error, provide documentation for the Engineer's approval. Documentation for staking changes includes notes, calculations, and drawings.

During staking, perform checks to establish locations and grades to fit the existing conditions as agreed by the Engineer. Correct errors from Contractor operations at no additional cost to the Department.

**U. Staking Documentation.** Sign, check, date, and provide staking documentation and field notes, as approved by the Engineer before beginning work. The Department may inspect field notes and calculation documents any time. Original field notes and grade calculation

documents will become the Department's property upon completion of the work.

Provide original and final plotted cross sections and final volume calculations in a format approved by the Engineer for earthwork, undercuts, muck excavation, swamp backfill, sand subbase, and topsoil stripping. Determine final quantities by plan sheet breakdown.

Provide intermediate plotted cross sections to verify interim earthwork quantities if the Department requests. Provide the Engineer a final "as constructed" full-sized set of plans documenting vertical and horizontal alignment changes, drainage and subsurface changes, and other changes. Ensure plans and cross sections represent the same scale shown on the plans.

**V. Contractor Staking Quality Control.** Provide Contractor Staking Quality Control (CSQC) to ensure compliance with contract requirements, including staking operations performed by subcontractors, keyed to construction sequence.

Perform staking in accordance with Department procedures, or an alternate guidebook approved by the Engineer.

At the preconstruction meeting, provide the Engineer with a CSQC plan detailing the selected guidebook for quality control and measures to detect and minimize construction staking errors.

The Engineer will perform periodic reviews of the CSQC plan with the Contractor during the project. The Department considers these assurance reviews. Allow the Engineer access to in-progress construction staking work and phases of the ongoing CSQC plan.

The Engineer will use assurance reviews to make independent checks on the reliability of quality control procedures as shown on the CSQC plan. Assurance reviews do not constitute the Engineer's acceptance of the work. Correct work related to staking errors.

**W. Contractor Staking Quality Control Plan.**

1. **Plan Manager.** Identify one person as plan manager. Provide a plan manager as the sole contact to the Department for staking quality control. The plan manager is responsible for contractor staking quality control on each phase of the project. Ensure the plan manager is on the project during staking operations.
2. **Equipment Calibration.** Provide copies of equipment certification for levels, transits, lasers, total stations, and GPS units. Check equipment on a semi-annual basis or if equipment accuracy

becomes questionable. Perform tests on a certified stand if possible. If performing field checks, document the method and readings and provide to the Engineer.

3. **Procedures and Records.** Include, in the CSQC plan, a listing of the procedures and records to control the quality of the staking operation. Provide at least the following information:
  - a. List of work items for staking,
  - b. Description of methods of computing grades and staking,
  - c. Description of the checks to detect errors,
  - d. Methods of documentation,
  - e. Procedure to handle detected errors, and
  - f. Final measurement methods and documentation.
4. **Approval of CSQC Plan.** Ensure the Engineer accepts the CSQC plan before beginning staking operations. The Department will review the plan to determine acceptability within five working days. Do not begin work until the Engineer accepts the plan in writing. The Department will not grant extensions of time without liquidated damages for the Contractor's inability to submit an acceptable plan.
5. **Changing the Plan.** If the Department determines the Contractor's performance is unsatisfactory, the Department reserves the right to require the Contractor to make changes in the CSQC plan at no additional cost to the Department. The Department may suspend work operations until the Engineer approves the plan changes.

**824.04. Measurement and Payment.**

| <b>Pay Item</b>                                   | <b>Pay Unit</b> |
|---|-----------------|
| Contractor Staking.....                           | Lump Sum        |
| Contractor Staking, Road Only.....                | Lump Sum        |
| Staking Plan Errors and Extras, One Person.....   | Hour            |
| Staking Plan Errors and Extras, Two Person.....   | Hour            |
| Staking Plan Errors and Extras, Three Person..... | Hour            |

If the Engineer determines the Contractor will perform staking as extra work, the Department will pay for staking in accordance with subsection [109.07](#).

If the contract does not include the pay items listed in this subsection [824.04](#), the Department is responsible for construction layout and the work specified in this section and subsection [104.09](#) will not apply.

The Department will make partial payments for staking pay items in accordance with the following Table 824-2:

| <b>Table 824-2<br/>Staking Schedule of Partial Payments</b> |  |
|---|--|
| <b>Percent of Original Contract Pay Item Earned</b>         | <b>Percent of Contract Unit Price Paid</b> |
| Approved CSQC Plan  | 10%  |
| 10%   | 30%  |
| 50%   | 75%  |
| 90%   | 90%  |

The Department will retain 10 percent of the relevant contractor staking pay item until the Engineer receives the required documents.

The Department will not make adjustments in the lump sum amount for **Contractor Staking** if the final contract amount for the project is within  $\pm 5$  percent of the original contract amount or for approved extensions of time. If final contract amount differs from the original contract amount by greater than  $\pm 5$  percent, the Department will make an upward or downward adjustment to the lump sum amount for **Contractor Staking** by the percentage that exceeds  $\pm 5$  percent.

If the contract includes the pay item **Contractor Staking**, provide the lines, grades, and elevations specified in subsection [824.03](#) and subsection [104.09.B](#) for the prosecution, inspection, and final measurement of the work.

If the contract includes the pay item **Contractor Staking, Road Only**, provide the lines, grades, and elevations, except for bridges and approach slabs, as specified in subsection [824.03.J](#) through subsection [824.03.M](#), for the prosecution, inspection, and final measurement of road work.

The Department will pay for **Staking Plan Errors and Extras** at the unit price bid or at the following rates whichever is less:

- A. For one person, \$90 per hour;
- B. For two people, \$120 per hour; and
- C. For three people, \$150 per hour.

The Department will not pay separately for staking changes approved by the Engineer due to the Contractor's methods.



## NOTES

## DIVISION 9 – MATERIALS

| <b>Section</b> | <b>Title</b>                                       | <b>Page No.</b>            |
|----------------|--|----------------------------|
| 901            | Cement and Lime.....                               | <a href="#"><u>737</u></a> |
| 902            | Aggregates.....                                    | <a href="#"><u>738</u></a> |
| 903            | Admixtures and Curing Materials for Concrete.....  | <a href="#"><u>753</u></a> |
| 904            | Asphaltic Materials.....                           | <a href="#"><u>756</u></a> |
| 905            | Steel Reinforcement .....                          | <a href="#"><u>767</u></a> |
| 906            | Structural Steel .....                             | <a href="#"><u>770</u></a> |
| 907            | Fencing Materials .....                            | <a href="#"><u>775</u></a> |
| 908            | Miscellaneous Metal Products .....                 | <a href="#"><u>782</u></a> |
| 909            | Drainage Products.....                             | <a href="#"><u>789</u></a> |
| 910            | Geosynthetics .....                                | <a href="#"><u>810</u></a> |
| 911            | Water .....  | <a href="#"><u>814</u></a> |
| 912            | Timber and Lumber.....                             | <a href="#"><u>815</u></a> |
| 913            | Masonry Units .....                                | <a href="#"><u>833</u></a> |
| 914            | Joint and Waterproofing Materials .....            | <a href="#"><u>836</u></a> |
| 915            | Bridge Coating Systems .....                       | <a href="#"><u>842</u></a> |
| 916            | Erosion and Sedimentation Control Materials.....   | <a href="#"><u>844</u></a> |
| 917            | Turf and Landscaping Materials.....                | <a href="#"><u>848</u></a> |
| 918            | Electrical and Lighting Materials .....            | <a href="#"><u>857</u></a> |
| 919            | Permanent Traffic Sign and Support Materials ..... | <a href="#"><u>880</u></a> |
| 920            | Permanent Pavement Marking Materials.....          | <a href="#"><u>890</u></a> |
| 921            | Permanent Traffic Signal Materials.....            | <a href="#"><u>893</u></a> |
| 922            | Temporary Traffic Control Materials .....          | <a href="#"><u>933</u></a> |
| 923            | Water Main Materials.....                          | <a href="#"><u>947</u></a> |

## NOTES

## Section 901. CEMENT AND LIME

**901.01. General Requirements.** Provide facilities for sampling and inspecting cement at the mill, the distribution point, and the project. Store cement to allow access for inspection and identification of each shipment.

Ensure portland cement does not develop false set if tested by the mortar method specified in ASTM C 359. The Department defines false set as occurring if penetration is less than 5 mm at 5-minute, 8-minute, or 11-minute intervals. The Department will apply these limits if difficulties arise from premature stiffening during the concrete placement or finishing.

Before concrete placement, provide the Engineer a copy of the Certification of Quality of Cement, as provided by the producer.

**901.02. Testing.** Cement and lime materials testing must be in accordance with the specified ASTM, AASHTO, or Department methods, as modified by this section.

### **901.03. Portland Cement.**

A. **Type I, Type II, and Type III Portland Cements.** Type I, Type II, and Type III portland cements must meet the requirements of ASTM C 150. The requirements for Gillmore or Vicat setting time and the 7-day and 28-day compressive strength apply.

B. **Blended Cements.** Blended cements must meet the requirements of ASTM C 595.

**901.04. Masonry Cement.** Masonry cement must meet the requirements of ASTM C 91, Type N, Type S, or Type M.

**901.05. Hydrated Lime.** Hydrated lime must meet the requirements of ASTM C 207, Type S or Type SA.

**901.06. Slag Cement.** Slag cement must meet the requirements of ASTM C 989, Grade 100, minimum.

**901.07. Fly Ash.** Fly ash must meet the requirements of ASTM C 618, Class F, or Class C, except the loss on ignition must not exceed 5.0 percent and the air-entraining admixture uniformity requirement in Table 3 for Supplementary Optional Physical Requirements will apply.

**901.08. Silica Fume, Dry-Densified.** Dry-densified silica fume must meet the requirements of ASTM C 1240.

## Section 902. AGGREGATES

**902.01. General Requirements.** The Department may re-inspect and retest aggregates regardless of inspection at the producing plant. Provide safe access to the material for sampling from haul units or stockpiles.

Do not use spent metal casting foundry sand, unless the contract expressly allows for its use.

Do not contaminate aggregate during loading or measurement. Transport and place aggregate without loss of material.

**902.02. Testing.** Test aggregate materials in accordance with the following:

| <b>Material</b>   | <b>Test</b>             |
|---|-------------------------|
| Wire Cloth and Sieves .....                             | AASHTO M 92             |
| Materials Finer than 75 mm (No. 200) Sieve in           |                         |
| Mineral Aggregates by Washing .....                     | AASHTO T 11             |
| Specific Gravity and Absorption of Coarse Aggregate ..  | AASHTO T 85             |
| Specific Gravity and Absorption of Fine Aggregates..... | AASHTO T 84             |
| Sieve Analysis of Fine and Coarse Aggregate .....       | AASHTO T 27             |
| Sampling and Testing Fly Ash.....                       | ASTM C 311              |
| Sand Equivalent of Fine Aggregate.....                  | ASTM D 2419             |
| Flat Particles, Elongated Particles, or Flat and        |                         |
| Elongated Particles in Coarse Aggregate .....           | ASTM D 4791             |
| Organic Impurities in Fine Aggregate .....              | AASHTO T 21             |
| Sieve Analysis of Mineral Filler.....                   | AASHTO T 37             |
| Mortar Strength.....                                    | AASHTO T 71             |
| Particle Size Analysis .....                            | AASHTO T 88             |
| Plastic fines in Graded Aggregates and                  |                         |
| Soils by Use of the Sand Equivalent Test.....           | AASHTO T 167            |
| Uncompacted Void Content of Fine Aggregate.....         | AASHTO T 304            |
| Water Asphalt Preferential Test .....                   | <a href="#">MTM 101</a> |
| LA Abrasion Resistance of Aggregate .....               | <a href="#">MTM 102</a> |
| Insoluble Residue in Carbonate Aggregate.....           | <a href="#">MTM 103</a> |
| Sampling Aggregates .....                               | <a href="#">MTM 107</a> |
| Loss by Washing .....                                   | <a href="#">MTM 108</a> |
| Sieve Analysis of Aggregate.....                        | <a href="#">MTM 109</a> |
| Deleterious and Objectionable Particles .....           | <a href="#">MTM 110</a> |
| Aggregate Wear Index.....                               | <a href="#">MTM 112</a> |
| Selection and Preparation of Coarse Aggregate           |                         |
| Samples for Freeze-Thaw Testing.....                    | <a href="#">MTM 113</a> |

|  |                         |
|--|-------------------------|
| Making Concrete Specimens for Freeze-Thaw Testing on Concrete Coarse Aggregate ..... | <a href="#">MTM 114</a> |
| Freeze-Thaw Testing of Coarse Aggregate .....  | <a href="#">MTM 115</a> |
| Crushed Particles in Aggregates .....  | <a href="#">MTM 117</a> |
| Angularity Index of Fine Aggregate .....   | <a href="#">MTM 118</a> |
| Sampling Open-Graded Drainage Course   |                         |
| Compacted in Place .....   | <a href="#">MTM 119</a> |
| Dry Unit Weight (LM) of Coarse Aggregate.....  | <a href="#">MTM 123</a> |
| Determining Specific Gravity and Absorption of Coarse Aggregates .....               | <a href="#">MTM 320</a> |
| Determining Specific Gravity and Absorption of Coarse Aggregates .....               | <a href="#">MTM 321</a> |

A. **Terminology.** The Department uses the following terminology in the testing and acceptance of aggregates:

**Natural Aggregates.** Aggregates originated from stone quarries, gravel, sand or igneous/ metamorphic rock deposits.

**Slag Aggregates.** By-products formed in the production of iron, copper, and steel.

**Iron Blast Furnace Slag.** A synthetic nonmetallic by-product simultaneously produced with pig iron in a blast furnace that primarily consists of a fused mixture of oxides of silica, alumina, calcium, and magnesia.

**Reverberatory Furnace Slag.** A nonmetallic by-product of refined copper ore.

**Steel Furnace Slag.** A synthetic by-product of basic oxygen, electric or open-hearth steel furnaces that primarily consists of a fused mixture of oxides of calcium, silica, iron, alumina, and magnesia.

**Crushed Concrete Aggregate.** Crushed portland cement concrete.

**Salvaged Aggregate.** Dense-graded aggregate saved or manufactured from Department project sources that may consist of natural aggregate, blast furnace slag, crushed concrete, or reclaimed asphalt pavement with particle sizes no greater than 2 inches and no visible organic or foreign matter.

**Manufactured Fine Aggregate.** One hundred percent crushed rock, gravel, iron blast furnace slag, reverberatory furnace slag, steel furnace slag, or portland cement concrete.

**Natural Sand 2NS and 2MS.** Fine, clean, hard, durable, uncoated particles of sand free from clay lumps, and soft or flaky granular material resulting from the natural disintegration of rock, and used in concrete mixtures, mortar mixtures, and intrusion grout for pre-placed aggregate concrete.

**Stone Sand 2SS.** Sand manufactured from stone sources. These stone sources must meet the physical requirements for coarse aggregate 6A prior to crushing. The Engineer will only allow stone sand in concrete base course or structural concrete not exposed to vehicular traffic.

**Soft Particles.** Structurally weak particles or particles experiencing environmental deterioration, including shale, siltstone, friable sandstone, ochre, coal, and clay-ironstone.

**Crushed Particles.** Particles with at least one fractured face. The contract will specify the number of fractured faces based on required use. Unless otherwise specified, one fractured face is considered a crushed particle.

**Base Fineness Modulus.** The average fineness modulus typical of the source for a specific fine aggregate.

**Cobblestones (Cobbles).** Rock fragments, usually rounded or semi-rounded, with an average dimension between 3 inches and 10 inches.

**902.03. Coarse Aggregates for Portland Cement Concrete.** For coarse aggregates for portland cement concrete, use Michigan Class 4AA, 6AAA, 6AA, 6A, 17A, and 26A coarse aggregate produced from natural aggregate, iron blast furnace slag, or reverberatory furnace slag sources.

The Contractor may produce Michigan Class 6A, 17A and 26A from crushed portland cement concrete for uses specified in this subsection.

Ensure the bulk dry specific gravity falls within the limits established by freeze-thaw testing.

Provide coarse aggregates for portland cement concrete in accordance with Table [902-1](#), Table [902-2](#), and this subsection.

A. **Slag Coarse Aggregate.** Use slag coarse aggregate consisting of iron blast furnace slag or reverberatory furnace slag with a dry (loose measure) unit weight of at least 70 pounds per cubic foot in accordance with [MTM 123](#).

**B. Crushed Concrete Coarse Aggregate.** Use Department-owned concrete on the project to produce crushed concrete coarse aggregate. The Contractor may use crushed concrete coarse aggregate in the following concrete mixtures: curb and gutter, valley gutter, sidewalk, concrete barriers, driveways, temporary pavement, interchange ramps with a commercial ADT less than 250, and concrete shoulders.

Do not use crushed concrete coarse aggregate in the following: mainline pavements or ramps with a commercial ADT greater than or equal to 250, concrete base course, bridges, box or slab culverts, headwalls, retaining walls, pre-stressed concrete, or other heavily reinforced concrete.

Avoid contamination with non-concrete materials, including joint sealants, HMA patching, and base layer aggregate or soil, when processing crushed concrete coarse aggregate. Limit contamination particles retained on the  $\frac{3}{8}$ -inch sieve to no greater than 3.0 percent, based on a particle count of the total retained  $\frac{3}{8}$ -inch aggregate particles. The Engineer will reject any aggregate stockpile contaminated with building brick, wood, or plaster. Steel reinforcement pieces may remain in the stockpile if they can pass the maximum grading sieve size without aid. Ensure the fine aggregate portion of the gradation does not exceed a liquid limit of 25.0 percent or a plasticity index of 4.0.

The Engineer will test the freeze-thaw durability of crushed concrete coarse aggregate for each project. After the Department's central laboratory receives the aggregate samples, each test requires at least three months for testing.

Crush concrete ensuring it maintains uniform aggregate properties with no apparent segregation. The specific gravity must not vary more than  $\pm 0.05$  nor the absorption by more than  $\pm 0.40$ . Separate crushed concrete aggregate according to the original coarse aggregate type, except in the following situations:

1. If the weighed quantities of each aggregate type retained on the No. 4 sieve do not differ from the average quantities obtained from at least three representative samples by more than 10 percent; or
2. If using aggregate produced from concrete pavement with only one type of aggregate, but repaired with concrete patches with a different aggregate type.



## C. Aggregates for Optimized Gradation.

### 1. Coarse Aggregate Requirements.

- a. Coarse aggregate includes all aggregate particles greater than or retained on the ½-inch sieve.
- b. The physical requirements for coarse aggregate are as specified in Table [902-2](#) for Class 6AAA and the following:
  - i. Maximum 24 hour soak absorption of 2.50 percent;
  - ii. Maximum freeze-thaw dilation of 0.040 percent per 100 freeze-thaw cycle;
  - iii. Maximum flat and elongated particles of 15.0 percent as measured on the greater than or retained on the ¾-inch sieve using a 3:1 aspect ratio (ASTM D 4791); and
  - iv. Maximum Loss by Washing per [MTM 108](#) of 2.0 percent for materials produced entirely by crushing rock, boulders, cobbles, slag or concrete; otherwise 1.0 percent.

### 2. Intermediate Aggregate Requirements.

- a. Intermediate aggregate includes all aggregate particles passing the ½-inch sieve through those retained on the No. 4 sieve.
- b. The physical requirements for intermediate aggregate are as specified in Table [902-2](#) for Class 6AAA and the following:
  - i. Maximum freeze-thaw dilation of 0.067 percent per 100 freeze-thaw cycle;
  - ii. Maximum sum of soft and chert particles of 4.0 percent by weight ([MTM 110](#)); and
  - iii. Maximum Loss by Washing per [MTM 108](#) of 2.0 percent.

### 3. Fine Aggregate Requirements.

- a. Fine aggregate includes all aggregates particles passing the No. 4 sieve.
- b. The fine aggregate must meet the requirements of subsection [902.08](#).

**902.04. Chip Seal Aggregates.** For chip seal, use 34CS aggregate with a maximum moisture content of 4 percent, calculated in accordance with section [109](#) at the time of placement, and in accordance with Table [902-7](#), and Table [902-8](#).

**902.05. Dense-Graded Aggregates for Base Course, Surface Course, Shoulders, Approaches and Patching.** When necessary, combine fine aggregate with natural aggregate, iron blast furnace slag, reverberatory furnace slag, or crushed concrete to produce Michigan

Class 21AA, 21A, 22A, and 23A dense-graded aggregates in accordance with Table [902-1](#), Table [902-2](#), and this subsection.

Ensure dense-graded aggregate produced by crushing portland cement concrete does not contain more than 5.0 percent building rubble or hot mix asphalt by particle count. The Department defines building rubble as building brick, wood, plaster, or other material. The Engineer will allow pieces of steel reinforcement capable of passing through the maximum grading sieve size without aid.

Do not use Class 21AA, 21A and 22A dense-graded aggregate produced from crushing portland cement concrete to construct an aggregate base or an aggregate separation layer when the dense-graded layer drains into an underdrain, unless at least one of the following conditions apply:

- A. A vertical layer of at least 12 inches of granular Class I, II, IIA, or IIAA exists between the dense-graded aggregate layer and an underdrain; or
- B. A geotextile liner or blocking membrane, that will be a barrier to leachate, placed between the crushed concrete and the underdrain.

Only produce Class 23A dense-graded aggregate from steel furnace slag for use as an unbound aggregate surface course or as an unbound aggregate shoulder.

**902.06. Open-Graded Aggregates for Earthwork, Open-Graded Drainage Courses and Underdrains.** Use Michigan Class 4G, 34G, and 34R open-graded aggregates produced from natural aggregate, iron blast furnace slag, reverberatory furnace slag, or crushed concrete in accordance with Table [902-1](#) and Table [902-2](#).

Ensure open-graded aggregate 4G produced by crushing portland cement concrete does not contain more than 5.0 percent building rubble or hot mix asphalt by particle count. The Department defines building rubble as building brick, wood, plaster, or other material. The Engineer will allow pieces of steel reinforcement capable of passing through the maximum grading sieve size without aid.

Do not use open-graded aggregate 34G or 34R produced from portland cement concrete.

**902.07. Granular Materials for Fill and Subbase.** Use granular materials consisting of sand, gravel, crushed stone, iron blast furnace slag, reverberatory furnace slag or a blend of aggregates in accordance with Table [902-3](#) and this subsection.

The Contractor may make the following substitutions:

- A. Class I or Class IIAA material for Class II material;
- B. Class I, Class II, Class IIA, Class IIAA or Class IIIA material for Class III material; and
- C. Class I material for Class IIAA material.

Do not use material with cementitious properties or with permeability characteristics that do not meet design parameters for subbase.

The Engineer will only allow the use of granular material produced from crushed portland cement concrete for swamp backfill, embankment (except the top 3 feet below subgrade) and as trench backfill for non-metallic culvert and sewer pipes without associated underdrains.

The Engineer may allow the placement of granular material produced from steel furnace slag below the top 3 feet of the embankment and fill.

#### **902.08. Fine Aggregates for Portland Cement Concrete and Mortar.**

Ensure that, when tested for organic impurities in accordance with AASHTO T 21, the aggregate does not produce a color darker than Plate 3 (light brown). The Engineer may approve the use of fine aggregate that fails the test for organic impurities based on one of the following:

- A. The discoloration resulted from small quantities of coal, lignite, or similar discrete particles, or
- B. The tested concrete develops a relative seven-day strength of at least 95 percent in accordance with AASHTO T 71.

Uniformly grade the aggregate from coarse to fine in accordance with Table [902-4](#). Fine aggregate 2NS, 2SS, and 2MS must meet fineness modulus requirements in Table [902-4](#).

Do not use crushed portland cement concrete fine aggregate in new concrete mixtures.

**902.09. Aggregate General Requirements for HMA Mixtures.** Ensure the HMA mixture consists of aggregate materials meeting the requirements of Table [902-5](#) and Table [902-6](#) for the mix number and type required.

**A. Coarse Aggregates.** For HMA mixtures, use natural aggregate, iron blast furnace slag, reverberatory furnace slag, steel furnace slag, or crushed concrete as coarse aggregate.

**B. Fine Aggregates.** For HMA mixtures, use natural aggregate, iron blast furnace slag, reverberatory furnace slag, steel furnace slag, manufactured fine aggregate, or a uniformly graded blend as fine aggregate. Ensure fine aggregates are clean, hard, durable, uncoated,

and free of clay lumps, organic matter, soft or flakey material and other foreign matter.

#### **902.10. Surface Treatment Aggregates.**

A. **Paver-Placed Surface Seal.** For paver-placed surface seal, use aggregate 27SS or 30SS consisting of material meeting the requirements of subsection [902.09.B](#) and in accordance with Table [902-7](#) and Table [902-8](#).

B. **Micro-Surfacing.** For micro-surfacing, use 2FA and 3FA aggregates consisting of crushed material from a quarried stone, natural gravel, slag source, or a blend in accordance with Table [902-7](#) and Table [902-8](#).

C. **Slurry Seal.** For slurry seal, use 2FA aggregate consisting of crushed material from a quarried stone, natural gravel, slag source, or a blend in accordance with Table [902-7](#) and Table [902-8](#).

**902.11. Mineral Filler for HMA Mixtures.** For HMA mixtures, use dry, 3MF mineral filler consisting of limestone dust, dolomite dust, fly ash collected by an electrostatic precipitation method, slag, or hydrated lime with 100 percent passing the No. 30 sieve and 75 percent to 100 percent passing the No. 200 sieve. Mineral filler must be from a Department-approved source or must be tested on a per project basis. The free carbon content of the fly ash sample must not exceed 12 percent by weight as measured by the loss on ignition test in accordance with ASTM C 311.

**Table 902-1  
Grading Requirements for Coarse Aggregates, Dense-Graded Aggregates, and Open-Graded Aggregates**

| Material Type           | Class     | Item of Work by Section Number (Sequential)   | Sieve Analysis (MTM 109) Total Percent Passing (a) |        |          |        |        |        |        |       |       |        | Loss by Washing (MTM 102) % Passing |             |   |   |               |
|-------------------------|-----------|---|--|--------|----------|--------|--------|--------|--------|-------|-------|--------|-------------------------------------|-------------|---|---|---------------|
|                         |           |   | 2 1/2 in   | 2 in   | 1 1/2 in | 1 in   | 3/4 in | 1/2 in | % in   | No. 4 | No. 8 | No. 30 |                                     | No. 200 (a) |   |   |               |
| Coarse Aggregates       | 4 AA (b)  | <u>602</u>                                    | 100  | 90-100 | 40-60    | —      | 0-12   | —      | —      | —     | —     | —      | —                                   | —           | — | — | ≤2.0          |
|                         | 6 AAA (b) | <u>602</u>                                    | —  | —      | 100      | 90-100 | 60-85  | 30-60  | —      | —     | —     | —      | —                                   | —           | — | — | ≤1.0 (c)      |
|                         | 6 AA (b)  | <u>601, 602, 706, 708, 806</u>                | —  | —      | 100      | 95-100 | —      | 30-60  | —      | —     | —     | —      | —                                   | —           | — | — | ≤1.0 (c)      |
|                         | 6 A       | <u>205, 401, 402, 601, 602, 603, 706, 806</u> | —  | —      | 100      | 95-100 | —      | 30-60  | —      | —     | —     | —      | —                                   | —           | — | — | ≤1.0 (c)      |
|                         | 17 A      | <u>401, 406, 701, 706, 708</u>                | —  | —      | —        | 100    | 90-100 | 50-75  | —      | —     | —     | —      | —                                   | —           | — | — | ≤1.0 (c)      |
|                         | 25 A      |   | —  | —      | —        | —      | 100    | 95-100 | 60-90  | 5-30  | —     | —      | —                                   | —           | — | — | ≤3.0          |
| Dense-Graded Aggregates | 26 A      | <u>706, 712</u>                               | —  | —      | —        | —      | 100    | 95-100 | 60-90  | 5-30  | —     | —      | —                                   | —           | — | — | ≤3.0          |
|                         | 29 A      |   | —  | —      | —        | —      | —      | 100    | 90-100 | 10-30 | —     | —      | —                                   | —           | — | — | ≤3.0          |
|                         | 21 AA     | <u>302, 304, 305, 306, 307</u>                | —  | —      | 100      | 85-100 | —      | 50-75  | —      | —     | —     | —      | —                                   | —           | — | — | 4-8 (d,e)     |
|                         | 21 A      | <u>302, 305, 306, 307</u>                     | —  | —      | 100      | 85-100 | —      | 50-75  | —      | —     | —     | —      | —                                   | —           | — | — | 4-8 (d,e)     |
|                         | 22 A      | <u>302, 305, 306, 307</u>                     | —  | —      | 100      | 90-100 | —      | —      | 65-85  | —     | —     | —      | —                                   | —           | — | — | 4-8 (d, e, f) |
|                         | 23 A      | <u>306, 307</u>                               | —  | —      | 100      | —      | —      | —      | 60-85  | —     | —     | —      | —                                   | —           | — | — | 9-16 (e)      |
| Open-Graded Aggregates  | 4 G (g)   | <u>303</u>                                    | —  | —      | —        | —      | —      | —      | —      | —     | —     | —      | —                                   | —           | — | — | —             |
|                         | 34 R      | <u>401, 404</u>                               | —  | —      | —        | —      | —      | 100    | 90-100 | —     | —     | —      | —                                   | —           | — | — | ≤3.0          |
|                         | 34 G      | <u>404</u>                                    | —  | —      | —        | —      | —      | 100    | 95-100 | —     | —     | —      | —                                   | —           | — | — | ≤3.0          |

a. Based on dry weights.  
 b. Class 6AAA will be used exclusively for all mainline and ramp concrete pavement when the directional commercial ADT is greater than or equal to 5,000 vehicles per day.  
 c. Loss by Washing will not exceed 2.0 percent for material produced entirely by crushing rock, boulders, cobbles, slag, or concrete.  
 d. When used for aggregate base courses, surface courses, shoulders and approaches and the material is produced entirely by crushing rock, boulders, cobbles, slag, or concrete, the maximum limit for Loss by Washing must not exceed 10 percent.  
 e. The limits for Loss by Washing of dense-graded aggregates are significant to the nearest whole percent.  
 f. For aggregates produced from sources located in Berrien County, the Loss by Washing must not exceed 8 percent and the sum of Loss by Washing and shale particles must not exceed 10 percent.  
 g. Reference contract documents.

Table 902-2  
Physical Requirements for Coarse Aggregates, Dense-Graded Aggregates, and Open-Graded Aggregates

| Material                              | Series/<br>Class | Gravel, Stone, and Crushed Concrete        |  |  |                              |   | Slag (a)  |   | All Aggregates   |   |
|---------------------------------------|------------------|--|--|--|------------------------------|---|---|---|--|---|
|                                       |                  | Crushed<br>Material, %<br>min (MTM<br>117) | Loss, % max,<br>Los Angeles<br>Abrasion<br>(MTM 102) | Soft<br>Particles,<br>% max<br>(MTM 110) | Chert, %<br>max<br>(MTM 110) | Sum of Soft<br>Particles and<br>Chert, % max<br>(MTM 110) | Freeze-Thaw<br>Dilation, %<br>per 100 cycle<br>max<br>(MTM 115) (d) | Sum of Coke<br>and Coal<br>Particles, %<br>max<br>(MTM 110) | Freeze-Thaw<br>Dilation, %<br>per 100<br>cycles max<br>(MTM 115) (d) | Flat and<br>Elongated<br>Particles, ratio<br>% max<br>(ASTM D 4791) |
| Coarse<br>Aggregates<br>(n)           | 4 AA (b)         | —  | 40   | —  | —                            | 2.0 (c)   | 0.020   | 1.0   | 0.020  | 3:1–15.0 (l)  |
|                                       | 6 AAA            | —  | 40   | 2.0 (e)                                  | 2.5                          | 4.0   | 0.040 (f)   | 1.0   | 0.040 (f)  | —   |
|                                       | 6 AA (g)         | —  | 40   | 2.0 (e)                                  | —                            | 4.0   | 0.067 (h)   | 1.0   | 0.067  | —   |
|                                       | 6 A (g)          | —  | 40   | 3.0 (e)                                  | 7.0                          | 9.0   | 0.067   | 1.0   | 0.067  | —   |
|                                       | 17 A (g)         | —  | 40   | 3.5 (e)                                  | 8.0                          | 10.0  | 0.067   | 1.0   | 0.067  | —   |
|                                       | 25 A             | 95   | 45   | 8.0 (i)                                  | —                            | 8.0   | —   | 1.0   | —  | 3:1–20.0 (m)  |
|                                       | 26 A (g)         | —  | 40   | 2.0 (e)                                  | —                            | 4.0   | 0.067   | 1.0   | 0.067  | —   |
| Dense-<br>Graded<br>Aggregates<br>(j) | 29 A             | 95   | 45   | 8.0 (i)                                  | —                            | 8.0   | —   | 1.0   | —  | 3:1–20.0 (m)  |
|                                       | 21 AA            | 95   | 50   | —  | —                            | —   | —   | —   | —  | —   |
|                                       | 21 A             | 25   | 50   | —  | —                            | —   | —   | —   | —  | —   |
|                                       | 22 A             | 25   | 50   | —  | —                            | —   | —   | —   | —  | —   |
| Open-<br>Graded<br>Aggregates         | 23 A             | 25   | 50   | —  | —                            | —   | —   | —   | —  | —   |
|                                       | 4 G              | 95   | 45 (k)   | —  | —                            | —   | —   | —   | —  | —   |
|                                       | 34 R             | ≤20  | 45 (k)   | —  | —                            | —   | —   | —   | —  | —   |
|                                       | 34 G             | 100  | 45 (k)   | —  | —                            | —   | —   | —   | —  | —   |

**Notes for Table 902-2:**

- a. Iron blast furnace and reverberatory furnace slag must contain no free (unhydrated) lime.
- b. 2.50 percent maximum 24 hour soak absorption based on oven dry 6 series aggregate.
- c. 1.0% maximum for particles retained on the 1 inch sieve.
- d. If the bulk dry specific gravity is more than 0.04 less than the bulk dry specific gravity of the most recently tested freeze-thaw sample, the aggregate will be considered to have changed characteristics and be required to have a new freeze-thaw test conducted prior to use on Department projects.
- e. Clay-ironstone particles must not exceed 1.0 percent for 6AAA, 6AA and 26A, and 2.0 percent for 6A and 17A. Clay-ironstone particles are also included in the percentage of soft particles for these aggregates.
- f. Maximum freeze-thaw dilation is 0.067 when the directional commercial ADT is less than 5000 vehicles per day.
- g. Except for pre-stressed beams, the sum of soft and chert particles may be up to 3.0 percent higher than the values determined from the sample tested for freeze-thaw durability. However, under no circumstances will the deleterious particle percentages exceed the specification limits in Table 902-2. In addition, a source may be restricted to a minimum percent crushed not to exceed 15 percent less than the percent crushed in the freeze-thaw sample. When the freeze-thaw dilation is between 0.040 and 0.067 percent per 100 cycles more restrictive limits will be applied.
- h. Maximum dilation of 0.010 for pre-stressed concrete beams.
- i. Friable sandstone is included in the soft particle determination for chip seal aggregates.
- j. Quarried carbonate (limestone or dolomite) aggregate may not contain over 10 percent insoluble residue finer than No. 200 sieve when tested in accordance with [MTM 103](#).
- k. If a blend of different aggregate sources, the abrasion value applies to each source.
- l. ASTM D 4791 Section 8.4 will be followed. The test will be performed on the material retained down to and including the 1 inch sieve.
- m. ASTM D 4791 Section 8.4 will be followed. The test will be performed on the material retained down to and including the No. 4 sieve.
- n. Grade P1M concrete requires an optimized aggregate gradation as specified in section [604](#). Use aggregates only from geologically natural sources.

**Table 902-3  
Grading Requirements for Granular Materials**

| Material      | Sieve Analysis (MTM 109), Total % Passing (a) |        |      |        |       |      |        | Loss by Washing %<br>Passing No. 200 (a), (b) |        |         |      |
|---------------|---|--------|------|--------|-------|------|--------|---|--------|---------|------|
|               | 6 in  | 3 in   | 2 in | 1 in   | ½ in  | % in | No. 4  |   | No. 30 | No. 100 |      |
| Class I       | —   | —      | 100  | —      | 45-85 | —    | 20-85  | 5-30  | —      | —       | 0-5  |
| Class II (c)  | —   | 100    | —    | 60-100 | —     | —    | 50-100 | —   | 0-30   | —       | 0-7  |
| Class IIA (c) | —   | 100    | —    | 60-100 | —     | —    | 50-100 | —   | 0-35   | —       | 0-10 |
| Class IIAA    | —   | 100    | —    | 60-100 | —     | —    | 50-100 | —   | 0-20   | —       | 0-5  |
| Class III     | 100   | 95-100 | —    | —      | —     | —    | 50-100 | —   | —      | —       | 0-15 |
| Class IIIA    | —   | —      | —    | —      | —     | 100  | 50-100 | —   | 0-30   | —       | 0-15 |

a. Test results based on dry weights.  
b. Use test method [MTM 108](#) for Loss by Washing.  
c. Except for use in granular blankets, Class IIA granular material may be substituted for Class II granular material for projects located in the following counties: Arenac, Bay, Genesee, Gladwin, Huron, Lapeer, Macomb, Midland, Monroe, Oakland, Saginaw, Sanilac, Shiawassee, St. Clair, Tuscola, and Wayne counties.

**Table 902-4  
Grading Requirements for Fine Aggregates**

| Material | Sieve Analysis (MTM 109), Total Percent Passing (a) |        |        |        |        |        |         | Loss by Washing %<br>Passing No. 200<br>(a), (b) | Fineness<br>Modulus<br>Variation (c) |
|----------|---|--------|--------|--------|--------|--------|---------|--|--------------------------------------|
|          | % in  | No. 4  | No. 8  | No. 16 | No. 30 | No. 50 | No. 100 |  |                                      |
| 2NS      | 100   | 95-100 | 65-95  | 35-75  | 20-55  | 10-30  | 0-10    | —  | ±0.20 (d)                            |
| 2SS (e)  | 100   | 95-100 | 65-95  | 35-75  | 20-55  | 10-30  | 0-10    | 0-4.0  | ±0.20 (d)                            |
| 2MS      | —   | 100    | 95-100 | —      | —      | 15-40  | 0-10    | 0-3.0  | ±0.20 (d)                            |

a. Test results based on dry weights.  
b. Use test method [MTM 108](#) for Loss by Washing.  
c. Aggregate having a fineness modulus differing from the base fineness modulus of the source by the amount exceeding the maximum variation specified in the table, will be rejected. Use ASTM C 136.  
d. The base fineness modulus will be supplied by the aggregate producer at the start of each construction season and be within the range of 2.50 to 3.35. The base FM, including the permissible variation, will be within the 2.50 to 3.35 range.  
e. Quarried carbonate (limestone or dolomite) cannot be used for any application subject to vehicular traffic.



**Table 902-5  
Superpave Final Aggregate Blend Gradation Requirements  
Percent Passing Criteria (control points)**

| Standard Sieve | Mixture Number               |           |           |           |   | LVSP (a) |
|----------------|------------------------------|-----------|-----------|-----------|---|----------|
|                | 5                            | 4         | 3         | 2         | 2 |          |
| 1½ in          | —                            | —         | —         | 100       | — | —        |
| 1 in           | —                            | —         | 100       | 90–100    | — | —        |
| ¾ in           | —                            | 100       | 90–100    | ≤90       | — | 100      |
| ½ in           | 100                          | 90–100    | ≤90       | —         | — | 75–95    |
| ⅜ in           | 90–100                       | ≤90       | —         | —         | — | 60–90    |
| No. 4          | ≤90                          | —         | —         | —         | — | 45–80    |
| No. 8          | 32–67                        | 28–58     | 23–49     | 19–45     | — | 30–65    |
| No. 16         | —                            | —         | —         | —         | — | 20–50    |
| No. 30         | —                            | —         | —         | —         | — | 15–40    |
| No. 50         | —                            | —         | —         | —         | — | 10–25    |
| No. 100        | —                            | —         | —         | —         | — | 5–15     |
| No. 200        | 2.0–10.0                     | 2.0–10.0  | 2.0–8.0   | 1.0–7.0   | — | 3–6      |
| <b>Sieve</b>   | <b>Restricted Zone (b,c)</b> |           |           |           |   |          |
| No. 4          | —                            | —         | —         | 39.5      | — | (d)      |
| No. 8          | 47.2                         | 39.1      | 34.6      | 26.8–30.8 | — | (d)      |
| No. 16         | 31.6–37.6                    | 25.6–31.6 | 22.3–28.3 | 18.1–24.1 | — | (d)      |
| No. 30         | 23.5–27.5                    | 19.1–23.1 | 16.7–20.7 | 13.6–17.6 | — | (d)      |
| No. 50         | 18.7                         | 15.5      | 13.7      | 11.4      | — | (d)      |

a. For LVSP, less than 50 percent of the material passing the No. 4 sieve may pass the No. 30 sieve.

b. The final gradation blend must pass between the control points established. The following conditions must be satisfied in order for the final gradation blend to enter the restricted zone.

c. Mixture types E03, E1, E3, E10, E30, and E50 may enter the restricted zone provided the final gradation blend enters from above the maximum density line.

d. Restricted zone does not apply to LVSP.

Table 902-6

Superpave Final Aggregate Blend Physical Requirements

| Est. Traffic (million ESAL) | Mix Type | Fine Aggregate Angularity Minimum Criteria |             | % Sand Equivalent Minimum Criteria |             | Los Angeles Abrasion % Loss Minimum Criteria |             | % Soft Particles Maximum Criteria (b) |             | % Flat and Elongated Particles Maximum Criteria (c) |             |
|-----------------------------|----------|--|-------------|------------------------------------|-------------|--|-------------|---------------------------------------|-------------|---|-------------|
|                             |          | Top & Leveling Courses                     | Base Course | Top & Leveling Courses             | Base Course | Top & Leveling Courses                       | Base Course | Top & Leveling Courses                | Base Course | Top & Leveling Courses                              | Base Course |
|                             |          |  |             |                                    |             |  |             |                                       |             |   |             |
| <0.3                        | LVSP     | —  | —           | 40                                 | 40          | 45   | 45          | 10                                    | 10          | —   | —           |
| <0.3                        | E03      | —  | —           | 40                                 | 40          | 45   | 45          | 10                                    | 10          | —   | —           |
| >0.3-<1.0                   | E1       | 40   | —           | 40                                 | 40          | 40   | 45          | 10                                    | 10          | —   | —           |
| >1.0-<3                     | E3       | 40 (a)                                     | 40 (a)      | 40                                 | 40          | 35   | 40          | 5                                     | 5           | 10  | 10          |
| >3-<10                      | E10      | 45   | 40          | 45                                 | 45          | 35   | 40          | 5                                     | 5           | 10  | 10          |
| >10-<30                     | E30      | 45   | 40          | 45                                 | 45          | 35   | 35          | 3                                     | 4.5         | 10  | 10          |
| >30-<100                    | E50      | 45   | 45          | 50                                 | 50          | 35   | 35          | 3                                     | 4.5         | 10  | 10          |

a. For an E3 mixture type that enters the restricted zone as defined in Table 902.5, the minimum is 43. If these criteria are satisfied, acceptance criteria and associated incentive/disincentive or pay adjustment tied to this gradation restricted zone requirement included in the contract, do not apply. Otherwise, final gradation blend must be outside of the restricted zone.

b. Soft particles maximum is the sum of the shale, siltstone, ochre, coal, clay-ironstone, and particles that are structurally weak or are non-durable in service.

c. Maximum by weight with a 1:5 aspect ratio.

Table 902-7

CPM Final Aggregate Blend Gradation Requirements

| Material | Mechanical Analysis, Total Percent Passing |        |        |        |       |        |        |        |         |             |
|----------|--|--------|--------|--------|-------|--------|--------|--------|---------|-------------|
|          | ¾ in                                       | ½ in   | ¾ in   | No. 4  | No. 8 | No. 16 | No. 30 | No. 50 | No. 100 | No. 200 (a) |
| 27SS     | 100  | 85-100 | 55-80  | 22-38  | 19-32 | 15-24  | 11-18  | 8-14   | 5-10    | 4-7 (b)     |
| 30SS     | —  | 100    | 85-100 | 22-38  | 19-32 | 15-24  | 11-18  | 8-14   | 5-10    | 4-7 (b)     |
| 34CS     | —  | 100    | 90-100 | 0-10   | 0-5   | —      | —      | —      | —       | ≤2.0        |
| FA2      | —  | —      | 100    | 90-100 | 65-90 | 45-70  | 30-50  | 18-30  | 10-21   | 5-15 (b)    |
| FA3      | —  | —      | 100    | 70-90  | 45-70 | 28-50  | 19-34  | 12-25  | 7-18    | 5-15 (b)    |

a. Includes mineral filler.

b. No. 200 limits are significant to the nearest whole percent.

| CPM Aggregate Blend Physical Requirements |   |  |                                     |   |                                    |  |                                      |  |                             |                                      |
|---|---|--|-------------------------------------|---|------------------------------------|--|--------------------------------------|--|-----------------------------|--------------------------------------|
| Material                                  | Percent Crushed (Min) <a href="#">MTM 117</a> | Angularity Index (Min) <a href="#">MTM 118</a> | Uncompacted Void (Min) AASHTO T 304 | Los Angeles Abrasion (% Loss Max) <a href="#">MTM 102</a> | AWI (min.) <a href="#">MTM 112</a> | Soft Particles (% Max) <a href="#">MTM 110</a> | Sand Equivalent (% Min) AASHTO T 176 | Flat and Elongated (% Max) ASTM D 4791 | Absorp. (% Max) AASHTO T 85 | Mico-Deval (% Loss Max) AASHTO T 327 |
| 27SS (h)                                  | 90 (b)  | —  | 40                                  | 35  | 260                                | 5.0 (a)  | 45                                   | 25.0 (e)                               | 3.0                         | 18                                   |
| 30SS (h)                                  | 90 (b)  | —  | 40                                  | 35  | 260                                | 5.0 (a)  | 45                                   | 25.0 (e)                               | 3.0                         | 18                                   |
| 34CS                                      | 95  | —  | —                                   | 35 (c)  | 260 (d)                            | 3.5 (a)  | —                                    | 12.0 (e)                               | —                           | —                                    |
| FA2                                       | —   | 4.0 (f)  | —                                   | 45  | 260                                | —  | 60 (g)                               | —                                      | —                           | —                                    |
| FA3                                       | —   | 4.0  | —                                   | 45  | 260                                | —  | 60                                   | —                                      | —                           | —                                    |

a. Sum of shale, siltstone, clay-ironstone, and structurally weak.  
b. Percent two-faced crushed.  
c. L. A. Abrasion maximum loss of 45 for blast furnace slag.  
d. Does not apply to shoulder area of the chip seal.  
e. For material retained on the No. 4 sieve, ensure the ratio between length to width, or length to thickness, or combination is no greater than 3:1.  
f. Angularity index must exceed 2.0 for as least 50 percent of the blending sands for slurry seal applications.  
g. Does not apply to slurry seals.  
h. Must be 100% virgin aggregate.

## Section 903. ADMIXTURES AND CURING MATERIALS FOR CONCRETE

**903.01. Air-Entraining Admixtures.** Select air-entraining admixtures for concrete from the Qualified Products List.

**903.02. Liquid Chemical Admixtures.** Select liquid chemical admixtures for use in portland cement concrete from the Qualified Products List. Liquid chemical admixtures must not contain a chloride ion content greater than 0.5 percent by weight.

The Department uses the following ASTM C 494 terms for chemical admixtures:

| Table 903-1<br>ASTM C 494 Terms for Chemical Admixtures |  |
|---|--|
| Type  | Term   |
| A   | Water-reducing admixtures                            |
| C   | Accelerating admixtures                              |
| D   | Water-reducing and retarding admixtures              |
| E   | Water-reducing and accelerating admixtures           |
| F   | Water-reducing, high range admixtures                |
| G   | Water-reducing, high range, and retarding admixtures |

The Department refers to water-reducing, mid-range admixtures, not included in ASTM C 494, as Type MR.

**903.03. Latex Admixtures.** Formulated latex admixture for modifying mortar or concrete mixtures must be a non-toxic, film forming, polymeric emulsion to which all stabilizers are added at the point of manufacture. Latex admixtures must be homogeneous and uniform in composition.

**A. Physical Properties.** White latex styrene butadiene modifier must have between 46.0 percent and 49.0 percent solids, a pH, as shipped, between 8.5 and 11.0, and a shelf life of at least 2 years.

**B. Storage.** Protect latex admixtures from freezing. Do not expose latex admixtures to temperatures greater than 85 °F for more than 10 days.

**903.04. Calcium Chloride Concrete Accelerators.** Do not use calcium chloride in prestressed concrete, superstructure concrete, concrete for bridge railings, or concrete containing galvanized steel or aluminum.

Flake or pellet calcium chloride for on-the-job preparation of admixture solutions must meet the requirements of ASTM D 98 for 77 percent grade or 94 percent grade. Determine the percentage of calcium and magnesium chlorides in accordance with ASTM D 345. Provide flake or pellet Type S (solid) material.

Calcium chloride admixture, delivered to the job in solution, must conform to the following chemical composition:

- A. From 32.0 percent to 35.0 percent calcium chloride,  $\text{CaCl}_2$  (anhydrous);
- B. No greater than 1.0 percent total magnesium as  $\text{MgCl}_2$ ;
- C. No greater than 2.0 percent total alkali chlorides calculated as  $\text{NaCl}$ ; and
- D. No greater than 0.5 percent other impurities.

**903.05. Polypropylene Fibers.** Use 100 percent virgin polypropylene fibers,  $\frac{3}{4}$ -inch long, that meet the requirements of ASTM C1116, Type III.

**903.06. Concrete Curing Materials for Pavements.**

**A. White Membrane Curing Compound.** White membrane curing compound must meet the requirements of ASTM C 309, Type 2, and be packaged in clean containers.

Before use and before transferring the compound between containers, agitate the compound to a uniform consistency and ensure pigment is uniformly suspended.

**B. Transparent Membrane Curing Compound for Base Course.** Transparent membrane curing compound must meet the requirements of ASTM C 309, Type 1-D, Class B with fugitive dye.

**903.07. Concrete Curing Materials for Structures.**

**A. White Membrane Curing Compound for Bridge Decks.** Provide white-pigmented, modified, linseed oil based material either water soluble or an emulsion type that meets the requirements of ASTM C 309, Type 2 except that the reflectance requirement and drying time do not apply. Compound must be packaged in clean containers.

Before transferring the compound between containers and applying, agitate the compound to a uniform consistency and ensure uniform suspension of the pigment.

**B. Transparent Membrane Curing Compound.** Transparent membrane curing compound must meet the requirements of ASTM C 309, Type 1-D, Class B, with fugitive dye.

**C. Insulating Blankets.** Insulating blankets must meet Federal Specification HH-1-521e, Insulation, Building, Mineral-Wool; Batts, Loose-Fill, and Granular-Fill, Type 1-Batts, Class C, with enveloping membranes. Blankets must have liners that completely enclose and are bonded to both sides of the insulating mat. Blankets must have thicknesses or R-values meeting the requirements of Table [706-2](#).

Insulating blanket must have a thermal conductivity (k) no greater than 0.27 BTU per hour per square foot temperature gradient of 1 °F per inch of thickness at a mean temperature of 75 °F when tested in accordance with ASTM C 177.

**D. Polystyrene Insulation.** Expanded polystyrene must be cut from preformed material with an average cell diameter no greater than 0.04 inch and as specified in Table 903-2:

| <b>Table 903-2<br/>Polystyrene Insulation Specifications</b>                               |                                  |                    |
|--|----------------------------------|--------------------|
| <b>Property</b>  | <b>Specification</b>             | <b>Test Method</b> |
| Density  | ≥0.90 lb/ft <sup>3</sup>         | ASTM C 303         |
| Compressive Strength   | ≥9.0 psi                         | ASTM D 1621        |
| Flexural Strength  | ≥25.0 psi                        | ASTM C 203         |
| Water Absorption   | ≤2.0% by volume                  | ASTM C 272         |
| Thermal Conductivity   | ≤0.27 BTU/hr/ft <sup>2</sup> (a) | ASTM C 177         |
| a. For a temperature gradient of 1 °F per inch of thickness at a mean temperature of 75 °F |                                  |                    |

## Section 904. ASPHALTIC MATERIALS

**904.01. General Requirements.** The certification program described in the [Materials Quality Assurance Procedures Manual](#) governs the asphalt binders in Table [904-2](#) and the emulsified asphalts in Table [904-4](#), Table [904-5](#), and Table [904-6](#). The Contractor may use materials listed in Table [904-2](#) through Table [904-6](#) on MDOT projects, if tested and approved for use in accordance with MDOT procedures.

The Engineer will notify the Contractor and the supplier to correct materials if test results for the requirements from Table [904-2](#), Table [904-3](#), Table [904-4](#), Table [904-5](#) and Table [904-6](#) deviate from the specified range.

Asphaltic materials testing will be in accordance with the specified ASTM, AASHTO or Department methods, as modified by this section.

**904.02. Application Temperatures.** Apply asphaltic materials at temperatures specified in Table [904-7](#).

### **904.03. Specific Requirements.**

**A. Asphalt Binder.** Asphalt binder must be homogeneous, water-free, and must not foam when heated to the maximum temperature specified in Table [904-7](#) for the material required.

If using an anti-foaming agent, use a dimethyl polysiloxane type silicone material, preferably 1,000 centistoke viscosity grade, unless otherwise approved by the Engineer. Do not add amounts greater than 5 parts per million unless approved by the Engineer. Mechanically mix the asphalt binder after adding anti-foaming agent while in storage at the asphalt plant.

Asphalt cement must be prepared by refining crude petroleum with or without the addition of modifiers. Asphalt cement prepared with used motor oil is not allowed.

The Engineer will allow organic, virgin or recycled modifiers dissolved, dispersed, or reacted in asphalt cement to enhance performance.

Asphalt binder must be at least 99.0 percent soluble in accordance with AASHTO T 44 or ASTM D 5546.

This specification is not applicable for asphalt binders in which fibers or other discrete particles are larger than 250 micrometers in size.

**B. Cut-Back Asphalt.** Cutback asphalt must meet the requirements of Table [904-3](#) and this subsection.

Liquid asphalt must be homogeneous, must not foam when heated to the maximum required temperature and must be water-free unless otherwise required.

**Caution:** Use caution when heating cut-back asphalt, especially RC and MC asphaltic products containing naphtha and kerosene cutback asphalt, since the temperatures for use are near or above the flash points. If using heated cutbacks, keep open flames away from pugmill enclosures, tank car domes, distributor tank openings, and storage tank openings.

**C. Emulsified Asphalt.** Emulsified asphalt must meet the requirements of either Table [904-4](#), Table [904-5](#), or Table [904-6](#) and be made from asphalt having a negative spot test result using 35% xylene / 65% heptane solvent, Aniline No: 30 C  $\pm$  2 degrees, AASHTO T 102. It must be homogeneous and show no separation of asphalt after thorough mixing, for a period of at least 30 days after delivery.

**D. Polyester Fibers for Overband Crack Fill.** Provide General Certification for polyester fibers used for overband crackfill. Polyester fibers must meet the requirements of Table 904-1.

| <b>Table 904-1</b>                             |                      |                 |
|--|----------------------|-----------------|
| <b>Polyester Fiber Characteristics</b>         |                      |                 |
| <b>Characteristic</b>                          | <b>Requirement</b>   | <b>Test</b>     |
| Length   | 6.4 mm $\pm$ 0.05 mm | —               |
| Crimps   | None                 | ASTM D 3937     |
| Tensile strength                               | $\geq$ 480 MPa       | ASTM D 2256 (a) |
| Denier   | 3.0–6.0              | ASTM D 1577 (a) |
| Specific gravity                               | 1.32–1.40            | —               |
| Melting temperature                            | $\geq$ 245 °C        | —               |
| Ignition temperature                           | $\geq$ 540 °C        | —               |
| a. Obtain this data before cutting the fibers. |                      |                 |



**Table 904-2  
Performance Graded Asphalt Binder Specification**

| Performance Grade   | PG 46  |     |     |     |     |     | PG 52  |     |     |     |     |     | PG 58  |     |     |     |     |     |     |     |    |    |
|---|--------|-----|-----|-----|-----|-----|--------|-----|-----|-----|-----|-----|--------|-----|-----|-----|-----|-----|-----|-----|----|----|
|   | -34    | -40 | -46 | -10 | -16 | -22 | -28    | -34 | -40 | -46 | -16 | -22 | -28    | -34 | -40 | -16 | -22 | -28 | -34 | -40 |    |    |
| Avg 7-day Max. Pavement Design Temp, °C (a)   | 46     |     |     |     |     |     | 52     |     |     |     |     |     | 58     |     |     |     |     |     |     |     |    |    |
| Minimum Pavement Design Temp, °C (a)  | -34    | -40 | -46 | -10 | -16 | -22 | -28    | -34 | -40 | -46 | -16 | -22 | -28    | -34 | -40 | -16 | -22 | -28 | -34 | -40 |    |    |
| <b>Original Binder</b>  | 230 °C |     |     |     |     |     | 230 °C |     |     |     |     |     | 230 °C |     |     |     |     |     |     |     |    |    |
| Flash Point Temp, T48/D 92: Min.  | 230 °C |     |     |     |     |     | 230 °C |     |     |     |     |     | 230 °C |     |     |     |     |     |     |     |    |    |
| Viscosity, T 316/D 4402: Max. 3 Pas, Test Temp (b)  | 135 °C |     |     |     |     |     | 135 °C |     |     |     |     |     | 135 °C |     |     |     |     |     |     |     |    |    |
| Dynamic Shear, T 315/D 7175: G*/sin $\theta$ , Min. 1.00 kPa Test Temp at 10 rad/s (c, g)     | 46 °C  |     |     |     |     |     | 52 °C  |     |     |     |     |     | 58 °C  |     |     |     |     |     |     |     |    |    |
| <b>Rolling Thin Film Oven (T 240/D 2872)</b>  | 1.00   |     |     |     |     |     | 1.00   |     |     |     |     |     | 1.00   |     |     |     |     |     |     |     |    |    |
| Mass Loss, Max. Percent   | 1.00   |     |     |     |     |     | 1.00   |     |     |     |     |     | 1.00   |     |     |     |     |     |     |     |    |    |
| Dynamic Shear, T 315/D 7175: G*/sin $\theta$ , Min. 2.20 kPa Test Temp at 10 rad/s (g)        | 46 °C  |     |     |     |     |     | 52 °C  |     |     |     |     |     | 58 °C  |     |     |     |     |     |     |     |    |    |
| <b>Pressure Aging Vessel Residue (R 28/D 6521)</b>  | 90 °C  |     |     |     |     |     | 90 °C  |     |     |     |     |     | 100 °C |     |     |     |     |     |     |     |    |    |
| PAV Aging Temp (d)  | 90 °C  |     |     |     |     |     | 90 °C  |     |     |     |     |     | 100 °C |     |     |     |     |     |     |     |    |    |
| Dynamic Shear, T 315/D 7175: G* sin $\theta$ , Max. 5,000 kPa Test Temp at 10 rad/s, °C (g)   | 10     | 7   | 4   | 25  | 22  | 19  | 16     | 13  | 10  | 7   | 25  | 22  | 19     | 16  | 13  | 10  | 7   | 25  | 22  | 19  | 16 | 13 |
| Physical Hardening (e)  | Report |     |     |     |     |     | Report |     |     |     |     |     | Report |     |     |     |     |     |     |     |    |    |
| Creep Stiffness, T 313/D 6648: S, Max. 300 MPa, m-value, Min. 0.300 Test Temp at 60 s, °C (f) | -24    | -30 | -36 | 0   | -6  | -12 | -18    | -24 | -30 | -36 | -6  | -12 | -18    | -24 | -30 | -6  | -12 | -18 | -24 | -30 |    |    |
| Direct Tension, T 314/D 6723: Fail. Strain, Min. 1.0% Test Temp at 1.0 mm/min, °C (f)         | -24    | -30 | -36 | 0   | -6  | -12 | -18    | -24 | -30 | -36 | -6  | -12 | -18    | -24 | -30 | -6  | -12 | -18 | -24 | -30 |    |    |

| Table 904-2<br>Performance Graded Asphalt Binder Specification (Continued)                     |        |     |     |     |     |     |           |     |     |     |     |     |
|--|--------|-----|-----|-----|-----|-----|-----------|-----|-----|-----|-----|-----|
| Performance Grade  | PG 64  |     |     |     |     |     | PG 70     |     |     |     |     |     |
|  | -10    | -16 | -22 | -28 | -34 | -40 | >-10      | -16 | -22 | -28 | -34 | -40 |
| Avg 7 day Max. Pave Design Temp (a)  | 64 °C  |     |     |     |     |     | 70 °C     |     |     |     |     |     |
| Minimum Pavement Design Temp, °C   | -10    | -16 | -22 | -28 | -34 | -40 | -10       | -16 | -22 | -28 | -34 | -40 |
| <b>Original Binder</b>   |        |     |     |     |     |     |           |     |     |     |     |     |
| Flash Point Temp, T48/D 92: Min.   | 230 °C |     |     |     |     |     | 230 °C    |     |     |     |     |     |
| Viscosity, T 316/D 4402: Max. 3 Pa·s, Test Temp (b)  | 135 °C |     |     |     |     |     | 135 °C    |     |     |     |     |     |
| Dynamic Shear, T 315/D 7175:<br>G*/sin $\theta$ , Min. 1.00 kPa Test Temp at 10 rad/s (c,g)    | 64 °C  |     |     |     |     |     | 70 °C     |     |     |     |     |     |
| <b>Rolling Thin Film Oven (T 240/D 2872)</b>   |        |     |     |     |     |     |           |     |     |     |     |     |
| Mass Loss, Max. Percent  | 1.00   |     |     |     |     |     | 1.00      |     |     |     |     |     |
| Dynamic Shear, T 315/D 7175:<br>G*/sin $\theta$ , Min. 2.20 kPa Test Temp at 10 rad/s (g)      | 64 °C  |     |     |     |     |     | 70 °C     |     |     |     |     |     |
| <b>Pressure Aging Vessel Residue (R 28/D 6521)</b>   |        |     |     |     |     |     |           |     |     |     |     |     |
| PAV Aging Temp, °C (d)   | 100    |     |     |     |     |     | 100 (110) |     |     |     |     |     |
| Dynamic Shear, T 315/D 7175:<br>G*/sin $\theta$ , Max. 5,000 kPa Test Temp at 10 rad/s, °C (g) | 31     | 28  | 25  | 22  | 19  | 16  | 34        | 31  | 28  | 25  | 22  | 19  |
| Physical Hardening (e)   | Report |     |     |     |     |     | Report    |     |     |     |     |     |
| Creep Stiffness, T 313/D 6648: S, Max. 300 MPa, m-value, Min. 0.300 Test Temp at 60 s, °C (f)  | 0      | -6  | -12 | -18 | -24 | -30 | 0         | -6  | -12 | -18 | -24 | -30 |
| Direct Tension, T 314/D 6723: Fail. Strain, Min. 1.0% Test Temp at 1.0 mm/min, °C (f)          | 0      | -6  | -12 | -18 | -24 | -30 | 0         | -6  | -12 | -18 | -24 | -30 |

**Table 904-2  
Performance Graded Asphalt Binder Specification (Continued)**

| Performance Grade   | PG 76     |     |     |     |     | PG 82     |     |     |     |     |
|---|-----------|-----|-----|-----|-----|-----------|-----|-----|-----|-----|
|   | -10       | -16 | -22 | -28 | -34 | -10       | -16 | -22 | -28 | -34 |
| Avg 7 day Max. Pave Design Temp (a)   | 76 °C     |     |     |     |     |           |     |     |     |     |
| Minimum Pavement Design Temp, °C  | -10       | -16 | -22 | -28 | -34 | -10       | -16 | -22 | -28 | -34 |
| <b>Original Binder</b>  |           |     |     |     |     |           |     |     |     |     |
| Flash Point Temp, T 48/D 92: Min.   | 230 °C    |     |     |     |     | 230 °C    |     |     |     |     |
| Viscosity, T 316/D 4402: Max. 3 Pa·s, Test Temp (b)   | 135 °C    |     |     |     |     | 135 °C    |     |     |     |     |
| Dynamic Shear, T 315/D 7175:<br>G*/sin $\theta$ , Min. 1.00 kPa Test Temp at 10 rad/s (c, g)  | 76 °C     |     |     |     |     | 82 °C     |     |     |     |     |
| <b>Rolling Thin Film Oven (T 240/D 2872)</b>  |           |     |     |     |     |           |     |     |     |     |
| Mass Loss, Max. Percent   | 1.00      |     |     |     |     |           |     |     |     |     |
| Dynamic Shear, T 315/D 7175:<br>G*/sin $\theta$ , Min. 2.20 kPa Test Temp at 10 rad/s (g)     | 76 °C     |     |     |     |     |           |     |     |     |     |
| <b>Pressure Aging Vessel Residue (R 28/D 6521)</b>  |           |     |     |     |     |           |     |     |     |     |
| PAV Aging Temp, °C (d)  | 100 (110) |     |     |     |     | 100 (110) |     |     |     |     |
| Dynamic Shear, T 315/D 7175: G* $\sin \theta$ , Max. 5000 kPa Test Temp at 10 rad/s, °C (g)   | 37        | 34  | 31  | 28  | 22  | 40        | 37  | 34  | 31  | 28  |
| <b>Physical Hardening (e)</b>   |           |     |     |     |     |           |     |     |     |     |
| Creep Stiffness, T 313/D 6648: S, Max. 300 MPa, m-value, Min. 0.300 Test Temp at 60 s, °C (f) | 0         | -6  | -12 | -18 | -24 | 0         | -6  | -12 | -18 | -24 |
| Direct Tension, T 314/D 6723: Fail. Strain, Min. 1.0% Test Temp at 1.0 mm/min, °C (f)         | 0         | -6  | -12 | -18 | -24 | 0         | -6  | -12 | -18 | -24 |

| <p align="center"><b>Table 904-2<br/>Performance Graded Asphalt Binder Specification (Continued)</b></p>  |
|---|
| <p>a. Pavement temperatures are estimated from air temperatures using an algorithm contained in the Superpave software program, may be provided by the specifying agency, or by following the procedures as outlined in MP2 and PP28.</p> <p>b. This requirement may be waived at the discretion of the specifying agency if the supplier warrants that the asphalt binder can be adequately pumped and mixed at temperatures that meet all applicable safety standards.</p> <p>c. For quality control of unmodified asphalt cement production, measurement of the viscosity of the original asphalt cement may be used or supplement dynamic shear measurements of <math>G^*/\sin \theta</math> at test temperatures where the asphalt is a Newtonian fluid. The Contractor may use a standard means of viscosity measurement, including capillary (T 201/D 2170 or T 202/D 2171) or rotational viscometer (T 316/D 4402).</p> <p>d. The PAV aging temperature is based on simulated climatic conditions and is one of three temperatures 90°C, 100°C or 110°C. The PAV aging temperature is 100°C for PG 58- and above, except in desert climates, where it is 110°C.</p> <p>e. Physical Hardening – T 313/D 6648 is performed on a set of asphalt beams according to Section 13.1, except the conditioning time is extended to 24 h <math>\pm</math>10 min at 10°C above the minimum performance temperature. The 24 h stiffness and m-value are reported for information purposes only.</p> <p>f. If the creep stiffness is below 300 MPa, the direct tension test is not required. If the creep stiffness is from 300 MPa to 600 MPa, the direct tension failure strain requirement can be used in lieu of the creep stiffness requirement. The m-value requirement must be satisfied in both cases.</p> <p>g. <math>G^*/\sin \theta</math> = high temperature stiffness and <math>G^*\sin \theta</math> = intermediate temperature stiffness.</p> |

| <b>Table 904-3<br/>Medium and Rapid Curing Cut-Back Asphalts</b>   |                     |                  |               |                 |
|--|---------------------|------------------|---------------|-----------------|
| <b>Tests</b>   | <b>Requirements</b> |                  |               |                 |
|  | <b>MC-30 (a)</b>    | <b>MC-70 (a)</b> | <b>MC-250</b> | <b>RC-250</b>   |
| Kinematic Viscosity, 60 °C, mm <sup>2</sup> /s, T 201/D 2170   | 30-60               | 70-140           | 250-500       | 250-500         |
| Flash Point, deg °C:   |                     |                  |               |                 |
| Tag Open Cup, min, T 79  | 37.8                | 37.8             | —             | 26.7            |
| Cleveland Open Cup, min, T 48/D 92   | —                   | —                | 65.6          | —               |
| <b>Distillation Test, T 78/D 402</b>   |                     |                  |               |                 |
| Distillate, % by Vol of Total Distillate to 360 °C   |                     |                  |               |                 |
| To 225 °C  | ≤25                 | ≤20              | ≤10 max       | ≥35             |
| To 260 °C  | 40-70               | 20-60            | 15-55         | ≥60             |
| To 315.5 °C  | 75-93               | 65-90            | 60-87         | ≥80             |
| Residue from Distillation to 360 °C, min   | 50                  | 55               | 67            | 65              |
| <b>Tests on Residue from Distillation, T 78/D 402:</b>   |                     |                  |               |                 |
| Penetration at 25 °C, 100 g, 5 sec, T 49/D 5   | 120-250             | 120-250          | 120-250       | 80-120          |
| Ductility at 25 °C, cm, min T 51/D 113 (b)   | 100                 | 100              | 100           | 100             |
| Solubility in Trichloroethylene, %, min, T 44/D 2042   | 99.5                | 99.5             | 99.5          | 99.5            |
| Spot Test, AASHTO T 102 (c)  | Neg.                | Neg.             | Neg.          | Neg.            |
| Section Number Reference   | —                   | <u>914</u>       | —             | <u>710, 914</u> |
| <p>a. Use MC-70 grade from June 1 to September 1 and MC-30 grade other times of the year, unless otherwise directed by the Engineer.</p> <p>b. If penetration of residue exceeds 200 and ductility, at 25 °C, is less than 100, the Engineer will accept the material if ductility at 15.6 °C exceeds 100.</p> <p>c. Use 35% Xylene, 65% Heptane solvent, aniline number: 30 °C ±2 °C.</p> |                     |                  |               |                 |

**Table 904-4**  
**Anionic Emulsified Asphalts**

| Anionic Emulsified Asphalts   | Requirements |                     |         |                     |         |                     |                          |
|---|--------------|---------------------|---------|---------------------|---------|---------------------|--------------------------|
|   | RS-1m        | RS-2a               | HFRS-2  | MS-Op               | MS-2h   | MS-2s               | SS-1h                    |
| Viscosity, Saybolt Furol, T 59-01/D 7496:   |              |                     |         |                     |         |                     |                          |
| At 25 °C, sec   | 20–100       | —                   | —       | —                   | —       | —                   | 20–100                   |
| At 50 °C, sec   | —            | 50–300              | 50–300  | 15–150              | 50–300  | 50–300              | —                        |
| Storage Stability Test, T 59-01/D 6930-04, 24 hr, % Difference max  | 2            | 2                   | 2       | 3                   | 3       | 3                   | 2                        |
| Demulsibility, T 59-01/D 6936-04:   |              |                     |         |                     |         |                     |                          |
| 35 ml 0.02 N CaCl <sub>2</sub> , %  | 20–60        | ≥60                 | ≥40     | —                   | —       | —                   | —                        |
| 50 ml 0.1 N CaCl <sub>2</sub> , %   | —            | —                   | —       | —                   | —       | —                   | ≤2                       |
| 50 ml 0.02 N CaCl <sub>2</sub> , %  | —            | —                   | —       | —                   | —       | —                   | —                        |
| Sieve Test, T 59-01 / D 6933-04, % max  | 0.10         | 0.10                | 0.10    | 0.10                | 0.10    | 0.10                | 0.10                     |
| Miscibility with Water, D 244 (a)   | —            | —                   | —       | —                   | —       | —                   | Yes                      |
| Distillation to 260 °C, T 59-01/D 6997-04, % by Weight:   | —            | —                   | —       | —                   | —       | —                   | —                        |
| Residue, Min  | 65           | 65                  | 65      | 65                  | 65      | 65                  | 60                       |
| Oil Distillate, max   | 2            | 2                   | 2       | 25                  | 7       | 7                   | 2                        |
| <b>Tests on Distillation Residue:</b>   |              |                     |         |                     |         |                     |                          |
| Penetration, 25 °C, 100 g, 5 sec, dmm, T 49/D 5   | 100–200      | 100–200             | 100–200 | (b)                 | 150–300 | ≥300                | 40–90                    |
| Float Test, sec, T 50/D 139:  |              |                     |         |                     |         |                     |                          |
| At 50 °C, max   | —            | —                   | —       | 200                 | —       | —                   | —                        |
| At 60 °C, min   | —            | —                   | 1,200   | —                   | 1,200   | 1,200               | —                        |
| Ductility, 25 %C, cm, min, T 51/D 113   | 60           | 60                  | 60      | 40 (b)              | —       | —                   | 40                       |
| Solubility in Trichloroethylene, % min, T 44/D 2042   | 97.5         | 97.5                | 97.5    | 97.5                | 97.5    | 97.5                | 97.5                     |
| Ash Content, % max, D 128   | 2            | 2                   | 2       | 2                   | 2       | 2                   | 2                        |
| Specific Gravity, 25/25 °C, min., T 228/D 70  | 0.996        | 0.996               | 0.996   | —                   | —       | —                   | —                        |
| Toughness/Tenacity, 25 °C, 50 cm/min., Nm, min., D 5801   | —            | —                   | —       | —                   | —       | —                   | —                        |
| Elastic Recovery, 10 °C, % min., T 301/D 6084   | —            | —                   | —       | —                   | —       | —                   | —                        |
| Section Number Reference  | —            | <a href="#">401</a> | —       | <a href="#">501</a> | —       | <a href="#">501</a> | <a href="#">501, 805</a> |
| a. No appreciable coagulation or visible separation in 2 hours.   |              |                     |         |                     |         |                     |                          |
| b. Heat the distillation residue (ASTM D 243) to 100±15 penetration within 2 hours, and have a ductility of at least 40 cm. |              |                     |         |                     |         |                     |                          |

| <b>Table 904-5<br/>Cationic Emulsified Asphalts</b>  |                     |              |                     |                          |
|--|---------------------|--------------|---------------------|--------------------------|
| <b>Cationic Emulsified Asphalts</b>  | <b>Requirements</b> |              |                     |                          |
|  | <b>CRS-1</b>        | <b>CRS-2</b> | <b>CMS-2</b>        | <b>CSS-1h</b>            |
| <b>Viscosity, Saybolt Furol, T 59-01/D 7496:</b>   |                     |              |                     |                          |
| At 25 °C, sec  | —                   | —            | —                   | 20–100                   |
| At 50 °C, sec  | 20–100              | 100–400      | 50–450              | —                        |
| <b>Storage Stability Tests,<br/>T 59-01/D 6930-04, 24 hr, %<br/>Difference, max</b>                    | 1                   | 1            | 1                   | 1                        |
| <b>Demulsibility, %, 35 ml 0.8% Dioctyl<br/>Sodium Sulfosuccinate, min, T 59-01/D<br/>6936-04, (a)</b> | 40                  | 40           | —                   | —                        |
| <b>Particle Charge Tests, T 59-01/D 7402 (b)</b>   | Positive            | Positive     | Positive            | Positive                 |
| <b>Sieve Tests, T 59-01/D 6933-04, % max<br/>(Distilled Water)</b>                                     | 0.10                | 0.10         | 0.10                | 0.10                     |
| <b>Distillation to 260 °C, T 59-01/D 6997-04,<br/>% by Weight (c)</b>                                  | —                   | —            | —                   | —                        |
| Residue, min   | 60                  | 65           | 65                  | 60                       |
| Oil Distillate, max  | 3                   | 3            | 12                  | —                        |
| <b>Tests on Distillation Residue:</b>  |                     |              |                     |                          |
| Penetration, 25 °C, 100 g, 5 sec, dmm,<br>T 49/D 5   | 100–250             | 100–250      | 100–250             | 40–90                    |
| Ductility, 25 °C, 5 cm/min, cm, min,<br>T 51/D 113   | 40                  | 40           | 40                  | 40                       |
| Ductility, 4 °C, 5 cm/min, cm,<br>T 51/D 113   | —                   | —            | —                   | —                        |
| Elastic/Recovery, 4 °C, % min,<br>T 301/D 6084   | —                   | —            | —                   | —                        |
| Solubility in Trichloroethylene, % min,<br>T 44/D 2042   | 97.5                | 97.5         | 97.5                | 97.5                     |
| Ash Content, % max, D 128  | 2                   | 2            | 2                   | 2                        |
| Specific Gravity, 25/25 °C, min,<br>T 228/D 70   | 0.996               | 0.996        | —                   | —                        |
| Toughness/Tenacity, 25 °C, 50<br>cm/min., Nm, min., D 5801   | —                   | —            | —                   | —                        |
| Elastic Recovery, 10 °C, % min.,<br>T 301/D 6084   | —                   | —            | —                   | —                        |
| Cement Mixing Test, T 59-01/D 6935-04,<br>% max  | —                   | —            | —                   | 2.0                      |
| <b>Coating Ability and Water Resistance:</b>   |                     |              |                     |                          |
| Coating Dry Aggregate  | —                   | —            | Good                | —                        |
| Coating After Spraying   | —                   | —            | Good                | —                        |
| Coating Wet Aggregate  | —                   | —            | Fair                | —                        |
| Coating After Spraying   | —                   | —            | Fair                | —                        |
| Section Number Reference   | —                   | —            | <a href="#">501</a> | <a href="#">501, 805</a> |
| a. The Demulsibility Test must be made within 30 days from date of shipment.                           |                     |              |                     |                          |
| b. If Particle Charge Test is inconclusive, material having a maximum pH of 6.7 is acceptable.         |                     |              |                     |                          |

| Table 904-6<br>Capital Preventative Maintenance (CPM) Emulsions (h)  |              |          |          |          |        |          |
|--|--------------|----------|----------|----------|--------|----------|
|  | Requirements |          |          |          |        |          |
|  | HFRS-2M      | CRS-2M   | CSS-1mM  | CSS-1hM  | PPSS   | CSEA     |
| Viscosity, Saybolt Furol, T 59-01/D 7496:  |              |          |          |          |        |          |
| At 25 °C, sec  | —            | —        | 20–100   | 20–100   | 20–100 | —        |
| At 50 °C, sec  | 75–300       | 75–300   | —        | —        | —      | 75–400   |
| Storage Stability Test, T 59-01/D 6930-04, 24 hr, % Difference max   | 1            | 1        | 1        | 1        | 1 (g)  | 1        |
| Demulsibility, T 59-01/D 6936-04:  |              |          |          |          |        |          |
| 35 ml 0.8% Dioctyl Sodium Sulfosuccinate, % min (a)  | —            | 50       | —        | —        | 60     | 50       |
| 35 ml 0.02 N CaCl <sub>2</sub> , %, min.   | —            | —        | —        | —        | 60     | —        |
| 50 ml 0.1 N CaCl <sub>2</sub> , %  | —            | —        | —        | —        | —      | —        |
| 50 ml 0.02 N CaCl <sub>2</sub> , %   | ≥50          | —        | —        | —        | —      | —        |
| Particle Charge Tests, T 59-01/D 7402 (b)  |              | Positive | Positive | Positive | —      | Positive |
| Sieve Test, T 59-01 / D 6933-04, % max   | 0.10         | 0.10     | 0.10     | 0.10     | 0.05   | 0.10     |
| Miscibility with Water, D 244 (f)  | —            | —        | —        | —        | —      | —        |
| Distillation to 260°C, T 59-01/D 6997-04, % by Weight:   | (e)          | (e)(j)   | (e)      | (e)      | (e)    | (i)      |
| Residue, Min   | 65           | 65       | 62       | 62       | 63     | 68       |
| Oil Distillate, ml, max, D 244   | 2            | 3        | —        | —        | 2      | 3.0      |
| <b>Tests on Distillation Residue:</b>  |              |          |          |          |        |          |
| Penetration, 25 °C, 100 g, 5 sec, dmm, T 49/D 5  | 80–150       | 80–150   | 70–90    | 40–90    | 80–150 | 70–100   |
| Ductility, 25 °C, 5 cm/min, cm, T 51/D 113   | —            | —        | 40       | 40       | —      | 40       |
| Ductility, 4 °C, 5 cm/min, cm, T 51/D 113  | —            | —        | 35       | —        | —      | —        |
| Elastic/Recovery, 4 °C, % min., T 301/D 6084   | —            | —        | 65       | —        | —      | —        |
| Float Test, sec, T 50/D 139:   |              |          |          |          |        |          |
| At 50 °C, max  | —            | —        | —        | —        | —      | —        |
| At 60 °C, min  | 1,200        | —        | —        | —        | —      | —        |
| Solubility in Trichloroethylene, % min., T 44/D 2042   | —            | —        | 97.5     | 97.5     | —      | 97.5     |
| Ash Content, %, max, D 128   | 2            | 2        | 2        | 2        | —      | 2        |
| Specific Gravity, 25/25 °C, min., T 228/D 70   | —            | —        | —        | —        | —      | —        |
| Toughness/Tenacity, 25 °C, 50 cm/min., Nm, min., D 5801  | 4.5/3.5      | 4.5/3.5  | —        | —        | —      | 9.0/7.0  |
| Elastic Recovery, 10 °C, % min., T 301/D 6084  | 60%          | 60%      | —        | —        | 60     | 75       |
| <b>Tests on Residue from Evaporation, T 59-01/D 6934-04: (c)</b>   |              |          |          |          |        |          |
| Softening Point, Ring & Ball, °C, min., T 53/D 36  | —            | —        | 60       | 57.2     | —      | —        |
| Viscosity, 60C, Pa·S, T 202/D 2171   | —            | —        | 800 (d)  | 800 (d)  | —      | —        |
| Section Number Reference   | 505          | 505      | 507      | 507      | —      | —        |
| <p>a. The Demulsibility Test must be made within 30 days from date of shipment.</p> <p>b. If Particle Charge Test is inconclusive, material having a maximum pH of 6.7 is acceptable.</p> <p>c. Residue by evaporation: Oven evaporate an emulsion sample on a glass plate at a maximum temperature of 60 °C for 24 hours (forced draft oven recommended) or air dry the sample at ambient temperature for three days. Once dry, the sample is scraped from the plate using a razor blade tool.</p> <p>d. The minimum Viscosity will be obtained using a Cannon-Manning Vacuum Capillary Viscometer Tube No. 14 per T 202 / D 2171.</p> <p>e. ASTM D 6997, with modifications to include a 204 °C (± 6 °C) maximum temperature to be held for 15 minutes.</p> <p>f. No appreciable coagulation or visible separation in 2 hours.</p> <p>g. After standing undisturbed for 24 hours, the surface must show no white, milky colored substance, but must be a smooth homogenous color throughout. Any visible amount of white, milky colored substance is basis for non-acceptance.</p> <p>h. Samples of emulsified asphalt will be taken in accordance with ASTM D 140. Samples must be stored at a temperature of not less than 4 °C until tested.</p> <p>i. Residue determination and preparation may use the alternate ASTM D 6934 method, "Residue by Evaporation" so as to not destroy the properties of any polymer modifiers contained therein.</p> |              |          |          |          |        |          |



| <b>Table 904-7<br/>Temperatures for Asphaltic Materials</b>   |  |  |
|---|--|--|
| <b>Asphalt Type</b>   | <b>Designation</b>   | <b>Temperature, °F<br/>Distributor</b> |
| Cut-Back<br>Asphalts  | RC-250   | 145–220                                |
|   | MC-250   | 145–220                                |
|   | MC-30  | 70–140                                 |
|   | MC-70  | 105–180                                |
| Emulsified  | RS-1m, SS-1h, CSSmM,<br>CRS-1, CSS-1h, CSS-1hM,                  | 85–135                                 |
| Asphalts  | RS-2a, HFRS-2, HFRS-2M,<br>MS-2h, MS-2s, CRS-2,<br>CMS-2, CRS-2M | 125–175                                |
| Asphalt Binder  | All Grades   | 350 Maximum Mixing<br>Temp (a)         |
| a. Mixing temperature for all asphalt binders will be as specified by the modifier/binder producer. |  |  |

## Section 905. STEEL REINFORCEMENT

**905.01. General Requirements.** Steel reinforcement for use in concrete structures and pavements must meet the requirements of this section [905](#) and subsection [105.01](#).

**905.02. Testing.** Steel reinforcement materials testing will be in accordance with ASTM A 370, ASTM E 8 or other specified ASTM, AASHTO or Department methods, as modified by this section.

If requested, provide the Engineer with two copies of the chemical analysis of reinforcing bars, in accordance with the relevant ASTM specifications.

**905.03. Bar Reinforcement for Structures.** Deformed bars, must meet the requirements of ASTM A 706 or of ASTM A 615, ASTM A 616, ASTM-96a, or ASTM A 617-96a for Grade 60 steel bars, unless otherwise required.

Unless otherwise specified, spiral reinforcement must meet the requirements for plain or deformed Grade 40 steel bars of ASTM A 615, ASTM A 617-96a, or the requirements for cold-drawn wire of ASTM A 82.

Bar reinforcement for prestressed concrete beams must meet the requirements of ASTM A 616-96a for Grade 60 steel bars, except the Engineer will allow bar reinforcement that meets the requirements of ASTM A 615 or ASTM A 617-96a for Grade 40 steel bars for stirrups in prestressed concrete beams.

A. **Bending.** Bent bar reinforcement must be cold shop bent to the shapes shown on the plans. Complete all field bending cold as specified. Heat bending is cause for rejection.

The diameter of a bar bend, measured on the inside of the bar, must meet the requirements of Table 905-1.

| ASTM Bar Designation No.         | Minimum Inside Diameter of Bend |
|----------------------------------|---------------------------------|
| No. 3 – No. 8                    | 6 bar diameters                 |
| No. 9 – No. 11                   | 8 bar diameters                 |
| No. 14, No. 18                   | 10 bar diameters                |
| Stirrups and Ties, No. 3 – No. 5 | 4 bar diameters                 |

Bar cutting and bending must be in accordance with the CRSI Code of Standard Practice and the ACI Detailing Manual.

**B. Bundling and Tagging.** Ship bar reinforcement in standard bundles, tagged and marked in accordance with the CRSI Code of Standard Practice.

**C. Epoxy Coating.** Epoxy coated steel reinforcement, if required, must be coated in accordance with AASHTO M 284, with the following exceptions and additions:

1. Select coating material from the Qualified Products List.
2. The Department may test samples at the coating applicator's plant or at the laboratory to determine thickness of coating, adhesion of coating, and holidays. Coat more bars than shown on the plans to allow splicing to replace bars removed for test samples.
3. Include written certification that the coated reinforcing bars were cleaned, coated, and tested in accordance with AASHTO M 284 with the coating applicator.
4. Coat bars before or after bending. Repair damage to the coating in accordance with subsection [706.03.E.8](#).

**D. Bar Chairs and Wire Ties for Epoxy Coated Steel Reinforcement.** The bar chairs and wire ties required for placing and fastening steel reinforcement must conform to the following:

1. Bar chairs must be plastic coated wire, epoxy coated wire, or plastic.
2. Wire ties must be plastic coated wire, epoxy coated wire, or molded plastic clips.
3. Tie-down wires must be plastic coated.

**905.04. Bar Reinforcement for Pavements.** Bar reinforcement for pavement tie bars and bars for use as dowels for load transfer in pavement expansion joints and contraction joints must meet the requirements of section [914](#).

**905.05. Dowels and Bar Reinforcement for Curb, Glare Screen, Concrete Barriers, and Filler Walls.** Deformed steel bars must meet the requirements of ASTM A 706 or the requirements for Grade 40, Grade 50, or Grade 60 of ASTM A 615, ASTM A 616-96a, or ASTM A 617-96a.

**905.06. Steel Welded Wire Fabric.** Deformed wire fabric for prestressed concrete must meet the requirements of ASTM A 497.

Fabric for concrete pavement reinforcement must meet the requirements of ASTM A 185 and fabricated as required.

**905.07. Strand for Prestressed Concrete.** Strands for prestressed concrete must have a 0.500 inch nominal diameter and a 0.153 square inch cross-sectional area or a 0.6000 inch nominal diameter and a

0.217 square inch cross-sectional area and must meet the requirements of ASTM A 416, for Grade 270, Low Relaxation Strand, as required.

Identify each reel or pack number and provide a Test Data Certification, including a load-elongation curve to at least 1 percent elongation.

Protect prestress strands from physical damage, rust, and contaminants.

**905.08. Tendons for Lateral Post Tensioning of Box Beams.**

Tendons for lateral post tensioning of box beams must meet the requirements of ASTM A 416, for Grade 270 steel strand or ASTM A 722, for high-strength steel bars.

If selecting bars, consider the tolerances allowed in manufacturing and placing precast concrete box beams and determine the required bar lengths accordingly.

## Section 906. STRUCTURAL STEEL

**906.01. General Requirements.** Finished rolled shapes must be free from imperfections that affect strength and durability in accordance with ASTM A 6. Rolled shapes must have a smooth, uniform finish. Straighten rolled shapes in the mill, if necessary, before shipment. Comply with subsection [105.01](#) and subsection [105.10](#).

**906.02. Testing.** Structural steel materials testing will be in accordance with the specified ASTM, AASHTO or Department methods, as modified by this section.

Mechanical testing of structural steel products will be in accordance with ASTM A 6 and AASHTO T 244.

**906.03. Mill Inspection.** The Engineer will waive mill inspection, unless otherwise specified. If required, the Department will conduct mill inspection in accordance with Division 1, subsection [707.02](#), and subsection [906.01](#). Notify the Department before beginning rolling to ensure time for inspection. Provide mill test reports in accordance with subsection [707.02](#).

**906.04. Structural Steel.** Steel for use in highway structures must meet the requirements of the contract and this section.

Where impact tests are required, the producer must conduct and report the impact tests for heat qualification according to the sampling and testing procedures of AASHTO T 243. Use the (H) frequency, Heat Testing for Plates, Shapes, and Bars of AASHTO T 243 unless otherwise specified.

The Department considers the average flange thickness to be the governing thickness for beams, tees, and channels. The Department considers the required leg thickness to be the governing thickness for angles. Take test specimens for these sections at one-third the distance from the outer edge of the flange or leg to the web or heel of the section.

The Department may reject any structural steel covered by these requirements, which by subsequent impact testing, conducted at the option of the Department, fails to produce the required impact strength.

**A. AASHTO M 270 Grade 36 Structural Steel.** Primary member material must meet the longitudinal Charpy V-Notch impact test requirement of 15 foot-pounds at a test temperature of 40 °F. Lower the testing temperature for critical load carrying members by 30 °F, as required.

**B. High-Strength Structural Steel.** High-strength structural steel must meet the requirements of AASHTO M 270, for Grade 50, Grade 50W Type A, Type B, or Type C, Grade 50S, Grade HPS 50W, and Grade HPS 70W.

Primary member material must meet the longitudinal Charpy V-Notch impact requirements of 15 foot-pounds for 2-inch thick steel and mechanically fastened steel, or 20 foot-pounds for steel thicker than 2 inches, at the following yield points and corresponding testing temperatures:

1. No greater than 65 ksi at 40 °F,
2. From 65 ksi to 75 ksi at 25 °F,
3. From 75 ksi to 85 ksi at 10 °F, and
4. Greater than 85 ksi at -5 °F.

Lower the testing temperature for critical load carrying members by 30 °F, as required.

**906.05. Foundation Piles.** Ensure the manufacturer of the piling steel provides the Department with a certified mill test report showing the physical properties of the steel.

Foundation piles must meet the following requirements for the type of pile required. If the Engineer determines pile cutoffs are in good condition, the Engineer will accept pile cutoffs that meet size and thickness requirements without mill test reports. If submitting pile cutoffs without mill test reports, provide the Engineer with two copies of an affidavit stating that the material provided meets the contract requirements.

**A. Steel H-Piling and Special Sections.** Steel H-piling and special sections must meet the requirements of AASHTO M 270 Grade 36, Grade 50, or Grade 50W.

**B. Steel Shells for Cast-in-Place Concrete Piles.** Steel shells for cast-in-place concrete piles must have the nominal outside diameters and minimum shell metal thicknesses shown on the plans. Cylindrical pipe shells must meet the requirements of ASTM A 252 Grade 2 welded and seamless steel pipe piles.

**C. Pile Points.** Pile points must conform to the dimensions shown on the plans. Provide certification that the steel used for the fabrication of the points meets one of the following:

1. AASHTO M 270 Grade 36, Grade 50, or Grade 50W;
2. SAE Grade 1016 through Grade 1027; or
3. SAE Grade 1030.

**906.06. Sheet Piles.** For permanent sheet piling, ensure the piling steel manufacturer provides the Department with a certified mill test report that shows the physical properties of the steel.

Sheet piles must meet the following requirements for the type of pile required. If the Engineer determines pile cutoffs are in good condition, the Engineer will accept pile cutoffs that meet the size and thickness requirements without mill test reports. If submitting pile cutoffs without mill test reports, provide the Engineer with two copies of an affidavit stating that the material provided meets the contract requirements.

**A. Temporary Steel Sheet Piling.** Temporary steel sheet piling must meet the requirements of AASHTO M 202 or AASHTO M 270 Grade 36, Grade 50, or Grade 50W.

**B. Permanent Steel Sheet Piling.** Permanent steel sheet piling must meet the requirements of AASHTO M 270 Grade 50.

**906.07. High-Strength Steel Bolts, Nuts, and Washers for Structural Joints.** High-strength bolt fasteners for structural joints must meet the requirements of AASHTO M 164 Type 1 bolts. High-strength nuts for structural joints must meet the requirements of AASHTO M 291 Grade DH or AASHTO M 292 Grade 2H. High-strength washers for structural joints must meet the requirements of AASHTO M 293 Type 1 for circular, beveled, clipped circular, and clipped beveled washers.

Bolts, nuts, and washers must be hot dip galvanized in accordance with AASHTO M 232. Galvanized nuts must be tapped oversize in accordance with AASHTO M 291 and meet Supplementary Requirements S1, Lubricant and Rotational Capacity Test for Coated Nuts and S2, Lubricant Dye.

**906.08. Pins and Link Plates for Steel Bridge Construction.** Link plates for steel bridge construction must meet the requirements of AASHTO M 270 Grade 50 or Grade 50W, and pins must meet the requirements of ASTM A 276 UNS designation S21800 or S20161 annealed stainless steel with 50 ksi yield point. Washers and pins must be made from the same material.

The Longitudinal Charpy V-Notch impact values for pin and link plate materials in redundant structures must meet the requirements for high strength structural steel in subsection [906.04](#). Use the steel yield point stress value shown in the certified mill test report to determine the testing temperature. The steel may require heat treatment to meet the Charpy V-Notch impact requirements.

Perform notch toughness tests on specimens in accordance with Frequency (P) Piece Testing of AASHTO T 243.

The longitudinal Charpy V-Notch impact values for pin and link plate materials in non-redundant structures must average 30 foot-pounds when tested at the Lowest Anticipated Service Temperature (LAST) specified for the MDOT Region location of the structure in accordance with Table 906-1.

| <b>Region</b>                    | <b>LAST</b> |
|----------------------------------|-------------|
| Superior                         | -25 °F      |
| North                            | -20 °F      |
| Grand and Bay                    | -15 °F      |
| Southwest, University, and Metro | -10 °F      |

**906.09. Shear Developers.** Select shear connector studs from the Qualified Products List. Shear connector studs must be designed for end-welding to steel beams and girders with automatically timed stud welding equipment. Provide shear developers as shown on the plans.

Provide an arc shield (ferrule) with each stud. The arc shield must be made of a heat-resistant ceramic or material that will not adversely affect the welds, cause excessive slag, or crumble or break from thermal or structural shock during welding.

Furnish flux for welding with each stud, either attached to the end of the stud or combined with the arc shield for automatic application in the welding operation.

Shear connector studs must meet the requirements of AASHTO M 169, for cold-finished carbon steel, cold-drawn bar, Grade 1015 or Grade 1020, either semi-killed or fully-killed. If using flux-retaining caps, provide cold-rolled steel caps of a low carbon grade for welding, that meet the requirements of ASTM A 109.

Tensile properties, as determined by tests of bar stock after drawing or of finished studs, must conform to the minimum requirements shown in Table 906-2.

| <b>Property</b>   | <b>Specification (minimum)</b> |
|-------------------|--------------------------------|
| Tensile strength  | 60 ksi                         |
| Yield strength    | 50 ksi                         |
| Elongation        | 20% in 2 inches                |
| Reduction of area | 50%                            |



906.09

Determine tensile properties in accordance with AASHTO T 244 for mechanical testing of steel products. Use the 0.2 percent offset method to determine the yield strength.

Finished studs must be uniform in quality and condition, free from injurious laps, fins, seams, cracks, twists, bends, or other defects. Use cold drawing, cold rolling, or machining to finish.

## Section 907. FENCING MATERIALS

**907.01. General Requirements.** Materials for fencing property, right-of-way, and other installations, must meet the requirements of this section.

**907.02. Testing.** Fencing materials testing will be in accordance with the specified ASTM, AASHTO or Department methods, as modified by this section.

The weights of fencing material include the weight of coating, unless otherwise specified.

Zinc coating at 1 ounce per square foot corresponds to a coating thickness of 1.7 mils.

### **907.03. Woven Wire Fence.**

**A. Fabric.** Steel woven wire fabric must be zinc coated or aluminum coated.

1. **Zinc Coated.** Zinc coated fabric must meet the requirements of ASTM A 116, Design No. 1047-6-11, for Grade 60, Class 1 zinc coating.

2. **Aluminum Coated.** Aluminum coated fabric must meet the requirements of ASTM A 584, Design No. 1047-6-11.

**B. Barbed Wire.** Standard grade zinc coated or aluminum coated steel barbed wire must be composed of two strands of wire with four-point round barbs. Provide chain link fence grade barbed wire for use with chain link fence.

1. **Zinc Coated.** Zinc coated barbed wire must meet the requirements of ASTM A 121 and the following:

- a. If the direction of the strand wire twist alternates between left and right, the strand wires must not untwist under a tensile force of 950 pounds for 12½ gauge wire, 850 pounds for 13½ gauge wire, or 750 pounds for 15½ gauge wire; and
- b. Class 1 zinc coating is required for 12½ gauge steel wire, and Class 3 zinc coating is required for 13½ gauge wire and 15½ gauge wire.

2. **Aluminum Coated.** Aluminum coated barbed wire must meet the requirements of ASTM A 585, for Type I aluminum coated steel barbed wire with aluminum coated barbs.

C. **Smooth Line Wire.** Smooth line wire must be No. 9 gauge coated steel wire meeting the requirements of ASTM A 116, for Grade 60, Class 1 zinc-coated smooth line wire or ASTM A 584, for aluminum-coated smooth line wire.

D. **Steel Posts.** After fabrication, galvanize steel fence posts, braces, and fittings in accordance with ASTM A 123 and this subsection.

The weight of zinc coating per square foot of surface on posts and braces must average at least 2.00 ounces and no individual specimen may have less than 1.80 ounces of zinc coating per square foot, regardless of metal thickness. The Department will include the weight of zinc coating in the weights specified for posts and braces, but will deduct the weight of galvanizing greater than 4.00 ounces per square foot of surface from the post weight.

The Department will allow an alternate zinc and clear coat system for pipe sections. The exterior surface of the pipe section must have 0.90 ounce per square foot of zinc coating and a clear acrylic coating at least 0.30 mil thick. The interior surface of the pipe section must have 0.35 ounce per square foot of zinc coating or 0.30 mil zinc-rich organic coating and a zinc powder loading of at least 91 percent by weight.

Zinc coating must be applied in accordance with ASTM A 123. Determine coating weights and thicknesses in accordance with AASHTO M 181.

1. **Line Posts.** Steel for line posts must meet the requirements of ASTM A 702, for Type A or Type B. Line posts must be 7 feet long,  $\pm 1$  inch, with a nominal weight of 1.12 pounds per foot. Exclusive of the anchor plate, individual line posts must weigh 1.08 pounds per foot. Posts must be notched, studded, or have other Department-approved means of holding the fabric in place on the post. Provide each post with a Department-approved anchor plate and at least seven 11 gauge galvanized or aluminum coated wire clamps.
2. **End, Corner, Gate, Intersection, and Intermediate Braced Posts.** Steel angle sections, steel pipe, or steel tubing end, corner, gate, intersection, and intermediate braced posts must have an average weight within 10 percent of the specified weight per foot. Angle sections for posts and braces must meet the physical requirements of ASTM A 36 or ASTM A 702, for Type A or Type B.

Provide the required fittings and braces with each post.

- a. **Posts.** End, corner, gate, intersection, and intermediate braced posts must be 8 feet long,  $\pm 1$  inch.

Angle sections must be nominal 2½ inch by 2½ inch by ½ inch. Pipe or tubing must be nominal 2-inch, (2.375 inch OD), weighing 3.650 pounds per foot.

- b. **Braces.** Angle section braces must be nominal 1¼ inch by 1¼ inch by ¼ inch (2 inch by 2 inch by ¾ inch). Steel pipe braces must be nominal 1½ inch, (1.900 inch OD), weighing 2.72 pounds per foot. Steel tubing braces must be nominal 1.750 inch OD weighing 3.13 pounds per foot.

Braces must be long enough to support the posts. Provide at least one brace with each end post or gate posts. Provide at least two braces with each corner post and each intermediate braced post. Provide at least three braces with each intersection post.

E. **Wood Posts.** Wood posts must meet the requirements of subsection [912.08](#).

F. **Gates.** Provide gates for woven wire fence of the width and height shown on the plans. Provide each gate with Department-approved hinges, latches and auxiliary braces to prevent sagging. Weld or fit to form a rigid and watertight frame. Use woven wire in accordance with subsection [907.03.A](#) to fill gate frames.

#### **907.04. Steel Chain Link Fence.**

A. **Fabric.** Chain link fence fabric must be zinc coated steel fabric meeting the requirements of ASTM A 392, for Class 2 coating, aluminum coated steel fabric meeting the requirements of ASTM A 491, or polymer coated steel fabric meeting the requirements of ASTM F 668, as modified by this subsection.

Galvanize zinc coated fabric after weaving.

Polymer coated steel chain link fence fabric must meet ASTM F 668, Class 2a except that the steel core wire may be either hot-dipped zinc coated (galvanized) or aluminum coated (aluminized) prior to polymer coating. Both the metallic coating and the polymer coating must be applied before weaving. The minimum weight of metallic coating must conform to ASTM F 668, Class 2a for zinc galvanized, or ASTM A 817 for aluminum. Provide fabric height and polymer coating color as shown on the plans.

Provide steel chain link fence fabric with the following characteristics:

1. Mesh size of 2.0 inches, or as shown on the plans;

2. Wire size of 9 gauge zinc coated, 9 gauge aluminum coated, or 10 gauge aluminum coated; and
3. Top and bottom selvages knuckled.

**B. Tension Wire.** Tension wire must meet the steel wire requirements of ASTM A 824 for Type I aluminum coating and Type II, Class 3, zinc coating.

As an alternative for tension wire coatings, the Contractor may use hot-dipped Type I aluminized or hot-dipped Type II, Class 1 galvanized, followed by a polymer coating. The polymer coating must meet the requirements for polymer coated steel chain link fence fabric and match the color of the polymer coated steel chain link fence fabric.

**C. Posts for Fence and Gates.** Fence posts and gate posts for chain link fence must be metallic coated steel meeting the requirements of Table 907-1 and Table 907-2.

| <b>Table 907-1<br/>Posts and Rail for Steel Chain Link Fence</b> |                    |   |                        |                              |        |
|--|--------------------|---|------------------------|------------------------------|--------|
| Use  | Fabric Height (in) | Diameter (a) (in)                               | Nominal Weight (lb/ft) | ASTM Steel Specification (b) |        |
| End, Corner, Angle, and Intermediate Braced Posts (c)            | ≤120               | 2½ (2.875)                                      | 5.80                   | F 1083                       |        |
|  |                    | 2½ (2.875)                                      | 4.64                   | F 1043                       |        |
|  |                    | 3½ by 3½ RF Corner (d)                          | 5.10                   | F 1043                       |        |
| Line Posts   | ≤120               | 2 (2.375)                                       | 3.65                   | F 1083                       |        |
|  |                    | 2 (2.375)                                       | 3.12                   | F 1043                       |        |
|  |                    | 1⅞ by 1⅞ H-Section                              | 2.72                   | F 1043                       |        |
|  |                    | 2¼ by 14 <sup>5</sup> / <sub>64</sub> H-Section | 3.26                   | F 1043                       |        |
|  |                    | 2¼ by 1⅞ C-Section (c)                          | 2.70                   | F 1043                       |        |
|  | ≤72                | 2 (2.375)                                       | 2.31                   | F 1043                       |        |
|  |                    | 1⅞ by 1⅞ C-Section (c)                          | 2.26                   | F 1043                       |        |
|  | ≤60                | 1½ (1.900)                                      |                        | 2.72                         | F 1083 |
|  |                    |   |                        | 2.28                         | F1043  |
| Horizontal Rail  | —                  | 1¼ (1.660)                                      | 2.27                   | F 1083                       |        |
|  |                    | 1¼ (1.660)                                      | 1.84                   | F 1043                       |        |

a. Outside pipe diameter with nominal diameter given first; actual diameter in brackets.

b. ASTM F 1083 references are for standard weight (Schedule 40) pipe.

c. Posts for fencing on structures must be 2 in (2.875) nominal outside pipe diameter and must meet the requirements of either ASTM F 1083 (Schedule 40) or ASTM F 1043 (Group 1C) or as called for on the plans.

d. RF: Roll-Formed Sections.

| Table 907-2<br>Pipe for Gate Posts and Frames                         |   |                   |                        |                              |
|---|---|-------------------|------------------------|------------------------------|
| Use   | Gate Width (ft)   | Diameter (a) (in) | Nominal Weight (lb/ft) | ASTM Steel Specification (b) |
| Gate Posts  | ≤6  | 2½ (2.875)        | 5.80                   | F 1083                       |
|   |   | 2½ (2.875)        | 4.64                   | F 1043                       |
|   | 7 – 13  | 3½ (4.000)        | 9.11                   | F 1083                       |
|   |   | 3½ (4.000)        | 7.65                   | F 1043                       |
|   | 14 – 18   | 6 (6.625)         | 18.97                  | F 1083                       |
| Gate Frames   | ≤6  | 1¼ (1.660)        | 2.27                   | F 1083                       |
|   |   | 1¼ (1.660)        | 1.40                   | F 1043                       |
|   | 7 – 18  | 1½ (1.900)        | 2.72                   | F 1083                       |
|   |   | 1½ (1.900)        | 2.28                   | F 1043                       |
|   | a. Outside pipe diameter with nominal diameter given first; actual diameter in parenthesis. |                   |                        |                              |
| b. ASTM F 1083 references are for standard weight (Schedule 40) pipe. |   |                   |                        |                              |

The average weight per foot of metallic coated fence posts must be within ±10 percent of the required weight per foot. Posts must be at least 32 inches longer than the height of the fence fabric.

Steel posts for chain link fence must be coated with zinc or aluminum inside and outside, or polymer-coated posts in accordance with one of the following methods.

- Zinc Coating.** Apply zinc coating meeting the requirements of ASTM A 123 or ASTM A 653. Use the alternate zinc and clear coat system described in subsection [907.03.D](#) for pipe sections only.

The weight of zinc coating on pipe sections must average at least 1.80 ounces per square foot of surface and at least 1.60 ounces per square foot of surface per specimen when tested in accordance with ASTM A 90.

For posts, other than pipe sections, the weight of zinc coating on each post must average at least 2.00 ounces per square foot of surface and at least 1.80 ounces per square foot of surface per specimen when tested in accordance with ASTM A 90.

- Aluminum Coating.** Use Type 2 aluminum to coat posts. The weight of aluminum coating on each post must average at least 0.75 ounces per square foot of surface and at least 0.70 ounces per square foot of surface per specimen when tested in accordance with ASTM A 428.
- Polymer Coating.** After metallic coating, coat exterior surfaces with extruded and adhered polymer coating. Match the color of the post

to the color of the polymer coated steel chain link fence fabric coating.

**D. Gates.** Provide gates for chain link fence as shown on the plans. Provide metallic-coated steel pipe gate frames in accordance with Table [907-2](#). The average weight per foot of the pipe for the gate frames must be within  $\pm 10$  percent of the required weight per foot. Use the same type and weight of coating required for posts.

Weld or fasten joints to form a rigid and watertight frame. Wire brush welded joints and paint with two coats of a Department-approved zinc-rich paint.

Provide gates with intermediate braces, and truss rods to prevent sagging, and provide Department-approved hinges, latches, keepers, and stops. Fill the gate frames with fabric meeting the same requirements as for the fence fabric.

Provide polymer coated gate frames the same as for metallic-coated gate frames, in accordance with Table [907-2](#). Apply polymer coating to gate frames, including hinges, latches, keepers, and stops. Match the color of the polymer coated gate frame to the color of polymer coated steel chain link fence fabric.

**E. Fence Fittings and Hardware.** Provide post caps, rail, or brace ends, tie wires and clips, tension and brace bands, tension bars, truss rods, barb arms, and other hardware, meeting the requirements of ASTM F 626 and the exceptions and additions specified in this subsection.

Bevel the ends of hog rings for fastening fabric to the tension wire to allow crimping.

Provide fittings made of malleable iron or pressed steel for fences and gates.

If using aluminum coated wire ties and clips, ensure the coating weighs at least 0.30 ounces per square foot of surface.

The Contractor may use flat aluminum alloy line post bands with an OD from 0.062 inch to 0.375 inch and with self locking ends to fasten fabric to posts with an OD no greater than 2.375 inches.

Use double twisted, No. 9 gauge, galvanized steel for fabric fasteners for structure fencing.

Polymer coated fence fittings and hardware must be as specified above. After metallic coating, coat exterior surfaces with extruded and adhered

polymer coating. Ensure the color of the polymer coating matches the color of the polymer coated steel chain link fence fabric.

**907.05. High-Tensile Wire Fence.**

A. **Wire.** High tensile wire must be 1½ gauge, Grade 200, with Class 3 zinc coating in accordance with ASTM A 854.

B. **Wood Posts.** Wood posts must be pressure treated and meet the requirements of subsection [912.08](#).

C. **Hardware.** Galvanize hardware in accordance with ASTM A 153.

**907.06. Protective Fencing.** Protective fencing must be orange-colored, high density polyethylene mesh fabric with a nominal 2 inch diamond design. Protective fencing must be 48 inches high and weigh at least 0.102 pounds per square foot.



**Section 908. MISCELLANEOUS METAL PRODUCTS**

**908.01. General Requirements.** Miscellaneous metal products must meet the requirements of this section and the contract.

**908.02. Testing.** Miscellaneous metals product testing will be in accordance with the specified ASTM, AASHTO or Department methods, as modified by this section.

**908.03. Malleable Iron Castings.** Malleable iron castings must meet the requirements of ASTM A 47, for Grade 22010.

**908.04. Steel Castings.** Steel castings for steel construction must meet the requirements of ASTM S 148 for Grade 60/90 carbon steel castings, as shown on the plans, unless the Engineer approves an alternative in writing. Steel castings must be heat treated by full annealing, unless otherwise required.

Blow holes on finished castings must be located so that a straight line laid in any direction will not cut a total length of cavity greater than 1 inch in any 12 inches. Single blow holes must not exceed 0.500 square inches in area or have a depth that will affect the strength of the casting.

**908.05. Gray Iron Castings.** Gray iron castings must meet the requirements of AASHTO M 306, for Class 35B with certified independent proof load testing at 50,000 pounds for manholes, catch basins, leaching basins, inlets, iron steps, and bridge deck drains. Coat exposed casting surfaces with asphaltic paint. Ensure a smooth, tough, and tenacious coating when cold. Ensure the coating does not scale-off, tack, or become brittle.

**908.06. Bronze or Copper-Alloys for Structures.** Washers, bearing, and expansion plates for bridges must meet the requirements of ASTM B 22, for Copper Alloy UNS No. C91100 bronze castings, or the requirements of ASTM B 100, for Copper Alloy UNS No. C51000 copper-alloy plates and sheets. Provide bronze castings, free of deleterious material, casting faults, injurious blow holes, and other defects.

Provide finished parts with the dimensions shown on the plans, within  $\pm 5$  percent of the required thickness and  $\pm 0.125$  inch of the required width and length. For mating curved surfaces, provide the curvature radius shown on the plans no greater than +0.010 inch on concave surfaces, and no less than -0.010 inch on convex surfaces. Ensure flat machined surfaces meet required dimensions within  $\pm 0.0005$  inch per 1.0 inch.

Ensure the surface roughness of bronze or steel is no greater than 125 micro inches per inch, root mean square (RMS).

**908.07. Sheet Lead.** Sheet lead must meet the requirements of ASTM B 29 for desilverized pig lead.

**908.08. Sheet Copper.** Sheet copper must meet the requirements of ASTM B 370.

**908.09. Tubing, Steel Railings.**

**A. Base Plate, Angle, and Post Elements.** Galvanized base plate, angle, rail splice elements, and post elements must meet the requirements of ASTM A 36 and ASTM A 123. Silicon content must be less than 0.06 percent or from 0.15 percent to 0.25 percent. Base plate and post elements must meet the Charpy V Notch requirements specified in subsection [906.04.A](#) at a test temperature of 10 °F.

**B. Rail Elements.** Rail elements must meet the requirements of ASTM A 500, for Grade B and subsection [908.10.B](#) and be galvanized in accordance with ASTM A 123. Silicon content must be less than 0.06 percent or from 0.15 percent to 0.25 percent.

The Department will test rail elements from all heats supplied according to ASTM E 436, Standard Test Method for Drop-Weight Tear Tests of Ferritic Steels, except as modified herein. Drop weight tear testing is not required on TS 2 by 2 rail elements. The Department will take rail test samples at the rail supplier and test before delivery of the rail. The Department will test all rail heats supplied to the project. Do not heat treat failed heats and do not provide failed heats to the fabricator.

The Department will test after galvanizing and after completion of associated operations on the test samples. The Department will randomly test the galvanized rail for tensile, yield, and elongation properties on one of every five heats. If the tests do not verify the required elongation, the Department will sample and test a single, ungalvanized rail for elongation. The Department will conduct the drop-weight tear test on each heat at 0 °F on 2 inch by 9 inch specimens, supported to achieve a 7-inch span. The Department will not remove galvanizing from testing rail specimens.

The Department will test three specimens from each of three sides that do not contain weld to determine the percent shear area. The Department will disregard the shear areas of the three specimens from the side with the lowest average shear area, and base the final average on the remaining six specimens.

The Department will reject material with an average percent shear below 50, except that if the average shear area is between 30 and 50, the Department will allow one retest. Retest sampling frequency is three times that of the first test and all sample test results are included in calculating the average. The Department will reject material not having a minimum average percent shear area of 50 upon retest.

The manufacturer of the structural shape must identify the product as follows:

1. Place identification before galvanizing;
2. Include heat number or other code traceable to the heat number;
3. Include manufacturer's unique identification code;
4. Place identification on only one section face;
5. Repeat identification a no more than 4-foot intervals;
6. Do not extend identification into the curved surface at corners of section; and
7. Do not place identification on side facing traffic or side opposite traffic.

**C. Hardware.** Railing anchor studs must meet the requirements of ASTM A 449. Heavy hex nuts must meet the requirements of AASHTO M 291, Class 10S. Bolts, used as rail fasteners, washers and nuts must meet the requirements of AASHTO M 164, Type 1. Where called for, round head bolts and nuts must meet the requirements of ASTM A 307. The material for the railing hand hole screws must meet the requirements of ASTM A 276, Type 304. All flat washers must meet the requirements of AASHTO M 293. Lock washers must be steel, regular, helical spring washers meeting the requirements of ANSI B18.21.1 - 1972.

**908.10. Hardware for Timber Construction.** Machine bolts, drift bolts, and dowels for timber construction must be made of structural grade steel.

Washers must be cast iron ogee or malleable castings. Nails must be cut or round wire of standard form. Spikes must be cut or wire spikes, or boat spikes. Galvanize in accordance with AASHTO M 232, when required.

**908.11. Steel Beam Guardrail Elements, Hardware, and Steel Sleeves.**

**A. Steel Beam Elements and End Sections.** Steel beam sections, backup elements, buffered end sections, terminal end shoes, and special end shoes must meet the requirements of AASHTO M 180, for Class A guardrail. Thrie beam elements for bridge railing retrofit, and special end

shoes for bridge barrier railing connections must meet the requirements of AASHTO M 180, for Class B guardrail.

Provide steel beam elements, back-up elements, and end sections in the required shape. Steel beam elements, back-up elements, and end sections must be hot-dip zinc coated after fabrication in accordance with AASHTO M 180, for Type II zinc coatings. Guardrail Type A, Type B, and Type BD beam elements and corresponding back-up elements may be hot-dip zinc coated before, or after fabrication.

**B. Hardware.** Bolts, nuts, washers, and other guardrail hardware must be hot-dip zinc coated in accordance with AASHTO M 232.

Bolts, nuts, and round washers for guardrail, other than at bridge barrier railings, must meet the requirements of ASTM A 307, ASTM A 563 (Grade A with Supplementary Requirements S1 of ASTM A 563), and AASHTO M 293, respectively.

Washers, other than round washers, for guardrail must meet the requirements for circular washers in AASHTO M 293 except that the dimensions must be as shown on the plans.

Bolts and nuts for making splices and connections of beam elements, other than at bridge barrier railings, must meet the configuration requirements of AASHTO M 180 (bolts must be of the Alternate No. 2 configuration).

Bolts, nuts, and washers for connections at bridge barrier railings must conform to AASHTO M 164 Type 1 galvanized high-strength structural bolts with suitable nuts and hardened washers.

Wire rope and fittings for the cable anchorage must conform to AASHTO M 30. Wire rope must be Type II with a Class B coating.

**C. Steel Sleeves, Soil Plates, and Bearing Plates.** Provide steel sleeves with the inside dimensions shown on the plans within a tolerance, after galvanizing, of  $\pm\frac{1}{8}$  inch. Provide steel plates in the sizes shown on the plans, but no more than +0.250 inch larger.

Steel for the sleeves and plates for wood guardrail posts must meet the requirements of ASTM A 36 or ASTM A 1011, for Grade 36 or Grade 40.

Steel sleeves must have one or two full penetration longitudinal welds that run along the length of the sleeve.

Hot-dip zinc coat sleeves and plates in accordance with AASHTO M 111. The weight of the zinc coating on the sleeves must average at least 2.0 ounces per square foot and each sleeve must have at least 1.7 ounces of zinc coating per square foot. The weight of the zinc

coating on plates must average at least 2.3 ounces per square foot and each plate must have at least 2.0 ounces of zinc coating per square foot.

**908.12. Steel Posts for Guardrail.** Steel posts for guardrail must be W6 by 9 section steel posts of the length shown on the plans for guardrail. Each steel post must weigh at least 9.0 pounds per foot, including zinc coating. The Engineer will allow nominal 6 inch by 4 inch joist sections that weigh at least 8.5 pound per linear foot, including the zinc coating. Posts must be fabricated from ASTM A 36 structural steel.

Hot-dip galvanize posts in accordance with ASTM A 123 to produce an average coating weight of at least 2.0 ounces per square foot of surface area.

**908.13. Reflectorized Washers for Guardrail.** Reflectorized washers for guardrail must be fabricated from at least 13 gauge galvanized steel sheets, galvanized in accordance with ASTM A 653, Coating Designation G210, and as required. Use Type III reflective sheeting meeting the requirements of subsection [919.03.B](#).

Provide washers of the required shapes and sizes. Degrease washers and treat in accordance with the sheeting manufacturer's recommendations before applying the sheeting. Bond reflective material to the galvanized steel washers.

**908.14. Anchor Bolts, Nuts, and Washers.**

**A. General.** Ensure the fabricator or supplier provides test data certification for bolts with a reference to the heat number of the steel, including the following test results:

1. Yield strength,
2. Tensile strength,
3. Elongation,
4. Reduction of area, and
5. Charpy V-notch.

If anchor bolts, nuts, and washers are heat treated, ensure the supplier provides the furnace lot number. Before sampling, anchor bolts for cantilever and truss sign supports must have a heat number identification stamped in the end of the hook and a Department test report reference stamped in the threaded end cross-section. Order additional bolts to replace those used for testing.

**B. Sign Support and Light Standard Anchor Bolts.** Sign support and light standard bolts must be medium carbon, hot rolled steel bar anchor bolts meeting the mechanical requirements of ASTM F 1554, for Grade 55, supplemental S4.

| <b>Table 908-1<br/>Anchor Bolt Specifications</b>                            |                      |
|--|----------------------|
| <b>Characteristic</b>  | <b>Specification</b> |
| Yield Strength   | 55 ksi               |
| Ultimate Strength  | 75 – 95 ksi          |
| Elongation (2 in gauge)  | ≥21% (a)             |
| Reduction in Area  | ≥30% (b)             |
| Longitudinal Charpy V-Notch  | ≥15 ft-lb at 40 °F   |
| a. Elongation (8 in gauge), min 18% for bolts tested full section.           |                      |
| b. Bolts over 2 in to 2.5 in, 22% minimum; over 2.5 in to 3 in, 20% minimum. |                      |

The Department will perform notch toughness tests on specimens in accordance with Test Frequency (P) Piece Testing of AASHTO T 243 orienting the notch perpendicular to the longitudinal axis of the anchor bolt. If necessary, heat treat steel to meet Charpy V-Notch impact requirements.

Provide anchor bolts, nuts, and washers in the size and shape shown on the plans, hot-dip zinc coated in accordance with AASHTO M 232, as required.

Anchor bolt threads must meet the requirements of ANSI B1.1, for 8UN series, Class 2A tolerances before coating. After coating, the maximum limit of pitch and major diameter for bolts with a diameter no greater than 1 inch may exceed the Class 2A limit by no greater than 0.02 inch, and by no greater than 0.031 inch for bolts greater than 1 inch in diameter. Anchor bolt threads may be cut or rolled into the round bar stock.

Nuts for anchor bolts must meet the requirements of ASTM A 563, for Grade DH, or ASTM A 194, for Grade 2H, heavy hex. Nut threads must meet the requirements of ANSI B1.1, for 8UN series, Class 2B tolerances. After coating, for nuts no greater than 1 inch in diameter, tap oversize no greater than 0.021 inch, and for nuts greater than 1 inch in diameter, tap oversize no greater than 0.031 inch. Lubricate nuts in accordance with Supplementary S1 of ASTM A 563.

Provide washers meeting the requirements of AASHTO M 293 for circular washers.

**C. Anchor Bolts for Traffic Signal Strain Poles.** Provide four high strength anchor bolts with each standard. Anchor bolts for traffic signal strain poles must meet the requirements of subsection [908.15.B](#) with the following exceptions and additions:

1. Requirement for longitudinal Charpy V-Notch do not apply.
2. Coarse pitch threads are acceptable if the anchor bolts meet required tolerances.

3. Anchor bolts must be 120 inches long including a 6 inch "L" bend at the lower end. Bolts must be 1 $\frac{3}{4}$ -inch diameter for poles from 30 feet to 36 feet or 2-inch diameter for poles 40 feet. Bolts must be threaded at least 9 inches at the upper end. At least 20 inches of the threaded end of bolts must be hot-dip galvanized, after threading, in accordance with ASTM A 153.
4. Each anchor bolt must be provided with one lock washer, two flat washers, and two Heavy Hexagon series hex nuts meeting the requirements of ASTM A 563 for carbon steel nuts with at least Grade A strength.

**D. Anchor Bolts and Nuts for Other Purposes.** Steel anchor bolts and nuts must meet the requirements of ASTM F1554, for Grade 36. Provide Heavy Hexagon series nuts.

Galvanize nuts, washers, and the exposed length of anchor bolts plus 6 inches in accordance with AASHTO M 232. Retap nuts after galvanizing, in accordance with ASTM A 563.

## Section 909. DRAINAGE PRODUCTS

**909.01. General Requirements.** Use the pipe materials shown in Table [401-1](#) and Table [402-1](#) for culverts or sewers, if only the size and class are specified by the contract documents. Construct drainage structures and underdrains as required.

Provide galvanized corrugated steel or aluminum structural plates as required. Galvanized corrugated steel structural plates must meet the requirements of AASHTO M 167. Corrugated aluminum structural plates must meet the requirements of ASTM B 790 or Section 12 of the AASHTO LRFD Bridge Specifications.

Provide sanitary sewer or industrial waste systems in accordance with the contract. Install sanitary sewer or industrial waste systems using a compression gasket as specified in subsection [909.03](#).

**909.02. Testing.** Test drainage products in accordance with AASHTO or ASTM specifications, unless otherwise specified in this section.

Ensure each concrete pipe manufacturer provides a calibrated standard testing machine to determine the strength of the product. Ensure the manufacturer provides labor and materials to perform strength tests.

**909.03. Watertight Joints for Sewers and Culverts.** Provide watertight joint systems selected from the Qualified Products List. Ensure watertight joint systems meet the pressure test requirements of [MTM 723](#) and the specifications for the materials used in assembling the pipe system.

Use flexible rubber compression gaskets meeting the requirements of ASTM C 443 for concrete pipe, ASTM F 477 for plastic pipe, or AASHTO M 36 for metal pipe. As an alternative to the AASHTO M 36 requirements for metal pipe, the Contractor may use gasket material meeting the low temperature flexibility and elevated temperature flow test requirements of ASTM C 990 and AASHTO M 198, excluding the requirements for softening point, flashpoint and fire point.

External rubber gaskets, mastic, and protective film must meet the requirements of ASTM C 877.

**909.04. Concrete Pipe Products.**

**A. Reinforced Concrete Circular Pipe.** Provide reinforced concrete circular pipe meeting the requirements of AASHTO M 170 or AASHTO M 242. If using AASHTO M 242 pipe, ensure the design loads meet the requirements of AASHTO M 170.



If using AASHTO M 170 pipe, apply the following exceptions and additions:

1. The Contractor may use the circular pipe designs specified in Table [909-1](#), Table [909-2](#), Table [909-3](#), and Table [909-4](#) in addition to the circular pipe designs in Table 2, Table 3, Table 4, and Table 5 of AASHTO M 170.
2. Cast or drill lift holes and seal with concrete plugs after installing the pipe. Cast lift holes in circular pipe with elliptical reinforcing along the top centerline of the pipe.
3. Use circular reinforcement in circular pipe for use in pipe culverts and sewers jacked in place. The Engineer will waive the absorption test requirements of the concrete if the load required to produce the 0.01 inch crack exceeds the minimum load by at least 20 percent.

If using stirrup supports, use indentations or waterproof paint to mark the top and bottom centerline of the pipe, inside and out, on each end of the pipe. Symmetrically place stirrup supports around the centerline in the top and bottom portion of the pipe. Pass stirrups around, and in contact with each inside circumferential reinforcing member. Space the stirrups in accordance with Table [909-2](#), Table [909-3](#), and Table [909-4](#). Do not use more than three sections of stirrup material in one support line. Ensure a section length of at least 30 inches for each stirrup.

**B. Reinforced Concrete Elliptical Pipe.** Provide reinforced concrete elliptical pipe meeting the requirements of AASHTO M 207. The Engineer will waive the concrete absorption test requirement if the load required to produce the 0.01 inch crack exceeds the required minimum load by at least 20 percent.

The Contractor may use the horizontal elliptical pipe designs specified in Table [909-5](#) and Table 1 of AASHTO M 207.

**C. Non-Reinforced Concrete Pipe.** Provide non-reinforced concrete pipe meeting the requirements of AASHTO M 86. Place required markings on the barrel of the pipe near the socket. Ensure the markings remain legible during delivery of the pipe to the project.

**D. Precast Concrete Box Sections.** Use precast concrete box sections as required and in accordance with ASTM C 1577.

**E. Concrete End Sections.** Provide precast concrete end sections fabricated using material meeting the requirements of AASHTO M 170, for Class II, and as shown on the plans. Provide wet-cast concrete for end sections with an entrained air content of 6.0 percent to 8.5 percent. Ensure concrete for end sections made using the dry-cast process contains at least 658 pounds of cement per cubic yard of concrete and

uses a liquid air entraining agent at the dosage recommended by the manufacturer for dry cast concrete.

Use tongue and groove joints to make connections to pipe culverts.

**F. Pipe Culverts Jacked in Place.** For pipe culverts jacked in place, use reinforced concrete pipe at least 36 inches in diameter, meeting the requirements of AASHTO M170, for Class IV or Class V, Wall C.

**G. Precast Concrete Three-Sided and Arch Sections.** Use precast concrete three-sided and arch sections as required and in accordance with ASTM C 1504.

**909.05. Metal Pipe Products.** For metal pipe products, refer to Table [909-6](#) for the minimum wall thickness, or refer to Table [909-7](#) through Table [909-17](#), and Table [909-20](#) to determine the required wall thickness.

Refer to Table [909-19](#) for gauge equivalents for specified nominal thicknesses.

**A. Corrugated Steel Pipe.** Provide circular and pipe arch corrugated steel pipe meeting the requirements of AASHTO M 36 for metallic coated pipe. For polymer-precoated pipe, provide circular and pipe arch corrugated steel pipe meeting the requirements of AASHTO M 245 and using an ethylene acrylic acid film selected from the Qualified Products List.

The Contractor may use Type IA and Type IIA dual wall polymer-precoated galvanized corrugated steel pipe of the wall thicknesses specified in Table [909-6](#) and specified in subsection [909.05](#).

1. **Steel Sheet.** Provide corrugated steel pipe from zinc coated sheets meeting the requirements of AASHTO M 218 or from aluminum coated sheets meeting the requirements of AASHTO M 274. Do not use the continuous welded seam process if using aluminum coated sheets for pipe.

On zinc coated steel sheet for polymer-precoated corrugated steel pipe, use ethylene acrylic acid film selected from the Qualified Products List meeting the requirements of AASHTO M 246, for Grade 250/250 polymer. Only use lock seam pipe. Do not use riveted pipe.

Ensure the metallic coating weight on individual samples of fabricated pipe or steel sheet meets the single spot and triple spot test requirements in accordance with AASHTO M 218. Refer to Table [909-6](#), Table [909-7](#), Table [909-8](#), Table [909-9](#), Table [909-10](#),

and Table [909-11](#) for the specified nominal sheet thickness for a given diameter, class, and size of corrugation of culvert or sewer pipe.

Provide pipe from 6 inches to 12 inches in diameter, fabricated from steel sheet with a minimum thickness of at least 0.064 inch (16 gage).

2. **Corrugations.** For required pipe at least 12 inches in diameter, do not use pipe with 1½ inch by ¼ inch corrugations.
3. **End Finish for Helical Corrugated Pipe.** For helical corrugated pipe, except perforated pipe, with diameters of at least 12 inches, reroll the pipe ends to form at least two circumferential corrugations, or to form an upturned flange, in accordance with AASHTO M 36 or AASHTO M 245. This end treatment for perforated pipe and pipe with diameters less than 12 inches is optional for the fabricator.
4. **Coupling Bands.** To connect sections of pipe and to attach end sections to culvert pipe with diameters of at least 12 inches, except perforated pipe, provide coupling bands circumferentially corrugated with the same size corrugations as on the ends of the pipe. As an alternative, use preformed channel bands on pipe ends with flanges meeting the requirements of AASHTO M 36 or AASHTO M 245 and the details shown on the plans.

For coupling bands with diameters no greater than 10 inches, use coupling bands with corrugations matching the pipe corrugations.

The Contractor may connect perforated pipe with a diameter no greater than 12 inches, with smooth sleeve-type couplers. For perforated pipe with diameters greater than 12 inches, use coupling bands with corrugations matching the pipe corrugations.

Provide coupling band connections as specified in subsection [401.03](#) and meeting the requirements of AASHTO M 36 or AASHTO M 245.

**B. Corrugated Aluminum Alloy Pipe.** Provide corrugated aluminum alloy pipe meeting the requirements of AASHTO M 196, except fabricate pipe from aluminum sheet with the nominal thickness specified in Table [909-12](#), Table [909-13](#), Table [909-14](#), Table [909-15](#), Table [909-16](#), and Table [909-17](#).

Only use Type IA and Type IIA corrugated aluminum alloy pipe if directed by the Engineer.

**C. Steel End Sections.** Provide steel end sections with coupling bands or hardware as shown on the plans. Ensure metallic coating on the end

sections is the same as the metallic coating on the pipe. The Contractor may use zinc coated steel end sections with aluminum coated steel pipe and polymer coated steel pipe. Provide metal end sections meeting the requirements of AASHTO M 36.

**D. Steel Pipe for Jacking in Place.** Provide steel pipe for jacking in place meeting the requirements of ASTM A 53, for Type E or Type S, Grade B or ASTM A 139, for Grade B. For field welding at joints, prepare the ends of steel pipe for jacking in place.

**909.06. Plastic Pipe Products.** Provide Smooth-Lined Corrugated Polyethylene Pipe (CPE) and required fittings meeting the requirements of AASHTO M 294, for Type S.

Provide Corrugated Polyvinyl Chloride Pipe (CPV) and required fittings meeting the requirements of AASHTO 304. The Engineer will test CPV in accordance with [MTM 728](#).

If providing a separate fitting or coupling to ensure a watertight joint in corrugated plastic pipe culverts and sewers, use non-corrugated, solid sleeve, fabricated from Polyethylene (PE) or Polyvinyl Chloride (PVC) with a gasket meeting the requirements of subsection [909.03](#) on both sides of the joint. Do not use split collar couplers.

Ensure a pipe indentation in each sleeve in the center to ensure positioning of the pipe sections in the field. Factory install sleeves on one end of the pipe sections and place a removable protective material over the exposed gaskets. Lubricate gaskets and sleeves before insertion, as required by the manufacturers.

**909.07. Pipe for Underdrains.**

**A. Smooth Plastic Pipe for Underdrain.** Provide smooth plastic pipe for underdrain, fabricated from PVC pipe meeting the requirements of AASHTO M 278. For pipes no greater than 6 inches in diameter, the Contractor may use acrylonitrile-butadiene-styrene (ABS) pipe meeting the requirements of ASTM D 2751, for SDR 35, with perforations meeting the requirements of AASHTO M 278, except the joint tightness requirements do not apply.

**B. Corrugated Plastic Tubing for Underdrain.** Provide corrugated plastic tubing for underdrain meeting the requirements of AASHTO M 252 for PE tubing, or ASTM F 949 for PVC tubing. Ensure the perforations for PE and PVC tubing meet the requirements of AASHTO M 252.

**C. Underdrain Outlets.** Provide PVC pipe underdrain outlets meeting one of the following requirements:

1. ASTM D 1785 Schedule 40;
2. ASTM D 2665;
3. ASTM D 3034, for Type SDR 23.5; or
4. Corrugated steel pipe in accordance with subsection [909.05.A](#).

D. **Connections.** Obtain the Engineer's approval of fittings and connections for the underdrain system before installing the underdrain.

Seal connections with tape recommended by the manufacturer for underground service conditions. Provide tape resistant to moisture and organic growth.

### **909.08. Pipe for Downspouts.**

A. **Bridge Deck Downspouts.** Provide bridge deck downspouts of PE pipe meeting the requirements of ASTM D 2447, PE 3406, Schedule 40. The Contractor may provide bridge deck downspouts of fiberglass Reinforced Thermosetting Resin Pipe (RTRP) with a short-term rupture hoops tensile stress of at least 30,000 psi, in accordance with ASTM D 2996.

B. **Culvert, Downspouts.** If shown on the plans, provide other culvert downspouts made from one of the following:

1. Corrugated steel pipe as specified in subsection [909.05.A](#);
2. Corrugated aluminum alloy pipe as specified in subsection [909.05.B](#);  
or
3. Corrugated Polyethylene Pipe (CPP) meeting the requirements of AASHTO M 294, for Type C.

Provide fittings required for CPP meeting the requirements of AASHTO M 294.

Seal joints between lengths of pipe, as recommended by the pipe manufacturer, to form silt-tight joints. Provide end sections as shown on the plans and specified in subsection [909.04.D](#) or subsection [909.05.C](#).

C. **Bridge Deck Drain Extensions.** Provide bridge deck drain extensions as an integral component of the drain casting assembly in accordance with Standard Plan B-101 Series.

**909.09. Cold-Applied Pipe Joint Sealer.** The Engineer will test cold-applied pipe joint sealers in accordance with section [904](#) as modified by this subsection.

The Engineer will use the cone method penetration test in accordance with ASTM D 1191, except the Engineer will test the material as received. The Contractor may trowel the material into the ointment can. The Engineer will perform the flow test in accordance with

ASTM D 1851, except the Contractor may trowel the material into the test mold.

Ensure the asphaltic material for sealing joints in concrete or clay pipe can spread on the joints with a trowel at an air temperature from 14 °F to 100 °F. Ensure the material adheres to the concrete or clay to make a watertight seal. Ensure the material does not flow, crack, or become brittle if exposed to the atmosphere.

Provide asphaltic sealer meeting the following requirements:

- A. Penetration with cone from 175 dmm to 300 dmm, at 77 °F, for 5 seconds, 150 grams;
- B. Loss on heating maximum of 1.50 percent at 325 °F, for 5 hours, 50 grams;
- C. Minimum solubility in trichloroethylene, 70 percent;
- D. Ash from 15 percent to 25 percent; and
- E. Flow of 0 centimeter maximum at 60 °C.

Deliver the sealer to the project in sealed containers. Protect the sealer from contamination. Mark the container with "Cold-Applied Pipe Joint Sealer" and the brand name, net volume or weight, and the application requirements.

**909.10. Drainage Marker Posts.** Provide drainage marker posts meeting the requirements for plastic or steel delineator posts as specified in section [919](#) or the requirements for steel line fence posts in section [907](#), except provide posts at least 6 feet long. The Contractor may submit alternate post materials to the Engineer for approval.

**909.11. Rodent Screens.** Provide rodent screens of hardware cloth meeting the requirements of ASTM A 740 with an opening size no greater than 0.30 inch, except provide wire of a nominal size of 0.057 inch and a minimum zinc coating weight of 0.59 ounce per square foot of uncoated wire surface, applied after weaving. The Contractor may substitute fabric made of Type 304 stainless steel wire with an opening no greater than 0.30 inch and a 0.057 inch nominal wire diameter. The Contractor may submit other screens with openings no greater than 0.30 inch to the Engineer for approval.

Form the screen using a punch and die. After shaping ensure the fabric forms a cylinder slightly larger than the inside diameter of the outlet pipe.

| <b>Table 909-1<br/>Additional Designs For Class II Reinforced Concrete Pipe (AASHTO M 170 Table 2 Extended)</b>  |   |   |                   |  |                            |
|--|---|---|-------------------|--|----------------------------|
| <b>Internal Diameter of<br/>Pipe, (in)</b>   | <b>Minimum<br/>Wall Thickness, (in)</b> | <b>Reinforcement per foot of Pipe Wall, (sq in)</b> |                   |  |                            |
|  |   | <b>Circular Reinforcement in<br/>Circular Pipe</b>  |                   | <b>Elliptical Reinforcement in<br/>Circular Pipe</b> |                            |
|  |   | <b>Inner Cage</b>                                   | <b>Outer Cage</b> | <b>Inner Circular<br/>Cage</b>                       | <b>Elliptical<br/>Cage</b> |
| 114  | 9.5                                     | 0.56  | 0.34              | 0.22   | 0.34                       |
| 120  | 10                                      | 0.61  | 0.37              | 0.24   | 0.37                       |
| 126  | 10.5                                    | 0.65  | 0.39              | 0.26   | 0.39                       |
| 132  | 11                                      | 0.70  | 0.42              | 0.28   | 0.42                       |
| 144  | 12                                      | 0.80  | 0.48              | 0.32   | 0.48                       |
| <p>Note: D-Load = pound-force per linear foot per foot of diameter.<br/> D-Load to produce a 0.01 in crack 1,000.<br/> D-Load to produce the ultimate load, 1,500.<br/> Concrete Strength, 5,000 psi</p> |   |   |                   |  |                            |

**Table 909-2  
Additional Designs For Class III Reinforced Concrete Pipe(AASHTO M 170 Table 3 Extended)**

| Internal Diameter of Pipe, (in) | Reinforcement per foot of Pipe Wall, (sq in) |            |   |                 | Stirrup Support System                        |                  |                     |                                     |                                 | Ave. Area (sq in per ft per line) (d) |
|---------------------------------|--|------------|---|-----------------|---|------------------|---------------------|-------------------------------------|---------------------------------|---------------------------------------|
|                                 | Circular Reinforcement in Circular Pipe      |            | Elliptical Reinforcement in Circular Pipe |                 | Minimum Area per Support Element, (sq in) (a) | No. of Lines (b) | Long. Spacing, (in) | Circum. Spacing on Inner Cage, (in) | Amplitude of Supports, (in) (c) |                                       |
|                                 | Inner Cage                                   | Outer Cage | Inner Circular Cage                       | Elliptical Cage |   |                  |                     |                                     |                                 |                                       |
| 114                             | 0.69   | 0.41       | 0.28                                      | 0.41            | 0.041   | 5                | 2                   | 6 7/8                               | 6.68                            | 0.242                                 |
| 120                             | 0.74   | 0.44       | 0.30                                      | 0.44            | 0.041   | 5                | 2                   | 6 1/2                               | 7.16                            | 0.242                                 |
| 126                             | 0.79   | 0.47       | 0.32                                      | 0.47            | 0.041   | 5                | 2                   | 6 7/8                               | 7.68                            | 0.242                                 |
| 132                             | 0.85   | 0.51       | 0.34                                      | 0.51            | 0.041   | 5                | 2                   | 7 1/4                               | 8.16                            | 0.242                                 |
| 144                             | 0.97   | 0.58       | 0.39                                      | 0.58            | 0.041   | 5                | 2                   | 8                                   | 9.16                            | 0.242                                 |

Note: D-Load = pound-force per linear foot per foot of diameter.  
 D-Load to produce a 0.01 in crack 1,350.  
 D-Load to produce the ultimate load 2000.  
 Concrete Strength 5000 psi.

Where a stirrup system is shown for a given size, it must be used with the circumferential reinforcement design selected.  
 a. Two times the cross-sectional area of the wire used in the stirrup support system using 2 in x 8 in pattern for inner cage steel.  
 b. Number of longitudinal lines required in the top and in the bottom portions of the pipe.  
 c. Overall width of each line of stirrup support system using 2 in x 8 in pattern for inner cage steel. (Use with Shearlock stirrups or S-stirrups or equal)

d. Minimum area per support times number of supports per foot using 2 in x 8 in pattern for inner cage steel.



Table 909-3  
 Additional Designs For Class IV Reinforced Concrete Pipe(AASHTO M 170 Table 4 Extended)

| Internal Diameter of Pipe, (in) | Minimum Wall Thickness, (in) | Reinforcement, per foot of Pipe Wall, (sq in) |            |   |                 | Stirrup Support System                       |                     |                     |                                     |                                 |  |
|---------------------------------|------------------------------|---|------------|---|-----------------|--|---------------------|---------------------|-------------------------------------|---------------------------------|--|
|                                 |                              | Circular Reinforcement in Circular Pipe       |            | Elliptical Reinforcement in Circular Pipe |                 | Minimum area per Support Element (sq in) (a) | Number of Lines (b) | Long. Spacing, (in) | Circum. Spacing on Inner Cage, (in) | Amplitude of Supports, (in) (c) | Ave. Area, (sq in per ft per line) (d) |
|                                 |                              | Inner Cage                                    | Outer Cage | Inner Circular Cage                       | Elliptical Cage |  |                     |                     |                                     |                                 |  |
|                                 |                              |   |            |   |                 |  |                     |                     |                                     |                                 |  |
| 78                              | 7½                           | 0.87  | 0.52       | 0.35                                      | 0.52            | 0.028  | 11                  | 2                   | 4%                                  | 4.67                            | 0.167                                  |
| 84                              | 8                            | 1.00  | 0.60       | 0.40                                      | 0.64            | 0.028  | 11                  | 2                   | 4%                                  | 5.17                            | 0.167                                  |
| —                               | —                            | Concrete Strength, 5,000 psi                  |            |   |                 | 0.028  | 11                  | 2                   | 4%                                  | 5.17                            | 0.167                                  |
| 78                              | 7½                           | 0.69  | 0.41       | 0.28                                      | 0.41            | 0.028  | 11                  | 2                   | 5%                                  | 5.67                            | 0.167                                  |
| 84                              | 8                            | 0.74  | 0.44       | 0.30                                      | 0.44            | 0.033  | 11                  | 2                   | 5%                                  | 5.67                            | 0.195                                  |
| 90                              | 8                            | 0.85  | 0.51       | 0.34                                      | 0.51            | 0.043  | 11                  | 2                   | 5%                                  | 6.17                            | 0.260                                  |
| 96                              | 8½                           | 0.91  | 0.55       | 0.36                                      | 0.55            | 0.047  | 11                  | 2                   | 6%                                  | 6.67                            | 0.279                                  |
| 102                             | 8½                           | 1.02  | 0.61       | 0.41                                      | 0.61            | 0.050  | 11                  | 2                   | 6%                                  | 7.17                            | 0.298                                  |
| 108                             | 9                            | 1.07  | 0.64       | 0.43                                      | 0.64            | 0.053  | 11                  | 2                   | 7%                                  | 7.67                            | 0.316                                  |
| 114                             | 9½                           | 1.02  | 0.61       | 0.41                                      | 0.61            | 0.056  | 11                  | 2                   | 7%                                  | 8.17                            | 0.335                                  |
| 120                             | 10                           | 1.10  | 0.66       | 0.44                                      | 0.66            | 0.064  | 11                  | 2                   | 8                                   | 9.17                            | 0.381                                  |
| 126                             | 10½                          | 1.17  | 0.70       | 0.47                                      | 0.70            |  |                     |                     |                                     |                                 |  |
| 132                             | 11                           | 1.25  | 0.75       | 0.50                                      | 0.75            |  |                     |                     |                                     |                                 |  |
| 144                             | 12                           | 1.42  | 0.85       | 0.57                                      | 0.85            |  |                     |                     |                                     |                                 |  |

Note: D-Load = pound-force per linear foot per foot of diameter.

D-Load to produce a 0.01 inch crack, 2,000.

D-Load to produce the ultimate load, 3,000.

Where a stirrup system is shown for a given size, it must be used with the circumferential reinforcement design selected.

a. Two times the cross-sectional area of the wire used in the S-stirrups.

b. Number of longitudinal lines required in the top and in the bottom portions of the pipe.  
 c. Overall width of each line of stirrup support system using 2 in x 8 in pattern for inner cage steel. (Use with Shearlock stirrups or S-stirrups or equal.)

d. Minimum area per support times number of supports per foot using 2 in x 8 in pattern for inner cage steel.

**Table 909-4  
Additional Designs for Class V Reinforced Concrete Pipe (AASHTO M 170 Table 5 Extended)**

| Internal Diameter of Pipe, (in) | Wall Thickness, (in min)                |   | Reinforcement, sq in per foot of Pipe Wall |   |                     |                     | Stirrup Support System              |                                  |                     |                 |  | Ave. Area, (sq in per ft per line) (d) |
|---------------------------------|---|---|--|---|---------------------|---------------------|-------------------------------------|----------------------------------|---------------------|-----------------|--|--|
|                                 | Circular Reinforcement in Circular Pipe | Elliptical Reinforcement in Circular Pipe |  | Minimum Area per Support Element, (sq in) (a) | Number of Lines (b) | Long. Spacing, (in) | Circum. Spacing on Inner Cage, (in) | Ampli-tude of Supports, (in) (c) |                     |                 |  |  |
|                                 |   | Inner Cage                                | Outer Cage                                 |   |                     |                     |                                     |                                  | Inner Circular Cage | Elliptical Cage |  |  |
| 54                              | 5½                                      | 0.64                                      | 0.38                                       | 0.26  | 0.38                | 15                  | 2                                   | 2½                               | 2.68                | 0.167           |  |  |
| 60                              | 6                                       | 0.70                                      | 0.42                                       | 0.28  | 0.42                | 0.028               | 14                                  | 2                                | 2                   | 0.167           |  |  |
| 66                              | 6½                                      | 0.79                                      | 0.47                                       | 0.32  | 0.47                | 0.028               | 13                                  | 2                                | 2                   | 0.167           |  |  |
| 72                              | 7                                       | 0.87                                      | 0.52                                       | 0.35  | 0.52                | 0.028               | 12                                  | 2                                | 3                   | 0.167           |  |  |
| 78                              | 7½                                      | 0.92                                      | 0.55                                       | 0.37  | 0.55                | 0.028               | 11                                  | 2                                | 4                   | 0.167           |  |  |
| 84                              | 8                                       | 0.99                                      | 0.59                                       | 0.40  | 0.59                | 0.033               | 11                                  | 2                                | 4                   | 0.195           |  |  |
| 90                              | 8                                       | 1.13                                      | 0.68                                       | 0.45  | 0.68                | 0.040               | 11                                  | 2                                | 4                   | 0.248           |  |  |
| 96                              | 8½                                      | 1.20                                      | 0.72                                       | 0.48  | 0.72                | 0.043               | 11                                  | 2                                | 5                   | 0.260           |  |  |
| 102                             | 8½                                      | 1.34                                      | 0.80                                       | 0.54  | 0.80                | 0.051               | 11                                  | 2                                | 5                   | 0.307           |  |  |
| 108                             | 9                                       | 1.51                                      | 0.91                                       | 0.60  | 0.91                | 0.061               | 11                                  | 2                                | 5                   | 0.363           |  |  |
| 114                             | 9½                                      | 1.51                                      | 0.91                                       | 0.60  | 0.91                | 0.062               | 11                                  | 2                                | 6                   | 0.372           |  |  |
| 120                             | 10                                      | 1.62                                      | 0.97                                       | 0.65  | 0.97                | 0.067               | 11                                  | 2                                | 6                   | 0.400           |  |  |
| 126                             | 10½                                     | 1.73                                      | 1.04                                       | 0.69  | 1.04                | 0.070               | 11                                  | 2                                | 6                   | 0.419           |  |  |
| 132                             | 11                                      | 1.84                                      | 1.10                                       | 0.74  | 1.10                | 0.074               | 11                                  | 2                                | 7                   | 0.446           |  |  |
| 144                             | 12                                      | 2.09                                      | 1.25                                       | 0.84  | 1.25                | 0.082               | 11                                  | 2                                | 8                   | 0.493           |  |  |

Note: D-Load = pound-force per linear foot per foot of diameter.  
 D-Load to produce a 0.01 inch crack, 3, 000.  
 D-Load to produce the ultimate load, 3, 750.  
 Concrete Strength, 6, 000 psi.

- Where a stirrup system is shown for a given size, it must be used with the circumferential reinforcement design selected.
- a. Two times the cross-sectional area of the wire used in the Stirrups Support System using 2 in x 8 in pattern for inner cage steel. (Use with Shearlock stirrups or S-stirrups or equal.)
  - b. Number of longitudinal lines required in the top and in the bottom portions of the pipe.
  - c. Overall width of each line of stirrups.
  - d. Minimum area per support times number of supports per foot using 2 in x 8 in pattern for inner cage steel.

**Table 909-5  
Additional Designs for Horizontal Elliptical Pipe**

| Specified Diameter, Equivalent Round Size (in) | Specified Rise by Span (in) | Min Wall Thick (in) | Reinforcement, sq in per foot |          |            |            |             |          |             |          |             |              |             |          | Class HE-IV                          |                     |                    |                                       |  |  |
|--|-----------------------------|---------------------|-------------------------------|----------|------------|------------|-------------|----------|-------------|----------|-------------|--------------|-------------|----------|--------------------------------------|---------------------|--------------------|---------------------------------------|--|--|
|  |                             |                     | Class HE-A                    |          |            | Class HE-I |             |          | Class HE-II |          |             | Class HE-III |             |          | Stirrup Support System               |                     |                    |                                       |  |  |
|  |                             |                     | 0.01 = 600                    |          | 0.01 = 800 |            | 0.01 = 1000 |          | 0.01 = 1350 |          | 0.01 = 2000 |              | 0.01 = 3000 |          | Min Area per Support Element (sq in) | Number of Lines (a) | Long. Spacing (in) | Circum. Spacing on Inner Cage (in)(b) |  |  |
|  |                             |                     | In Cage                       | Out Cage | In Cage    | Out Cage   | In Cage     | Out Cage | In Cage     | Out Cage | In Cage     | Out Cage     | In Cage     | Out Cage |                                      |                     |                    |                                       |  |  |
| 48   | 38 x 60                     | 5½                  | —                             | —        | —          | —          | —           | —        | —           | —        | —           | —            | 0.70        | 0.70     | 0.13                                 | 15                  | 2                  | 3.000                                 |  |  |
| 54   | 43 x 68                     | 6                   | —                             | —        | —          | —          | —           | —        | —           | —        | —           | —            | 0.82        | 0.82     | 0.15                                 | 15                  | 2                  | 3.375                                 |  |  |
| 60   | 48 x 76                     | 6½                  | —                             | —        | —          | —          | —           | —        | —           | —        | —           | —            | 0.94        | 0.94     | 0.17                                 | 15                  | 2                  | 3.750                                 |  |  |
| 66   | 53 x 83                     | 7                   | —                             | —        | —          | —          | —           | —        | —           | —        | —           | —            | 0.99        | 0.99     | 0.17                                 | 15                  | 2                  | 4.125                                 |  |  |
| 72   | 58 x 91                     | 7½                  | —                             | —        | —          | —          | —           | —        | —           | —        | —           | —            | 1.11        | 1.11     | 0.19                                 | 15                  | 2                  | 4.500                                 |  |  |
| 84   | 63 x 98                     | 8                   | —                             | —        | —          | —          | —           | —        | —           | —        | —           | —            | 1.21        | 1.21     | 0.21                                 | 15                  | 2                  | 4.875                                 |  |  |
| 78   | 68 x 106                    | 8½                  | —                             | —        | —          | —          | —           | —        | —           | —        | —           | —            | 1.33        | 1.33     | 0.22                                 | 15                  | 2                  | 5.250                                 |  |  |
| 90   | 72 x 113                    | 9                   | 0.28                          | 0.28     | 0.40       | 0.40       | 0.58        | 0.58     | —           | —        | —           | —            | 0.84        | 1.43     | 0.24                                 | 15                  | 2                  | 5.625                                 |  |  |
| 96   | 77 x 121                    | 9½                  | 0.30                          | 0.30     | 0.45       | 0.45       | 0.65        | 0.65     | 0.92        | 0.92     | 0.92        | 0.92         | 1.56        | 1.56     | 0.26                                 | 15                  | 2                  | 6.000                                 |  |  |
| 102  | 82 x 128                    | 9¾                  | 0.33                          | 0.33     | 0.52       | 0.52       | 0.73        | 0.73     | 1.03        | 1.03     | 1.03        | 1.03         | 1.72        | 1.72     | 0.28                                 | 15                  | 2                  | 6.188                                 |  |  |
| 108  | 87 x 136                    | 10                  | 0.36                          | 0.36     | 0.60       | 0.60       | 0.83        | 0.83     | 1.16        | 1.16     | 1.16        | 1.16         | 1.92        | 1.92     | 0.30                                 | 15                  | 2                  | 6.375                                 |  |  |
| 114  | 92 x 143                    | 10½                 | 0.40                          | 0.40     | 0.64       | 0.64       | 0.88        | 0.88     | 1.23        | 1.23     | 1.23        | 1.23         | 2.02        | 2.02     | 0.32                                 | 15                  | 2                  | 6.750                                 |  |  |
| 120  | 97 x 151                    | 11                  | 0.44                          | 0.44     | 0.70       | 0.70       | 0.96        | 0.96     | 1.32        | 1.32     | 1.32        | 1.32         | 2.16        | 2.16     | 0.34                                 | 15                  | 2                  | 7.125                                 |  |  |
| 132  | 106 x 166                   | 12                  | 0.53                          | 0.53     | 0.81       | 0.81       | 1.09        | 1.09     | 1.49        | 1.49     | 1.49        | 1.49         | 2.40        | 2.40     | 0.38                                 | 15                  | 2                  | 7.875                                 |  |  |
| 144  | 116 x 180                   | 13                  | 0.61                          | 0.61     | 0.91       | 0.91       | 1.21        | 1.21     | 1.64        | 1.64     | 1.64        | 1.64         | 2.62        | 2.62     | 0.42                                 | 15                  | 2                  | 8.625                                 |  |  |
| Concrete Strength, psi                         |                             |                     | 4,000                         |          |            | 4,000      |             |          | 4,000       |          |             | 5,000        |             |          | 48 in, 54 in, 60 in 4,000            |                     |                    | 66 in – 144 in 5,000                  |  |  |

Note: Where a stirrup system is shown for a given size, it must be used with the circumferential reinforcement design selected.  
 a. Number of longitudinal lines required in the top and in the bottom portions of the pipe.  
 b. Overall width of each line of stirrups.

| Table 909-6<br>References for Spiral Ribbed and Corrugated Metal Pipes |                                     |                              |                                 |
|--|-------------------------------------|------------------------------|---------------------------------|
| Pipe Material Type   | Driveway Culverts<br>and Downspouts |                              | Sewers                          |
|  | Minimum Design Life                 |                              |                                 |
|  | 25 years                            | 50 years                     | 70 years                        |
| Galvanized Spiral Ribbed Metal Pipe                                    | Table <a href="#">909-8</a>         | 0.109                        | 0.168                           |
| Aluminized Type 2 Spiral Ribbed Metal Pipe                             | Table <a href="#">909-8</a>         | Table <a href="#">909-11</a> | 0.138                           |
| Polymer-Precoated Spiral Ribbed Metal Pipe                             | Table <a href="#">909-8</a>         | Table <a href="#">909-8</a>  | Table <a href="#">909-8</a>     |
| Galvanized Corrugated Metal Pipe                                       | Table <a href="#">909-7</a>         | Table <a href="#">909-9</a>  | 0.168 (a)                       |
| Aluminized Type 2 Corrugated Metal Pipe                                | Table <a href="#">909-7</a>         | Table <a href="#">909-10</a> | 0.138 (a)                       |
| Polymer-Precoated Corrugated Galvanized Pipe                           | Table <a href="#">909-7</a>         | Table <a href="#">909-7</a>  | Table <a href="#">909-7</a> (a) |
| Aluminum pipe  | Table <a href="#">909-12</a>        | Table <a href="#">909-13</a> | Table <a href="#">909-14</a>    |
| Aluminum Spiral Ribbed Pipe  | Table <a href="#">909-15</a>        | Table <a href="#">909-16</a> | Table <a href="#">909-17</a>    |
| Dual Wall Polymer-Precoated Galvanized Corrugated Steel Pipe           | Table <a href="#">909-20</a>        | Table <a href="#">909-20</a> | Table <a href="#">909-20</a>    |

Note: Minimum wall thickness in inches to meet structural and durability requirements for various metal pipes to meet the design life.

Numbers represent the minimum durability gage requirements for the specific pipe material.

Table [909-7](#) represents the minimum structural gauge thickness requirements for corrugated steel pipe.

Table [909-8](#) represents the minimum structural gauge thickness requirements for spiral ribbed steel pipe.

a. Permitted for 12 in to 18 in diameter  $2\frac{2}{3}$  in  $\times$   $\frac{1}{2}$  in helically corrugated pipe only.

**Table 909-7**  
**Wall Thickness Requirements in Inches, Based on Diameter Class of Pipe, and Size of Corrugation**

| Pipe Diameter, (in) | 0 ft – 16 ft                      |                          |                                   |              |                        |                                   | >16 ft – 24 ft         |              |                                   | >24 ft – 32 ft |                        |  |
|---------------------|-----------------------------------|--------------------------|-----------------------------------|--------------|------------------------|-----------------------------------|------------------------|--------------|-----------------------------------|----------------|------------------------|--|
|                     | Corrugation Size, (in)            |                          | Corrugation Size, (in)            |              | Corrugation Size, (in) |                                   | Corrugation Size, (in) |              | Corrugation Size, (in)            |                | Corrugation Size, (in) |  |
|                     | $2\frac{1}{2} \times \frac{1}{2}$ | $3 \times 1, 5 \times 1$ | $2\frac{1}{2} \times \frac{1}{2}$ | $3 \times 1$ | $5 \times 1$           | $2\frac{1}{2} \times \frac{1}{2}$ | $3 \times 1$           | $5 \times 1$ | $2\frac{1}{2} \times \frac{1}{2}$ | $3 \times 1$   | $5 \times 1$           |  |
| 12-30               | 0.064                             | —                        | 0.064                             | —            | —                      | —                                 | —                      | —            | 0.064                             | —              | —                      |  |
| 36-48               | 0.064                             | 0.064                    | 0.064                             | 0.064        | 0.064                  | 0.064                             | 0.064                  | 0.064        | 0.064 <sup>a</sup>                | 0.064          | 0.064                  |  |
| 54                  | 0.079                             | 0.064                    | 0.079                             | 0.064        | 0.064                  | 0.064                             | 0.064                  | 0.064        | 0.079                             | 0.064          | 0.064                  |  |
| 60                  | 0.109                             | 0.064                    | 0.109                             | 0.064        | 0.064                  | 0.064                             | 0.064                  | 0.064        | 0.109                             | 0.064 (a)      | 0.064                  |  |
| 66                  | 0.138                             | 0.064                    | 0.138                             | 0.064        | 0.064                  | 0.064                             | 0.064                  | 0.064        | 0.138                             | 0.064 (a)      | 0.064                  |  |
| 72                  | 0.138                             | 0.064                    | 0.138                             | 0.064 (a)    | 0.064                  | 0.064                             | 0.064 (a)              | 0.064        | 0.138                             | 0.064 (a)      | 0.064                  |  |
| 78                  | 0.168                             | 0.064                    | 0.168                             | 0.064 (a)    | 0.064                  | 0.064                             | 0.064 (a)              | 0.064        | 0.168                             | 0.064 (b)      | 0.064                  |  |
| 84                  | 0.168                             | 0.064                    | 0.168                             | 0.064 (a)    | 0.064                  | 0.064                             | 0.064 (a)              | 0.064        | 0.168                             | 0.064 (b)      | 0.079                  |  |
| 90                  | —                                 | 0.064                    | —                                 | 0.064 (b)    | 0.064                  | 0.064                             | 0.064 (b)              | 0.064        | —                                 | 0.079 (a)      | 0.079                  |  |
| 96                  | —                                 | 0.079                    | —                                 | 0.079 (a)    | 0.079                  | 0.079                             | 0.079 (a)              | 0.079        | —                                 | 0.079 (a)      | 0.079                  |  |
| 102                 | —                                 | 0.079                    | —                                 | 0.079 (a)    | 0.079                  | 0.079                             | 0.079 (a)              | 0.079        | —                                 | 0.079 (a)      | 0.109                  |  |
| 108-120             | —                                 | 0.109                    | —                                 | 0.109        | 0.109                  | 0.109                             | 0.109                  | 0.109        | —                                 | 0.109 (a)      | 0.109                  |  |
| 126                 | —                                 | 0.138                    | —                                 | 0.138        | 0.138                  | 0.138                             | 0.138                  | 0.138        | —                                 | 0.138          | 0.138                  |  |
| 130-136             | —                                 | 0.138                    | —                                 | 0.138        | 0.138                  | 0.138                             | 0.138                  | 0.138        | —                                 | 0.138 (a)      | 0.138                  |  |
| 144                 | —                                 | 0.168                    | —                                 | 0.168        | 0.168                  | 0.168                             | 0.168                  | 0.168        | —                                 | 0.168 (c)      | 0.168                  |  |

Note: For pipe-arch shape corrugated steel pipe, use the gage requirement for the circular pipe equal to or next larger than the span of the pipe-arch.

- Increase the wall thickness by one gage for riveted or spot welded longitudinal seams.
- Increase the wall thickness by two gages for riveted or spot welded longitudinal seams.
- Not allowed for riveted or spot welded longitudinal seams. Riveted or spot welded seams not permitted for 5 in x 1 in corrugations.

**Table 909-8  
Wall Thickness Requirements in Inches Based on Diameter, Class of Pipe, and Size of Ribs**

| Pipe Diameter, (in) | 0 ft – 16 ft   |   | >16 ft – 24 ft                                       |   | >24 ft – 32 ft                                       |   |
|---------------------|--|---|--|---|--|---|
|                     | Corrugation Size, (in)                               |   | Corrugation Size, (in)                               |   | Corrugation Size, (in)                               |   |
|                     | $\frac{3}{4} \times \frac{3}{4} \times 7\frac{1}{2}$ | $\frac{3}{4} \times 1 \times 11\frac{1}{2}$ | $\frac{3}{4} \times \frac{3}{4} \times 7\frac{1}{2}$ | $\frac{3}{4} \times 1 \times 11\frac{1}{2}$ | $\frac{3}{4} \times \frac{3}{4} \times 7\frac{1}{2}$ | $\frac{3}{4} \times 1 \times 11\frac{1}{2}$ |
| 18-36               | 0.064  | 0.064                                       | 0.064  | 0.064                                       | 0.064  | 0.064                                       |
| 42                  | 0.064  | 0.064                                       | 0.064  | 0.064                                       | 0.064  | 0.079                                       |
| 48                  | 0.064  | 0.064                                       | 0.064  | 0.079                                       | 0.064  | 0.079                                       |
| 54                  | 0.079  | 0.064                                       | 0.079  | 0.079                                       | 0.079  | 0.109                                       |
| 60                  | 0.079  | 0.079                                       | 0.079  | 0.079                                       | 0.079  | 0.109                                       |
| 66                  | 0.109  | 0.079                                       | 0.109  | 0.109                                       | 0.109  | 0.109                                       |
| 72-78               | 0.109  | 0.109                                       | 0.109  | 0.109                                       | 0.109  | 0.109                                       |
| 84                  | —  | 0.109                                       | —  | 0.109                                       | —  | 0.109                                       |

Note: For pipe-arch shape corrugated steel pipe, use the gage requirement for the circular pipe equal to or next larger than the span of the pipe-arch.

**Table 909-9  
Wall Thickness Requirements in Inches Based on Class of Pipe and Size of Corrugation**

| Pipe Diameter, (in) | Class A and Class B               |                          | Class C                           |                          | Class D                           |              |
|---------------------|-----------------------------------|--------------------------|-----------------------------------|--------------------------|-----------------------------------|--------------|
|                     | Corrugation Size, (in)            |                          | Corrugation Size, (in)            |                          | Corrugation Size, (in)            |              |
|                     | $2\frac{3}{8} \times \frac{1}{2}$ | $3 \times 1, 5 \times 1$ | $2\frac{3}{8} \times \frac{1}{2}$ | $3 \times 1, 5 \times 1$ | $2\frac{3}{8} \times \frac{1}{2}$ | $3 \times 1$ |
| 12-30               | 0.109                             | —                        | 0.109                             | —                        | 0.109                             | —            |
| 36-60               | 0.109                             | 0.109                    | 0.109                             | 0.109                    | 0.107                             | 0.109        |
| 66-72               | 0.138                             | 0.109                    | 0.138                             | 0.109                    | 0.138                             | 0.109        |
| 78-84               | 0.168                             | 0.109                    | 0.168                             | 0.109                    | 0.168                             | 0.109        |
| 90-102              | —                                 | 0.109                    | —                                 | 0.109                    | —                                 | 0.109        |
| 108-120             | —                                 | 0.109                    | —                                 | 0.109                    | —                                 | 0.109 (a)    |
| 126                 | —                                 | 0.138                    | —                                 | 0.138                    | —                                 | 0.138        |
| 130-136             | —                                 | 0.138                    | —                                 | 0.138                    | —                                 | 0.138 (a)    |
| 144                 | —                                 | 0.168                    | —                                 | 0.168                    | —                                 | 0.168 (b)    |

Note: For pipe-arch shape corrugated steel pipe, use the gage requirement for the circular pipe equal to or next larger than the span of the pipe-arch.

a. Increase the wall thickness by one gage for riveted or spot welded longitudinal seams.

c. Not allowed for riveted or spot welded longitudinal seams. Riveted or spot welded seams not permitted for 5 in x 1 in corrugations.

**Table 909-10  
Wall Thickness Requirements in Inches Based on Diameter, Class of Pipe and Size of Corrugation**

| Pipe Diameter, (in) | Class A and B          |              | Class C                |          |       | Class D                |          |       |
|---------------------|------------------------|--------------|------------------------|----------|-------|------------------------|----------|-------|
|                     | Corrugation Size, (in) |              | Corrugation Size, (in) |          |       | Corrugation Size, (in) |          |       |
|                     | 2½ x ½                 | 3 x 1, 5 x 1 | 2½ x ½                 | 3 x 1    | 5 x 1 | 2½ x ½                 | 3 x 1    | 5 x 1 |
| 12-30               | 0.079                  | —            | 0.079                  | —        | —     | 0.079                  | —        | —     |
| 36-54               | 0.079                  | 0.079        | 0.079                  | 0.079    | 0.079 | 0.079                  | 0.079    | 0.079 |
| 60                  | 0.109                  | 0.079        | 0.109                  | 0.079    | 0.079 | 0.109                  | 0.079    | 0.079 |
| 66-72               | 0.138                  | 0.079        | 0.138                  | 0.079    | 0.079 | 0.138                  | 0.079    | 0.079 |
| 78-84               | 0.168                  | 0.079        | 0.168                  | 0.079    | 0.079 | 0.168                  | 0.079(a) | 0.079 |
| 90-96               | —                      | 0.079        | —                      | 0.079(a) | 0.079 | —                      | 0.079(a) | 0.079 |
| 102                 | —                      | 0.079        | —                      | 0.079(a) | 0.079 | —                      | 0.079(a) | 0.109 |
| 108-120             | —                      | 0.109        | —                      | 0.109    | 0.109 | —                      | 0.109(a) | 0.109 |
| 126                 | —                      | 0.138        | —                      | 0.138    | 0.138 | —                      | 0.138    | 0.138 |
| 130-136             | —                      | 0.138        | —                      | 0.138    | 0.138 | —                      | 0.138(a) | 0.138 |
| 144                 | —                      | 0.168        | —                      | 0.168    | 0.168 | —                      | 0.168(b) | 0.168 |

Note: For pipe-arch shape corrugated steel pipe, use the gage requirement for the circular pipe equal to or next larger than the span of the pipe-arch.

a. Increase the wall thickness by one gage for riveted or spot welded longitudinal seams.

b. Not allowed for riveted or spot welded longitudinal seams. Riveted or spot welded seams not permitted for 5 in x 1 in corrugations.



**Table 909-11**  
**Wall Thickness Requirements in Inches Based on Diameter, Class of Pipe, and Size of Ribs**

| Pipe Diameter, (in) | Class A and B  |   | Class C  |   | Class D  |   |
|---------------------|--|---|--|---|--|---|
|                     | Corrugation Size, (in)                               |   | Corrugation Size, (in)                               |   | Corrugation Size, (in)                               |   |
|                     | $\frac{3}{4} \times \frac{3}{4} \times 7\frac{1}{2}$ | $\frac{3}{4} \times 1 \times 11\frac{1}{2}$ | $\frac{3}{4} \times \frac{3}{4} \times 7\frac{1}{2}$ | $\frac{3}{4} \times 1 \times 11\frac{1}{2}$ | $\frac{3}{4} \times \frac{3}{4} \times 7\frac{1}{2}$ | $\frac{3}{4} \times 1 \times 11\frac{1}{2}$ |
| 18-48               | 0.079  | 0.079                                       | 0.079  | 0.079                                       | 0.079  | 0.079                                       |
| 54-60               | 0.079  | 0.079                                       | 0.079  | 0.079                                       | 0.079  | 0.109                                       |
| 66-78               | 0.109  | 0.109                                       | 0.109  | 0.109                                       | 0.109  | 0.109                                       |
| 84                  | —  | 0.109                                       | —  | 0.109                                       | —  | 0.109                                       |

Note: For pipe-arch shape corrugated steel pipe, use the gage requirement for the circular pipe equal to or next larger than the span of the pipe-arch.

**Table 909-12**  
**Wall Thickness Requirements in Inches, Based on Class of Pipe and Size of Corrugation, Lock Seam Pipe Only**

| Pipe Diameter, (in) | 0 ft - 16 ft                      |       | >16 ft - 24 ft                    |       | >24 ft - 32 ft                    |       |
|---------------------|-----------------------------------|-------|-----------------------------------|-------|-----------------------------------|-------|
|                     | Corrugation Size, (in)            |       | Corrugation Size, (in)            |       | Corrugation Size, (in)            |       |
|                     | $2\frac{1}{2} \times \frac{1}{2}$ | 3 x 1 | $2\frac{1}{2} \times \frac{1}{2}$ | 3 x 1 | $2\frac{1}{2} \times \frac{1}{2}$ | 3 x 1 |
| 12-27               | 0.060                             | 0.060 | 0.060                             | 0.060 | 0.060                             | 0.060 |
| 30-36               | 0.075                             | 0.060 | 0.075                             | 0.060 | 0.075                             | 0.060 |
| 42-54               | 0.105                             | 0.060 | 0.105                             | 0.060 | 0.105                             | 0.060 |
| 60                  | 0.135                             | 0.075 | 0.135                             | 0.075 | 0.135                             | 0.075 |
| 66-72               | 0.164                             | 0.075 | 0.164                             | 0.075 | 0.164                             | 0.075 |
| 78                  | —                                 | 0.075 | —                                 | 0.075 | —                                 | 0.075 |
| 84-96               | —                                 | 0.105 | —                                 | 0.105 | —                                 | 0.105 |
| 102-108             | —                                 | 0.135 | —                                 | 0.135 | —                                 | 0.135 |
| 112-120             | —                                 | 0.164 | —                                 | 0.164 | —                                 | 0.164 |

Note: For pipe-arch shape corrugated aluminum pipe, use the gage requirement for the circular pipe equal to or next larger than the span of the pipe-arch.

| <b>Table 909-13</b>   |                                      |              |
|---|--------------------------------------|--------------|
| <b>Wall Thickness Requirements in Inches, Based on Class of Pipe and Size of Corrugation, Lock Seam Pipe Only</b> |                                      |              |
| <b>Pipe Diameter, (in)</b>  | <b>Class A, B, C, D</b>              |              |
|   | <b>Corrugation Size, (in)</b>        |              |
|   | <b>2<math>\frac{2}{3}</math> × ½</b> | <b>3 × 1</b> |
| 12–36   | 0.075                                | 0.075        |
| 42–54   | 0.105                                | 0.075        |
| 60  | 0.135                                | 0.075        |
| 66–72   | 0.164                                | 0.075        |
| 78  | —                                    | 0.075        |
| 84–96   | —                                    | 0.105        |
| 102–108   | —                                    | 0.135        |
| 112–120   | —                                    | 0.164        |

Note: For pipe-arch shape corrugated aluminum pipe, use the gage requirement for the circular pipe equal to or next larger than the span of the pipe-arch.

| <b>Table 909-14</b>   |                                      |              |
|---|--------------------------------------|--------------|
| <b>Wall Thickness Requirements in Inches, Based on Class of Pipe and Size of Corrugation, Lock Seam Pipe Only</b> |                                      |              |
| <b>Pipe Diameter, (in)</b>  | <b>Class A, B, C, D</b>              |              |
|   | <b>Corrugation Size, (in)</b>        |              |
|   | <b>2<math>\frac{2}{3}</math> × ½</b> | <b>3 × 1</b> |
| 12–54   | 0.105                                | 0.105        |
| 60  | 0.135                                | 0.105        |
| 66–72   | 0.164                                | 0.105        |
| 78–96   | —                                    | 0.105        |
| 102–108   | —                                    | 0.135        |
| 112–120   | —                                    | 0.164        |

Note: For pipe-arch shape corrugated aluminum pipe, use the gauge requirement for the circular pipe equal to or next larger than the span of the pipe-arch.

| <b>Table 909-15</b>  |   |
|--|---|
| <b>Wall Thickness Requirements in Inches, Based on Diameter, Class of Pipe, and Size of Rib, Lock Seam Pipe Only</b> |   |
| <b>Pipe Diameter, (in)</b>   | <b>Class F</b>  |
|  | <b><math>\frac{3}{4}</math> × <math>\frac{3}{4}</math> × 7½</b> |
| 18–24  | 0.060   |
| 30–36  | 0.075   |
| 42–54  | 0.105   |
| 60–66  | 0.135   |

Note: For pipe-arch shape corrugated aluminum pipe, use the gage requirement for the circular pipe equal to or next larger than the span of the pipe-arch.

| <b>Table 909-16</b>  |  |
|--|--|
| <b>Wall Thickness Requirements in inches, Based on Diameter, Class of Pipe, and Size of Rib, Lock Seam Pipe Only</b> |  |
| <b>Pipe Diameter, (in)</b>   | <b>Class A, B, C, D</b>                              |
|  | $\frac{3}{4} \times \frac{3}{4} \times 7\frac{1}{2}$ |
| 18–36  | 0.075  |
| 42–54  | 0.105  |
| 60–66  | 0.135  |

Note: For pipe-arch shape corrugated aluminum pipe, use the gage requirement for the circular pipe equal to or next larger than the span of the pipe-arch.

| <b>Table 909-17</b>  |  |
|--|--|
| <b>Wall Thickness Requirements in Inches, Based on Diameter, Class of Pipe, and Size of Rib, Lock Seam Pipe Only</b> |  |
| <b>Pipe Diameter, (in)</b>   | <b>Class A, B, C, D</b>                              |
|  | $\frac{3}{4} \times \frac{3}{4} \times 7\frac{1}{2}$ |
| 18–54  | 0.105  |
| 60–66  | 0.135  |

Note: For pipe-arch shape corrugated aluminum pipe, use the gage requirement for the circular pipe equal to or next larger than the span of the pipe-arch.

| <b>Table 909-18</b>   |                                 |                       |
|---|---------------------------------|-----------------------|
| <b>Nominal OD and Wall Thickness in Inches Jacked In Place Steel Pipe</b> |                                 |                       |
| <b>Nominal Size</b>   | <b>Nominal Outside Diameter</b> | <b>Wall Thickness</b> |
| 2   | 2.375                           | 0.154                 |
| 4   | 4.500                           | 0.188                 |
| 6   | 6.625                           | 0.188                 |
| 8   | 8.625                           | 0.188                 |
| 10  | 10.750                          | 0.188                 |
| 12  | 12.750                          | 0.188                 |
| 14  | 14.000                          | 0.250                 |
| 16  | 16.000                          | 0.250                 |
| 18  | 18.000                          | 0.250                 |
| 20  | 20.000                          | 0.250                 |
| 24  | 24.000                          | 0.250                 |
| 30  | 30.000                          | 0.312                 |
| 36  | 36.000                          | 0.312                 |
| 42  | 42.000                          | 0.438                 |
| 48  | 48.000                          | 0.500                 |
| 54  | 54.000                          | 0.563                 |

| Sheet Gauge Number | Nominal Thickness |                |
|--------------------|-------------------|----------------|
|                    | Galvanized        | Aluminum Alloy |
| 18                 | 0.052             | 0.048          |
| 16                 | 0.064             | 0.060          |
| 14                 | 0.079             | 0.075          |
| 12                 | 0.109             | 0.105          |
| 10                 | 0.138             | 0.135          |
| 8                  | 0.168             | 0.164          |
| 7                  | 0.188             | —              |
| 5                  | 0.218             | —              |
| 3                  | 0.249             | —              |
| 1                  | 0.280             | —              |

| Diameter of Pipe, (in) | Corrugation Size, (in)            |       | Corrugation Size, (in) |       |
|------------------------|-----------------------------------|-------|------------------------|-------|
|                        | $2\frac{3}{8} \times \frac{1}{2}$ |       | $3 \times 1$           |       |
|                        | Shell                             | Liner | Shell                  | Liner |
| 36–48                  | 0.064                             | 0.052 | 0.064                  | 0.052 |
| 54                     | 0.079                             | 0.052 | 0.064                  | 0.052 |
| 60                     | 0.109                             | 0.052 | 0.064                  | 0.052 |
| 66–72                  | 0.138                             | 0.052 | 0.064                  | 0.052 |
| 78–84                  | 0.168                             | 0.052 | 0.064                  | 0.052 |
| 90–102                 | —                                 | —     | 0.079                  | 0.052 |
| 108–120                | —                                 | —     | 0.109                  | 0.052 |
| 126–136                | —                                 | —     | 0.138                  | 0.052 |
| 144                    | —                                 | —     | 0.168                  | 0.052 |

## Section 910. GEOSYNTHETICS

**910.01. General Requirements.** Geosynthetics must be composed of long-chain synthetic fiber of at least 85 percent, by weight, polyolefins or polyesters. Geosynthetics must be capable of resisting degradation from chemicals, mildew, rot, and ultraviolet (UV) light.

Deliver and store geosynthetics in packaging capable of resisting UV radiation, contaminants, and moisture. Label each unit of material with product information including supplier and lot identification. Do not expose geosynthetics to direct sunlight for prolonged periods. Repair or replace damaged geosynthetics at no additional cost to the Department.

**910.02. Testing.** Geosynthetic testing will be in accordance with the specified ASTM, or Department methods, as modified by this section.

Geotextiles must meet the minimum physical property requirements shown in Table [910-1](#). The directional property values listed in Table [910-1](#) specify values for the weaker principle direction.

**910.03. Geotextiles.** Geotextiles are flexible, permeable fabrics, consisting of synthetic fibers or yarns oriented into a dimensionally stable network. Woven geotextiles must have sealed or selvaged edges to prevent raveling.

**A. Geotextile Blanket.** Geotextile for filtration applications, including trench lining, ditch lining, streambed protection, pipe wrap, joint wrap, drainhole and weephole filter, granular blanket separation, and filter bags must be non-woven and meet the requirements shown in Table [910-1](#) for geotextile blanket.

**B. Geotextile Liner.** Geotextile for erosion control in riprap and similar applications must be non-woven and meet the requirements shown in Table [910-1](#) for geotextile liner. Geotextile for use with heavy riprap must be non-woven and meet the requirements shown in Table [910-1](#) for heavy geotextile liner.

**C. Geotextile Separator.** Geotextile used to prevent intermixing of dissimilar aggregate or soil layers must meet the requirements shown in Table [910-1](#) for geotextile separator. Geotextiles separators with grab tensile elongation-at-break less than 50 percent must meet the requirements shown in Table [910-1](#) for woven geotextile separator. Geotextiles with grab tensile elongation-at-break equal to or greater than 50 percent must meet the strength requirements shown in Table [910-1](#) for non-woven geotextile separator.

D. **Stabilization Geotextile.** Geotextile used to prevent intermixing of soft subgrade and subbase materials must meet the requirements shown in Table [910-1](#) for stabilization geotextile.

**910.04. Silt Fence Geotextile.** Select geotextile for fabricating silt fence from the Qualified Products List. Geotextile for silt fence must have a nominal height of 3 feet and must meet the requirements shown in Table [910-1](#) for silt fence. Geotextile for silt fence must have a retained strength of at least 70 percent after 500 hours of UV exposure, when tested in accordance with ASTM D 4355.

**910.05. Drainage Geocomposites.** Drainage geocomposites must meet the requirements shown in Table [910-1](#) and this subsection.

Prefabricated geocomposites for drainage applications must consist of a geotextile bonded to or wrapped around a polymer core having corrugated, dimpled, tubular, or net (mesh) configurations. Geocomposites must have sufficient flexibility and durability to withstand installation, handling, and permanent loading stresses.

Fittings for geocomposite installations must be manufactured by the geocomposite manufacturer or meet the published specifications of the geocomposite manufacturer. Tape used to seal connections must be manufactured with adhesive resistant to moisture and organic growth and recommended by the manufacturer for underground service conditions.

Obtain the Engineer's approval for all components of the geocomposite system before installation.

A. **Prefabricated Drainage System (PDS).** PDS for underdrain applications must consist of a polymer core, completely wrapped with geotextile.

The geotextile must be tightly stretched around the core and bonded to itself, to the core, or both. Geotextile must have a peel strength of at least 35 pounds per foot when tested in accordance with ASTM D 1876. Core must be at least 1 inch thick and allow transverse flow from both directions. The geocomposite must have a crush strength of at least 6,000 pounds per square foot at no greater than 18 percent deformation, when tested in accordance with [MTM 411](#).

B. **Wall Drain.** Wall drains for single direction cross-planar flow must consist of an impermeable polymer core, with geotextile bonded to one side. The geocomposite must have a minimum crush strength of 4,000 pounds per square foot at no more than 18 percent deformation when tested according to [MTM 411](#).

C. **Geocomposite Net.** The Engineer may allow geocomposite net consisting of geotextile blanket bonded to both sides of a mesh core as an alternate to open-graded aggregate drainage layers.

The Engineer will approve the geocomposite net based on durability, drainage capacity, crush resistance, tensile strength, and thickness.

**Table 910-1  
Physical Requirements for Geotextiles**

| Geotextile Category                              | Property                         |                                    |                              |                                       |                         |                                  |
|--|----------------------------------|------------------------------------|------------------------------|---------------------------------------|-------------------------|----------------------------------|
|  | Grab Tensile Strength (min) (lb) | Trapezoid Tear Strength (min) (lb) | Puncture Strength (min) (lb) | Mullen Burst Strength (min) (psi) (a) | Permittivity per second | Apparent Opening Size (max) (mm) |
|  | Test Method                      |                                    |                              |                                       |                         |                                  |
| <b>ASTM D 4632</b>                               | <b>ASTM D 4533</b>               | <b>ASTM D 4833</b>                 | <b>ASTM D 3786</b>           | <b>ASTM D 4491</b>                    | <b>ASTM D 4751 (b)</b>  |                                  |
| Geotextile Blanket (c)                           | 45                               | 45                                 | 140                          | 0.5                                   | 0.21                    |                                  |
| Geotextile Liner                                 | 75                               | 75                                 | 200                          | 0.5                                   | 0.21                    |                                  |
| Heavy Geotextile Liner                           | 100                              | 100                                | 400                          | 0.5                                   | 0.21                    |                                  |
| Woven Geotextile Separator (<50% elongation)     | 100                              | 100                                | 400                          | 0.05                                  | 0.425                   |                                  |
| Non-Woven Geotextile Separator (>50% elongation) | 75                               | 75                                 | 200                          | 0.05                                  | 0.425                   |                                  |
| Stabilization Geotextile                         | 100                              | 100                                | 400                          | 0.05                                  | 0.50                    |                                  |
| Silt Fence                                       | 45                               | —                                  | —                            | 0.1                                   | 0.60                    |                                  |
| Drainage Geocomposites (e)                       | 45                               | 65 (e)                             | 200 (e)                      | 0.5                                   | 0.21                    |                                  |

a. ASTM D 3786-87. The fluid displacement rate for the Mullen burst test equipment must be 170 mL/min  $\pm$ 5 mL/min. Subtract tare strength from the ultimate burst strength as specified in ASTM.

b. The Engineer will allow filtration opening size (FOS, Canadian General Standards Board, method 148.1 No. 10) as an alternate test method to ASTM D 4751 for non-woven geotextiles.

c. For pipe wrap where backfill around the pipe meets granular material Class II requirements; geotextiles, including knitted polyester sock, which meet the following minimum requirements in the applied condition are permitted: Mass/Unit Area: 3.0 oz/yd<sup>2</sup>, Mullen burst strength: 100 psi; maximum apparent opening size must be 0.30 mm for pavement and foundation underdrains, and 0.60 mm in other areas.

d. Elongation at the specified grab tensile strength no greater than 40% for silt fence.

e. Geotextile placed over a continuous tubular core must have at least 100 psi Mullen burst strength and 40 lb minimum puncture strength.



**Section 911. WATER**

**911.01. General Requirements.** Water used in concrete, mortar, and grout, or for curing concrete must be clean and free of oil, salt, acid, alkali, organic matter, or other deleterious material. Use a water intake filter to remove silt, mud, grass, or other deleterious material.

Water used for turf and landscape plantings must be from a potable or non-potable water source approved by the Engineer.

**911.02. Testing.** Potable water, from sources approved by the State Department of Public Health, is acceptable for use for concrete, mortar, grout, or for curing concrete, without testing.

Non-potable water used for concrete, mortar, grout, or for curing concrete, must be tested in accordance with AASHTO T 26 and must meet the requirements of Table 911-1.

| <b>Table 911-1<br/>Non-Potable Water Requirements</b> |                      |
|---|----------------------|
| <b>Property</b>                                       | <b>Specification</b> |
| Total Solids (TS)                                     | ≤0.30%               |
| Total Organic Content (TOC)                           | ≤0.05%               |
| Alkalinity-Acidity (pH)                               | 6.5 – 7.5            |

## Section 912. TIMBER AND LUMBER

**912.01. General Requirements.** Timber and lumber, timber piles, posts and blocks for guardrails, sign posts, mailbox posts, guard posts, guide posts, fence posts, and timber for rustic construction must meet the requirements of this section.

In case of a conflict between the AWPAs and ASTM Standards, the AWPAs take precedence.

Machine or manufacture material, including bored holes, saw cuts, routs, and kerfs, to the required shape before applying preservative treatment.

Manufacture material from the wood species specified. The commercial and common names for domestic hardwood and softwood timber and lumber referenced in this section are as specified in ASTM D 1165.

### 912.02. Quality Control.

**A. General.** The supplier is responsible for quality control and inspection of material. Material must be graded before shipment in accordance with the grading rules of ASTM D 245 and marked with the approved grading agency stamp showing the mill origin, species, and grade. The required grading agency stamp or marking must be legible on a wide face at the trimmed end before and after treating.

**B. Inspection Prior to Preservative Treatment.** Before treating timber and lumber, inspect material for quality, size, and straightness. This inspection does not waive the Department's right to inspection and rejection of material in accordance with subsection [105.05](#).

**C. Inspection of Preservative Treatment.** Inspect chemical preservatives, treatment processes, and treated material in accordance with AWPAs M 2, "Standard for Inspection of Treated Timber Products," and M 3, "Standard Quality Control Procedures for Wood Preserving Plants," and other relevant AWPAs Standards. The treater must determine if the preservatives used conform to the requirements.

For single treatment charges, analyze the preservative at least once per charge. For consecutive treatments from the same working tank, analyze the first charge and at least one of every five additional charges, selected at random.

Collect preservative samples that are representative of the solution used in the actual treatment process.

**D. Results of Treatment.** Ensure the treatment results, including preservative analysis and penetration and retention determinations, meet AWWPA Standards.

**E. Inspection Records.** Provide a signed inspection certificate for each material shipment. Provide copies of treatment records, analysis records and other records ensuring that the treatment conforms to specification requirements to Department personnel or their designated representatives upon request. Retain the records at the treatment plant for at least 5 years from the date the material is shipped to the project. Refer to AWWPA M 2 for required information.

**F. Painting Treated Wood.** Air-season wood for at least 30 days and remove preservative dust from the wood before painting.

### **912.03. Field Treatment of Preservative Treated Material.**

**A. General.** Field-treat saw cuts, routs, kerfs, holes, and other injuries to preservative-treated material occurring after pressure treatment by brushing, dipping, soaking, or coating. Do not spray. Saturate injuries with the field-treating solution. Fill bored holes with preservative.

The Contractor may fill horizontal holes by temporarily plugging one end of a hole and using a bent funnel to pour preservative into the other end of the hole.

**B. Preservative.** Use a 2.0 percent solution of copper naphthenate, based on copper as metal, meeting the requirements for AWWPA Standard M4 for field treatment. Ensure a State of Michigan Certified Commercial Pesticide Applicator applies the copper naphthenate.

### **912.04. Terminology Used in Timber and Lumber Specifications.**

Refer to ASTM D 9, Standard Terminology Relating to Wood, and AWWPA M 5, Glossary of Terms Used in Wood Preservation for additional wood and wood preservation terms.

**Annual Ring.** The growth layer produced by the tree in a single growth year, including earlywood and latewood.

**Bark.** The layer of a tree, outside the cambium, comprising the inner bark, or thin, inner living part (phloem), and the outer bark, or corky layer, composed of dry, dead tissue.

**Bird Peck.** A small hole or patch of distorted grain resulting from birds pecking through the growing cells in the tree. Bird peck usually resembles a carpet tack with the point toward the bark, and it is usually accompanied by discoloration extending for a

considerable distance along the grain and to a much lesser extent across the grain. The discoloration produced by bird peck causes what is commonly known as mineral streak.

**Boxed Heart.** The term used when the pith falls entirely within the four faces of a piece of wood anywhere in its length. Also called boxed pith.

**Check.** A lengthwise separation of the wood that usually extends across the rings of annual growth and commonly results from stresses set up in wood during seasoning. Checks are measured as an average of the penetration perpendicular to the wide face. Where two or more checks appear on the same face, only the deepest one is measured. Where two checks are directly opposite each other, the sum of their depths is used.

**Contiguous Checks.** Individual checks that are adjoining though not in contact with adjacent checks.

**Crook or Sweep.** A distortion of a piece of lumber or post in which there is a deviation in a direction perpendicular to the edge from a straight line from end to end of the piece.

**Decay.** The decomposition of wood substance caused by action of wood destroying fungi, resulting in softening, loss of strength and weight and often in change of texture and color.

**Advanced (or typical) Decay.** The older stage of decay in which the destruction is readily recognized because the wood has become punky, soft and spongy, stringy, ring-shaked, pitted, or crumbly. Decided discoloration or bleaching of the rotted wood is often apparent.

**Incipient Decay.** The early stage of decay that has not proceeded far enough to soften or otherwise perceptibly impair the hardness of the wood. It is usually accompanied by a slight discoloration or bleaching of the wood.

**Defect.** Any irregularity or imperfection occurring in or on the wood that may lower its durability or strength.

**Grain.** The direction, size, arrangement, appearance, or quality of the fibers in wood or lumber.

**Heartwood.** The wood extending from the pith to the sapwood, the cells of which no longer participate in the life processes of the tree. Heartwood may be infiltrated with gums, resins, and other

materials that usually make it darker and more decay resistant than sapwood.

**Knot.** That portion of a branch or limb that has been surrounded by subsequent growth of the wood of the trunk or other portion of the tree. As a knot appears on the sawed surface it is merely a section of the entire knot, its shape depending upon the direction of the cut. Knot diameter is measured as shown. The least dimension is used to determine size of the knot.

**Knot Cluster.** Three or more knots in a compact, roughly circular group, with the grain between them highly contorted. Two or more knots laterally arranged and without contortion of the fibers between them do not constitute a knot cluster.

**Loose Knot.** A knot that is not held firmly in place by growth or position and that cannot be relied upon to remain in place.

**Sound Knot.** A knot that is solid across its face, at least as hard as the surrounding wood, and shows no indication of decay.

**Unsound Knot.** A knot that, due to decay, is softer than the surrounding wood.

**Mineral Streak.** An olive to greenish-black or brown discoloration of undetermined cause in hardwoods, particularly hard maples; commonly associated with bird pecks and other injuries; occurs in streaks usually containing accumulations of mineral matter.

**Peeling (clean).** The removal of all outer bark and at least 80 percent of the inner bark distributed over the surface of the post, pile, or block.

**Pith.** The small, soft core occurring in the structural center of a tree trunk, branch, twig, or log.

**Plugged Hole.** Any opening, or defect, which has been filled, or repaired, through the use of wooden plugs, plastic wood, or other methods. Holes resulting from the taking of test cores by an increment borer to check penetration or retention of preservative and filled with tight-fitting pressure treated plugs are not considered as plugged holes for rejection purposes.

**Sapwood.** The living wood of pale color near the outside of the log. Under most conditions the sapwood is more susceptible to decay than heartwood.

**Shake.** A separation along the grain, the greater part of which occurs between the rings of annual growth. Shakes are

measured at the ends of pieces between lines parallel with the two faces that give the least dimension.

**Slope of Grain.** Slope of grain is the deviation of the wood fiber from a line parallel to the edges of a piece. The deviation is expressed as a ratio such as a slope of grain of one in eight. Generally, slope of grain is measured over sufficient length and area to be representative of the general slope of the fibers, disregarding local variations.

**Split.** A lengthwise separation of the wood extending through the piece from one surface to an opposite or to an adjoining surface, due to the tearing apart of wood cells. Splits are measured as the penetration of a split from the end of the piece and parallel to edges of the piece.

**Twist.** A distortion caused by the turning or winding of the edges of a board so the four corners of any face are no longer in the same plane.

**Unightly Gaps.** The term as used in these specifications is interpreted as being any gap, or opening that is more than  $\frac{3}{8}$  inch at its maximum width and more than 12 inches long.

**Wane.** Bark, or lack of wood from any cause, on edge or corner of piece.

### 912.05. Structural Timber and Lumber.

A. **Grade.** Provide structural timber and lumber of the grade required, as determined by the grading and dressing requirements of ASTM D 245.

B. **Species.** Use species specifically included in AWPA U1, Section 5, Table UCS-U1, for UCS listing UC4C.

C. **Preservative Treatment.** Condition and treat structural timber and lumber in accordance with AWPA U1, Section 6, Commodity Specification A. Refer to Use Category 4A (UC4A) for above ground requirements and Use Category 4C (UC4C) for ground contact requirements.

D. **Preservatives.** Provide preservatives for treatment meeting the requirements of AWPA U1, Section 4, "Preservatives for Pressure Treatment Processes," and the relevant P Standards.

## 912.06. Timber Piles.

**A. Physical Characteristics and Species.** Provide timber piles of southern pine, red pine, jack pine, ponderosa pine, Douglas fir, western larch, lodgepole pine, or red oak. Before applying preservative treatment, ensure timber piles meet the requirements of ASTM D 25, "Standard Specifications for Round Timber Piles," except as modified by this subsection.

**B. Dimensions.** Ensure the pile circumference measured under the bark meets the requirements of Table 912-1, except 10 percent of the piles in a shipment lot may have circumferences 2 inches less than the minimum values. Ensure piles do not exceed the 1:2 maximum to minimum diameter ratio measured at the butt of the pile.

| Table 912-1<br>Circumferences and Diameters of Timber Piles |   |                   |                             |                   |                             |                   |
|---|---|-------------------|-----------------------------|-------------------|-----------------------------|-------------------|
| Length,<br>(ft)   | 3 ft from Butt  |                   |                             |                   | At Tip                      |                   |
|   | Minimum   |                   | Maximum                     |                   | Minimum                     |                   |
|   | Circum-<br>ference,<br>(in)                                     | Diameter,<br>(in) | Circum-<br>ference,<br>(in) | Diameter,<br>(in) | Circum-<br>ference,<br>(in) | Diameter,<br>(in) |
| Douglas Fir, Larch, Pine, or Tamarack                       |   |                   |                             |                   |                             |                   |
| <40   | 38  | 12                | 63                          | 20                | 25                          | 8                 |
| 40-50   | 38  | 12                | 63                          | 20                | 22                          | 7                 |
| ≥50-70  | 41  | 13                | 63                          | 20                | 22                          | 7                 |
| ≥70-90  | 41  | 13                | 63                          | 20                | 19                          | 6                 |
| >90   | Dimensions must be as specified in the proposal or on the plans |                   |                             |                   |                             |                   |
| Oak and Cypress   |   |                   |                             |                   |                             |                   |
| <30   | 38  | 12                | 57                          | 18                | 25                          | 8                 |
| 30-40   | 41  | 13                | 63                          | 20                | 22                          | 7                 |
| >40   | 41  | 13                | 63                          | 20                | 19                          | 6                 |

**C. Sapwood.** Provide piles with a sapwood thickness of at least 1 inch at the butt end.

**D. Straightness.** Use straight piles, as determined by drawing a line from the center of the butt to the center of the tip, and ensuring the line lies within the pile body. Only use piles with a uniform taper from butt to top and without short crooks.

**E. Knots.** Provide piles free of unsound and loose knots. Piles may contain sound knots no greater than 4 inches in diameter or one-third of the shortest pile dimension at the knot location, except for piles used as structural members in exposed work. Ensure piles used as structural members in exposed work do not contain sound knots with diameters greater than one-quarter of the shortest pile dimension at the knot location.

F. **Checks.** Do not use piles with checks wider than ¼ inch or deeper than 2 inches.

G. **Peeling (Shaving).** Piles must meet the requirements for clean-peeled posts as specified by subsection [912.07.I](#).

H. **Preservative Treatment.** Perform preservative treatment of timber piling in accordance with the AWPA Use Category UC4C for foundation, land, and fresh water exposure. Submit certification from the treatment plant stating type, pressure process used, net amount of preservative retained, and compliance with relevant standards to the Engineer. Preservative penetration and retention must meet the requirements of AWPA U1 Table 3.0, Use Category 4 (UC4C).

I. **Preservatives.** Provide preservatives for treatment meeting the requirements of AWPA Standard U1 Section 4, "Preservatives for Pressure Treatment Processes," and the applicable P Standards.

### 912.07. Timber Posts.

A. **General.** Use posts cut from live timber without bird pecks or insect holes. Saw post ends square.

B. **Species and Grades.** Provide fence posts, guide posts, guard posts, and mailbox posts manufactured from the species specified in Table 912-2.

| Table 912-2<br>Species and Grading Requirements for Posts   |                      |                             |
|---|----------------------|-----------------------------|
| Species   | Round Posts<br>Grade | Grading Rules<br>Agency (a) |
| <b>Hardwoods</b>  |                      |                             |
| Red Oak (Northern Red, Black, Pin Laurel, Cherry-Bark, Scarlet, Water, and Willow Oaks) (b)   | ASTM D 245           | MDOT                        |
| Hard Maple (Black & Sugar) and Red Maple  |                      |                             |
| White Ash   |                      |                             |
| White-Heartwood Beech   |                      |                             |
| Yellow Birch  |                      |                             |
| <b>Softwoods</b>  |                      |                             |
| Northern White Cedar, Red Pine, and Eastern White Pine (Northern White Pine)  | No. 1 or better      | NHPMA                       |
| Douglas-fir   | No. 2 or better      | WCLIB, WWPA                 |
| Southern Pine Species   | No. 2 or better      | SPIB                        |
| a. NHPMA (Northern Hardwood and Pine Manufacturers Assoc.); WWPA (Western Wood Products Assoc.); WCLIB (West Coast Lumber Inspection Bureau); and SPIB (Southern Pine Inspection Bureau)<br>b. Southern Red Oak is not permitted. |                      |                             |



C. **Marking.** Ensure posts show the grading agency stamp indicating the mill origin, species, and grade.

D. **Dimensions.** Provide 7 foot long line posts with a nominal 4 inch square cross section or a round cross section with a diameter of at least 4½ inches.

Provide 8 foot long end, corner, gate, intersection, and intermediate braced posts with a nominal 6 inch square cross section or a round cross section with a diameter of at least 8 inches.

Provide mailbox posts at least 6 feet long with a nominal 4 inch square cross section or a round cross section with a diameter of at least 4 inches.

E. **Dimensional Tolerances.** Provide round posts within +¼ inch and -¼ inch of the required diameter. Ensure posts are equal to the required nominal length ±2 inches. Use the average top diameter to determine the sizes of posts that are not perfectly round. Provide square posts within -¼ inch of the required cross section.

F. **Decay.** Do not provide posts with butt rot in greater than 5 percent of the butt area. Ensure post tops are sound, except the Engineer may allow one pipe rot no greater than ⅜ inch in diameter in posts with a nominal top size of at least 6 inches.

G. **Knots.** Posts may contain sound knots trimmed flush with the post surface that do not affect the post strength.

H. **Crook or Bow.** Do not provide posts with short crooks, one-way sweep greater than 2 inches, and unsightly and exaggerated winding twists.

I. **Surface.** Provide fence posts that are peeled or shaved to remove the outer bark from the entire length. The Engineer will not require shaving to remove the inner bark.

For round posts for mailbox posts, guard posts, and guide posts, ensure the inner and outer bark is completely removed.

J. **Preservative Treatment.** Condition and treat round posts, except northern white cedar, in accordance with AWWA U1, Section 6, Commodity Specification B, Use Category 4B (UC4B). Treat sawn posts as specified in subsection [912.05.C](#).

K. **Conditioning.** If air seasoned, stack posts in a Department-approved manner until the average moisture content is no greater than 19 percent.

L. **Preservatives.** Provide treatment preservatives meeting the requirements of AWWA U1, Section 4, "Preservatives for Pressure Treatment Processes," and the relevant P Standards.

M. **Results of Treatment.** Refer to Table 912-3 for the minimum preservative penetration and retention, as determined in accordance with AWWA Standards.

| Table 912-3<br>Treatment Results Requirements |  |  |
|---|--|--|
| Preservative                                  | Minimum Retention<br>0.0 – 0.6 in zone | AWPA Standard                          |
| Oil Type                                      | AWPA Commodity Specification B         | A 6                                    |
| Waterborne Type                               | Table 3.1.2, Use category 4B           | A 11                                   |
| Minimum Penetration                           |  |  |
| Species                                       | Heartwood                              | Sapwood                                |
| Hardwoods & Douglas-fir                       | ≥0.3 in                                | 0.6 in or 90%,<br>whichever is greater |
| Softwoods                                     | —                                      | 2.0 in or 90%,<br>whichever is greater |

### 912.08. Sawn Timber Posts and Blocks for Beam Guardrail and Highway Signs.

A. **Species and Grades.** Provide wood posts for guardrail in accordance with Table 912-4; for wood blocks in accordance with Table 912-5; and for sign posts in accordance with Table 912-6. Ensure the grading agency stamp is applied to the middle one-third of each sign post on the wider face.

| Table 912-4<br>Species and Grading Requirements for Sawn Timber Guardrail Posts              |                      |                      |
|--|----------------------|----------------------|
| Species  | Posts & Timber Grade | Grading Rules Agency |
| <b>Hardwoods</b>   |                      |                      |
| Red Oak (Northern Red, Black, Pin, Laurel, Cherry-Bark, Scarlet, Water, and Willow Oaks) (a) | Grade GRP            | MDOT                 |
| Hard Maple (Black & Sugar) and Red Maple   |                      |                      |
| White Ash  |                      |                      |
| White-Heartwood Beech  |                      |                      |
| Yellow Birch   |                      |                      |
| Hickory (Mockernut, Pignut, Shagbark, and Shellbark Hickories)                               |                      |                      |
| <b>Softwoods</b>   |                      |                      |
| Douglas-fir, Douglas-fir/Larch   | No. 1 or better      | WWPA or WCLIB        |
| Southern Pine  | No. 1 or better      | SPIB                 |
| Jack Pine 8 in × 8 in  | No. 1 or better      | NHPMA                |
| a. Southern Red Oak is not permitted.  |                      |                      |

| Table 912-5<br>Species and Grading Requirements for Sawn Timber Guardrail Blocks             |                 |                      |
|--|-----------------|----------------------|
| Species  | Blocks Grade    | Grading Rules Agency |
| <b>Hardwoods</b>   |                 |                      |
| Red Oak (Northern Red, Black, Pin, Laurel, Cherry-Bark, Scarlet, Water, and Willow Oaks) (a) | Grade GRB       | MDOT                 |
| Hard Maple (Black & Sugar) and Red Maple   |                 |                      |
| White Ash  |                 |                      |
| White-Heartwood Beech  |                 |                      |
| Yellow Birch   |                 |                      |
| Hickory (Mockernut, Pignut, Shagback, and Shellbark Hickories)                               |                 |                      |
| <b>Softwoods</b>   |                 |                      |
| Douglas-fir and Douglas-fir/Larch  | No. 2 or better | WCLIB, WWPA          |
| Southern Pine Species  | No. 2 or better | SPIB                 |
| Jack Pine, Red Pine, and Eastern White Pine (Northern White Pine)                            | No. 1 or better | NHPMA                |
| a. Southern Red Oak is not permitted.  |                 |                      |

| Table 912-6<br>Species and Grading Requirements for Sawn Sign Posts |                                   |                      |
|---|-----------------------------------|----------------------|
| Species   | Grade                             | Grading Rules Agency |
| <b>4 in x 6 in (nominal) Posts</b>                                  |                                   |                      |
| Balsam Fir  | No. 1 (Joists-Planks)             | NELMA                |
| Douglas Fir   | No. 1 (Joists-Planks)             | WCLIB                |
| Eastern Hemlock   | No. 1 (Joists-Planks)             | NHPMA                |
| Tamarack (Eastern Larch)  | No. 1 (Joists-Planks)             | NHPMA                |
| Eastern White Pine  | Select Structural (Joists-Planks) | NELMA                |
| Southern Pine   | No. 1 (Joists-Planks)             | SPIB                 |
| <b>6 in x 8 in (nominal) Posts</b>                                  |                                   |                      |
| Douglas Fir   | No. 1 Dense (Posts-Timbers)       | WWPA                 |
| Southern Pine   | No. 1 SR (Stress Rated Timbers)   | SPIB                 |
| Eastern Hemlock   | Select Structural (Posts-Timbers) | NELMA                |
| Tamarack (Eastern Larch)  | Select Structural (Posts-Timbers) | NELMA                |

For guardrails, provide wood posts and blocks with a nominal 6 inch by 8 inch cross section, except for jack pine provide at least No. 1 Grade posts with a nominal 8 inch by 8 inch cross section. For sawed wood posts for signs, provide nominal 4 inch by 6 inch or 6 inch by 8 inch cross section.

1. **MDOT Grade GRP.** Provide MDOT Grade GRP guard rail posts meeting the requirements of this subsection.
  - a. **Splits.** Ensure splits are no greater than 3 inches on the bolt hole plane and no greater than 6 inches in other locations.

- b. **Checks.** Ensure single checks are no deeper than 3 inches. Ensure checks opposite each other do not have a total depth greater than 3 inches as measured with a probe no greater than  $\frac{1}{16}$  inch thick and  $\frac{1}{16}$  inch in diameter.

Ensure single checks at least  $\frac{3}{8}$  inch wide, as measured at the widest point, do not extend along more than one-third of the post length.

Ensure single checks, as measured at the widest point, are no greater than  $\frac{3}{8}$  inch wide.

- c. **Shakes.** Ensure shakes are no greater than 2 inches in the smallest dimension.
- d. **Splits, Checks, and Shakes.** Ensure splits, checks, or shakes do not appear in combinations that may cause posts to separate into pieces.
- e. **Stains.** Ensure pieces do not contain more than 25 percent stained heartwood, and staining is not caused by decay.
- f. **Slope of Grain.** Ensure slope of grain is no greater than 1:10.
- g. **Wane.** Ensure wane occurs on less than one-quarter of any face.
- h. **Knots.** Ensure knots are sound and tight. Ensure the sum of the least knot dimensions in 6 inch lengths of posts is less than 5 inches. Ensure grain distortion caused by knot clusters is no greater than  $2\frac{1}{2}$  inches. Ensure knots do not exceed  $2\frac{1}{2}$  inches in the least dimension.
2. **MDOT Grade GRB.** Provide MDOT Grade GRB guardrail blocks meeting the requirements of this subsection.
- a. **Splits.** Ensure splits are no greater than 3 inches on the bolt hole plane and no greater than 5 inches in other locations.
- b. **Checks.** Ensure single checks are no greater than 3 inches deep. Ensure checks opposite each other do not have a total depth greater than 3 inches as measured with a probe no greater than  $\frac{1}{16}$  inch thick and  $\frac{1}{16}$  inch in diameter.

Ensure single checks at least  $\frac{3}{8}$  inch wide as measured at the widest point do not extend along more than one-third of the post length.

Ensure single checks, as measured at the widest point, are no greater than  $\frac{3}{8}$  inch wide.

- c. **Shakes.** Ensure shakes are no greater than 3 inches in the smallest dimension and do not extend more than one-half of the standard grading length.
- d. **Splits, Checks, and Shakes.** Ensure splits, checks, and shakes do not appear in combinations that may cause blocks to separate into pieces.
- e. **Stains.** Ensure pieces do not contain more than 25 percent stained heartwood, and staining is not caused by decay.
- f. **Wane.** Ensure wane occurs on less than one-third of any face.
- g. **Knots.** Ensure grain distortion caused by knot clusters is no greater than 4 inches. Ensure knots do not exceed 4 inches in the least dimension.

#### B. **General Requirements.**

- 1. **Decay.** Provide posts and blocks free from decay before treatment.
- 2. **Crook or Bow.** Ensure crooks or bows are no greater than 1 inch per 10 feet of length.
- 3. **Dimensional Tolerances.** Provide posts and blocks with the following dimensional tolerances:
  - a. Cross-section no less than minus ½ inch from the required dimension;
  - b. Block length no less than minus ½ inch from the required length; and
  - c. Post length no less than minus 2 inches from the required length.

C. **Incising.** Incise posts before treatment; the Department does not require blocks to be incised. Ensure the incisor has teeth a nominal  $\frac{7}{8}$  inch long to make cuts spaced  $2\frac{1}{2}$  inches apart lengthwise in rows  $\frac{3}{4}$  inch apart. Ensure alternate rows are staggered by  $1\frac{1}{4}$  inches to provide 60 diamond patterns of incisions per square foot. Ensure the diamonds are  $2\frac{1}{2}$  inches long and  $1\frac{1}{2}$  inches wide from center to center. The Contractor may incise southern pine with  $\frac{3}{4}$  inch teeth.

As an alternative, the Contractor may incise posts in accordance with the *AREMA Manual for Railway Engineering*, Article 3.6.2.

D. **Inspection Before Treatment.** Inspect air dried or kiln dried material for moisture content as specified in subsection [912.09.E](#) and in accordance with AWPA M2. Test representative pieces. Test at least 5 percent or 50 pieces out of a charge, whichever is less.

**E. Test for Moisture Content.** Test moisture content using an electrical resistance type moisture meter with insulated needles 1½ inches long. Correct readings for species and temperature readings in accordance with meter instructions. Take readings on one surface at mid-length. Drive needles to their full length during readings. The Engineer will accept lots with average moisture content no greater than 19 percent. Remove individual pieces with moisture contents greater than 23 percent.

**F. Preservative Treatment.** Treat wood for guardrail posts and sign posts in accordance with AWPA U1, Section 6, Commodity Specification A, Use Category 4B. Treat wood for guardrail blocks in accordance with AWPA U1, Section 6, Commodity Specification A, Use Category 4A.

**G. Preservatives.** Provide preservatives for treatment meeting the requirements of AWPA U1, Section 4, "Preservatives for Pressure Treatment Processes," and the relevant P Standards.

**H. Sorting and Spacing.** Provide charges of the same species or species within any one group specified in Table 912-7. Provide material with a similar moisture content and similar form and size.

The Contractor may treat blocks and posts in the same charge after meeting the retention requirements specified in subsection [912.09.K](#). Use horizontal spacers to separate pieces in the charge to ensure preservative and steam contacts all horizontal surfaces.

| <b>Group</b> | <b>Species</b>                                     |
|--------------|--|
| A            | Southern Pine                                      |
| B            | Douglas-Fir, Balsam Fir, Eastern Hemlock, Tamateck |
| C            | Jack Pine, Red Pine and Eastern White Pine         |
| D            | Hardwoods  |

**I. Conditioning.** Use air seasoning, kiln drying, Boulton drying, vapor drying, steaming, or heating in preservative.

Ensure average moisture content no greater than 19 percent for air seasoned or kiln dried material before treatment.

If steam conditioning, do not exceed the maximum temperature specified in Table [912-8](#) in less than 1 hour. If applying a vacuum after steaming, ensure the vacuum pressure is at least 22 inches of mercury. If using Chromated Copper Arsenate (CCA), Ammoniacal Copper Arsenate (ACA), or Ammoniacal Copper Zinc Arsenate (ACZA), remove the material from the cylinder and allow it to cool to no greater than 120 °F

after steaming and before applying the preservative. When treating douglas fir with pentachlorophenol, do not steam. If treating southern pine, jack pine, and red pine with CCA, ACA or ACZA, use steam only to thaw frozen or ice coated material.

If conditioning material by heating in preservative, ensure the solution covers the material. Refer to Table 912-8 for maximum temperatures. Do not condition by heating in water-borne preservatives, including CCA, ACA, and ACZA.

| Species             | Conditioning Methods Allowed | Steaming           |                      | Heating in Preservative |                      |
|---------------------|------------------------------|--------------------|----------------------|-------------------------|----------------------|
|                     |                              | Maximum Temp. (°F) | Maximum Duration (h) | Maximum Temp. (°F)      | Maximum Duration (h) |
| Hard Maple          | Air drying only, no steaming | —                  | —                    | —                       | —                    |
| Other Hardwoods (a) | (d)                          | —                  | —                    | 220                     | No limit             |
| Southern Pine       | (d)                          | 245                | 17                   | 220                     | No limit             |
| Eastern White Pine  | (d)                          | 240                | 4½                   | 210                     | 6 (c)                |
| Other Softwoods (b) | (d)                          | 240                | 6                    | 210                     | 6 (c)                |

a. Red Oak, White Ash, White-Heartwood Beech, Yellow Birch, Hickory, and Red Maple.  
 b. Jack Pine, Douglas Fir, and Red Pine, Balsam Fir, Eastern Hemlock, Tamarack.  
 c. If using seasoned material, otherwise no limit.  
 d. See Subsection [912.08.I](#), "Conditioning."

**J. Treatment.** Ensure treatment meets the retentions and penetrations specified in subsection [912.08.K](#) and subsection [912.08.L](#).

Apply pressure in accordance with Table [912-9](#). Maintain pressure until the required volume of preservative enters the wood.

For pentachlorophenol in Type A hydrocarbon solvent, do not exceed 210 °F during the pressure period. For ACA, do not exceed 150 °F during the pressure period. For CCA, do not exceed 120 °F during the pressure period. For ACZA do not exceed 150 °F during the pressure period.

If treating with pentachlorophenol, the Contractor may apply an expansion bath or a final steaming after completion of the pressure phase of the treatment, as specified in Table 912-9.

| Table 912-9<br>Pressure Requirements by Species |                  |                  |  |                          |                            |
|---|------------------|------------------|--|--------------------------|----------------------------|
| Species   | Pressure         |                  | Where Preservative is<br>Penetachlorophenol in Type A<br>Hydrocarbon Solvent |                          |                            |
|   |                  |                  | Expansion<br>Bath<br>Maximum<br>Temp.<br>(°F)                                | Final Steaming (a)       |                            |
|   | Minimum<br>(psi) | Maximum<br>(psi) |  | Maximum<br>Temp.<br>(°F) | Maximum<br>Duration<br>(h) |
| Red Oak   | 125              | 250              | Not<br>Permitted   | 240                      | 1                          |
| Other Hardwoods                                 | 125              | 200              | Not<br>Permitted   | 240                      | 1                          |
| Jack Pine, Red Pine                             | 75               | 175              | 220  | 240                      | 2                          |
| Southern Pine                                   | 75               | 200              | 220  | 240                      | 2                          |
| Douglas Fir                                     | 50               | 150              | 220  | 240                      | 2                          |
| Balsam Fir                                      |                  |                  |  |                          |                            |
| Eastern Hemlock                                 |                  |                  |  |                          |                            |
| Tamarack  |                  |                  |  |                          |                            |
| Eastern White Pine                              | 50               | 135              | 220  | 240                      | 1                          |

a. If using seasoned material, the Contractor may post-steam at 225 °F for no greater than 15 h.

K. **Retention.** Use chemical assay with samples taken after treatment as specified in subsection [912.09.M](#), and refer to Table 912-10 to determine the minimum retention for the outer 0.6 inch of guardrail posts, blocks, and sign posts using the AWPAs Standards specified. If treating blocks with posts, determine charge retention by assay of borings from posts.

| Table 912-10<br>Minimum Retention Requirements |   |  |   |                  |
|--|---|--|---|------------------|
| Preservative                                   | Minimum Retention, (pcf)  |  |   | AWPA<br>Standard |
|  | Guardrail Posts   | Sign Posts   | Blocks  |                  |
| Oil Type                                       | AWPA<br>Commodity<br>Specification A,<br>Table 3.0, Use<br>Category 4<br>(UC4C) | AWPA<br>Commodity<br>Specification B,<br>Table 3.1.2, Use<br>Category 4B | AWPA<br>Commodity<br>Specification A,<br>Table 3.0, Use<br>Category 4<br>(UC4A) | A6               |
| Waterborne<br>Type                             |   |  |   | A11              |

L. **Penetration.** Refer to Table 912-11 for heartwood and sapwood penetration requirements. Take samples to determine penetration after treatment as specified in subsection [912.09.M](#).



| <b>All Species Allowed (a)</b>  | <b>Minimum Penetration</b> |                                     |
|---|----------------------------|-------------------------------------|
|   | <b>Heartwood</b>           | <b>Sapwood</b>                      |
| Guardrail Posts and Blocks  | 0.3 in                     | 0.6 in or 90%, whichever is greater |
| Sign Posts  | 0.5 in                     | 0.6 in or 90%, whichever is greater |
| a. For Red Oak, penetrate 65 percent of the total annual rings. If red oak cannot be penetrated as required, the Contractor may properly condition wood to refusal. |                            |                                     |

**M. Inspection After Treatment.** After treatment, examine the charge for cleanliness, mechanical damage, treatment damage such as severe checking, splitting, or honeycombing, and for untreated areas resulting from air pockets, floating material, or insufficient preservative height. Remove defective material before shipment.

The Department will sample material in accordance with [MTM 713](#), and test for preservative retention and penetration.

**N. Branding.** Permanently and clearly burn brand posts and blocks on one wide face. On guardrail posts, ensure the brand is within 1 foot of the post top. On sign posts, ensure the brand is within the middle one-third of the post. Ensure the brand shows the following information in accordance with AWPA M 6:

1. Treater ID,
2. Plant designation,
3. Year of treatment (the month may be included),
4. Species or group (code designation specified in Table 912-12),
5. Preservative type, and
6. Retention type.

| <b>Group</b>   | <b>Code (a)</b> |
|--|-----------------|
| Hardwoods  | MH              |
| Jack Pine  | J               |
| Other Softwoods  | MS              |
| Southern Pine  | SP              |
| Douglas Fir  | DF              |
| a. Species designated in Table <a href="#">912-4</a> , Table <a href="#">912-5</a> , and Table <a href="#">912-6</a> . |                 |

**O. Conformance.** Ensure the treatment plant supplying the material provides a certificate indicating the species, grade, preservative type, retention, year, and name of treater.

**P. Degradation After Treatment.** The Engineer will reject guardrail posts or blocks that develop at least one of the following before installation:

1. Single checks at least 3 inches deep or checks opposite each other with a total depth greater than 3 inches as measured with a probe no greater than  $\frac{1}{16}$  inch thick;
2. Single checks at least  $\frac{1}{4}$  inch wide as measured at the widest point, and extending along more than one-third of the length of the post or block;
3. Single checks greater than  $\frac{3}{8}$  inch wide as measured at the widest point;
4. Splits in the bolt hole plane greater than 3 inches long;
5. Crooks or bows greater than 1 inch per 10 foot length;
6. Twists; or
7. A combination of checks, splits, or shakes that may cause the post or block to separate into pieces.

**Q. Guardrail Offset Blocks.** The Contractor may select alternate materials for guardrail offset blocks from the Qualified Products List.

### **912.09. Timber for Rustic Construction.**

**A. Species and Grade.** Provide sound unfinished eastern or northern white pine, red pine, ponderosa pine, douglas-fir, northern white cedar, or southern pine for logs, posts, timbers, lumber and split rails for rustic construction.

Provide material free of decay, with the bark removed. The Contractor may use salvaged rails from existing rail fences. Ensure salvaged rails are sound and uniform in straightness and size.

**B. Shape and Dimensions.** Provide uniformly straight materials as required, except where curved or angular logs are shown on the plans. Provide logs and posts with an average diameter, at the small end, of no less than the required diameter minus  $\frac{1}{4}$  inch.

**C. Preservative Treatment.** Condition and pressure treat wood for rustic construction in accordance with AWPA U1, Section 6, Commodity Specification B, Use Category 4A (UC4A) for above ground or Use Category 4B (UC4B) for ground contact.

**D. Preservatives.** Provide preservatives, meeting the requirements of AWPA U1 Section 4, "Preservatives for Pressure Treatment Processes," and the relevant P Standards.

### **912.10. Timber and Lumber for Human Conveyances.**

**A. Preservative Treatment.** Provide preservative treatment for timber and lumber on areas where frequent human contact may occur, including deck surfaces, walkways, handrails, steps, railing and fence posts, tables, and benches, with Ammoniacal Copper Quat (ACQ) or Copper

Azole (CA), in accordance with AWPA U1-04. Ensure the ACQ preservative meets requirements of AWPA P5. Do not use Chromium Copper Arsenate (CCA) or other arsenic based preservatives.

Ensure the lumber and timber meets the preservative retention and penetration requirements of AWPA U1-04, Table 3.0 and Table 4.0, for UC4A, for above ground and UC4B, for ground contact.

For UC4A, ensure a retention of at least 0.40. For UC4B, ensure a retention of at least 0.60. Do not use wood species cited in Table 3.0 as "NR (Not Recommended) for ACQ preservative."

**B. Results of Treatment.** Evaluate treatment results, including preservative analysis and penetration and retention, by testing chemical assay, in accordance with AWPA A11. Process and treat wood in accordance with AWPA T1-04. Ensure the preservative temperature during the pressure period does not exceed 150 °F.

**C. Fasteners.** For wood treated with ACQ preservative, use stainless steel fasteners or hot dipped galvanized fasteners in accordance with ASTM A653, batch or post-dipped process, with a coating thickness of at least 1.85 ounces of zinc per square foot of surface area (G185). Do not mix fastener types. Ensure aluminum does not directly contact ACQ treated wood. Use non-metallic spacers if contact with aluminum may occur. Do not use aluminum fasteners.

## Section 913. MASONRY UNITS

**913.01. General Requirements.** Clay brick, concrete brick, concrete block, salvaged paving brick, precast reinforced concrete units, and structural tile for masonry structures must meet the requirements of this section.

**913.02. Testing.** Testing will be in accordance with the specified ASTM or AASHTO method, as modified by this section.

### 913.03. Brick.

**A. Brick Dimensions.** Brick must meet the following nominal size limitations:

1. Depth – 2 inches to 2½ inches,
2. Width – 3½ inches to 3¾ inches, and
3. Length – 7½ inches to 8 inches.

Brick for a single structure must be of one nominal size and must not vary from the manufacturer's specified standard dimensions by more than  $\pm\frac{1}{8}$  inch in any dimension. However, clay brick may vary in length by  $\pm\frac{1}{4}$  inch and up to 2 percent of the clay brick may exceed the dimensional tolerances.

**B. Clay Brick.** Clay brick, to construct manholes, catch basins, and similar structures, must meet the requirements of AASHTO M 91, for Grade MS.

Recessed or cored brick approved by the Engineer is acceptable.

Salvaged paving brick meeting the requirements of this section is acceptable.

**C. Concrete Brick.** Concrete brick must meet the requirements of ASTM C 55 for concrete building brick.

Recessed or cored brick approved by the Engineer is acceptable.

**D. Sand-Lime Brick.** Sand-lime brick for masonry structures must meet the requirements of ASTM C 73, for Grade SW and the following 5-hour boiling test water absorption requirements:

1. Average of 5 bricks – 18% maximum; and
2. Individual brick – 20% maximum.

**913.04. Concrete Masonry Units for Structures Other than Drainage Structures.**

A. **Load-Bearing Units.** Hollow, load-bearing, concrete masonry units must meet the requirements of ASTM C 90, Normal Weight.

B. **Non-Load-Bearing Units.** Hollow, non-load bearing, concrete masonry units must meet the requirements of ASTM C 129, Normal Weight.

**913.05. Concrete Block for Drainage Structures.** Concrete blocks for manholes, catch basins, and inlets must meet the requirements of ASTM C 139, except as modified by this subsection

A. **Shape.** Block must be solid with parallel inside and outside surfaces, curved to the required radii and must have a groove or other Department-approved joint at the ends.

B. **Size.** The block manufacturer will select the nominal block dimensions for length and height. Blocks must have a nominal width of 6 inches, 8 inches, or 12 inches,  $\pm 3$  percent, as shown on the plans.

Where standard plans call for 12-inch thick drainage structure walls, the Contractor may use two 6-inch wide blocks to meet the required width. Blocks must be designed for length so that only full or half-length blocks are required to lay the circular wall of any one course.

The shape of blocks for use in the cones or tops of manholes or other structures must allow for constructing the structure as shown on the plans with inside and outside joints not to exceed  $\frac{1}{4}$  inch in thickness.

**913.06. Precast Reinforced Concrete Units for Drainage Structures.**

Circular precast concrete units with circular reinforcement for tops, risers, and sump bases for manholes, catch basins, and inlets must meet the requirements of AASHTO M 199 and the following additions and exceptions:

A. Units must have the internal diameter shown on the plans and must accept standard covers.

B. The joint with the vertical wall of the structure must be the same design as the joints in the circular pipe sections to allow a uniform bearing on the full wall thickness of the pipe.

C. Construct openings for pipe inlets or outlets in the riser sections of drainage structures by blocking out the openings when casting the sections, by scribing the openings in the green concrete and removing the green concrete from the openings, or by drilling out the openings from cured concrete with a water-cooled diamond bit.

D. Openings in the riser sections must be 3 inches larger than the outside diameter of the inlet or outlet pipe. The interior spacing between openings in a riser section must be at least 6 inches.

E. Obtain the Engineer's approval for the design of units for structure tops and for design of sump risers with base units. Request approval for sump riser and base units used together.

**913.07. Precast Concrete Bases for Drainage Structures.** Precast concrete bases for drainage structures for sewers less than 48 inches in diameter must be cast with Grade P2 or Grade S3 concrete, and as shown on the plans.

**913.08. Structural Tile.** Structural clay load-bearing tile must meet the requirements of ASTM C 34, for Grade LBX.

Structural clay non-load-bearing tile must meet the requirements of ASTM C 56.

**913.09. Precast Concrete Slope Paving Blocks.** Construct precast concrete slope paving blocks as shown on the plans.

Blocks must have a compressive strength of at least 2,500 psi for an average of three units with no individual block having a compressive strength of less than 2,000 psi. The average water absorption of three units must be no greater than 10 pounds per cubic foot.

The Department will sample and test precast concrete slope paving blocks in accordance with ASTM C 140 with the following exceptions:

A. Test 4 inch by 4 inch compression test specimens sawn from precast concrete slope paving block units. The specimens will be tested with the load applied in the direction of the thickness of the unit.

B. Determine water absorption using half of the unit used for the compression test specimen.

## Section 914. JOINT AND WATERPROOFING MATERIALS

**914.01. General Requirements.** Joint and waterproofing material for use in concrete construction must meet the requirements of this section.

**914.02. Testing.** Steel joint material testing must be in accordance with ASTM E 8 or ASTM A 370 and the ASTM specifications applicable to the specific material.

Other joint and waterproofing material testing must be in accordance with the specified ASTM, AASHTO or Department methods, as modified by this section.

### 914.03. Joint Filler for Concrete Construction.

**A. Fiber Joint Filler.** Fiber joint filler for concrete construction must meet the requirements of ASTM D 1751.

Fiber joint filler must not deform or break due to twisting, bending, or handling when exposed to atmospheric conditions.

For concrete pavements, cut fiber joint filler into a rectangular shape and to the widths shown on the plans. Punch holes in the fiber joint filler for load-transfer bars in new concrete pavements as shown on the plans.

**B. Recycled Rubber Joint Filler.** Select recycled rubber joint filler from the Qualified Products List.

For concrete pavements, cut recycled rubber joint filler into a rectangular shape and to the widths shown on the plans. Punch holes in the recycled rubber joint filler for load-transfer bars in new concrete pavements as shown on the plans.

### 914.04. Joint Sealants for Concrete Construction.

**A. Hot-Poured Joint Sealant.** Hot-poured joint sealant must meet the requirements of ASTM D 6690, for Type II with the following exceptions:

1. Test sealant bond at  $-20^{\circ}\text{F}$  for three complete cycles at 100 percent extension.
2. Penetration must be  $130 \pm 20$  dmm at  $77^{\circ}\text{F}$ .
3. Penetration must be at least 40 dmm at  $0^{\circ}\text{F}$ . Prepare and test two specimens after 24 hours of conditioning at  $0^{\circ}\text{F}$ . Complete the test within 20 seconds after removal from the freezer.
4. Use 2NS sand as the fine aggregate in concrete mixture for bond blocks.
5. Allow at least 14 days from receipt of the sample to the time of reporting test results.

6. Material containers must be legibly marked with a non-fading, weather-resistant ink or paint. Include the manufacturer's name or trade name, batch number, recommended pouring temperature, and the maximum safe heating temperature on the label.

**B. Backer Rod for Use with Hot-Poured Joint Sealant.** Backer rod for use with a hot-poured joint sealant must be solid, round, heat resistant, closed-cell, cross-linked polyethylene foam meeting the requirements of ASTM D 5249, for Type I.

**914.05. Epoxy Binder for Joint Spall Repair.** Select one of the following types of epoxy binder material mixed with dry 2MS masonry sand to repair spalls adjacent to longitudinal or transverse joint grooves.

A. If the concrete temperature is from 60 °F to 104 °F, select Type I epoxy binder.

B. If the concrete temperature is from 35 °F to 59 °F, select Type II epoxy binder.

Epoxy components must be low-viscosity and come packaged to allow easy measurement and mixing in the field at a 1:1 ratio or a 2:1 ratio, by volume. Both component containers must show the volumetric mix ratio.

Epoxy binders must be composed of 100 percent nonvolatile materials and must not contain solvents or pigments. All epoxy binder ingredients must be reactive, become a permanent part of the cured adhesive system, and not lose adhesion due to small amounts of moisture that may be present in the concrete repair area.

Epoxy binders must meet the requirements of Table [914-1](#).

Mark containers with part, type, lot or batch number, and volumetric proportioning ratio. Allow at least two weeks for testing before intended use.

A batch of each component consists of quantities of material subjected to the same unit chemical or physical mixing process to make the final product uniform.



| <b>Table 914-1<br/>Epoxy Binder Physical Requirements</b>   |               |                |
|---|---------------|----------------|
| <b>Test</b>   | <b>Type I</b> | <b>Type II</b> |
| Part A, Epoxy Resin Base Polymer Viscosity, poises at 72 °F (a) (Brookfield viscometer, No. 2 Spindle)  | 5 – 30        | 5 – 20         |
| Part B, Modified Curing Agent Viscosity, poises at 72 °F (a) (Brookfield viscometer, No. 2 Spindle)   | 3 – 30        | 3 – 20         |
| Mixture A and B Gel Time, minutes (100 g initially at 72 °F)  | 25 – 50       | 8 – 15         |
| Tensile Strength at yield, psi at 72 °F (b)(c)  | ≥3,000        | ≥2,500         |
| Elongation, Ultimate, percent (c)   | ≥10           | ≥10            |
| Absorption (24 h in water at 72 °F) percent by weight (c)   | ≤1.0          | ≤1.0           |
| Shear Bond Strength, psi (On sawed concrete at 72 °F)   | ≥400          | ≥400           |
| a. Perform viscosity tests in accordance with ASTM D 1084, Method B.<br>b. Perform tensile tests at 0.2 in/min in accordance with ASTM D 638, Type 1 Specimen.<br>c. Perform tensile, elongation, and absorption tests on specimens cut from a 1/8 in thick cast sheet of cured epoxy binder. Core times are 96 h for Type I, 24 h for Type II. |               |                |

**914.06. Epoxy Resin Adhesive.** Epoxy resin adhesive must be capable of being injected into, and flow along, a crack 0.005 inch wide. Select epoxy resin adhesive from the Qualified Products List.

Use a fast-setting grout or a fast-set temporary seal as recommended by the epoxy resin adhesive manufacturer.

**914.07. Dowel Bars for Transverse Expansion and Contraction Joints.** Dowel bars must be straight, smooth, round bars with the dimensions shown on the plans. Dowel bars must have a minimum yield strength of at least 40,000 psi and a minimum tensile strength of at least 70,000 psi. When welding is required, dowel bars must meet these strength requirements when tested after welding to the dowel basket assembly.

Provide dowel baskets from a Department-approved source. Secure the dowel bars into the baskets by welding or other mechanical method to ensure the dowels will maintain alignment during and after concrete placement.

The ends of dowel bars for expansion and contraction joints must be saw cut or sheared, and free of burrs. If dowel bars are sheared, ensure the ends remain round and do not deform.

Protect dowel bars from corrosion as specified in this subsection.

**A. Coatings for Dowel Bars.** If required, provide dowel bars coated with an epoxy resin coating selected from the Qualified Products List.

The supplier must identify the epoxy resin coating used and certify that the dowel bars underwent a surface preparation treatment before coating in accordance with the recommendations of the coating manufacturer.

The Engineer will sample and test dowel bars for average coating thickness, and check for chips, cracks, or other damage to the coating, and for the presence of a bond breaker, if required, before installation in the concrete construction. The Engineer may reject dowels with coatings not meeting the thickness requirements, or dowels with coating damage.

Epoxy coated dowel bars must have an average coating thickness not less than 0.010 inch, nor more than 0.014 inch on any bar, with individual determinations on a single bar within a tolerance of  $\pm 0.004$  inches of the average. Coating is not required on the end faces of the bars and on the cylindrical surface within 3 inches of the end fixed in the supporting basket by welding or other mechanical means.

To prevent bonding to concrete, epoxy coated dowels must be coated with an asphalt material meeting the requirements of MC-70 or RC-250, as specified in subsection [904.03.B](#); or an alternate bond release agent selected from the Qualified Products List. Bond release agents must provide a pull-out shear bond stress of the dowel bar no greater than 60 psi for initial and final movement of the dowel from the concrete specimen. The manufacturer of the asphalt material must provide certification to the Engineer that the coating material meets the 60-psi pull-out requirement.

The Contractor or supplier may apply asphalt coatings to the dowel bar and the dowel basket assembly. The manufacturer must apply the alternate bond release agents to the dowel bar and the dowel basket assembly.

**B. Sleeves for Dowel Bars.** Sleeves for dowel bars must be at least 0.01 inch thick and made of 300 series stainless steel, Monel metal, or a Department-approved equal. The sleeve must cover the bar to within 3 inches of the bar end that will be fixed in the supporting basket by welding or other mechanical means. The sleeve must wrap around the dowel bar and must not move in relation to the bar. A folded lock seam or a continuous weld must fasten the lap. The sleeve must contact the entire bar without gaps.

The Engineer will determine if sleeves do not fully contact dowel bars based on the formation of dimples in the sleeve when tapped lightly with a ball-peen hammer or similar tool.

As an alternative to placing a sleeve on a carbon steel bar, the Contractor may provide a solid stainless steel bar meeting the other applicable requirements for dowel bars.

**C. Dowel Bar Expansion Caps.** Dowel bars for expansion joints must include metal or plastic expansion caps as shown on the plans and approved by the Engineer. Expansion caps must be sized to provide a slip fit onto the coated bar.

Expansion caps must have a uniform diameter for a length of at least 4 inches and must include a stop to ensure the end of the cap remains at least 1 inch away from the end of the dowel bar during concrete placement. Fabricate metal expansion caps from at least 28-gauge sheet steel, and close at the sides and end by crimping. Plastic expansion caps must be one piece, with a uniform thickness of at least  $1/16$  inch, entirely closed on the end.

**914.08. Devices for Transverse End-of-Pour Joints.** Use straight steel tie bar devices for end-of-pour joints.

Straight tie bars for end-of-pour joints must consist of at least No. 5 steel deformed bars at least 30 inches long meeting the requirements of ASTM A 615, ASTM A 616-96a, ASTM A 617-96a, or ASTM A 706. Epoxy coat straight tie bars as specified in subsection [905.03.C](#), except the Engineer will not require the application of the epoxy coating within 4 inches of each end of the tie bar, or repair of damage to the coating within 4 inches of each end of the bar.

**914.09. Lane Ties for Longitudinal Pavement Joints.**

**A. Straight Tie Bars.** Straight tie bars for longitudinal pavement joints must consist of at least No. 5 steel deformed bars at least 24 inches long meeting the requirements of ASTM A 615, ASTM A 616-96a, ASTM A 617-96a, or ASTM A 706. Epoxy coat straight tie bars as specified in subsection [905.03.C](#), except the Engineer will not require the application of the epoxy coating within 4 inches of each end of the tie bar, or repair of damage to the coating within 4 inches of each end of the bar.

**B. Bent Tie Bars for Bulkhead Joints.** Bent tie bars for bulkhead joints must consist of at least No. 5 steel deformed bars at least 24 inches long as measured around the outside of the bend. The tie bars must have a yield strength of at least 40,000 psi and be capable of withstanding bending to a 90° angle, re-straightening, and then withstanding the pull-out test requirements specified in subsection [602.03.F](#).

Epoxy coat bent tie bars as specified in subsection [905.03.C](#), except the Engineer will not require the application of the epoxy coating within 4 inches of each end of the tie bar, or repair of damage to the coating within 4 inches of each end of the bar.

**914.10. Structure Expansion Anchors and Bolts.** Select expansion anchors from the Qualified Products List in the sizes and shapes shown on the plans. Bolts for flush-type anchors must meet the requirements of ASTM A 307, for Grade A.

**914.11. Preformed Waterproofing Membranes and Joint Waterproofing.** Select preformed waterproofing fabric system, including the manufacturer's recommended primer, from the Qualified Products List.

**914.12. Elastomeric Bearings.** Elastomeric bearings must meet the requirements of AASHTO Division II, Section 18.2, "Elastomeric Bearings," for 100 percent virgin polychloroprene bearings. Provide certification to the Engineer that bearings conform to this subsection.

Laminated bearings must have a shear modulus of 100 psi  $\pm$ 15 psi. Plain bearings must have a shear modulus of 200 psi  $\pm$ 30 psi. Rolled steel sheet laminates must meet the requirements of ASTM A 36 or ASTM A 1011, for Grade 36 or Grade 40. Blast-clean the surfaces of the laminates where elastomers are to be bonded.

**914.13. Non-Metallic Washers.** Washers used as spacers between pin plates and link plates must be polyethylene, high density, non-metallic washers meeting the requirements of ASTM D 1248, for Type III, Class B.

## Section 915. BRIDGE COATING SYSTEMS

**915.01. General Requirements.** Select a complete coating system from the Qualified Products List for each structure. Use the same coating system for all coating repairs to the structure including warranty work. The system must consist of a tinted organic zinc-rich primer, a white intermediate coat, and a urethane top coat matching the Federal Standards No. 595B color number, as shown on the plans. For faying surfaces of slip critical bolted connections, use a zinc-rich primer meeting the requirements for Class B slip coefficient, selected from the Qualified Products List.

Before coating, provide the Engineer with the product data sheets showing mixing and thinning directions, and the manufacturer-recommended spray nozzles and pressures for each product. Provide the Engineer with documentation stating the date of manufacture for the coating product components.

Use spray equipment to apply the coating. The coating products and the thinners must arrive at the project in new, unopened containers. Coating containers must be labeled with the manufacturer's name, product name, batch number, and date of manufacture.

**915.02. Mixing the Coating.** Using a high shear mixer, mix the coating in accordance with the manufacturer's recommendations, to a homogenous consistency. Do not use paddle mixers or paint shakers. Mix until the metallic powder or pigment is in suspension. Disperse coating solids that may settle to the bottom of the container. Strain the primer through a screen with openings no greater than a No. 30 sieve meeting the requirements of ASTM E 11. After straining, continuously agitate the primer until application is complete.

**915.03. Thinning the Coating.** Do not thin the coating, unless otherwise recommended by the coating manufacturer. For thinning the coating, provide thinners recommended by the coating manufacturer. Do not exceed the manufacturer's recommended thinning limits.

**915.04. Conditions for Coating.** Apply coatings under the conditions specified by this subsection.

A. **Temperature.** Do not apply coatings if air or steel temperature is greater than 100 °F, or if the steel temperature is less than 5 °F higher than the dew point. Apply the primer and intermediate coats if air, coating material, and steel temperatures exceed 50 °F. Apply the top coat if air, coating material, and steel temperatures exceed 40 °F. Unless the manufacturer recommends a longer recoat time, maintain the

specified minimum air and steel temperatures between coats for 24 hours in the field, or for 16 hours in the fabrication shop.

**B. Humidity.** Do not apply coating if the relative humidity exceeds 90 percent, or if temperature and humidity conditions cause moisture to condense on the surfaces requiring coating. Use a psychrometer to measure the humidity.

**C. Heating.** If heating is required, heaters must maintain air and steel temperatures from 50 °F to 100 °F without discharging oils or other pollutants into the enclosure.

**D. Storage and Shelf Life of Coating.** Store the coating materials in accordance with the manufacturer's directions. Use coating within one year of the date of manufacture, unless product data sheets indicate a shorter shelf life.

## **Section 916. EROSION AND SEDIMENTATION CONTROL MATERIALS**

**916.01. Stone Used For Erosion and Sedimentation Control.** Provide cobblestone, coarse aggregate 3×1, and riprap for erosion and sedimentation control on slopes, in ditches, and to construct erosion control devices, including check dams. Natural stone for cobblestone or riprap must be sound, non-stratified, durable rock. As an alternative to natural stone, the Contractor may use sound pieces of broken concrete, free of protruding reinforcement, if approved by the Engineer and allowed by permit. Do not use crushed Hot Mix Asphalt (HMA) pavement or broken brick as erosion and sedimentation control material.

**A. Cobblestone.** Cobblestone must consist of rounded or semi-rounded rock fragments with an average dimension from 3 inches to 12 inches.

**B. Coarse Aggregate 3x1.** Coarse aggregate 3×1 must meet the requirements of commercially graded material with particle sizes from ¾ inch to 3 inches.

**C. Riprap.** Riprap must be natural stone, solid precast concrete blocks of Grade P2 concrete, or sound pieces of broken concrete, free from structural defects. Riprap must not contain soil, HMA, or protruding reinforcing steel. Randomly score the face of the precast concrete blocks to provide plane of weakness joints in sections with areas from 4 square feet to 9 square feet. Lifting lugs, cast into concrete blocks, must not project above the finished concrete surface.

The Department classifies riprap as plain or heavy, based on the horizontal cross section dimensions, (the “footprint” dimension) and the in-place thickness of the individual pieces.

1. **Plain Riprap.** Natural stone and broken concrete used for plain riprap must have footprint dimensions ranging from 8 inches to 16 inches and an in-place thickness of at least 8 inches. The Contractor may use smaller pieces to fill spaces for better slope protection.

Precast concrete block used for plain riprap must be at least 6 inches thick with a surface area no greater than 15 square feet.

2. **Heavy Riprap.** The smallest footprint dimension for natural stone and broken concrete used for heavy riprap must be at least 16 inches. The maximum to minimum dimension ratio must be no greater than 3:1. The in-place thickness must be at least 8 inches.

Precast concrete block used for heavy riprap must be at least 16 inches thick with a surface area no greater than 20 square feet.

**D. Requirements for Specific Erosion and Sedimentation Control Applications.**

1. **Checkdams.** Checkdams for ditch grades less than 2 percent must be constructed using cobblestone or broken concrete ranging from 2 inches to 4 inches in size. Checkdams for ditch grades 2 percent or greater must be constructed using cobblestone or broken concrete ranging from 3 inches to 12 inches in size.
2. **Stone Filled Bags.** Stone for stone filled bags must meet the gradation requirements for coarse aggregate 6A, as specified in Table [902-1](#).
3. **Sand Filled Bags.** Sand for sand filled bags must meet the gradation requirements for Class II granular material, as specified in Table [902-3](#).
4. **Aggregate Cover.** Aggregate used for aggregate cover, must meet the gradation requirements specified in Table [902-1](#) for dense-graded aggregate 21AA, or coarse aggregate 6A, or the requirements of subsection [916.01.B](#) for coarse aggregate 3×1. Aggregate must be natural aggregate, iron blast furnace slag, reverberatory-furnace slag, or crushed portland cement concrete. Use geotextile separator meeting the requirements of subsection [910.03.C](#).
5. **Gravel Access Approach.** Coarse aggregate used for gravel access approaches must meet the requirements of subsection [916.01.B](#) for coarse aggregate 3×1, or as approved by the Engineer. Aggregate must be produced from natural aggregate, iron blast furnace slag, reverberatory-furnace slag, or crushed portland cement concrete. Use geotextile separator meeting the requirements of subsection [910.03.C](#).

**916.02. Silt Fence.** Geotextile for erosion control silt fence must meet the requirements of subsection [910.04](#).

Attach geotextile to machine-pointed, No. 2 common grade hardwood posts with at least five staples through wood lath at least  $\frac{3}{8}$  inch thick and 2.0 feet long. Space posts no greater than 6½ feet apart.

Posts must be at least 36 inches long with a cross-sectional area of at least 2¼ square inches, and a smallest dimension of 1½ inches.



Silt fence must have at least two permanent markings or affixed labels per assembled roll, identifying the fabricator.

**916.03. Temporary Plastic Sheet or Geotextile Cover.** Provide plastic sheets or geotextile covers as temporary covers to prevent erosion. Mend or patch torn or punctured plastic sheets or geotextile cover with additional material of the same quality.

**A. Sheeting Material.** Sheeting material must be plastic sheet at least 6.0 mils thick with an ultra-violet ray inhibitor, or polyvinyl chloride (PVC) at least 10 mils thick. Use PVC material instead of plastic sheet from November 15 to April 1, or if expecting freezing conditions. Store and handle plastic sheet and PVC material in accordance with the manufacturer's recommendations. Do not expose sheeting material to heat or direct sunlight, causing diminished strength or toughness.

**B. Geotextile Cover.** Geotextile cover must meet the requirements of subsection [910.03.A](#) for geotextile blanket.

**916.04. Inlet Protection Fabric Drop.** Fabric for inlet protection fabric drop must be geotextile silt fence fabric meeting the requirements of subsection [916.02](#) or geotextile blanket meeting the requirements of subsection [910.03.A](#). If using gravel filter berm, aggregate must meet the gradation requirements for 34R or 6A specified in Table [902-1](#).

**916.05. Inlet Protection Geotextile and Stone and Drop Inlet Sediment Trap.** Geotextile for inlet protection geotextile and drop inlet sediment traps must be geotextile blanket meeting the requirements of subsection [910.03.A](#). Aggregate must meet the gradation requirements for 34R or 6A as specified in Table [902-1](#).

**916.06. Sand Fence and Dune Stabilization.** Fabric for sand and dune stabilization fence must be high-density polyethylene mesh fabric with a design opening of ½ inch to 1 inch. Sand fence must be at least 4 feet high.

**916.07. Turbidity Curtain.** Turbidity curtain must be delivered pre-assembled and includes the geosynthetic fabric, connection, and securing mechanisms, flotation devices, stakes, and ballast chain.

**A. Geosynthetic.** Geosynthetic for turbidity curtain must meet the minimum physical requirements for stabilization geotextile, except permittivity must be no greater than 0.2 second<sup>-1</sup> as specified by ASTM D 4491, and trapezoidal tear strength must be least 50 pounds, in accordance with ASTM D 4533.

The Contractor may use polymer-impregnated geosynthetics in lieu of meeting permittivity and opening size requirements.

Hemmed pockets to accommodate flotation devices and bottom weights must be sewn or heat bonded. Panel ends must include metal grommets through a reinforced hem. Tie connections between panels with synthetic or wire rope to prevent water flow through the joint.

**B. Flotation.** Flotation devices must be closed-cell polystyrene. Determine the required buoyancy based on site conditions. Flotation devices must ensure adequate freeboard to prevent overtopping.

**C. Stakes.** If using stakes to maintain curtain alignment, provide hardwood or steel stakes of lengths and cross-sections capable of supporting the curtain. The Contractor may use external supports with embedment depths greater than 1½ feet. Space stakes no greater than 6½ feet apart.

**D. Hardware.** Hardware, including stakes, ballast chain, connection bolts, reinforcement plates, and tension cables must be galvanized, stainless steel, or aluminum, and corrosion resistant. The mass of the ballast chain must be at least 0.7 pounds per foot and be capable of maintaining the geosynthetic in a vertical position.

## Section 917. TURF AND LANDSCAPING MATERIALS

**917.01. General Requirements.** Nursery stock, seed, sod, mulching material, and chemical fertilizer nutrients must meet the requirements of this section. Provide documentation of inspection for plant diseases and insect infestation in accordance with State and Federal laws.

**917.02. Testing.** The Engineer will require visual inspection or other acceptance tests of landscaping material as specified in this section or the [Materials Quality Assurance Manual](#).

**917.03. Nursery Stock.** Nursery stock must come from nurseries located in Zone 4 or Zone 5 of the USDA Hardiness Zone Map for landscaping in the Lower Peninsula. Nursery stock must come from nurseries located in Zone 3 for landscaping in the Upper Peninsula. Nursery stock must meet the requirements of ANSI Z 60.1, except the ball sizes must be as shown on the plans.

Ensure nursery stock is true to the type and name specified by the *American Joint Committee on Horticultural Nomenclature*, "Standardized Plant Names." Label a sample of each plant type with the size, species, and variety. Include the common and scientific names on the label. Provide first-class quality stock with well-developed branch systems and vigorous, healthy root systems. Ensure uniform and straight tree trunks. The Department will reject nursery stock grown in sandy soils. Provide balled and burlapped trees, ornamentals, and shrubs unless otherwise required.

Notify the Engineer at least 24 hours before stock delivery. Provide an invoice showing plant sizes, species, and varieties for each shipment. The Engineer will not accept plants until the stock is delivered and inspected at the project.

The Engineer may examine plants at the nursery by removing soil from the root systems of balled or container grown plants, or digging in the nursery row. The Engineer may inspect plant root systems for each species and plant source to determine the condition of plant root systems. The Department will not pay for plants that fail the Engineer's root system inspection.

**A. Deciduous Shade Trees.** Deciduous shade trees must be straight and symmetrical with a persistent main leader. The crown must be in proportion to the total height of the tree.

Where clumps are required, they must have at least two stems originating from a common base at the groundline.

**B. Small Trees, Ornamentals, and Shrubs.** Small trees, ornamentals, and shrubs must be well-formed with a crown typical of the species or variety. The Engineer will not allow heading-back plants to meet the sizes shown on the plans.

**C. Evergreen Trees.** Evergreen trees must be typical of the species and not sheared or color treated. Do not use evergreen trees grown for Christmas trees. The Engineer may require anti-transparent protection for evergreen trees.

**D. Vines and Ground Cover Plants.** Vines and ground cover plants must be in individual containers. Plants must be at least 1 year old, grown in pots long enough to ensure root growth capable of holding soil in place and retaining the container shape when removed from the pot. Vines must have at least four runners 1½ feet long. Tops of ground cover plants must be proportional to the root systems and typical of species or variety.

**917.04. Tree Wrapping Materials.** Wrap trees with waterproof crepe tree wrapping paper and secure with 2-inch wide masking tape. Use tree wrapping paper at least 3 inches wide, consisting of two layers of crepe kraft paper cemented together with asphalt, weighing at least 30 pounds per ream.

**917.05. Balling Material.** Use untreated burlap as balling material. Do not use synthetic balling materials such as nylon or plastic.

**917.06. Bracing and Guying Materials.**

**A. Wire.** For trees less than 4 inches in diameter, provide No. 11 galvanized steel guy wire. For trees with a diameter greater than 4 inches, provide No. 9 galvanized steel guy wire. Provide new wire free of bends and kinks.

**B. Hose.** Provide ¾ inch reinforced rubber garden hose or steam hose.

**C. Stakes.** Provide green metal T-section posts without anchor plates for bracing trees. For shade trees, posts must be at least 8 feet long. For evergreen trees, posts must be at least 6 feet long.

Provide nominal 2 inch by 4 inch stock stakes 24 inches long for guying plants. Stakes must be beveled on two or four sides to provide a point on one end.

**917.07. Topsoil.** The Engineer will visually inspect topsoil for organic contamination and cleanliness at the source prior to transport to the project site. Obtain the Engineer's approval of salvaged topsoil prior to use. Topsoil must meet the following requirements:

- A. Must not be contaminated;
- B. Must not be excessively acidic or excessively alkaline;
- C. Must not contain natural underlying soils, subbase materials, or other deleterious material;
- D. Must consist of natural loam, sandy loam, silty loam, or clay loam humus-bearing soils adapted to sustain plant life; and
- E. Must be of mineral origin, exclusive of peat or muck.

**917.08. Compost.** The Engineer will visually inspect and approve the compost at the composting site for physical contaminants.

Compost must be mature, stabilized, humus-like, dark brown or black compost derived from the aerobic decomposition of yard clippings or other compostable materials as defined in 1995 PA 451, Part 115 Solid Waste Management, and federal and state laws. Compost must meet the following requirements:

- A. Must be capable of supporting plant growth;
- B. Must be free of objectionable odor, plastic, glass, metal, or other physical contaminants;
- C. Must not contain viable weed seeds, or other plant parts capable of reproducing; the exception is for airborne weed species; and
- D. Must not produce visible free water or dust during handling.

**917.09. Peat Moss.** Peat moss must consist of finely shredded sphagnum or fibrous peat moss of a Department-approved commercial grade, free of woody substance.

**917.10. Fertilizers.** Provide standard, commercial, packaged, or bulk product fertilizers in granular or liquid form for landscape planting, landscape plant watering, seeding, and sodding. Each container of packaged fertilizer must be marked with the content analysis showing the minimum percentages of total nitrogen, available phosphoric acid, and soluble potash. If providing bulk fertilizer, provide an invoice with each shipment indicating the minimum percentages of total nitrogen, available phosphoric acid, and soluble potash.

**A. Landscape Fertilizers.**

1. **Planting Fertilizers.** For mixing with peat moss and topsoil, provide ready-mixed granular fertilizer containing equal amounts of phosphorus and potassium by weight. Each cubic yard of prepared soil must contain chemical fertilizer to provide 1 pound of available phosphorus and 1 pound of available soluble potassium.

2. **Watering Fertilizers.** For application during watering, provide water soluble, nitrogen-enriched fertilizer containing 8.3 pounds of available nitrogen per 1,000 gallons of water.
- B. **Seeding and Sodding Fertilizers.** Ensure fertilizers in each class contain a water insoluble and water-soluble component.
  1. **Class A.** Provide and apply Class A chemical nutrient fertilizer as specified by this subsection and as indicated by soil tests, when required.
    - a. **Water Insoluble Fertilizer.** Apply 32 pounds of water insoluble nitrogen per acre (i.e. 128 pounds of Ureaform or 115 of IBDU, etc.). Provide the water insoluble nitrogen from ureaformaldehydes, coarse grade isobutylidene diurea, or both.
    - b. **Water Soluble Fertilizer.** Apply 48 pounds of nitrogen, phosphorous, and potassium nutrient per acre (i.e. 253 pounds of 19-19-19, 400 pounds of 12-12-12, etc.). Provide water soluble fertilizer containing a 1:1:1 ratio of nitrogen, phosphorous, and potassium. Ensure fertilizer components include urea, diammonium phosphate, and potassium chloride.
  2. **Class B.** Provide and apply Class B chemical nutrient fertilizer as specified by this subsection and as indicated by soil tests, when required.
    - a. **Water Insoluble Fertilizer.** Apply 32 pounds of water insoluble nitrogen per acre. Provide the water insoluble nitrogen from ureaformaldehydes, coarse grade isobutylidene diurea, or both.
    - b. **Water Soluble Fertilizer.** Apply nitrogen at a rate of 48 pounds of nutrient per acre and 40 pounds of potassium per acre. Ensure fertilizer components include urea and potassium chloride.
  3. **Class C.** Provide and apply Class C chemical nutrient fertilizer as specified by this subsection and as indicated by soil tests, when required.
    - a. **Water Insoluble Fertilizer.** Apply 32 pounds of water insoluble nitrogen per acre. Provide water insoluble nitrogen from ureaformaldehydes, coarse grade isobutylidene diurea, or both.
    - b. **Water Soluble Fertilizer.** Apply nitrogen at a rate of 48 pounds of nutrient per acre. Ensure fertilizer components include urea.

**917.11. Water.** Use water that meets the requirements of section [911](#) and that is free from any impurities or substances that might injure the plant.

**917.12. Seed.** Provide the required certified seed and mixture meeting the purity, germination, and proportions specified in Table [917-1](#). Select seed of each species from the Qualified Products List. Supply seed in durable bags, with a tag marked by the manufacturer and supplier of the blended mix showing the species and variety name, lot number, net weight of contents, purity, and germination.

Seed must be tested in accordance with *The Proceedings of the Association of Official Seed Analysts*, "Rules for Testing Seeds." The Engineer will evaluate deficiencies below the percentage required for purity and germination, to determine acceptability.

**917.13. Sod.** Provide sod consisting of a densely rooted blend of at least two bluegrass varieties with at least 30 percent creeping red fescue content, free of weeds, and grown on the same or similar soil as the topsoil on the project. Obtain the Engineer's approval of the sod in the sod field before harvesting. Select sod capable of adapting to the topsoil on the project and future maintenance needs. Before cutting the sod, mow the grass to 3 inches to 4 inches above the ground surface.

Cut the sod from  $\frac{1}{2}$  inch to  $\frac{3}{4}$  inch thick. If cutting sod into strips, cut in small uniform units of approximately 10 square feet per roll to ensure ease of handling of the sod without tearing or breaking. The sod may be cut, transported, and laid in large rolls with machinery designed for that purpose.

A. **Pegs for Sodding.** Provide pegs of sound wood, at least 10 inches long, with a cross-sectional area of at least 0.75 square inches for pegging sod. The Engineer may require longer pegs in sandy or similar soils.

**917.14. Mulching Materials for Nursery Stock.**

A. **Shredded Bark.** Provide shredded bark consisting of tree bark stripped and shredded from saw logs with a de-barking machine. Shredded bark mulch must be capable of passing through a conventional mulch blower. Do not use wood chips.

**917.15. Mulch for Seed.**

A. **Loose Mulch.** Provide clean, undamaged, and rot free straw in an air-dry condition for loose mulch. Loose mulch must be free of weed seeds or other deleterious material.

**B. Turf Mulch Blankets.** Select turf mulch blankets from the Qualified Products List.

1. **High Velocity Mulch Blankets.** High velocity mulch blankets must have net covering on two sides. The net must meet the requirements of subsection [917.15.D.1](#) and be capable of reinforcing the blanket to prevent damage during shipping, handling, and installation.

a. **High Velocity Excelsior Mulch Blankets.** Provide high velocity excelsior mulch blankets that meets the following requirements:

- i. Blanket must consist of a uniform layer of interlocking excelsior fibers cut from sound, green timber;
- ii. The average roll weight, for an entire shipment, must be 12 ounces per square yard  $\pm 10$  percent;
- iii. Blankets must be shipped in tightly compressed rolls; and
- iv. Each roll must have the roll weight and the manufacturer name written or stenciled on the roll wrapper or on an attached tag.

b. **High Velocity Straw Mulch Blankets.** Provide high velocity straw mulch blankets that meet the following requirements:

- i. Blankets must consist of a uniform layer of clean wheat straw, free of weeds and weed seed;
- ii. When dry, the blankets must weigh 8 ounces per square yard  $\pm 10$  percent;
- iii. The straw and net must be stitched together to create a uniform mat;
- iv. Blankets must be shipped in tightly compressed rolls; and
- v. Each roll must have the roll weight and the manufacturer name written or stenciled on the roll wrapper or on an attached tag.

2. **Mulch Blankets.**

a. **Excelsior Mulch Blankets.** Provide excelsior mulch blankets meeting the requirements of high velocity excelsior mulch blankets except the blankets must weigh from 8 ounces to 12 ounces per square yard and have netting on one side.

b. **Straw Mulch Blankets.** Provide straw mulch blankets meeting the requirements of high velocity straw mulch blankets, except the blankets must have netting on one side.

**C. Mulch Anchoring.** Select mulch anchoring material from the Qualified Products List.



1. **Latex-Base.** Provide latex-base mulch anchoring material composed of 48 percent styrene, 50 percent butadiene, and 2 percent additive, by weight. The mulch anchoring material must contain from 42.0 percent to 46.0 percent solids and a pH, as shipped, from 8.5 to 10.0. Protect the emulsion from freezing or prolonged exposure to sunlight.
2. **Recycled Newsprint.** Provide recycled newsprint mulch consisting of specifically prepared, biodegradable, shredded, recycled newsprint fibers. The recycled newsprint fiber must:
  - a. Have a moisture content (total weight) no greater than 12 percent;
  - b. Have a high-grade newsprint content of at least 96 percent by weight (oven-dry);
  - c. Include tackifier content from 1.5 percent to 3 percent by weight;
  - d. Have a water holding capacity of at least 32 ounces per 3.5 ounces of fiber;
  - e. Contain a wetting agent and a defoaming agent; and
  - f. Contain a nontoxic bright green or blue dyestuff that adheres to the fiber to minimize leaching of the color after application.
3. **Wood Fiber.** Provide specially prepared, biodegradable, air-dried, virgin wood fibers manufactured from 100 percent whole wood chips. Do not use recycled materials. The wood fiber must:
  - a. Have a moisture content (total weight) no greater than 12 percent;
  - b. Have an organic wood fiber content of at least 95 percent by weight (oven-dry);
  - c. Include tackifier content from 3 percent to 5 percent by weight;
  - d. Have a water holding capacity of at least 35 ounces per 3.5 ounces of fiber;
  - e. Be dyed with a green or blue biodegradable dye; and
  - f. Contain no growth or germination inhibiting materials.
4. **Guar Gum.** Provide guar gum tackifiers consisting of at least 95 percent guar gum by weight with the remaining 5 percent by weight consisting of dispersing and crosslinking additives.
5. **Other Tackifiers.** The Contractor may provide water-soluble natural vegetable gums, guar gums blended with gelling and hardening agents, or a water-soluble blend of hydrophilic polymers, viscosifiers, sticking aids, and other gums as tackifiers.

**D. Mulch Netting.**

1. **Netting.** Provide mulch net with a mesh size from  $\frac{1}{2}$  inch by  $\frac{1}{2}$  inch to  $1\frac{1}{2}$  inches by 2 inches, formulated from or treated with a chemical that promotes the breakdown of the net within the first growing season after placement.

Mulch netting must be strong enough to hold the mulch in place and still deteriorate when exposed to sunlight.

2. **Net Anchors.** Provide wood or other biodegradable net anchors, at least 6 inches in length, as approved by the Engineer. Do not use steel wire staples or pins to anchor mulch blankets or netting.

**917.16. Weed Control.** Provide herbicides registered for use on highway right-of-way by the Michigan Department of Agriculture and the United States Environmental Protection Agency. Obtain the Engineer's approval of herbicides prior to use. Do not use restricted use herbicides.

Table 917-1  
Seed Mixtures

| Species             | Minimum Purity<br>(percent) | Germination<br>(percent) | Seed Mixture                            |     |     |     |     |    |               |            |    |    |
|---------------------|-----------------------------|--------------------------|---|-----|-----|-----|-----|----|---------------|------------|----|----|
|                     |                             |                          | Mixture Proportions (percent by weight) |     |     |     |     |    |               |            |    |    |
|                     |                             |                          | TDS                                     | THV | TUF | TGM | THM | CR | TSM<br>6 - 24 | TSM<br>>24 |    |    |
| Kentucky Blue Grass | 98                          | 85                       | 5                                       | 15  | 10  | 10  | 30  | —  | —             | —          | —  | —  |
| Perennial Ryegrass  | 96                          | 85                       | 25                                      | 30  | 20  | 20  | 20  | —  | —             | 50         | 50 | —  |
| Hard Fescue         | 97                          | 85                       | 25                                      | —   | 20  | 30  | —   | —  | —             | —          | —  | —  |
| Creeping Red Fescue | 97                          | 85                       | 45                                      | 45  | 40  | 40  | 50  | —  | —             | —          | —  | —  |
| Fulfs Salt Grass    | 98                          | 85                       | —                                       | 10  | 10  | —   | —   | —  | —             | —          | —  | —  |
| Cereal Rye          | 85                          | 85                       | —                                       | —   | —   | —   | —   | —  | —             | 100        | —  | —  |
| Spring Oats         | 85                          | 85                       | —                                       | —   | —   | —   | —   | —  | —             | —          | 50 | 50 |

## Section 918. ELECTRICAL AND LIGHTING MATERIALS

**918.01. Conduit.** Provide UL labeled conduits, with ultraviolet protection and manufactured for use at temperatures of at least 194 °F unless otherwise required. For cables encased in concrete, use Grade S2 concrete in accordance with section [701](#). If steel reinforcement is required, provide reinforcement meeting the requirements of section [905](#).

**A. Galvanized Steel Conduit.** Provide galvanized steel conduit meeting the requirements of ANSI C80.1. Provide UL listed and labeled galvanized steel conduit manufactured in accordance with UL 6.

Provide couplings and fittings that meet the requirements of ANSI C80.4 and are hot-dipped galvanized. Provide elbows and nipples meeting the requirements for conduit. Provide thread-type fittings and couplings for rigid conduit.

**B. Smooth-Wall Schedule 40 PVC Conduit.** Provide smooth-wall polyvinyl chloride (PVC) conduit, fittings, and accessories, manufactured from PVC meeting the requirements of ASTM D 1784 and the applicable NEMA TC2 and UL 651 requirements.

**C. Smooth-Wall Schedule 80 PVC Conduit.** Provide smooth-wall PVC conduit, fittings, and accessories manufactured from PVC meeting the requirements of ASTM D 1784 and the applicable NEMA TC2 and UL 651 requirements.

**D. Smooth-Wall Coilable Schedule 40 PE Conduit.** Provide high-density polyethylene Type III, Grade P-33, Category 5, Class C conduit meeting the requirements of ASTM D 3485, ASTM D 3350, and ASTM D 1248.

Ensure conduit is marked in accordance with ASTM D 3485. Mark the conduit to indicate the producer code and designation, whether HDPE or Type III. Provide conduit produced from material with a color and ultraviolet stabilization code of C, D, or E in accordance with ASTM D 3350. Provide black conduit for use above ground unless otherwise required.

For each project, supply a general certification that the PE conduit meets the above specification requirements.

**E. Smooth-Wall Coilable Schedule 80 PE Conduit.** Provide smooth-wall, coilable, polyethylene conduit meeting the requirements of applicable sections of NEMA TC7, UL 651 and 651A, ASTM D 3485 or ASTM D 2447.

Provide high-density polyethylene Type III, Grade P-33, Category 5, Class C conduit meeting the requirements of ASTM D 3485, ASTM D 3350, and ASTM D 1248.

Wall thickness and outside diameter dimensions must conform to ASTM D 1785 for Schedule 40 and 80 material, or applicable special provision. The Department will allow no more than 3 percent deviation from the minimum wall thickness specified. Wall thickness range must be within 12 percent in accordance with ASTM D 3035. For each project, supply a general certification that the PE conduit meets the above specification requirements.

**F. Rigid Fiberglass.** Provide filament wound conduit and fittings consisting of E-glass and corrosion resistant epoxy resin, manufactured for use at temperatures from -40 °F to 230 °F. Ensure conduit is pigmented with carbon black for ultraviolet protection and fire resistant in accordance with UL 94. Provide heavy walled fiberglass conduit meeting the specifications, labeling, and testing requirements of ANSI/NEMA TC14.

**918.02. Electrical Grounding System.** Provide material for the electrical grounding system meeting the requirements specified in this subsection.

**A. Flexible Grounding Connection.** Provide flexible grounding connections made of extra flexible, flat, tinned copper braid, with seamless tinned copper ferrules at each end. Provide flexible grounding connections with a minimum cross sectional area equal to the cross sectional area of the grounding cable. Provide ferrule capable of being formed to fit the curved surfaces of a clamp or pipe.

**B. Grounding Cable and Bonding Jumper.** Provide grounding cable and bonding jumper sized in accordance with the current NEC. Provide conductors of stranded bare soft copper wire meeting the requirements of ASTM B 8.

**C. Grounding Rod.** Provide a copper clad steel grounding rod with a diameter of at least  $\frac{3}{4}$  inch and a length of at least 10 feet, with no more than 10 ohms resistance to ground.

**D. Connecting Hardware.** Provide silicon bronze connecting hardware meeting the requirements of ASTM B 124. Provide materials supplied by the same manufacturer to ensure compatibility.

**918.03. Electrical Wire and Cable.** Provide wire and cable meeting the requirements of the NEC, relevant local ordinances, and ASTM specifications. Provide UL approved cable. Provide coated, soft drawn

copper conductors in standard American Wire Gauge (AWG) sizes as shown on the plans.

Provide wire and cables with the size, voltage rating, insulation type, and manufacturer's name permanently marked on the outer covering at regular intervals. The manufacturer must provide splicing or terminating information for installation of the cable to the Engineer and the Contractor. Provide soft drawn copper bare ground conductors.

**A. Overhead and Underground Service Wire and Cable.** Provide stranded cable consisting of two, 1/C polyethylene insulated conductors, assembled under a common polyethylene jacket. Provide cables meeting the requirements of IMSA 20-1 for aerial and duct installation, except provide conductors of the sizes and numbers required. Provide an insulation thickness for No. 6, No. 7, and No. 8 AWG cables of at least 1,016 microns and an average of 1,143 microns.

Provide Periwinkle-type, or Department-approved equal, aluminum multiplex cable, consisting of two sheathed conductors wrapped around a ground and messenger cable. Ensure the phase conductor consists of seven-strand, No. 4 AWG with an insulation thickness of 45 mils. Provide a bare neutral messenger consisting of a 6/1 strand, No. 4 AWG, with a rated strength of 1,860 pounds.

**B. Traffic Signal Wire and Cable.** Provide stranded traffic signal wire and cable for aerial, underground duct, or direct burial systems. Except for IMSA 51-5 cable, provide polyethylene insulated and polyethylene jacketed cables with from two to 20 conductors. Provide IMSA 51-5 PVC insulated, nylon jacketed cables, loosely encased in a polyethylene tube. Provide the sizes and number of conductors shown on the plans.

Provide cables meeting the requirements of IMSA 20-1, IMSA 20-3, IMSA 20-5, IMSA 40-2 (aerial and duct), IMSA 40-4 (aerial self-supporting), IMSA 50-2 (loop lead-in), and IMSA 51-5 (loop) with the exceptions and additions specified in this subsection.

1. **Conductors.** Provide concentric standard, Class B, soft copper conductors meeting the requirements of ASTM B 8, except do not allow joints in the conductors after completing final drawing operations.
2. **Circuit Identification.** Provide color coded insulation in accordance with the following:
  - a. Table 5.1 of IMSA 20-1,
  - b. IMSA 20-2,
  - c. IMSA 20-5,

- d. Table 5.2 of IMSA 40-2, and
- e. IMSA 40-4.

Do not print numerals or words on the insulation for conductor identification.

**C. Messenger Cable.** Provide stranded, ¼ inch, Class C, galvanized, extra high-strength steel strand messenger cable of no more than seven-wire, meeting the requirements of ASTM A 475, as specified by 9.1-A of IMSA 20-3 and 11.1 of IMSA 40-4.

**918.04. Direct Burial Cable.** Install direct burial cable in conduit unless otherwise shown on the plans.

Direct burial cable in conduit for use in wet locations must be a type allowed in the current NEC.

Unless otherwise required, provide UL listed cables rated at 600 volts. Provide cables resistant to oils and chemicals, rated 194 °F dry and 167 °F wet, for installation in wet and dry locations exposed to the weather, and meeting the requirements of UL 44.

Provide cables for electric service entrance runs with a USE rating.

For No. 2 AWG or smaller cable, provide cables that are UL listed Type RHH/RHW or Type RHH/RHW/USE.

If using cable greater than No. 2 AWG, use UL listed Type RHH/RHW/USE.

Provide cable with the UL listing mark, cable voltage, insulation type and ratings, and the cable size printed on the cable in a color contrasting with the insulation color.

**A. Conductors.** Provide uncoated, copper, UL 44 approved conductors meeting the requirements of ASTM B 3. Provide Class B conductors, stranded in accordance with ASTM B 8. Ensure the manufacturer's insulation curing process does not damage uncoated conductors.

Color code the insulation on cables No. 2 AWG and greater. Field-tape at least 12 inches of cable ends with half-lapped color tape.

Color code electric cables smaller than No. 2 AWG solid, painted full. Color code neutral wires white. Color code single phase 3-wire with one black, one red, and one white. Provide neutral, single phase 2-wire runs that are color coded similar to the applicable phase. Color code insulated ground wires green.

**918.05. Equipment Grounding Conductor.** Provide insulated or bare, annealed copper wire meeting the requirements of ASTM B 3 for equipment grounding conductors. Provide equipment grounding conductors that are stranded in accordance with ASTM B 8, for Class B. For installing conductor in conduit, insulate and color code the conductor green. For installing in earth, keep the conductor bare.

**918.06. Handholes.**

A. **Concrete.** Provide Grade S2 concrete in accordance with section [701](#).

B. **Steel Reinforcement.** Provide bar or welded cage mesh steel reinforcement. Provide welded cage mesh with a steel area capable of supporting HS-20-44 loading. Provide reinforcement as shown on the plans or in accordance with the manufacturer's design. If reinforcement deviates from the plans, provide calculations showing that the new design supports HS-20-44 loading.

C. **Frame and Covers.** Provide frame and covers of steel, and classified as light duty or heavy duty. Provide covers reading "MDOT ELECTRIC, MDOT TRAFFIC SIGNAL," "MDOT TRAFFIC CONTROLS," or "MDOT FREEWAY LIGHTING" in the location and of the size specified on the handhole detail sheet.

1. **Light Duty Cover.** Provide the light duty covers shown on the plans, or a Department-approved equal.

Provide East Jordan No. 2982A-18 or Neenah Foundry No. R-6012-D round cover.

2. **Heavy Duty Cover.** Provide the heavy duty covers shown on the plans or a Department-approved equal.

Provide East Jordan No. 2860A or Neenah Foundry No. R-6052-D round cover.

D. **Polymer Concrete Handhole Boxes and Covers.** Construct handhole boxes of polymer concrete, reinforced with a heavy weave fiberglass.

Provide heavy duty enclosures and covers designed and tested to -50 °F, with a compressive strength of at least 11,000 psi. Provide covers with a friction coefficient of at least 0.5.

1. **Boxes.** Provide stackable, heavy duty, nominal 17 inch by 30 inch by 12 inch handhole boxes, rated for 5,000 pounds over a 10 inch by 10 inch area.



2. **Covers.** Provide handhole covers with a service load of at least 15,000 pounds over a 10 inch by 10 inch area. Provide covers marked with a logo imprint of "MDOT TRAFFIC SIGNAL" or "MDOT TRAFFIC CONTROL." Secure covers with stainless steel, 300 series,  $\frac{3}{8}$  inch, 16NC hex bolts and washers.

E. **Handhole, Square, 4 foot.** Construct handhole boxes from concrete.

1. **Handhole.** Provide handholes with live loads meeting the requirements of AASHTO HS 20-44 for heavy traffic. Increase the handhole design live load by 20 percent, given an earth cover from 2 feet to 5 feet.

Provide standard telecommunications, Type S design, precast handholes with inside dimensions of at least 48 inches by 48 inches by 48 inches.

Center the top opening in the roof of the handhole and provide at least a 39 inch diameter, clear opening. Provide eight bell end inserts in the sides for a 4-inch PVC conduit. Provide a knockout for one, 14-inch diameter sump crock in the base of the handhole.

Provide a handhole that is watertight to within 42 inches of grade. Ensure the manufacturer provides master sealer for joints and holes, including grade rings and pull-in irons.

Provide one, 12-inch, interlocking, grade ring with a galvanized step cast into the ring. Provide a grade ring with an outside diameter of at least 45 inches and an inside diameter of 39 inches  $\pm 1$  inch.

Cast metal bolt anchor inserts for  $\frac{1}{2}$ -inch bolts into each wall. Ensure spacing between inserts is no greater than 24 inches. Protect the inserts during casting to prevent filling with concrete.

2. **Hardware.** Provide metallic hardware that is hot-dipped galvanized or stainless steel. Provide a complete hardware package with each handhole including the following:
- One hook ladder for hooking on the step of the grade ring when positioned at the climbing angle;
  - Four pull-in irons with backing plates;
  - Eight, 36-inch cable racks (Underground Devices Inc., No. CR36 or Department-approved equal); and
  - Sixteen, 3-inch throat saddle (Underground Devices Inc., No. 3HDS or Department-approved equal).

3. **Frame, Ring and Cover.** Provide a heavy duty cast iron frame, grade ring, and cover manufactured by East Jordan Iron Works, or a Department-approved equal. Provide a Model 1220C ring and cover, with "Signals & Lighting" cast into the cover. Do not use alternate ring and cover model numbers. Provide a frame weighing 410 pounds and a cover weighing 245 pounds.

F. **Handhole, Round, 3 foot diameter.** Construct handhole boxes from concrete.

1. **Handhole.** Provide handholes with live loads meeting the requirements of AASHTO HS 20 for wheel loading.

Ensure concrete attains a 28-day compressive strength of 4,500 psi.

Provide smooth or deformed welded wire fabric in accordance with ASTM A 185 or ASTM A 497.

Provide reinforcing steel meeting the requirements of ASTM A 615 for Grade 60 rebar, if required. Bend bars and place in accordance with the latest ACI standards.

Provide precast handholes with the following characteristics:

- a. An inside diameter of 36 inches, capable of accommodating round covers;
- b. Integral wall and base;
- c. A height of 48 inches;
- d. An outside diameter of 44 inches;
- e. One, 6-inch knockout in the base for a sump drain hole; and
- f. Walls with four tapered knock-outs for conduit entering the handhole, 2 inches deep from the inside and from 11 inches to 10 inches in diameter.

Construct the handhole to accept a heavy-duty frame and cover centered atop the handhole.

2. **Frame and Cover.** Provide a heavy duty frame and cover manufactured by East Jordan Iron Works, Model 1220, or a Department-approved equal, with "Traffic Signal" cast into the cover. Ensure the East Jordan Iron Works Model 1220 frame has an outside diameter of 45 inches, capable of accommodating a cover 31½ inches in diameter. Ensure the total assembly weighs 675 pounds.

### 918.07. Light Standard Foundation.

A. **Concrete.** Provide Grade S2 concrete in accordance with section [701](#).

**B. Steel Reinforcement.** Provide steel reinforcement as shown on the plans, and meeting the requirements of section [905](#).

**C. Anchor Bolts, Nuts, and Washers.** Provide anchor bolts, nuts, and washers meeting the requirements of subsection [908.15.A](#) and subsection [908.15.B](#). Size and place anchor bolts as shown on the plans for the required light standard. Install and tighten the anchor bolts as specified in subsection [810.03.N](#).

Provide anchor bolts with a diameter of at least 1 inch with series 8UN threads. Provide anchor bolts less than 1 inch in diameter with a coarse pitch. Provide anchor bolts threaded 1 inch beyond the anchor bolt projection shown on the plans.

**D. Ground Rods.** Use an 8-foot, copper clad steel,  $\frac{5}{8}$  inch diameter ground rod meeting the requirements of subsection [918.02.C](#).

1. **Grounding Wire.** Unless otherwise required, provide No. 6 stranded bare copper grounding wire for the street lighting unit meeting the requirements of subsection [918.02.B](#).
2. **Conduit.** Provide conduit in the foundation to allow placement of conductors and grounding wires as shown on the plans and meeting the requirements of subsection [918.01](#).

**918.08. Light Standards.** Provide steel, aluminum, or other light standard material shown on the plans. The Engineer will visually inspect welding and reject standards exhibiting poor welding workmanship.

Provide light standards designed in accordance with the AASHTO *Standard Specifications for Structural Supports for Highway Signs, Luminaires, and Traffic Signals*. Use a wind importance factor based on a recurrence interval of 50 years for the design wind speed. Do not use alternative methods for determining wind speed. Use a Category I fatigue importance factor. Submit calculations for the light standard design, sealed by a professional engineer licensed in the State of Michigan, to the Engineer for approval.

**A. Steel Light Standards.**

1. **Shafts.** Provide light standard shafts of hot rolled low carbon steel or high strength low alloy steel. Provide shafts with a tensile yield strength of at least 50,000 psi when tested before or after fabrication.
2. **Handhole.** Provide light standards with reinforced handholes with a steel cover and a grounding nut or lug located inside the shaft. Ensure the grounding nut or lug is easily accessible from the handhole.

3. **Anchor Bases.** Provide one-piece anchor bases of cast steel or hot rolled steel plate.

Provide cast steel anchor bases meeting the requirements of ASTM A 27 for Grade 65-35.

Provide hot rolled steel plate anchor bases of steel meeting the requirements of ASTM A 36, or a Department-approved equal.

4. **Bracket Arm Assembly.** Provide a bracket arm assembly of truss-type design and steel meeting the requirements of ASTM A 53 Grade B or ASTM A 36.

Ensure the installed bracket arm assembly provides a weather resistant connection with a smooth wiring raceway.

5. **Welds.** Weld in accordance with section [707](#). The Contractor may provide a shaft with one longitudinal welded joint and one transverse welded joint as shown on the plans.

Ensure the welded area is free of flat spots, protuberances, cracks, discolorations, weld splatter, mill scale, or other imperfections that would mar the appearance or structural continuity of the welded area.

Provide circumferential butt weld splices and base connection welds using full penetration welds, ground flush. The Contractor may make the remaining portion of the longitudinal weld a partial penetration weld of at least 60 percent.

Provide a base that telescopes onto the shaft. Weld the base onto the shaft with two continuous electric arc welds; one weld on the inside of the base at the end of the shaft and one weld on the outside of the shaft at the top of the base.

6. **Galvanizing.** Hot-dip galvanize light standards and related components in accordance with ASTM A 123. Galvanize the bracket arm assembly separately.

7. **Hardware.** Provide AISI Series 300 stainless steel threaded fasteners and lock washers to secure parts to the shaft.

**B. Aluminum Light Standards.**

1. **Shafts.** Provide round, octaflute, or octagonal aluminum shafts with a uniform taper.

Provide a shaft fabricated from a single piece of seamless tubing of aluminum alloy 6063, meeting the requirements of ASTM B 221.

After fabrication, ensure the shaft has physical strength properties meeting the requirements for T6 temper.

Provide aluminum alloy 356-T6 castings, except for the shaft top provide aluminum alloy 43F.

Provide sand castings meeting the requirements of ASTM B 26. Provide permanent mold castings meeting the requirements of ASTM B 108.

2. **Handhole.** Provide light standards with a reinforced handhole, a cover, and a grounding nut or lug located inside the shaft. Ensure the grounding nut or lug is easily accessible from the handhole.
3. **Bracket Arm Assembly.** Provide a bracket arm assembly of truss-type design and aluminum alloy pipe or tapered tubes. Ensure the installed bracket provides a weather resistant connection with a smooth wiring raceway.

Provide pipes meeting the requirements of ASTM B 241 for aluminum alloy 6063-T6 or 6061-T6.

Provide tapered tubes meeting the requirements of ASTM B 221 for aluminum alloy 6063-T6 or 6061-T6.

4. **Welds.** Weld aluminum in accordance with AWS D1.2, *Structural Welding Code — Aluminum*.

As required by the Engineer, qualify welding procedures by testing qualification welds.

Use two continuous welds made by the metal inert-gas method using aluminum filler metal meeting the requirements of AWS D1.2, *Structural Welding Code — Aluminum* to secure the cast aluminum anchor base to the lower end of the shaft.

Provide a base that telescopes onto the shaft. Weld the base onto the shaft with two welds; one weld on the inside of the base at the end of the shaft, and one weld on the outside of the shaft at the top of the base.

5. **Hardware.** Provide aluminum alloy 2024-T4 or AISI Series 300 stainless steel threaded fasteners, lock washers, and other pieces to secure parts to the shaft.

C. **Frangible Transformer Bases.** Provide frangible transformer bases selected from the Qualified Products List and meeting the requirements for breakaway supports as specified in the AASHTO *Standard Specifications for Structural Supports for Highway Signs, Luminaires,*

and Traffic Signals, Section 12. Provide each base with four bolts, hex nuts, washers, and lock washers meeting the requirements of subsection [918.08.C](#). Use foundation anchor bolts and lock washers meeting the requirements of subsection [918.08.D](#). Galvanize bolts, nuts, washers, and lock washers as specified in subsection [908.15.B](#).

Provide each frangible base with manufacturer covers or fiberglass covers, as shown on the plans.

D. **Anchor Bolts.** Provide anchor bolts and associated nuts, studs, and couplings meeting the requirements of subsection [908.15](#).

Zinc coat anchor bolts at least 16 inches starting from the threaded end. Hot-dip galvanize associated nuts, studs, washers, and couplings in accordance with ASTM A 153.

## 918.09. Luminaires.

### A. High Pressure Sodium Luminaires (Cobra Head Type).

1. **Housing.** Provide a luminaire housing of cast or formed aluminum, of a thickness to provide structural rigidity.

Provide a housing hood containing an integral slip fitter capable of being mounted on a 2-inch pipe bracket or a 1½-inch pipe bracket. Use inserts if necessary.

Provide mechanical means for leveling the luminaire within a range of at least  $\pm 3$  degrees from the horizontal. Provide a leveling surface on the housing exterior to mount the luminaire in the operating position.

Provide a hinge arrangement for the refractor holding ring that allows the refractor to open at least 90 degrees from the horizontal.

Provide hinges with a locking arrangement to prevent the refractor holding ring from falling.

For exposed hardware and fasteners, provide stainless steel, monel metal, or aluminum alloy hardware and fasteners. For the luminaire to bracket arm, and other internal fasteners, provide stainless steel or zinc coated steel. Provide remaining internal hardware of stainless steel, aluminum alloy, or zinc coated steel.

2. **Reflector.** Provide aluminum reflector with an ALGLAS reflector finish or with a sealed anodic coating over either an electrolytically or chemically brightened specular surface.

Ensure the anodic coating is at least 4 milligrams per square inch in accordance with ASTM B 137.

Provide coating seal meeting the requirements of ASTM B 136.

Mount the reflector to allow removal for cleaning without special tools.

Provide gaskets of ethylene-propylene terpolymer (EPT) or a synthetic fiber felt.

3. **Refractor.** Provide clear borosilicate glass refractor compatible with the reflector to give the required light distribution.

Mount the refractor to the holding ring to allow for easy replacement.

4. **Ballast.** Provide magnetic regulator-type or constant wattage auto regulator-type ballast.

Mount the ballast entirely within the luminaire housing.

Ensure the ballast includes a clearly identified lamp wattage and circuit voltage meeting the requirements of the current ANSI Specifications.

Provide ballasts with a power factor of at least 90 percent at rated voltage.

Provide a ballast that starts reliably at  $-20^{\circ}\text{F}$  over voltage variations of  $\pm 10$  percent of nominal required voltage.

Provide a ballast with a lamp starting pulse voltage no greater than 4,000 pulse peak volts.

5. **Lamps.** Provide vapor lamps as shown on the plans. Provide lamps in accordance with luminaire design burning position requirements.

6. **Socket.** Provide a socket assembly of rigid construction to ensure the lamp retains the required position during service.

Provide nickel plated brass sockets with a porcelain covering. Provide the socket with lamp grips. Provide a socket with a spring-loaded center contact.

Weld or attach sock leads with crimp type, solderless, compression connectors.

Do not use socket adapters for positioning the lamp. If the socket is capable of variable socket positions, provide information to establish the correct socket position.

7. **Wiring.** Complete internal wiring and connections so only incoming supply conductors require attachment to pressure type connectors on a terminal block.

Provide heat resistant protective tips or sleeves for the lamp cords if the lamp cord connections are directly above the lamp.

Provide a terminal block rated at 600 volts and meeting the requirements of the NEMA *Specifications for Wiring Terminals*. Provide a terminal board that accommodates crimp-on solderless compression connectors for interior wiring.

Mechanically and electrically fasten the incoming supply conductors with compression terminals to accommodate wire from No. 12 to No. 6 AWG.

Provide and mount Type FNM fuses, as shown on the plans. Refer to Table 918-1 for the amperage rating of fuses.

| Table 918-1<br>High Pressure Sodium Luminaire Fuse Requirements |                      |     |     |     |
|---|----------------------|-----|-----|-----|
| Luminaire   | Fuse Rating, Amperes |     |     |     |
|   | Circuit voltage      |     |     |     |
|   | 120                  | 240 | 277 | 480 |
| 250 W   | 10                   | 5   | 5   | 5   |
| 400 W   | 15                   | 10  | 10  | 10  |
| 700 W   | 20                   | 10  | 10  | 10  |
| 1,000 W   | 30                   | 15  | 15  | 15  |

**B. Rectangular Luminaires.** Provide rectangular luminaires as required.

**918.10. Tower Lighting Unit.** Provide tower lighting units designed in accordance with AASHTO *Standard Specifications for Structural Supports for Highway Signs, Luminaires and Traffic Signals*. Use a wind importance factor for the design wind speed, based on a recurrence interval of 50 years. Do not use alternative methods for determining the wind speed. Use a Category I fatigue importance factor. Submit calculations for the light standard design, sealed by a professional engineer licensed in the State of Michigan, to the Engineer for approval.

**A. Shaft and Base.** Provide steel shaft and base from a single thickness steel plate with no laminations. Provide a shaft fabricated from steel, meeting the requirements of ASTM A 572 for Grade 50 or ASTM A 607 for Grade 50. Provide shafts and bases with a silicon content no greater than 0.060 percent or with a silicon content from 0.150 percent to 0.250 percent.

Base design calculations on a yield strength no greater than 50,000 psi.

Provide pole sections with a wall thickness of at least  $\frac{3}{16}$  inch. Provide anchor bolts, nuts, and washers meeting the requirements of subsection



[908.14.A](#) and subsection [908.14.B](#). Install and tighten anchor bolts as specified in subsection [810.03.N](#).

Provide shafts with an overall diameter of at least 23½ inches at the base, with uniform taper to the top to a diameter of at least 6 inches.

Provide a shaft and base fabricated at a structural steel plant certified by the American Institute for Steel Construction for the Category Bridge and Highway Metal Components and as specified in section [707](#), except as modified by this subsection.

1. **Handhole.** Provide shafts with hinged doors fabricated from the same material as the shafts. Provide doors at least 24 inches by 14 inches in size. Provide doors with a hasp for a padlock. Place access holes so they do not intersect the longitudinal seam weld on the pole.
2. **Galvanizing.** Hot-dip galvanize poles and related components in accordance with ASTM A 123.
3. **Welds.** Use submerged arc welding (SAW) for the longitudinal seam and circumferential welds. Ensure circumferential seams are full penetration groove welds.

Ensure longitudinal seams at slip joints with 1½ diameters, and welded splice areas are full penetration groove welds on both sections 10 inches beyond the splice end.

Grind weld reinforcement flush on the faying surfaces in the slip joint area for the entire length of the full penetration weld.

Ensure longitudinal welds other than in the slip joint area have a penetration of at least 60 percent.

Ensure base plate joints are full penetration single bevel groove welds with reinforcing fillet welds.

Provide non-destructive testing on welds as required. Ensure the personnel performing the ultrasonic testing (UT) and magnetic particle inspection testing (MT) are qualified as NDT Level II or Level III in accordance with ASNT STN-TC-1A. The Engineer must witness both MT and UT. Provide the Engineer with certified inspection reports from the ANST inspector for welds tested.

- a. **Magnetic Particle Testing.** Perform MT on welds in accordance with subsection [707.03C.9.b](#).
- b. **Ultrasonic Testing.** Use the shear wave or angle beam method to perform UT of 100 percent of the full penetration groove

welds. Perform UT in accordance with ASTM E587-94, "Standard Practice for Ultrasonic Angle Beam Examination by the Contact Method" and AWS D1.1 "Structural Welding Code-Steel," except as modified by this subsection.

Use UT to evaluate the full penetration groove weld of the slip joints as cyclically loaded, nontubular connections. Evaluate materials thinner than  $\frac{5}{16}$  inch as shown in Table 6.3 of AWS D1.1, by UT indications in accordance with this subsection. Before beginning inspection, establish the material thickness and the near field of the transducer to ensure detection of relevant indications with repeatable results. Evaluate flaws at the location of the sound path beyond the first leg, as specified in Table 6.6 of AWS D1.1. Establish the material thickness and near field of the transducer to ensure near field interference is not a factor in the testing.

For inspection test reporting, use Form D-11 of Annex D, AWS D1.1, or an equivalent form containing information for identifying and classifying indications found during the inspection process.

- c. **Equipment and Calibration.** Provide pulse-echo type ultrasonic units capable of generating, receiving, and amplifying electrical impulses for the required application. Use instruments equipped with a decibel or attenuation control. Calibrate instruments to ensure performance in the operation range. Qualify equipment as specified in Section 6.24 of AWS D1.1.

Provide piezo-electric type search units (transducers) coupled to a 70-degree wedge. Before calibrating for testing, verify the angle is within  $\pm 2$  degrees. Mark the exit point on the side of the transducer if different from the original exit point.

Provide a search unit with a 5.0 megahertz frequency and a diameter no greater than  $\frac{1}{2}$  inch. Calculate the near field using Formula 918-1 or Formula 918-2.

$$N = \frac{(D^2 \times F)}{(4 \times V)} \quad \text{Formula 918-1}$$

$$N = \frac{D^2}{(4\lambda)} \quad \text{when } \lambda = \frac{V}{F} \quad \text{Formula 918-2}$$

Where:

$N$  = near field (in),

$D$  = transducer diameter (in),

$F$  = frequency (MHz),

$V$  = velocity (in/sec x  $10^6$ ), and

$\lambda$  = wavelength (in).

Use glycerin-type couplant. Perform calibrations using the same type of couplant as used to perform the inspection.

Before beginning the calibration procedure, ensure the operator verifies reject controls are turned off. Use of the reject controls may alter the amplitude linearity of the instrument and invalidate the test results. Calibrate the ultrasonic equipment in accordance with Section 6.25 of AWS D1.1.

- d. **UT Acceptance Criteria.** Perform ultrasonic inspections in accordance with Section 6.13 of AWS D1.1. Perform the inspection beyond the first leg of the sound path to avoid the near field effects. If recording indications, note the leg of the sound path where the signal peaks. Calculate the sound path, or full V-path, using Formula 918-3.

$$SP(FVP) = \frac{2T}{\cos \angle} \quad \text{Formula 918-3}$$

Where:

$SP(FVP)$  = sound path, or full V-path, (in),

$T$  = material thickness (in), and

$\angle$  = wedge angle.

The Engineer will accept or reject the weld in accordance with Table 6.3 of AWS D1.1 for  $5/16$  inch material thickness, except the values shown in the table will be reduced by 10 decibels to account for the thinner material tested and the modified frequency and diameter of the search unit.

Prepare the surface so that the transducer can be freely manipulated through the full surface area to evaluate the sound path. The Contractor may grind or use other means to clean the surface before inspection. Test in accordance with Section 6.26 of AWS D1.1. Calculate attenuation in accordance with Section 6.26.6.4 of AWS D1.1. Due to the short length of the

sound path in thin materials, in most cases attenuation will not be a factor.

4. **Fabrication.** Ensure the supplier keeps test records available for review upon request.

Do not weld identification marks or other stray tack welds on the poles.

Clean steel components and welds using sand blasting or other methods approved by the Engineer before galvanizing.

Use Tempil indicating crayons or direct temperature instruments to verify preheat.

- B. **Head Frame Assembly.** Provide a headframe assembly with a pair of pulleys located for each stainless steel cable supporting the luminaire ring. Provide a roller assembly or a single pulley for the power cord. Provide a hoisting system with two or three stainless steel cables at the head frame assembly.

1. **Power Cord Roller Assembly.** If using a roller assembly to support the power cord, provide six rollers mounted between two cold-rolled steel plates that are zinc-electroplated in accordance with ASTM B 633, and yellow chromatic-dipped. Ensure the power cord rides on rollers of acetate resin meeting the requirements of ASTM D 2133-65, for Grade II mounted on AISI 304 stainless steel shafts. Locate the six rollers to support the power cord in a bending radius of at least 7 inches. Except for pulleys and rollers, fabricate parts of the assembly from ASTM A 572 Grade 345 steel.

Design the assembly to protect parts from the weather.

2. **Power Cord Pulley.** If using a pulley to support the power cord, provide pulleys fabricated from a single piece of galvanized steel, with a diameter of at least 16 inches.
3. **Pulleys for Stainless Steel Support Cables.** Provide pulleys for the stainless steel cables with a diameter of at least 6 inches and fabricated from one piece of stainless steel or galvanized steel.

Provide pulleys with permanently lubricated bronze bearings and stainless steel axle pins. Ensure the depth of the vee on pulleys at least equals the diameter of the cable. Provide guards to prevent cables from riding off the pulleys.

4. **Latching.** The Contractor may locate the latching mechanism for the luminaire mounting ring at the head frame assembly or at the base of the pole.

If completing latching at the head frame assembly, provide three latches as an integral part of the head frame assembly. Latch the luminaire mounting ring by the alternate raising and lowering of the luminaire ring assembly using the winch and hoisting assembly. Attach moving parts of the latching mechanism to the luminaire ring assembly. Ensure the moving parts are serviceable at ground level. Ensure the luminaire ring does not move horizontally or rotate around the pole during the latching or unlatching process. Use indicator flags, visible from the ground, to signal the latching and locking of each latching mechanism.

If using a two cable hoist system, provide for the latching of the luminaire mounting ring at the base of the pole. Provide a cable anchoring device to latch each supporting cable in place.

**C. Luminaire Mounting Ring.** Provide a luminaire mounting ring capable of supporting 2 inch diameter mounting tenons, complete with ballasts, evenly distributed around the ring for mounting the required number of luminaires. Ensure the luminaire mounting ring provides a raceway or enclosure for the required electrical connections to the luminaires.

Provide the mounting ring with at least No. 12 AWG copper wire rated at 200 °F.

Provide a galvanized steel luminaire mounting ring and related components. Galvanize using the hot-dip method in accordance with ASTM A 123 after welding fabrication.

Equip the luminaire mounting ring with a weatherproof male receptacle to energize the luminaires in the lowered position. Ensure connections are weather tight and protected when the luminaires are in the operating position.

Make provisions for centering and damping contacts the luminaire mounting ring may encounter while ascending and descending the pole.

Provide roller-contact with spring-loaded centering arms located on the luminaire mounting ring. Ensure the luminaire ring centering device maintains the ring concentric with the pole.

**D. Luminaires for Tower Lighting.** Provide luminaires capable of operating at mounting heights greater than 100 feet. Provide luminaires capable of withstanding wind velocities of 120 feet per second and resulting vibrations. Provide a luminaire that weighs no more than 94 pounds. If mounted in operating position, ensure an area no greater than 5.4 square feet is exposed to the wind.

Provide luminaires meeting the requirements specified by the following.

1. **Housing.** Provide a structurally rigid luminaire housing of cast or formed aluminum with a copper content no greater than 0.2 percent.

Provide a housing containing an integral slip fitter mounted on a 2-inch pipe bracket or a 1½-inch pipe bracket with inserts, if necessary.

Provide a mechanical means to limit insertion of the pipe arm. Provide a mechanical means for leveling the luminaire to within a range of ±3 degrees from the horizontal.

Provide a leveling surface on the housing exterior to mount the luminaire in the operating position. For luminaires producing asymmetrical light distributions, orient to distribute the light as shown on the plans. For exposed exterior hardware and fasteners, provide stainless steel, monel metal, or aluminum alloy hardware and fasteners. For the luminaire-to-bracket arm mounting fasteners and other internal fasteners, provide stainless steel or zinc coated steel fasteners. Provide remaining internal hardware of stainless steel, aluminum alloy, or zinc coated steel.

2. **Reflector.** Provide aluminum or glass reflectors, affixed to the refractor or the cover glass with a gasket. Provide extruded silicone rubber or synthetic fiber felt gaskets.
3. **Aluminum Reflector.** Provide enclosed aluminum reflectors fabricated with ALGLAS reflector finish or a sealed anodic coating over an electrolytically or chemically brightened specular surface. Provide optical parts that are weather tight and bug tight. Provide a coating that is at least 4 milligrams per square inch in accordance with ASTM B 137. Provide a coating seal meeting the requirements of ASTM B 136. The fabricator must submit certification that the reflector coating meets requirements, upon the Engineer's request.
4. **Glass Reflector.** Provide one piece clear borosilicate glass reflectors free of bubbles and ripples. Protect the reflector back surface from the effects of atmospheric oxidation and moisture.
5. **Cover Glass.** If required, provide clear tempered cover glass. Mount the cover glass to the holding ring, but allow for easy replacement.

Use an ethylene-propyleneteropolymer (EPT) or synthetic fiber felt gasket for the cover.

6. **Ballast.** Mount the ballast or ballast housing on the luminaire housing. Ensure the ballast, ballast housing, and luminaire housing are entirely enclosed. Install a gasket between the ballast housing and luminaire housing. Provide ballasts designed to operate at the rated voltage shown on the plans.

Identify the ballast lamp wattage and circuit voltage in accordance with ANSI C 82.4.

Provide a regulating auto-transformer type ballast. Ensure an applied primary voltage change of  $\pm 10$  percent of line nominal at the ballast does not cause more than a  $\pm 13$  percent change in lamp wattage. Ensure a power factor of at least 90 percent at the rated voltage. Provide a ballast that starts reliably at  $-20$  °F with  $\pm 10$  percent of line nominal voltage variations.

7. **Lamp.** Provide lamps of the type and size shown on the plans.
8. **Socket.** Provide a socket assembly of rigid construction to ensure the lamp retains the required position during service. Do not use socket adapters for positioning lamps.

Provide nickel plated brass sockets with a porcelain covering. Provide a socket with lamp grips. Provide a socket with a spring loaded center contact. Weld or attach sock leads with crimp-type, solderless, compression connectors.

If the socket is capable of variable socket positions, provide information to establish the correct socket position.

9. **Wiring.** Complete internal wiring and connections so only incoming supply conductors require attachment to pressure type connectors on a terminal block.

Provide a terminal block rated at 600 volts and meeting the requirements of the NEMA *Specifications for Wiring Terminals*. Provide a terminal board that accommodates crimp-on solderless, compression connectors for interior wiring.

Mechanically and electronically fasten the incoming supply conductors with compression terminals to accommodate wire from No. 12 to No. 16 AWG.

10. **Fusing.** Provide and mount inline FNM type fuses in the luminaire housing. Provide fuses with the current ratings in Table 918-2:

| <b>Circuit Voltage</b> | <b>Current Rating</b> |
|------------------------|-----------------------|
| 120 volts              | 30 amperes            |
| 240 volts              | 15 amperes            |
| 277 volts              | 15 amperes            |
| 480 volts              | 15 amperes            |

11. **Painting.** Paint the luminaire housing metallic gray.
12. **Packaging.** Pack luminaires individually for shipment.
13. **Assembly Drawings.** Provide assembly and installation drawings.
14. **Sampling and Testing.** Provide Test Data certification for tower lighting luminaires.

E. **Lowering Device.** Equip the inside of each tower lighting unit with an electric motor and a hoisting device capable of raising the required number of luminaires plus 300 pounds to the operating position and lowering the luminaires to 5 feet above the foundation. Ensure raising and lowering operations can be controlled 15 feet from the pole base. The Contractor may use a transformer to obtain the desired voltage of the motor for remote operation.

Provide a lowering device with a worm gear, gear reducer hoist of at least 30:1, with supporting, hoisting, and electric cables to the luminaire mounting ring.

Mount the hoist inside the pole base with stainless steel hardware. Provide the hoist drum with a stainless steel cable at least  $\frac{1}{4}$  inch in diameter, attached to the hoist drum and long enough for at least one complete layer on the drum plus the length required to lower the luminaire mounting ring to the lowest position.

If using a single hoisting cable, provide a cable junction plate to join the three supporting cables to the hoisting cable and to hold the lower end of the electric cable. Ensure the junction plate is accessible through the handhole when the luminaire mounting ring is in the raised position. Provide three stainless steel supporting cables  $\frac{3}{16}$  inch in diameter. Provide means to adjust the length of each of the three supporting cables by 4 inches, with the luminaire mounting frame at the top of the pole. As an alternative, the Contractor may provide for each of the three supporting cables to terminate through a coil spring under compression, so when the luminaire mounting ring is in the raised position, differences in tension of one or two cables will compensate for a difference of 3 inches in the length of those cables.



F. **Electric Cable.** Provide portable power cable Type W-4, round, 600 volt, No. 8 AWG, copper electrical cables with 133 strands in each conductor, rated at 167 °F. Provide cable that meets the requirements of ICEAS-19-81.

Provide the same type of cable for the electric supply from the safety switch to the terminal block in the pole, and from the terminal block to the twist loc connector. Ensure the cable reaches through the handhole in the pole to serve as a power source for the electric drill or motor to operate the lowering device.

Where the electric cable attaches to the cable junction, provide a strain relief grip to hold the electric cable. Provide a strain relief grip that has an insulated compression-type connector, capable of supporting the cable when the luminaire mounting ring is lowered. Where the electric cable connects to the luminaire mounting ring, provide a similar strain relief grip to hold the other end of the electric cable.

G. **Lightning Arrestor.** Mount a lightning arrestor, of the operating voltage and conditions necessary, inside the pole base. Ensure the lightning arrestor is accessible through the handhole, and connected between the load side of the fused safety switch and the pole grounding lug by the shortest practical connections.

H. **Twist Loc Connector.** Provide a 600-volt, UL 50 ampere, three-pole, four-wire, twist-type connector. Provide a power cord from the luminaire mounting ring with a male plug, and a supply cord with a female plug.

I. **Electric Drill/Motor.** Provide an electric drill or motor to operate the hoisting device. If using an electric drill, provide a 240 volt, heavy duty, industrially rated, ½-inch capacity, electrically reversible electric drill with special chuck to fit the lowering device hoist. Provide an electric drill with a special mounting bracket for attaching to the hoist through the handhole in the pole. Provide an electric drill with a special electric cord.

If using an electric motor, use a reversible, standard frame motor with a magnetic brake.

Mount the drill or motor frame, so it is connected to the hoist without being held by other means. Provide a drill or motor that operates the hoist in either direction, from the mounted position.

Provide a flexible, electric cord with heavy-duty 600-volt insulation for the drill or motor and an attachment plug that fits the 240-volt outlet in the metal pull box. Provide a momentary push button control in the electric cord for the drill or on a separate cord from the drill, to allow operation of

the drill in either direction, or stopping when the operator is as far as 15 feet from the pole.

Provide a test cable with the drill or motor to energize the luminaires when the mounting ring is in the lowered position. Provide the same type cable as the electric cable up the pole. Provide a cable that includes the required fittings and a length to connect the electric supply to the weather tight outlet in the luminaire frame.

**J. Foundation.** Construct the foundation for the tower lighting unit as shown on the plans. Ensure the pole manufacturer provides the anchor bolts for installation in the foundation.

Provide each anchor bolt with two nuts for plumbing the pole. Zinc coat the upper 15 inches of the bolts and the nuts in accordance with ASTM A 153. Provide anchor bolts and associated nuts, washers, and hardware meeting the requirements of subsection [908.15](#). Install anchor bolts as specified in section [810](#).

**K. Fused Safety Switch.** Provide the fused safety switch as shown on the plans.

**918.11. Wood Poles.** Provide western red cedar, red pine, or southern pine poles meeting the requirements of ANSI Specification 5.1 and P.L.D. Specification for Wood Poles.

Incise the circumferential surface area of poles beginning from at least 24 inches below the ground line and extending to at least 12 inches above the ground line. Machine shave poles full length above the incised area.

Treat poles full length in accordance with AWWA *Standard for the Preservative Treatment Wood Poles*.

Provide pentachlorophenol-petroleum preservative solution in accordance with AWWA Standards P8-64 and P9-65. Provide a solution containing at least 5 percent of pentachlorophenol by weight.

**A. Guys and Guy Anchors.** Provide extra high strength grade seven-strand guy wire. Provide heavy, two-bladed, malleable iron expansion-type guy anchors. Provide galvanized  $\frac{3}{4}$  inch by 8-foot thimble eye type guy anchor rods. Provide anchor guys with metal or plastic guards.

**B. Miscellaneous Hardware.** Provide hot-dip galvanized miscellaneous pole line hardware that is a standard product of electrical materials manufacturers.

**Section 919. PERMANENT TRAFFIC SIGN AND SUPPORT MATERIALS**

**919.01. General Requirements.** Permanent traffic signs and sign support material must meet the requirements of the [MDOT Sign Support Standard Plans](#) and this section.

Cantilever, truss, breakaway column, and aluminum structure inspection must be in accordance with section [707](#) and this section.

**919.02. Traffic Signs.** The Department classifies signs by type of sign panel material and type of sign face, as follows:

| Table 919-1<br>Sign Panel and Face Types |                             |   |
|--|-----------------------------|---|
| Sign Panel                               |                             |   |
| Type                                     | Material                    | Size Limits   |
| I  | Aluminum Extruded Sections  | Height > 48 in or Width > 144 in  |
| II                                       | Plywood                     | Height = 48 in and Width = 24 in<br>From Height ≥ 36 in and Width ≥ 36 in<br>up to Height ≤ 48 in or Width ≤ 144 in |
| III                                      | 0.080 in Aluminum Sheet (a) | 36 in by 36 in  |
| IV                                       | 0.040 Aluminum Sheet (a)    | Overlay   |
| Sign Face                                |                             |   |
| Type                                     | Background                  | Legend  |
| A  | Reflectorized               | Reflectorized   |
| B  | Reflectorized               | Non-reflectorized   |
| C  | Non-reflectorized           | Reflectorized   |

a. Corners must be rounded on aluminum sheet signs

**A. Sign Panel Material and Fabrication.**

1. **Aluminum Extruded Sections.** Provide aluminum extruded sections in a variety of widths with plain butt-type edges for connecting to adjoining horizontal sections. Sections must be one-piece with no vertical splices and have a cross-sectional shape meeting the minimum requirements specified in Table [919-2](#). Sections must have at least a 0.125-inch nominal thickness. Exterior corners must have a radius of at least 0.040 inch.

Sign panel sections must be extruded aluminum alloy 6063-T6, meeting the requirements of ASTM B 221. Panel sections, after fabrication, must be flat to within 0.031 inch or less per foot of length and to within 0.004 inch or less per inch of width.

Degrease aluminum extruded sign panel sections in accordance with the sheeting manufacturer's recommendations. After degreasing, surface treating, and rinsing, maintain sign panels free of grease, oil, or other contaminants.

**Table 919-2**  
**Cross-Sectional Requirements for Extruded Aluminum**  
**Sign Sections for Type I Sign Panels**

| Length of Sign Support Type                                     | Moment of Inertia | Section Modulus | Elements of Cross Section |       |              |       |
|---|-------------------|-----------------|---------------------------|-------|--------------|-------|
|   |                   |                 | No Free Ends              |       | One Free End |       |
|   |                   |                 | b/t                       | ≥l/y  | b/t          | ≥l/y  |
| ≤30 ft on Columns<br>≤20 ft on Cantilevers<br>≤30 ft on Trusses | ≥0.94 W           | ≥0.55 W         | 8-50                      | 56.0C | 5-28         | 32.0A |
|   |                   |                 | >50                       | 3.4D  | >28          | 11.6B |

Note: b = the compression width of stiffener elements in inches.  
t = the thickness of the stiffener element in inches.  
I = moment of inertia of the sign section in inches<sup>4</sup>.  
y = the distance from the neutral axis to the centroid of the compression width of the element.  
W = the width of the sign section in feet.  
A = W/(63-b/t).  
B =  $1.0 \times 10^{-4} W(b/t)^2$ .  
C = W/(111-b/t).  
D =  $1.0 \times 10^{-4} W(b/t)^2$ .

Connect the sections horizontally with 3/8 inch diameter stainless steel bolts, spaced as shown on the Sign Support Standard Plans. Section connections or sign-to-post connections must have no fasteners that project through the sign panel face.

If using a 6 inch plank, position the plank second from the bottom of the sign.

Before transporting sign panels, ensure the support angles and wide flanged shapes are shop connected and remain on the sign.

2. **Plywood.** Plywood sign panels must be 5/8 inch thick and have a black or natural color overlay on both sides. Panels must meet the requirements of the U.S. Product Standard PS-1-83 for Group 1 wood species, Grade B-B veneer, exterior type, high-density overlaid plywood. Inner plies must meet the requirements of Section 3.8.1, "Crossband Gaps and Center Gaps" of the U.S. Product Standard PS-1-83. Inner plies must have no continuous core gaps, tunnels, holes, or through openings that travel longitudinally or transversely through the plies, as measured from the panel edge. Crossband gaps or center gaps allowed by the U.S. Product Standard PS-1-83 must be filled with a synthetic filler repair, in accordance with Section 3.3, "Synthetic Repairs" of the U.S. Product Standard PS-1-83. Smooth and seal edges with one coat of exterior oil base paint.

Do not make vertical splices in plywood signs. The Engineer will allow horizontal splices only for gore signs. Do not splice plywood sign panels, unless otherwise shown on the sign details. Do not

make horizontal splices through legends or symbols. Round the corners and remove burrs at corners and mounting holes.

Prepare the plywood high-density overlay surface for sheeting application by lightly abrading the surface with a product recommended by the sheeting supplier. Do not power sand. Wipe the surface with a solvent and allow to dry in accordance with the sheeting manufacturer's recommendations.

After preparing the plywood surface, ensure no grease, oil, or other contaminants come in contact with the surface.

3. **Aluminum Sheet.** Aluminum sheet for Type III and Type IV sign panels must meet the requirements of ASTM B 209 for aluminum alloy 6061-T6, 5052-H38, or 5154-H38.

Aluminum sheet for Type III sign panels must be fabricated from nominal 0.080 inch thick aluminum sheet with mill tolerance meeting the requirements of ASTM B 209. Aluminum sheet for Type IV overlay sign panels must be fabricated from at least nominal 0.040 inch thick aluminum sheet, at least 0.037 inch thick.

Round the corners and remove burrs at the corners and mounting holes.

Degrease the aluminum sheet in accordance with the sheeting manufacturer's recommendations. After degreasing, surface treating, and rinsing, maintain sign panels free of grease, oil, or other contaminants.

## B. **Sign Face and Legend Material.**

1. **Reflective Sheeting Material.** Select reflective sheeting for permanent signs from the Qualified Products List. Provide sheeting meeting the requirements of ASTM D 4956 and the ASTM Types specified in Table [919-3](#), unless otherwise required.

Provide the Engineer with written certification that reflective sheeting meets the following requirements:

- a. Sheeting material on each sign is an approved product, obtained from the same sheeting manufacturer, and applied in accordance with the manufacturer's recommendations;
- b. Signs are manufactured in strict compliance with the sheeting manufacturer's requirements; and
- c. Each 145 foot length roll of reflective sheeting contains no splices.

Certification must include lot numbers, run numbers, shipping date, invoice number, stock number, and quantities of material for each sign shipment.

2. **Sheeting Application.** Fabricate and apply legends in accordance with the [\*Michigan Standard Highway Signs Manual\*](#), or as shown on the plans.
3. **Direct Applied Reflective Legend.** Cut legends with a smooth, regular outline, free of ragged or torn edges, and with interior corners cut to  $\frac{3}{16}$  inch  $\pm$   $\frac{1}{16}$  inch radius.

Apply legends in accordance with the reflective sheeting manufacturer's recommendations.

For Type I aluminum extruded sign sections, cut the legend components along each metal sign section joint after applying the legend.

4. **Non-Reflective Legend, Borders and Arrows.** If a black legend is required, it must be applied using ink, silkscreen method, or non-reflective sheeting. Black sheeting used for legend, borders, and arrows must be non-reflective material unless otherwise stated. Provide material and apply non-reflective legends, borders and arrows in accordance with the manufacturer's specifications.

**C. Sign Hardware.** Steel shapes, bars, and plates must meet the requirements of ASTM A 36, or Department-approved equal, and be hot-dip galvanized in accordance with ASTM A 123.

Bolts, nuts, washers, U-bolts, and straps must be stainless steel alloy meeting the requirements of ASTM A 320, for Class 1, Grade B8. Provide self-locking, nylon insert-type nuts meeting the requirements of ASTM A 320 and ASTM A 194 for Grade 8F. If using U-bolts formed from straight bar stock, ensure U-bolts are formed by cold working.

Aluminum alloy shapes and plates must meet ASTM B 308, for aluminum alloy 6061-T6.

Cast post clips must conform to ASTM B 108, for aluminum alloy 356.0-T6.

**Table 919-3  
Retroreflective Sign Sheeting Material Guidelines**

| <b>Sign Category</b>    | <b>Type</b>  | <b>Material Type</b> | <b>Color</b>                  |
|-------------------------|--|----------------------|-------------------------------|
| Yellow Warning Signs    | W-series (non school related), E13-1, E13-2, E11-1, OM-1, OM-2, OM-3           | ASTM Type IX         | Fluorescent Yellow            |
| School Signs            | S1-1, S4-3, S4-5, S4-5a, school portion of S5-1, W16-7p, W16-9p, W16-2, W16-2a | ASTM Type IX         | Fluorescent Yellow Green      |
| Freeway Guide Signs     | White legends; borders; and arrows;  | ASTM Type IX         | White                         |
| Freeway Guide Signs     | Background including M8 series signs   | ASTM Type IV         | Green, Brown, or Blue         |
| Non Freeway Guide Signs | All  | ASTM Type IV         | White on Green, Brown or Blue |
| Regulatory Signs        | Stop, Yield, parking, black on white signs                                     | ASTM Type IV         | —                             |
| Route Markers           | —  | ASTM Type IX         | —                             |

**919.03. Delineators.** Fabricate reflectors for delineators from plastic material or reflective sheeting material, as shown on the plans. Provide the Engineer a copy of the manufacturer's certification that reflectors and posts meet the requirements of this subsection.

**A. Plastic Reflectors.** Reflectors for mounting on rigid post must consist of a round, clear, and transparent plastic lens, with a back fused to the lens, under heat and pressure, around the perimeter to form a unit sealed against dust, water, and vapor. The unit must have a central mounting hole and the lens must have a nominal reflecting area of 7 square inches. The lens must have a smooth outside surface and an inside configuration which provides "cube-corner" retro-reflection. The manufacturer's trademark must be legibly molded into the face of the lens.

Plastic reflectors must have plastic or aluminum housing. An aluminum or plastic grommet with an inside diameter of  $\frac{3}{16}$  inch must be expanded within the reflector mounting hole and flanged. The Contractor may use plastic reflector housing consisting of acrylonitrile butadiene styrene (ABS) plastic meeting the requirements of ASTM D 3965 with a tensile strength of at least 6,500 psi.

- 1. Optical Performance.** At least 90 percent of the reflectors tested must meet or exceed the values specified in Table 919-4 for the required color. One hundred percent of the reflectors tested must meet or exceed 80 percent of the values specified.

| Table 919-4<br>Specific Intensity (SI) of Plastic Reflectors for Delineators |      |                                |    |                                |    |
|--|------|--------------------------------|----|--------------------------------|----|
| Color  | Type | SI candelas/foot-candle        |    |                                |    |
|  |      | Divergence Angle<br>0.1 degree |    | Divergence Angle<br>0.2 degree |    |
|  |      | Entrance Angle (degree)        |    | Entrance Angle (degree)        |    |
|  |      | 0                              | 20 | 0                              | 20 |
| Crystal or Silver  | A    | 120                            | 50 | 84                             | 35 |
| Yellow   | A    | 71                             | 28 | 50                             | 20 |
| Red  | A    | 29                             | 11 | 21                             | 8  |

**B. Reflective Sheeting Reflectors.** Reflective sheeting for mounting on flexible posts must meet the material, color, and resistance to weathering requirements of ASTM D 4956 for Type IX flexible high-intensity retroreflective sheeting.

When reflective sheeting reflectors are specified, or allowed for used in lieu of plastic reflectors, use yellow (amber) sheeting in place of yellow plastic reflectors and white (silver) sheeting in place of crystal plastic reflectors. Place a 3 inch by 6 inch piece of red reflective sheeting on the back side of the flexible post showing wrong-way movement for freeway ramps, as shown on the standard plans. Apply reflective sheeting in accordance with the manufacturer's specifications.

**C. Mounting Hardware.** Mounting hardware for plastic reflectors must consist of a solid aluminum pin with annular locking grooves and an aluminum crimp-type collar. Both the pin and the collar must meet the requirements of ASTM B 308, for aluminum alloy 6061.

The pin must be  $\frac{3}{16}$  inch diameter, have a  $\frac{7}{16}$  inch diameter bearing head, and have a grip length equal to the total thickness of material fastened together.

The collar must have a bearing diameter from  $\frac{3}{8}$  inch to  $\frac{7}{16}$  inch and be sized to fit the pin.

**D. Posts.** Provide steel or flexible plastic delineator posts, as shown on the plans. Steel delineator posts must have a nominal weight of 1.12 pounds per foot and meet the requirements of subsection [919.04](#) for steel posts. Select flexible plastic delineator posts from the Qualified Products List.

**919.04. Steel Post Sign Supports and Square Tubular Steel Sign Supports.** Steel post sign supports and square tubular steel sign supports, including sign posts, anchor sleeves, and anchor posts, must meet the requirements of ASTM A 702, for Type A or Type B.



**A. Steel Post Sign Supports.** The length of finished posts must be as shown on the plans. Posts must be straight with a smooth, uniform finish, free of cracks, flaws, injurious seams, laps, blisters, ragged and imperfect edges, or other defects affecting the strength, durability, or appearance of the posts. Cross-section and bolt hole diameter and spacing must meet the requirements shown on the sign support standard plans. The centers of the holes must coincide with the centerline of the posts. The punched bolt holes must provide a smooth, even sign post face. Holes and cutoff ends must be free of burrs.

After fabrication and hole punching, hot-dip galvanize steel posts in accordance with subsection [907.03.D](#).

Punched and coated posts must weigh at least 95 percent of the nominal weight shown on the plans.

**B. Square Tubular Steel Sign Supports.** Square tubular steel sign supports must meet the chemical, mechanical, and geometric properties of material used in the crash tests referenced in AASHTO Standard Specifications for Structural Supports for Highway Signs, Luminaries and Traffic Signals.

Sign posts, anchor sleeves, anchor posts, and connection hardware must be of the size and type shown on the Sign Support Standards.

Submit proof of compliance that the assembly was crash tested in accordance with AASHTO Standard Specifications for Luminaries and Traffic Signals. The proof of compliance must include a copy of the FHWA approval letter to the manufacturer, indicating that the FHWA interprets the crash test results as acceptable for use on federal-aid projects.

The sign post, anchor sleeve, and anchor post must be straight and have a smooth uniform finish, free from cracks and flaws or other defects affecting their strength or durability. All ends must be free from burrs and must be cut square to maintain telescoping characteristics.

Bolt holes of the diameter specified must be accurately spaced on all four sides of the sign post, anchor sleeve and anchor post. Holes must line up exactly opposite each other on opposing sides of the post in order to accommodate a bolt placed through two opposite sides. The center of the holes must coincide with the centerline of the sign post, anchor sleeve and anchor post.

The bolt holes must be punched so that the face of the sign post, anchor sleeve and anchor post will have a smooth even surface.

The sign post, anchor sleeve, and anchor post must be hot-dip galvanized, after fabrication and hole punching, in accordance with ASTM A 123 for Grade 65.

**919.05. Sawed Wood Posts for Highway Signs.** Sawed wood posts for highway signs must meet the requirements of section [912](#) and Sign Support Standard SIGN-210.

**919.06. Breakaway Column Sign Supports.** Structural steel for column sign supports and bolts, nuts, and washers for the structural steel joints must meet the requirements of Sign Support Standard SIGN-220.

Shims must be fabricated from brass shim stock or brass strip meeting the requirements of ASTM B 36, for copper alloy UNS No. C26000, half-hard rolled temper, or fabricated from galvanized sheeting meeting the requirements of ASTM A 526, for Coating Designation G 90.

Galvanizing runs or beads must be removed from contact surfaces of columns, plates, and washers.

Breakaway column sign supports must be welded and galvanized and must be within the dimension tolerances specified by subsection [919.07](#).

**919.07. Cantilever Sign Supports.**

**A. Types E and J.** Pipe for the vertical poles of types E and J supports, and horizontal arms of type E supports, must meet the requirements of ASTM A 53 for Grade B, Type E, or Type S steel pipe or the requirements of API 5L for Grade X42 to X52.

Pipe for the horizontal arms of type J, must meet the requirements of ASTM A 500, Grade B or the requirements of ASTM A 519-4140 annealed.

Gusset, flange, and base plates must meet the requirements of ASTM A 36 for structural steel. Plates must be free of sharp edges and irregularities.

**B. Castings.** Pole top and end cap castings must meet the requirements of ASTM A 126 for Class A castings.

**C. Bolts for Arm Connections.** Galvanized high-strength steel bolts, nuts, and washers for connecting arm connection flanges must meet the requirements of subsection [906.06](#).

**D. Dimension Tolerances.** Dimensional tolerances for each type of commodity must meet the requirements of ASTM A 6 or the ASTM standard applicable to the required material.

E. **Welding.** Weld in accordance with AWS D1.1, Structural Welding Code, “Steel” as amended by this section, or the contract.

F. **Galvanizing.** Galvanize steel anchor bolts for a length of at least 20 inches from the threaded end. Bolts, nuts, and washers must be hot-dip galvanized in accordance with ASTM A 153.

After welding assemblies and sign support attachments, blast clean base plates and welds to remove excess mill scale and welding slag. Blast clean other areas as directed by the Engineer. Hot-dip galvanize supports in accordance with ASTM A 123.

**919.08. Truss Sign Supports.** Before applying dead loads, trusses must be cambered so the ordinate is within the allowable tolerances at the center of the assembled truss for the span length and type shown on the plans. Ensure bearing surfaces fully contact each other in the relaxed position before tightening the flange bolts. The fabricator will determine the method of cambering the structure, with the Engineer’s approval, to ensure the method does not induce stress into the truss.

A. **Materials.** Hollow structural tubing for horizontal arms must meet the requirements of ASTM A 500 for Grade B, the requirements of ASTM A 519-4140 annealed, or the requirements of API-5L for Grade X42. Safeguard hollow structural tubing against embrittlement in accordance with ASTM A 143.

Pipe for vertical poles must meet the requirements of ASTM A 53 for Grade B, Type E, or Type S steel pipe, or the requirements of API 5L for Grade X42 to X52.

Bar, plate, and rolled structural shapes must meet the requirements of ASTM A 36. Bars, plates, and shapes must be free of sharp edges and irregularities.

U-bolts and washers must meet the requirements of ASTM A 320, Grade B8, Class 1 stainless steel. Nuts must be self-locking nylon insert-type nuts meeting the requirements of ASTM A 320 for Grade B8F.

Nuts used in the upper clamp connection of the vertical end support assembly and on all U-bolts must be of the self-locking type.

Assemble truss unit flange connections and the alternate bolted, web-to-chord connection using galvanized high-strength steel bolts, nuts, and washers meeting the requirements specified by subsection [906.06](#).

B. **Welding.** Weld in accordance with AWS D1.1, Structural Welding Code, “Steel” as amended by section [919](#) or the contract.

**C. Dimension Tolerances.** Ensure cross sections, flatness, length, straightness, thickness, and camber of material, before and after fabrication, meet the tolerance requirements of ASTM A 6 and AWS D1.1.

**D. Galvanizing.** Truss units must be galvanized in accordance with ASTM A 123. Blast clean base plates and welds to remove excess mill scale and welding slag before galvanizing. Blast clean other areas as directed by the Engineer.

Provide safeguards meeting the requirements of ASTM A 384 and ASTM A 385 to obtain high quality galvanized coatings and minimize distortion and warpage during galvanizing.

Interconnect sections of fabricated pipe work or tube assemblies with open tee or miter joints and provide each enclosed section with a vent hole at each end to provide drainage for the molten zinc and to prevent hazard to personnel engaged in the galvanizing process.

Hot-dip galvanize individual pipe, tube, and bar members in accordance with ASTM A 123.

**919.09. Overhead Lane Assignment Structures.** Overhead lane assignment structures must meet the requirements of Sign Support Standard SIGN-760 and traffic signal typical plans.

**919.10. Casings for Cantilever Drilled Piles.** Casings for cantilever drilled piles must meet the requirements of ASTM A 252 for Grade 2 steel. Casings must be smooth, watertight, and capable of withstanding handling stresses and external subsurface pressures. Casing must have an inside diameter at least equal to the required shaft size.

**Section 920. PERMANENT PAVEMENT MARKING MATERIALS**

**920.01. Marking Materials.** Select pavement marking materials from the Qualified Product List.

Pavement marking materials must meet the general packaging and labeling requirements of subsection [920.01.A](#), and applicable specific material requirements of subsection [920.01.B](#).

**A. General Packaging and Labeling.** Material containers or packages must be marked on the tops and sides, using a durable, weather-resistant marking. Include the following information:

1. Manufacturer's name and address,
2. Description of the material,
3. Product identification number,
4. Lot or Batch number,
5. Date of manufacture,
6. Volume and
7. Weight.

**B. Packaging and Labeling for Cold Plastic and Thermoplastic Markings.**

1. **Cold Plastic.** Containers or packages of cold plastic material, and the core of each role must be marked with the information specified in subsection [920.01.A](#).
2. **Thermoplastic.** In addition to the requirements of subsection [920.01.A](#), thermoplastic material must be packaged in non-stick containers, and labeled with "heat to manufacturer-recommended temperature range," or a Department-approved equal.

**920.02. Glass Beads.**

**A. Glass Bead Packaging and Labeling.** Glass beads must be packaged in moisture resistant bags and labeled to include the following information:

1. Manufacturer's name and address,
2. Shipping point,
3. Trademark or name,
4. The wording "Glass Beads,"
5. Specification number,
6. Weight,
7. Lot or Batch number, and
8. Date of manufacture.

Glass beads must meet the general requirements of subsection [920.02.B](#), and the applicable requirements for specific applications of subsection [920.02.A](#).

**B. General Glass Bead Requirements.** Glass beads must meet the physical characteristics and gradation requirements specified in Table 920-1, unless otherwise specified in subsection [920.02.C](#) for specific applications.

| <b>Table 920-1</b>                        |   |
|---|---|
| <b>General Glass Bead Requirements</b>    |   |
| <b>Physical characteristics (MTM 711)</b> |   |
| General Appearance                        | Transparent, clean, smooth, free from milkiness, pits, or excessive air bubbles |
| Shape                                     | Spherical with $\geq 75\%$ true spheres   |
| Color                                     | Colorless, very light gray, very light gray tinge, or bright white              |
| Index of Refraction                       | $\geq 1.50$   |
| Alkalinity                                | $\leq 2.0$  |
| <b>Gradation Requirements (MTM 711)</b>   |   |
| Sieve Size (No.)                          | Total Percent Passing   |
| 20  | 100   |
| 30  | 75–95   |
| 50  | 15–35   |
| 100                                       | 0–5   |

**C. Glass Bead Requirements for Specific Applications.** For specific applications, glass beads must be as follows:

- 1. Waterborne and Low Temperature Waterborne.** Standard glass beads for use with waterborne marking material and low temperature waterborne marking material require a moisture resistant coating and a silane coating.
- 2. Regular Dry.** Standard glass beads for use with regular dry marking material may have a moisture resistant coating, a silane coating, or both.
- 3. Thermoplastic.** Glass beads for thermoplastic marking material must have a moisture resistant coating.
- 4. Sprayable thermoplastic.** The type, gradation, and application rates for glass beads used with sprayable thermoplastic marking material must meet the thermoplastic manufacturer's recommendation.
- 5. Polyurea.** The type, gradation, and application rates for glass beads used with polyurea marking material must meet the thermoplastic manufacturer's recommendation.

Use a double drop system of large and standard glass beads, a double drop system of ceramic elements and standard glass beads, or an Engineer-approved alternate for recessed longitudinal markings. Ensure large glass beads meet federal specification TTB-1325 for a Type 4 glass bead.

## Section 921. PERMANENT TRAFFIC SIGNAL MATERIALS

### 921.01. Sampling and Testing.

A. **General.** The Department may select permanent traffic signal materials covered by this section at random from shipments and test in accordance with Department methods. If requested by the Department, complete one installation for preliminary testing. If the preliminary sample does not meet the requirements of this section, the Department will notify the Contractor, in writing, of deficiencies so the Contractor may make the necessary changes or corrections in materials or installation methods. The Department may re-test traffic signal materials after the Contractor makes the necessary changes or corrections.

B. **Loop Detectors.** The Department will randomly select one or more loop detectors from the shipment and perform testing as specified in subsection [921.01.A](#). If the one tested loop detector meets the requirements of subsection [921.01.A](#), the Department will give the Contractor written notification to provide the remainder of the order, which will be subject to testing.

If the preliminary sample does not meet to the requirements of subsection [921.01.A](#), the Department will notify the Contractor, in writing, of deficiencies so the Contractor may make changes or corrections in materials or installation methods. All loop detectors will then be subject to testing. If the Contractor does not, or cannot make corrections, the Department will require the Contractor to provide materials from other sources in accordance with section [105](#).

C. **Warranty.** Provide materials with a manufacturer's guarantee or warranty, transferable to the Department, that the material is free of defects in materials and workmanship for a specified period from the date of shipment. Provide the Engineer with the manufacturer's guarantee or warranty documents and a copy of the invoice showing date of shipment.

**921.02. Span Wire.** Use extra high-strength Grade, 7-wire, Class A, zinc-coated steel, meeting the requirements of ASTM A 475. Provide wire with a nominal diameter of  $\frac{1}{4}$  inch for supporting traffic signal cables, including self supporting figure-8 type cable. Provide wire with a nominal diameter of  $\frac{5}{16}$  inch for supporting a traffic signal, case sign, and cable.

**921.03. Vehicular Traffic Signals and Mounting Assemblies.** Unless otherwise required, provide traffic signals meeting the requirements of the Institute of Traffic Engineers (ITE) Standard, the *Standard for*



*Adjustable Face Vehicle Traffic Control Signal Heads, Vehicle Traffic Control Signal Heads (VTCSH), Light Emitting Diode (LED) Circular Signal Supplement, and the LED Vehicle Arrow Traffic Signal Supplement.*

Provide adjustable face-type traffic signals with 8 inch or 12 inch diameter lenses. Provide signal sections of the same make and type to ensure they are interchangeable. Signal faces include LED traffic signal modules for ball lenses, arrow lenses, or both, socket assembly gaskets, reflector and door assembly, housing, visors, optical units, wiring, and mounting assembly. Provide LED vehicular traffic signals compatible in new installations, or as a retrofit unit capable of replacing the optical unit of existing vehicular traffic signal sections meeting the ITE requirements.

**A. Housing.** Provide polycarbonate plastic housing. Provide each signal body with a 2 inch diameter hole in the top and bottom to receive 1½ inch diameter supporting pipe. Provide AISI Series 300 stainless steel fasteners if at least partially exposed on the exterior of the assembled housing. Provide AISI Series 300 stainless steel screws, bolts, nuts, and hinge pins for the interior of the housing. Provide other hardware used on the interior in AISI Series 300 stainless steel, brass, or aluminum. Do not use plastic fasteners to secure the door.

**B. Visor.** Provide each signal face with a detachable tunnel design visor for each signal lens. Provide a visor from 7 inches to 8 inches long for 8 inch lenses and from 9 inches to 12 inches long for 12 inch lenses. Provide a visor that encloses at least 290 degrees of the lens circumference and tilts downward from 1 degree to 10 degrees. Provide a polycarbonate visor at least 0.078 inch thick, made of one solid piece. Attach the visor to the signal section.

**C. LED Module.** LED signals and modules include circular and arrow modules, unless otherwise specified.

Provide new Department-approved LED signal of the latest model currently in production. The Engineer will not accept equipment that is no longer manufactured, even if it meets the requirements of this subsection. Install all LED signals produced by the same manufacturer at one location.

**1. Physical and Mechanical Requirements.** Provide self-contained, sealed LED module units consisting of a lens, color coded leads with pre-insulated spade lugs, LED assembly, power supply, and a one-piece neoprene gasket. Use material for the lens and module construction that meets ASTM requirements. Provide enclosures to contain the power supply or electronic components for the signal

module made of UL94 flame retardant material. If retrofitting into existing traffic signal housing, provide the LED module in a new signal door and visor assembly.

Ensure the LED assembly and the manufacturer's assembly processes provide support for the internal LED and electronic components to withstand mechanical shock and vibration in accordance with MIL STD 883, Test Method 2007. Verify that the LED vehicle signal manufacturer is ISO 9001 certified.

Protect the LED signal module against dust and moisture intrusion in accordance with the results of MIL STD 810F, Procedure I, "Rain and Blowing Rain" testing. Conduct the test on stand alone units with no protective housing.

Provide an LED signal module lens made from ultraviolet stabilized polycarbonate. Use lenses that are color tinted red, yellow, and green to match the color of the LEDs. Provide lenses that do not require special tools for replacement. Provide a hard-coated lens, or a lens that otherwise complies with the material exposure and weathering effects requirements of SAE J576. Attach the lens to the signal body using waterproof silicone seal.

Provide lenses for vehicle signals with smooth external lens surfaces and no raised features to minimize collection of dirt, diesel smoke, and other particulate contaminants, and to facilitate periodic cleaning.

Ensure each signal module identifies the manufacturer's name, model number, serial number, related voltage, and power consumption on the outside of the unit. Attach the identification tag using polyester or vinyl self adhesive labels and make visible without disassembly of the signal module. Do not use paper labels.

For each LED signal module, provide a prominent and permanent vertical indicator for the orientation of the module inside the traffic signal housing.

Provide LED modules that incorporate a dual lens approach using a single inner collimating lens and a single outer spreading lens. Provide an inner Fresnel lens that collimates the light emitted by the LED light engine and spans the full diameter of the interior of the signal. Provide an outer lens that distributes the light rays through raised optical detail on the inner surface to meet the intensity and distribution standards specified in this section.

Provide LED modules that incorporate two separate printed circuit boards, one for the LED light source, and one for the power supply. Provide LED modules consisting of high flux LEDs mounted on a metal core circuit board using thermal epoxy and LED electrical contacts soldered to the circuit board. Place a single layer of thermal transfer material between the metal core printed circuit board and the module heat sink to ensure optimum heat transfer away from the LED P-N junctions.

Provide a lens assembly that disperses the light to prevent visibility of individual LEDs from vehicles.

Provide watertight LED signals when installed in traffic signal housing. Provide the same mounting hardware for LED signal modules as used to secure incandescent lens and gasket assemblies. Ensure installation only requires a screwdriver or standard installation tool. Provide an LED signal module assembly that weighs less than 5 pounds.

Mount and solder the LED arrow module to a printed circuit board. Provide an LED arrow module that uses a single outer lens that spreads and diffuses light from the LEDs. Incorporate a black arrow mask behind the outer lens to enhance the definition of the arrow icon. Provide an outer lens with raised optical detail on the inner surface to distribute the light rays to meet the intensity and distribution standards required by this subsection.

2. **Electrical Requirements.** Provide LED signal modules that operate from a 60-hertz line frequency and over a voltage range from 80 volts to 135 volts. The Engineer will allow a change of luminous intensity no greater than 10 percent over the voltage range.

Provide an LED signal module capable of operating over a temperature range from  $-40^{\circ}\text{F}$  to  $165^{\circ}\text{F}$ .

Provide each LED signal module with two color-coded, No. 18 gauge minimum, anti-capillary 39 inch long, 600 volt, jacketed wires, conforming to the requirements of the NEC, rated for service at  $221^{\circ}\text{F}$ . Provide the LED module wire leads with insulated spade lug terminals for connecting to existing traffic signal terminal blocks.

Provide LED signal modules with voltage surge protection to withstand high repetition noise transients and low-repetition, high-energy transients, in accordance with NEMA Standard TS-2.

Provide LED circuitry that prevents flicker at less than 100 hertz over the voltage range from 80 volts to 135 volts in accordance with ITE VTCSH.

Provide LED signals and associated on-board circuitry meeting Federal Communications Commission (FCC) Title 47, Subpart B, Section 15 regulations concerning the emission of electronic noise by Class A digital devices.

Ensure a power factor of at least 90 percent, at nominal rated voltage, at 77 °F. Ensure a total harmonic distortion (THD) of less than 20 percent at rated voltage, at 77 °F.

Ensure the failure of a single LED will not cause a loss of light from other LEDs. Provide LED ball lamps that do not lose light output from the complete module assembly as a result of the failure of a single LED.

Provide an LED module that will detect catastrophic loss of the LED load. Provide a module which, upon sensing the loss of the LED load, presents a resistance of at least 250 kilo ohms across the input power leads within 300 millisecond. The Department considers catastrophic failure of an LED light source if it fails to show visible illumination when energized in accordance Section 5.2.1 of the ITE VTCSH LED Circular Signal Supplement, dated June 27, 2005, after 75 milliseconds or Section 5.7 of the LED Vehicle Arrow Traffic Signal Supplement dated April 3, 2006.

Provide an LED signal module that is operationally compatible with current controller assemblies, including solid state load switches, flashers, and conflict monitors.

Wire the LED modules with at least No. 18 AWG, color coded thermoplastic insulated wire.

Provide a six point terminal block with screw terminals, for spade lugs of brass, stainless steel, or other non-corrosive material, for connecting wires from the LED module and the cable from the signal controller. Mount the terminal block in the center section of the signal face and provide at least 1 inch lateral clearance from the housing. Hold the terminal block in place with stainless steel screws.

Mount and locate the terminal block, and other appurtenances, in the housing to minimize the danger of electrical shock during maintenance activities.

3. **Power Consumption and Operational Range.** Provide LED traffic signal modules that meet the minimum intensity requirements while operating from temperatures of  $-40^{\circ}\text{F}$  to  $165^{\circ}\text{F}$  for 5 years.

Provide high flux LED capable of being driven continuously at a current of at least 350 milli-amperes with a power dissipation rating of at least 1 watt.

Provide LEDs that do not illuminate for input voltages below 35 volts, but do illuminate for input voltages greater than 45 volts, and are regulated above 80 volts.

Provide LED modules for traffic signals with the following characteristics:

- a. Eight inch and 12 inch red ball traffic signal modules with a maximum power consumption no greater than 6 watts and 9 watts respectively, at 120 VAC, at  $77^{\circ}\text{F}$ ;
- b. Eight inch and 12 inch yellow ball traffic signal modules with a maximum power consumption no greater than 13 watts and 19 watts, respectively, at 120 VAC, at  $77^{\circ}\text{F}$ ;
- c. Eight inch and 12 inch green ball traffic signal modules with a maximum power consumption no greater than 6 watts and 12 watts, respectively, at 120 VAC, at  $77^{\circ}\text{F}$ ;
- d. Twelve inch red arrows with a maximum power consumption no greater than 7 watts at 120 VAC, at  $77^{\circ}\text{F}$ ;
- e. Twelve inch yellow arrows with a maximum power consumption no greater than 9 watts at 120 VAC, at  $77^{\circ}\text{F}$ ; and
- f. Twelve inch green arrows with a maximum power consumption no greater than 7 watts at 120 VAC, at  $77^{\circ}\text{F}$ .

Ensure each LED module reaches 90 percent full illumination within 75 milliseconds of applying the nominal operating voltage. Ensure modules do not show visible illumination after 75 milliseconds of removing the nominal operating voltage.

Provide red LEDs that use exclusively aluminum indium gallium phosphide technology, either absorbing substrate or transparent substrate, and do not exhibit degradation greater than 30 percent of the initial light intensity following accelerated life testing (operating at  $185^{\circ}\text{F}$  and 85 percent humidity for 1,000 hours). Do not use aluminum gallium absorbing substrate technology.

Provide green LEDs that use indium gallium nitride technology. Provide green LED traffic signal modules that do not illuminate if the applied voltage is less than 35 VAC. Provide green LEDs that illuminate, unregulated, if the applied voltage is from 45 VAC to

80 VAC. Provide green LEDs that illuminate in accordance with the ITE VTCSH, Part II, if applied voltage is from 80 VAC to 135 VAC.

Provide yellow LEDs that use aluminum indium gallium phosphide technology, absorbing substrate or transparent substrate. Provide yellow LED traffic signal modules that do not illuminate if the applied voltage is less than 35 VAC. Provide yellow LEDs that illuminate, unregulated, if the applied voltage is from 45 VAC to 80 VAC. Provide yellow LEDs that illuminate in accordance with the ITE VTCSH if applied voltage is from 80 VAC to 135 VAC.

Provide LED modules operationally compatible with NEMA TS-1 and NEMA TS-2 conflict monitoring parameters.

4. **Photometric Requirements.** Refer to Section 4, Table 1 of the ITE VTCSH LED Circular Signal Supplement dated June 27, 2005, and the LED Vehicle Arrow Traffic Signal Supplement, dated April 3, 2006, for the minimum initial luminous intensity values for the LED traffic signal module.

Ensure the actual luminous intensity for a module does not exceed three times the required peak value of the minimum maintained luminous intensity for the signal size and color, if operated within the temperature range specified in Section 3.3.2 of the ITE VTCSH LED Circular Signal Supplement dated June 27, 2005, and the LED Vehicle Arrow Traffic Signal Supplement dated April 3, 2006.

Ensure the uniformity of the signal output across the module lens does not exceed a ratio of 10:1 from the maximum to minimum luminance values.

Provide LED modules with surfaces that appear uniform in illumination. Eliminate the visibility of individual LEDs to the motorist.

Ensure the measured chromaticity coordinates of LED traffic signal modules conform to the color regions based on the 1931 CIE chromaticity diagram listed in the ITE VTCSH LED Circular Signal Supplement dated June 27, 2005.

Ensure the dominant wavelength for individual color measurements of portions of the emitting surface of a module are within  $\pm 3$  nanometers of the dominant wavelength for the average color measurement of the entire emitting surface.

Provide LED modules operationally compatible with NEMA TS-1 and NEMA TS-2 conflict monitoring parameters.

921.03

Provide LED traffic signal modules that meet the minimum luminous intensity values listed in Table [921-1](#) for circular modules, or Table [921-2](#) for arrow modules, for 60 months.

**Table 921-1  
Minimum Maintained Luminous Intensity Values — VTCSH LED Circular Signal**

| Vertical Angle (°) | Horizontal Angle (°) | Luminous Intensity (candela) (a) (b) |        |       |       |        |       |
|--------------------|----------------------|--------------------------------------|--------|-------|-------|--------|-------|
|                    |                      | 8 in                                 |        |       | 12 in |        |       |
|                    |                      | Red                                  | Yellow | Green | Red   | Yellow | Green |
| +12.5              | 2.5                  | 17                                   | 41     | 22    | 37    | 91     | 48    |
|                    | 7.5                  | 13                                   | 33     | 17    | 29    | 73     | 38    |
| +7.5               | 2.5                  | 31                                   | 78     | 41    | 69    | 173    | 90    |
|                    | 7.5                  | 25                                   | 62     | 32    | 55    | 137    | 71    |
|                    | 12.5                 | 28                                   | 45     | 24    | 40    | 100    | 52    |
| +2.5               | 2.5                  | 68                                   | 168    | 88    | 150   | 373    | 195   |
|                    | 7.5                  | 56                                   | 139    | 73    | 124   | 309    | 162   |
|                    | 12.5                 | 38                                   | 94     | 49    | 84    | 209    | 109   |
|                    | 17.5                 | 21                                   | 53     | 28    | 47    | 118    | 62    |
| -2.5               | 22.5                 | 12                                   | 29     | 15    | 26    | 64     | 33    |
|                    | 2.5                  | 162                                  | 402    | 211   | 358   | 892    | 466   |
|                    | 7.5                  | 132                                  | 328    | 172   | 292   | 728    | 380   |
|                    | 12.5                 | 91                                   | 226    | 118   | 201   | 501    | 261   |
|                    | 17.5                 | 53                                   | 131    | 69    | 117   | 291    | 152   |
| -7.5               | 22.5                 | 28                                   | 70     | 37    | 62    | 155    | 81    |
|                    | 27.5                 | 15                                   | 37     | 19    | 33    | 82     | 43    |
|                    | 2.5                  | 127                                  | 316    | 166   | 281   | 701    | 366   |
|                    | 7.5                  | 106                                  | 262    | 138   | 234   | 582    | 304   |
|                    | 12.5                 | 71                                   | 176    | 92    | 157   | 391    | 204   |
|                    | 17.5                 | 41                                   | 103    | 54    | 91    | 228    | 119   |
| -12.5              | 22.5                 | 21                                   | 53     | 28    | 47    | 118    | 62    |
|                    | 27.5                 | 12                                   | 29     | 15    | 26    | 64     | 33    |
|                    | 2.5                  | 50                                   | 123    | 65    | 110   | 273    | 143   |
|                    | 7.5                  | 40                                   | 98     | 52    | 88    | 218    | 114   |
|                    | 12.5                 | 28                                   | 70     | 37    | 62    | 155    | 81    |
|                    | 17.5                 | 17                                   | 41     | 22    | 37    | 91     | 48    |
| -17.5              | 22.5                 | 8                                    | 21     | 11    | 18    | 4      | 24    |
|                    | 27.5                 | 5                                    | 12     | 6     | 11    | 27     | 14    |
|                    | 2.5                  | 23                                   | 57     | 30    | 51    | 127    | 67    |
|                    | 7.5                  | 18                                   | 45     | 24    | 40    | 100    | 52    |
|                    | 12.5                 | 13                                   | 33     | 17    | 29    | 73     | 38    |
|                    | 17.5                 | 7                                    | 16     | 9     | 15    | 36     | 19    |
| -22.5              | 22.5                 | 3                                    | 8      | 4     | 7     | 18     | 10    |
|                    | 2.5                  | 17                                   | 41     | 22    | 37    | 91     | 48    |
|                    | 7.5                  | 13                                   | 33     | 17    | 29    | 73     | 38    |
|                    | 12.5                 | 10                                   | 25     | 13    | 22    | 55     | 29    |
| -27.5              | 17.5                 | 5                                    | 12     | 6     | 11    | 27     | 14    |
|                    | 2.5                  | 12                                   | 29     | 15    | 26    | 64     | 33    |
|                    | 7.5                  | 8                                    | 21     | 11    | 18    | 46     | 24    |

a. Luminous intensity values for equivalent left and right horizontal angles are the same.

b. Tabulated values of luminous intensity are rounded to the nearest whole value.



| <b>Table 921-2<br/>Minimum Maintained Luminous Intensity Values for the VTC SH LED Vehicle<br/>Arrow Traffic Signal</b> |                                     |   |               |              |
|---|-------------------------------------|---|---------------|--------------|
| <b>Vertical Angle<br/>(°)</b>   | <b>Horizontal<br/>Angle<br/>(°)</b> | <b>Luminous Intensity (candela) (a) (b)</b> |               |              |
|   |                                     | <b>12 in arrow</b>                          |               |              |
|   |                                     | <b>Red</b>                                  | <b>Yellow</b> | <b>Green</b> |
| +12.5   | 2.5                                 | 6   | 15            | 8            |
|   | 7.5                                 | 5   | 12            | 6            |
| +7.5  | 2.5                                 | 11  | 28            | 14           |
|   | 7.5                                 | 9   | 22            | 11           |
|   | 12.5                                | 6   | 16            | 8            |
| +2.5  | 2.5                                 | 24  | 60            | 31           |
|   | 7.5                                 | 20  | 49            | 26           |
|   | 12.5                                | 13  | 33            | 17           |
|   | 17.5                                | 8   | 19            | 10           |
| -2.5  | 22.5                                | 4   | 10            | 5            |
|   | 2.5                                 | 57  | 143           | 75           |
|   | 7.5                                 | 47  | 116           | 61           |
|   | 12.5                                | 32  | 80            | 42           |
|   | 17.5                                | 19  | 47            | 24           |
| -7.5  | 22.5                                | 10  | 25            | 13           |
|   | 27.5                                | 5   | 13            | 7            |
|   | 2.5                                 | 45  | 112           | 59           |
|   | 7.5                                 | 37  | 93            | 49           |
|   | 12.5                                | 25  | 63            | 33           |
|   | 17.5                                | 15  | 36            | 19           |
| -12.5   | 22.5                                | 8   | 19            | 10           |
|   | 27.5                                | 4   | 10            | 5            |
|   | 2.5                                 | 18  | 44            | 23           |
|   | 7.5                                 | 14  | 35            | 18           |
|   | 12.5                                | 10  | 25            | 13           |
|   | 17.5                                | 6   | 15            | 8            |
| -17.5   | 22.5                                | 3   | 7             | 4            |
|   | 27.5                                | 2   | 4             | 2            |
|   | 2.5                                 | 8   | 20            | 11           |
|   | 7.5                                 | 6   | 16            | 8            |
|   | 12.5                                | 5   | 12            | 6            |
| -22.5   | 17.5                                | 2   | 6             | 3            |
|   | 22.5                                | 1   | 3             | 2            |
|   | 2.5                                 | 6   | 15            | 8            |
|   | 7.5                                 | 5   | 12            | 6            |
| -27.5   | 12.5                                | 4   | 9             | 5            |
|   | 17.5                                | 2   | 4             | 2            |
|   | 2.5                                 | 4   | 10            | 5            |
|   | 7.5                                 | 3   | 7             | 4            |

a. Luminous intensity values for equivalent left and right horizontal angles are the same.  
 b. Tabulated values of luminous intensity are rounded to the nearest whole value.

D. **Electrical Wiring.** Provide stranded wire electrical wiring meeting the requirements of ITE Standards. Equip each signal with a non corrosive barrier-type terminal block with at least four terminals; one for each optical unit and one common terminal. Mount the terminal block in the center section without interfering mechanically with other components of the signal. Locate the terminal block in the housing to minimize the danger of electrical shock during maintenance activities.

Electrically and mechanically secure the wiring by fastening to the lamp receptacle. Insulate exposed, current carrying parts. Use pre-insulated fork-type terminals on the wires at the terminal block connection.

Do not use pressure type terminal blocks.

E. **Mounting Assemblies.** Provide mounting assemblies that include the hardware for complete assembly of the signal.

1. **Pipe.** For mounting assemblies, use rigid conduit of 1 inch standard steel pipe with tapered threads. Do not use straight threads. Install plastic thread protectors for exposed pipe threads to protect the threads during shipping.
2. **Hub or Center Fitting.** Provide a hub of malleable iron with a nominal 3 inch by 3 inch opening to draw wires and make connections. Secure the cover for the opening with two  $\frac{3}{8}$  inch by  $\frac{1}{2}$  inch hexagon head, 300 Series stainless steel screws. Close unused openings in the hub with ferrous or aluminum ornamental closures.
3. **Arms.** Provide pipe arms from the center hub to position the centers of the signal face housings on a radius of  $8\frac{3}{4}$  inches  $\pm\frac{1}{4}$  inch from the hub for 8-inch signals, and a radius of  $10\frac{3}{4}$  inches  $\pm\frac{1}{4}$  inch from the hub for 12-inch signals.
4. **Fittings.** Use ferrous pipe crosses to make right angles in mounting frames. Close unused openings of the pipe crosses with ornamental closures. Do not use set screws in pipe crosses.

Provide malleable iron fittings are free of flash and voids.

5. **Assemblies.** Construct the bottom portion of the side post mounting assemblies of  $1\frac{1}{2}$  inch standard steel pipe and fittings. Attach the bottom portion of the span mounting assembly to signals using a flat, aluminum spacer, of one-piece construction or welded, with aluminum closures. Do not use rivets.
6. **Finish.** Provide pipes and fittings with internal surfaces that are free of sharp edges and burrs.

7. **Cable Entrance Fitting.** Provide fittings of one-piece construction, made of malleable iron. Provide the wire outlet with a composition bushing with opening to accommodate a multi-conductor cable, 1 inch in diameter. Provide the threaded end of the fitting with a threaded nipple, two 1½ inch malleable iron locknuts, and a stainless steel cotter key.
8. **Span Wire Fitting.** Provide fittings of malleable iron to accommodate ¼ inch to ⅝ inch messenger wire with a 1⅝ inch diameter pin and ⅜ inch by 1-inch stainless steel cotter key. Locate the pin 3<sup>7</sup>/<sub>16</sub> inches from where the span cable seats into the saddle part of the fitting. Provide a saddle part 9 inches long.
9. **Span and Cable Entrance Assembly.** Provide a span and cable entrance assembly that allows the signal assembly to swing in any direction and return to the vertical position without placing stress on the span wire.
10. **Signal Head Attachment.** Provide the top outlet of each signal bracket with a nipple and either a watertight metal gasket with retainer to restrict the flow of the gasket or one flat stainless steel washer and one malleable iron hexagon nut, ½ inch thick.

Provide a nipple of a length to allow the use of the gasket or nut and washer.

#### F. **Paint and Color.**

1. **Mounting Assemblies.** Clean and surface treat the surfaces of mounting assemblies in accordance with standard industry practice, to ensure bonding of the paint to the metal. After preparation, paint surfaces with durable weather resistant semi-gloss or gloss yellow enamel.

Apply the enamel at an average dry film thickness of 1.5 mils, without blisters, runs, or other defects. Determine the dry film thickness using Method A, Inductance Thickness Gauge, as specified in ASTM D 1400. Ensure the color matches the central color within the limits shown on the current FHWA Highway Yellow Color Tolerance Chart, except do not use a color darker than the central color.

2. **Signal Faces.** Provide signal faces with the yellow color specified in subsection [921.03.F.1](#), permanently molded into the signal door, housing, and visors. Provide the inside of the visors with a finish coat of flat black paint, compatible with polycarbonate plastic.

**G. Packing and Marking.** Pack each traffic signal separately to prevent damage or defacement to the signal and mounting assembly during transportation to the project. Legibly mark each carton with the signal and mounting assembly description and supplier's name.

**H. Quality Assurance.** Provide LED modules that comply with the quality assurance production testing, inspection, and design, as specified in the ITE VTCSH, LED Circular Signal Supplement dated June 27, 2005, and LED Vehicle Arrow Traffic Signal Supplement dated April 3, 2006.

**I. Tests, Inspection, and Sampling.** Test each LED module and inspect before shipment. Reject pieces of equipment that fail to meet the requirements of this section.

**J. Drawings and Information.** If required, provide two copies of drawings of the signal head and LED module showing manufacturer's part numbers.

Provide the independent test lab reports showing that proposed material meets or exceeds the requirements of this section and Quality Assurance Testing and Inspection per Section 6 of the ITE VTCSH, LED Circular Signal Supplement dated June 27, 2005 and LED Vehicle Arrow Traffic Signal Supplement dated April 3, 2006. Failure to provide the independent lab test reports will be cause for rejection.

The Engineer will hold the information required by this subsection, along with a sample, if requested, as standards for acceptance.

**921.04. Pedestrian Signals and Countdown Type.** Unless otherwise required, provide pedestrian signals and countdown pedestrian signals meeting the requirements of the ITE Standard for "Adjustable Face Pedestrian Signal Heads" and the "LED Performance Specifications of the Pedestrian Traffic Control Signal Indications (PTCSI)" Part 2, "Pedestrian Traffic Signal Modules." The pedestrian signal indications include the LED signal modules, countdown, socket assembly gaskets, reflector and door assembly, housing, visors, optical units, wiring, and mounting assemblies.

Provide LED pedestrian signal modules capable of displaying the ITE specified symbolic full icon "hand" or "walking person" legends, using a one-piece section that includes a nominal message-bearing surface size of 12 inches by 12 inches.

Provide LED countdown pedestrian signal modules capable of exhibiting two, seven-segment digital numerical digits that display the remaining time to clear the intersection, and the traditional full icon "hand" or

“walking person” legends using a one-piece section that includes a nominal message-bearing surface size of 16 inches by 16 inches.

**A. Housing.** Provide housing for each section as a one-piece, black polycarbonate resin material with front, sides, top, and bottom integrally molded. Provide housing at least  $\frac{3}{32}$  inch thick, ribbed to produce a strong assembly, and lightweight. Provide two sets of internal bosses in the section for mounting terminal strip facilities horizontally. Attach a six-position terminal block with screw terminals for spade lugs to bosses with two self-tapping stainless steel screws.

Provide each signal section with a 2 inch diameter round hole top and bottom to receive a  $1\frac{1}{2}$  inch supporting pipe. After assembling the sections, ensure a 1 inch cable can pass through the head without damage or excessive labor.

Provide a variable pressure-type door latch, bolt and wing nut, of American Iron and Steel Institute (AISI) 300 Series stainless steel, or approved equal.

Provide signal sections with a “hand” and “walking person” symbolic icon signal face of an over-all height of at least 14 inches.

For fasteners partially or fully exposed on the exterior of the assembled housing, provide AISI 300 Series stainless steel fasteners. For other screws, bolts, nuts, and hinge pins on the interior of the housing, provide AISI 300 Series stainless steel, brass or aluminum fasteners. Do not use plastic fasteners to secure the door.

**B. Visor.** Provide signal heads with visors attached that encompasses the top and two sides of the lens for each signal indication. Provide a visor made of black polycarbonate resin at least 0.070 inch thick, attached to the door and signal section with at least four AISI 300 Series stainless steel screws. Provide a visor that fits tightly against the door and does not allow perceptible filtration of light between the door and the visor. Provide a visor that is detachable and 10 inches long or  $6\frac{3}{4}$  inches long for countdown pedestrian signals. Provide a visor mounting system allows handling of the signal head by the visor.

**C. LED Module.** Provide new LED pedestrian signals of the latest models currently in production. The Engineer will not accept equipment no longer manufactured, even if it meets the requirements specified in this subsection. Install all LED signals produced by the same manufacturer in one location.

Provide LED pedestrian signals that achieve the minimum intensity requirements of the ITE photometric test criteria.

## 1. Physical and Mechanical Requirements.

- a. **General.** Make each LED module a self contained unit.

Ensure the module the manufacturer's LED assembly process provide support for the internal LED and electronic components to withstand mechanical shock and vibration. Ensure the LED signal manufacturer is ISO 9001 certified.

Protect the LED signal module against dust and moisture intrusion in accordance with the requirements of MIL 810F, Procedure I, "Rain and Blowing Rain" for protecting internal LED, electronic, and electrical components. Conduct the test on a stand alone unit, with no protective housing required.

Provide an LED signal module made of ultraviolet, stabilized polycarbonate. Provide LED signal modules with a lens that is tinted or uses transparency film, or materials with similar characteristics. If requested by the Engineer, use a surface coating or film on a non fused polymeric lens to provide front surface abrasion resistance.

Provide pedestrian signals with smooth external lens surfaces with no raised features, to minimize the collection of dirt, soil, diesel smoke, and other particulate contaminates, and facilitate periodic cleaning.

Identify each LED signal module with the manufacturer's name, model number, serial number on the outside of the unit, rated voltage, and power consumption. Ensure the identification tag is visible without disassembling the signal module.

Provide LED signal modules with a prominent and permanent vertical indication to orient the module inside pedestrian signal housing.

- b. **LED Assembly.** Provide LED assemblies that consist of an LED array mounted to a printed circuit board and sealed in a polycarbonate cover assembly. Secure the cover assembly to a 12 inch polycarbonate, or 16 inch for countdown, clear matte signal lens. Provide the assembly with No. 18 AWG, anti-capillary, 39 inch, color-coded leads, meeting the requirements of the NEC with insulated spade lug terminals for attachment to the signal terminal block.

The retrofit assembly requires removal of the existing housing and mounting assembly and reconfiguration of the mounting

brackets to accommodate the one piece LED pedestrian signal housing.

Provide retrofit replacement modules, built for the PTCSI sizes of the “hand” and “walking person” icon pedestrian standards that fit into existing signal housings, without modifying the housing. The retrofit will require removing the existing reflector, lens, and door. Install the LED module in place of the removed lens, reassemble the door using the existing hinge pins, and connect the leads from the LED module to the existing terminal block.

Provide enclosed units that do not expose circuit boards with LEDs.

Do not use screw-in type products.

- c. **LED Array.** Provide LED arrays that consist of a highly visible full icon symbol of the “hand” and “walking person.” Use a “hand” symbol that is at least 9 inches tall and consists of Portland Orange LEDs. Use a “walking person” symbol that is at least 9 inches tall and consists of Lunar White LEDs. Provide the symbols that are at least 5¼ inches wide. Provide wires at least No. 18 AWG with thermoplastic insulation.

Provide an LED countdown array that consists of a highly visible full icon symbol of the “hand” and “walking person”. Ensure the “hand” symbol is at least 11 inches tall and consists of Portland orange LEDs. Use a “walking person” symbol that is at least 11 inches tall and consists of Lunar White LEDs. Provide symbols that are at least 6½ inches wide. Provide units with countdown digits that are at least 9 inches tall and consist of two rows of Portland orange LEDs. Provide wires at least No. 18 AWG with thermoplastic insulation.

Provide Portland orange T-1 LEDs that use aluminum indium gallium phosphate technology, 605 nanometers. Provide white T-1 LEDs that use indium gallium nitride technology.

2. **Electrical Requirements.** The minimum performance requirements for LED pedestrian signals and countdown modules include the following:
  - a. LED signal modules operate from a 60 hertz line frequency, over a voltage range from 80 VAC to 135 VAC, with a luminous intensity change no greater than ±10 percent.
  - b. Provide a nominal operating voltage of 120 VAC root mean square (RMS) for all measurements.

- c. Each LED signal module has two color coded, minimum No. 18 AWG, 39 inch, 600 volt, jacketed wires, meeting the requirements of the NEC, and rated for service at 221 °F. Provide the wire leads with pre-insulated spade lug terminals for connecting to existing traffic signal terminal blocks.
- d. LED signal modules include voltage surge protection to withstand high repetition noise transients, and low repetition, high energy transients as specified in Section 2.1.8 of NEMA Standard Publication TS-2.
- e. LED circuitry prevents flicker at less than 100 Hertz over the voltage range specified in Section 5.2 of the LED Performance Specifications.
- f. LED signals and associated on-board circuitry meet the requirements of FCC Regulations Title 47, Sub Part B, Section 15 concerning electronic noise emissions.
- g. LED modules provide a power factor of at least 90 at the nominal rated voltage, at 77 °F. The total harmonic distortion is less than 20 percent at the rated voltage, at 77 °F.
- h. LEDs are connected in series parallel strings so LED burnouts result in a single point failure. The current draw ensures compatibility and proper triggering and operation of load switches.
- i. The maintained minimum luminance value for the LED modules' "walking person" icon remains at 2,200 candelas per square meter for at least 60 months.
- j. The maintained luminance value for the LED modules' "hand" icon remains at 1,400 candelas per square meter for at least 60 months.
- k. Each module icon reaches 90 percent full illumination within 75 milliseconds of applying the nominal operating voltage.
- l. Modules do not illuminate after 75 milliseconds of removing the nominal operating voltage.

Provide a six-point terminal block with screw terminals for spade lugs for connecting wires from the LED module and incoming wires from the controller. Centrally locate the terminal block in the housing and provide at least 1 inch lateral clearance from the housing.

3. **Power Consumption and Operational Range.** Provide LED pedestrian traffic signals that consume no more than 8 watts for the "hand" icon, 6 watts for the "walking person" icon, and 5 watts for the countdown digits, at 120 VAC, 0.90 power factor at 77 °F.



Provide LED signals that operate over a temperature range from -40 °F to 165 °F, with no more than a 10 percent change in luminous intensity over the required voltage range.

Ensure the luminance uniformity of the “walking person” and “hand” icons does not exceed a ratio of 1:10 from the minimum to maximum luminance values, as measured in ½ inch diameter spots.

If operating within the temperature range, ensure the luminance of the module does not exceed three times the minimum luminance of the modules.

Provide LED pedestrian countdown modules with a uniform appearance when illuminated. Provide LED pedestrian countdown modules that do not present a pixilated appearance.

4. **Photometric Requirements.** Provide the minimum initial luminous intensity values for the LED traffic signal module specified in Section 4 of the LED Performance Specifications.

Provide LED pedestrian signal modules meeting the minimum intensity requirements while operating over a temperature range from -40 °F to 165 °F.

Provide LED traffic signal modules with measured chromaticity coordinates that meet the requirements of Section 4 of the LED Performance Specifications.

Retain a certified independent test lab to provide test data to verify that pedestrian signal performance meets the requirements of Section 6 of the LED Performance Specifications. To test, control and monitor the “walking person,” “hand,” and countdown digits separately, provide three wires for electrical connection to the “walking person” and “hand,” and provide three wires for the countdown digits.

5. **Countdown Timer.** Provide a micro-controller based countdown timer. Provide a timer that counts down only during the pedestrian clearance intervals, continuously monitors the pedestrian clearance interval, and automatically adjusts for changes made at the controller. If the flashing “hand” icon becomes solid, ensure the module displays a zero for 1 second and then blacks out. Ensure the countdown display remains dark until the beginning of the next countdown.

If a pre-emption sequence begins, ensure the countdown module skips the pre-empted clearance time and reaches zero at the same time as the flashing “hand” becomes solid. In the cycle following a

pre-emption call, ensure the signal displays the correct time. Ensure the countdown remains synchronized with the signal indications and always reaches zero at the same time the flashing “hand” becomes solid.

Provide the LED module with a removable plug on the rear of the unit to allow access to dip switches for selecting the following features:

- a. 1 – Display zero during stand by;
- b. 2 – Turn on LEDs for testing;
- c. 3 – Countdown walk, plus clearance time; and
- d. 4 – Disable countdown display.

Provide the countdown module with an internal conflict monitor to prevent conflicts between the “walking person” and the “hand” icons and the countdown digits display. Provide a conflict monitor that prevents the display from counting down during a steady “hand” indication.

**D. Electrical Wiring.** Provide electrical wiring that consists of stranded wire, meeting the requirements of the ITE VTCSH. Equip each pedestrian signal with a barrier-type terminal block with at least three terminals, one for each optical unit and one common terminal.

Mount the terminal block so it does not interfere mechanically with other components of the signal. Electrically and mechanically secure the wiring to a lamp receptacle. Insulate exposed current-carrying parts to prevent electrical shock hazard. Use pre-insulated fork-type terminals on the wires at the terminal block connection. Do not use pressure-type terminal blocks.

**E. Mounting Bracket Frame Assembly and Fitting.** Construct the mounting frame assembly and fittings entirely weather-tight. Reference MDOT typical signal construction details to reflect the new straight arm length needed for the countdown pedestals. Provide arms for the mounting assembly of 1½-inch standard steel pipe of a length to provide the following dimensions, within a tolerance of ±¼ inch:

1. For overhead and pedestal mountings, a radius of 8¾ inches from center of hub to center of pipe cross; and
2. From the center of the first pipe cross, 11½ inches for I-brackets and T-brackets, 14½ inches for countdown brackets.

Ensure the internal surfaces of pipes and fittings are free of sharp edges and burrs. Use ferrous pipe crosses to make right angles in the

mounting assembly. Close unused openings of the pipe crosses with ornamental closures. Provide malleable iron adapters or slip fitters.

Provide malleable iron fittings free of flash and voids.

Install a plastic thread protector on exposed pipe threads to protect the threads from damage during shipping.

**F. Painting Requirements.** Before painting the mounting brackets, clean and treat the ferrous and aluminum surfaces in accordance with standard industry practice for each type of metal to ensure bonding of the paint to the metal.

Provide a coating system for the mounting bracket assembly consisting of durable and weather-resistant black enamels, applied at a uniform thickness without blisters, runs, or other defects. Provide an average dry film thickness of 1.5 mils as determined by Method A, Inductance Thickness Gauge, as specified in ASTM D 1400.

Provide black LED pedestrian traffic signals. Provide visors with an inside surface painted flat black, compatible with polycarbonate plastic.

Provide signal parts with a color and finish that does not require painting to maintain a functional appearance. Ensure scratches on signal parts do not expose uncolored material.

Clean and pretreat metal surfaces of pedestrian signal mounting brackets, before painting and assembly, to ensure phosphate coating bonds to the surfaces in accordance with Federal Specifications TT C 490, "Cleaning Methods and Pretreatment of Ferrous Surfaces or Organic Coatings."

Use semi-gloss or glossy black enamel to finish coat other exterior surfaces of the fittings, except stainless steel latch bolts and clips.

**G. Packing and Marking.** Pack each pedestrian signal separately to prevent damage or defacement to the pedestrian signal and mounting assembly during transportation to the project. Mark each carton legibly with the pedestrian signal and mounting assembly description and supplier's name.

**H. Quality Assurance.** Provide LED modules that comply with the quality assurance production testing, inspection, and design specified in the ITE PTCSI Part 2 "Pedestrian Traffic Signal Modules," adopted 2004.

**I. Tests, Inspection, and Sampling.** Test each LED and inspect for conformance with this section before shipment. Reject pieces of equipment that fail to meet the requirements of this section. Ensure a certified independent test lab provides test data to verify pedestrian

signal performance meets the requirements of Section 6 of the LED Performance Specifications.

**J. Drawings and Information.** If required, provide the Engineer two copies of a detailed drawing and material specification list of the pedestrian head.

Provide LED pedestrian signal modules that comply with the quality assurance production testing and inspection requirements specified in Section 6 of the LED Performance Specifications.

Provide a test report in accordance with subsection [921.04.I](#) from an independent lab certifying pedestrian signals meet the requirements of the LED Performance Specifications.

The Engineer will hold the information required by this subsection [921.04.J](#), along with a sample, if requested, as standards for acceptance.

#### **921.05. Traffic Signal Strain Pole.**

**A. Shaft Assembly and Fabrication.** Provide traffic signal strain poles fabricated from high-strength steel, meeting the requirements of ASTM A 572, for Grade 345, galvanized after fabrication in accordance with ASTM A 123.

Provide a tapered shaft with a circular or at least an eight-sided polygonal cross section.

Provide a shaft in one continuous length with no more than one longitudinal weld. Provide a longitudinal weld that is rolled or ground smooth. Do not provide poles with transverse welds, except where the anchor base is welded to the shaft.

Provide a shaft attached by two continuous welds to a steel anchor base meeting the requirements of ASTM A 36, or an approved equal. Provide one weld on the inside of the base at the end of the shaft, and the other weld is on the outside, at the top of the base. Place the two welds at least 2 inches apart. Ensure the base and welded connection develop the full strength of the shaft.

Provide a base with four evenly spaced holes for bolting the standard to a concrete foundation. Thirty foot and 36 foot poles require four holes for 1 $\frac{3}{4}$ -inch anchor bolts in an 18-inch bolt circle diameter. Forty-foot poles require four holes for 2-inch anchor bolts in an 18-inch bolt circle diameter.

Provide a handhole opening and cover. Provide a handhole opening with a reinforcing frame welded to the shaft. Provide a handhole that

does not reduce the strength of the shaft. Provide stainless steel hex head cap screws or an approved locking device to fasten the handhole cover.

Provide a base with a lower surface that is finished flat and attached to the shaft axis at 90 degrees. Provide a base with an opening of at least 6½ inches in diameter allowing cables from three 3 inch and one 1½ inch ducts to enter into the foundation.

Provide a pole top with means for securing to the top of the shaft.

Provide a hook or other device for supporting a cable on the inside of the shaft near the top.

For grounding purposes, weld a standard ½ inch nut to the inside of the shaft, accessible from the handhole.

Provide each pole with three pole bands for attaching the traffic signal span, minor cable span, and service rack. Only attach one of these spans or racks to each pole band.

**B. Strength Requirements.** Provide a standard capable of withstanding a transverse load of at least 3,700 pounds applied 18 inches below the top of the shaft without exceeding the elastic limit. Ensure the deflection of the shaft does not exceed 0.40 inch per 100 pounds of transverse load applied at the same point.

**C. Air Circulation.** Make provisions for free air circulation inside the shaft to remove moisture caused by condensation, or from other sources.

**D. Anchor Bolts.** Provide anchor bolts meeting the requirements of subsection [908.15.C](#), including elongation and reduction of area requirements. Charpy V-Notch testing is not required. After threading, hot-dip galvanize at least 20 inches on the threaded end of anchor bolts in accordance with ASTM A 153.

**E. Repairing Galvanized Surfaces.** Repair spelter coating damaged in transporting, handling, or erection in accordance with subsection [716.03.E](#), at no additional cost to the Department.

**F. Identification of Manufacturer.** Provide standards with a catalog or other manufacturer's identification number permanently marked on the base.

**921.06. Traffic, Pedestrian Signals, Pushbutton Pedestals.** Provide pedestals for mounting pedestrian pushbuttons with signs, or traffic and pedestrian signals equipped with slip fitters for 4 inch nominal size pipe.

Provide pedestals of the overall height shown on the plans or as directed by the Engineer.

Provide pedestals meeting the minimum requirements of this subsection. Provide a base designed for a 12<sup>3</sup>/<sub>4</sub> inch bolt circle diameter.

Provide a pedestal made with a cast aluminum base with an aluminum shaft threaded into the base. Secure the shaft by a stainless steel set screw to prevent loosening or turning after installation.

A. **Shaft.** Provide extruded aluminum pedestal shafts meeting the following characteristics:

1. Aluminum alloy meeting the requirements of ASTM B 308 6063-T6,
2. Tensile strength of 30 ksi,
3. Yield strength of 25 ksi,
4. Elongation of 10 percent,
5. Walls 0.237 inch thick, and
6. Outside diameter of 4<sup>1</sup>/<sub>2</sub> inches.

Provide threaded and de-burred pedestal shafts that conform to the basic dimensions of ASME B1.20.1, for taper pipe threads (NPT). Ensure the threaded end of the pedestal shaft has 4 inches of NPT thread. Equip pushbutton pedestals with a standard 4-inch pipe cap.

B. **Finish.** Do not paint aluminum pedestals. Provide aluminum shafts with the minimum finish requirements specified in this subsection.

1. **Finish Type.** Provide a shaft with the full length covered with a tough surface texture that is not a mill finish, consisting of a uniform grain pattern perpendicular to the axis of the shaft.
2. **Texture Profile.** Ensure the grain profile has a surface roughness of at least two, but no greater than four times a roughness average (Ra) of 250 microinches. Provide aluminum pedestal shafts free of the following:
  - a. Excessive material;
  - b. Heat discoloration of material;
  - c. Irregular grain spacing and grain patterns;
  - d. Waviness;
  - e. Scratches or marks of varying depths and sizes;
  - f. Holes;
  - g. Ridges;
  - h. Cracks; and
  - i. Other surface defects, not removed in the finish process.

C. **Mill Certification.** Require the manufacturer to maintain reports and provide copies to the Department on request.

D. **Hardware.** Provide the pedestal complete with foundation bolts having a diameter of at least  $\frac{3}{4}$  inch and 21 inches long with a 3-inch L-bend on the unthreaded end.

Equip foundation bolts with hexagonal nuts and washers. Ensure the threaded end of the bolts are threaded for at least 3 inches. Electro-galvanize bolts after threading in accordance with ASTM B 633, Service Condition 4 for the entire length, or hot-dip galvanize in accordance with ASTM A 153. Provide nuts that are galvanized using similar methods as used on the bolts, and ensure nuts turn freely on the bolts after galvanizing. Provide a level foundation surface to accept the base assembly.

Hold the access door in the base of the pedestal in place with an AISI, 300 Series stainless steel machine screw.

E. **Drawings.** Provide two copies of detailed dimensional and installation drawings to the Engineer.

F. **Packaging.** Provide a protective cap for the threaded end of bolts to prevent thread damage. Provide a cardboard sleeve that covers the entire length of shaft to protect surface finish.

**921.07. Illuminated and Non-illuminated Case Signs.** Provide LED case signs internally illuminated by LEDs and changeable message case signs internally illuminated with halogen type lamps. Ensure signs are designed to operate on 120 volt, single-phase AC electrical systems. Work includes a retrofit unit capable of removing and replacing the LED light module and associated material of an existing internally illuminated case sign.

Provide non-illuminated case signs equipped with retroreflective case sign panels.

Ensure well-fitted, free-moving doors and other moving components. Provide signs of the sizes shown on the plans. Mount signs as shown on the plans.

A. **Hardware.** For fasteners partially or completely exposed on the exterior of case signs, provide AISI, 300 Series stainless steel fasteners. Provide a mounting hub for case signs of  $1\frac{1}{2}$  inch, malleable iron, KK-197, four-bolt mounted on the top center of the sign.

**B. Housing and Door Requirements.**

1. **Housing for LED and Non-Illuminated Case Signs.** Provide one-way and two-way housings constructed of a minimum 0.080 inch thick extruded aluminum.

Provide four-way housings constructed with a minimum 0.063 inch thick aluminum body and a 1.5 inches by 1.5 inches by  $\frac{1}{8}$  inch thick channeled aluminum framework.

Place a 1 inch, screened drain hole at each of the four corners of the housing bottom.

2. **Housing for Changeable Message LED Case Sign.** Provide case sign housing constructed of a minimum 0.125 inch thick extruded aluminum with a 0.063 inch thick flat aluminum back welded at the back.

Provide a back capable of being inserted into a slot designed in the backside of the extrusion. Ensure the slot directs water out of the housing. Ensure corners are TIG welded to provide a weatherproof seal around the entire housing.

3. **Doors for LED Case Signs.** Provide doors for four-way case signs constructed of a minimum 0.080 inch thick extruded aluminum. Provide doors for the one and two-way case signs constructed of a minimum 0.080 inch thick extruded aluminum. Fasten doors to the housing by a full length stainless steel hinge. Secure doors onto a 1 inch wide by  $\frac{5}{32}$  inch thick neoprene gasket with one or two  $\frac{1}{4}$  turn Link Locks.
4. **Doors for Non-Illuminated Case Signs.** Provide doors constructed of a minimum 0.080 inch thick extruded aluminum. Fasten doors to the housing by a full length, 0.040 inch by  $1\frac{1}{2}$  inch open stainless steel hinge. Secure doors onto a 1 inch wide by  $\frac{5}{32}$  inch thick neoprene gasket with one or two  $\frac{1}{4}$  turn Link Locks.

Provide single or double sided signs with a hinged, extruded aluminum service door to provide access to either side for service. Provide a sign capable of displaying messages in from one to four directions.

5. **Doors for Changeable Message Case Signs.** Provide doors constructed of 0.125 inch thick extruded aluminum. Ensure two corners are TIG welded and two corners screwed together to make one side of the door removable for installation of the Fiber Optic Module. Fasten the door to the housing on the left using a full length, 0.040 inch by  $1\frac{1}{4}$  inch open stainless steel hinge. Secure the



door onto a 1 inch wide by  $\frac{5}{32}$  inch thick neoprene gasket using two  $\frac{1}{4}$  turn Link Locks.

Provide single or double sided signs with a hinged, extruded aluminum service door to provide access to either side for service. Provide signs capable of displaying messages in one or two directions.

Ensure the sign door allows full access to serviceable components of the sign.

Fit a three sided visor made of 0.63 inch thick aluminum to the door to act as a sunshade and improve the visibility of the message.

**C. LED Case Sign Electrical Requirements.** Provide an LED case sign designed to operate on 120 VAC, 60 hertz, single phase. Ensure the LED current operates at the manufacturer's recommended current by reducing the input voltage and providing power conditioning circuitry.

Where conductors pass through sheet metal or conduit, provide bushings, grommets, or rolled edges on the edges of openings, to protect conductors from abrasion.

1. **LED Light Module.** Provide LED light modules consisting of LEDs that provide at least 250 candelas per square meter, or an equivalent surface luminance of 1,000 lux over an ambient temperature range from  $-40^{\circ}\text{F}$  to  $165^{\circ}\text{F}$ , consistent with the NEMA temperature specifications. Ensure the LED light modules contain a quantity of white LEDs to uniformly illuminate the viewing area.

Provide LED light modules that consist of a circuit board comprised of an insulated aluminum substrate, at least 0.050 inch thick.

Ensure the LED light module operates for at least 50,000 hours with a lumen depreciation no greater than 30 percent. Ensure the LED supplier provides operational documentation, if requested, based on actual temperature measurements taken after 12 continuous hours of operation, correlated against lumen depreciation and LED mortality curves.

Ensure the LED light engine electronics are entirely conformally coated with at least a 0.002 inch dry coat, to protect the light engine from moisture and corrosion. Ensure LED modules are reduction of hazardous substances (ROHS) compliant.

Attach the LED light module to the case sign housing to allow the module to remain in place during maintenance or retrofit activities. Ensure the LED light module passes the tests specified in subsection

[921.07.C.1.a](#) and subsection [921.07.C.1.b](#), in accordance with the NEMA Standards.

- a. **Thermal Shock Test.** Perform the thermal shock test on LED light modules at temperatures of 85 °F and -40 °F for five cycles of 2 hour dwells with a 2 hour presoak at -40 °F.
- b. **Salt Spray and Soak Test.** Ensure LED light module endures 48 hours of continuous salt spray and 240 hours of salt water soak.

Ensure the manufacturer burns-in LED light modules for 24 hours and certifies for compliance. Ensure the manufacturer mounts a quality control (QC) tracking sticker and the manufacturer's name and date of manufacture on the inside of the LED light module.

Ensure the LED light modules do not exceed a 59 °F temperature rise under continuous operating conditions.

Paint the panels white and ensure panels meet GM4901 Specifications.

2. **Power Consumption and Power Supply Panel.** Provide LED case signs with the maximum power consumption wattage as follows:

| <b>Case Sign Size</b> | <b>Power Consumption</b> |
|-----------------------|--------------------------|
| 1-Way 12 in × 27 in   | 15 watts                 |
| 4-Way 12 in × 27 in   | 60 watts                 |
| 1-Way 24 in × 30 in   | 45 watts                 |
| 2-Way 24 in × 30 in   | 90 watts                 |
| 4-Way 24 in × 30 in   | 180 watts                |

Provide at least 75-watt power supply units rated by the UL for Class 2 operation, 24 volts Direct Current (DC), and Ingress Protection (IP66) rated.

Provide a terminal block for the incoming 120 VAC power. Connect the output of the 24-volt power supply to a two-wire connector that attaches to the LED light modules.

3. **LED Retrofit Assembly.** Provide LED retrofit assemblies meeting the requirements of this subsection. that do not alter the structural properties or functional requirements of the case sign.

**D. Changeable Message Case Sign Electrical Requirements.** Provide changeable message signs capable of displaying three distinct fiber optic type messages. Provide the case sign, hardware, fittings,

cable, and one message, clearly and legibly displayed under any lighting conditions when energized. Refer to the FHWA and [MMUTCD](#) legends for single or multi-message overlays.

Provide a changeable message sign that forms the message with a single or double row of fiber optic glass bundles. Provide energized bundles that are highly visible within a 60-degree cone, centered around the optic axis.

1. **Fiber Optic Module.** Provide a fiber optic module consisting of a flat black, aluminum alloy, 3003 H14 faceplate, 0.080 inch thick, with the fiber optic assembly directly mounted to it. Insert the assembly into the rear track of the extruded aluminum door.

Secure glass, fiber optic bundles into an end tip using epoxy at the termination end, and the common assembly at the other end. Grind smooth and optically polish to ensure maximum light transmission through the bundle.

Insert the end tip of black nylon into a punched hole in the black faceplate and mechanically hold in place with four crush ribs along the outside diameter of the end tip. Ensure the end tip, if installed on the faceplate, does not protrude more than  $\frac{5}{16}$  inch.

Ensure the LED light sources provide the message colors. Provide LED light sources capable of being changed in the field by replacing the solid state LED lamp without removing the sign from the case. Mount the LED light source with four No. 8  $\times$   $\frac{3}{8}$  stainless steel screws between the common assembly and the LED lamp. Provide LED light sources that sustain an average 50,000 hour life.

Provide messages illuminated by at least two light sources, based on the message. Arrange the glass bundles so if one light source fails the other sources continue to provide a legible message by lighting every other point in the message. Ensure no color appears in the output points if the source is not energized, regardless of ambient light condition.

Provide messages that are clearly legible, and attract attention under any lighting conditions. Ensure the sign is highly visible at full intensity within a 20-degree cone, centered around the optic axis.

Provide a  $\frac{1}{8}$  inch thick matte or clear polycarbonate lens with anti glare characteristics to protect the LED assembly. Insert the lens into the front track in the door.

2. **Lamps and Drivers.** Use solid state LED lamps to illuminate the messages. Use two lamps per message to provide fail safe operation in the event of lamp failure.

Provide a 5-watt, LED type, or Department-approved equal LED lamp, based MR 16 traditional halogen package, rated for 50,000 hours life.

Use LED drivers to reduce the incoming 120 VAC to the lamp manufacturer's suggested operating voltage and current. Provide UL Class 2 rated LED drivers that operate at temperatures from -40 °F to 176 °F. Provide LED drivers rated for 50,000 hours of life. Ensure LED drivers provide a consistent light output across the line and load levels. Use a separate LED driver with each lamp to provide failsafe protection.

Provide a barrier-type terminal strip, Weco 324/HDS/12-type or Department-approved equal, for electrical connection of field wires.

Provide signs capable of continuous operation over a range of temperatures from 35 °F to 140 °F.

Include supplementary markings to indicate the correct method of connection for the leads.

E. **Face.**

1. **LED Case Sign.** Provide an LED case sign face that is Lexan translucent white, or other Department-approved equal plastic material with equivalent or better weathering, structural, and optical properties.

Provide a face that is 0.125 inch thick  $\pm 10$  percent. Mark each face with the plastic name or trade name.

Provide sign faces with a message applied to the outside. For black sign copy, provide 3M Company, Scotchcal, ElectroCut Film No. 7720 12 and for red copy, provide 3M Company Scotchlite, ElectroCut Film (E.C. Film) No. 1172, or Department-approved equals. Provide a symbol or text message, of one or two colors, as shown on the plans, or specified by the Engineer at the time of the order.

2. **Changeable Message Case Sign.** Provide changeable message case sign faces, designed to clearly and legibly display three distinct fiber optic messages, one message at a time, when energized under any lighting conditions. Refer to standard FHWA and [MMUTCD](#) legends to provide a single or multi message overlay.

Form the message with single or double rows of fiber optic glass bundles. Ensure the energized bundles are highly visible within a 60-degree cone centered around the optic axis.

3. **Non-Illuminated Case Sign Panel.** Provide non-illuminated case sign panel sections meeting the requirements of subsection [919.02.C](#). Provide reflective sheeting material meeting the requirements of ASTM D 4956, for Type IX retroreflective sheeting unless otherwise required.

Provide one-piece case sign panel sections of Type III aluminum sheet with no vertical splices.

Apply the reflective and non-reflective legends in accordance with the sheeting manufacturers' recommendations. Provide legends that display one symbol or text message as shown on the plans and in accordance with the [MMUTCD](#).

Insert the case sign panel into the front track in the door.

For sign panels without legends, provide aluminum panels, or as directed by the Engineer. Coat the exterior face with a semi-gloss or gloss yellow enamel. Provide a color within the limits shown on the Highway Yellow Color Tolerance Chart for the central color, except provide a color darker than the central color. Coat the interior face with a semi-gloss or gloss white enamel.

F. **Wiring.** Provide illuminated case signs completely wired. Provide 600 volt, No. 18 AWG soft annealed copper wiring with the following characteristics:

1. Color coded,
2. At least seven strands, and
3. Insulation of 194 °F THHN thermoplastic or 194 °F neoprene and marked.

Provide wiring that runs neatly in flexible aluminum conduit between the power supply and the socket housing. Where conductors pass through an opening in sheet metal or conduit, provide bushings, grommets, or rolled edges to protect conductors.

Make splices and terminations at the terminal block, switch, lampholder leads, or ballast leads. Make splices mechanically and electrically secure using insulated pressure-type, solderless connectors. Make terminations mechanically and electrically secure using insulated pressure-type solderless terminals. Provide nickel-plated brass wire connecting screws, tabs, washers, and strips.

Mount switches and prevent them from turning by providing mechanical means other than friction.

**G. Painting Requirements.** Before painting the case sign, clean metal surfaces and surface treat in accordance with standard industry practice to ensure paint bonds to the metal.

Provide a coating system consisting of durable and weather-resistant enamels of the required color, applied in a uniform thickness, without blisters, runs or other defects. Provide an average dry film thickness of 1.5 mils, determined by Method A, "Inductance Thickness Gauge," as specified by ASTM D 7091, "Measurement of Dry Film Thickness of Nonmagnetic Coatings of Paint, Varnish, Lacquer, and Related Products Applied on a Nonmagnetic Metal Base." Coat the metal interior of the sign with a semi-gloss or gloss white enamel.

Coat the exterior of the sign with a semi-gloss or gloss yellow enamel. Provide a color within the limits shown on the Highway Yellow Color Tolerance Chart for the central color, except provide a color darker than the central color.

**H. Packing and Marking.** Provide finished signs with a permanent legible marking that includes the supplier's name, trademark, or other means of identification.

Package signs individually for transport by common carriers without damage or defacement to the sign during transportation. Mark each package is legibly with the descriptions of contents and supplier's name.

**I. Inspection.** The Department will perform inspections of illuminated and non-illuminated case signs. Provide mill test reports for aluminum extrusions upon the Department's request.

At the time of delivery, ensure the supplier provides a general certification, stating that materials meet pretreatment requirements, as specified by subsection [921.06.E](#). Ensure the certification references the method and material used in the pretreatment process.

### **921.08. Traffic Loop.**

**A. Traffic Loop Wire.** Provide loop wire and loop lead-in wire meeting the requirements of subsection [918.03](#).

**B. Traffic Loop Sealant.** To seal and encapsulate detector loop wires in concrete or hot mix asphalt (HMA) roadway surfaces, provide sealant in cartridges for use with a common 1 quart manual caulking gun or air powered caulking gun. Provide sealant meeting the following requirements:

1. Consists of one part moisture curing and self leveling polyurethane, not containing a level of solvents that would cause an incompatibility with asphalt. If installing traffic loop in existing pavement before placing a final asphalt wearing course, provide sealant compatible with the asphalt wearing course.
2. Minimum temperature range for application from 40 °F to 100 °F, and a minimum service temperature range from -40 °F to 200 °F.
3. Dielectric constant greater than 6 at 50 Hertz, and greater than 4 at 500 Hertz or greater.
4. Viscosity from 28,000 cPs to 48,000 cPs, tack free within 24 hours or less after application.
5. Non-stringing and capable of opening to traffic immediately after sealant recesses 1/8 inch.
6. Provides complete encapsulation of the detector loop wires in a rubber-like environment, and provides protection against moisture, wire and thermal pavement movements, and damage under normal roadway conditions.
7. Moisture cure to a tough, long lasting seal that resists weather, abrasion, oils, gasoline, anti-freeze solutions, brake fluids, and road salts and other deicers.
8. Remains permanently flexible without shrinking or pulling-out of the saw cut groves after application. Ensure cured sealant is temperature stable throughout the specified minimum service temperature range without performance degradation.

**C. Packaging and Marking.** Deliver materials in the original, tightly sealed containers, clearly labeled with the manufacturer's name, product identification, and lot number. Pack each case of cartridges to prevent damage or defacement to the cartridges during transportation to the project. Mark each carton legibly with a description of the contents and the supplier's name.

**921.09. Digital Loop Detector.** Provide digital loop detectors meeting current and applicable NEMA standards. Provide high performance, two or four channel, inductive loop vehicle detectors with liquid crystal displays (LCD) to indicate the operational, setup, and loop diagnostic parameters of the loop detector system in accordance with the minimum design, operational, and functional performance requirements specified in this subsection.

**A. Detector Loop Requirements.** Provide detector units meeting the environmental, transient, and size requirements of NEMA Standards TS-1 1994, Section 15, TS-2, 2003 Section 6.5, and California/New York Type 170/179 specifications.

Provide microprocessor controlled, fully digital, self tuning detector units with two or four operationally independent channels. Ensure the detector unit is configured as a rack-mounted printed circuit board for insertion into a NEMA TS-1 and TS-2 rack, or Caltrans Type 170 detector input file.

Provide a detector with optically isolated, solid state outputs, designed to provide a continuous "fail-safe" output in the event of power loss to the unit. Ensure each channel provides a continuous fail-safe output and indication in response to an open or shorted loop.

Provide a detector that uses two spring-loaded toggle switches per channel to setup and retrieve information from the detector.

Provide a detector unit that displays and records open loops, shorted loops, or an excess inductance change greater than 25 percent. Program the LCD and yellow fault LED to display the type of error. Program the LCD to display "Shorted loop," "Open loop," or "25% DL/L" and log the most recent 25 events. Provide units that store the information in non-volatile memory.

Ensure each channel includes two, wide angle, high visibility LED indicators.

Provide channels with a red LED to display channel detect output status, output state, and the status of the delay and extension timers, plus a yellow LED to display loop fault monitor diagnostics.

Ensure the red channel detect LED indicator flashes at a rate of 2 hertz during delay timing and flashes at a rate of 4 Hertz during extension timing.

Ensure the yellow fault LED flashes once to indicate an open loop, twice to indicate a shorted loop, and three times to indicate an excessive change in inductance.

During fault indication, ensure the red channel detect LED flashes at the same rate as the yellow fault LED to indicate a current fault. If the fault self-heals, ensure the red LED returns to normal operation and the yellow fault LED continues to flash, indicating a prior fault.

**B. Graphic Liquid Crystal Display.** Provide a graphic LCD unit capable of displaying two or four channels simultaneously.

Provide a unit capable of setting up channels simultaneously and resetting channels individually.

Provide a unit that uses a white back light for the LCD. Do not provide units with electro-luminescence.



**C. LCD Full Prompting Menu System.** Provide an LCD unit that prompts the user with word prompts in English for easy setup, operation, diagnostic, and information gathering operations.

Provide a menu system that prompts the end user for the input specified in this subsection during setup and operation.

1. **Sensitivity.** Ensure the LCD prompting menu offers a range of sensitivity values from 1 to 15, and an "OFF" option that disables the channel. Provide a system that displays a pie chart showing the deflection caused by vehicles on the loop, to assist in determining the correct sensitivity, and an XY chart showing the deflection values and vehicle calls over time.
2. **Frequency.** Provide an LCD prompting menu that displays eight frequency values that the user can select from, depending on the frequency of adjacent loops. Ensure the actual frequency is displayed and can be compared to adjacent detectors to achieve maximum separation between adjacent loops. Provide a unit capable of graphically displaying noise or crosstalk on the display.
3. **Operational Mode.** Provide an LCD prompting menu that allows users to select one of two operational modes: "Pulse" or "Presence." If selecting "Presence," program the unit to prompt the user for "Short," "Long," or "User Defined Presence."
4. **Timing.** Ensure the timing menu for "Delay" and "Extension" prompts the user for a "yes" or "no" response. If selecting "yes," program the unit to prompt for the delay amount and extension timing.
5. **Count.** Provide a count that controls the secondary count outputs and prompts the user for a "yes" or "no" response. If selecting "yes," program the unit to prompt the user for the loop configuration from which it will take the counts and if secondary count outputs are active.
6. **Approach ID.** Program the unit to prompt the user to select alphanumeric characters to identify the related approach of the channel (e.g. SBLT for south bound left turn).
7. **Display.** The "Display" selection determines the display that shows during normal operation at power up. Program the unit to prompt the user for frequency (FREQ), inductance (INDUCT), and count (Count). Ensure pressing "down" cycles through the display options.
8. **Event Logs.** Ensure selecting "Logs" allows the user to view the last 25 events, the most recent first, on a per channel basis. Provide a

log with the type of fault, power up, power loss, and reset events, and the time elapsed after each event.

#### D. Edge Connector Description.

| Pin No. | Function                          |
|---------|-----------------------------------|
| A       | DC Supply - (Logic Ground)        |
| B       | DC Supply + (12 VDC – 24 VDC)     |
| C       | Reset                             |
| D       | Loop Input Channel 1              |
| E       | Loop Input Channel 1              |
| F       | Call Output Channel 1 (Collector) |
| H       | Call Output Channel 1 (Emitter)   |
| J       | Loop Input Channel 2              |
| K       | Loop Input Channel 2              |
| L       | Earth Ground                      |
| S       | Secondary Count Output Channel 1  |
| W       | Call Output Channel 2 (Collector) |
| X       | Call Output Channel 2 (Emitter)   |
| Y       | Secondary Count Output Channel 2  |
| 1       | Green Input Channel 1             |
| 2       | Green Input Channel 2             |
| 7       | Status Output Channel 1           |
| 20      | Status Output Channel 2           |

**E. Operation Requirements.** Provide detector units designed to operate over a voltage range from 10.8 VDC to 28 VDC. Provide a power supply that operates over a voltage range from 10.8 VDC to 28.8 VDC, and at no greater than 90 milli-amperes for back light illuminated units. Provide detector units with the following characteristics:

1. Loop tuning range from 20 micro hertz to 2,500 micro hertz, plus a lead-in with a range from 15 kilo Hertz to 60 kilo Hertz;
2. Q-factor of 5 minutes;
3. Low (true) inputs of less than 8 volts, and high (false) inputs greater than 16 volts;
4. Solid state, optically isolated call output. Ensure the “On” voltage is less than 1.5 volts at 50 milli-amperes collector current;
5. Status and count outputs no greater than 50 volts collector voltage, with an “On” voltage less than 1.5 volts at 50 milli-amperes collector current;

6. The following physical dimensions:
  - a. 7 inches by 4.5 inches international card with 44 pin double-sided gold-edge connector, and
  - b. 1.12 inch wide faceplate with 3 inch by 1 inch handle;
7. Weight of 1 pound; and
8. Functional from  $-29^{\circ}\text{F}$  to  $165^{\circ}\text{F}$  at a maximum non-condensing humidity of 95 percent.

**F. Functional Data and Parts Lists.** Ensure the manufacturer provides a complete set of the following items with each loop detector, directly applicable to the loop detector with which the item is supplied:

1. Schematic and wiring diagrams of the loop detector and terminal facilities,
2. Instructions for loop detector installation and maintenance, and
3. Parts list.

**G. Packing and Marking.** Package each loop detector separately to prevent damage or defacement to the loop detector during transportation. Mark each carton legibly with the loop detector description, contract number, and supplier's name.

**921.10. Steel Truss Arms.** Provide steel truss arms for mounting video detection cameras and radio antennae as shown on the plans and in accordance with this subsection.

**A. Truss Brackets.** Provide truss brackets formed from round tube and steel bar or plate, complete with stainless steel U-bolts, nuts, and washers for mounting to steel poles or curved plate with bolt holes for mounting to wood poles. Provide trusses with an 18-degree rise in the top arm tube, from the mounting plate to the location of the device attachment. Locate a  $\frac{7}{8}$  inch rubber grommet within 3 inches of the mounting base plate on the underside of the upper arm tube.

**B. Truss.**

1. **Wood Pole Mount.** Provide arm tubes meeting the requirements of ASTM A 500, for Grade B steel, with  $2\frac{7}{8}$  inch outside diameter (OD) by 0.203 inch thick tubing overlapped and welded to  $2\frac{3}{8}$  inch OD by 0.154 inch thick stock tubing for 16 foot, 18 foot, and 20 foot arms, or  $2\frac{3}{8}$  inch OD by 0.120 inch thick for arms no longer than 15 feet.

To form the truss, weld  $\frac{1}{2}$  inch by 2 inch flat bar steel, meeting the requirements of ASTM A 36, between arm tubes. Provide a pole mounting plate, formed using  $\frac{3}{8}$  inch ASTM A 36 steel plate and plate gussets welded to the arm tubes in accordance with the mounting plate detail shown on the truss arm drawing.

Provide one plate per arm tube. Ensure each plate incorporates two 0.562 inch diameter holes and one 0.687 inch by 1.50 inch keyhole for lagging to the wood pole.

2. **Steel Pole Mount.** For 1½ foot, 4 foot, 6 foot, 9 foot, 12 foot, 15 foot, and 18 foot arms, provide arm tubes meeting the requirements of ASTM A 500, for Grade B steel, with 2¾ inch OD by 0.120 inch thick tubing, welded to ¼ inch formed steel mounting plate meeting the requirements of ASTM A 36.

To form the truss, weld ½ inch by 2 inch flat bar steel meeting the requirements of ASTM A 36, between arm tubes. Provide ¼ inch flat bar steel gussets welded between the arm tube and mounting plate.

Use steel U-bolts and other hardware, meeting the requirements of ASTM A 36, to attach trusses to the steel pole. For poles with a diameter range from 8½ inches to less than 9½ inches, use ⅝ inch rod bolts. For poles with a diameter range from 9½ inches to 10¼ inches, use ¾ inch rod U-bolts. Use hex nuts, flat, and lock washers for fastening U-bolts.

- C. **Finishes.** Provide truss arms, brackets, and hardware, hot-dipped galvanized after fabrication and welded in accordance with ASTM A 123 and ASTM A 153. Weld in accordance with AWS D1.1 Structural Welding Code - Steel.

**921.11. Mast Arm Mount Signal Bracket.** Provide adjustable mast arm mount signal brackets in accordance with Figure [921-1](#) and this subsection.

- A. **Adjustability.** Ensure the bracket is adjustable as shown in Figure [921-1](#), A through D.

B. **Attachment.** Provide the bracket with Type 201 stainless steel band to fasten the bracket to the supporting arm or structure. Provide an easily adjustable bracket to fit all sizes of round, octagonal, elliptical, or other shaped structure without special tools or equipment.

C. **Signal Accommodations.** Attach the bracket to the signal by clamping the signal from the top and bottom to ensure maximum rigidity. Provide a standard bracket, as shown in Figure [921-1](#), to accommodate all major signal manufacturers' signals ranging from a three-section one-way 8-inch signal to a three-section one-way 12-inch signal, or a combination of sizes including 3M and ICC configurations.

|               |   |  |
|---------------|---|--|
| A. Top View   |  | Rotational Adjustment<br>About Bracket Arms                    |
| B. Side View  |   | Vertical Adjustment  |
| C. Side View  |    | Rotational Adjustment<br>About Mast Arm                        |
| D. Front View |    | Rotational Adjustment<br>Right and Left From<br>Vertical Plane |

Figure 921-1: Signal Head Bracket Adjustment

Ensure electrical wiring is concealed in the bracket. Provide a gusseted, C-shaped, extruded aluminum tube for the vertical support to accommodate the signal cable, regardless of the vertical position of the tube.

**D. Material and Design.** Provide upper and lower arms cast from 319 aluminum or a Department-approved equal. Ensure the lower bracket arm is internally threaded to accommodate the threaded vertical support tube. Provide the lower arm with ABS plastic covers that will slide and snap into position without fasteners or tools. Ensure the upper and lower arms have 72 tooth serrations cast into the arm to ensure a positive lock with the signal housing, secured around the rotational axis with setscrews. Provide upper and lower arms with a tri-bolt arrangement for attachment to the signal housing. Ensure the lower arm has an opening to accommodate at least three 12 conductor, 14 gauge cables.

**E. The Vertical Support Tube.** Provide a double gusseted, extruded 6082-T8 aluminum alloy tube for the vertical support with the cross section shown in Figure 921-2, Section "A-A." Provide each tube with a vinyl closure strip, threaded on one end to accommodate the lower arm assembly.

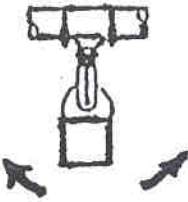
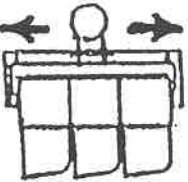
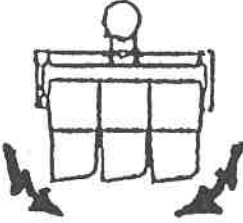
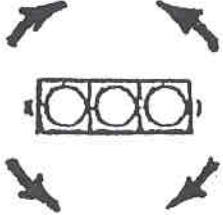
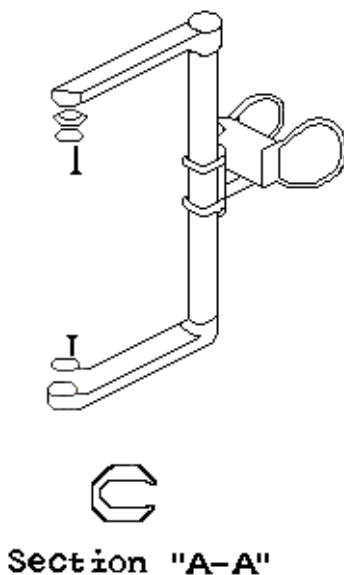

**Figure 921-2: Section "A-A"**

**F. The Mast Arm Clamp Assembly.** Provide a mast arm clamp assembly with male and female halves cast from 356-T8 aluminum alloy or a Department-approved equal. Ensure the male clamp half is secured in the female half, using a spring steel retainer ring. Ensure the assembly provides an unobstructed center of at least 2 inches in diameter to allow for 360-degree rotation of the clamp assembly. Ensure no internal cross bracing assembly obstructs the center opening.

Provide a mast arm clamp assembly equipped with two stainless steel bands, 1 inch wide, 0.045 inch thick, and 29 inches long. Ensure stainless steel bands have a tensile strength of at least 100,000 psi. Use a set screw secured buckle to secure the band.

**G. The Clamp Screw.** Provide a clamp screw for attaching the stainless steel bands to the clamp kit. Use a  $\frac{7}{16}$  inch, 14 inch by 3 inch one piece unit clamp screw, drop forged from C-1045 carbon steel or 410 stainless steel with a tensile strength of at least 80,000 psi, formed with a slot sized to accept a 1 inch band.

**H. Hardware.** Provide each bracket with required bolts, washers, gaskets, and other hardware to attach the signal to the bracket and the bracket to the mast arm.

**I. Finish.** Provide aluminum parts with an Alodine 1200 finish or Department-approved equal.

Provide steel parts with a yellow, zinc di-chromate finish.

## Section 922. TEMPORARY TRAFFIC CONTROL MATERIALS

**922.01. Description.** Temporary traffic control devices must meet the design requirements of the [MMUTCD](#), Part 6 and the requirements of section [922](#).

Provide the Engineer with certification and an FHWA acceptance letter stating that the materials and devices meet the requirements of this section. Certification documents and the FHWA acceptance letter do not waive material and device inspection, sampling, or testing requirements, as determined by the Engineer.

### 922.02. Temporary Signs.

**A. Sign Panel and Supports.** Temporary signs must meet NCHRP-350 crashworthy requirements or the requirements of the *Manual for Assessing Safety Hardware* (MASH), as applicable.

1. **Portable Sign Systems.** Portable sign systems must meet the following requirements:
  - a. Signs for which the substrate totals 20 square feet or less, must be constructed with the materials and design features specified in the FHWA acceptance letter.
  - b. Signs must have a 5-foot minimum bottom height and have one or two rigid legs.
  - c. The leg of bases using only one rigid leg must have an “X” or “H” configuration.
  - d. Temporary ground driven sign system must be constructed as described in the Maintaining Traffic Typical WZD-100 or other NCHRP-350/MASH accepted design.
2. **Portable Sign Substrate.** Portable sign substrates must conform to the materials requirements of section [919](#) and the following requirements:
  - a. Rigid sign panels no greater than 3 feet by 3 feet must be aluminum sheet or plywood.
  - b. Rigid sign panels larger than 3 feet by 3 feet and up to 8 feet in width must be plywood.
  - c. Rigid sign panels with a width of greater than 8 feet but not greater than 12 feet must be plywood or extruded aluminum.
  - d. Rigid sign panels with a width greater than 12 feet must be extruded aluminum.
  - e. Temporary sign panels fabricated with plywood must have a minimum thickness of ½ inch.



The Department will not permit vertical joints in sign substrates or horizontal splices through legends or symbols.

**B. Reflective Sheeting.** Prismatic grade reflective sheeting must meet the requirements of ASTM D 4956, for Type VIII prismatic sheeting or higher. Orange colored sheeting must be fluorescent orange reflective sheeting.

**C. Legend.** Legend fabrication and application must meet the requirements of the [Michigan Standard Highway Signs Manual](#) or as shown on the plans.

**D. Sign Covers.** Cover material for permanent signs and temporary signs on driven supports must be exterior grade plywood, hardboard, sheet metal, aluminum, or rigid plastic capable of resisting deterioration from weathering and atmospheric conditions for the duration of the project. Do not use flexible materials on permanent signs. Flexible materials may only be used on temporary signs.

Covers must be opaque during all light and weather conditions and must cover the entire front of sign panels. The Engineer will not require the Contractor to cover the entire sign panel on overhead signs and large guide signs greater than 60 square feet, but the Contractor must cover conflicting information.

**922.03. Channelizing Devices.** Channelizing devices include cones, drums, 42-inch channelizing devices, and Type III barricades. Reflective sheeting for channelizing devices must meet or exceed the requirements of ASTM D 4956 for Type III high intensity sheeting.

**A. Cones.** Traffic cones must be predominantly orange, at least 28 inches high, and made of material capable of withstanding impact without damaging vehicles. Provide certification from the manufacturer that cones meet NCHRP-350/MASH requirements.

**B. Drums.** Drums must be composed of a low-density polyethylene plastic. Do not use high-density polyethylene for plastic drums. Provide certification from the manufacturer that drums meet NCHRP-350/MASH requirements. Reflectorized sheeting on drums must consist of 6-inch stripes meeting the requirements of ASTM D 4956, for flexible Type III high intensity reflectorized sheeting. The drum striping design must meet the requirements of WZD-125.

**C. Drums with Lights.** Drums with warning lights must meet NCHRP-350/MASH requirements.

**D. 42-Inch Channelizing Devices.** Forty-two-inch channelizing devices must meet the following requirements:

1. Have 42-inch minimum height and may include a “handle” or lifting device that extends above the 42-inch height;
2. Be fabricated of material capable of withstanding impact without damaging vehicles;
3. Meet NCHRP-350/MASH requirements;
4. Have a base at least 8 inches in diameter and taper to at least a 4-inch diameter at the top, regardless of orientation;
5. Provide predominantly orange 42-inch channelizing devices;
6. Include ballast meeting the manufacturer’s specifications as necessary to keep them upright; and
7. Be reflectorized with flexible ASTM D 4956 Type III high-intensity sheeting material as follows:
  - a. Sheeting material must have a smooth, sealed outer surface capable of displaying the same color during the day and night.
  - b. Sheeting pattern must consist of four 6-inch alternating orange and white bands with no more than 2 inches between the bands, with the top band being orange and spaced no greater than 4 inches from the top of the device.

**E. Type III Barricades.** Type III barricades consist of three horizontal reflectorized rails, supports, and warning lights. When Type III barricades are shown on the plans as being double sided, both sides of the rails must be reflectorized. Rails must be reflectorized with orange and white diagonal striped ASTM Type III high intensity sheeting. Type III barricades must meet NCHRP-350/MASH requirements and the design criteria of WZD-125.

#### **922.04. Temporary Concrete Barrier and Endings.**

**A. Temporary Concrete Barrier.** Provide temporary barrier sections at least 10 feet long. Provide shorter barrier sections for locations where longer sections cannot achieve the required curvature or deflection in barrier alignment. Furnish and operate section lengths that meet the requirements of NCHRP-350/MASH, and that have been accepted by the FHWA. Provide certification documenting that the concrete used in fabricating the barrier sections meets or exceeds the requirements of the concrete used in crash tested sections.

Temporary concrete barrier must meet the requirements of NCHRP-350 Test Level 3 or higher or MASH requirements and when installed, the tested maximum deflection must not exceed 6½ feet.

The bottom width of barrier sections must not exceed 28 inches. The top of sections must be flat and at least 6 inches wide.

Cast barriers using Grade S3 concrete and cure in accordance with subsection [804.03.F](#). Cast barriers in accordance with the weather and temperature limitations specified in subsection [602.03.T](#). Ensure a uniform, smooth finish on temporary concrete barrier surfaces.

The Contractor may use lifting devices or openings to enhance placement. Ensure lifting devices do not protrude from the sides or top of the barrier when the barrier is in place.

Install barrier reflector markers on temporary concrete barrier to delineate the barrier wall. Markers must be trapezoidal or rectangular and include a methyl acrylate reflective area of at least 7.5 square inches. Initial photometric requirements at 0.2-degree observation angle and 0-degree entrance angle must be at least 9 candela per lux for white markers and 6.5 candela per lux for yellow markers.

**B. Temporary Concrete Barrier Ending.** The concrete end section shown on Standard Plan R-52 Series must meet the requirements for temporary concrete barrier as specified in section [812](#). The cross section and connection type for concrete barrier endings must match the cross section of the end of the in-place concrete barrier.

Impact attenuator devices must be constructed from material specified by the manufacturer and in accordance with Standard Plan R-49, R-52, R-54, and R-126 Series.

Construct concrete attenuator base pads, foundations, anchor blocks, or backup units using Grade S1 concrete, unless otherwise directed by the Engineer.

The Contractor may use NCHRP-350, Test Level 3 or MASH approved attenuation.

Ensure attenuator transition assemblies, transition panels, end panels, connections and other miscellaneous accessories required for installation meet the manufacturer's specifications.

Provide all modules in a sand module attenuator array from the same manufacturer. Do not mix different types of modules.

Provide sand for filling sand module attenuators meeting the gradation and moisture content requirements specified by the manufacturer.

**922.05. Temporary Guardrail.** Use existing guardrail beam elements and guardrail approach terminals for reconstructing guardrail if the Engineer determines this material is reusable in their present condition. The Contractor may reuse existing guardrail posts in good condition, as determined by the Engineer, for reconstructing guardrail. If existing

material is not reusable, provide new guardrail panels, posts, bolts, reflectorized washers, and other fittings.

Provide new guardrail beam elements and associated hardware meeting the requirements of subsection [908.11](#).

Provide new guardrail posts of the same type as existing posts, and ensure new guardrail posts meet the requirements of section [912](#) for wood posts, or section [908](#) for steel posts.

**922.06. Temporary Pavement Markings.** Temporary pavement markings consist of painted lines, pavement marking tape, and temporary raised pavement markers (TRPMs).

**A. Pavement Marking Materials.** Select paint, preformed tape, and temporary raised pavement markers from the Qualified Products List.

1. **Pavement Marking, Type R.** The contract documents require Type R markings if the markings, applied during the project, require removal during the life of the contract. Provide Type R temporary pavement marking as preformed tape. Apply and remove preformed tape in accordance with the manufacturer's instructions. The tape must remain flexible and conform to the texture of the pavement surface during use.
2. **Pavement Marking, Type NR.** The contract documents require Type NR markings if the markings applied during the project can remain in place. Provide Type NR temporary pavement markings as preformed tape or paint reflectorized with glass beads, as required. The tape must remain flexible and conform to the texture of the pavement surface during use.

**B. Temporary Raised Pavement Markers (TRPM).** Provide temporary raised pavement markers, reflectorized on one or both sides, depending on exposure to one-way or two-way traffic. Install TRPMs using the manufacturer's recommended adhesive and in accordance with the manufacturer's instructions.

1. **TRPM Type 1.** TRPM Type 1 consists of a flexible retroreflective strip with a protective removable plastic shield that the Contractor may use as a temporary pavement marking on a hot-mix asphalt (HMA) pavement surface before applying chip seal.
2. **TRPM Type 2.** TRPM Type 2 consists of a flexible retroreflective strip that the Contractor may use as a temporary pavement marking on interim HMA layers or concrete surfaces.

3. **TRPM Type 3.** TRPM Type 3 consists of a solid plastic device with a retroreflective face surface that the Contractor may use as a durable temporary pavement marking.

**C. Pavement Marking Cover.** Preformed polymer tape pavement marking covers must have a black or gray non-reflective matte finish. In addition to the requirements of subsection [922.06.A.1](#), pavement marking cover tape must meet the following requirements and characteristics:

1. Be 6 inches wide, and designed to last from 1 day to 10 days;
2. Be at least 0.04 inches thick, not including adhesive;
3. Be pre-coated with a pressure sensitive adhesive, capable of adhering to existing markings;
4. Contain no metallic foil;
5. Consist of a mixture of high quality polymeric material, pigments, and inorganic fillers distributed throughout the base cross sectional area, with a black or gray non-reflective matte finish top layer with non-skid particles;
6. Provide an initial average surface skid resistance value of 60 BPN when tested in accordance with ASTM E 303;
7. Remain in useable condition for 1 year after the receipt date, when stored in accordance with the manufacturer's recommendations; and
8. Be manually removable in large pieces, at temperatures greater than 40 °F, without using heat, solvents, grinding, or blasting.

Ensure the tape, when applied in accordance with the manufacturer's recommendations, provides a neat, durable masking that does not flow or distort on a stable pavement surface due to high temperature. Provide weather resistant film, capable of withstanding normal traffic wear without lifting, shrinking, tearing, rollback, or other signs of poor adhesion. Incorporate a non-metallic medium to facilitate removal.

### **922.07. Lighting Devices.**

**A. Lighted Arrow, Types B and C.** Lighted arrows for traffic control in work zones consist of a lighted arrow panel, controller, and a power supply, mounted on a heavy-duty trailer.

1. **Lighted Arrow Panel.** Lighted arrow panels must have a flat black non-reflective surface and lights on the back to indicate which message mode is in operation.

Type B panels must be at least 30 inches high by 60 inches wide and be equipped with 13 light emitting diode (LED) amber lights.

Type C panels must be at least 48 inches high by 96 inches wide

and be equipped with 15 LED amber lights. Program lights to present the following flashing message modes:

- a. Left arrow,
  - b. Right arrow,
  - c. Double arrow, and
  - d. Caution.
2. **Controller.** Lighted arrows must have a photoelectrically controlled circuit that automatically adjusts the lamp intensity to ambient light conditions and with no manual override. An automatic intensity control that keeps the lamps at constant brightness when the battery is low is required.
  3. **Power Supply.** Lighted arrows must have a solar power supply with a battery backup and a built-in 110 VAC battery charger. When fully charged, the arrow panel must be capable of operating for 20 days in single arrow mode with the photocell covered.
  4. **Legibility.** The arrow panel must have an average legibility of 1 mile and, must be legible from ½ mile if viewed 10 degrees from center. Ensure arrow panels, installed for field use, meet the legibility requirements of subsection [812.03.D.7](#).
  5. **Trailer.** The trailer and trailer components, with the exception of the sign panel, must be painted in highway orange. Delineate the trailer with a 4-inch by 18-inch strip, or an equivalent area, of reflectorized red and white conspicuity tape, installed on each of the four sides of the trailer. Locate these strips at each corner of the trailer.
- B. Warning Lights.** Provide warning lights with LED technology. Type A, Type B, and Type C warning lights must meet the Institute of Transportation Engineers Purchase Specification for Flashing and Steady Burn Warning Lights. Lights must be battery or solar powered, and must be maintained in accordance with subsection [812.03.G.6](#). Provide the following types of warning lights as required:
1. Type A, low intensity flashing warning lights with a yellow lens.
  2. Type B, high intensity flashing warning lights with a yellow lens and a visor affixed to shield the lens from overhead sunlight.
  3. Type C, steady burn warning lights with a yellow lens.
  4. Type D, 360-degree steady burn warning lights with a yellow lens. Lenses for Type D lights on plastic drums must be visible for 360 degrees and the LED light source must emit light equally for 360 degrees. The LED light source must sustain constant brightness, evenly distributed throughout the lens until unable to

maintain the intensity requirements specified in subsection [812.03.G.6](#).

**C. Portable Changeable Message Signs.** Portable Changeable Message Signs (PCMS) consist of a message board, controller, and power supply, mounted on a heavy-duty tow-able trailer.

1. **Message Board.** Message boards must meet the following requirements:
  - a. Measure at least 75 inches high by 114 inches long;
  - b. Have a character height of 18 inches with 8 characters per line and a pixel matrix that is 5 pixels wide and 7 pixels high;
  - c. Provide spacing between characters at least twice the element stroke width;
  - d. Be either disk matrix, or LED, or both disk matrix and LED, capable of displaying three message lines;
  - e. Include a photocell to regulate the internal lighting system; and
  - f. Include a sighting device to ensure required alignment.

Disk matrix PCMS must have fluorescent lighting at the top and bottom of each message line. LED PCMS must have with forced air ventilation and with filtered inlets to maintain the interior temperature within temperature limits for LEDs.

2. **Legibility.** PCMS must have an average legibility of 1,000 feet if viewed head-on and 10 degrees off center.
3. **Controller.** Controllers for PCMS must be equipped with the following:
  - a. Micro-processor based unit with a storage capacity of at least 50 preprogrammed messages;
  - b. Non-volatile memory capable of holding the keyboard created messages in memory during a non-power period;
  - c. Password security feature to prevent unauthorized use;
  - d. Message display capable of displaying a variable message at a rate of 0.25 second increments or correlated to 0.25 second increments; and
  - e. Message display panel showing the message on the sign or created on the keyboard, and capable of giving the operator programming instructions.
4. **Electrical/Electronics.** Control cabinet for PCMS must be equipped with the following:
  - a. Lockable door and an interior light for night operations.

- b. Ventilated cabinet with screen covering on the vents to prevent damage from insects.
  - c. NEC 400-10 and NEC 400-14 compliant connections to control cabinets and sign board.
  - d. International Municipal Signal Association Wiring and Cable Specifications 20-1, 20-2, 20-5, and 20-6 compliant external electrical wiring.
  - e. Shock-mounted sign electronics, to reduce vibration. Provide shock mountings in the circuit designs, mechanical supports for drive transistors, and in the type of conformal coating.
  - f. Printed circuit boards mounted with spring-load tension screws for ease of access and removal.
5. **Power Supply.** Power supply to the PCMS must be a maintenance-free battery with one of the following backup systems:
- a. Generator with electric start, capable of continuous operation without refueling for 72 hours; and
  - b. Solar, with a built-in 115 VAC battery charger, capable of sequencing a message for 18 days to 21 days consecutively without sun in 16 °F weather conditions.
6. **Trailer.** The PCMS trailer must be painted in highway orange. Delineate the trailer with a 4-inch by 18-inch strip, or an equivalent area, of reflectorized red and white conspicuity tape, installed on each of the four sides of the trailer. Locate these strips at each corner of the trailer. The trailer must conform to the Michigan Vehicle Code with a nonskid upper surface.

The PCMS must be mounted to the trailer with a sign panel support that moves up, down, and rotates 360 degrees, with a safety bolt to prevent the sign panel from lowering once in the raised position. The support must be equipped with a hydraulic system that includes a manual pump with manual release for use as a back up for the electric hydraulic pump. The bottom of the sign panel must be at least 7 feet above the roadway when in operating mode.

**922.08. Temporary Traffic Signals and Street Lighting.** The Contractor may provide used material and equipment for temporary traffic signals and street lighting. Obtain the Engineer's approval for used material before installation. The Contractor is responsible for performance and maintenance of used material throughout the life of the project.

**922.09. Temporary Traffic Signals.** Material for temporary traffic signals must meet the requirements of section [918](#) and section [921](#), the



Institute of Transportation Engineers (ITE) for *Vehicle Traffic Control Signal Heads* (VTC SH), “LED Circular Signal Supplement,” and the [MMUTCD](#).

**922.10. Portable Temporary Traffic Signal System.** Material for portable temporary traffic signal systems (PTS) must meet the requirements of section [918](#) and section [921](#), the Institute of Transportation Engineers (ITE) for *Vehicle Traffic Control Signal Heads* (VTC SH), “LED Circular Signal Supplement,” and the [MMUTCD](#).

**A. Trailer.** PTS trailer must be self-contained and meet the following requirements:

1. Consist of a vertical upright and horizontal mast arm to accommodate two 12-inch overhead traffic signal heads, mounted at the same height, and capable of providing at least 16 feet of clearance.
2. Allow at least one signal head on the horizontal mast to be placed over the traffic lane.
3. Conform to the wind load requirements specified by AASHTO, “Luminaries and Traffic Signals,” 4th edition, with all equipment mounted, without the need for additional ballast.
4. Allow for transporting two signal trailers with one vehicle.
5. Have adequate structural integrity to allow for lifting and placing the PTS trailer, as required.
6. Conform to the Michigan Vehicle Code.
7. Equipped with four stabilizing and leveling jacks, one on each corner of the trailer.
8. Delineated with a 4-inch by 18-inch strip, or an equivalent area, of reflectorized red and white conspicuity tape, installed on each of the four sides of the trailer. Locate these strips at each corner of the trailer.

**B. Traffic Signal Heads/Display Requirements.** The PTS system must meet the following requirements:

1. Conform to the physical display and operational requirements of conventional traffic signals, as specified in Part IV of the [MMUTCD](#), ITE Specifications for LED Circular Signals, and NEMA Standards TS1 and TS2;
2. Be equipped with two overhead, 12-inch, LED traffic signal heads with visors that extend beyond the signal head at least 10 inches;
3. Be equipped with traffic signal heads that can accommodate back plates and that rotate horizontally 180 degrees; and

4. Provide traffic signal head clearance height of at least 16 feet, measured from the bottom of the green signal housing or signal back plate, whichever is lowest, to the road surface.

**C. Power Requirements.** Each PTS trailer must be equipped with batteries capable of operating the traffic signal system for at least 21 days at 72 °F without charging. Provide a charging system that includes at least 450 watts of solar collection capability and an onboard battery charger for use with a 110 Volt power source, and an onboard monitoring system, capable of regulating and providing a visual display of the battery voltage and solar input.

The PTS system must be fully operable if connected to a 110 Volt power source, if required.

**D. PTS Operational Requirements.** PTS must have an operating system that includes a conflict monitoring system that conforms to NEMA standards, capable of operating in a fixed time, traffic actuated, or manual control mode. The fixed time mode operation option must be capable of providing at least five automatic traffic signal timing changes in a 24-hour period. The traffic actuation mode option must allow minimum and maximum green time programming to extend the green times in predetermined programmable segments, as required.

In addition, the PTS operating system must meet the following requirements:

1. Control at least seven traffic phases and include programmable green times from 3 seconds to 250 seconds, and red times from 1 second to 250 seconds, in 1 second increments.
2. Can facilitate standby modes of red, red flash, and yellow flash.
3. Capable of interfacing with a remote monitoring system that will report signal location, battery voltage, and system default. Ensure the monitoring system is not limited to cellular phone coverage areas, and remains operational regardless of location and weather conditions.
4. Can accommodate a pre-emption system with optical activation that provides a priority green phase in the direction of equipped approaching emergency vehicles.
5. Allows for connect and control of the PTS by a standard NEMA-type controller.
6. Equipped with diagnostic capabilities in the event of a system failure and can identify the failure to expedite return to full operational mode.

7. Has an integrated mechanism, capable of recording system malfunctions, and providing a printout of this record that must be kept with the PTS, including the following:
- Date and time of system failure,
  - Service and maintenance performed,
  - A description of the equipment serviced and why the service was performed,
  - Repairs made to the unit, and
  - Past operational history of the unit.

**E. Actuation Requirements.** PTS system must have traffic actuation capabilities that include microwave motion sensors, video detection, and in-pavement loops. PTS system must be capable of operating with a motion and true-presence actuation system.

**F. Communication Requirements.** Equip the PTS system to communicate via hardwire connection or wireless radio link communication. If using the hardwire communication, do not obstruct vehicular and pedestrian traffic or intrude into the work area while deploying the communication cable. If using the radio link communication option, maintain clear line of sight between PTS trailers, and ensure the radio system conforms to Federal Communication Commission (FCC) requirements and applicable state and local requirements.

**G. Default Requirements.** Program the PTS system to revert to a red, red flash, or yellow flash mode upon system failure. Set the default setting to red flash or a preprogrammed operating mode to ensure safety in the work zone, unless otherwise required, or directed by the Engineer. Upon failure, ensure the PTS system can notify Contractor personnel via the remote monitoring system specified in subsection [922.10.D](#).

The Contractor is responsible for repairing the PTS system. Make repairs to return the PTS system to full operational condition as soon as possible. Identify an authorized service center for timely response to system failures.

### **922.11. Traffic Regulator Equipment.**

**A. Stop/Slow and Stop/Stop Sign Paddle.** Equip traffic regulators with a stop/slow or stop/stop paddle meeting design requirements of the [MMUTCD](#). Do not use red flags, except in case of emergencies.

**B. Traffic Regulator's High-Visibility Safety Apparel.** Provide fluorescent vests, shirts, or jackets, clearly visible at a distance of at least 1,000 feet, day and night. Provide orange, yellow, white, silver, strong

yellow green, or a fluorescent version of these colors, designed to be visible through the full range of body motions.

**C. Traffic Regulator Apparel.** Ensure traffic regulators wear head, eye, and foot protection as specified in the provisions of Construction Safety Standard Part 6 "Personal Protective Equipment," R408.40601 et seq, of the Michigan Administrative Code.

**D. Two-Way Radio System.** Provide a two-way radio system with power to send and receive signals over the length of the intended flagging operations. If a two-way radio system is required, place a backup system on standby, readily available to the flaggers.

### 922.12. Miscellaneous.

**A. Dust Palliative.** Calcium chloride dust palliative in solid or liquid form must conform to the requirements of ASTM D 98, except as modified by this subsection

Solid-form calcium chloride must have a minimum concentration of 77 percent  $\text{CaCl}_2$ , with 100 percent passing the  $\frac{3}{8}$ -inch sieve, and from 0 to 5 percent passing the No. 30 sieve.

Liquid-form calcium chloride must be a solution with a concentration of 33, 35, or 38 percent  $\text{CaCl}_2$ .

Provide two copies of a report, with each load, that includes the following information:

1. The volume in gallons or weight of solution delivered, or the weight of solids delivered;
2. The concentration of solids or solution delivered, expressed as the percent of  $\text{CaCl}_2$ ;
3. Equivalent tons of  $\text{CaCl}_2$  determined for the concentration shown on the delivery report in accordance with Table 922-1; and
4. Copy of manufacturer's certification that the calcium chloride conforms to this section.

| <b>Concentration, %</b> | <b>Pounds of Calcium Chloride</b> |  |
|-------------------------|-----------------------------------|--|
|                         | <b>Per Gallon of Solution</b>     | <b>Per Pound of Solution or Solids</b> |
| 33                      | 3.7                               | 0.33                                   |
| 35                      | 3.9                               | 0.35                                   |
| 38                      | 4.4                               | 0.38                                   |
| 77                      | N/A                               | 0.77                                   |

If the manufacturer's certification indicates a solution does not conform to the concentration stated on the report, the Engineer will use the value from Table [922-1](#) for the next lower concentration to which the solution conforms to calculate the equivalent weight of calcium chloride.

If the manufacturer's certification indicates a solution has a concentration less than required for a 33 percent concentration, or a quantity of solids has a concentration less than required for 77 percent concentration, the Engineer will calculate the weight of equivalent calcium chloride using the required concentration.

If manufacturer's certification indicates a concentration of calcium chloride greater than stated on the delivery report, the Engineer will calculate the weight of equivalent calcium chloride using the concentration indicated on the report.

## Section 923. WATER MAIN MATERIALS

**923.01. General.** Materials for water main work must meet the requirements of this section, ANSI/AWWA Specifications, and the requirements of the water main owner (Municipality).

**923.02. Pipe.** The Department considers lines 2 inches or less in diameter to be water services not water mains. Water service pipe must be Type K copper unless otherwise specified by the Municipality, except that the minimum water service size is 1 inch.

Water main pipe must be ductile iron pipe manufactured in accordance with ANSI/AWWA C150/A21.50 and C151/A21.51.

Water main pipe must be lined with a standard thickness cement mortar lining sealed with a bituminous seal coat in accordance with ANSI/AWWA C104/A21.4, unless otherwise required. The outside of the pipe must be coated with the standard bituminous seal and each length of pipe must be marked with the following information:

- A. Metal thickness class,
- B. Net weight of the pipe without lining,
- C. The nominal size, and
- D. The manufacturer's identifying symbol.

Provide "push on" joints. Provide gaskets meeting the requirements of ANSI/AWWA C111/A21.11. If shown on the plans, provide nitrile gaskets. Provide, for each joint, two serrated silicon bronze electrical continuity wedges or an external conductor connection meeting the standards of the Municipality.

If shown on the plans, provide ductile iron pipe and fittings with the standard joint restraint system required by the Municipality.

Fittings, plugs, and gaskets for ductile iron pipe must meet the requirements of AWWA/ANSI C110/A21.10, ANSI/AWWA C111/A21.11 and ANSI/AWWA C153/A21.53. Cement mortar linings for fittings must meet the requirements of ANSI/AWWA C104/A21.4.

**923.03. Gate Valves.** Provide resilient wedge valves with a nominal diameter from 6 inches to 12 inches, rated for at least 200 psi, for use in water distribution systems. Valves must meet the requirements of AWWA C509.

Provide valves with the end types shown on the plans, or conforming to the conditions encountered on the project, as necessary to complete installation. Provide manually operated valves with non-rising stems and

provide a standard AWWA square operating nut of the Municipality standard size.

**923.04. Valve Boxes and Curb Boxes.** Valve boxes and curb boxes must be made of cast iron, conforming to the requirements of ASTM A 48 for Class 30B and AASHTO M 306. Each box must be a screw type and consist of five sections: base, center, extension, top, and cover. The cover must be marked "Water". Ensure boxes also meet supplemental requirements or specifications of the Municipality.

**923.05. Tapping Valves.** Tapping valves include a gate valve meeting the requirements of AWWA C509 and a tapping sleeve allowing a wet tap. Size the valve body and seat opening to accommodate the tapping machine cutters. Provide the tapping valve with the end types conforming to the conditions encountered on the project, as necessary to complete installation. The tapping sleeve must be compatible with the existing pipe material.

**923.06. Corporation Stops and Curb Stops.** Corporation stops and curb stops must meet the requirements of AWWA C800. Provide stops of all-brass construction with the end types conforming to the conditions encountered on the project, as necessary to complete installation. Ensure stops open counterclockwise. Ensure stops also meet supplemental requirements or specifications of the Municipality.

**923.07. Service Saddles.** Provide solid stainless steel service saddles with a single bolt band, as specified by the Municipality.

**923.08. Fire Hydrants.** Provide Municipality-standard fire hydrants.

**923.09. Polyethylene Encasement.** Polyethylene encasement must be manufactured using 8 mil thick virgin polyethylene in accordance with ASTM D 1248.

Provide the tube size recommended by the manufacturer to protect the pipe and fitting sizes.

Provide adhesive tape for the polyethylene tube as recommended by the manufacturer. Tape for repairing damage to the polyethylene must have a life expectancy equal to the life expectancy of the polyethylene.

## PAY ITEM INDEX

| ITEM DESCRIPTION  | PAGE       | SEC        |
|---|------------|------------|
| <b>A</b>  |            |            |
| Adhesive Anchoring of Horizontal Bar, ___ inch .....                      | <u>482</u> | <u>712</u> |
| Adhesive Anchoring of Vertical Bar, ___ inch.....                         | <u>482</u> | <u>712</u> |
| Aggregate Base .....  | <u>163</u> | <u>302</u> |
| Aggregate Base, ___ inch.....   | <u>163</u> | <u>302</u> |
| Aggregate Base, Conditioning .....  | <u>163</u> | <u>302</u> |
| Aggregate Base, LM .....  | <u>163</u> | <u>302</u> |
| Aggregate Surface Cse.....  | <u>174</u> | <u>306</u> |
| Aggregate Surface Cse, ___ inch .....                                     | <u>174</u> | <u>306</u> |
| Aggregate, 6A .....   | <u>147</u> | <u>206</u> |
| Aggregate, Filler.....  | <u>169</u> | <u>304</u> |
| Anchor Guy .....  | <u>696</u> | <u>820</u> |
| Approach, CI ___ .....  | <u>178</u> | <u>307</u> |
| Approach, CI ___, ___ inch.....   | <u>178</u> | <u>307</u> |
| Approach, CI ___, CIP .....   | <u>178</u> | <u>307</u> |
| Approach, CI ___, LM .....  | <u>178</u> | <u>307</u> |
| <b>B</b>  |            |            |
| Backfill, Structure, CIP .....  | <u>147</u> | <u>206</u> |
| Backfill, Structure, LM .....   | <u>147</u> | <u>206</u> |
| Backfill, Swamp.....  | <u>140</u> | <u>205</u> |
| Band, Sign.....   | <u>583</u> | <u>810</u> |
| Barbed Wire .....   | <u>566</u> | <u>808</u> |
| Barricade, Type III, High Intensity, Double Sided, Furn.....              | <u>622</u> | <u>812</u> |
| Barricade, Type III, High Intensity, Double Sided,<br>Lighted, Furn ..... | <u>622</u> | <u>812</u> |
| Barricade, Type III, High Intensity, Double Sided,<br>Lighted, Oper ..... | <u>622</u> | <u>812</u> |
| Barricade, Type III, High Intensity, Double Sided, Oper.....              | <u>622</u> | <u>812</u> |
| Barricade, Type III, High Intensity, Furn .....                           | <u>622</u> | <u>812</u> |
| Barricade, Type III, High Intensity, Lighted, Furn .....                  | <u>622</u> | <u>812</u> |
| Barricade, Type III, High Intensity, Lighted, Oper.....                   | <u>622</u> | <u>812</u> |
| Barricade, Type III, High Intensity, Oper.....                            | <u>622</u> | <u>812</u> |
| Basement Cleanout.....  | <u>123</u> | <u>204</u> |
| Beam Plate, Seal Perimeter.....   | <u>496</u> | <u>713</u> |
| Bearing, Elastomeric, ___ inch .....                                      | <u>434</u> | <u>707</u> |
| Bolt, Adhesive Anchored, ___ inch .....                                   | <u>482</u> | <u>712</u> |
| Bolt, Mechanical Expansion Anchored, ___ inch.....                        | <u>482</u> | <u>712</u> |



INDEX

| <b>ITEM DESCRIPTION</b>                            | <b>PAGE</b> | <b>SEC</b> |
|--|-------------|------------|
| (Botanical Name) .....                             | <u>646</u>  | <u>815</u> |
| Bracket, Truss, Rem .....                          | <u>697</u>  | <u>820</u> |
| Bracket, Truss, with ___ foot Arm.....             | <u>697</u>  | <u>820</u> |
| Bridge Barrier Railing, Type ___.....              | <u>460</u>  | <u>711</u> |
| Bridge Deck Surface Construction.....              | <u>482</u>  | <u>712</u> |
| Bridge Joint, Revise Compression Seal.....         | <u>482</u>  | <u>712</u> |
| Bridge Joint, Revise Expansion Device .....        | <u>482</u>  | <u>712</u> |
| Bridge Joints, Clean and Seal (Structure No.)..... | <u>482</u>  | <u>712</u> |
| Bridge Ltg, Furn and Rem (Structure No.).....      | <u>410</u>  | <u>706</u> |
| Bridge Ltg, Oper and Maintain .....                | <u>410</u>  | <u>706</u> |
| Bridge Railing, ___ Tube .....                     | <u>460</u>  | <u>711</u> |
| Bridge Railing, Aesthetic Parapet Tube.....        | <u>460</u>  | <u>711</u> |
| Bridge Railing, Thrie Beam Retrofit .....          | <u>460</u>  | <u>711</u> |
| Bridge Sign Connection, Bolt Replacement.....      | <u>583</u>  | <u>810</u> |
| Bridge Sign Connection, Conc, Type ___.....        | <u>583</u>  | <u>810</u> |
| Bridge Sign Connection, Steel, Type ___.....       | <u>583</u>  | <u>810</u> |
| Bridge Sign Connection, Type ___, Rem .....        | <u>584</u>  | <u>810</u> |
| Bushing .....                                      | <u>434</u>  | <u>707</u> |

**C**

|   |            |            |
|---|------------|------------|
| Cabinet, Rem .....  | <u>697</u> | <u>820</u> |
| Cabinet, Salv.....  | <u>697</u> | <u>820</u> |
| Cable Pole, (type), Disman .....  | <u>679</u> | <u>819</u> |
| Cable, (type), Rem .....  | <u>679</u> | <u>819</u> |
| Cable, Equipment Grounding Wire, 1/C# (size).....                               | <u>679</u> | <u>819</u> |
| Cable, P.J., 600 Volt, 1, (size) .....  | <u>679</u> | <u>819</u> |
| Cable, Rem .....  | <u>679</u> | <u>819</u> |
| Cable, Sec, (type), (number), (size).....                                       | <u>679</u> | <u>819</u> |
| Cable, Sec, (volt), (number), (size).....                                       | <u>679</u> | <u>819</u> |
| Cable, Shielded, (volt), (number), (size), (type).....                          | <u>679</u> | <u>819</u> |
| Cable, St Ltg, (volt), (number), (size), (type) .....                           | <u>679</u> | <u>819</u> |
| Call Back, Intermediate Transportation.....                                     | <u>598</u> | <u>811</u> |
| Call Back, Mobilization.....  | <u>598</u> | <u>811</u> |
| Cantilever, Rem .....   | <u>584</u> | <u>810</u> |
| Cantilever, Type ___.....   | <u>583</u> | <u>810</u> |
| Cantilever, Type ___, Erect, Salv .....   | <u>584</u> | <u>810</u> |
| Case Sign (LED), (number) Way, ___ inch x ___ inch.....                         | <u>696</u> | <u>820</u> |
| Case Sign (LED), (number) Way, ___ inch x ___ inch,<br>Retrofit Assembly .....  | <u>696</u> | <u>820</u> |
| Case Sign (LED), Changeable Message, (number) Way,<br>___ inch x ___ inch ..... | <u>696</u> | <u>820</u> |
| Case Sign Panel .....   | <u>696</u> | <u>820</u> |

| ITEM DESCRIPTION   | PAGE                | SEC                 |
|--|---------------------|---------------------|
| Case Sign Panel, Rem.....  | <a href="#">696</a> | <a href="#">820</a> |
| Case Sign Panel, Salv .....  | <a href="#">696</a> | <a href="#">820</a> |
| Case Sign, (number) Way, __ inch x __ inch .....                     | <a href="#">696</a> | <a href="#">820</a> |
| Case Sign, (number) Way, __ inch x __ inch,<br>Non-Illuminated ..... | <a href="#">696</a> | <a href="#">820</a> |
| Case Sign, (number) Way, __ inch x __ inch, Salv .....               | <a href="#">696</a> | <a href="#">820</a> |
| Case Sign, Disappearing Legend, __ inch x __ inch.....               | <a href="#">696</a> | <a href="#">820</a> |
| Case Sign, Disappearing Legend, __ inch x __ inch, Salv....          | <a href="#">696</a> | <a href="#">820</a> |
| Case Sign, Non-Illuminated, Rem.....                                 | <a href="#">696</a> | <a href="#">820</a> |
| Case Sign, Non-Illuminated, Salv .....                               | <a href="#">696</a> | <a href="#">820</a> |
| Case Sign, Rem .....   | <a href="#">696</a> | <a href="#">820</a> |
| Cement.....  | <a href="#">339</a> | <a href="#">603</a> |
| Channelizing Device, 42 inch, Furn .....                             | <a href="#">622</a> | <a href="#">812</a> |
| Channelizing Device, 42 inch, Oper.....                              | <a href="#">622</a> | <a href="#">812</a> |
| Clearing.....  | <a href="#">113</a> | <a href="#">201</a> |
| Clearing, Fence.....   | <a href="#">113</a> | <a href="#">201</a> |
| Cofferdams (Structure No.).....                                      | <a href="#">363</a> | <a href="#">704</a> |
| Cofferdams, Left in Place (Structure No.).....                       | <a href="#">363</a> | <a href="#">704</a> |
| Cold Milling HMA Surface .....                                       | <a href="#">247</a> | <a href="#">501</a> |
| Column, Breakaway, W8 x (wt/ft) .....                                | <a href="#">583</a> | <a href="#">810</a> |
| Compost Surface, Furn, __ inch .....                                 | <a href="#">657</a> | <a href="#">816</a> |
| Compost Surface, Furn, LM.....                                       | <a href="#">657</a> | <a href="#">816</a> |
| Conc Barrier Backfill, CIP .....                                     | <a href="#">548</a> | <a href="#">804</a> |
| Conc Barrier Ending, Temp, Detail __, Adj.....                       | <a href="#">623</a> | <a href="#">812</a> |
| Conc Barrier Ending, Temp, Detail __, Furn.....                      | <a href="#">623</a> | <a href="#">812</a> |
| Conc Barrier Ending, Temp, Detail __, Oper .....                     | <a href="#">623</a> | <a href="#">812</a> |
| Conc Barrier Ending, Temp, Detail __, Relocated.....                 | <a href="#">623</a> | <a href="#">812</a> |
| Conc Barrier Reflector Replacement .....                             | <a href="#">623</a> | <a href="#">812</a> |
| Conc Barrier, Double Face, Type __ .....                             | <a href="#">548</a> | <a href="#">804</a> |
| Conc Barrier, Single Face, Type __.....                              | <a href="#">548</a> | <a href="#">804</a> |
| Conc Barrier, Split, Type __.....                                    | <a href="#">548</a> | <a href="#">804</a> |
| Conc Barrier, Temp, Adj .....  | <a href="#">623</a> | <a href="#">812</a> |
| Conc Barrier, Temp, Furn .....                                       | <a href="#">623</a> | <a href="#">812</a> |
| Conc Barrier, Temp, Oper.....  | <a href="#">623</a> | <a href="#">812</a> |
| Conc Barrier, Temp, Relocated .....                                  | <a href="#">623</a> | <a href="#">812</a> |
| Conc Base Cse, Nonreinf, __ inch.....                                | <a href="#">318</a> | <a href="#">602</a> |
| Conc Base Cse, Reinf, __ inch .....                                  | <a href="#">318</a> | <a href="#">602</a> |
| Conc Pavt with Integral Curb, Nonreinf, __ inch.....                 | <a href="#">318</a> | <a href="#">602</a> |
| Conc Pavt with Integral Curb, Reinf, __ inch .....                   | <a href="#">318</a> | <a href="#">602</a> |
| Conc Pavt, Misc, Nonreinf, __ inch.....                              | <a href="#">318</a> | <a href="#">602</a> |
| Conc Pavt, Misc, Reinf, __ inch .....                                | <a href="#">318</a> | <a href="#">602</a> |
| Conc Pavt, Nonreinf, __ inch .....                                   | <a href="#">318</a> | <a href="#">602</a> |

# INDEX

| <b>ITEM DESCRIPTION</b>                             | <b>PAGE</b>         | <b>SEC</b>          |
|---|---------------------|---------------------|
| Conc Pavt, Nonreinf, __ inch, Temp .....            | <a href="#">318</a> | <a href="#">602</a> |
| Conc Pavt, Ovly, Finishing and Curing .....         | <a href="#">318</a> | <a href="#">602</a> |
| Conc Pavt, Ovly, Furnishing and Placing .....       | <a href="#">318</a> | <a href="#">602</a> |
| Conc Pavt, Ovly, Misc, Finishing and Curing.....    | <a href="#">318</a> | <a href="#">602</a> |
| Conc Pavt, Ovly, Misc, Furnishing and Placing ..... | <a href="#">318</a> | <a href="#">602</a> |
| Conc Pavt, Reinf, __ inch .....                     | <a href="#">318</a> | <a href="#">602</a> |
| Conc Pavt, Reinf, __ inch, Temp .....               | <a href="#">318</a> | <a href="#">602</a> |
| Conc Pole, Rem .....                                | <a href="#">695</a> | <a href="#">820</a> |
| Conc, Bridge Deck Ovly .....                        | <a href="#">482</a> | <a href="#">712</a> |
| Conc, Grade __ .....                                | <a href="#">318</a> | <a href="#">602</a> |
| Conc, Grade __ .....                                | <a href="#">409</a> | <a href="#">706</a> |
| Conc, Grade S2, Subfooting .....                    | <a href="#">409</a> | <a href="#">706</a> |
| Conc, Low Temperature Protection .....              | <a href="#">410</a> | <a href="#">706</a> |
| Conc, Silica Fume Modified .....                    | <a href="#">482</a> | <a href="#">712</a> |
| Concrete Barrier, Rem .....                         | <a href="#">123</a> | <a href="#">204</a> |
| Concrete Pole, Fit Up, (type) .....                 | <a href="#">679</a> | <a href="#">819</a> |
| Conduit Repr, Under Pavt .....                      | <a href="#">696</a> | <a href="#">820</a> |
| Conduit Repr, Under Sidewalk or Earth.....          | <a href="#">696</a> | <a href="#">820</a> |
| Conduit, (type), __ inch .....                      | <a href="#">678</a> | <a href="#">819</a> |
| Conduit, (type), __ inch, Structure .....           | <a href="#">678</a> | <a href="#">819</a> |
| Conduit, __ inch .....                              | <a href="#">410</a> | <a href="#">706</a> |
| Conduit, __ inch, Placed .....                      | <a href="#">410</a> | <a href="#">706</a> |
| Conduit, DB, (number), __ inch .....                | <a href="#">678</a> | <a href="#">819</a> |
| Conduit, Directional Bore, (number), __ inch.....   | <a href="#">678</a> | <a href="#">819</a> |
| Conduit, Encased, (number), __ inch .....           | <a href="#">678</a> | <a href="#">819</a> |
| Conduit, Jacked Bored, (number), __ Inch .....      | <a href="#">678</a> | <a href="#">819</a> |
| Conduit, Rem .....                                  | <a href="#">678</a> | <a href="#">819</a> |
| Conduit, Schedule (number), __ inch .....           | <a href="#">678</a> | <a href="#">819</a> |
| Contractor Staking .....                            | <a href="#">732</a> | <a href="#">824</a> |
| Contractor Staking, Road Only .....                 | <a href="#">732</a> | <a href="#">824</a> |
| Controller and Cabinet, Rem .....                   | <a href="#">696</a> | <a href="#">820</a> |
| Controller and Cabinet, Salv .....                  | <a href="#">696</a> | <a href="#">820</a> |
| Controller Fdn, Base Mount .....                    | <a href="#">697</a> | <a href="#">820</a> |
| Controller Fdn, Rem .....                           | <a href="#">697</a> | <a href="#">820</a> |
| Corduoy, Rem .....                                  | <a href="#">115</a> | <a href="#">202</a> |
| Crack Sealing, Conc Pavt .....                      | <a href="#">339</a> | <a href="#">603</a> |
| Culv Bedding, Box Culv .....                        | <a href="#">226</a> | <a href="#">406</a> |
| Culv End Sect, (material), __ inch .....            | <a href="#">190</a> | <a href="#">401</a> |
| Culv End Sect, __ inch.....                         | <a href="#">190</a> | <a href="#">401</a> |
| Culv End Sect, Footing .....                        | <a href="#">190</a> | <a href="#">401</a> |
| Culv End Sect, Grate .....                          | <a href="#">190</a> | <a href="#">401</a> |
| Culv End Sect, Salv, 30 inch or less .....          | <a href="#">190</a> | <a href="#">401</a> |

| ITEM DESCRIPTION   | PAGE                | SEC                 |
|--|---------------------|---------------------|
| Culv End Sect, Salv, over 30 inch.....   | <a href="#">190</a> | <a href="#">401</a> |
| Culv, CI __, (material), __ inch.....  | <a href="#">189</a> | <a href="#">401</a> |
| Culv, CI __, __ inch.....  | <a href="#">189</a> | <a href="#">401</a> |
| Culv, CI __, __ inch, Jacked in Place.....   | <a href="#">190</a> | <a href="#">401</a> |
| Culv, CSP Arch, CI __, (span) inch x (rise) inch.....                              | <a href="#">189</a> | <a href="#">401</a> |
| Culv, Downspout, __ inch.....  | <a href="#">189</a> | <a href="#">401</a> |
| Culv, End, Rem, 24 inch to 48 inch.....  | <a href="#">118</a> | <a href="#">203</a> |
| Culv, End, Rem, Less than 24 inch.....   | <a href="#">118</a> | <a href="#">203</a> |
| Culv, End, Rem, Over 48 inch.....  | <a href="#">118</a> | <a href="#">203</a> |
| Culv, Other than Pipe, Rem.....  | <a href="#">123</a> | <a href="#">204</a> |
| Culv, Precast Conc Box, (span) foot x (rise) foot.....                             | <a href="#">226</a> | <a href="#">406</a> |
| Culv, Precast Three-Sided or Arch, (span) foot x<br>(rise) foot.....               | <a href="#">226</a> | <a href="#">406</a> |
| Culv, Reinf Conc Ellip, CI __, (rise) inch x (span) inch.....                      | <a href="#">189</a> | <a href="#">401</a> |
| Culv, Rem, 24 inch to 48 inch.....   | <a href="#">118</a> | <a href="#">203</a> |
| Culv, Rem, Less than 24 inch.....  | <a href="#">118</a> | <a href="#">203</a> |
| Culv, Rem, Over 48 inch.....   | <a href="#">118</a> | <a href="#">203</a> |
| Culv, Slp End Sect, (slope), __ inch, Longit.....                                  | <a href="#">189</a> | <a href="#">401</a> |
| Culv, Slp End Sect, (slope), __ inch, Transv.....                                  | <a href="#">189</a> | <a href="#">401</a> |
| Culv, Slp End Sect, Arch Pipe, (slope), (span) inch x<br>(rise) inch, Longit.....  | <a href="#">189</a> | <a href="#">401</a> |
| Culv, Slp End Sect, Arch Pipe, (slope), (span) inch x<br>(rise) inch, Transv.....  | <a href="#">189</a> | <a href="#">401</a> |
| Culv, Slp End Sect, Ellip Pipe, (slope), (rise) inch x<br>(span) inch, Longit..... | <a href="#">189</a> | <a href="#">401</a> |
| Culv, Slp End Sect, Ellip Pipe, (slope), (rise) inch x<br>(span) inch, Transv..... | <a href="#">190</a> | <a href="#">401</a> |
| Culv, Temp.....  | <a href="#">623</a> | <a href="#">812</a> |
| Curb and Gutter, Bridge Approach.....  | <a href="#">540</a> | <a href="#">802</a> |
| Curb and Gutter, Conc, Det __.....   | <a href="#">540</a> | <a href="#">802</a> |
| Curb and Gutter, Rem.....  | <a href="#">123</a> | <a href="#">204</a> |
| Curb Nose.....   | <a href="#">540</a> | <a href="#">802</a> |
| Curb Sloped, HMA.....  | <a href="#">550</a> | <a href="#">805</a> |
| Curb Vertical, HMA.....  | <a href="#">551</a> | <a href="#">805</a> |
| Curb, Conc, Det __.....  | <a href="#">540</a> | <a href="#">802</a> |
| Curb, Rem.....   | <a href="#">123</a> | <a href="#">204</a> |
| Cutting Beam Ends, Simple Span.....  | <a href="#">496</a> | <a href="#">713</a> |

## D

|   |                     |                     |
|---|---------------------|---------------------|
| DB Cable, 600 Volt, 1/C# (size).....                      | <a href="#">678</a> | <a href="#">819</a> |
| DB Cable, in Conduit, 600 Volt, (number) 1/C# (size)..... | <a href="#">678</a> | <a href="#">819</a> |
| DB Cable, in Conduit, 600 Volt, 1/C# (size).....          | <a href="#">679</a> | <a href="#">819</a> |

# INDEX

| <b>ITEM DESCRIPTION</b>   | <b>PAGE</b>         | <b>SEC</b>          |
|---|---------------------|---------------------|
| DB Cable, in Conduit, Rem.....                                  | <a href="#">679</a> | <a href="#">819</a> |
| Deck Drain, Adj.....  | <a href="#">521</a> | <a href="#">717</a> |
| Deck Drain, Extension.....                                      | <a href="#">521</a> | <a href="#">717</a> |
| Deck Joint, Rem.....  | <a href="#">482</a> | <a href="#">712</a> |
| Delineator Reflector.....                                       | <a href="#">583</a> | <a href="#">810</a> |
| Delineator, Reflective Sheeting, __ inch x __ inch, (color).... | <a href="#">583</a> | <a href="#">810</a> |
| Detectable Warning Surface.....                                 | <a href="#">544</a> | <a href="#">803</a> |
| Dewatering System, Trench.....                                  | <a href="#">200</a> | <a href="#">402</a> |
| Diamond Grinding Conc Pavt.....                                 | <a href="#">339</a> | <a href="#">603</a> |
| Digital Loop Detector.....                                      | <a href="#">696</a> | <a href="#">820</a> |
| Digital Loop Detector, Salv.....                                | <a href="#">696</a> | <a href="#">820</a> |
| Ditch Cleanout.....   | <a href="#">140</a> | <a href="#">205</a> |
| Ditch, Grouted Cobble.....                                      | <a href="#">639</a> | <a href="#">814</a> |
| Ditch, Intercepting.....  | <a href="#">154</a> | <a href="#">208</a> |
| Ditch, Plain Cobble.....  | <a href="#">639</a> | <a href="#">814</a> |
| Divider, Nonreinf Conc, Type __.....                            | <a href="#">540</a> | <a href="#">802</a> |
| Divider, Reinf Conc, Type I.....                                | <a href="#">540</a> | <a href="#">802</a> |
| Downspout Header, Conc.....                                     | <a href="#">540</a> | <a href="#">802</a> |
| Downspout Replacement.....                                      | <a href="#">521</a> | <a href="#">717</a> |
| Dr Marker Post.....   | <a href="#">190</a> | <a href="#">401</a> |
| Dr Structure Cover, Adj, Case __.....                           | <a href="#">207</a> | <a href="#">403</a> |
| Dr Structure Cover, Type __.....                                | <a href="#">207</a> | <a href="#">403</a> |
| Dr Structure Lead, Cleaning, __ inch.....                       | <a href="#">207</a> | <a href="#">403</a> |
| Dr Structure, __ inch dia.....                                  | <a href="#">206</a> | <a href="#">403</a> |
| Dr Structure, Abandon.....                                      | <a href="#">118</a> | <a href="#">203</a> |
| Dr Structure, Add Depth of __ inch dia, 8 foot to 15 foot.....  | <a href="#">206</a> | <a href="#">403</a> |
| Dr Structure, Add Depth of __ inch dia, more than 15 foot....   | <a href="#">207</a> | <a href="#">403</a> |
| Dr Structure, Adj, Add Depth.....                               | <a href="#">207</a> | <a href="#">403</a> |
| Dr Structure, Cleaning.....                                     | <a href="#">207</a> | <a href="#">403</a> |
| Dr Structure, Rem.....  | <a href="#">118</a> | <a href="#">203</a> |
| Dr Structure, Tap, __ inch.....                                 | <a href="#">207</a> | <a href="#">403</a> |
| Dr Structure, Temp Lowering.....                                | <a href="#">207</a> | <a href="#">403</a> |
| Drain Casting Assembly.....                                     | <a href="#">521</a> | <a href="#">717</a> |
| Drain Casting, Type __.....                                     | <a href="#">521</a> | <a href="#">717</a> |
| Drilled Shaft Equipment, Furnished (Structure No.).....         | <a href="#">533</a> | <a href="#">718</a> |
| Drilled Shaft, __ inch.....                                     | <a href="#">533</a> | <a href="#">718</a> |
| Driveway Opening, Conc, Det M.....                              | <a href="#">540</a> | <a href="#">802</a> |
| Driveway, Nonreinf Conc, __ inch.....                           | <a href="#">537</a> | <a href="#">801</a> |
| Driveway, Reinf Conc, __ inch.....                              | <a href="#">537</a> | <a href="#">801</a> |
| Drop Inlet, Type.....   | <a href="#">207</a> | <a href="#">403</a> |
| Dune Grass Planting.....  | <a href="#">662</a> | <a href="#">818</a> |
| Dust Palliative, Applied.....                                   | <a href="#">623</a> | <a href="#">812</a> |

| ITEM DESCRIPTION  | PAGE                | SEC                 |
|---|---------------------|---------------------|
| <b>E</b>  |                     |                     |
| Edge Trimming.....  | <a href="#">247</a> | <a href="#">501</a> |
| Elec Grounding System .....                                   | <a href="#">410</a> | <a href="#">706</a> |
| Elec Serv, Rem .....  | <a href="#">679</a> | <a href="#">819</a> |
| Embankment, CIP .....   | <a href="#">140</a> | <a href="#">205</a> |
| Embankment, LM.....   | <a href="#">140</a> | <a href="#">205</a> |
| Embankment, Structure, CIP .....                              | <a href="#">140</a> | <a href="#">205</a> |
| Embedded Galvanic Anode .....                                 | <a href="#">482</a> | <a href="#">712</a> |
| Emergency Pre-emption, Rem.....                               | <a href="#">697</a> | <a href="#">820</a> |
| Emergency Pre-emption, Salv .....                             | <a href="#">697</a> | <a href="#">820</a> |
| End Diaphragm, Rem and Replace .....                          | <a href="#">512</a> | <a href="#">715</a> |
| End Header Replacement.....                                   | <a href="#">482</a> | <a href="#">712</a> |
| Erosion Control, Aggregate Cover .....                        | <a href="#">154</a> | <a href="#">208</a> |
| Erosion Control, Check Dam, Stone .....                       | <a href="#">154</a> | <a href="#">208</a> |
| Erosion Control, Filter Bag.....                              | <a href="#">154</a> | <a href="#">208</a> |
| Erosion Control, Gravel Access Approach .....                 | <a href="#">154</a> | <a href="#">208</a> |
| Erosion Control, Gravel Filter Berm .....                     | <a href="#">154</a> | <a href="#">208</a> |
| Erosion Control, Inlet Protection, Fabric Drop .....          | <a href="#">154</a> | <a href="#">208</a> |
| Erosion Control, Inlet Protection, Geotextile and Stone ..... | <a href="#">154</a> | <a href="#">208</a> |
| Erosion Control, Inlet Protection, Sediment Trap .....        | <a href="#">154</a> | <a href="#">208</a> |
| Erosion Control, Maintenance, Sediment Removal .....          | <a href="#">154</a> | <a href="#">208</a> |
| Erosion Control, Sand Bag .....                               | <a href="#">154</a> | <a href="#">208</a> |
| Erosion Control, Sand Fence.....                              | <a href="#">154</a> | <a href="#">208</a> |
| Erosion Control, Sediment Basin .....                         | <a href="#">154</a> | <a href="#">208</a> |
| Erosion Control, Sediment Trap.....                           | <a href="#">154</a> | <a href="#">208</a> |
| Erosion Control, Silt Fence .....                             | <a href="#">154</a> | <a href="#">208</a> |
| Erosion Control, Stone Bag .....                              | <a href="#">154</a> | <a href="#">208</a> |
| Erosion Control, Temp Plastic Sheet/Geotextile Cover .....    | <a href="#">154</a> | <a href="#">208</a> |
| Erosion Control, Turbidity Curtain, Deep .....                | <a href="#">154</a> | <a href="#">208</a> |
| Erosion Control, Turbidity Curtain, Shallow .....             | <a href="#">154</a> | <a href="#">208</a> |
| Excavation, Channel .....                                     | <a href="#">140</a> | <a href="#">205</a> |
| Excavation, Earth.....  | <a href="#">140</a> | <a href="#">205</a> |
| Excavation, Fdn .....   | <a href="#">147</a> | <a href="#">206</a> |
| Excavation, Peat .....  | <a href="#">140</a> | <a href="#">205</a> |
| Excavation, Rock .....  | <a href="#">140</a> | <a href="#">205</a> |
| Excavation, Rock Fdn .....                                    | <a href="#">147</a> | <a href="#">206</a> |
| Expansion Joint Device.....                                   | <a href="#">410</a> | <a href="#">706</a> |
| Expansion Joint Device, Cover Plate.....                      | <a href="#">410</a> | <a href="#">706</a> |
| <b>F</b>  |                     |                     |
| False Decking .....   | <a href="#">409</a> | <a href="#">706</a> |

INDEX

| <b>ITEM DESCRIPTION</b>   | <b>PAGE</b>                | <b>SEC</b>                 |
|---|----------------------------|----------------------------|
| Fdn, Breakaway, W8 x (wt/ft).....                                       | <a href="#"><u>583</u></a> | <a href="#"><u>810</u></a> |
| Fdn, Cantilever Sign Structure Type __, __ inch Dia,<br>Cased .....     | <a href="#"><u>583</u></a> | <a href="#"><u>810</u></a> |
| Fdn, Cantilever Sign Structure Type __, __ inch Dia,<br>Uncased.....    | <a href="#"><u>583</u></a> | <a href="#"><u>810</u></a> |
| Fdn, Cantilever, Rem .....  | <a href="#"><u>584</u></a> | <a href="#"><u>810</u></a> |
| Fdn, Cantilever, Type .....   | <a href="#"><u>583</u></a> | <a href="#"><u>810</u></a> |
| Fdn, Column Breakaway, Rem .....  | <a href="#"><u>584</u></a> | <a href="#"><u>810</u></a> |
| Fdn, Entire, Cantilever, Rem.....                                       | <a href="#"><u>584</u></a> | <a href="#"><u>810</u></a> |
| Fdn, Entire, Truss, Rem .....   | <a href="#"><u>584</u></a> | <a href="#"><u>810</u></a> |
| Fdn, Rem .....  | <a href="#"><u>695</u></a> | <a href="#"><u>820</u></a> |
| Fdn, Truss Sign Structure Type __, __ inch Dia, Cased .....             | <a href="#"><u>583</u></a> | <a href="#"><u>810</u></a> |
| Fdn, Truss Sign Structure Type __, __ inch Dia, Uncased....             | <a href="#"><u>583</u></a> | <a href="#"><u>810</u></a> |
| Fdn, Truss, Rem .....   | <a href="#"><u>584</u></a> | <a href="#"><u>810</u></a> |
| Fdn, Truss, Type .....  | <a href="#"><u>583</u></a> | <a href="#"><u>810</u></a> |
| Fdn, Wood Support, Rem .....  | <a href="#"><u>584</u></a> | <a href="#"><u>810</u></a> |
| Fence Gate, __ foot, for __ inch Chain Link Fence .....                 | <a href="#"><u>566</u></a> | <a href="#"><u>808</u></a> |
| Fence Gate, __ foot, for Woven Wire .....                               | <a href="#"><u>566</u></a> | <a href="#"><u>808</u></a> |
| Fence Material .....  | <a href="#"><u>566</u></a> | <a href="#"><u>808</u></a> |
| Fence Post .....  | <a href="#"><u>566</u></a> | <a href="#"><u>808</u></a> |
| Fence, Chain Link, __ inch .....  | <a href="#"><u>566</u></a> | <a href="#"><u>808</u></a> |
| Fence, Chain Link, __ inch, with (number) Strand of<br>Barbed Wire..... | <a href="#"><u>566</u></a> | <a href="#"><u>808</u></a> |
| Fence, High Tensile Wire.....   | <a href="#"><u>566</u></a> | <a href="#"><u>808</u></a> |
| Fence, Moving.....  | <a href="#"><u>566</u></a> | <a href="#"><u>808</u></a> |
| Fence, Protective .....   | <a href="#"><u>566</u></a> | <a href="#"><u>808</u></a> |
| Fence, Rem.....   | <a href="#"><u>123</u></a> | <a href="#"><u>204</u></a> |
| Fence, Structure.....   | <a href="#"><u>566</u></a> | <a href="#"><u>808</u></a> |
| Fence, Temp .....   | <a href="#"><u>566</u></a> | <a href="#"><u>808</u></a> |
| Fence, Woven Wire with Steel Post.....                                  | <a href="#"><u>566</u></a> | <a href="#"><u>808</u></a> |
| Fence, Woven Wire with Wood Post .....                                  | <a href="#"><u>566</u></a> | <a href="#"><u>808</u></a> |
| Fertilizer, Chemical Nutrient, Cl __ .....                              | <a href="#"><u>657</u></a> | <a href="#"><u>816</u></a> |
| Field Office, Cl .....  | <a href="#"><u>569</u></a> | <a href="#"><u>809</u></a> |
| Field Office, Utility Fees .....  | <a href="#"><u>569</u></a> | <a href="#"><u>809</u></a> |
| Field Repair of Damaged Coating (Structure No.).....                    | <a href="#"><u>519</u></a> | <a href="#"><u>716</u></a> |
| Filler Wall Conc .....  | <a href="#"><u>482</u></a> | <a href="#"><u>712</u></a> |
| Fire Hydrant .....  | <a href="#"><u>720</u></a> | <a href="#"><u>823</u></a> |
| Flushing Cracks, Water.....   | <a href="#"><u>482</u></a> | <a href="#"><u>712</u></a> |

**G**

|                                    |                            |                            |
|------------------------------------|----------------------------|----------------------------|
| Gate Box, Adj, Case __ .....       | <a href="#"><u>720</u></a> | <a href="#"><u>823</u></a> |
| Gate Box, Adj, Temp, Case __ ..... | <a href="#"><u>720</u></a> | <a href="#"><u>823</u></a> |

| ITEM DESCRIPTION  | PAGE                | SEC                 |
|---|---------------------|---------------------|
| Gate Box, Reconst, Case __ .....                                    | <a href="#">720</a> | <a href="#">823</a> |
| Gate Valve and Box, __ inch .....                                   | <a href="#">720</a> | <a href="#">823</a> |
| Gate Valve, __ inch.....  | <a href="#">720</a> | <a href="#">823</a> |
| Gate Well, __ inch dia.....   | <a href="#">720</a> | <a href="#">823</a> |
| Gate Well, Abandon.....   | <a href="#">720</a> | <a href="#">823</a> |
| Gate Well, Rem.....   | <a href="#">720</a> | <a href="#">823</a> |
| Geotextile, Separator .....   | <a href="#">180</a> | <a href="#">308</a> |
| Geotextile, Stabilization .....                                     | <a href="#">180</a> | <a href="#">308</a> |
| Glare Screen Connection, Conc .....                                 | <a href="#">583</a> | <a href="#">810</a> |
| Glare Screen Connection, Conc, Perforated Steel<br>Square Tube..... | <a href="#">583</a> | <a href="#">810</a> |
| Glare Screen, Conc.....   | <a href="#">548</a> | <a href="#">804</a> |
| Glare Screen, Conc, Split .....                                     | <a href="#">548</a> | <a href="#">804</a> |
| Glare Screen, Rem .....   | <a href="#">123</a> | <a href="#">204</a> |
| Granular Blanket, Type __ .....                                     | <a href="#">140</a> | <a href="#">205</a> |
| Granular Material, Cl __.....                                       | <a href="#">140</a> | <a href="#">205</a> |
| Guardrail Anch, Bridge, Det __ .....                                | <a href="#">560</a> | <a href="#">807</a> |
| Guardrail Anch, Bridge, Det __, Temp.....                           | <a href="#">560</a> | <a href="#">807</a> |
| Guardrail Anch, Median .....  | <a href="#">560</a> | <a href="#">807</a> |
| Guardrail Approach Terminal, Type __.....                           | <a href="#">560</a> | <a href="#">807</a> |
| Guardrail Approach Terminal, Type __, Temp .....                    | <a href="#">560</a> | <a href="#">807</a> |
| Guardrail Buffered End .....  | <a href="#">560</a> | <a href="#">807</a> |
| Guardrail Departing Terminal, Type __.....                          | <a href="#">560</a> | <a href="#">807</a> |
| Guardrail Departing Terminal, Type __, Temp .....                   | <a href="#">560</a> | <a href="#">807</a> |
| Guardrail Post, Culv .....  | <a href="#">559</a> | <a href="#">807</a> |
| Guardrail Reflector.....  | <a href="#">560</a> | <a href="#">807</a> |
| Guardrail, Backed, Det __.....                                      | <a href="#">559</a> | <a href="#">807</a> |
| Guardrail, Curved, Type __.....                                     | <a href="#">559</a> | <a href="#">807</a> |
| Guardrail, Mult, Salv.....  | <a href="#">560</a> | <a href="#">807</a> |
| Guardrail, Rem.....   | <a href="#">123</a> | <a href="#">204</a> |
| Guardrail, Salv .....   | <a href="#">560</a> | <a href="#">807</a> |
| Guardrail, Type __ .....  | <a href="#">559</a> | <a href="#">807</a> |
| Guardrail, Type __, Temp .....                                      | <a href="#">560</a> | <a href="#">807</a> |
| Gutter, Rem.....  | <a href="#">123</a> | <a href="#">204</a> |

## H

|   |                     |                     |
|---|---------------------|---------------------|
| Hand Chipping, Deep.....                | <a href="#">482</a> | <a href="#">712</a> |
| Hand Chipping, Other Than Deck.....     | <a href="#">482</a> | <a href="#">712</a> |
| Hand Chipping, Shallow.....             | <a href="#">482</a> | <a href="#">712</a> |
| Hand Patching.....                      | <a href="#">247</a> | <a href="#">501</a> |
| Hanger Assembly, Field Measurement..... | <a href="#">496</a> | <a href="#">713</a> |
| Hanger Assembly, Rem and Erect.....     | <a href="#">496</a> | <a href="#">713</a> |



INDEX

| <b>ITEM DESCRIPTION</b>                        | <b>PAGE</b>         | <b>SEC</b>          |
|--|---------------------|---------------------|
| Hardware, Misc. (Structure No.) .....          | <a href="#">449</a> | <a href="#">709</a> |
| Heat Straightening Steel (Structure No.) ..... | <a href="#">496</a> | <a href="#">713</a> |
| Hh, (type) .....                               | <a href="#">679</a> | <a href="#">819</a> |
| Hh, (type), (size).....                        | <a href="#">679</a> | <a href="#">819</a> |
| Hh, (work).....                                | <a href="#">679</a> | <a href="#">819</a> |
| High Intensity Light, Type B, Furn.....        | <a href="#">622</a> | <a href="#">812</a> |
| High Intensity Light, Type B, Oper .....       | <a href="#">622</a> | <a href="#">812</a> |
| HMA Approach.....                              | <a href="#">247</a> | <a href="#">501</a> |
| HMA Approach, High Stress .....                | <a href="#">247</a> | <a href="#">501</a> |
| HMA Base Crushing and Shaping .....            | <a href="#">171</a> | <a href="#">305</a> |
| HMA Crack Treatment, Ramp.....                 | <a href="#">253</a> | <a href="#">502</a> |
| HMA Crack Treatment, Roadbed.....              | <a href="#">253</a> | <a href="#">502</a> |
| HMA Patch, Rem .....                           | <a href="#">247</a> | <a href="#">501</a> |
| HMA Surface, Rem .....                         | <a href="#">247</a> | <a href="#">501</a> |
| HMA, (type), High Stress .....                 | <a href="#">247</a> | <a href="#">501</a> |
| HMA, 2 E ____ .....                            | <a href="#">247</a> | <a href="#">501</a> |
| HMA, 3 E ____ .....                            | <a href="#">247</a> | <a href="#">501</a> |
| HMA, 4 E ____ .....                            | <a href="#">247</a> | <a href="#">501</a> |
| HMA, 5 E ____ .....                            | <a href="#">247</a> | <a href="#">501</a> |
| HMA, LVSP .....                                | <a href="#">247</a> | <a href="#">501</a> |
| Hydrant, Relocate, Case ____ .....             | <a href="#">720</a> | <a href="#">823</a> |
| Hydrant, Rem .....                             | <a href="#">720</a> | <a href="#">823</a> |
| Hydrodemolition, First Pass .....              | <a href="#">482</a> | <a href="#">712</a> |
| Hydrodemolition, Second Pass.....              | <a href="#">482</a> | <a href="#">712</a> |
| <b>I</b>                                       |                     |                     |
| Installing MDOT Supplied Sign, Type ____ ..... | <a href="#">584</a> | <a href="#">810</a> |
| <b>J</b>                                       |                     |                     |
| Joint and Crack, Cleanout.....                 | <a href="#">247</a> | <a href="#">501</a> |
| Joint Waterproofing .....                      | <a href="#">456</a> | <a href="#">710</a> |
| Joint Waterproofing, Expansion .....           | <a href="#">456</a> | <a href="#">710</a> |
| Joint Waterproofing, Railroad .....            | <a href="#">456</a> | <a href="#">710</a> |
| Joint, Contraction, (type).....                | <a href="#">318</a> | <a href="#">602</a> |
| Joint, Contraction, Crg .....                  | <a href="#">339</a> | <a href="#">603</a> |
| Joint, Expansion, (type) .....                 | <a href="#">318</a> | <a href="#">602</a> |
| Joint, Expansion, Erg .....                    | <a href="#">339</a> | <a href="#">603</a> |
| Joint, Expansion, Esc.....                     | <a href="#">339</a> | <a href="#">603</a> |
| Joint, Plane-of-Weakness, (type).....          | <a href="#">318</a> | <a href="#">602</a> |
| Joint, Tied, Trg .....                         | <a href="#">339</a> | <a href="#">603</a> |

| ITEM DESCRIPTION   | PAGE                | SEC                 |
|--|---------------------|---------------------|
| <b>K</b>   |                     |                     |
| Keep Rt Sign, Rem .....                                  | <a href="#">696</a> | <a href="#">820</a> |
| <b>L</b>   |                     |                     |
| Lane Tie, Epoxy Anchored.....                            | <a href="#">339</a> | <a href="#">603</a> |
| Latex Conc Surface, Rem.....                             | <a href="#">482</a> | <a href="#">712</a> |
| Light Std Arm, (work) .....                              | <a href="#">679</a> | <a href="#">819</a> |
| Light Std Arm, __ foot .....                             | <a href="#">679</a> | <a href="#">819</a> |
| Light Std Fdn.....                                       | <a href="#">679</a> | <a href="#">819</a> |
| Light Std Fdn, Conc Barrier .....                        | <a href="#">548</a> | <a href="#">804</a> |
| Light Std Fdn, Rem .....                                 | <a href="#">679</a> | <a href="#">819</a> |
| Light Std Shaft, (work) .....                            | <a href="#">679</a> | <a href="#">819</a> |
| Light Std Shaft, __ foot to __ foot .....                | <a href="#">679</a> | <a href="#">819</a> |
| Light Std Shaft, __ foot to __ foot, Double Arm .....    | <a href="#">679</a> | <a href="#">819</a> |
| Light Std Shaft, __ foot to __ foot, Single Arm.....     | <a href="#">679</a> | <a href="#">819</a> |
| Light Std Shaft, 30 foot or less.....                    | <a href="#">679</a> | <a href="#">819</a> |
| Light Std Shaft, 30 foot or less, Double Arm.....        | <a href="#">679</a> | <a href="#">819</a> |
| Light Std Shaft, 30 foot or less, Single Arm .....       | <a href="#">679</a> | <a href="#">819</a> |
| Light Std Shaft, Square, __ foot.....                    | <a href="#">679</a> | <a href="#">819</a> |
| Light Std, Frangible Transformer Base.....               | <a href="#">679</a> | <a href="#">819</a> |
| Light Std, Frangible Transformer Base, Rem .....         | <a href="#">679</a> | <a href="#">819</a> |
| Lighted Arrow, Type __, Furn .....                       | <a href="#">622</a> | <a href="#">812</a> |
| Lighted Arrow, Type __, Oper.....                        | <a href="#">622</a> | <a href="#">812</a> |
| Lighted Arrow, Type C, Standby.....                      | <a href="#">622</a> | <a href="#">812</a> |
| Live Tap, __ inch x __ inch .....                        | <a href="#">720</a> | <a href="#">823</a> |
| Loop Detector, Rem .....                                 | <a href="#">696</a> | <a href="#">820</a> |
| Louver .....   | <a href="#">695</a> | <a href="#">820</a> |
| Ltg for Night Work .....                                 | <a href="#">623</a> | <a href="#">812</a> |
| Luminaire .....  | <a href="#">679</a> | <a href="#">819</a> |
| Luminaire, (watt) High Pressure Sodium .....             | <a href="#">679</a> | <a href="#">819</a> |
| Luminaire, (watt) High Pressure Sodium, Rectangular..... | <a href="#">679</a> | <a href="#">819</a> |
| Luminaire, (watt) High Pressure Sodium, Spec.....        | <a href="#">679</a> | <a href="#">819</a> |
| Luminaire, (work) .....                                  | <a href="#">679</a> | <a href="#">819</a> |
| <b>M</b>   |                     |                     |
| Machine Grading.....                                     | <a href="#">140</a> | <a href="#">205</a> |
| Maintenance Gravel.....                                  | <a href="#">174</a> | <a href="#">306</a> |
| Maintenance Gravel, LM.....                              | <a href="#">174</a> | <a href="#">306</a> |
| Masonry and Conc Structure, Rem.....                     | <a href="#">123</a> | <a href="#">204</a> |
| Masonry Plate, Grout .....                               | <a href="#">482</a> | <a href="#">712</a> |
| Material, Surplus and Unsuitable, Rem, LM .....          | <a href="#">171</a> | <a href="#">305</a> |

INDEX

| <b>ITEM DESCRIPTION</b>   | <b>PAGE</b>                | <b>SEC</b>                 |
|---|----------------------------|----------------------------|
| Median Barrier Connection, Conc.....                                  | <a href="#"><u>583</u></a> | <a href="#"><u>810</u></a> |
| Median Barrier Connection, Conc, Perforated Steel<br>Square Tube..... | <a href="#"><u>583</u></a> | <a href="#"><u>810</u></a> |
| Membrane, Preformed Waterproofing .....                               | <a href="#"><u>456</u></a> | <a href="#"><u>710</u></a> |
| Metered Serv.....   | <a href="#"><u>697</u></a> | <a href="#"><u>820</u></a> |
| Metered Serv, Rem.....  | <a href="#"><u>697</u></a> | <a href="#"><u>820</u></a> |
| Mh Base, __ inch, Type __ .....                                       | <a href="#"><u>207</u></a> | <a href="#"><u>403</u></a> |
| Mh Riser.....   | <a href="#"><u>207</u></a> | <a href="#"><u>403</u></a> |
| Mh, Precast Tee, CI __, __ inch.....                                  | <a href="#"><u>207</u></a> | <a href="#"><u>403</u></a> |
| Micro-Surface, Rutfilling.....  | <a href="#"><u>269</u></a> | <a href="#"><u>504</u></a> |
| Micro-Surface, Single Cse .....                                       | <a href="#"><u>269</u></a> | <a href="#"><u>504</u></a> |
| Micro-Surface, Std .....  | <a href="#"><u>269</u></a> | <a href="#"><u>504</u></a> |
| Minor Traf Devices.....   | <a href="#"><u>622</u></a> | <a href="#"><u>812</u></a> |
| Mobilization, Max __ .....  | <a href="#"><u>107</u></a> | <a href="#"><u>150</u></a> |
| Monument Box.....   | <a href="#"><u>709</u></a> | <a href="#"><u>821</u></a> |
| Monument Box Adjust.....  | <a href="#"><u>709</u></a> | <a href="#"><u>821</u></a> |
| Monument Preservation.....  | <a href="#"><u>709</u></a> | <a href="#"><u>821</u></a> |
| Monument Preservation, Vertical.....                                  | <a href="#"><u>709</u></a> | <a href="#"><u>821</u></a> |
| Mowing.....   | <a href="#"><u>661</u></a> | <a href="#"><u>817</u></a> |
| Mulch.....  | <a href="#"><u>657</u></a> | <a href="#"><u>816</u></a> |
| Mulch Anchoring .....   | <a href="#"><u>657</u></a> | <a href="#"><u>816</u></a> |
| Mulch Blanket.....  | <a href="#"><u>657</u></a> | <a href="#"><u>816</u></a> |
| Mulch Blanket, High Velocity .....                                    | <a href="#"><u>658</u></a> | <a href="#"><u>816</u></a> |
| Mulch Netting .....   | <a href="#"><u>657</u></a> | <a href="#"><u>816</u></a> |
| <b>N</b>  |                            |                            |
| Non-Chloride Accelerator.....   | <a href="#"><u>339</u></a> | <a href="#"><u>603</u></a> |
| <b>O</b>  |                            |                            |
| Obliterate Old Road .....   | <a href="#"><u>149</u></a> | <a href="#"><u>207</u></a> |
| Obstruction Removal.....  | <a href="#"><u>533</u></a> | <a href="#"><u>718</u></a> |
| Overband Crack Fill, Ramp.....  | <a href="#"><u>253</u></a> | <a href="#"><u>502</u></a> |
| Overband Crack Fill, Roadbed.....                                     | <a href="#"><u>253</u></a> | <a href="#"><u>502</u></a> |
| Overhead Lane Assignment Structure.....                               | <a href="#"><u>583</u></a> | <a href="#"><u>810</u></a> |
| <b>P</b>  |                            |                            |
| Part Width Intersection Construction .....                            | <a href="#"><u>623</u></a> | <a href="#"><u>812</u></a> |
| Patch, Forming.....   | <a href="#"><u>482</u></a> | <a href="#"><u>712</u></a> |
| Patch, Full Depth.....  | <a href="#"><u>482</u></a> | <a href="#"><u>712</u></a> |
| Patching Conc, (type) .....   | <a href="#"><u>482</u></a> | <a href="#"><u>712</u></a> |
| Patching Mortar or Conc .....   | <a href="#"><u>482</u></a> | <a href="#"><u>712</u></a> |
| Paved Ditch, Conc .....   | <a href="#"><u>639</u></a> | <a href="#"><u>814</u></a> |

| <b>ITEM DESCRIPTION</b>  | <b>PAGE</b>         | <b>SEC</b>          |
|--|---------------------|---------------------|
| Paved Ditch, HMA.....  | <a href="#">639</a> | <a href="#">814</a> |
| Paver Placed Surface Seal, Type ____   | <a href="#">259</a> | <a href="#">503</a> |
| Pavt for Butt Joints, Rem .....  | <a href="#">247</a> | <a href="#">501</a> |
| Pavt Gapping .....   | <a href="#">318</a> | <a href="#">602</a> |
| Pavt Joint and Crack Repr, Det ____  | <a href="#">247</a> | <a href="#">501</a> |
| Pavt Mrkg Cover, Type R, (color) .....   | <a href="#">623</a> | <a href="#">812</a> |
| Pavt Mrkg, (material), 4 inch, SRSM, (color) .....                               | <a href="#">598</a> | <a href="#">811</a> |
| Pavt Mrkg, (material), 4 inch, SRSM, 2nd Application,<br>(color).....            | <a href="#">598</a> | <a href="#">811</a> |
| Pavt Mrkg, Longit, 6 inch or Less Width, Rem.....                                | <a href="#">623</a> | <a href="#">812</a> |
| Pavt Mrkg, Longit, Greater than 6 inch Width, Rem .....                          | <a href="#">623</a> | <a href="#">812</a> |
| Pavt Mrkg, Ovly Cold Plastic, (legend) .....                                     | <a href="#">598</a> | <a href="#">811</a> |
| Pavt Mrkg, Ovly Cold Plastic, (symbol).....                                      | <a href="#">598</a> | <a href="#">811</a> |
| Pavt Mrkg, Ovly Cold Plastic, ____ inch, (color).....                            | <a href="#">597</a> | <a href="#">811</a> |
| Pavt Mrkg, Ovly Cold Plastic, ____ inch, Crosswalk .....                         | <a href="#">598</a> | <a href="#">811</a> |
| Pavt Mrkg, Ovly Cold Plastic, ____ inch, Stop Bar .....                          | <a href="#">597</a> | <a href="#">811</a> |
| Pavt Mrkg, Ovly Cold Plastic, 12 inch, Crosshatching,<br>(color).....            | <a href="#">597</a> | <a href="#">811</a> |
| Pavt Mrkg, Polyurea, ____ inch, (color).....                                     | <a href="#">598</a> | <a href="#">811</a> |
| Pavt Mrkg, Polyurea, ____ inch, Cross Hatching .....                             | <a href="#">598</a> | <a href="#">811</a> |
| Pavt Mrkg, Polyurea, ____ inch, Crosswalk .....                                  | <a href="#">598</a> | <a href="#">811</a> |
| Pavt Mrkg, Polyurea, ____ inch, Stop Bar .....                                   | <a href="#">598</a> | <a href="#">811</a> |
| Pavt Mrkg, Regular Dry, ____ inch, (color).....                                  | <a href="#">597</a> | <a href="#">811</a> |
| Pavt Mrkg, Regular Dry, 2nd Application, ____ inch, (color) .....                | <a href="#">597</a> | <a href="#">811</a> |
| Pavt Mrkg, Sprayable Thermopl, ____ inch, (color) .....                          | <a href="#">597</a> | <a href="#">811</a> |
| Pavt Mrkg, Thermopl, ____ inch, (color).....                                     | <a href="#">597</a> | <a href="#">811</a> |
| Pavt Mrkg, Thermopl, ____ inch, Cross Hatching, (color) .....                    | <a href="#">597</a> | <a href="#">811</a> |
| Pavt Mrkg, Thermopl, ____ inch, Crosswalk .....                                  | <a href="#">597</a> | <a href="#">811</a> |
| Pavt Mrkg, Thermopl, ____ inch, Stop Bar .....                                   | <a href="#">597</a> | <a href="#">811</a> |
| Pavt Mrkg, Type NR, Paint, 4 inch, (color), Temp .....                           | <a href="#">623</a> | <a href="#">812</a> |
| Pavt Mrkg, Type NR, Tape, 4 inch, (color),Temp .....                             | <a href="#">623</a> | <a href="#">812</a> |
| Pavt Mrkg, Type R, 4 inch, (color), Temp .....                                   | <a href="#">623</a> | <a href="#">812</a> |
| Pavt Mrkg, Waterborne, ____ inch, (color) .....                                  | <a href="#">597</a> | <a href="#">811</a> |
| Pavt Mrkg, Waterborne, 2nd Application ____ inch, (color) .....                  | <a href="#">597</a> | <a href="#">811</a> |
| Pavt Mrkg, Waterborne, for Rest Areas, Parks, &<br>Lots, ____ inch, (color)..... | <a href="#">597</a> | <a href="#">811</a> |
| Pavt Repr, Nonreinf Conc, ____ inch .....  | <a href="#">339</a> | <a href="#">603</a> |
| Pavt Repr, Reinf Conc, ____ inch.....  | <a href="#">339</a> | <a href="#">603</a> |
| Pavt Repr, Rem.....  | <a href="#">339</a> | <a href="#">603</a> |
| Pavt, Cleaning.....  | <a href="#">247</a> | <a href="#">501</a> |
| Pavt, Rem .....  | <a href="#">123</a> | <a href="#">204</a> |
| Pavt, Rubblize .....   | <a href="#">169</a> | <a href="#">304</a> |

# INDEX

| ITEM DESCRIPTION                                      | PAGE       | SEC        |
|---|------------|------------|
| Pedestal Fdn, Rem .....                               | <u>696</u> | <u>820</u> |
| Pedestal, Alum .....                                  | <u>696</u> | <u>820</u> |
| Pedestal, Alum, Salv .....                            | <u>696</u> | <u>820</u> |
| Pedestal, Fdn .....                                   | <u>696</u> | <u>820</u> |
| Pedestal, Rem.....                                    | <u>696</u> | <u>820</u> |
| Perforated Steel Square Tube Breakaway System .....   | <u>583</u> | <u>810</u> |
| Permanent Casing .....                                | <u>533</u> | <u>718</u> |
| Pile Driving Equipment, Furn, (Structure No.) .....   | <u>380</u> | <u>705</u> |
| Pile Point, CIP Conc.....                             | <u>380</u> | <u>705</u> |
| Pile Point, Steel.....                                | <u>380</u> | <u>705</u> |
| Pile, CIP Conc, Furn and Driven, __ inch .....        | <u>379</u> | <u>705</u> |
| Pile, Galv, (Structure No.) .....                     | <u>379</u> | <u>705</u> |
| Pile, Steel, Furn and Driven, __ inch .....           | <u>379</u> | <u>705</u> |
| Pile, Treated Timber, Driven .....                    | <u>379</u> | <u>705</u> |
| Pile, Treated Timber, Furn .....                      | <u>379</u> | <u>705</u> |
| Pipe Railing, (material).....                         | <u>460</u> | <u>711</u> |
| Pipe Sleeve, __ inch .....                            | <u>410</u> | <u>706</u> |
| Pipe Sleeve, __ inch, Placed .....                    | <u>410</u> | <u>706</u> |
| Plastic Drum, High Intensity, Furn .....              | <u>622</u> | <u>812</u> |
| Plastic Drum, High Intensity, Lighted, Furn .....     | <u>622</u> | <u>812</u> |
| Plastic Drum, High Intensity, Lighted, Oper .....     | <u>622</u> | <u>812</u> |
| Plastic Drum, High Intensity, Oper .....              | <u>622</u> | <u>812</u> |
| Pole Guy .....  | <u>696</u> | <u>820</u> |
| Polyethylene Encasement .....                         | <u>720</u> | <u>823</u> |
| Post Hole Through Conc for Steel Post.....            | <u>583</u> | <u>810</u> |
| Post Hole Through Conc for Wood Post.....             | <u>583</u> | <u>810</u> |
| Post Tensioning (Structure No.).....                  | <u>445</u> | <u>708</u> |
| Post, Delineator.....                                 | <u>583</u> | <u>810</u> |
| Post, Flexible, Delineator .....                      | <u>583</u> | <u>810</u> |
| Post, Mailbox.....                                    | <u>560</u> | <u>807</u> |
| Post, Steel, __ pound.....                            | <u>583</u> | <u>810</u> |
| Post, Wood Guard.....                                 | <u>560</u> | <u>807</u> |
| Post, Wood Guide .....                                | <u>560</u> | <u>807</u> |
| Post, Wood, __ inch x __ inch .....                   | <u>583</u> | <u>810</u> |
| Post, Wood, __ inch x __ inch, Direct Embedment ..... | <u>583</u> | <u>810</u> |
| Power Co. (Est Cost to Contractor) .....              | <u>696</u> | <u>820</u> |
| Prebore, Fdn Piling .....                             | <u>380</u> | <u>705</u> |
| Prest Conc 1800 Beam, Erect .....                     | <u>445</u> | <u>708</u> |
| Prest Conc 1800 Beam, Furn .....                      | <u>445</u> | <u>708</u> |
| Prest Conc Box Beam, Erect, __ inch.....              | <u>445</u> | <u>708</u> |
| Prest Conc Box Beam, Furn, __ inch.....               | <u>445</u> | <u>708</u> |
| Prest Conc Deck, __ inch .....                        | <u>445</u> | <u>708</u> |

| <b>ITEM DESCRIPTION</b>   | <b>PAGE</b>         | <b>SEC</b>          |
|---|---------------------|---------------------|
| Prest Conc I Beam, Erect, __ inch.....                              | <a href="#">445</a> | <a href="#">708</a> |
| Prest Conc I Beam, Furn, __ inch.....                               | <a href="#">445</a> | <a href="#">708</a> |
| Project Cleanup.....  | <a href="#">158</a> | <a href="#">209</a> |
| Protect Corners.....  | <a href="#">709</a> | <a href="#">821</a> |
| Protective Shield, Utility Pipe.....                                | <a href="#">512</a> | <a href="#">715</a> |
| PTS System, Temp, Furn.....   | <a href="#">623</a> | <a href="#">812</a> |
| PTS System, Temp, Oper.....   | <a href="#">623</a> | <a href="#">812</a> |
| Pushbutton.....   | <a href="#">695</a> | <a href="#">820</a> |
| Pushbutton and Sign.....  | <a href="#">695</a> | <a href="#">820</a> |
| Pushbutton, Rem.....  | <a href="#">695</a> | <a href="#">820</a> |
| <b>R</b>  |                     |                     |
| Railing for Steps.....  | <a href="#">544</a> | <a href="#">803</a> |
| Raised Pavt Marker, Temp, Type __, (color), Bidirectional ...       | <a href="#">623</a> | <a href="#">812</a> |
| Raised Pavt Marker, Temp, Type __, (color),<br>Monodirectional..... | <a href="#">623</a> | <a href="#">812</a> |
| Reflective Marker, Permanent Barrier.....                           | <a href="#">460</a> | <a href="#">711</a> |
| Reinforcement, Mechanical Splice.....                               | <a href="#">482</a> | <a href="#">712</a> |
| Reinforcement, Steel.....   | <a href="#">409</a> | <a href="#">706</a> |
| Reinforcement, Steel, Culv and Headwall.....                        | <a href="#">409</a> | <a href="#">706</a> |
| Reinforcement, Steel, Epoxy Coated.....                             | <a href="#">409</a> | <a href="#">706</a> |
| Rem Curing Compound, for Longit Mrkg __ width.....                  | <a href="#">598</a> | <a href="#">811</a> |
| Rem Curing Compound, for Spec Mrkg.....                             | <a href="#">598</a> | <a href="#">811</a> |
| Rem Raised Pavt Marker.....   | <a href="#">598</a> | <a href="#">811</a> |
| Rem Spec Mrkg.....  | <a href="#">598</a> | <a href="#">811</a> |
| Resealing Longit Joints with Hot-Poured Rubber.....                 | <a href="#">339</a> | <a href="#">603</a> |
| Resealing Trans Joints with Hot-Poured Rubber.....                  | <a href="#">339</a> | <a href="#">603</a> |
| Riprap, Grouted.....  | <a href="#">635</a> | <a href="#">813</a> |
| Riprap, Heavy.....  | <a href="#">635</a> | <a href="#">813</a> |
| Riprap, Heavy, LM.....  | <a href="#">635</a> | <a href="#">813</a> |
| Riprap, Plain.....  | <a href="#">635</a> | <a href="#">813</a> |
| Riprap, Plain, LM.....  | <a href="#">635</a> | <a href="#">813</a> |
| Riser.....  | <a href="#">696</a> | <a href="#">820</a> |
| Riser, Rem.....   | <a href="#">696</a> | <a href="#">820</a> |
| Rocker, Realign.....  | <a href="#">496</a> | <a href="#">713</a> |
| <b>S</b>  |                     |                     |
| Salv Crushed Material, LM.....                                      | <a href="#">171</a> | <a href="#">305</a> |
| Saw Cut, Intermediate.....  | <a href="#">339</a> | <a href="#">603</a> |
| Saw Cut, Rubblize.....  | <a href="#">169</a> | <a href="#">304</a> |
| Sawing and Sealing Longit Pavt Joints.....                          | <a href="#">339</a> | <a href="#">603</a> |
| Sawing and Sealing Trans Pavt Joints.....                           | <a href="#">339</a> | <a href="#">603</a> |

# INDEX

| <b>ITEM DESCRIPTION</b>  | <b>PAGE</b>                | <b>SEC</b>                 |
|--|----------------------------|----------------------------|
| Scarifying .....   | <a href="#"><u>482</u></a> | <a href="#"><u>712</u></a> |
| Seal, Double Chip .....  | <a href="#"><u>277</u></a> | <a href="#"><u>505</u></a> |
| Seal, Shoulder Chip .....  | <a href="#"><u>277</u></a> | <a href="#"><u>505</u></a> |
| Seal, Single Chip .....  | <a href="#"><u>277</u></a> | <a href="#"><u>505</u></a> |
| Seal, Slurry .....   | <a href="#"><u>284</u></a> | <a href="#"><u>506</u></a> |
| Seeding, Mixture __ .....  | <a href="#"><u>657</u></a> | <a href="#"><u>816</u></a> |
| Serv Disconnect .....  | <a href="#"><u>696</u></a> | <a href="#"><u>820</u></a> |
| Serv Disconnect, Rem .....   | <a href="#"><u>696</u></a> | <a href="#"><u>820</u></a> |
| Serv Disconnect, Salv .....  | <a href="#"><u>696</u></a> | <a href="#"><u>820</u></a> |
| Sewer Bulkhead, __ inch .....  | <a href="#"><u>200</u></a> | <a href="#"><u>402</u></a> |
| Sewer Tap, __ inch .....   | <a href="#"><u>200</u></a> | <a href="#"><u>402</u></a> |
| Sewer, CI __, (type), __ inch, Jacked in Place .....                     | <a href="#"><u>200</u></a> | <a href="#"><u>402</u></a> |
| Sewer, CI __, __ inch, Tr Det __ .....                                   | <a href="#"><u>200</u></a> | <a href="#"><u>402</u></a> |
| Sewer, Reinf Conc Ellip, CI __, (rise) x (span) inch,<br>Tr Det __ ..... | <a href="#"><u>200</u></a> | <a href="#"><u>402</u></a> |
| Sewer, Rem, 24 inch to 48 inch .....                                     | <a href="#"><u>118</u></a> | <a href="#"><u>203</u></a> |
| Sewer, Rem, Less than 24 inch .....                                      | <a href="#"><u>118</u></a> | <a href="#"><u>203</u></a> |
| Sewer, Rem, Over 48 inch .....   | <a href="#"><u>118</u></a> | <a href="#"><u>203</u></a> |
| Shared use Path, Aggregate .....   | <a href="#"><u>554</u></a> | <a href="#"><u>806</u></a> |
| Shared use Path, Aggregate, LM .....                                     | <a href="#"><u>554</u></a> | <a href="#"><u>806</u></a> |
| Shared use Path, Conc .....  | <a href="#"><u>554</u></a> | <a href="#"><u>806</u></a> |
| Shared use Path, Grading .....   | <a href="#"><u>554</u></a> | <a href="#"><u>806</u></a> |
| Shared use Path, HMA .....   | <a href="#"><u>554</u></a> | <a href="#"><u>806</u></a> |
| Shear Developers (Structure No.) .....                                   | <a href="#"><u>434</u></a> | <a href="#"><u>707</u></a> |
| Shotcrete .....  | <a href="#"><u>456</u></a> | <a href="#"><u>710</u></a> |
| Shoulder Corrugations, Ground or Cut, Conc .....                         | <a href="#"><u>711</u></a> | <a href="#"><u>822</u></a> |
| Shoulder Corrugations, Ground or Cut, HMA .....                          | <a href="#"><u>711</u></a> | <a href="#"><u>822</u></a> |
| Shoulder Gutter, Conc, Det __ .....                                      | <a href="#"><u>540</u></a> | <a href="#"><u>802</u></a> |
| Shoulder, CI __ .....  | <a href="#"><u>178</u></a> | <a href="#"><u>307</u></a> |
| Shoulder, CI __, __ inch .....   | <a href="#"><u>178</u></a> | <a href="#"><u>307</u></a> |
| Shoulder, CI __, CIP .....   | <a href="#"><u>178</u></a> | <a href="#"><u>307</u></a> |
| Shoulder, CI __, LM .....  | <a href="#"><u>178</u></a> | <a href="#"><u>307</u></a> |
| Shoulder, Freeway .....  | <a href="#"><u>318</u></a> | <a href="#"><u>602</u></a> |
| Shoulder, Nonreinf Conc .....  | <a href="#"><u>318</u></a> | <a href="#"><u>602</u></a> |
| Shoulder, Reinf Conc .....   | <a href="#"><u>318</u></a> | <a href="#"><u>602</u></a> |
| Sidewalk Ramp, Conc, __ inch .....                                       | <a href="#"><u>544</u></a> | <a href="#"><u>803</u></a> |
| Sidewalk, Conc, __ inch .....  | <a href="#"><u>544</u></a> | <a href="#"><u>803</u></a> |
| Sidewalk, Rem .....  | <a href="#"><u>123</u></a> | <a href="#"><u>204</u></a> |
| Sign Cover .....   | <a href="#"><u>622</u></a> | <a href="#"><u>812</u></a> |
| Sign Cover, Type 1 .....   | <a href="#"><u>622</u></a> | <a href="#"><u>812</u></a> |
| Sign Optical (LED) .....   | <a href="#"><u>697</u></a> | <a href="#"><u>820</u></a> |
| Sign Optical, Rem .....  | <a href="#"><u>697</u></a> | <a href="#"><u>820</u></a> |

| ITEM DESCRIPTION  | PAGE                | SEC                 |
|---|---------------------|---------------------|
| Sign Support Fdn, Conc Barrier, Truss Type _____                | <a href="#">548</a> | <a href="#">804</a> |
| Sign, Portable, Changeable Message, Furn.....                   | <a href="#">622</a> | <a href="#">812</a> |
| Sign, Portable, Changeable Message, Oper.....                   | <a href="#">622</a> | <a href="#">812</a> |
| Sign, Type _____  | <a href="#">583</a> | <a href="#">810</a> |
| Sign, Type __, Erect, Salv.....                                 | <a href="#">584</a> | <a href="#">810</a> |
| Sign, Type __, Rem.....   | <a href="#">584</a> | <a href="#">810</a> |
| Sign, Type __, Temp, Prismatic, Furn.....                       | <a href="#">622</a> | <a href="#">812</a> |
| Sign, Type __, Temp, Prismatic, Oper.....                       | <a href="#">622</a> | <a href="#">812</a> |
| Site Preparation, Max. (dollar).....                            | <a href="#">646</a> | <a href="#">815</a> |
| Slope Paving Header.....  | <a href="#">635</a> | <a href="#">813</a> |
| Slope Paving, Conc.....   | <a href="#">635</a> | <a href="#">813</a> |
| Slope Paving, Precast Conc.....                                 | <a href="#">635</a> | <a href="#">813</a> |
| Sodding.....  | <a href="#">657</a> | <a href="#">816</a> |
| Span Wire.....  | <a href="#">696</a> | <a href="#">820</a> |
| Span Wire, Rem.....   | <a href="#">696</a> | <a href="#">820</a> |
| Spillway, Conc.....   | <a href="#">540</a> | <a href="#">802</a> |
| Staking Plan Errors and Extras, One Person.....                 | <a href="#">732</a> | <a href="#">824</a> |
| Staking Plan Errors and Extras, Three Person.....               | <a href="#">732</a> | <a href="#">824</a> |
| Staking Plan Errors and Extras, Two Person.....                 | <a href="#">732</a> | <a href="#">824</a> |
| Steel Casing Pipe, __ inch, Jacked in Place.....                | <a href="#">190</a> | <a href="#">401</a> |
| Steel Casing Pipe, __ inch, Trench Det.....                     | <a href="#">190</a> | <a href="#">401</a> |
| Steel Pole, Fit Up, (type).....                                 | <a href="#">679</a> | <a href="#">819</a> |
| Steel Pole, Rem.....  | <a href="#">695</a> | <a href="#">820</a> |
| Steel Pole, Rem (Embedded).....                                 | <a href="#">695</a> | <a href="#">820</a> |
| Steel Sheet Piling, Permanent.....                              | <a href="#">363</a> | <a href="#">704</a> |
| Steel Sheet Piling, Temp.....                                   | <a href="#">363</a> | <a href="#">704</a> |
| Steel Sheet Piling, Temp, Left in Place.....                    | <a href="#">363</a> | <a href="#">704</a> |
| Steel Structure, Cleaning, Partial, Type 4 (Structure No.)..... | <a href="#">512</a> | <a href="#">715</a> |
| Steel Structure, Cleaning, Type 4 (Structure No.).....          | <a href="#">512</a> | <a href="#">715</a> |
| Steel Structure, Coating Type 4 (Structure No.).....            | <a href="#">512</a> | <a href="#">715</a> |
| Steel Structure, Coating, Partial, Type 4 (Structure No.).....  | <a href="#">512</a> | <a href="#">715</a> |
| Steps, Conc.....  | <a href="#">544</a> | <a href="#">803</a> |
| Stiffeners, Furn, Fab, and Erect.....                           | <a href="#">496</a> | <a href="#">713</a> |
| Strain Pole Fdn, Cased.....                                     | <a href="#">695</a> | <a href="#">820</a> |
| Strain Pole Fdn, Uncased.....                                   | <a href="#">695</a> | <a href="#">820</a> |
| Strain Pole, Steel, Anchor Base, __ foot.....                   | <a href="#">695</a> | <a href="#">820</a> |
| Strain Pole, Steel, Anchor Base, __ foot, Salv.....             | <a href="#">695</a> | <a href="#">820</a> |
| Strain Pole, Steel, Anchor Fdn.....                             | <a href="#">695</a> | <a href="#">820</a> |
| Structural Crack, Repr.....                                     | <a href="#">482</a> | <a href="#">712</a> |
| Structural Steel, Furn and Fab, Pin and Hanger.....             | <a href="#">496</a> | <a href="#">713</a> |
| Structural Steel, Mixed, Erect.....                             | <a href="#">434</a> | <a href="#">707</a> |
| Structural Steel, Mixed, Furn and Fab.....                      | <a href="#">434</a> | <a href="#">707</a> |



# INDEX

| <b>ITEM DESCRIPTION</b>   | <b>PAGE</b>         | <b>SEC</b>          |
|---|---------------------|---------------------|
| Structural Steel, Plate, Erect.....   | <a href="#">434</a> | <a href="#">707</a> |
| Structural Steel, Plate, Furn and Fab.....  | <a href="#">434</a> | <a href="#">707</a> |
| Structural Steel, Retrofit, Furn, Fab, and Erect.....                               | <a href="#">496</a> | <a href="#">713</a> |
| Structural Steel, Rolled Shape, Erect .....   | <a href="#">434</a> | <a href="#">707</a> |
| Structural Steel, Rolled Shape, Furn and Fab .....                                  | <a href="#">434</a> | <a href="#">707</a> |
| Structural Steel, Welded Repair, Furn, Fab, and Erect .....                         | <a href="#">496</a> | <a href="#">713</a> |
| Structure, Timber (Structure No.).....  | <a href="#">449</a> | <a href="#">709</a> |
| Structures, Rehabilitation, Rem Portions (Structure No.) .....                      | <a href="#">482</a> | <a href="#">712</a> |
| Structures, Rem .....   | <a href="#">123</a> | <a href="#">204</a> |
| Structures, Rem Portions .....  | <a href="#">123</a> | <a href="#">204</a> |
| Structures, Temp (Structure No.).....   | <a href="#">500</a> | <a href="#">714</a> |
| Structures, Temp, Rem (Structure No.) .....   | <a href="#">500</a> | <a href="#">714</a> |
| Strut Guy .....   | <a href="#">696</a> | <a href="#">820</a> |
| Stump, Rem, __ inch to __ inch.....   | <a href="#">115</a> | <a href="#">202</a> |
| Stump, Rem, 37 inch or Larger .....   | <a href="#">115</a> | <a href="#">202</a> |
| Subbase, CIP .....  | <a href="#">161</a> | <a href="#">301</a> |
| Subbase, LM .....   | <a href="#">161</a> | <a href="#">301</a> |
| Subgrade Manipulation .....   | <a href="#">140</a> | <a href="#">205</a> |
| Subgrade Undercutting, Type __ .....  | <a href="#">140</a> | <a href="#">205</a> |
| Substructure Conc .....   | <a href="#">409</a> | <a href="#">706</a> |
| Superstructure Conc .....   | <a href="#">410</a> | <a href="#">706</a> |
| Superstructure Conc, Form, Finish, and Cure<br>(Structure No.) .....                | <a href="#">410</a> | <a href="#">706</a> |
| Superstructure Conc, Form, Finish, and Cure,<br>Night Casting (Structure No.) ..... | <a href="#">410</a> | <a href="#">706</a> |
| Superstructure Conc, Night Casting .....  | <a href="#">410</a> | <a href="#">706</a> |
| Support, Column, Temp .....   | <a href="#">496</a> | <a href="#">713</a> |
| Support, Diaphragm, Temp.....   | <a href="#">496</a> | <a href="#">713</a> |
| Support, Suspension, Temp .....   | <a href="#">496</a> | <a href="#">713</a> |
| Support, Temp .....   | <a href="#">410</a> | <a href="#">706</a> |
| <b>T</b>  |                     |                     |
| Temp Casing.....  | <a href="#">533</a> | <a href="#">718</a> |
| Temp Casing-Left in Place.....  | <a href="#">533</a> | <a href="#">718</a> |
| Test Pile, CIP Conc, __ inch .....  | <a href="#">379</a> | <a href="#">705</a> |
| Test Pile, Steel, __ inch .....   | <a href="#">380</a> | <a href="#">705</a> |
| Test Pile, Treated Timber .....   | <a href="#">379</a> | <a href="#">705</a> |
| Thinning, Selective, Type __.....   | <a href="#">113</a> | <a href="#">201</a> |
| Timber and Lumber, Treated, Furn and Place.....                                     | <a href="#">449</a> | <a href="#">709</a> |
| Top Flanges and Beam Ends, Clean and Coat .....                                     | <a href="#">482</a> | <a href="#">712</a> |
| Topsoil Surface, Furn, __ inch .....  | <a href="#">657</a> | <a href="#">816</a> |
| Topsoil Surface, Furn, LM.....  | <a href="#">657</a> | <a href="#">816</a> |

| <b>ITEM DESCRIPTION</b>  | <b>PAGE</b>         | <b>SEC</b>          |
|--|---------------------|---------------------|
| Topsoil Surface, Salv, __ inch .....                                 | <a href="#">657</a> | <a href="#">816</a> |
| Topsoil Surface, Salv, LM .....                                      | <a href="#">657</a> | <a href="#">816</a> |
| Tower Ltg Unit, __ foot (Number) Luminaire .....                     | <a href="#">679</a> | <a href="#">819</a> |
| Tower Ltg Unit, Fdn Cased .....                                      | <a href="#">679</a> | <a href="#">819</a> |
| Tower Ltg Unit, Fdn Uncased .....                                    | <a href="#">679</a> | <a href="#">819</a> |
| Track, Rem.....  | <a href="#">123</a> | <a href="#">204</a> |
| Traf Loop.....   | <a href="#">696</a> | <a href="#">820</a> |
| Traf Loop, (type).....   | <a href="#">696</a> | <a href="#">820</a> |
| Traffic Regulator Control.....                                       | <a href="#">622</a> | <a href="#">812</a> |
| Transporting Salv MDOT Materials.....                                | <a href="#">584</a> | <a href="#">810</a> |
| Tree, Rem, __ inch to __ inch.....                                   | <a href="#">115</a> | <a href="#">202</a> |
| Tree, Rem, 37 inch or Larger.....                                    | <a href="#">115</a> | <a href="#">202</a> |
| Trench Undercut and Backfill.....                                    | <a href="#">200</a> | <a href="#">402</a> |
| Trenching .....  | <a href="#">178</a> | <a href="#">307</a> |
| Truss Fdn Anchor Bolts, Replace .....                                | <a href="#">584</a> | <a href="#">810</a> |
| Truss, Rem.....  | <a href="#">584</a> | <a href="#">810</a> |
| Truss, Type __, __ foot .....  | <a href="#">583</a> | <a href="#">810</a> |
| Truss, Type __, __ foot, Erect, Salv.....                            | <a href="#">584</a> | <a href="#">810</a> |
| TS, (number) Way (type) Mtd .....                                    | <a href="#">695</a> | <a href="#">820</a> |
| TS, (number) Way (type) Mtd (LED).....                               | <a href="#">695</a> | <a href="#">820</a> |
| TS, (number) Way (type) Mtd (LED) Retrofit Assembly.....             | <a href="#">695</a> | <a href="#">820</a> |
| TS, (number) Way (type) Mtd, (arrow type) .....                      | <a href="#">695</a> | <a href="#">820</a> |
| TS, (number) Way (type) Mtd, (arrow type), Salv .....                | <a href="#">695</a> | <a href="#">820</a> |
| TS, (number) Way (type) Mtd, (type) (LED).....                       | <a href="#">695</a> | <a href="#">820</a> |
| TS, (number) Way (type) Mtd, (type) (LED) Retrofit<br>Assembly ..... | <a href="#">695</a> | <a href="#">820</a> |
| TS, (number) Way (type) Mtd, Salv .....                              | <a href="#">695</a> | <a href="#">820</a> |
| TS, (type) Mtd, Rem.....   | <a href="#">695</a> | <a href="#">820</a> |
| TS, 4th Level (arrow type).....                                      | <a href="#">695</a> | <a href="#">820</a> |
| TS, 4th Level (arrow type), Salv.....                                | <a href="#">695</a> | <a href="#">820</a> |
| TS, 4th Level Arrow, Rem.....  | <a href="#">695</a> | <a href="#">820</a> |
| TS, 4th Level, __ (LED) .....  | <a href="#">695</a> | <a href="#">820</a> |
| TS, 4th Level, __ (LED) Retrofit Assembly .....                      | <a href="#">695</a> | <a href="#">820</a> |
| TS, Antenna .....  | <a href="#">695</a> | <a href="#">820</a> |
| TS, Antenna, Rem.....  | <a href="#">695</a> | <a href="#">820</a> |
| TS, Antenna, Salv .....  | <a href="#">695</a> | <a href="#">820</a> |
| TS, Lens.....  | <a href="#">695</a> | <a href="#">820</a> |
| TS, Lens, Pedestrian Sym .....                                       | <a href="#">695</a> | <a href="#">820</a> |
| TS, Lens, Rem .....  | <a href="#">695</a> | <a href="#">820</a> |
| TS, Lens, Salv.....  | <a href="#">695</a> | <a href="#">820</a> |
| TS, Pedestrian, (number) Way (type) Mtd .....                        | <a href="#">695</a> | <a href="#">820</a> |
| TS, Pedestrian, (number) Way (type) Mtd (LED).....                   | <a href="#">695</a> | <a href="#">820</a> |

INDEX

| <b>ITEM DESCRIPTION</b>  | <b>PAGE</b> | <b>SEC</b> |
|--|-------------|------------|
| TS, Pedestrian, (number) Way (type) Mtd (LED)<br>Countdown ..... | <u>695</u>  | <u>820</u> |
| TS, Pedestrian, (number) Way (type), Salv .....                  | <u>695</u>  | <u>820</u> |
| TS, Pedestrian, (type) Mtd, Rem .....                            | <u>695</u>  | <u>820</u> |
| TS, Temp, Furn .....   | <u>623</u>  | <u>812</u> |
| TS, Temp, Oper .....   | <u>623</u>  | <u>812</u> |
| <b>U</b>   |             |            |
| Underdrain Outlet, __ inch .....                                 | <u>214</u>  | <u>404</u> |
| Underdrain, Bank, __ inch .....                                  | <u>214</u>  | <u>404</u> |
| Underdrain, Bank, Open-Graded, __ inch .....                     | <u>214</u>  | <u>404</u> |
| Underdrain, Edge of Pavt, __ inch .....                          | <u>214</u>  | <u>404</u> |
| Underdrain, Fdn, __ inch .....                                   | <u>214</u>  | <u>404</u> |
| Underdrain, Outlet Ending, __ inch .....                         | <u>214</u>  | <u>404</u> |
| Underdrain, PDS, Open-Graded, __ inch .....                      | <u>214</u>  | <u>404</u> |
| Underdrain, Pipe, Open-Graded, __ inch .....                     | <u>214</u>  | <u>404</u> |
| Underdrain, Subbase, __ inch .....                               | <u>214</u>  | <u>404</u> |
| Underdrain, Subgrade, __ inch .....                              | <u>214</u>  | <u>404</u> |
| Underdrain, Subgrade, Open-Graded, __ inch .....                 | <u>214</u>  | <u>404</u> |
| Utility Pole, Rem .....  | <u>123</u>  | <u>204</u> |
| <b>V</b>   |             |            |
| Valley Gutter, Conc .....  | <u>540</u>  | <u>802</u> |
| Vertical Exploratory Investigation .....                         | <u>697</u>  | <u>820</u> |
| Video Taping Sewer and Culv Pipe .....                           | <u>200</u>  | <u>402</u> |
| <b>W</b>   |             |            |
| Wall Drain .....   | <u>410</u>  | <u>706</u> |
| Warning Sign .....   | <u>697</u>  | <u>820</u> |
| Warning Sign, Rem .....  | <u>697</u>  | <u>820</u> |
| Water Main, __ inch, Cut and Plug .....                          | <u>720</u>  | <u>823</u> |
| Water Main, DI, __ inch, Tr Det __ .....                         | <u>720</u>  | <u>823</u> |
| Water Repellent Treatment, Penetrating .....                     | <u>410</u>  | <u>706</u> |
| Water Serv .....   | <u>720</u>  | <u>823</u> |
| Water Serv, Conflict .....                                       | <u>720</u>  | <u>823</u> |
| Water Serv, Long .....   | <u>720</u>  | <u>823</u> |
| Water Shutoff, Adj, Case __ .....                                | <u>720</u>  | <u>823</u> |
| Water Shutoff, Adj, Temp Case __ .....                           | <u>720</u>  | <u>823</u> |
| Water Shutoff, Reconst, Case __ .....                            | <u>720</u>  | <u>823</u> |
| Water, Sodding/Seeding .....                                     | <u>658</u>  | <u>816</u> |
| Watering and Cultivating, First Season, Min. (dollar) .....      | <u>646</u>  | <u>815</u> |
| Watering and Cultivating, Second Season, Min. (dollar) .....     | <u>646</u>  | <u>815</u> |

| <b>ITEM DESCRIPTION</b>                         | <b>PAGE</b>         | <b>SEC</b>          |
|---|---------------------|---------------------|
| Weed Control .....                              | <a href="#">658</a> | <a href="#">816</a> |
| Witness, Log, Layout, Max. __, \$1,000.00 ..... | <a href="#">598</a> | <a href="#">811</a> |
| Wood Pole.....                                  | <a href="#">679</a> | <a href="#">819</a> |
| Wood Pole, Cl __, __ foot .....                 | <a href="#">679</a> | <a href="#">819</a> |
| Wood Pole, Fit Up, (type).....                  | <a href="#">679</a> | <a href="#">819</a> |
| Wood Pole, Rem .....                            | <a href="#">679</a> | <a href="#">819</a> |

**GENERAL INDEX**

(boldface type indicates materials reference page)

**A**

|  |            |
|--|------------|
| Abandoning Drainage Structures .....           | <u>117</u> |
| Abandoning Pipe Culverts .....                 | <u>117</u> |
| Abbreviations .....                            | <u>3</u>   |
| Acceptance and Final Payment .....             | <u>104</u> |
| Accident Prevention .....                      | <u>35</u>  |
| Addendum ( <i>definition</i> ) .....           | <u>4</u>   |
| Additives in Granular Bases and Surfaces ..... | <u>162</u> |
| Adequacy of Methods and Equipment .....        | <u>73</u>  |
| Adhesive Anchoring:                            |            |
| Horizontal Bar .....                           | <u>484</u> |
| Vertical Bar .....                             | <u>484</u> |
| Adjusting Covers for Drainage Structures ..... | <u>204</u> |
| Adjusting Monument Boxes .....                 | <u>710</u> |
| Adjustment ( <i>definition</i> ) .....         | <u>5</u>   |
| Adjustments .....                              | <u>26</u>  |
| Admixtures for Concrete, Chemical .....        | <u>753</u> |
| Advertisement ( <i>definition</i> ) .....      | <u>5</u>   |
| Aggregate:                                     |            |
| Aggregate Base Course .....                    | <u>162</u> |
| Chip Seal .....                                | <u>742</u> |
| Concrete Pavement .....                        | <u>740</u> |
| Concrete Structures .....                      | <u>349</u> |
| Erosion Control .....                          | <u>844</u> |
| Granular Blanket .....                         | <u>137</u> |
| HMA .....                                      | <u>231</u> |
| Maintenance Gravel .....                       | <u>173</u> |
| Shoulders and Approaches .....                 | <u>176</u> |
| Subbase .....                                  | <u>161</u> |
| Surface Course .....                           | <u>173</u> |
| Aggregate Cover, Erosion Control .....         | <u>153</u> |
| Aggregate Materials:                           |            |
| Aggregate Wear Index .....                     | <u>738</u> |
| Coarse Graded .....                            | <u>740</u> |
| Dense Graded .....                             | <u>742</u> |
| Fine Graded .....                              | <u>744</u> |
| Furnishing and Handling .....                  | <u>738</u> |
| Granular Material .....                        | <u>743</u> |

|  |                            |
|--|----------------------------|
| Mineral Filler .....                             | <a href="#"><u>745</u></a> |
| Open-Graded.....                                 | <a href="#"><u>743</u></a> |
| Test Methods.....                                | <a href="#"><u>738</u></a> |
| Air-Entraining:                                  |                            |
| Admixtures.....                                  | <a href="#"><u>753</u></a> |
| Portland Cement.....                             | <a href="#"><u>737</u></a> |
| Air Pollution, Control of .....                  | <a href="#"><u>65</u></a>  |
| Aluminum:  |                            |
| Extruded Aluminum for Signs.....                 | <a href="#"><u>88</u></a>  |
| Anchor Bolts:                                    |                            |
| Light Poles.....                                 | <a href="#"><u>864</u></a> |
| Sign Supports .....                              | <a href="#"><u>880</u></a> |
| Structures .....                                 | <a href="#"><u>772</u></a> |
| Approach.....                                    | <a href="#"><u>176</u></a> |
| Approval of Materials .....                      | <a href="#"><u>50</u></a>  |
| Approved for Traffic.....                        | <a href="#"><u>69</u></a>  |
| Archaeological and Historical Findings.....      | <a href="#"><u>58</u></a>  |
| Arrows, Lighted:                                 |                            |
| Equipment Requirements .....                     | <a href="#"><u>938</u></a> |
| Use of .....                                     | <a href="#"><u>605</u></a> |
| Asphalt:   |                            |
| Binder .....                                     | <a href="#"><u>756</u></a> |
| Emulsified.....                                  | <a href="#"><u>757</u></a> |
| Liquid .....                                     | <a href="#"><u>757</u></a> |
| Authority:                                       |                            |
| of Department.....                               | <a href="#"><u>30</u></a>  |
| of Engineer .....                                | <a href="#"><u>30</u></a>  |
| of Inspector.....                                | <a href="#"><u>30</u></a>  |
| to Inspect Scales .....                          | <a href="#"><u>31</u></a>  |
| Authorization ( <i>definition</i> ) .....        | <a href="#"><u>5</u></a>   |
| Average Daily Traffic ( <i>definition</i> )..... | <a href="#"><u>5</u></a>   |
| Award ( <i>definition</i> ) .....                | <a href="#"><u>5</u></a>   |

## B

|                          |                            |
|--------------------------|----------------------------|
| Backfill:                |                            |
| for Median Barrier ..... | <a href="#"><u>546</u></a> |
| Structure .....          | <a href="#"><u>146</u></a> |
| Swamp.....               | <a href="#"><u>129</u></a> |
| Band, Sign.....          | <a href="#"><u>573</u></a> |
| Barbed Wire .....        | <a href="#"><u>775</u></a> |
| Barricade, Type III..... | <a href="#"><u>606</u></a> |
| Barrier:                 |                            |
| Concrete .....           | <a href="#"><u>546</u></a> |

# INDEX

|  |            |
|--|------------|
| Reflector Replacement.....                       | <u>627</u> |
| Temporary Concrete.....                          | <u>935</u> |
| Base Course ( <i>definition</i> ) .....          | <u>5</u>   |
| Basement Cleanout.....                           | <u>120</u> |
| Beam Plate, Seal Perimeter.....                  | <u>488</u> |
| Bearing:   |            |
| Elastomeric.....                                 | <u>841</u> |
| for Structures.....                              | <u>425</u> |
| Stiffeners at Temporary Supports .....           | <u>492</u> |
| Bid ( <i>definition</i> ) .....                  | <u>5</u>   |
| Bid and Bid Guaranty:                            |            |
| Consideration .....                              | <u>21</u>  |
| Contents of Proposal.....                        | <u>16</u>  |
| Delivery.....                                    | <u>19</u>  |
| Guaranty Payment.....                            | <u>23</u>  |
| Guaranty Return .....                            | <u>23</u>  |
| Irregular .....                                  | <u>17</u>  |
| Payment.....                                     | <u>23</u>  |
| Rejection.....                                   | <u>19</u>  |
| Rejection Appeal .....                           | <u>20</u>  |
| Review .....                                     | <u>19</u>  |
| Withdrawal or Revision of Bid .....              | <u>19</u>  |
| Bid Appeal Committee ( <i>definition</i> ) ..... | <u>5</u>   |
| Bidder ( <i>definition</i> ).....                | <u>5</u>   |
| Bidder Prequalification .....                    | <u>16</u>  |
| Bid Document ( <i>definition</i> ).....          | <u>5</u>   |
| Bid Guaranty ( <i>definition</i> ) .....         | <u>5</u>   |
| Bid Review Committee ( <i>definition</i> ).....  | <u>5</u>   |
| Blocks:  |            |
| Drainage Structure .....                         | <u>834</u> |
| Slope Paving .....                               | <u>835</u> |
| Bolt:  |            |
| Adhesive Anchored .....                          | <u>470</u> |
| Mechanical Expansion Anchored.....               | <u>472</u> |
| Bolted Connections.....                          | <u>429</u> |
| Bond:  |            |
| Lien.....  | <u>22</u>  |
| Performance .....                                | <u>22</u>  |
| Bond Coat .....                                  | <u>261</u> |
| Boring Logs.....                                 | <u>127</u> |
| Borrow:  |            |
| Material.....                                    | <u>48</u>  |
| Area Restoration.....                            | <u>49</u>  |

|                                      |                     |
|--------------------------------------|---------------------|
| Haul Routes .....                    | <a href="#">49</a>  |
| Brick .....                          | <a href="#">833</a> |
| Bridge ( <i>definition</i> ) .....   | <a href="#">6</a>   |
| Bridge: ( <i>see also</i> Structure) |                     |
| Barrier Railing .....                | <a href="#">459</a> |
| Bearing Plate .....                  | <a href="#">425</a> |
| Lighting .....                       | <a href="#">412</a> |
| Over Navigable Waters .....          | <a href="#">68</a>  |
| Railing .....                        | <a href="#">458</a> |
| Rehabilitation-Concrete .....        | <a href="#">462</a> |
| Rehabilitation-Steel .....           | <a href="#">488</a> |
| Sign Connection .....                | <a href="#">579</a> |
| Bridge Deck:                         |                     |
| Drain .....                          | <a href="#">520</a> |
| Joint, Remove .....                  | <a href="#">467</a> |
| Patching .....                       | <a href="#">474</a> |
| Scarifying .....                     | <a href="#">467</a> |
| Surface Construction .....           | <a href="#">465</a> |
| Bridge Joint:                        |                     |
| Clean and Seal .....                 | <a href="#">466</a> |
| Revise Compression Seal .....        | <a href="#">482</a> |
| Revise Expansion Device .....        | <a href="#">482</a> |
| Bushings .....                       | <a href="#">425</a> |

## C

|  |                     |
|--|---------------------|
| Cable .....  | <a href="#">858</a> |
| Calcium Chloride .....                             | <a href="#">753</a> |
| Calendar Date Contract ( <i>definition</i> ) ..... | <a href="#">6</a>   |
| Calendar Day ( <i>definition</i> ) .....           | <a href="#">6</a>   |
| Calendar Day Contract ( <i>definition</i> ) .....  | <a href="#">6</a>   |
| Call Back, Pavement Marking .....                  | <a href="#">596</a> |
| Cantilever Sign Supports:                          |                     |
| Erecting .....                                     | <a href="#">575</a> |
| Fabrication .....                                  | <a href="#">880</a> |
| Foundation .....                                   | <a href="#">574</a> |
| Carrier Bills, Required for Partial Payments ..... | <a href="#">101</a> |
| Carrier Rates on Construction Materials .....      | <a href="#">104</a> |
| Case Sign .....                                    | <a href="#">916</a> |
| Case Sign Panel .....                              | <a href="#">922</a> |
| Castings:  |                     |
| Gray Iron .....                                    | <a href="#">782</a> |
| Malleable Iron .....                               | <a href="#">782</a> |
| Steel .....  | <a href="#">782</a> |



# INDEX

## Cement:

|                              |                     |
|------------------------------|---------------------|
| Additional Payment for ..... | <a href="#">339</a> |
| Weighing.....                | <a href="#">290</a> |

## Cementitious Materials:

|                      |                     |
|----------------------|---------------------|
| Fly Ash.....         | <a href="#">737</a> |
| Hydrated Lime .....  | <a href="#">737</a> |
| Masonry Cement ..... | <a href="#">737</a> |
| Portland Cement..... | <a href="#">737</a> |

|  |                   |
|--|-------------------|
| Certification of DBE Contractors ( <i>definition</i> ) ..... | <a href="#">6</a> |
|--|-------------------|

|                                   |                   |
|-----------------------------------|-------------------|
| Change ( <i>definition</i> )..... | <a href="#">6</a> |
|-----------------------------------|-------------------|

|   |                    |
|---|--------------------|
| Changes in Quantities, Plans, or Character of the Work..... | <a href="#">26</a> |
|---|--------------------|

|                          |                     |
|--------------------------|---------------------|
| Channel Excavation ..... | <a href="#">139</a> |
|--------------------------|---------------------|

|                            |                     |
|----------------------------|---------------------|
| Channelizing Devices ..... | <a href="#">604</a> |
|----------------------------|---------------------|

|                                  |                     |
|----------------------------------|---------------------|
| Check Dam, Erosion Control ..... | <a href="#">151</a> |
|----------------------------------|---------------------|

|                       |                     |
|-----------------------|---------------------|
| Chipping, Bridge..... | <a href="#">467</a> |
|-----------------------|---------------------|

|                |                     |
|----------------|---------------------|
| Chip Seal..... | <a href="#">742</a> |
|----------------|---------------------|

|   |                    |
|---|--------------------|
| Claims for Extra Compensation, Disputed ..... | <a href="#">40</a> |
|---|--------------------|

|   |                    |
|---|--------------------|
| Claims, Responsibility for Damage ..... | <a href="#">61</a> |
|---|--------------------|

## Cleaning Pavement:

|                       |                     |
|-----------------------|---------------------|
| HMA Paving.....       | <a href="#">250</a> |
| Pavement Marking..... | <a href="#">589</a> |

|                     |                    |
|---------------------|--------------------|
| Cleanup, Final..... | <a href="#">37</a> |
|---------------------|--------------------|

|                       |                     |
|-----------------------|---------------------|
| Cleanup, Project..... | <a href="#">158</a> |
|-----------------------|---------------------|

|               |                     |
|---------------|---------------------|
| Clearing..... | <a href="#">111</a> |
|---------------|---------------------|

|                         |                     |
|-------------------------|---------------------|
| Clearing for Fence..... | <a href="#">113</a> |
|-------------------------|---------------------|

|                   |                     |
|-------------------|---------------------|
| Cobble Ditch..... | <a href="#">637</a> |
|-------------------|---------------------|

|                 |                     |
|-----------------|---------------------|
| Cofferdams..... | <a href="#">361</a> |
|-----------------|---------------------|

|                                      |                     |
|--------------------------------------|---------------------|
| Cold Applied Pipe Joint Sealer ..... | <a href="#">794</a> |
|--------------------------------------|---------------------|

Cold Weather Concrete (*see* Weather and Seasonal Limitations)

## Cold-Milling:

|                   |                     |
|-------------------|---------------------|
| Equipment .....   | <a href="#">235</a> |
| HMA Surface ..... | <a href="#">238</a> |

|                         |                     |
|-------------------------|---------------------|
| Column, Breakaway ..... | <a href="#">572</a> |
|-------------------------|---------------------|

|  |                   |
|--|-------------------|
| Commission ( <i>definition</i> ) ..... | <a href="#">6</a> |
|--|-------------------|

|                               |                     |
|-------------------------------|---------------------|
| Compacting Cut Sections ..... | <a href="#">132</a> |
|-------------------------------|---------------------|

## Competence:

|                                   |                    |
|-----------------------------------|--------------------|
| of Contractor's Supervision ..... | <a href="#">35</a> |
| of Workers .....                  | <a href="#">72</a> |

|  |                    |
|--|--------------------|
| Compliance With Laws; Environmental Protection ..... | <a href="#">65</a> |
|--|--------------------|

## Concrete:

### Barrier:

|                |                     |
|----------------|---------------------|
| Bridge.....    | <a href="#">459</a> |
| Permanent..... | <a href="#">546</a> |

|  |                     |
|--|---------------------|
| Temporary .....                                  | <a href="#">626</a> |
| Base Course .....                                | <a href="#">301</a> |
| Beams, Prestressed .....                         | <a href="#">444</a> |
| Bridge Deck Overlay .....                        | <a href="#">463</a> |
| Culverts, Box and Slab .....                     | <a href="#">217</a> |
| Curb and Gutter .....                            | <a href="#">538</a> |
| Curing .....                                     | <a href="#">312</a> |
| Deck Finishing .....                             | <a href="#">384</a> |
| Dividers .....                                   | <a href="#">538</a> |
| Driveway .....                                   | <a href="#">537</a> |
| Glare Screen .....                               | <a href="#">546</a> |
| Quality Assurance .....                          | <a href="#">345</a> |
| Quality Control .....                            | <a href="#">344</a> |
| Shoulder .....                                   | <a href="#">301</a> |
| Sidewalk, Sidewalk Ramps, and Steps .....        | <a href="#">542</a> |
| Slope Paving .....                               | <a href="#">634</a> |
| Spillway .....                                   | <a href="#">541</a> |
| Concrete Admixtures and Additives:               |                     |
| Accelerators:                                    |                     |
| Pavement .....                                   | <a href="#">298</a> |
| Structure .....                                  | <a href="#">349</a> |
| Latex .....                                      | <a href="#">753</a> |
| Silica Fume .....                                | <a href="#">360</a> |
| Water Reducing and/or Retarding Admixtures ..... | <a href="#">753</a> |
| Concrete Mixtures:                               |                     |
| Pavement .....                                   | <a href="#">287</a> |
| Structure .....                                  | <a href="#">349</a> |
| Concrete Pavement:                               |                     |
| Cleaning .....                                   | <a href="#">238</a> |
| Construction .....                               | <a href="#">301</a> |
| Coring .....                                     | <a href="#">314</a> |
| Gapping .....                                    | <a href="#">320</a> |
| Integral Curb and Gutter .....                   | <a href="#">301</a> |
| Joint and Crack .....                            | <a href="#">338</a> |
| Overlay .....                                    | <a href="#">301</a> |
| Price Adjustment .....                           | <a href="#">321</a> |
| Remove .....                                     | <a href="#">120</a> |
| Restoration .....                                | <a href="#">327</a> |
| Rubblizing .....                                 | <a href="#">166</a> |
| Stenciling .....                                 | <a href="#">311</a> |
| Work Progress Specimens .....                    | <a href="#">298</a> |
| Concrete Production:                             |                     |
| Elapsed Time .....                               | <a href="#">296</a> |

# INDEX

|   |                     |
|---|---------------------|
| Materials Handling.....   | <a href="#">295</a> |
| Mixing.....   | <a href="#">291</a> |
| Plants.....   | <a href="#">287</a> |
| Concrete Strengths:   |                     |
| Pavement.....   | <a href="#">298</a> |
| Structure.....  | <a href="#">350</a> |
| Concrete Tests:   |                     |
| Air Content:  |                     |
| Pavement.....   | <a href="#">287</a> |
| Structure.....  | <a href="#">349</a> |
| Beams and Cylinders:  |                     |
| Pavement.....   | <a href="#">298</a> |
| Structure.....  | <a href="#">439</a> |
| Slump:  |                     |
| Pavement.....   | <a href="#">297</a> |
| Structure.....  | <a href="#">351</a> |
| Strength:   |                     |
| Pavement.....   | <a href="#">298</a> |
| Structure.....  | <a href="#">350</a> |
| Temperature.....  | <a href="#">297</a> |
| Conditioning Aggregate Base.....                                    | <a href="#">163</a> |
| Conduit:  |                     |
| Direct Burial.....  | <a href="#">669</a> |
| Directional Bore.....   | <a href="#">666</a> |
| Encased.....  | <a href="#">665</a> |
| Jacking Boring.....   | <a href="#">667</a> |
| Structures.....   | <a href="#">392</a> |
| Conformity with Plans and Specifications.....                       | <a href="#">33</a>  |
| Consideration of Proposals.....                                     | <a href="#">21</a>  |
| Construction Equipment on or Crossing Pavements and Structures..... | <a href="#">42</a>  |
| Construction Influence Area ( <i>definition</i> ).....              | <a href="#">6</a>   |
| Construction Progress Schedule.....                                 | <a href="#">22</a>  |
| Contents of Proposal Form.....                                      | <a href="#">16</a>  |
| Contract ( <i>definition</i> ).....                                 | <a href="#">6</a>   |
| Contract:   |                     |
| Default.....  | <a href="#">83</a>  |
| Execution and Award.....  | <a href="#">16</a>  |
| Extension of Time.....  | <a href="#">77</a>  |
| Failure to Sign.....  | <a href="#">23</a>  |
| Intent of the.....  | <a href="#">26</a>  |
| Subcontracting.....   | <a href="#">71</a>  |
| Termination.....  | <a href="#">84</a>  |

|  |                     |
|--|---------------------|
| Contract Bond:                                       |                     |
| Lien .....   | <a href="#">22</a>  |
| Performance .....                                    | <a href="#">22</a>  |
| Requirements .....                                   | <a href="#">22</a>  |
| Contract Item (see also Pay Item) (definition) ..... | <a href="#">11</a>  |
| Contract Modification (definition) .....             | <a href="#">7</a>   |
| Contractor (definition) .....                        | <a href="#">7</a>   |
| Contractor:  |                     |
| Cooperation .....                                    | <a href="#">38</a>  |
| Quality Control for Concrete .....                   | <a href="#">344</a> |
| Prequalification .....                               | <a href="#">16</a>  |
| Responsibility for Utilities.....                    | <a href="#">64</a>  |
| Responsibility for the Work.....                     | <a href="#">63</a>  |
| Staking.....   | <a href="#">39</a>  |
| Contractor Staking .....                             | <a href="#">725</a> |
| Contract Time (definition).....                      | <a href="#">7</a>   |
| Contract Time for Work Day Contracts .....           | <a href="#">76</a>  |
| Contract Unit Price (definition) .....               | <a href="#">7</a>   |
| Control of Materials .....                           | <a href="#">48</a>  |
| Control Strip, OGDC .....                            | <a href="#">165</a> |
| Controlled Density Method, Embankments .....         | <a href="#">135</a> |
| Controlling Operation (definition) .....             | <a href="#">7</a>   |
| Coordination Clause (definition).....                | <a href="#">7</a>   |
| Coordination of Specifications and Plans .....       | <a href="#">34</a>  |
| Corduroy, Remove .....                               | <a href="#">115</a> |
| Coring Pavement .....                                | <a href="#">314</a> |
| Crushed Material, Salvaged.....                      | <a href="#">170</a> |
| Crushing Plants, Environmental Protection .....      | <a href="#">65</a>  |
| Crack Sealing, Concrete Pavement.....                | <a href="#">330</a> |
| Crack Treatment, HMA Pavement .....                  | <a href="#">250</a> |
| Culvert (definition) .....                           | <a href="#">7</a>   |
| Culvert:   |                     |
| Backfill .....                                       | <a href="#">187</a> |
| Bedding.....   | <a href="#">185</a> |
| Cleanout .....                                       | <a href="#">189</a> |
| Concrete .....                                       | <a href="#">186</a> |
| Extending.....                                       | <a href="#">186</a> |
| Headwalls and End Sections.....                      | <a href="#">187</a> |
| Laying and Jointing.....                             | <a href="#">185</a> |
| Mandrel Testing.....                                 | <a href="#">186</a> |
| Metal .....  | <a href="#">186</a> |
| Pipe.....  | <a href="#">183</a> |
| Pipe Jacked In Place .....                           | <a href="#">188</a> |

# INDEX

|   |                     |
|---|---------------------|
| Plastic .....   | <a href="#">185</a> |
| Precast Concrete Box.....                             | <a href="#">218</a> |
| Reinforced Concrete.....                              | <a href="#">186</a> |
| Reinforced Concrete, Elliptical .....                 | <a href="#">790</a> |
| Remove .....  | <a href="#">117</a> |
| Repair of Coating.....                                | <a href="#">185</a> |
| Sloped End Sections .....                             | <a href="#">187</a> |
| Video Inspection .....                                | <a href="#">189</a> |
| Watertight Joints.....                                | <a href="#">789</a> |
| Curb:   |                     |
| Concrete .....  | <a href="#">538</a> |
| HMA.....  | <a href="#">550</a> |
| Nose .....  | <a href="#">538</a> |
| Remove .....  | <a href="#">120</a> |
| Curb and Gutter:                                      |                     |
| Concrete .....  | <a href="#">538</a> |
| Remove .....  | <a href="#">120</a> |
| Curing Compound:                                      |                     |
| Bridge Deck Interim .....                             | <a href="#">405</a> |
| Concrete Base Transparent .....                       | <a href="#">754</a> |
| Pavement White Membrane .....                         | <a href="#">754</a> |
| Remove .....  | <a href="#">592</a> |
| Structure Transparent.....                            | <a href="#">754</a> |
| <b>D</b>  |                     |
| Damage Claims.....                                    | <a href="#">61</a>  |
| Damages, Liquidated .....                             | <a href="#">82</a>  |
| Deck Drain .....                                      | <a href="#">520</a> |
| Deck Joint .....                                      | <a href="#">400</a> |
| Decreased or Increased Quantities, Payment for .....  | <a href="#">92</a>  |
| Default of Contract .....                             | <a href="#">83</a>  |
| Definitions .....                                     | <a href="#">4</a>   |
| Delineator.....                                       | <a href="#">572</a> |
| Department ( <i>definition</i> ) .....                | <a href="#">7</a>   |
| Designated Classifications ( <i>definition</i> )..... | <a href="#">7</a>   |
| Determined Low Bidder ( <i>definition</i> ).....      | <a href="#">8</a>   |
| Diamond Grinding Concrete Pavement .....              | <a href="#">336</a> |
| Differing Site Conditions .....                       | <a href="#">27</a>  |
| Digital Loop Detector.....                            | <a href="#">693</a> |
| Director ( <i>definition</i> ).....                   | <a href="#">8</a>   |
| Discrimination.....                                   | <a href="#">55</a>  |
| Disposing of:   |                     |
| Stones, Rocks, and Boulders .....                     | <a href="#">129</a> |

|  |   |
|--|---|
| Surplus and Unsuitable Material .....        | <a href="#">139</a>                       |
| Unsalvageable Material .....                 | <a href="#">112</a>                       |
| Disputed Claims for Extra Compensation ..... | <a href="#">40</a>                        |
| Ditch:                                       |   |
| Cleanout .....                               | <a href="#">137</a>                       |
| Cobble .....                                 | <a href="#">637</a>                       |
| Intercepting .....                           | <a href="#">153</a>                       |
| Paved .....                                  | <a href="#">637</a>                       |
| Divider, Concrete .....                      | <a href="#">538</a>                       |
| Dowel Bar .....                              | <a href="#">302</a>                       |
| Downloading of Bids .....                    | <a href="#">19</a>                        |
| Downspout:                                   |   |
| Bridge Deck .....                            | <a href="#">794</a>                       |
| Headers .....                                | <a href="#">538</a>                       |
| Drainage Marker Post .....                   | <a href="#">795</a>                       |
| Drainage Structure:                          |   |
| Adjust .....                                 | <a href="#">203</a>                       |
| Backfilling .....                            | <a href="#">204</a>                       |
| Cover .....                                  | <a href="#">204</a>                       |
| Cover Plate, Temporary .....                 | <a href="#">202</a>                       |
| Lead, Cleaning .....                         | <a href="#">205</a>                       |
| Precast Units .....                          | <a href="#">203</a>                       |
| Remove .....                                 | <a href="#">117</a>                       |
| Tap .....                                    | <a href="#">205</a>                       |
| Temporary Lowering .....                     | <a href="#">204</a>                       |
| Drain Casting .....                          | <a href="#">520</a> , <a href="#">782</a> |
| Driveway:                                    |   |
| Concrete .....                               | <a href="#">537</a>                       |
| Opening .....                                | <a href="#">541</a>                       |
| Drop Inlet .....                             | <a href="#">207</a>                       |
| Dune Grass Planting .....                    | <a href="#">662</a>                       |
| Dust Control .....                           | <a href="#">65</a>                        |
| Dust Palliative .....                        | <a href="#">945</a>                       |

## E

|   |                     |
|---|---------------------|
| Earth Excavation:                         |                     |
| Earth .....                               | <a href="#">131</a> |
| Foundation .....                          | <a href="#">145</a> |
| Rock .....                                | <a href="#">129</a> |
| Trenching .....                           | <a href="#">176</a> |
| Earth Grade ( <i>definition</i> ) .....   | <a href="#">8</a>   |
| Earth Grade, Trimming and Finishing ..... | <a href="#">138</a> |
| Edge Trimming .....                       | <a href="#">238</a> |

# INDEX

|   |                     |
|---|---------------------|
| Electrical and Lighting .....                             | <a href="#">663</a> |
| Electrical Grounding System.....                          | <a href="#">858</a> |
| Eliminated Items.....                                     | <a href="#">28</a>  |
| Embankment Construction:                                  |                     |
| Controlled Density Method .....                           | <a href="#">135</a> |
| Rock Embankment .....                                     | <a href="#">136</a> |
| Surcharge, Placing, and Removing.....                     | <a href="#">130</a> |
| Swamp Backfill .....                                      | <a href="#">141</a> |
| Twelve Inch Layer Method .....                            | <a href="#">135</a> |
| End Diaphragm .....                                       | <a href="#">511</a> |
| End Header Replacement.....                               | <a href="#">470</a> |
| Engineer ( <i>definition</i> ) .....                      | <a href="#">8</a>   |
| Engineer, Authority of .....                              | <a href="#">30</a>  |
| Engineer Staking.....                                     | <a href="#">39</a>  |
| Environmental Protection, Compliance With Laws .....      | <a href="#">65</a>  |
| Equipment:  |                     |
| Crossing Pavements and Structures .....                   | <a href="#">42</a>  |
| General Requirements .....                                | <a href="#">44</a>  |
| Grounding Conductor .....                                 | <a href="#">670</a> |
| Rental Rates.....   | <a href="#">97</a>  |
| Rental Rates for Idled Equipment .....                    | <a href="#">103</a> |
| Erection of Prestressed Concrete Beams.....               | <a href="#">444</a> |
| Erection of Structural Steel .....                        | <a href="#">428</a> |
| Erosion Control:  |                     |
| Area Limitations.....                                     | <a href="#">150</a> |
| Devices .....   | <a href="#">151</a> |
| Materials .....   | <a href="#">150</a> |
| Time Limitations .....                                    | <a href="#">151</a> |
| Estimate ( <i>definition</i> ) .....                      | <a href="#">8</a>   |
| Estimate:   |                     |
| Biweekly.....   | <a href="#">93</a>  |
| Final.....  | <a href="#">104</a> |
| Plan Quantities .....                                     | <a href="#">87</a>  |
| Progress .....  | <a href="#">94</a>  |
| Examination of Plans, Specifications, and Work Site ..... | <a href="#">16</a>  |
| Excavation:   |                     |
| Earth .....   | <a href="#">131</a> |
| Foundation.....   | <a href="#">145</a> |
| Peat .....  | <a href="#">129</a> |
| Rock.....   | <a href="#">129</a> |
| Rock Foundation .....                                     | <a href="#">145</a> |
| Structure .....   | <a href="#">145</a> |
| Execution and Award of Contract .....                     | <a href="#">22</a>  |

|  |                     |
|--|---------------------|
| Expansion Joint Device.....                              | <a href="#">401</a> |
| Expansion Joints, Constructing:                          |                     |
| Curb and Gutter.....                                     | <a href="#">539</a> |
| Pavement.....  | <a href="#">313</a> |
| Sidewalk.....  | <a href="#">543</a> |
| Structure.....   | <a href="#">400</a> |
| Expansion Joints, Sawing:                                |                     |
| Pavement.....  | <a href="#">313</a> |
| Structure.....   | <a href="#">401</a> |
| Expansive Grout.....                                     | <a href="#">353</a> |
| Explosives, Use of.....                                  | <a href="#">68</a>  |
| Extension of Time ( <i>definition</i> ).....             | <a href="#">8</a>   |
| Extension of Time on Calendar Day or Date Contracts..... | <a href="#">78</a>  |
| Extension of Time on Work Day Contracts.....             | <a href="#">77</a>  |
| Extension of Time, Request for.....                      | <a href="#">80</a>  |
| Extra Work ( <i>definition</i> ).....                    | <a href="#">8</a>   |
| Extra Work.....  | <a href="#">28</a>  |

## F

|                                      |                     |
|--------------------------------------|---------------------|
| Failure to Open to Traffic.....      | <a href="#">82</a>  |
| False Decking.....                   | <a href="#">385</a> |
| Falsework ( <i>definition</i> )..... | <a href="#">8</a>   |
| Falsework for Structures:            |                     |
| Erection.....                        | <a href="#">386</a> |
| Removal.....                         | <a href="#">407</a> |
| Federal Aid Participation.....       | <a href="#">57</a>  |
| Fence:                               |                     |
| Chain Link.....                      | <a href="#">777</a> |
| Clearing for.....                    | <a href="#">113</a> |
| Gate.....                            | <a href="#">777</a> |
| High-Tensile Wire.....               | <a href="#">565</a> |
| Moving and Salvaging.....            | <a href="#">562</a> |
| Post, Wood.....                      | <a href="#">777</a> |
| Post, Steel.....                     | <a href="#">776</a> |
| Protective Fence.....                | <a href="#">562</a> |
| Remove.....                          | <a href="#">122</a> |
| Structure.....                       | <a href="#">565</a> |
| Temporary.....                       | <a href="#">564</a> |
| Woven Wire.....                      | <a href="#">562</a> |
| Fertilizer, Chemical Nutrient.....   | <a href="#">650</a> |
| Fertilizing.....                     | <a href="#">850</a> |
| Field Repair of Damaged Coating..... | <a href="#">518</a> |
| Field Office.....                    | <a href="#">568</a> |



## INDEX

|  |                     |
|--|---------------------|
| Filler Aggregate.....                                | <a href="#">169</a> |
| Filler Wall Concrete.....                            | <a href="#">487</a> |
| Filter Bag, Erosion Control.....                     | <a href="#">152</a> |
| Final Clean Up .....                                 | <a href="#">37</a>  |
| Final Estimate ( <i>definition</i> ) .....           | <a href="#">8</a>   |
| Final Inspection, Acceptance, and Final Payment..... | <a href="#">104</a> |
| Flame Cutting, Structural Steel .....                | <a href="#">419</a> |
| Float ( <i>definition</i> ) .....                    | <a href="#">9</a>   |
| Fly Ash .....  | <a href="#">737</a> |
| Force Account Work.....                              | <a href="#">95</a>  |
| Forest Protection.....                               | <a href="#">67</a>  |
| Forms ( <i>definition</i> ) .....                    | <a href="#">9</a>   |
| Forms for:   |                     |
| Concrete Curb and Gutter .....                       | <a href="#">538</a> |
| Concrete Pavement and Base Course.....               | <a href="#">305</a> |
| Concrete Structure .....                             | <a href="#">386</a> |
| Forms, Permanent Metal Deck .....                    | <a href="#">388</a> |
| Freeway Shoulders .....                              | <a href="#">319</a> |
| Frost Heave Textured Material .....                  | <a href="#">127</a> |
| Furnishing Right-of-Way .....                        | <a href="#">58</a>  |

## G

|  |                     |
|--|---------------------|
| Galvanizing Position Dowels and Anchor Bolts ..... | <a href="#">426</a> |
| Gapping Pavement .....                             | <a href="#">320</a> |
| Geosynthetics:                                     |                     |
| Geocomposites:                                     |                     |
| Net.....   | <a href="#">812</a> |
| PDS.....   | <a href="#">811</a> |
| Wall Drain.....                                    | <a href="#">811</a> |
| Geotextiles:                                       |                     |
| Blanket .....                                      | <a href="#">810</a> |
| Liner .....  | <a href="#">810</a> |
| Separator .....                                    | <a href="#">810</a> |
| Stabilizer .....                                   | <a href="#">811</a> |
| Glare Screen .....                                 | <a href="#">546</a> |
| Glass Beads.....                                   | <a href="#">890</a> |
| Grade and Compact Existing Material .....          | <a href="#">132</a> |
| Grade Separation ( <i>definition</i> ) .....       | <a href="#">9</a>   |
| Grading:   |                     |
| Machine .....                                      | <a href="#">137</a> |
| Winter .....                                       | <a href="#">133</a> |
| Granular Blanket .....                             | <a href="#">137</a> |
| Gravel Access Approach, Erosion Control .....      | <a href="#">153</a> |

|   |                     |
|---|---------------------|
| Gravel Filter Berm, Erosion Control .....   | <a href="#">152</a> |
| Grounding System .....                      | <a href="#">858</a> |
| Grout and Mortar.....                       | <a href="#">353</a> |
| Grouting Cracks by Pressure Injection ..... | <a href="#">479</a> |
| Grouting Under Masonry Plates.....          | <a href="#">481</a> |
| Guard Post.....                             | <a href="#">559</a> |
| Guardrail:                                  |                     |
| Installation .....                          | <a href="#">556</a> |
| Remove .....                                | <a href="#">121</a> |
| Repair of Damaged Galvanized Surfaces ..... | <a href="#">557</a> |
| Salvage.....                                | <a href="#">559</a> |
| Guardrail Materials:                        |                     |
| Beam Elements .....                         | <a href="#">784</a> |
| Hardware .....                              | <a href="#">785</a> |
| Steel Posts .....                           | <a href="#">786</a> |
| Wood Posts .....                            | <a href="#">823</a> |
| Gutter, Remove.....                         | <a href="#">120</a> |

## H

|  |                     |
|--|---------------------|
| Hand Chipping .....                          | <a href="#">467</a> |
| Handhole.....                                | <a href="#">861</a> |
| Handling and Transporting Materials .....    | <a href="#">52</a>  |
| Hand Patching.....                           | <a href="#">239</a> |
| Hanger Assembly.....                         | <a href="#">491</a> |
| Hardware, Miscellaneous.....                 | <a href="#">448</a> |
| Hauling Equipment for HMA Mixtures.....      | <a href="#">235</a> |
| Hauling on Local Roads and Streets .....     | <a href="#">68</a>  |
| Haul Routes Crossing Railroads.....          | <a href="#">69</a>  |
| Haul Routes for Borrow.....                  | <a href="#">49</a>  |
| Hazardous Materials, Control of .....        | <a href="#">66</a>  |
| Headers, Slope Paving .....                  | <a href="#">634</a> |
| Headwalls for Box Culverts.....              | <a href="#">187</a> |
| Health and Safety Requirements .....         | <a href="#">35</a>  |
| Heating and Housing Structure Concrete ..... | <a href="#">400</a> |
| Highway ( <i>definition</i> ).....           | <a href="#">9</a>   |
| Historical and Archaeological Findings.....  | <a href="#">58</a>  |
| Holidays ( <i>definition</i> ).....          | <a href="#">9</a>   |
| Hot Mix Asphalt (HMA):                       |                     |
| Approach .....                               | <a href="#">234</a> |
| Base Course, Placing.....                    | <a href="#">240</a> |
| Base Crushing and Shaping.....               | <a href="#">170</a> |
| Curb .....                                   | <a href="#">550</a> |
| Mixtures-Plant Mixed.....                    | <a href="#">232</a> |

# INDEX

|  |                     |
|--|---------------------|
| Patches, Remove .....  | <a href="#">239</a> |
| Pavers.....  | <a href="#">235</a> |
| Placing.....   | <a href="#">240</a> |
| Plants, Environmental Protection .....                         | <a href="#">65</a>  |
| Rollers.....   | <a href="#">236</a> |
| Shoulders, Replacing .....                                     | <a href="#">336</a> |
| Surface, Remove.....   | <a href="#">239</a> |
| Transporting .....   | <a href="#">240</a> |
| Hot-Poured Rubber-Asphalt:                                     |                     |
| for Pavement Joints.....                                       | <a href="#">304</a> |
| Hot Weather Concrete (see Weather and Temperature Limitations) |                     |
| Hydrodemolition .....  | <a href="#">469</a> |

## I

|   |                     |
|---|---------------------|
| Idled Equipment and Labor, Payment for .....          | <a href="#">103</a> |
| Increased or Decreased Quantities, Payment for.....   | <a href="#">92</a>  |
| Indemnification, Damage Liability and Insurance ..... | <a href="#">59</a>  |
| Inlets, Constructing .....                            | <a href="#">203</a> |
| Inlet Protection, Erosion Control .....               | <a href="#">152</a> |
| Inspection:   |                     |
| Department.....                                       | <a href="#">31</a>  |
| Federal.....  | <a href="#">57</a>  |
| Final.....  | <a href="#">104</a> |
| Inspector ( <i>definition</i> ).....                  | <a href="#">9</a>   |
| Inspector, Authority and Duties of.....               | <a href="#">30</a>  |
| Insulated Forms for Structures.....                   | <a href="#">398</a> |
| Insulation:   |                     |
| Blanket.....  | <a href="#">754</a> |
| Polystyrene.....                                      | <a href="#">755</a> |
| Insurance:  |                     |
| Bodily Injury and Property Damage.....                | <a href="#">59</a>  |
| Indemnification .....                                 | <a href="#">59</a>  |
| Notice.....   | <a href="#">61</a>  |
| Owner's Protective Liability .....                    | <a href="#">60</a>  |
| Workers' Compensation .....                           | <a href="#">59</a>  |
| Interpretation of Bid Items in the Proposal.....      | <a href="#">16</a>  |
| Irregular Proposals.....                              | <a href="#">17</a>  |

## J

|                                 |                     |
|---------------------------------|---------------------|
| Jacking Pipe.....               | <a href="#">188</a> |
| Joint and Crack, Cleanout.....  | <a href="#">248</a> |
| Joint Construction:             |                     |
| Bulkhead Bars, Bolts, etc. .... | <a href="#">840</a> |

|   |                     |
|---|---------------------|
| Dowel Bars .....                          | <a href="#">838</a> |
| End-of-Pour Hook Bolts and Tie Bars ..... | <a href="#">840</a> |
| Epoxy Binder for Joint Spalls.....        | <a href="#">837</a> |
| Epoxy Mortar and Grout .....              | <a href="#">837</a> |
| Epoxy Resin Adhesive.....                 | <a href="#">838</a> |
| Expansion Anchors and Bolts .....         | <a href="#">841</a> |
| Fiber Joint Filler .....                  | <a href="#">836</a> |
| Hot-Poured Joint Sealant .....            | <a href="#">836</a> |
| Lane Ties .....                           | <a href="#">840</a> |
| Repair, Longitudinal.....                 | <a href="#">316</a> |
| Waterproofing .....                       | <a href="#">841</a> |
| Joints in:                                |                     |
| Concrete Curb and Gutter .....            | <a href="#">539</a> |
| Concrete Pavement:                        |                     |
| Cleaning .....                            | <a href="#">317</a> |
| Constructing:                             |                     |
| Longitudinal .....                        | <a href="#">307</a> |
| Transverse.....                           | <a href="#">308</a> |
| Patching .....                            | <a href="#">314</a> |
| Sawing .....                              | <a href="#">312</a> |
| Sealing .....                             | <a href="#">317</a> |
| Concrete Structure .....                  | <a href="#">400</a> |
| HMA Pavement .....                        | <a href="#">241</a> |
| Pipe Culvert.....                         | <a href="#">789</a> |
| Sewer.....                                | <a href="#">789</a> |
| Sidewalk .....                            | <a href="#">543</a> |
| Underdrain.....                           | <a href="#">211</a> |
| Joint Types:                              |                     |
| Contraction .....                         | <a href="#">313</a> |
| Expansion.....                            | <a href="#">313</a> |
| <b>L</b>                                  |                     |
| Laboratory ( <i>definition</i> ) .....    | <a href="#">9</a>   |
| Labor Dispute ( <i>definition</i> ).....  | <a href="#">9</a>   |
| Lane Tie .....                            | <a href="#">301</a> |
| Land Monuments and Property Corner.....   | <a href="#">58</a>  |
| Landscaping:                              |                     |
| Bracing and Guying.....                   | <a href="#">644</a> |
| Nursery Stock .....                       | <a href="#">848</a> |
| Prepared Soil.....                        | <a href="#">640</a> |
| Seasonal Limitations .....                | <a href="#">641</a> |
| Tree Wrap.....                            | <a href="#">643</a> |
| Watering and Cultivating .....            | <a href="#">643</a> |

# INDEX

|  |                     |
|--|---------------------|
| Weed Control.....                                      | <a href="#">657</a> |
| Landscape Mowing.....                                  | <a href="#">660</a> |
| Latex Concrete Surface, Remove.....                    | <a href="#">483</a> |
| Laws to be Observed.....                               | <a href="#">55</a>  |
| Leaching Basins.....                                   | <a href="#">202</a> |
| Legal Relations and Responsibilities to Public.....    | <a href="#">55</a>  |
| Legal Rights, No Waiver of.....                        | <a href="#">64</a>  |
| Liability of Public Officials.....                     | <a href="#">64</a>  |
| Licenses and Permits.....                              | <a href="#">56</a>  |
| Lien Bond ( <i>definition</i> ).....                   | <a href="#">9</a>   |
| Lighted Arrow:   |                     |
| Equipment Requirements.....                            | <a href="#">938</a> |
| Use of.....  | <a href="#">605</a> |
| Lighting for Nighttime Work.....                       | <a href="#">619</a> |
| Light Standard:  |                     |
| Arm.....   | <a href="#">674</a> |
| Foundation.....  | <a href="#">671</a> |
| Shaft.....   | <a href="#">674</a> |
| Limitations of Operations.....                         | <a href="#">72</a>  |
| Limits of Earth Disturbance ( <i>definition</i> )..... | <a href="#">10</a>  |
| Lines, Grades, and Elevations.....                     | <a href="#">39</a>  |
| Liquidated Damages ( <i>definition</i> ).....          | <a href="#">10</a>  |
| Liquidated Damages.....                                | <a href="#">82</a>  |
| Local Traffic ( <i>definition</i> ).....               | <a href="#">10</a>  |
| Louver.....  | <a href="#">698</a> |
| Luminaire.....   | <a href="#">867</a> |

## M

|  |                     |
|--|---------------------|
| Machine Finishing of Structure Concrete.....         | <a href="#">402</a> |
| Machine Grading.....                                 | <a href="#">137</a> |
| Magnetic Particle Inspection.....                    | <a href="#">870</a> |
| Mailbox Post.....                                    | <a href="#">559</a> |
| Maintaining Traffic.....                             | <a href="#">616</a> |
| Maintenance During Construction.....                 | <a href="#">36</a>  |
| Maintenance Gravel.....                              | <a href="#">173</a> |
| Major and Minor Pay Items ( <i>definition</i> )..... | <a href="#">10</a>  |
| Manholes.....  | <a href="#">202</a> |
| Marketable Timber.....                               | <a href="#">111</a> |
| Masonry and Concrete Structures, Remove.....         | <a href="#">120</a> |
| Masonry Drainage Structures.....                     | <a href="#">203</a> |
| Masonry Plate, Grout.....                            | <a href="#">481</a> |
| Material, Control of.....                            | <a href="#">48</a>  |
| Materially Unbalance Bid ( <i>definition</i> ).....  | <a href="#">10</a>  |

|  |                     |
|--|---------------------|
| Material Source List .....   | <a href="#">48</a>  |
| Mathematically Unbalanced Bid ( <i>definition</i> ).....             | <a href="#">11</a>  |
| Maximum Unit Weight or Maximum Density ( <i>definition</i> ).....    | <a href="#">11</a>  |
| Measurement of Quantities.....                                       | <a href="#">87</a>  |
| Median ( <i>definition</i> ).....                                    | <a href="#">11</a>  |
| Membrane, Preformed Waterproofing .....                              | <a href="#">450</a> |
| Michigan Manual of Uniform Traffic Control Devices.....              | <a href="#">571</a> |
| Micro-Surface.....   | <a href="#">745</a> |
| Minor Traffic Devices .....  | <a href="#">625</a> |
| Miscellaneous Metals:  |                     |
| Bronze or Copper .....   | <a href="#">782</a> |
| Sheet Lead .....   | <a href="#">783</a> |
| Mobilization .....   | <a href="#">107</a> |
| Monument Box.....  | <a href="#">707</a> |
| Mortar and Concrete Patching, Repair, and Resurfacing Mixtures ..... | <a href="#">357</a> |
| Mortar and Grout.....  | <a href="#">353</a> |
| Mowing.....  | <a href="#">660</a> |
| Mulch.....   | <a href="#">852</a> |
| Mulching:  |                     |
| Trees, Shrubs, and Plants .....                                      | <a href="#">642</a> |
| Seeded Areas.....  | <a href="#">654</a> |

## N

|   |                     |
|---|---------------------|
| Navigable Waters, Work Over .....                     | <a href="#">68</a>  |
| Net Prequalification ( <i>definition</i> ).....       | <a href="#">11</a>  |
| Nighttime Casting of Concrete .....                   | <a href="#">397</a> |
| Night Work, Lighting for .....                        | <a href="#">619</a> |
| Nonconforming Materials .....                         | <a href="#">52</a>  |
| Non-Controlling Operation ( <i>definition</i> ) ..... | <a href="#">11</a>  |
| Non-Shrinking Mortar and Grout.....                   | <a href="#">353</a> |
| Notice of Award ( <i>definition</i> ).....            | <a href="#">11</a>  |
| No Waiver of Legal Rights .....                       | <a href="#">64</a>  |

## O

|  |                     |
|--|---------------------|
| Obliterating Roadway.....                                  | <a href="#">149</a> |
| Open-Graded Drainage Course.....                           | <a href="#">165</a> |
| Open-Graded Underdrain .....                               | <a href="#">212</a> |
| Opening of Proposals .....                                 | <a href="#">19</a>  |
| Operations, Limitations of .....                           | <a href="#">72</a>  |
| Outlet Endings for Underdrains.....                        | <a href="#">212</a> |
| Overband Crack Fill .....                                  | <a href="#">252</a> |
| Overhead Lane Assignment Structure.....                    | <a href="#">579</a> |
| Overloads Crossing Existing Pavements and Structures ..... | <a href="#">45</a>  |

# INDEX

## P

|  |                     |
|--|---------------------|
| Part-Width Intersection Construction .....                 | <a href="#">616</a> |
| Patching:  |                     |
| Longitudinal Joint, Pavement .....                         | <a href="#">316</a> |
| Transverse Joint, Pavement.....                            | <a href="#">308</a> |
| Transverse Joint, Structure .....                          | <a href="#">401</a> |
| Patching Mortar or Concrete.....                           | <a href="#">357</a> |
| Patented Processes and Materials .....                     | <a href="#">57</a>  |
| Paved Ditch.....   | <a href="#">637</a> |
| Pavement, Limitations on Construction Equipment Using..... | <a href="#">42</a>  |
| Pavement Marking:  |                     |
| Application Rates.....                                     | <a href="#">591</a> |
| Call Back.....   | <a href="#">596</a> |
| Delayed Acceptance.....                                    | <a href="#">599</a> |
| For Traffic Control (Temporary).....                       | <a href="#">609</a> |
| Permanent .....  | <a href="#">588</a> |
| Raised Pavement Markers, Remove.....                       | <a href="#">597</a> |
| Removal.....   | <a href="#">615</a> |
| Pavement Marking Materials:                                |                     |
| Glass Beads .....  | <a href="#">890</a> |
| Overlay Cold Plastic .....                                 | <a href="#">890</a> |
| Raised Pavement Markers .....                              | <a href="#">937</a> |
| Regular Dry .....  | <a href="#">891</a> |
| Sprayable Thermoplastic.....                               | <a href="#">891</a> |
| Temporary .....  | <a href="#">937</a> |
| Thermoplastic.....   | <a href="#">890</a> |
| Type NR, Paint .....                                       | <a href="#">937</a> |
| Type NR, Tape .....  | <a href="#">937</a> |
| Type R .....   | <a href="#">937</a> |
| Waterborne.....  | <a href="#">891</a> |
| Pavement Repair:   |                     |
| Nonreinforced Concrete .....                               | <a href="#">340</a> |
| Reinforced Concrete.....                                   | <a href="#">340</a> |
| Remove .....   | <a href="#">330</a> |
| Pavement Structure ( <i>definition</i> ) .....             | <a href="#">11</a>  |
| Pavers, HMA .....  | <a href="#">235</a> |
| Pay Item ( <i>definition</i> ) .....                       | <a href="#">11</a>  |
| Payment:   |                     |
| Eliminated Items .....                                     | <a href="#">28</a>  |
| Extra Work.....  | <a href="#">28</a>  |
| Final.....   | <a href="#">104</a> |
| Force Account Work.....                                    | <a href="#">95</a>  |
| Idled Equipment.....                                       | <a href="#">103</a> |

|  |                     |
|--|---------------------|
| Increased Material Cost.....                             | <a href="#">103</a> |
| Increased or Decreased Quantities.....                   | <a href="#">92</a>  |
| Measurement and.....                                     | <a href="#">87</a>  |
| Partial.....   | <a href="#">92</a>  |
| Scope of.....  | <a href="#">92</a>  |
| Source of Supply and Carrier Rates.....                  | <a href="#">104</a> |
| Stockpiled Materials .....                               | <a href="#">93</a>  |
| Pedestal:  |                     |
| Aluminum.....  | <a href="#">915</a> |
| Foundation.....  | <a href="#">689</a> |
| Pedestrian Signal.....                                   | <a href="#">686</a> |
| Performance Bond ( <i>definition</i> ) .....             | <a href="#">11</a>  |
| Performance of the Work.....                             | <a href="#">26</a>  |
| Permit Fees Required by Local Governmental Agencies..... | <a href="#">56</a>  |
| Permits and Licenses.....                                | <a href="#">56</a>  |
| Personal Liability of Public Officials .....             | <a href="#">64</a>  |
| Pile .....   | <a href="#">366</a> |
| Pile, Drilled .....                                      | <a href="#">575</a> |
| Pile Driving Equipment.....                              | <a href="#">368</a> |
| Pile Point.....  | <a href="#">771</a> |
| Piling:  |                     |
| Foundations.....   | <a href="#">366</a> |
| Steel Sheet.....   | <a href="#">361</a> |
| Pin and Hanger Replacement.....                          | <a href="#">491</a> |
| Pins and Link Plates for Steel Bridges.....              | <a href="#">489</a> |
| Pipe Railing.....  | <a href="#">458</a> |
| Pipe Sleeve (Socket).....                                | <a href="#">392</a> |
| Plan Error .....   | <a href="#">16</a>  |
| Plan Grade ( <i>definition</i> ) .....                   | <a href="#">11</a>  |
| Plan Quantity ( <i>definition</i> ).....                 | <a href="#">11</a>  |
| Plans ( <i>definition</i> ) .....                        | <a href="#">11</a>  |
| Plans and Specifications:                                |                     |
| Bidders Examination of.....                              | <a href="#">16</a>  |
| Coordination of .....                                    | <a href="#">34</a>  |
| Plans and Working Drawings:                              |                     |
| Conformity With .....                                    | <a href="#">33</a>  |
| Contractor Submission .....                              | <a href="#">32</a>  |
| Deviations from.....                                     | <a href="#">33</a>  |
| Plastic Drum.....  | <a href="#">933</a> |
| Pole, Wood.....  | <a href="#">678</a> |
| Pollution Control, Air and Water.....                    | <a href="#">65</a>  |
| Portland Cement Concrete Mixture.....                    | <a href="#">287</a> |
| Portland Cement Concrete Pavement .....                  | <a href="#">287</a> |



# INDEX

## Post:

|  |                     |
|--|---------------------|
| Delineator .....   | <a href="#">572</a> |
| Mailbox .....  | <a href="#">559</a> |
| Steel.....   | <a href="#">776</a> |
| Wood .....   | <a href="#">777</a> |
| Post Tensioning .....  | <a href="#">445</a> |
| Prebore, Foundation Piling .....                                   | <a href="#">372</a> |
| Preconstruction Requirements:                                      |                     |
| Progress Schedule .....  | <a href="#">74</a>  |
| Safety and Health .....  | <a href="#">35</a>  |
| Preparation of Bids.....   | <a href="#">17</a>  |
| Prequalification of Contractors ( <i>definition</i> ) .....        | <a href="#">12</a>  |
| Prequalification of Bidders .....                                  | <a href="#">16</a>  |
| Prestressed Concrete Beams .....                                   | <a href="#">438</a> |
| Prime Coat .....   | <a href="#">842</a> |
| Progress and Partial Payments .....                                | <a href="#">92</a>  |
| Progress Clause ( <i>definition</i> ).....                         | <a href="#">12</a>  |
| Progress Estimate ( <i>definition</i> ).....                       | <a href="#">8</a>   |
| Progress Schedule Content .....                                    | <a href="#">74</a>  |
| Progress Schedule ( <i>definition</i> ).....                       | <a href="#">12</a>  |
| Project ( <i>definition</i> ) .....                                | <a href="#">12</a>  |
| Project Cleanup.....   | <a href="#">158</a> |
| Project Limits ( <i>definition</i> ).....                          | <a href="#">12</a>  |
| Property Corners.....  | <a href="#">58</a>  |
| Property, Protection and Restoration of.....                       | <a href="#">58</a>  |
| Proposal ( <i>definition</i> ) .....                               | <a href="#">12</a>  |
| Prosecution and Progress.....                                      | <a href="#">71</a>  |
| Protecting Plant Life .....  | <a href="#">111</a> |
| Protection and Restoration of Property.....                        | <a href="#">58</a>  |
| Protection of Uncured HMA Pavements .....                          | <a href="#">621</a> |
| Protective Coating for Structures, Water Repellent Treatment ..... | <a href="#">480</a> |
| Protective Cover and Waterproofing.....                            | <a href="#">450</a> |
| Protective Liability, Owners.....                                  | <a href="#">60</a>  |
| Protective Shield, Utility Pipe .....                              | <a href="#">509</a> |
| Public Officials, Personal Liability .....                         | <a href="#">64</a>  |
| Public Utilities ( <i>see</i> Utilities, Public)                   |                     |
| Pump Station.....  | <a href="#">216</a> |
| Pushbutton, Pedestrian Signal.....                                 | <a href="#">688</a> |

## Q

|   |                    |
|---|--------------------|
| Qualified Products List ( <i>definition</i> ) ..... | <a href="#">12</a> |
| Quality and Source of Supply .....                  | <a href="#">48</a> |
| Quality Assurance Acceptance Program .....          | <a href="#">54</a> |

|   |                     |
|---|---------------------|
| Quality Assurance Testing:                                  |                     |
| Concrete .....  | <a href="#">345</a> |
| HMA.....  | <a href="#">269</a> |
| Quality Control Plans:                                      |                     |
| Contractor Staking.....                                     | <a href="#">39</a>  |
| Concrete .....  | <a href="#">344</a> |
| HMA.....  | <a href="#">245</a> |
| Quality Index Analysis.....                                 | <a href="#">54</a>  |
| Quantities:   |                     |
| Estimate of.....  | <a href="#">16</a>  |
| Increased or Decreased .....                                | <a href="#">92</a>  |
| Measurement of.....   | <a href="#">87</a>  |
| Miscellaneous Estimate of.....                              | <a href="#">50</a>  |
| Payment for Increased or Decreased.....                     | <a href="#">92</a>  |
| <b>R</b>  |                     |
| Radiographic Examination of Welds .....                     | <a href="#">422</a> |
| Railing for Steps.....                                      | <a href="#">543</a> |
| Railroad Crossing for Haul Purposes.....                    | <a href="#">69</a>  |
| Railroad Track, Remove .....                                | <a href="#">121</a> |
| Raised Pavement Marker:                                     |                     |
| Remove .....  | <a href="#">597</a> |
| Retroreflective .....                                       | <a href="#">588</a> |
| Temporary .....   | <a href="#">611</a> |
| Recycled Asphalt Pavement (RAP) .....                       | <a href="#">234</a> |
| Reflective Conspicuity Tape .....                           | <a href="#">622</a> |
| Reflective Marker, Bridge Barrier.....                      | <a href="#">460</a> |
| Reflectorized Washers.....                                  | <a href="#">786</a> |
| Reinforcing Steel:  |                     |
| Bars for Pavements.....                                     | <a href="#">768</a> |
| Bars for Structures.....                                    | <a href="#">767</a> |
| Dowels, Bars for Curb, Barriers for Walls.....              | <a href="#">768</a> |
| Prestressing Strand.....                                    | <a href="#">768</a> |
| Tendons for Boxbeams .....                                  | <a href="#">769</a> |
| Welded Wire Fabric.....                                     | <a href="#">768</a> |
| Reinforcing Steel-Construction:                             |                     |
| Mechanical Splice.....                                      | <a href="#">472</a> |
| Pavement.....   | <a href="#">307</a> |
| Splicing .....  | <a href="#">391</a> |
| Structure .....   | <a href="#">390</a> |
| Rejection of Proposals .....                                | <a href="#">19</a>  |
| Removal of Unauthorized Work.....                           | <a href="#">34</a>  |
| Removing and Salvaging Sign Supports, and Foundations ..... | <a href="#">582</a> |

# INDEX

|   |   |
|---|---|
| Removing Miscellaneous Structure and Material ..... | <a href="#">120</a>                       |
| Removing Structure and Retaining Wall .....         | <a href="#">121</a>                       |
| Rental, Force Account Equipment .....               | <a href="#">97</a>                        |
| Repairing Galvanized Surfaces:                      |   |
| Culverts.....                                       | <a href="#">185</a>                       |
| Guardrail Beams.....                                | <a href="#">557</a>                       |
| Sewers.....   | <a href="#">195</a>                       |
| Sign Supports .....                                 | <a href="#">572</a>                       |
| Structural Steel.....                               | <a href="#">518</a>                       |
| Resawing and Sealing Pavement Joints .....          | <a href="#">338</a>                       |
| Restoration and Protection of Property.....         | <a href="#">58</a>                        |
| Retaining Walls:                                    |   |
| Concrete .....                                      | <a href="#">383</a>                       |
| Remove .....  | <a href="#">121</a>                       |
| Ride Quality.....                                   | <a href="#">310</a>                       |
| Right-of-Way ( <i>definition</i> ) .....            | <a href="#">13</a>                        |
| Right-of-Way, Furnishing .....                      | <a href="#">58</a>                        |
| Riprap.....   | <a href="#">634</a> , <a href="#">844</a> |
| Roadbed ( <i>definition</i> ).....                  | <a href="#">13</a>                        |
| Road Closures .....                                 | <a href="#">606</a>                       |
| Roadside ( <i>definition</i> ) .....                | <a href="#">13</a>                        |
| Roadway ( <i>definition</i> ) .....                 | <a href="#">13</a>                        |
| Roadway Earthwork.....                              | <a href="#">127</a>                       |
| Roadway Foundation, Preparing .....                 | <a href="#">128</a>                       |
| Rodent Screens .....                                | <a href="#">795</a>                       |
| Royalties .....                                     | <a href="#">57</a>                        |
| Rubblizing PCC Pavement .....                       | <a href="#">166</a>                       |

## S

|  |                     |
|--|---------------------|
| Safety and Health Requirements .....     | <a href="#">35</a>  |
| Salvaging:                               |                     |
| Guardrail.....                           | <a href="#">559</a> |
| Material.....                            | <a href="#">128</a> |
| Sign.....                                | <a href="#">582</a> |
| Sign Support.....                        | <a href="#">582</a> |
| Structure .....                          | <a href="#">121</a> |
| Timber.....                              | <a href="#">111</a> |
| Topsoil .....                            | <a href="#">128</a> |
| Sampling Material .....                  | <a href="#">50</a>  |
| Sand and Stone Bag, Erosion Control..... | <a href="#">152</a> |
| Sand Fence, Erosion Control.....         | <a href="#">153</a> |
| Sanitary Provisions .....                | <a href="#">58</a>  |

|  |                     |
|--|---------------------|
| Saw Cut:   |                     |
| Intermediate.....  | <a href="#">339</a> |
| Rubblize.....  | <a href="#">166</a> |
| Sawing and Sealing Cracks.....                                       | <a href="#">330</a> |
| Scales:  |                     |
| for Concrete Mixtures.....   | <a href="#">291</a> |
| for HMA Mixtures.....  | <a href="#">239</a> |
| Inspection of.....   | <a href="#">91</a>  |
| Scarifying.....  | <a href="#">467</a> |
| Scope of Payment.....  | <a href="#">92</a>  |
| Scope of the Work.....   | <a href="#">26</a>  |
| Sealing Joints.....  | <a href="#">317</a> |
| Seasonal Limitation ( <i>definition</i> ).....                       | <a href="#">13</a>  |
| Seasonal Limitations ( <i>see Weather and Seasonal Limitations</i> ) |                     |
| Seasonal Suspension ( <i>definition</i> ).....                       | <a href="#">13</a>  |
| Sedimentation Control.....   | <a href="#">150</a> |
| Sediment Basin, Erosion Control.....                                 | <a href="#">151</a> |
| Sediment Trap, Erosion Control.....                                  | <a href="#">151</a> |
| Seeding.....   | <a href="#">650</a> |
| Seeding Mixtures.....  | <a href="#">852</a> |
| Segregation ( <i>definition</i> ).....                               | <a href="#">13</a>  |
| Sewer:   |                     |
| Bedding.....   | <a href="#">195</a> |
| Bulkheads.....   | <a href="#">197</a> |
| Concrete Pipe.....   | <a href="#">196</a> |
| Excavation.....  | <a href="#">195</a> |
| Mandrel Testing.....   | <a href="#">195</a> |
| Pipe Jacked in Place.....  | <a href="#">197</a> |
| Plastic Pipe.....  | <a href="#">196</a> |
| Remove.....  | <a href="#">119</a> |
| Repair of Coating.....   | <a href="#">195</a> |
| Taps.....  | <a href="#">196</a> |
| Video Inspection.....  | <a href="#">197</a> |
| Watertight Joints.....   | <a href="#">789</a> |
| Shared Use Path.....   | <a href="#">554</a> |
| Shear Developers.....  | <a href="#">773</a> |
| Sheet Lead.....  | <a href="#">783</a> |
| Sheet Piling.....  | <a href="#">361</a> |
| Shop Plans ( <i>see Plans and Working Drawings</i> )                 |                     |
| Shotcrete.....   | <a href="#">450</a> |
| Shoulder ( <i>definition</i> ).....                                  | <a href="#">13</a>  |
| Shoulder Construction:   |                     |
| Aggregate.....   | <a href="#">176</a> |

# INDEX

|  |   |
|--|---|
| Concrete .....   | <a href="#">301</a>                       |
| HMA.....   | <a href="#">243</a>                       |
| Shoulder Corrugation (Rumble Strip).....                           | <a href="#">711</a>                       |
| Shoulder, Freeway.....   | <a href="#">319</a>                       |
| Shrubs, Planting.....  | <a href="#">642</a>                       |
| Sidewalk ( <i>definition</i> ).....                                | <a href="#">13</a>                        |
| Sidewalk:  |   |
| Construction .....   | <a href="#">542</a>                       |
| Removal .....  | <a href="#">120</a>                       |
| Sidewalk Ramp .....  | <a href="#">542</a>                       |
| Sign:  |   |
| Band .....   | <a href="#">573</a>                       |
| Cover .....  | <a href="#">934</a>                       |
| Department Supplied.....   | <a href="#">581</a>                       |
| Paddles for Traffic Regulators.....                                | <a href="#">944</a>                       |
| Permanent.....   | <a href="#">571</a>                       |
| Portable Changeable Message .....                                  | <a href="#">940</a>                       |
| Post, Steel .....  | <a href="#">886</a>                       |
| Post, Wood.....  | <a href="#">887</a>                       |
| Remove and Replace .....   | <a href="#">614</a>                       |
| Salvage.....   | <a href="#">582</a>                       |
| Support .....  | <a href="#">880</a>                       |
| Temporary .....  | <a href="#">933</a>                       |
| Traffic.....   | <a href="#">880</a>                       |
| Sign Connection, Bridge Mounted .....                              | <a href="#">579</a>                       |
| Significant Changes in the Character of the Work.....              | <a href="#">26</a>                        |
| Siltation and Water Pollution, Control of .....                    | <a href="#">66</a> , <a href="#">150</a>  |
| Silt Fence, Erosion Control .....                                  | <a href="#">152</a> , <a href="#">811</a> |
| Sleeves Placed in Structures .....                                 | <a href="#">392</a>                       |
| Sleeves, Soil and Bearing Plates .....                             | <a href="#">785</a>                       |
| Slope:   |   |
| Class A, B, C .....  | <a href="#">138</a>                       |
| Paving.....  | <a href="#">633</a> , <a href="#">835</a> |
| Protection.....  | <a href="#">633</a>                       |
| Slurry Seal.....   | <a href="#">279</a>                       |
| Sodding.....   | <a href="#">653</a>                       |
| Soil Erosion and Sedimentation Control .....                       | <a href="#">150</a>                       |
| Soil Notations .....   | <a href="#">127</a>                       |
| Sound Earth .....  | <a href="#">127</a>                       |
| Source of Steel and Iron .....                                     | <a href="#">53</a>                        |
| Source of Supply and Carrier Rates on Construction Materials ..... | <a href="#">104</a>                       |
| Spall Repair.....  | <a href="#">314</a>                       |
| Span Wire .....  | <a href="#">686</a>                       |

|  |                     |
|--|---------------------|
| Special Provisions ( <i>definition</i> ).....        | <a href="#">14</a>  |
| Specialty Classifications ( <i>definition</i> )..... | <a href="#">13</a>  |
| Specifications ( <i>definition</i> ).....            | <a href="#">13</a>  |
| Specifications and Plans, Coordination of .....      | <a href="#">34</a>  |
| Specifications, Examination of .....                 | <a href="#">16</a>  |
| Spillway, Concrete .....                             | <a href="#">538</a> |
| Staking:   |                     |
| Contractor Staking.....                              | <a href="#">39</a>  |
| Engineer Staking .....                               | <a href="#">39</a>  |
| Standard Plans ( <i>definition</i> ).....            | <a href="#">11</a>  |
| Standard Specifications ( <i>definition</i> ) .....  | <a href="#">13</a>  |
| State ( <i>definition</i> ).....                     | <a href="#">14</a>  |
| Steel:   |                     |
| Coating .....  | <a href="#">501</a> |
| Post.....  | <a href="#">776</a> |
| Rail Tubing .....                                    | <a href="#">783</a> |
| Sheet Piling .....                                   | <a href="#">361</a> |
| Structure, Cleaning.....                             | <a href="#">501</a> |
| Temporary Supports.....                              | <a href="#">488</a> |
| Stenciling Pavement .....                            | <a href="#">311</a> |
| Stepping Side Slopes.....                            | <a href="#">132</a> |
| Steps, Concrete .....                                | <a href="#">542</a> |
| Stockpiled Material, Payment for .....               | <a href="#">93</a>  |
| Stone Disposal .....                                 | <a href="#">129</a> |
| Storage of Materials.....                            | <a href="#">51</a>  |
| Storm Sewer ( <i>see</i> Sewer)                      |                     |
| Strain Pole.....                                     | <a href="#">913</a> |
| Structural Crack Repair.....                         | <a href="#">479</a> |
| Structural Concrete:                                 |                     |
| Forming.....   | <a href="#">397</a> |
| Low Temperature Protection .....                     | <a href="#">399</a> |
| Night Casting.....                                   | <a href="#">397</a> |
| Work Progress Specimens .....                        | <a href="#">350</a> |
| Structural Materials:                                |                     |
| Bolts, Nuts, and Washers .....                       | <a href="#">786</a> |
| Coating Systems .....                                | <a href="#">842</a> |
| Elastomeric Bearings.....                            | <a href="#">841</a> |
| Foundation Piles.....                                | <a href="#">771</a> |
| Pins and Link Plates.....                            | <a href="#">772</a> |
| Pins and Link Plate Washers .....                    | <a href="#">772</a> |
| Shear Developers.....                                | <a href="#">773</a> |
| Structural Steel.....                                | <a href="#">770</a> |

# INDEX

## Structural Steel Construction:

|   |                     |
|---|---------------------|
| Erection.....   | <a href="#">428</a> |
| Welding, Field.....                                   | <a href="#">431</a> |
| Welding, Shop .....                                   | <a href="#">422</a> |
| Welds, Testing of .....                               | <a href="#">422</a> |
| Structure ( <i>see also</i> Bridge):                  |                     |
| Backfill .....  | <a href="#">146</a> |
| Embankment .....                                      | <a href="#">136</a> |
| Excavation and Backfill.....                          | <a href="#">145</a> |
| Limitation on Equipment Crossing.....                 | <a href="#">42</a>  |
| Name Plates .....                                     | <a href="#">409</a> |
| Rehabilitation: Remove Portions .....                 | <a href="#">462</a> |
| Remove .....  | <a href="#">120</a> |
| Timber.....   | <a href="#">446</a> |
| Stump, Remove .....                                   | <a href="#">115</a> |
| Subbase ( <i>definition</i> ) .....                   | <a href="#">14</a>  |
| Subbase:  |                     |
| Construction .....                                    | <a href="#">161</a> |
| Underdrain.....                                       | <a href="#">210</a> |
| Subcontract ( <i>definition</i> ) .....               | <a href="#">14</a>  |
| Subcontracting of Contract Work .....                 | <a href="#">71</a>  |
| Subcontractor ( <i>definition</i> ).....              | <a href="#">14</a>  |
| Subgrade ( <i>definition</i> ).....                   | <a href="#">14</a>  |
| Subgrade:   |                     |
| Manipulation .....                                    | <a href="#">131</a> |
| Undercutting .....                                    | <a href="#">130</a> |
| Underdrain.....                                       | <a href="#">210</a> |
| Subletting Contract Work to DBE.....                  | <a href="#">24</a>  |
| Substructure ( <i>definition</i> ).....               | <a href="#">14</a>  |
| Substructure Concrete .....                           | <a href="#">398</a> |
| Superstructure ( <i>definition</i> ).....             | <a href="#">14</a>  |
| Superstructure Concrete.....                          | <a href="#">399</a> |
| Supplemental Specification ( <i>definition</i> )..... | <a href="#">13</a>  |
| Support:  |                     |
| Column, Temporary.....                                | <a href="#">490</a> |
| Suspension, Temporary .....                           | <a href="#">490</a> |
| Temporary .....                                       | <a href="#">488</a> |
| Surcharge, Placing and Removing .....                 | <a href="#">130</a> |
| Surety ( <i>definition</i> ).....                     | <a href="#">14</a>  |
| Surface Course ( <i>definition</i> ) .....            | <a href="#">14</a>  |
| Surplus and Unsuitable Material Disposal .....        | <a href="#">139</a> |
| Suspensions of Work Ordered by the Engineer .....     | <a href="#">27</a>  |
| Swamp Backfill.....                                   | <a href="#">129</a> |

## T

Temperature Limitations (see Weather and Seasonal Limitations)

Temporary:

|  |   |
|--|---|
| Concrete Barrier .....                   | <a href="#">606</a> , <a href="#">935</a> |
| Guardrail .....                          | <a href="#">559</a>                       |
| Pavement Markings .....                  | <a href="#">609</a>                       |
| Railroad Crossing .....                  | <a href="#">137</a>                       |
| Structures and Approaches .....          | <a href="#">499</a>                       |
| Supports for Girder Ends .....           | <a href="#">489</a>                       |
| Traffic Signal and Street Lighting ..... | <a href="#">611</a>                       |

Temporary Road (*definition*) .....

[14](#)

Temporary Route (*definition*) .....

[15](#)

Temporary Structure (*definition*) .....

[15](#)

Termination of Contract .....

[84](#)

Test Piles, Driving .....

[374](#)

Thinning, Selective .....

[112](#)

Tile, Structural Clay .....

[835](#)

Timber:

Hardware .....

[448](#)

Salvaging Marketable .....

[111](#)

Structures .....

[446](#)

Timber and Lumber:

Piles .....

[820](#)

Posts .....

[821](#)

Preservative Treatment .....

[819](#)

Rustic Construction .....

[831](#)

Sawn Posts and Blocks .....

[823](#)

Species and Grade .....

[819](#)

Structural .....

[819](#)

Topsoil:

Removing and Salvaging .....

[128](#)

Surface .....

[649](#)

Tower Lighting Unit .....

[676](#), [869](#)

Track, Remove .....

[121](#)

Traffic Cones .....

[934](#)

Traffic Control .....

[42](#)

Traffic Control:

Break-Away Columns .....

[887](#)

Cantilever Supports .....

[887](#)

Delineators .....

[884](#)

Devices:

Cleaning .....

[618](#)

Placing .....

[602](#)



# INDEX

|   |                 |
|---|-----------------|
| Signs, Temporary .....                              | 602, <b>933</b> |
| Steel Posts and Square Tubular .....                | <b>885</b>      |
| Temporary .....                                     | 601             |
| Truss Supports .....                                | <b>888</b>      |
| Traffic Control Devices ( <i>definition</i> ) ..... | 15              |
| Traffic Lane ( <i>definition</i> ) .....            | 15              |
| Traffic Loop .....                                  | 692             |
| Traffic Regulator:                                  |                 |
| Equipment .....                                     | <b>944</b>      |
| Use of .....  | 618             |
| Traffic Regulator ( <i>definition</i> ) .....       | 15              |
| Traffic Signals .....                               | 685             |
| Traffic Signals:                                    |                 |
| Case Signs .....                                    | 690, <b>916</b> |
| Pedestrian Signals .....                            | 686, <b>905</b> |
| Signal Pedestals .....                              | 688, <b>914</b> |
| Signals and Assemblies .....                        | 686, <b>893</b> |
| Span Wire .....                                     | 686, <b>893</b> |
| Strain Poles .....                                  | 688, <b>913</b> |
| Traffic Signal System, Temporary .....              | 611             |
| Traffic Signs .....                                 | 571             |
| Transporting Materials .....                        | 52              |
| Traveled Way ( <i>definition</i> ) .....            | 15              |
| Tree:   |                 |
| Planting .....                                      | 641             |
| Remove .....  | 115             |
| Trench Excavation:                                  |                 |
| Culverts .....                                      | 185             |
| Sewers .....  | 195             |
| Trenching .....                                     | 176             |
| Trimming and Finishing Earth Grade .....            | 138             |
| Truss Sign Supports:                                |                 |
| Erecting .....                                      | 576             |
| Fabricating .....                                   | <b>888</b>      |
| Foundation .....                                    | 574             |
| Turf Establishment:                                 |                 |
| Compost .....                                       | 648             |
| Fertilizers .....                                   | <b>850</b>      |
| Mulch .....   | <b>852</b>      |
| Seasonal Limitations .....                          | 653             |
| Seeding .....                                       | 651             |
| Sod .....   | <b>852</b>      |
| Topsoil .....                                       | <b>849</b>      |

Watering and Cultivating ..... [643](#)

## U

Unauthorized Work ..... [34](#)

### Underdrain:

Backfill ..... [211](#)

Bank..... [211](#)

Cleanout ..... [213](#)

Connections..... [211](#)

Excavation ..... [211](#)

Foundation..... [211](#)

Laying and Jointing..... [211](#)

Open-Graded..... [212](#)

Outlet Ending..... [210](#)

Outlet ..... [212](#)

PDS ..... [210](#)

Pipe..... [210](#)

Subgrade ..... [211](#)

Unused Material ..... [38](#)

### Utilities, Public:

Contractor's Cooperation with ..... [38](#)

Contractor's Responsibility for..... [64](#)

Utility (*definition*)..... [15](#)

Utility Pole, Remove..... [122](#)

## V

Valley Gutter ..... [538](#)

Vests for Traffic Regulators ..... [944](#)

### Vibration of Concrete:

Pavement..... [303](#)

Piling..... [379](#)

Structural ..... [393](#)

Video Inspection Sewer and Culvert Pipe ..... [189](#)

## W

Waiver of NRMCA Requirements ..... [294](#)

Wall Drain..... [409](#)

Warning Lights ..... [939](#)

Water..... [814](#)

Watering and Cultivating..... [643](#)

Water Pollution and Siltation..... [66](#), [150](#)

Waterproofing Membrane and Joint Fabric ..... [450](#), [844](#)

Water Reducing and/or Retarding Admixtures ..... [753](#)

# INDEX

|  |                     |
|--|---------------------|
| Water Repellent Treatment, Penetrating .....               | <a href="#">408</a> |
| Watertight Joints .....                                    | <a href="#">789</a> |
| Weather Limitations (see Weather and Seasonal Limitations) |                     |
| Weather and Seasonal Limitations:                          |                     |
| Concrete:  |                     |
| Barrier .....  | <a href="#">548</a> |
| Bridge Deck.....   | <a href="#">478</a> |
| Curb .....   | <a href="#">540</a> |
| Drainage Structure .....                                   | <a href="#">203</a> |
| Driveway .....   | <a href="#">317</a> |
| Night Casting.....   | <a href="#">397</a> |
| Pavement.....  | <a href="#">317</a> |
| Sidewalk.....  | <a href="#">317</a> |
| Structure.....   | <a href="#">397</a> |
| HMA:   |                     |
| Chip Seal.....   | <a href="#">272</a> |
| Crack Treatment .....                                      | <a href="#">252</a> |
| Curb .....   | <a href="#">244</a> |
| Micro-Surfacing .....                                      | <a href="#">266</a> |
| Pavement.....  | <a href="#">244</a> |
| Paver Placed Surface Seal .....                            | <a href="#">257</a> |
| Slurry Seal.....   | <a href="#">282</a> |
| Pavement Markings.....                                     | <a href="#">592</a> |
| Planting Trees and Shrubs.....                             | <a href="#">641</a> |
| Seeding.....   | <a href="#">653</a> |
| Structure Painting .....                                   | <a href="#">842</a> |
| Weed Control .....   | <a href="#">657</a> |
| Weighing Equipment (see also Scales) .....                 | <a href="#">91</a>  |
| Welding Steel:   |                     |
| Field.....   | <a href="#">431</a> |
| Shop .....   | <a href="#">422</a> |
| Testing.....   | <a href="#">422</a> |
| Winter Grading:  |                     |
| Roadway Embankment .....                                   | <a href="#">133</a> |
| Structure Embankment.....                                  | <a href="#">137</a> |
| Withdrawal of Proposal .....                               | <a href="#">19</a>  |
| Wood Pole.....   | <a href="#">678</a> |
| Work ( <i>definition</i> ).....                            | <a href="#">15</a>  |
| Work Day (Working Day) ( <i>definition</i> ) .....         | <a href="#">15</a>  |
| Work Day, Charging.....                                    | <a href="#">76</a>  |
| Work Day Contract ( <i>definition</i> ).....               | <a href="#">15</a>  |
| Workers, Competence of .....                               | <a href="#">72</a>  |
| Working Drawing ( <i>definition</i> ).....                 | <a href="#">12</a>  |

|                                       |                    |
|---------------------------------------|--------------------|
| Work Order ( <i>definition</i> )..... | <a href="#">15</a> |
| Work Site Examination.....            | <a href="#">16</a> |