

**MICHIGAN STRUCTURE INSPECTION MANUAL
BRIDGE INSPECTION**

CHAPTER 5

ROUTINE AND CONDITION BASED IN-DEPTH INSPECTION

5.01 Purpose

The National Bridge Inspection Standards (NBIS) require each state to have outlined procedures for initial and routine bridge safety inspections. This chapter describes the minimum inspection procedures that must be adhered to once a bridge is opened to the public for routine inspections. Bridge owners and team leaders should periodically review the MDOT Safety Inspection web page for advisories, manual updates, and additional information affecting Michigan’s Bridge Inspection Program. The requirements of the Federal Highway Administration (FHWA) [Bridge Inspectors Reference Manual](#) (BIRM), AASHTO Manual for Bridge Evaluation (MBE), and those specified herein shall be adhered to by all involved in the inspection and condition rating of Michigan’s bridge inventory.

5.02 Routine Inspection Types

A routine inspection is defined by the NBIS as a regularly scheduled inspection consisting of observations and/or measurements needed to determine the physical and functional condition of the bridge, to identify any changes from initial or previously recorded conditions, and to ensure that the structure continues to satisfy present service requirements. All elements of the bridge must be visually inspected at a distance that is close enough to determine the overall condition and to detect deficiencies. When portions of primary members are not visible from the ground or water surface then specialized equipment such as a platform bucket truck or under-bridge inspection unit should be used to gain visual access to the elements (see Figure 5.02.01).



Figure 5.02.01 Utilization of an Under-Bridge Inspection Unit during Routine Inspection

MICHIGAN STRUCTURE INSPECTION MANUAL
BRIDGE INSPECTION – ROUTINE AND CONDITION BASED IN-DEPTH INSPECTION

5.02.01 Initial Inspections (New Structures/Existing Structure Replaced)

The initial inspection is defined as the first inspection of a bridge as it becomes a part of the bridge file to provide all Structure Inventory & Appraisal (SI&A) data and other relevant data and to determine baseline structural conditions. This type of inspection applies to every new or replaced bridge.

The initial inspection of newly constructed or replaced structures must be performed by a team leader within 90 days of opening the entire bridge to traffic for state owned bridges and 180 days for all others. However, it is beneficial for the inspection to occur prior to the removal of traffic control devices so a punch list may be developed to correct minor deficiencies that were not identified by the construction inspector. The MDOT Transportation Service Center (TSC) or agency providing the construction engineering oversight should regularly communicate with region staff in order to prevent inspection scheduling conflicts from arising for MDOT owned bridges.

The bridge owner is responsible for verifying whether a structure number exists in the inventory prior to the scheduled inspection. If the construction project letting was not completed through MDOT a request must be submitted to the Structure Preservation and Management Section for the creation of a new bridge inventory record. An SI&A form (see Figure 5.02.02) should accompany each request with data entered for all of the fields that may be obtained from the design drawings. An electronic copy of the [SI&A form](#) is available on the MDOT Safety Inspection web site. In addition to the SI&A information a copy of the Title, General Plan of Site and General Plan of Structure sheets should accompany the request.

The initial inspection encompasses all of the requirements and procedures of a regularly scheduled routine inspection, but also involves other tasks that are normally performed intermittently throughout the service life of a structure. Many of these activities include:

- Comprehensive review of all the SI&A inventory coding that was entered during the creation of the bridge record with the purpose of ensuring erroneous or missing data is corrected
- Performing a load rating for new structures or updating the safe load capacity when rehabilitative work affects the previous assessment utilizing the [Bridge Analysis Guide](#)
- For waterway crossings, measuring and documenting streambed elevations on the [Stream Cross-Section Report](#) in order to provide baseline data for the verification of scour during subsequent inspections
- Evaluating scour effects in accordance with [Appendix-6D](#) of the MDOT Drainage Manual for structures crossing waterways
- Scheduling any additional types of inspections that are required based according to the structural details incorporated by the designer or when the channel depth does not permit inspection of the substructure components through boat and probe or wade and probe methods
- Identifying fracture critical components on the as-built drawings and highlighting each one for future regularly scheduled hands-on inspections in accordance with Chapter 7
- Establishing a bridge file for the collection of pertinent construction documentation and in-service records in compliance with Chapter 4

MICHIGAN STRUCTURE INSPECTION MANUAL
BRIDGE INSPECTION – ROUTINE AND CONDITION BASED IN-DEPTH INSPECTION

safe functioning of the structure. Element level inspections shall be completed for bridges located on the National Highway System (NHS). To comply with the NBIS the inspections are documented through comprehensive inspection reports including the Bridge Safety Inspection Report (BSIR), Culvert Safety Inspection Report (CSIR), and other reports identified throughout this manual.

While routine NBI inspections have occurred since the Federal Highway Act of 1968, the federal requirement to perform element inspections was implemented only recently. The [Moving Ahead for Progress in the 21st Century Act](#) (MAP-21), signed into law by Congress during July of 2012, mandates the collection of element level data for all bridges located on the National Highway System (NHS) for all inspections completed after October 1, 2014. The primary purpose of gathering the condition state data during the Michigan Bridge Element Inspection is to improve asset management techniques that enable effective preservation of the bridge inventory. The [Michigan Bridge Element Inspection Manual \(MiBEIM\)](#) shall be used for all element level inspections conducted in Michigan.

Elements are organized according to three categories that have specific FHWA reporting requirements and restrictions for each type. National Bridge Elements (NBE) represent primary components of the structure and are responsible for the continued safe functioning of the bridge. Examples of NBEs include the deck, superstructure, bearings, substructure, and railing. Bridge Management Elements (BME) are fundamental features which were created for use in bridge management systems. Items such as paint, other protective coatings, and joints are identified as BMEs because their relative condition will affect the usable service life of the component they help to effectively preserve. The final type includes Agency Developed Elements (ADE) which permits each bridge inspection organization to create their own elements, or allow for NBEs and BMEs to be divided into additional sub-elements. ADEs that are linked directly to NBEs or BMEs must use the condition state definitions and units developed by AASHTO, while flexibility exists for elements that were developed to improve internal program processes and safety.

Due to the number of NHS structures in the MDOT owned bridge inventory, element level inspections for all NBI structures will be performed to establish consistency. This work shall also be extended to include non-NBI structures that MDOT inspects including:

- MDOT owned pedestrian bridges
- Railroad bridges where MDOT is responsible for superstructure maintenance
- MDOT owned structures with 10' to 19' span lengths

Under the current legislation, local agencies are only required to complete AASHTO Element Inspections for bridges that are located on the NHS. This requirement may change as MAP-21 also implemented a study that will examine the benefits of requiring the inspections for all NBI bridges.

MICHIGAN STRUCTURE INSPECTION MANUAL
BRIDGE INSPECTION – ROUTINE AND CONDITION BASED IN-DEPTH INSPECTION

5.02.03 Routine Inspections During and After Existing Structure Rehabilitation

Routine inspection requirements for existing structures under rehabilitation varies according to the scope of repairs and the maintenance of traffic during the construction phase. Bridge owners are required to have a post-construction inspection performed when structural rehabilitation that affects load capacity is completed. A routine inspection of a structure under rehabilitation is also necessary if it is due and the bridge is open or closed to traffic during construction.

Examples of common work activities requiring a post-construction inspection when rehabilitation is substantially complete include:

- Deep or Shallow Concrete Overlay
- Bituminous Overlay
- Superstructure Repairs
- Pin and Hanger Replacement
- Extensive Substructure Repairs
- Substructure Replacement
- Deck Replacement
- Superstructure Replacement

Examples of common work activities which do not require a post-construction inspection when rehabilitation is substantially complete include:

- Joint Replacement
- Epoxy Overlay
- Concrete Deck Patching
- Scour Countermeasures
- Painting

Once rehabilitation is completed for any component that changes the load carrying capacity, and the bridge is opened to traffic, a post-construction inspection is required within 90 days for state owned bridges and 180 days for local agency owned structures. However, bridge owners are encouraged to schedule the inspection prior to opening the structure to traffic to develop a comprehensive punch list. The post-construction inspection must be documented using the Bridge Safety Inspection Report (BSIR) or Culvert Safety Inspection Report (CSIR). The team leader should also adjust the inspection frequency according to engineering judgement and the guidelines established through the MDOT [*Guidelines for Bridge Inspection Frequencies*](#). The frequency for the subsequent routine inspection will often be set at less than 24 months, even though conditions do not warrant increased inspections, to ensure the bridge is on a similar cycle as nearby structures. When an increased frequency is used to adjust the inspection cycle a comment should be added to the “General Notes” of the report that describes the reason.

MICHIGAN STRUCTURE INSPECTION MANUAL
BRIDGE INSPECTION – ROUTINE AND CONDITION BASED IN-DEPTH INSPECTION

Team leaders are also encouraged to utilize the Request For Action (RFA) process in MiB^{RIDGE} to document the need for an updated load analysis. After opening the bridge to traffic a load rating that accounts for the current condition of the structure must be completed within 90 days for state owned bridges and 180 days for local agency owned structures. Refer to Chapter 10 for information regarding the RFA process.

If the rehabilitation tasks performed consist of preventive maintenance measures and do not affect the load capacity, the decision to perform a post-construction inspection is determined by the bridge owner. Bridge owners may elect to schedule a voluntary inspection to aid their asset management plan and practices.

When a structure is being rehabilitated and the routine inspection is due a team leader must enter an inspection report. If the structure is completely closed to traffic a general note should be added stating that there is no traffic on the bridge and the previous component ratings have been carried forward. Photos of the closure should be uploaded to the inspection report. If the structure is being rehabilitated under part-width construction then the components that are safely accessible must be inspected. Condition ratings for these components shall be updated accordingly. The team leader is required to document the locations of the structure which were not accessible during the inspection due to safety.

5.03 Routine Inspection Procedures - Bridge Owner Responsibilities

Although several of the activities conducted during routine bridge inspections are delegated to team leaders or other qualified individuals, the bridge owner is ultimately responsible for ensuring compliance with federal and state laws. Failure to complete routine bridge inspections in accordance with the FHWA and MDOT policies may jeopardize the disbursement of state and federal funding to the agency. In order to comply with the requirements the bridge owner must first request access to MiB^{RIDGE} bridge inspection and management web application to review the inventory they are responsible for and assign reports for other registered users to complete. Instructions to request access to the MiB^{RIDGE} application are accessible at the following link: [Access to MiB^{RIDGE}](#)

Once the rights have been obtained the bridge owner may review all of the structures in their particular inventory, previous inspection history, future inspection report due dates, and begin the process of assigning reports to team leaders and qualified individuals. MiB^{RIDGE} also allows the bridge owner to manage the inventory and update structure inventory coding on an as-needed basis. All inspection reports, load rating assumption and summary information, scour action plans, and element level data (as applicable) must be entered into the system.

The bridge owner must also ensure the bridge file contains the items that are identified in the MBE. A summary of this information is provided in [Chapter 4](#). The bridge owner should provide the team leader with access to the file approximately 30 days before the inspection due date. If the team leader recognizes that pertinent information is missing, or the documentation is inadequate, then the bridge owner shall take necessary steps to rectify the process. For example, the General Plan of Site and Structure are necessary records for the file. If the original or as-built drawings cannot be located the bridge owner will need to arrange for these to be created in such detail that overall primary component dimensions and materials are identified.

MICHIGAN STRUCTURE INSPECTION MANUAL
BRIDGE INSPECTION – ROUTINE AND CONDITION BASED IN-DEPTH INSPECTION

The bridge owner is responsible for ensuring that structures are inspected according to the recommended frequencies. Each routine inspection should be assigned in MiB^{RIDGE} one month prior to the month due. Failure to assign the inspection may result in identification of the agency on the monthly advertisement of unassigned inspections. The bridge owner should also perform periodic reviews of the inventory and compare the overall condition of the structure to the inspection frequency. Bridges that are in poor or worse condition generally require an increased inspection frequency.

Every agency must retain a quality control plan and maintain a copy in the bridge file. If a bridge owner secures a consultant to perform bridge inspections for their agency, then the consultant is also expected to perform the associated QC verifications. The bridge owner shall ensure that documentation of the QC tasks is procured and retained according to [Chapter 2](#).

The bridge owner is required to respond to a request from the team leader when a load rating analysis is recommended. In the event that a load rating will be performed, the bridge owner will contact the appropriate staff or secure a qualified consultant to perform the analysis. If a reduction in the safe load capacity occurs the bridge owner shall arrange for sign fabrication and installation. If the reduction in load carrying capacity is greater than 20 percent the bridge owner shall notify MDOT of the critical finding.

The bridge owner is responsible for reviewing each Request for Action (RFA) submitted by the team leader, load rating engineer, or other individual and ensuring that necessary actions are taken to resolve the issue when required.

Local agency bridge owners shall verify that the team leader understands which structures in the inventory are required to have Michigan Bridge Element Inspections completed. Due to the additional mandated effort that is required to collect element level data an amendment to increase existing multi-year inspection contracts may be necessary. In the event of an observed critical finding by the team leader the bridge owner shall respond immediately to facilitate the necessary appropriate actions to protect the public. When issues are anticipated to arise regarding traffic control or equipment scheduling the inspection should be assigned earlier to prevent delays. If the inspection is not performed during the month due the non-compliance process identified in [Chapter 3](#) will be initiated.

5.04 Routine Inspection Procedures – Team Leader Responsibilities

The team leader is responsible for performing the routine inspection in accordance with the BIRM, MBE, and MDOT policies and provisions. MDOT provides [Bridge Advisories](#) and bridge inspection related manual updates on an as-needed basis to improve the overall inspection program and increase FHWA compliance. Additionally, alignment meetings and workshops are coordinated annually to communicate bridge inspection requirements. Team leaders should stay current on changing practices and new procedures by attending these programs.

The team leader is required to document the inspection information in MDOT's MiB^{RIDGE} web application. By entering the required inspection information in MiB^{RIDGE} the team leader is acknowledging the use of standard inspection procedures as documented in the Michigan Structure Inspection Manual (MiSIM).

MICHIGAN STRUCTURE INSPECTION MANUAL
BRIDGE INSPECTION – ROUTINE AND CONDITION BASED IN-DEPTH INSPECTION

The team leader is responsible for documenting any unique inspection procedures that are required to perform the routine inspection.

The subsequent sections are intended to briefly provide an overview of the minimum BIRM and MBE requirements, as well as offer supplemental information that may be helpful during each routine inspection. Within each area is a short narrative that includes routine inspection procedures, clarification of element level inspection requirements, example work recommendations, example conditions which trigger an RFA submittal, and condition based in-depth inspection information. These procedures should be used in conjunction with detailed BIRM information to ensure that a comprehensive and well-documented inspection is completed.

5.05 Surface (BSIR #1, SI&A Item 58A)

The deck surface is often the most scrutinized bridge element by the public as deterioration affecting ride quality may be noticed during each crossing. Proper rating of the surface is important as it provides bridge owners with insight as to the kind of effective strategies that may be applied to preserve or improve the deck condition. SI&A Item 108 should be reviewed during the inspection in order to verify whether the type of wearing surface, type of membrane, and deck protection system placed is coded accurately (see Table 5.05.01). When the type of wearing surface cannot be readily identified as-built drawings must be studied to ensure the data is accurate and complete.

Table 5.05.01 Item 108 Wearing Surface/Protective System

Item 108A		Item 108B		Item 108C	
Type of Wearing Surface		Type of Membrane		Deck Protection	
1)	Monolithic Concrete	1)	Built-up	1)	Epoxy Coated Reinforcement
2)	Integral Concrete	2)	Preformed Fabric	2)	Galvanizing Reinforcing
3)	Latex Concrete or similar	3)	Epoxy	3)	Other Coated Reinforcing
4)	Low Slump Concrete	8)	Unknown	4)	Cathodic Protection
5)	Epoxy Overlay	9)	Other	6)	Polymer Impregnated
6)	Bituminous Concrete	0)	None	7)	Internally Sealed
7)	Wood or Timber	N)	Not Applicable	8)	Unknown
8)	Gravel			9)	Other
9)	Other			0)	None
0)	None			N)	Not Applicable
N)	Not Applicable				

5.05.01 Concrete Deck Surface Routine NBI Inspection Procedures

In the past latex modified concrete (LMC) was often employed as a wearing surface on MDOT owned bridges to fulfill the need of a material that limited the intrusion of moisture and chlorides into the structural deck. Over time, use of LMC as a rigid overlay declined due to the cost savings generated through the use of less expensive silica fume modified concrete (SFMC) that provides similar durability benefits. Many concrete decks may also utilize a sacrificial section of bridge deck concrete that is cast

MICHIGAN STRUCTURE INSPECTION MANUAL
BRIDGE INSPECTION – ROUTINE AND CONDITION BASED IN-DEPTH INSPECTION

monolithically or integrally with the structural deck. The team leader shall perform the procedures listed for the routine inspection of concrete deck surfaces and review Chapter 7 of the BIRM for additional considerations during the inspection.

1. Inspect the concrete wearing surface for cracking and investigate whether any observed cracking is structural or non-structural. Document the approximate location, orientation, width, and spacing of the cracking.
2. Inspect the concrete wearing surface for delamination and spalling. When exposed reinforcement is observed evaluate the area to determine if it poses a safety hazard to motorists and warrants an immediate action. Document the approximate location and percentage of deck area affected of both delamination and spalling.
3. Inspect the concrete wearing surface for scaling. Document the approximate location, percentage of deck area affected, and average estimated depth of scaling.
4. Inspect the concrete wearing surface where shallow, deep, or full depth concrete patches are located. Document the approximate location and percentage of deck area with deficient concrete patches.
5. Record photos of deficiencies when a change in the condition rating occurs and review the in-depth inspection procedures for suggested follow-up activities.

The evaluation of the concrete deck or wearing surface shall conform to the summarized conditions provided in Table 5.05.02. The MDOT Bridge Safety [NBI Rating Guidelines](#) shall be used to assign an overall code to the surface. The type of wearing surface that is being rated must be documented in the comment field of the BSIR. Concrete patches or repaired areas that are sound should not be included in the tabulation of deficient area. The surface of sliding link slabs shall be evaluated and rated as BSIR #16.

Table 5.05.02 Summarized Concrete Deck Surface Rating Guidelines

Good	Cracking less than 1/32" wide with no spalling, scaling, or delamination.
Fair	Delamination or spalling affecting between 2% and 10% of the area. Excessive cracking or heavy scaling up to 1" deep.
Poor	Delamination or spalling affecting between 10% and 25% of the area.
Serious	Spalling affecting more than 25% of the surface area.
Critical	Emergency surface repairs are required for the bridge to remain open.

5.05.02 Concrete Deck Surface Michigan Bridge Element Inspection

Element level information shall be collected for the surface of concrete decks using the Michigan Bridge Element Inspection Manual elements and condition states. If the deck surface is monolithic, integral, or a rigid overlay extends below the top mat of reinforcement then condition state quantities for Element

MICHIGAN STRUCTURE INSPECTION MANUAL
BRIDGE INSPECTION – ROUTINE AND CONDITION BASED IN-DEPTH INSPECTION

810 (Reinforced Concrete Deck Top Surface) shall be used. When a shallow overlay comprised of latex concrete, silica fume modified concrete, or any other type of cementitious wearing surface exists then condition state quantities for Element 815 (Rigid Overlay) shall be used.

Healer sealers are penetrating treatments that are intended to wear from the surface while maintaining a seal within the cracks. Therefore, they are considered a concrete protective coating and not a wearing surface. Healer sealers may exist with or without a wearing surface and in some cases the presence of them may only be determined by reviewing previous inspection or maintenance reports. For example, a concrete deck with a shallow overlay may have also had healer sealer applied to extend the serviceability and condition of the overlay. When a healer sealer floodcoat treatment has been applied to the structural deck surface or a wearing course then condition state quantities for Element 850 (Healer Sealer) shall also be added as a protective system to the primary element.

A flowchart illustrating the process of determining the applicable elements for concrete deck surfaces has been provided for clarification (see Figure 5.05.01). All of the elements displayed are ADEs that were created for improved deterioration modeling, analysis, and planning efforts. Quantities and condition state information are linked to other NBEs or BMEs that are reported to FHWA on an annual basis. The data provided must be accurate as it will be evaluated during future quality assurance and NBIP reviews.

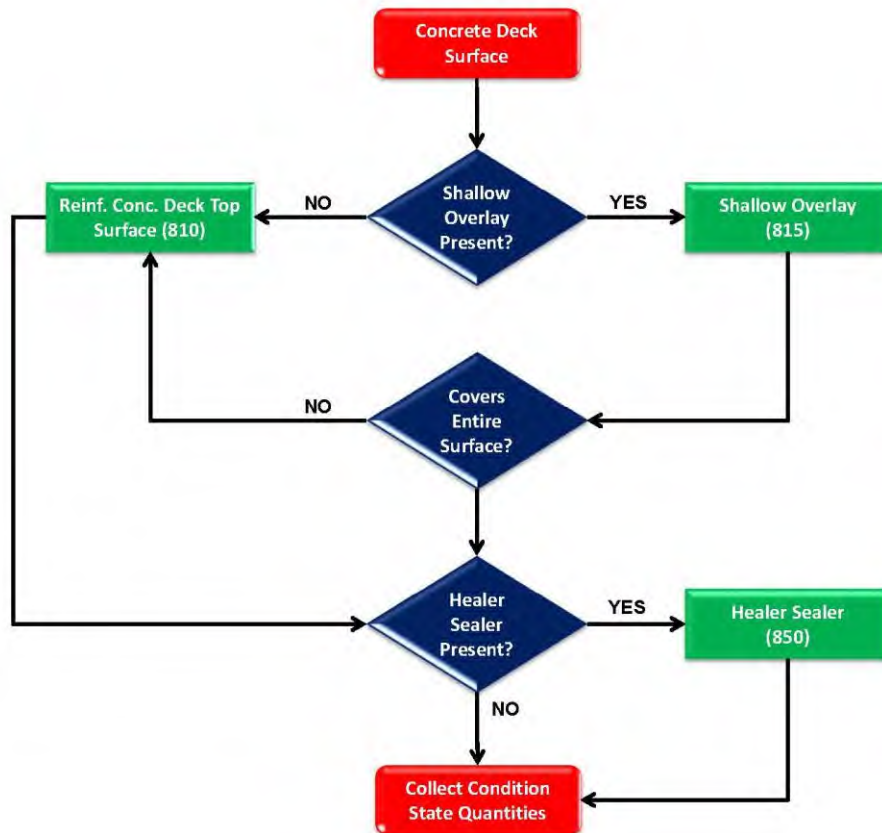

Figure 5.05.01 Element Collection Process for Concrete Surfaces

MICHIGAN STRUCTURE INSPECTION MANUAL
BRIDGE INSPECTION – ROUTINE AND CONDITION BASED IN-DEPTH INSPECTION

5.05.03 Thin Overlay Wearing Surface Routine NBI Inspection

Petrochemical refining advancements have led to the production of resins that are cost efficient for preventive bridge maintenance activities. The lower material prices combined with the moderate effort required for application have led to an increase in the number of bridge decks with thin overlays. These systems have gained wide acceptance because they are impervious, require decreased duration compared to shallow overlays for application, and increase the skid resistance of the surface (see Figure 5.05.02). Although the majority of thin overlays utilize epoxy to seal the surface and bind the aggregate wearing course, other materials such as methyl methacrylates and polyester polymers are being used in many states with similar benefits. The team leader shall perform the procedures listed for the routine inspection of thin overlays and review Chapter 7 of the BIRM for additional considerations during the inspection.



Figure 5.05.02 Thin Overlay Applied to Preserve the Surface of Cut River Deck Truss

1. Inspect the thin overlay wearing surface for loss of aggregate and surface abrasion. Document the approximate location and percentage of deck area affected.
2. Inspect the thin overlay wearing surface for cracking and investigate whether any observed cracking is structural or non-structural. Document the approximate location, orientation, width, and spacing of the cracking.
3. Inspect the thin overlay wearing surface for effectiveness. Failure of the epoxy usually occurs after ten or more years, but poor surface preparation prior to application may also be responsible for reduced durability. Document the approximate location and percentage of deck area affected.

**MICHIGAN STRUCTURE INSPECTION MANUAL
BRIDGE INSPECTION – ROUTINE AND CONDITION BASED IN-DEPTH INSPECTION**

4. Record photos of deficiencies when a change in the condition rating occurs and review the in-depth inspection procedures for suggested follow-up activities.

The evaluation of the thin overlay surface shall conform to the summarized conditions provided in Table 5.05.03. The MDOT Bridge Safety [NBI Rating Guidelines](#) shall be used to assign an overall code to the surface. The type of wearing surface that is being rated must be documented in the comment field of the BSIR. Areas where the material has been patched with a similar polymer product should not be included in the tabulation of deficient area. The portion of the surface that extends beyond the bridge reference lines of sliding link slabs shall be evaluated and rated as BSIR #16.

Table 5.05.03 Summarized Thin Overlay Surface Rating Guidelines

Good	Minor surface wear and aggregate loss within 2' of expansion joints.
Fair	Loss of aggregate or ineffectiveness affecting between 2% and 5% of the area.
Poor	Loss of aggregate or ineffectiveness affecting between 5% and 10% of the area.
Serious	Loss of aggregate or ineffectiveness affecting more than 10% of the surface area. Condition of aggregate may affect skid resistance.
Critical	Emergency surface repairs required for the bridge to remain open. Submit RFA to bridge owner.

5.05.04 Thin Overlay Wearing Surface Michigan Bridge Element Inspection

Element level information shall be collected for the surface of concrete decks using the Michigan Bridge Element Inspection Manual elements and condition states. Thin overlays may be applied to rigid overlays to seal cracking and extend the life of both the wearing surface and the structural deck. For these instances, which occur often on MDOT owned bridges, the data for several elements must be gathered with the distresses observed on the surface used to determine the condition of the underlying material.

When the deck has a thin overlay over any portion of the surface then condition state quantities for Element 816 (Thin Overlay) shall be collected. If multiple wearing surfaces are employed the respective quantities for each shall be measured and quantities assigned to each appropriate condition state. If the thin overlay does not cover the entire structural deck surface and no other wearing surfaces exist then condition state quantities for Element 810 (Reinforced Concrete Deck Surface) shall be collected.

A flowchart illustrating the process of determining the applicable elements for the majority of concrete decks which utilize a thin overlay for preservation has been provided for clarification (see Figure 5.05.03). All of the elements shown are ADEs that were created for improved deterioration modeling, analysis, and planning efforts. Quantities and condition state information are linked to other NBEs or BMEs that are reported to FHWA on an annual basis. The data provided must be accurate as it will be evaluated during future quality assurance and NBIP reviews.

MICHIGAN STRUCTURE INSPECTION MANUAL
BRIDGE INSPECTION – ROUTINE AND CONDITION BASED IN-DEPTH INSPECTION

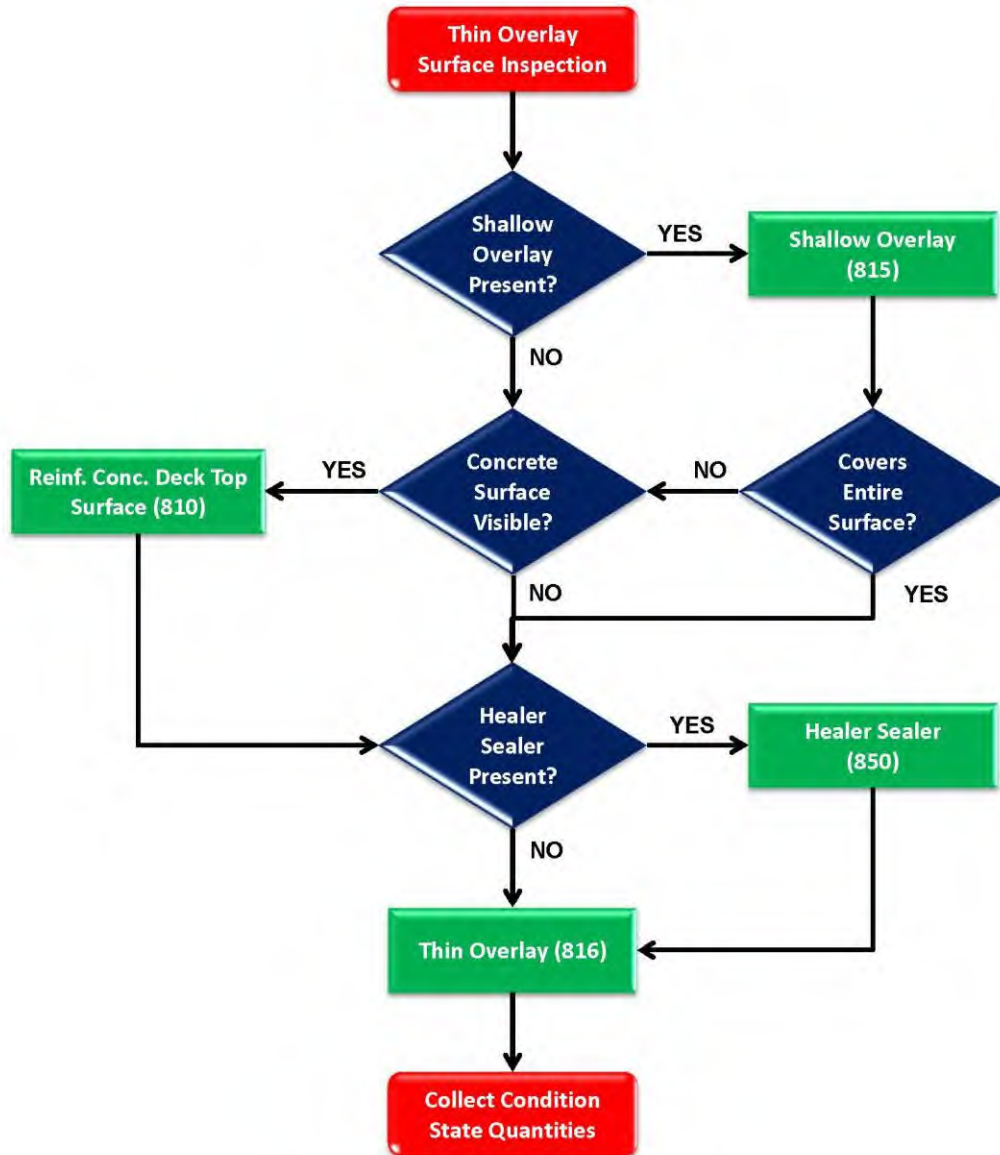

Figure 5.05.03 Element Collection Process for Thin Overlay Surfaces

5.05.05 Bituminous Wearing Surface Routine NBI Inspection

Bituminous concrete, also referred to as hot mix asphalt (HMA), is usually applied to bridge decks in poor condition for increased ride quality prior to rehabilitation or replacement (see Figure 5.05.04). However, slight changes in this standard have occurred as implementation of accelerated bridge construction and erection of prefabricated bridge deck elements systems may incorporate HMA. In many cases, HMA is also used on new local agency bridges that experience low ADT in order to reduce initial construction costs where future maintenance repairs will have a low mobility impact. The team leader shall perform the procedures listed for the routine inspection of bituminous overlays and review Chapter 7 of the BIRM for additional considerations during the inspection.

MICHIGAN STRUCTURE INSPECTION MANUAL
BRIDGE INSPECTION – ROUTINE AND CONDITION BASED IN-DEPTH INSPECTION



Figure 5.05.04 HMA Wearing Surface applied to the concrete deck of a Pony Truss Programmed for Replacement

1. Review existing plans, construction or maintenance records to verify if a waterproofing membrane was placed before the installation of the bituminous wearing surface. The presence of a waterproofing membrane should be noted on the inspection report.
2. Inspect the bituminous wearing surface for cracking. Document the approximate location, orientation, width and spacing of the cracking.
3. Inspect the bituminous wearing surface for spalling. If exposed reinforcement is observed in the structural deck or top flange then evaluate the area to determine if it poses a safety hazard to motorists and warrants an immediate action. Document the approximate location, percentage of deck area affected, and depth (if applicable) of spalling.
4. Inspect the bituminous wearing surface for longitudinal joint failure. Document the approximate location and length of failure.
5. Inspect the bituminous wearing surface for rutting, shoving, or raveling. Document the approximate location, type of defect, and percentage of deck area affected.
6. Record photos of deficiencies when a change in the condition rating occurs and review the in-depth inspection procedures for suggested follow-up activities.

The evaluation of the bituminous wearing surface shall conform to the summarized conditions provided in Table 5.05.04. The MDOT Bridge Safety [NBI Rating Guidelines](#) shall be used to assign an overall code to the surface. The type of wearing surface that is being rated must be documented in the comment field of

**MICHIGAN STRUCTURE INSPECTION MANUAL
BRIDGE INSPECTION – ROUTINE AND CONDITION BASED IN-DEPTH INSPECTION**

the BSIR. Patched surface areas composed of HMA or concrete that are exhibiting no signs of distress should not be included in the tabulation of deficient area.

Table 5.05.04 Summarized HMA Surface Rating Guidelines

Good	Cracks spaced at 50' or more. Minor deformations with no spalling, segregation, or longitudinal joint failure.
Fair	Spalling affecting 2% and 10% of the area. Moderate block cracking, raveling, and longitudinal joint failure.
Poor	Spalling affecting 10% and 25% of the area. Block cracking, raveling, and longitudinal joint failure throughout.
Serious	Spalling affecting more than 25% of the surface area. Ride quality may be impacted.
Critical	Emergency surface repairs are required for the bridge to remain open.

5.05.06 Bituminous Wearing Surface Michigan Bridge Element Inspection

Element level information shall be collected for the surface of concrete decks using the Michigan Bridge Element Inspection Manual elements and condition states. If the deck has a HMA wearing course over any portion of the surface then condition state quantities for Element 817 (Asphalt Overlay with Membrane) or Element 818 (Asphalt Overlay without Membrane) must be collected.

A review of the as-built drawings may have to be performed to verify whether a membrane was applied prior to pavement placement. If the HMA surface does not cover the entire deck refer to the appropriate section for the additional type(s) of material present.

A flowchart illustrating the process of determining the applicable elements for the majority of concrete decks which utilize a thin overlay for preservation has been provided for clarification (see Figure 5.05.05). All of the elements shown are ADEs that were created for improved deterioration modeling, analysis, and planning efforts. Quantities and condition state information are linked to other NBEs or BMEs that are reported to FHWA on an annual basis. The data provided must be accurate as it will be evaluated during future quality assurance and NBIP reviews.

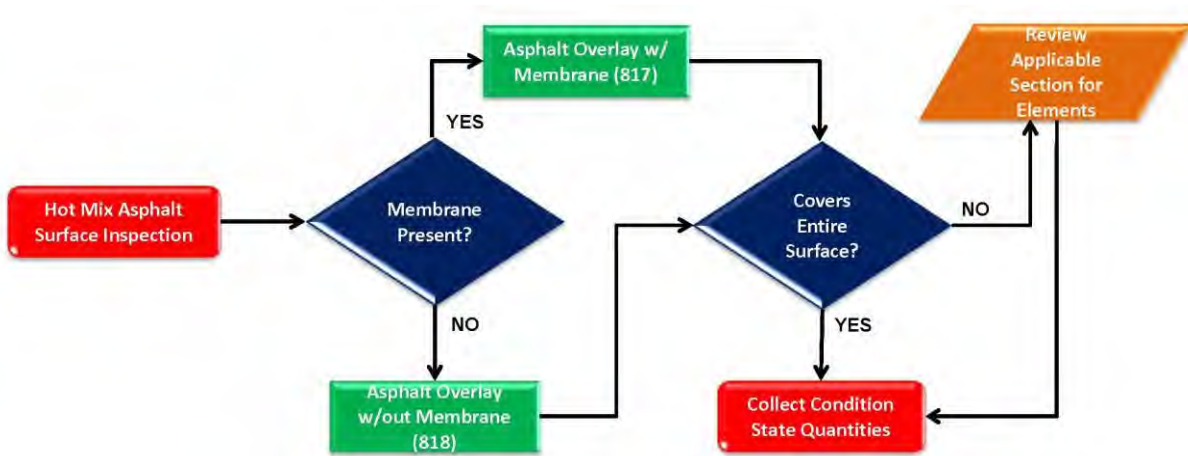

Figure 5.05.05 Element Collection Process for HMA Surfaces

MICHIGAN STRUCTURE INSPECTION MANUAL
BRIDGE INSPECTION – ROUTINE AND CONDITION BASED IN-DEPTH INSPECTION

5.05.07 Timber Wearing Surface Routine NBI Inspection

Exposed timber deck surfaces are often present on rural routes with minimal daily traffic or in recreational parks where the posted speed limit is low. The top surface may consist of timber running planks or the structural deck itself (see Figure 5.05.06). Attention should focus on whether the surface has been damaged by impact or if other deterioration including abrasion and decay are present. The team leader shall perform the procedures listed for the routine inspection of timber deck surfaces and review Chapter 7 of the BIRM for additional considerations during the inspection.



Figure 5.05.06 Timber Running Planks Protecting Timber Deck

1. Inspect the timber wearing surface for abrasion. Document the approximate location, estimated percent of section affected, and percentage of deck area affected.
2. Inspect the timber wearing surface fasteners to verify that they are functioning as constructed. Document the approximate location and number of loose or missing connections.
3. Inspect the timber wearing surface for decay and investigate whether it is localized or occurs throughout the entire surface. Document the approximate location, estimated percent of section loss, and percentage of deck area affected.
4. Inspect the timber wearing surface for damage such as vehicle impact or fire damage.
5. Record photos of deficiencies when a change in the condition rating occurs and review the in-depth inspection procedures for suggested follow-up activities.

**MICHIGAN STRUCTURE INSPECTION MANUAL
BRIDGE INSPECTION – ROUTINE AND CONDITION BASED IN-DEPTH INSPECTION**

The evaluation of the timber deck or timber wearing surface shall conform to the summarized conditions provided below (see Table 5.05.05). The MDOT Bridge Safety [NBI Rating Guidelines](#) shall be used to assign an overall code to the surface. The type of wearing surface that is being rated must be documented in the comment field of the BSIR. Repairs to timber running planks that are exhibiting no signs of distress should not be included in the tabulation of deficient area.

Table 5.05.05 Summarized Timber Surface Rating Guidelines

Good	Minor surface abrasion with the majority of fasteners functioning as constructed.
Fair	Abrasion or decay that affects 10% to 25% of the thickness. Fasteners may be loose but the surface functions adequately. Moderate damage to the surface.
Poor	Abrasion or decay that affects 25% to 50% of the thickness. Substantial damage to the surface.
Serious	Abrasion or decay that affects more than 50% of the thickness. Fasteners or planks are missing.
Critical	Emergency surface repairs required for the bridge to remain open. Submit RFA to bridge owner.

5.05.08 Timber Wearing Surface Michigan Bridge Element Inspection

Element level information shall be collected for the surface of timber decks using the Michigan Bridge Element Inspection Manual elements and condition states only when a wearing course is present. If the deck has sacrificial layer of lumber on the top surface then condition state quantities for Element 819 (Timber Running Planks) shall be collected. When the timber deck has a bituminous or concrete overlay present refer to the appropriate section for the additional type(s) of material present. A flowchart illustrating the process of determining the applicable elements for timber deck surfaces is provided for clarification (see Figure 5.05.07). The element shown is an ADE that has been created for improved deterioration modeling, analysis, and planning efforts. Quantities and condition state information are linked to an NBE that is reported to FHWA on an annual basis. The data provided must be accurate as it will be evaluated during future quality assurance and NBIP reviews.

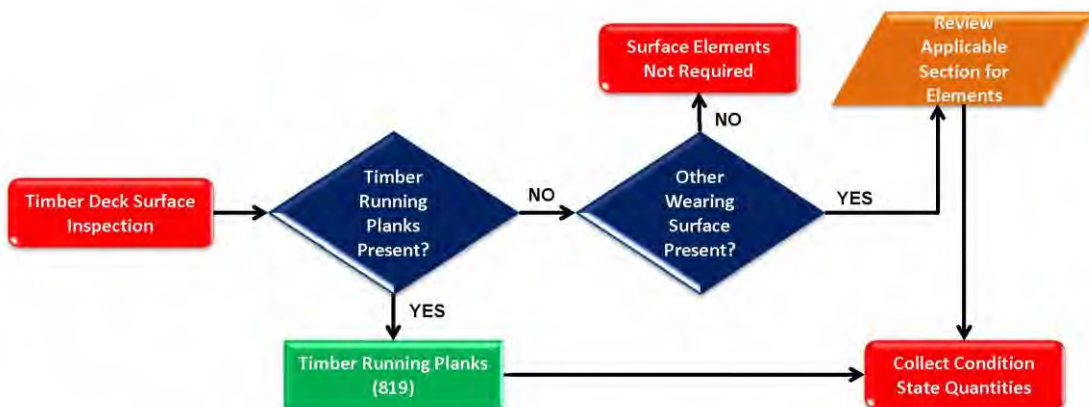

Figure 5.05.07 Timber Deck Element Top Surface Collection Process

MICHIGAN STRUCTURE INSPECTION MANUAL
BRIDGE INSPECTION – ROUTINE AND CONDITION BASED IN-DEPTH INSPECTION

5.05.09 Deck Top Surface Work Recommendations

The team leader should provide applicable work recommendations for all types of wearing surfaces regardless of condition. Several examples of recommendations that work to improve the condition, alleviate the rate of surface deterioration, or resolve specific defects when Item 58 and Item 58A are in fair or good condition are provided below in Table 5.05.06. Consideration for preventive measures to extend the useful life of the surface will aid the bridge owner; however, the overall condition of the structural deck should be evaluated prior to sanctioning a treatment.

For example, applying an epoxy floodcoat to a deck in poor condition will not have a substantial effect on the limited remaining usefulness of the component. In this case the investment required to complete the work could be more efficiently applied to a fair or good deck in the owner’s inventory.

Table 5.05.06 Work Recommendations for Common Bridge Deck Wearing Surfaces

Concrete (Item 58 & 58B ≥ 5)		
Recommendation	Defects	Additional Information
Crack Chasing (Penetrating Sealer)	Cracking, limited, spaced 2' apart or greater	Limited to agencies with direct maintenance forces
Healer Sealer Floodcoat	Cracking, significant, many spaced 2' or less	Generally effective for approximately 6 to 10 years
Thin Overlay Floodcoat	Cracking, significant, many spaced 2' or Less	Generally effective for more than 10 years
Deck Patching	Spalling, greater than 1" deep or 6" diameter	Improves Item 58, 58B, and element ratings
Thin Overlay (Item 58 ≥ 5)		
Recommendation	Defects	Additional Information
Crack Chasing (Penetrating Sealer)	Cracking, limited, spaced at 10' or greater	Limited to agencies with direct maintenance forces
Overlay Patching	Failed effectiveness, 5% or less of the total area	Limited to agencies with direct maintenance forces
Remove and Replace	Failed effectiveness, 5% or more of the total area	Improves Item 58, 58B, and element ratings
Hot Mix Asphalt (Item 58 ≥ 5)		
Recommendation	Defects	Additional Information
Hot Pour Rubber or Overband Crack Seal	Cracking, spaced at 50' or greater	Generally effective for less than 5 years
Hot Mix Asphalt Patching	Spalling, does not extend to structural deck	Improves Item 58B and element ratings
Timber (Item 58 ≥ 5)		
Recommendation	Defects	Additional Information
Water Repellent Treatment	Decay, affects less than 10% or less of the member	Preserves condition to protect deck
Replace Planks	Damage, missing running planks	Improves Item 58B and element ratings

MICHIGAN STRUCTURE INSPECTION MANUAL
BRIDGE INSPECTION – ROUTINE AND CONDITION BASED IN-DEPTH INSPECTION

Prioritize work recommendations according to the general guidelines provided below. Reference the element, location, and describe the extent of rehabilitative measures required. Submit a Request for Action (RFA) for any activity that should be completed prior to the next scheduled routine inspection.

High Priority Work Recommendations

Any structural repairs or replacement of bridge elements that should be completed within 24 to 60 months. High Priority work recommendations consist of any activity that will function to maintain safe load carrying capacity or preserve existing primary component condition ratings.

Medium Priority Work Recommendations

Any structural or non-structural repairs that should be completed within 24 to 60 months. Medium priority work recommendations serve to improve existing component and element condition ratings that are currently in fair or better condition.

Low Priority Work Recommendations

Any repairs that should be scheduled in conjunction with other planned work at the structure. Low priority work recommendations may have little to no effect on primary component condition ratings.

5.05.10 Deck Surface Request for Action

An RFA shall be submitted to the bridge owner when the condition of the structural deck or wearing surface poses a hazard to motorists, if a detailed inspection is required, or whenever an action should be completed in a timely manner. Corrective action or repairs that are not required prior to the next scheduled routine inspection should be identified as a work recommendation on the inspection report. Several examples of defects or items that trigger an RFA submittal for resolution and/or investigation are provided in Table 5.05.07. For other materials an RFA shall be submitted as-needed requesting the in-depth inspection. The RFA shall be submitted in MiB^{RIDGE} with proper documentation and photographs so an adequate review and resolution of the process may be completed.

Table 5.05.07 RFA Examples for Common Bridge Deck Wearing Surfaces

Request for Action	Concrete	Thin Overlay	Hot Mix Asphalt	Timber
In-Depth Inspection	X	X	X	X
Cracking Caused by Reduced Superstructure Capacity	X	X	X	X
Verification of Acceptable Skid Resistance	X	X		
Severe Deterioration resulting in unsafe ride quality conditions	X	X	X	X
Spalling Exposing Prestressed Superstructure Elements			X	
Severe Surface Rutting Inhibiting Drainage			X	

MICHIGAN STRUCTURE INSPECTION MANUAL
BRIDGE INSPECTION – ROUTINE AND CONDITION BASED IN-DEPTH INSPECTION

5.05.11 Deck Surface In-Depth Inspection

In-depth inspections shall be performed as-needed and condition based recommendations are provided in Table 5.05.08. A hands-on inspection should be completed to document the deficiencies present when the condition rating code for the Deck (Item 58) is 5 or greater and the concrete or timber surface (Item 58A, BSIR #1) is rated in fair condition. Once the surface deteriorates and becomes poor it is suggested to complete repetitive detailed inspections at a 48 month frequency. Detailed inspection or documented structural review of wearing surfaces in Condition State 4 is not required for Michigan Bridge Element Inspection.

Table 5.05.08 Recommended Condition Based In-Depth Inspection Guidelines for Deck Surfaces

NBI Rating		Perform Initial In-Depth	In-Depth Frequency	Applicable Deck Surfaces	
Item 58A	Item 58			Concrete	Timber
6	≥ 5	24 Months	As-Needed	Concrete	Timber
4	≥ 5	12 Months	48 Months	Concrete	Timber

The number of lanes or amount of surface area that will be closed to traffic for examination will be dependent on the activity performed, degree of detail required, and ultimately be determined at the discretion of the bridge owner. These access requirements must be discussed in advance of a scheduled in-depth inspection so adequate resources are available for an efficient, safe, and successful inspection. At a minimum, it is expected that the locations will concentrate on the areas that show the greatest degree of distress and influence the condition rating and condition state quantities.

Approval for each in-depth inspection should be documented through the submittal of an RFA to the bridge owner using MiB^{RIDGE}. When the inspection is performed immediately in response to stability or capacity concerns the inspection should be referenced on an RFA submitted after the work has been completed. These processes are necessary for confirming that the work has been performed and verification will occur annually for those structures selected in quality assurance and FHWA NBIP reviews.

The majority of in-depth inspections will require sounding the surface with a hammer or chain drag, and marking delaminated, spalled, and cracked areas so they are visible in photographs (see Figure 5.05.08). The surface shall be inspected for all of the defects identified in the appropriate material specific condition state tables in the Michigan Bridge Element Inspection Manual. In addition, the joints, railings, and other elements that may be accessed closely during the closure of lanes should be reviewed. Permanent marking paint is not recommended unless repairs are anticipated to be completed in a timely fashion. Thin overlay and HMA wearing surfaces generally do not require in-depth inspection as defects in the materials are often detected from the shoulder of the structure. Occasionally, accelerated deterioration or loss of aggregate for thin overlay surfaces may warrant tensile rupture testing, skid resistance measurements, or other hands-on interaction (see Figure 5.05.09). The need to perform a detailed inspection of HMA is even less common although ground penetrating radar and other specialized non-destructive techniques are occasionally used on large structures.

MICHIGAN STRUCTURE INSPECTION MANUAL
BRIDGE INSPECTION – ROUTINE AND CONDITION BASED IN-DEPTH INSPECTION



Figure 5.05.08 Sounding Shallow Overlay Using Chain-Drag Method

For top deck surface surveys, the minimum information included in the in-depth report shall be a sketch of the areas examined with defects provided for each span. Areas that were not examined shall also be delineated on the drawing for future consideration. The level of detail provided must allow for an efficient recurrent in-depth inspection to be conducted in order to determine if the condition of the surface has changed. Photographs of the deficient areas should accompany the sketch and written report findings. The BSIR and element report should be updated to reflect the in-depth findings following the conclusion of the hands-on activities or during the next regularly scheduled routine inspection.



Figure 5.05.09 Thin Overlay Tensile Rupture Test Sample

MICHIGAN STRUCTURE INSPECTION MANUAL
BRIDGE INSPECTION – ROUTINE AND CONDITION BASED IN-DEPTH INSPECTION

5.06 Expansion Joint (BSIR #2)

Expansion joints permit the expansion, contraction, and/or rotation of the superstructure. They are typically located above piers, abutments, pin and hangers, or at the sleeper slab. They may be transverse or longitudinal, and restricted movement leads to stresses that may cause irreversible damage to the bridge. Failure of an expansion joint may lead to an increased rate of environmental damage to the superstructure and substructure components beneath. When repair or replacement of the joint is not addressed over a period of time the damage may require extensive temporary or permanent repair measures. Examples of common expansion joint systems that exist at many structures include:

- Full Depth Strip Seal
- Compression Joint Seal
- Pourable Joint Seal
- Partial Depth Strip Seal
- Partial Depth Block Out

On MDOT owned bridges, the use of multiple joint systems has nearly been eliminated by the full depth strip seal joint. The galvanized steel rail, coupled with the resilient gland, requires low maintenance and provides superior durability compared to other methods. This system also allows the ability to replace damaged sections of gland with minor preparation and moderate effort for increased cost savings when comparisons are made to other systems.

5.06.01 Expansion Joint Routine NBI Inspection

Joints shall be inspected across the entire length of the deck including the vertical upturns at each railing or curb. Expansion joints that are closed do not allow the superstructure to expand and may cause irreversible damage. The team leader should evaluate whether closed joints are a result of pavement growth, seized pin and hangers, improper installation, or other factors that compromise the functionality. The team leader shall perform the procedures listed for the routine inspection of expansion joints and review Chapter 7 of the BIRM for additional considerations during the inspection.

1. Inspect the entire length of each expansion joint for adjacent deck cracking within 2 feet of system. Document the approximate location, length of joint affected, and severity of the cracking.
2. Inspect the entire length adjacent to each expansion joint for spalling within 2 feet of system. When exposed reinforcement is observed evaluate the area to determine if it poses a safety hazard to motorists and warrants an immediate action. Document the approximate location, length of joint affected, and whether the adjacent deterioration affects the performance of the system.

MICHIGAN STRUCTURE INSPECTION MANUAL
BRIDGE INSPECTION – ROUTINE AND CONDITION BASED IN-DEPTH INSPECTION

3. Inspect the entire length of each expansion joint for the ability to retain precipitation and debris. Evaluate the gland or seal for loss of adhesion, cracking, or punctures. Document the approximate location, length of joint affected, and cause of any reduced effectiveness.
4. Inspect the entire length of each expansion joint for damage or loose components. Document the approximate location, length of joint affected, and describe the potential cause.
6. Record photos of deficiencies when a change in the condition rating occurs and review the in-depth inspection procedures for suggested follow-up activities.

The evaluation of expansion joints shall conform to the summarized conditions provided in Table 5.06.01. The MDOT Bridge Safety [NBI Rating Guidelines](#) shall be used to assign an overall code to the expansion joint. This item for structures without decks shall be coded “N”. The function of the joint, regardless of the material used, will determine whether the condition rating is applied to the Expansion Joint (BSIR #2) or Other Joint (BSIR #3) on the inspection report. Joints which are fixed for the purpose of rotation shall be evaluated as Other Joints. Joints which permit rotation and horizontal translation shall be evaluated as expansion joints. If the purpose is not easily determined in the field the plans should be reviewed for proper coding (see Figure 5.06.01).

Table 5.06.01 Summarized Expansion Joint Rating Guidelines

Good	Minor deterioration with shallow hairline cracks less than 1/32" and shallow spalls within 2' of the joint. No noticeable water leakage on the surfaces below.
Fair	Moderate deterioration of surrounding concrete including cracking and shallow spalling. Minor leakage along less than 5% of the joint length on redundant members due to loss of seal adhesion and/or failure of the device. Expansion may be limited due to inadequate opening at the bridge railing or fascia.
Poor	Major deterioration of surrounding concrete including cracking and spalling to steel. Minor leakage on non-redundant members, or along 5% or more of the joint length on redundant ones due to loss of seal adhesion and/or failure of the device. Expansion is obstructed due to bridge railing or fascia contact.
Serious	Surrounding concrete is spalled below reinforcement on the top or bottom deck surface with possible full-depth failures. Majority of the device is leaking, loose, or not properly functioning. Settlement of the sleeper slab or joint condition is impacting ride quality.
Critical	Device and surrounding concrete is seriously deteriorated. Emergency repairs may be required for all lanes to remain open. Temporary joint support from underneath may be necessary.

MICHIGAN STRUCTURE INSPECTION MANUAL
BRIDGE INSPECTION – ROUTINE AND CONDITION BASED IN-DEPTH INSPECTION

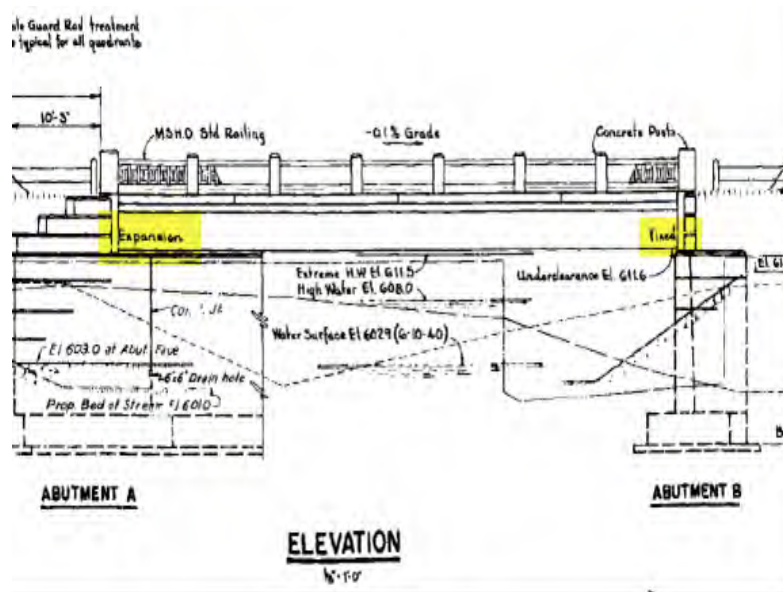

Figure 5.06.01 Review of the As-Built Drawings May Be Required for Proper Coding

5.06.02 Expansion Joint Michigan Bridge Element Inspection

Element level information shall be collected for expansion joints using the Michigan Bridge Element Inspection Manual elements and condition states. The joints shall be measured along the skew angle. A bridge may have multiple types of joints and condition state information shall be collected for Element 300 (Strip Seal Expansion Joint), Element 301 (Pourable Joint Seal), Element 302 (Compression Joint Seal), Element 303 (Assembly Joint with Seal), Element 304 (Open Expansion Joint), Element 305 (Assembly Joint without Seal), and Element 306 (Other Joints).

When the adjacent deck materials have been replaced with conventional concrete during joint rehabilitation or maintenance and no visible defects are present the area shall be coded in Condition State 1.

Strip seal expansion joints are a full depth system that utilizes a galvanized steel device and durable neoprene gland (see Figure 5.06.02). Anchoring devices are welded to the channel during fabrication which provides a means to secure it to the steel reinforcement mats and resist impact damage. The gland is formed in a fashion that allows secure attachment to the rolled profile opening. There are currently three approved material suppliers for MDOT owned bridges and each offer several variations based according to the specific design requirements.

Pourable joints seals are the most inexpensive systems since backer rod and hot pour rubber are utilized but durability is sacrificed (see Figure 5.06.03). Silicone may be used in lieu of the rubber as a result of cold weather construction but the additional material costs generally limit it from occurring. Older variations of pourable joints also incorporated a copper water stop that was thought to aid effectiveness. However, once the joint seal was compromised a “bathtub” effect was created which retained precipitation and accelerated damage during freeze thaw cycles. Poured seals resilience are also

MICHIGAN STRUCTURE INSPECTION MANUAL
BRIDGE INSPECTION – ROUTINE AND CONDITION BASED IN-DEPTH INSPECTION

dependent on placement conditions requiring a dry deck and optimum surface preparation. Due to these reasons regular maintenance and replacement are required. This element does not include fixed end joints which shall be collected according to Section 5.07.



Figure 5.06.02 Full Depth Strip Seal



Figure 5.06.03 Pourable Joint Seal

MICHIGAN STRUCTURE INSPECTION MANUAL
BRIDGE INSPECTION – ROUTINE AND CONDITION BASED IN-DEPTH INSPECTION



Figure 5.06.04 Compression Joint Seal

Compression joint seals are preformed and usually composed of neoprene or closed cell foam with a rubber coating for added durability (see Figure 5.06.04). Occasionally they utilize an armor system, but a means to attach the seal to the steel is only possible through the use of adhesive. After many expansion and contraction cycles the breakdown of the material leads to reduced effectiveness and failure.

Assembly joints with seals are commonly referred to as modular joints and are installed in areas where expansion and contraction exceed 4 inches (see Figure 5.06.05). Due to the width and multiple devices utilized, they are very susceptible to impact damage from snowplows which may cause cracked welds and decreased performance.



Figure 5.06.05 Assembly Joint with Seal

MICHIGAN STRUCTURE INSPECTION MANUAL
BRIDGE INSPECTION – ROUTINE AND CONDITION BASED IN-DEPTH INSPECTION

Open expansion joints may or may not utilize an armoring system as a means to protect horizontal to vertical deck slab transition (see Figure 5.06.06). This element should only be used in instances when the as-built joint did not include a seal. If there is any uncertainty whether a pourable seal previously existed the plans should be reviewed to ensure accurate element application.

Assembly joints without seals consist of finger and sliding plate systems (see Figure 5.06.07). Finger joints are used where there is a high degree of rotation and are also commonly installed at the interface between fixed and movable spans of bascule or lift bridges. Sliding plate joints were used in the past on structures with long spans to accommodate a high degree of expansion along with placement at many truss structures. The advent of the modular strip seal joint has eliminated current installations of these systems. Sliding plate joints that are sealed with hot pour rubber to reduce leakage must still be identified as Element 305.



Figure 5.06.06 Open Expansion Joint

Other joints are used to classify systems that cannot be defined by any of the previously described types (see Figure 5.06.08 and 5.06.09). Examples include block out style and partial depth strip seals. Although partial depth strip seals utilize many of the same materials as Element 300 durability is appreciably reduced because the device is bonded to the structural deck with elastomeric concrete. See Section 5.07 for additional information.

In rare circumstances a joint may consist of two or more mixed types of systems (see Figure 5.06.10). This usually occurs when temporary repairs are completed to prevent additional deterioration prior to a scheduled rehabilitation project. It may also happen when permanent repairs were affected by weather or mobility limitations. The applicable length for each element should be coded to accurately reflect the condition and quantity of the systems employed.

MICHIGAN STRUCTURE INSPECTION MANUAL
BRIDGE INSPECTION – ROUTINE AND CONDITION BASED IN-DEPTH INSPECTION

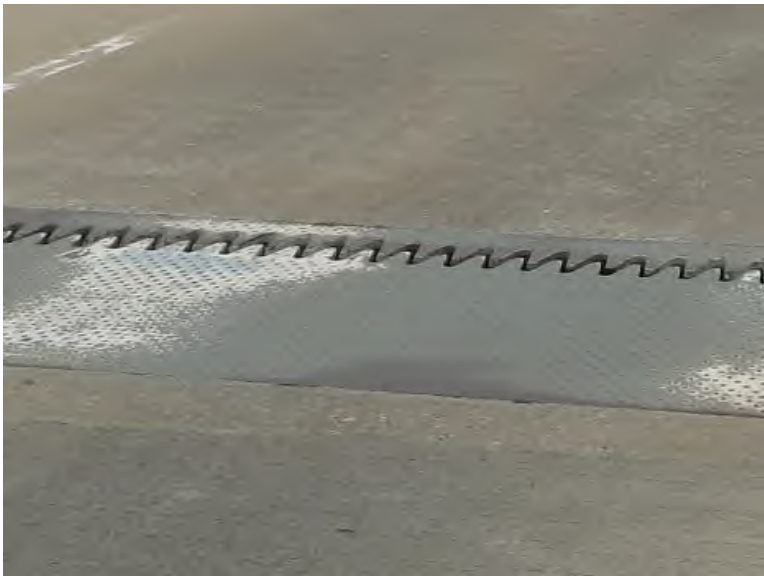

Figure 5.06.07 Assembly Joint without Seal



Figure 5.06.08 Other Joint – Partial Depth Strip Seal

MICHIGAN STRUCTURE INSPECTION MANUAL
BRIDGE INSPECTION – ROUTINE AND CONDITION BASED IN-DEPTH INSPECTION



Figure 5.06.09 Other Joint – Block Out Style



Figure 5.06.10 Mixed Joint Consisting of Elements 300 and 306

MICHIGAN STRUCTURE INSPECTION MANUAL
BRIDGE INSPECTION – ROUTINE AND CONDITION BASED IN-DEPTH INSPECTION

All joint elements that serve to accommodate superstructure expansion are BMEs which were developed for improved deterioration modeling, analysis, and planning efforts. Quantities and condition state information are reported directly to FHWA on an annual basis. The data provided must be accurate as it will be evaluated during future quality assurance and NBIP reviews.

5.06.03 Expansion Joint Work Recommendations

The team leader should provide work recommendations for any joint system that is leaking, ineffective, or damaged. Preventive measures such as cleaning or flushing to prevent gland failure may also be provided on the inspection report to extend the life of the system. Prompt maintenance and repair will prevent further damage that will escalate costs for superstructure and substructure repairs as a result of joint failure. Examples of work recommendations to include when the superstructure (Item 59) or substructure (Item 60) is in fair or better condition are provided in Table 5.06.02. The recommendation should not only include in-kind replacement, but consideration for upgrading the system to the preferred full depth strip seal system when an antiquated system is in use. The increased initial cost of the superior joint system is often recuperated through decreased future maintenance and repairs to other portions of the structure. Bridges that are primary candidates for upgrades include those with high ADT, where elevated concentrations of deicing materials are regularly placed, or ones which contain non-redundant members.

Table 5.06.02 Work Recommendations for Expansion Joints

Expansion Joints (Item 59 or 60 ≥ 5)		
Recommendation	Defects	Additional Information
Cleaning	Debris impaction, no visible signs of leakage	Reduces rate of gland failure
Resealing	Leakage, pourable joints	Effectiveness dependent on preparation and cycles
Gland Replacement	Leakage, caused by punctured or ripped gland	Reduces cost when full replacement is unnecessary
Deck Patching	Spalling, adjacent deck or header	Preserves joint condition and prevents device failure
Joint Replacement	Multiple, joint performance is compromised	Generally effective for more than 20 years

Prioritize work recommendations according to the general guidelines provided below. Reference the element, location, and describe the extent of rehabilitative measures required. Submit a Request for Action (RFA) for any activity that should be completed prior to the next scheduled routine inspection.

High Priority Work Recommendations

Any structural repairs or replacement of bridge elements that should be completed within 24 to 60 months. High Priority work recommendations consist of any activity that will function to maintain safe load carrying capacity or preserve existing primary component condition ratings.

MICHIGAN STRUCTURE INSPECTION MANUAL
BRIDGE INSPECTION – ROUTINE AND CONDITION BASED IN-DEPTH INSPECTION

Medium Priority Work Recommendations

Any structural or non-structural repairs that should be completed within 24 to 60 months. Medium priority work recommendations serve to improve existing component and element condition ratings that are currently in fair or better condition.

Low Priority Work Recommendations

Any repairs that should be scheduled in conjunction with other planned work at the structure. Low priority work recommendations may have little to no effect on primary component condition ratings.

5.06.04 Expansion Joint Request for Action

An RFA shall be submitted to the bridge owner when the condition of an expansion joint poses a hazard to motorists, if a detailed inspection is required, or whenever an action should be completed prior to the next scheduled routine inspection (see Figure 5.06.11). Corrective action or repairs that do not require completion prior to the next scheduled routine inspection should be identified as a work recommendation on the BSIR.



Figure 5.06.11 Failed Expansion Joint and Surrounding Concrete Deck Necessitating Repairs Prior to the Next Schedule Inspection

Examples that trigger an RFA submittal for resolution and/or investigation of four main joint systems are provided in Table 5.06.03. For other systems an RFA shall be submitted as-needed requesting the in-depth inspection. The RFA shall be submitted in MiB^{RIDGE} with proper documentation and photographs so an adequate review and resolution of the process may be completed.

MICHIGAN STRUCTURE INSPECTION MANUAL
BRIDGE INSPECTION – ROUTINE AND CONDITION BASED IN-DEPTH INSPECTION

Table 5.06.03 RFA Examples for Expansion Joints

Request for Action	Applicable Expansion Joint Systems			
	Strip Seal	Partial Depth	Compression	Pourable
In-Depth Inspection	X	X	X	X
Loose Expansion Joint Device Causing Hazard to Motorists	X	X		
Severe Spalling in Traveled Lanes Adj. to Device	X	X	X	X
Leakage Impacting Condition of Non-Redundant Members	X	X	X	X

5.06.05 Expansion Joint In-Depth Inspection

In-depth inspection of expansion joints is usually not required as the defects leading to improper performance may often be identified during a routine inspection through observations related to the condition of the gland, seal, armor, or adjacent materials. However, in rare cases a joint may require a hands-on inspection to determine whether its function has been compromised. This may occur when a full depth strip seal system is impacted with an extensive amount of debris and verification of the extent of gland failure cannot be performed without hands-on access (see Figure 5.06.12). A second example, related to modular joint systems, may be the need to examine a portion of the underside with an under-bridge inspection unit to verify whether a support bar is broken. Detailed inspection or documented review of expansion joints in Condition State 4 is not required for Michigan Bridge Element Inspection.

The number of lanes or areas that will be closed to traffic for examination will be dependent on the activity performed, degree of detail required, and ultimately be determined at the discretion of the bridge owner. These access requirements must be discussed in advance of a scheduled in-depth inspection so adequate resources are available for an efficient, safe, and successful inspection. At a minimum, it is expected that the locations will concentrate on areas where deficiencies are suspected or the joint is no longer effective.

Approval for each in-depth inspection should be documented through the submittal of an RFA to the bridge owner using MiB^{RIDGE}. When the inspection is performed immediately in response to concern for motorist safety the work should be referenced on an RFA submitted after it is completed. These processes are necessary for confirming that the work has been completed and will be reviewed annually during QA and FHWA NBIP reviews.

MICHIGAN STRUCTURE INSPECTION MANUAL
BRIDGE INSPECTION – ROUTINE AND CONDITION BASED IN-DEPTH INSPECTION



Figure 5.06.12 In-Depth Inspection of Full Depth Strip Seal Gland Failure

The majority of in-depth joint inspections will require removal of the debris on the gland, seal, and adjacent surfaces for adequate observation. When this is necessary the team leader should notify the bridge owner so adequate equipment, tools, and labor are available once lanes are closed. The gland or seal must be inspected to ensure that it is adequately secured or bonded to the proper surfaces. Areas within 2 feet of the joint should also be sounded as severe deterioration may compromise the ability for it to function. Joints shall be inspected for all of the defects identified in Condition State Table 8 of the Michigan Bridge Element Inspection Manual. In addition, railings, deck surface, or other elements that may be accessed within the work zone should also be evaluated when distress is observed.

For detailed joint inspections, the minimum information included in the report shall be commentary denoting the defects observed at each location, length of joint affected by the deficiency, and total number of joints inspected. Sketches may also be provided for additional detail and clarity when written findings do not adequately describe the observations. Photographs of the deficient areas should also accompany the report. The BSIR and element report should be updated to reflect the in-depth findings following the conclusion of the hands-on activities or during the next regularly scheduled routine inspection.

5.07 Other Joints (BSIR #3)

Other joints for both NBI and Michigan Bridge Element inspections are not classified identically. For NBI inspections, other joints may be categorized as any fixed or construction joint. The location or kind of materials utilized does not factor into the determination of the joint type. Whereas for element inspection, the types of joints that may be identified as Element 306 (Other Joint) is contingent on specific material or physical features that cannot be classified by any other described element.

MICHIGAN STRUCTURE INSPECTION MANUAL
BRIDGE INSPECTION – ROUTINE AND CONDITION BASED IN-DEPTH INSPECTION



Figure 5.07.01 The Purpose of Poured Joints Must Be Determined During NBI Inspection

5.07.01 Other Joint Routine NBI Inspection

Designers of MDOT owned bridges are required to evaluate the possibility of locating expansion joints beyond the reference line, away from the supported spans, within the approach pavement. Prior to December 2014 the MDOT NBI Inspection Guidelines provided instruction to evaluate the condition of expansion joints at the sliding approach and sleeper slab as Other Joints. The elimination of joints on the deck prevents deterioration to primary components in the event of leakage. Although placement off of the structure diminishes concerns related to environmental damage in the event of failure, the functional requirements of the system cannot be compromised as it may lead to irreversible damage to other structural elements. Due to this reasoning all locations where longitudinal translation of the structure occurs shall be evaluated as expansion joints (see Figure 5.07.01). The team leader shall perform the procedures listed for the routine inspection, and review Chapter 7 of the BIRM for additional considerations during the inspection.

1. Inspect the entire length of each joint for adjacent deck cracking that occurs within 2 feet of the seal or void. Document the approximate location, length of joint affected, and severity of the cracking.
2. Inspect the entire length of each joint for spalling that occurs within 2 feet of seal or void. When exposed reinforcement is observed evaluate the area to determine if it poses a safety hazard to motorists and warrants an immediate action. Document the approximate location, length of joint affected, and whether the adjacent deterioration affects effectiveness.
3. Inspect the entire length of each sealed joint for the ability to retain precipitation and debris. Evaluate the pourable or preformed seal for loss of adhesion, cracking, or punctures.

MICHIGAN STRUCTURE INSPECTION MANUAL
BRIDGE INSPECTION – ROUTINE AND CONDITION BASED IN-DEPTH INSPECTION

Document the approximate location, length of joint affected, and cause of any reduced effectiveness.

4. Inspect the entire length of each joint for damage. Document the approximate location, length of joint affected, and describe the potential cause.
5. Record photos of deficiencies when a change in the condition rating occurs and review the in-depth inspection procedures for suggested follow-up activities.

The evaluation of other joints shall conform to the summarized conditions provided in Table 5.07.01. The MDOT Bridge Safety [NBI Rating Guidelines](#) shall be used to assign an overall code to the surface. This item for structures without decks shall be coded “N”. The function of the joint, regardless of the material used, will determine whether the condition rating is applied to Expansion Joint (BSIR #2) or Other Joint item (BSIR #3) on the BSIR. Joints which are fixed for the purpose of rotation only shall be evaluated as other joints. Joints which permit rotation and horizontal translation shall be evaluated as expansion joints. If the purpose is not easily determined in the field the plans should be reviewed for proper coding.

Table 5.07.01 Summarized Other Joint Rating Guidelines

Good	Minor deterioration with shallow hairline cracks less than 1/32" and shallow spalls within 2' of the joint. No noticeable water leakage on the surfaces below.
Fair	Moderate deterioration of surrounding concrete including cracking and shallow spalling. Minor leakage along less than 5% of the joint length on redundant members.
Poor	Major deterioration of surrounding concrete including cracking and spalling to steel. Minor leakage on non-redundant members, or along 5% or more of the joint length on redundant ones.
Serious	Surrounding concrete is spalled below reinforcement on the top or bottom deck surface with possible full-depth failures. Majority of the device is leaking. Ridge quality may be impacted.
Critical	Joint and surrounding concrete is seriously deteriorated. Emergency repairs may be required for all lanes to remain open. Temporary joint support from underneath may be necessary.

5.07.02 Other Joint Michigan Bridge Element Inspection

Element level information shall be collected for all joint systems present using the Michigan Bridge Element Inspection Manual elements and condition states. The joints shall be measured along the skew angle. For the purpose of Michigan Bridge Element Inspection, Element 306 (Other Joints) is used to classify systems that cannot be defined by any of the previously described types. Review Section 5.06 for commentary regarding additional joint elements that are regularly employed to accommodate superstructure expansion.

Examples of Element 306 include block out style and partial depth strip seal joints. Although these systems accommodate expansion and utilize many materials that are identical to Element 300 (Strip Seal Expansion Joint), durability is appreciably reduced because the devices are bonded to the structural deck

MICHIGAN STRUCTURE INSPECTION MANUAL
BRIDGE INSPECTION – ROUTINE AND CONDITION BASED IN-DEPTH INSPECTION

with elastomeric concrete or fastened mechanically. Maintenance records for MDOT owned bridges have shown that the materials often delaminate or become unsecure from the conventional concrete block out surface in as little as ten years. The reduced section of reinforced concrete deck for the block out may also crack and shear from the remaining section rendering the joint ineffective. Collecting either type of these joint systems and coding them as Element 300 would skew deterioration modeling so they shall be recorded as Element 306.

Timely maintenance for all joints is important, but the prevention of damage caused from pavement stress is paramount as the damage affects the superstructure and/or substructure. Pavement growth is currently the leading cause for the installation of temporary supports on MDOT owned bridges, as the damage far exceeds requests stemming from section loss or other causes. Additional information regarding the symptoms to look for may be found in the MDOT guide [Alleviating the Effects of Pavement Growth on Structures](#). A second cause for inspecting these joints is due to failure of the closed cell foam. Missing joint material may lead to rapid erosion of the pavement subbase which requires prompt corrective action (see Figure 5.07.02). If a pressure relief joint has been installed in the approach as a proactive measure to eliminate damage from occurring, or a reactive measure where repairs or temporary supports are in-place, then condition state quantities for Element 828 (Pressure Relief Joints) shall be collected.



Figure 5.07.02 Erosion Induced By Missing Pressure Relief Joint Material

Joint elements which serve to accommodate rotation or horizontal translation of the superstructure are BMEs which were developed for improved deterioration modeling, analysis, and planning efforts. Element 828 is an ADE that has been developed to reduce any further damage to the superstructure and substructure. This element will also provide a relative timeline for the rate at which these joints must be replaced which will improve planning and reduce the number of temporary supports required in the future. The quantities and condition state data for Element 828 are linked to Element 306 for annual

MICHIGAN STRUCTURE INSPECTION MANUAL
BRIDGE INSPECTION – ROUTINE AND CONDITION BASED IN-DEPTH INSPECTION

reporting to FHWA. The data provided must be accurate as it will be evaluated during future quality assurance and NBIP reviews.

5.07.03 Other Joint Work Recommendations

The team leader should provide work recommendations for joint maintenance or replacement once it is observed that the function or effectiveness has been compromised. Examples of work recommendations to include are identified in Table 5.07.02.

One of the most common failures for other joints occurs where the superstructure is fixed at the abutment. Pourable materials are traditionally used in these locations because movement is minimal. However, these types of joints are prone to accelerated deterioration and require consistent maintenance to prevent damage. Loss of seal adhesion may cause costly damage to the substructure, loss of engineered fill supporting the approach slab, and adjacent spalling of the surface (see Figure 5.07.03).



Figure 5.07.03 Failed Approach Slab Resulting from Erosion of Backfill

For pressure relief joints, a recommendation must be provided for the replacement if the opening between the pavement slabs measures 2" or less. Discoloration, tears, or cracking in the foam or rubber usually do not require any action to be initiated if debris or incompressible particles are retained on the surface. Failure to ensure adequate separation of the slabs for expansion during peak seasonal temperatures may lead to additional structural damage.

MICHIGAN STRUCTURE INSPECTION MANUAL
BRIDGE INSPECTION – ROUTINE AND CONDITION BASED IN-DEPTH INSPECTION

Table 5.07.02 Work Recommendations for Other Joints

Recommendation	Defects	Additional Information
Reseal End Joints	Leakage, pourable joints loss of adhesion	Vital for reducing rate of substructure deterioration
Replace Pressure Relief Joint	Inadequate, 1" to 2" wide or material is missing	Reduces damage to superstructure and substructure
Seal Construction Joints	Leakage, or Efflorescence with rust staining	Reduces adjacent deck spalling

Prioritize work recommendations according to the general guidelines provided below. Reference the element, location, and describe the extent of rehabilitative measures required. Submit a Request for Action (RFA) for any activity that should be completed prior to the next scheduled routine inspection.

High Priority Work Recommendations

Any structural repairs or replacement of bridge elements that should be completed within 24 to 60 months. High Priority work recommendations consist of any activity that will function to maintain safe load carrying capacity or preserve existing primary component condition ratings.

Medium Priority Work Recommendations

Any structural or non-structural repairs that should be completed within 24 to 60 months. Medium priority work recommendations serve to improve existing component and element condition ratings that are currently in fair or better condition.

Low Priority Work Recommendations

Any repairs that should be scheduled in conjunction with other planned work at the structure. Low priority work recommendations may have little to no effect on primary component condition ratings.

5.07.04 Other Joint Request for Action

An RFA shall be submitted to the bridge owner when the condition of the joint poses a hazard to motorists, if a detailed inspection is required, or whenever an action should be completed prior to the next scheduled routine inspection. Corrective action or repairs that do not require completion prior to the next scheduled routine inspection should be identified as a work recommendation on the BSIR. Examples of defects that trigger an RFA submittal for resolution and/or investigation of three primary joint systems are provided in Table 5.07.03. For other types of joints an RFA shall be submitted as-needed requesting corrective action and repairs. The RFA shall be submitted in MiB^{RIDGE} with proper documentation and photographs so an adequate review and resolution of the process may be completed.

MICHIGAN STRUCTURE INSPECTION MANUAL
BRIDGE INSPECTION – ROUTINE AND CONDITION BASED IN-DEPTH INSPECTION

Table 5.07.03 RFA Examples for Other Joints

Request for Action	Applicable Expansion Joint Systems		
	Pressure Relief	Compression	Pourable
Joint Opening Measures Less than 1" Wide	X		
Severe Spalling in Traveled Lanes Adj. to Joint	X	X	X
Significant Erosion Due to Loss of Seal Adhesion	X	X	X
Leakage Impacting Condition of Non-Redundant Members		X	X

5.07.05 Other Joint In-Depth Inspection

In-depth inspection of other joints is usually not required as the defects may often be observed from distances normally associated with routine inspection. In cases where the need arises to perform further investigation Section 5.06 may be referenced for more information. Detailed inspection or documented review of Other Joints in Condition State 4 is not required for Michigan Bridge Element Inspection.

5.08 Railings (BSIR #4)

Railings may be installed solely for the protection of motorists, pedestrians, or a combination of both. The geometry and impact resistance of them are dependent according to the designated purpose and period in which they were installed. Pedestrian railings must meet minimum standard height requirements of 42" while the vertical height of those used for motorist safety is dependent according to specific test level requirements. As specified in the AASHTO *Standard Specifications for Highway Bridges* manual, previously crash tested railing should retain its test level approval and not have to be tested to meet the updated requirements of NCHRP Report 350.

Prior to performing field work, the team leader shall review the inventory information in order to determine whether the bridge is located on the National Highway System (NHS). Structures on the NHS require an appraisal according to the AASHTO manual, while non-NHS bridges may utilize specific state or governing authority standards. When the bridge is not located on the NHS and the organization has not created agency specific standards then the AASHTO Manual should be used for the evaluation. The description of the criteria used for each test level account for criteria that include vehicle weight, velocity, and impact angle includes:

- Test Level 1 - taken to be generally acceptable for work zones with low posted speeds and very low volume, low speed local streets;
- Test Level 2 - taken to be generally acceptable for work zones and most local and collector roads with favorable site conditions as well as where a small number of heavy vehicles is expected and posted speeds are reduced;

MICHIGAN STRUCTURE INSPECTION MANUAL
BRIDGE INSPECTION – ROUTINE AND CONDITION BASED IN-DEPTH INSPECTION

- Test Level 3 - taken to be generally acceptable for a wide range of high- speed arterial highways with very low mixtures of heavy vehicles and with favorable site conditions;
- Test Level 4 - taken to be generally acceptable for the majority of applications on high speed highways, freeways, expressways, and Interstate highways with a mixture of trucks and heavy vehicles;
- Test Level 5 - taken to be generally acceptable for the same applications as TL-4 and where large trucks make up a significant portion of the average daily traffic or when unfavorable site conditions justify a higher level of rail resistance;
- Test Level 6 - taken to be generally acceptable for applications where tanker-type trucks or similar high center of gravity vehicles are anticipated, particularly along with unfavorable site conditions.

Currently there are six types of approved railings for rehabilitation projects on MDOT owned bridges, and five of them may be used during reconstruction projects. Item 36 (Traffic Safety Features) must be reviewed during each inspection to determine if the bridge railing and associated safety systems have been accurately coded. Upon saving the BSIR the team leader acknowledges that the information has been reviewed and concurs with the previous coding. Item 36 consists of four segments which include:

- Item 36A (Bridge Railings)
- Item 36B (Transitions)
- Item 36C (Approach Guardrail)
- Item 36D (Approach Guardrail Terminal Ends)

Each segment must be carefully studied as an improper feature for one portion should not affect the entire system. The condition of the materials should not influence the SI&A coding. Guidelines for proper coding of each item from the SI&A manual consist of the following:

- 0) Inspected feature does not meet currently acceptable or a safety feature is required and none is provided.
- 1) Inspected feature meets currently acceptable standards.
- N) Not applicable or a safety feature is not required.

The purpose of the bridge railing is to contain and redirect an uncontrolled vehicle on the supported spans. The design of bridge railings has evolved over many years in order to accommodate increases in vehicle velocity and mass. Crash testing information for several bridge railing systems, including timber ones, is available on the [AASHTO Task Force 13 webpage](#). Existing railings may also be retrofitted to improve the rating. Examples of acceptable and unacceptable railings for accurate inventory coding of NHS or state-owned bridges include those shown in the following figures:

MICHIGAN STRUCTURE INSPECTION MANUAL
BRIDGE INSPECTION – ROUTINE AND CONDITION BASED IN-DEPTH INSPECTION



Figure 5.08.01 Type 5 Railing
Item 36A = 1



Figure 5.08.02 Type 4 Railing
Item 36 A=1



Figure 5.08.03 Four Tube Bicycle Railing
Item 36A = 1



Figure 5.08.04 Two Tube Railing
Item 36A = 1



Figure 5.08.05 Aesthetic Parapet Tube
Item 36A = 1



Figure 5.08.06 Thrie Beam Retrofit
Item 36A = 1

MICHIGAN STRUCTURE INSPECTION MANUAL
BRIDGE INSPECTION – ROUTINE AND CONDITION BASED IN-DEPTH INSPECTION



Figure 5.08.07 Parapet Railing
Item 36A = 0



Figure 5.08.08 Three Tube Railing
Item 36A = 0



Figure 5.08.09 R4 Railing
Item 36A = 0



Figure 5.08.10 Timber Brush Block
Item 36A = N

The four Item 36 segments shall be coded “N” for bridges that carry railway freight, culverts that do not have a railing system fastened to the structure because the amount of cover is sufficient for driven posts, or culverts with ends that have adequate clear distance from the route shoulder.

At the termination of each end of the bridge railing a proper transition must be installed. The transition section is often tapered with additional posts that increase rigidity of the railing near the span connection (see Figure 5.08.11). This prevents excessive movement of the guardrail system during impact that could cause pocketing and unwarranted deceleration. MDOT Bureau of Highway Development [Standard Plan R-67-F](#) provides details for currently approved guardrail anchorages connected to multiple types of railings.

The approach guardrail should be of adequate length that it prevents motorists from hazards as they approach the structure. At locations where the jurisdictional authority of the roadway on either side of the structure is owned by another agency the requirement for guardrail installation may be determined according to the organization’s standards and practices.

MICHIGAN STRUCTURE INSPECTION MANUAL
BRIDGE INSPECTION – ROUTINE AND CONDITION BASED IN-DEPTH INSPECTION

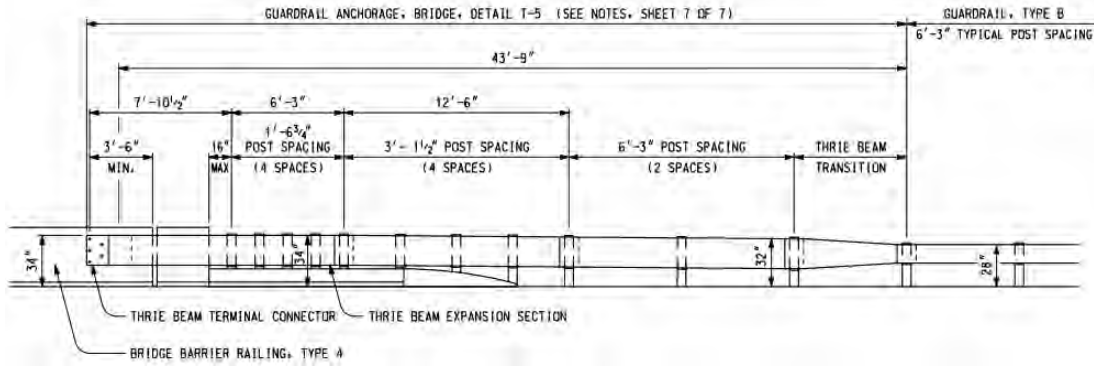

Figure 5.08.11 T-5 Bridge Barrier Railing Guardrail Transition

The approach guardrail end incorporates a series of special elements to attenuate the force caused by impact. This usually consists of a series of wood posts with reduced shear capacity, bracket, cable, and specialized terminal head or end shoe. Depending on the type of service and the direction of traffic the guardrail end may be outfitted with approach or departing terminal ends (see Figures 5.08.12 and 5.08.13.).



Figure 5.08.12 Approach Terminal



Figure 5.08.13 Departing Terminal

5.08.01 Concrete Railing Routine NBI Inspection

Concrete present in bridge railings is usually cast-in-place and may be limited to posts, brush blocks, or be the principal material used. Concrete railings with formed aesthetic features may require additional effort in order to identify and quantify defects. When concrete surface coating is applied to a railing the NBI condition rating may not be increased unless other rehabilitation measures were completed to reduce the magnitude of deterioration. Railings may consist of two or more materials, and the most severe deterioration should control the assigned ratings. The team leader shall perform the procedures listed for the routine inspection for concrete bridge railing, and review Chapter 7 of the BIRM for additional considerations during the inspection.

1. Inspect the entire length of each concrete bridge railing element on the supported spans for cracking. Document the approximate location, orientation, width and spacing of the cracking.

MICHIGAN STRUCTURE INSPECTION MANUAL
BRIDGE INSPECTION – ROUTINE AND CONDITION BASED IN-DEPTH INSPECTION

2. Inspect the entire length of each concrete bridge railing element on the supported spans for delamination and spalling. Pay special attention at areas near expansion joints where an insufficient opening in the railing may lead to premature localized deterioration. If substantial spalling has occurred evaluate the area to determine if it affects the integrity of the railing. Document the approximate location, percentage of railing area affected, and depth (if applicable) of both delamination and spalling.
3. Inspect the entire length of each concrete bridge railing on the supported spans for damage from vehicular impact. Document the approximate location and observed defects as a result of the impact.
4. Inspect the areas of concrete surrounding fasteners that secure steel or aluminum tube tubing or pedestrian fence posts. Document the approximate location of areas where deterioration may compromise the strength of the attachment.
5. Record photos of deficiencies when a change in the condition rating occurs and review the in-depth inspection procedures for suggested follow-up activities.

The evaluation of concrete railing shall conform to the summarized conditions provided in Table 5.08.01. The MDOT Bridge Safety [NBI Rating Guidelines](#) shall be used to assign an overall code to the condition of the entire length present. This item for structures without railings, those that only serve to carry railway freight, and culverts that do not have railing fastened to the structure shall be coded “N”. A statement is required if the railing is constructed on only one side of the bridge or if a thrie beam retrofit is in place. Brush blocks are considered as part of the railing.

Table 5.08.01 Summarized Concrete Railing Rating Guidelines

Good	Shallow hairline cracks less than 1/32" or shallow scaling. Minor deterioration or collision damage.
Fair	Moderate deterioration with cracks and spalls or scaling limited to less than 5% of the surface area. Minor collision damage with the majority of connections securely attached.
Poor	Major deterioration with cracks and spalls or scaling greater affecting between 5% and 10% of the surface area. Moderate collision damage or loose connections without substantial impact on railing performance.
Serious	Major deterioration with cracks and spalls or scaling greater affecting more than 10% of the surface area. Collision damage or loose connections should be repaired prior to the next scheduled inspection.
Critical	Most of the railing components exhibit deterioration and/or loss of section. Collision damage and deterioration has progressed to the point where the railing may fail if impacted. Immediate repairs are required for the structure to remain open.

MICHIGAN STRUCTURE INSPECTION MANUAL
BRIDGE INSPECTION – ROUTINE AND CONDITION BASED IN-DEPTH INSPECTION

5.08.02 Concrete Railing Michigan Bridge Element Inspection

Element level information shall be collected for all concrete bridge railings using the Michigan Bridge Element Inspection Manual elements and condition states. The types of bridge railing that are commonly installed within the Michigan inventory which shall be identified as Element 331 (Reinforced Concrete Bridge Railing) are provided in Table 5.08.02. The table also provides standardized usage factors for protective coatings and references an appropriate figure for clarification. The Aesthetic Parapet will require the use of multiple condition state tables. Parapet Railing with aluminum tube and posts (without thrie beam retrofit) will also require the use of multiple condition state tables, but a protective system for the metal will not be added.

For railing types that are not defined in Section 5.08, and two or more primary materials exist, use Element 331 when more than 50% of the surface exposed directly to impact is comprised of concrete.

FHWA permits the total length of railing to be entered on the element report for each kind of railing material that exists. For example, a 20' long structure with 40' of railing that is composed of reinforced concrete and galvanized steel tube may have two corresponding element entries on the report, and it would appear that 80' of railing is present on the bridge. Since this practice may lead to confusion and misunderstanding during the implementation of bridge maintenance or other management efforts MDOT policy requires that the total quantity on the supported spans match the total quantity on the element inspection report.

All of the elements shown are NBEs that were created for improved deterioration modeling, analysis, and planning efforts. The data provided must be accurate as it will be evaluated during future quality assurance and NBIP reviews.

Table 5.08.02 Railing Design Types and Protective Coating Factors for Element 331

Element 331 Railing Design Types	Concrete Protective Coating Perimeter (per linear ft.)	Reference Figure for Concrete Perimeter	Steel Protective Coating Perimeter (per linear ft.)	Reference Figure for Steel Perimeter
Type 5	6.5 sft.	5.08.14	N/A	N/A
Type 4	7.5 sft.	5.08.15	N/A	N/A
Aesthetic Parapet	4.9 sft.	5.08.16	*2.3 sft.	5.08.17
Parapet	5.8 sft.	5.08.18	N/A	N/A (Aluminum)

Note: *Assumes maximum post spacing specified in Standard Plan B-25-H

MICHIGAN STRUCTURE INSPECTION MANUAL
BRIDGE INSPECTION – ROUTINE AND CONDITION BASED IN-DEPTH INSPECTION

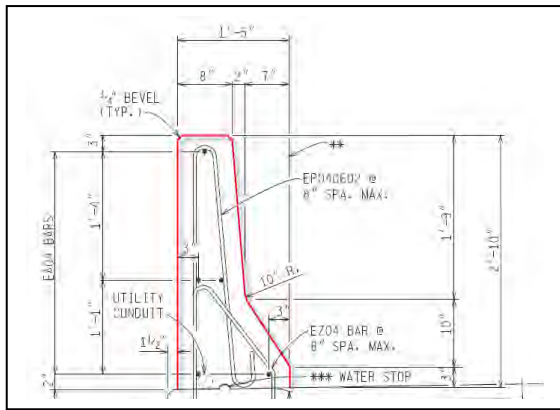

Figure 5.08.14 Type 5 Concrete Perimeter

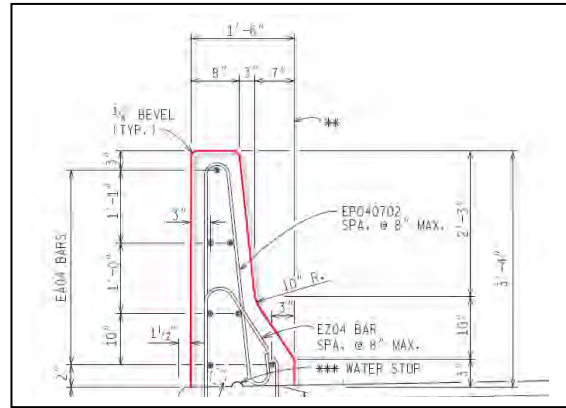

Figure 5.08.15 Type 4 Concrete Perimeter

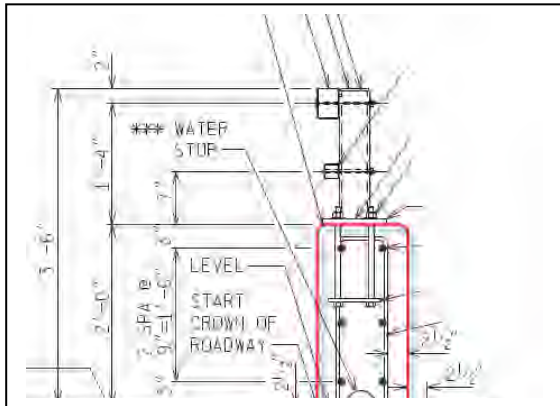

Figure 5.08.16 Aesthetic Parapet Conc. Perimeter

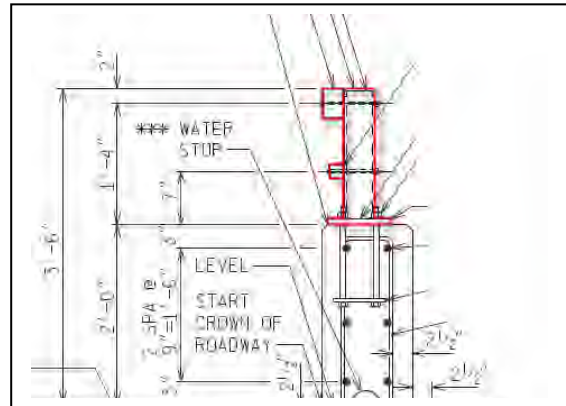

Figure 5.08.17 Aesthetic Parapet Steel Perimeter

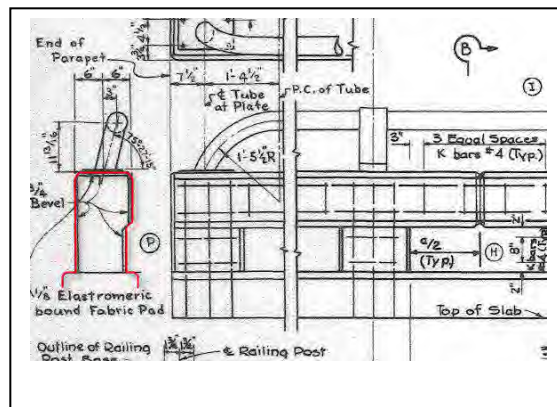

Figure 5.08.18 Parapet Concrete Perimeter

MICHIGAN STRUCTURE INSPECTION MANUAL
BRIDGE INSPECTION – ROUTINE AND CONDITION BASED IN-DEPTH INSPECTION

5.08.03 Steel Railing Routine NBI Inspection

Steel present in bridge railings is usually galvanized or coated to prevent premature deterioration. The steel used for the railing system may consist of posts that support horizontal timber rails, short height posts that are attached to anchors embedded into concrete barrier with steel railing, or a full height system where it is the sole material employed. The procedures provided shall also be applied for the inspection of aluminum railing components. Railings may consist of two or more materials, and the most severe deterioration should control the assigned ratings. The team leader shall perform the procedures listed for routine inspection for steel bridge railings, and review Chapter 7 of the BIRM for additional considerations during the inspection.

1. Inspect the entire length of each bridge railing on the supported spans for protective coating failure. Document the approximate location and estimated percentage of paint or galvanizing failure.
2. Inspect the entire length of each bridge railing for section loss. When section loss is measurable evaluate the area to determine if it affects the integrity of the railing or if an in-depth inspection is warranted. Document the approximate location and estimated percentage of section loss.
3. Inspect the entire length of each bridge railing on the supported spans for damage from vehicular impact. Document the approximate location and observed defects as a result of the impact.
4. Inspect the entire length of the bridge railing for loose or missing connections. Evaluate loose or missing connections and determine if they affect the integrity of the railing or if immediate actions are warranted. Document the location of loose, deteriorated, or damaged fasteners.
5. Record photos of deficiencies when a change in the condition rating occurs and review the in-depth inspection procedures for suggested follow-up activities.

The evaluation of steel railing shall conform to the summarized conditions provided in Table 5.08.03. The MDOT Bridge Safety [NBI Rating Guidelines](#) shall be used to assign an overall code to condition of the entire length present. This item for structures without railings, those that only serve to carry railway freight, and culverts that do not have railing fastened to the structure shall be coded “N”. A statement is required if the railing is constructed on only one side of the bridge or if a thrie beam retrofit is in place. Brush blocks are considered as part of the railing.

Table 5.08.03 Summarized Steel Railing Rating Guidelines

Good	Protective coating failures in very small and scattered locations. Minor deterioration or collision damage.
Fair	Protective coating failure is limited to less than 5% of the surface area with minor loss of section. Minor collision damage with the majority of connections securely attached.

**MICHIGAN STRUCTURE INSPECTION MANUAL
BRIDGE INSPECTION – ROUTINE AND CONDITION BASED IN-DEPTH INSPECTION**

Poor	Protective coating failure affecting between 5% and 10% of the surface area with some loss of section. Moderate collision damage or loose connections without substantial impact on railing performance.
Serious	Protective coating failure affecting more than 10% of the surface area with measurable loss of section. Collision damage or loose connections should be repaired prior to the next scheduled inspection.
Critical	Most of the railing components exhibit deterioration and/or loss of section. Collision damage and deterioration has progressed to the point where the railing may fail if impacted. Immediate repairs are required for the structure to remain open.

5.08.04 Steel Railing Michigan Bridge Element Inspection

Element level information shall be collected for all metal bridge railings using the Michigan Bridge Element Inspection Manual elements and condition states. The types of steel bridge railings that are commonly installed within the Michigan inventory which shall be identified as Element 330 (Metal Bridge Railing) are provided in Table 5.08.04. This table also provides standardized usage factors for protective coatings and references an appropriate figure for clarification.

For railing types that are not defined in Section 5.08, and two or more primary materials exist, use Element 330 when more than 50% of the surface exposed directly to impact is comprised of metal.

Table 5.08.04 Railing Design Types and Protective Coating Factors for Element 330

Element 330 Railing Types	Steel Protective Coating Perimeter (per linear ft.)	Reference Figure for Steel Perimeter	Concrete Protective Coating Perimeter (per linear ft.)	Reference Figure for Concrete Perimeter
Four Tube	6.9	5.08.19	2.9	5.08.20
Two Tube	4.3	5.08.21	2.7	5.08.22
Thrie Beam Retrofit	1.66	5.08.23	N/A	5.08.24

As stated in the concrete railing section, FHWA permits the total length of railing to be entered on the element report for each kind of railing material that exists. Since this practice may lead to confusion and misunderstanding during the implementation of bridge maintenance or other management efforts, MDOT policy requires that the total quantity on the supported spans match the total quantity on the element inspection Report.

All of the elements shown are NBEs that have been created by AASHTO. Quantities and condition state information are reported directly to FHWA on an annual basis. The data provided must be accurate as it will be evaluated during future quality assurance and NBIP reviews.

MICHIGAN STRUCTURE INSPECTION MANUAL
BRIDGE INSPECTION – ROUTINE AND CONDITION BASED IN-DEPTH INSPECTION

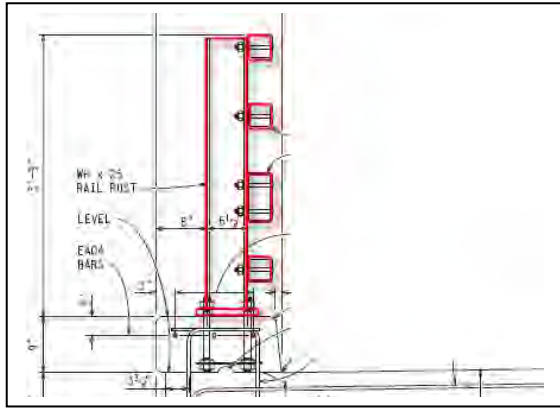

Figure 5.08.19 Four Tube Steel Perimeter

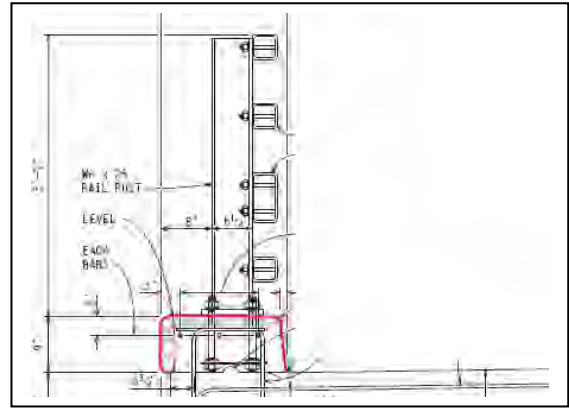

Figure 5.08.20 Four Tube Concrete Perimeter

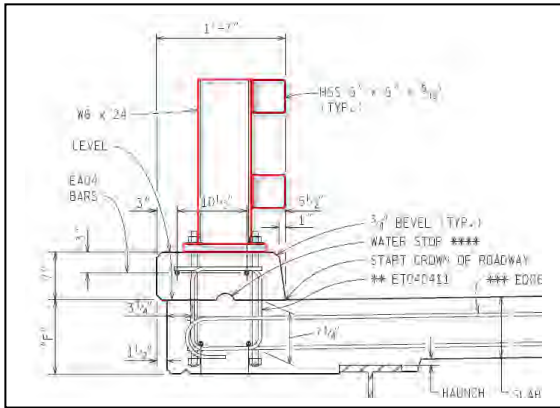

Figure 5.08.21 Two Tube Steel Perimeter

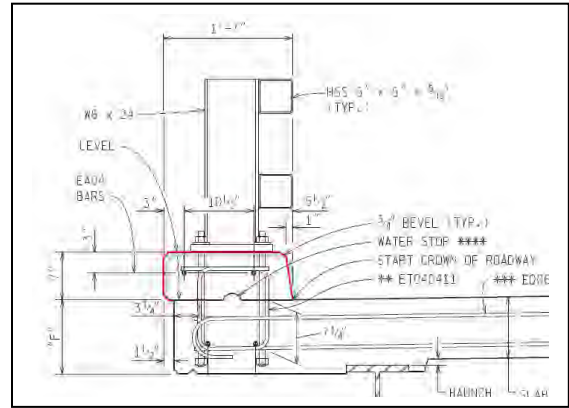

Figure 5.08.22 Two Tube Concrete Perimeter

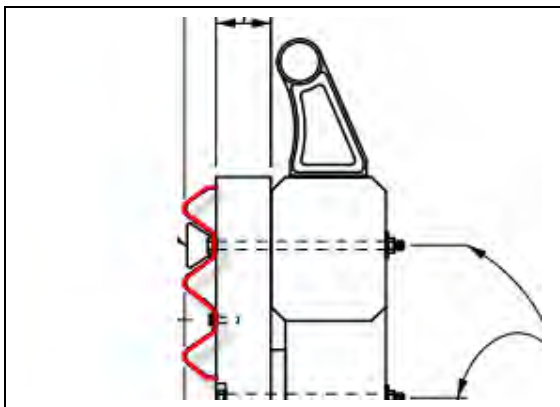

Figure 5.08.23 Thrie Beam Retrofit Steel Perimeter

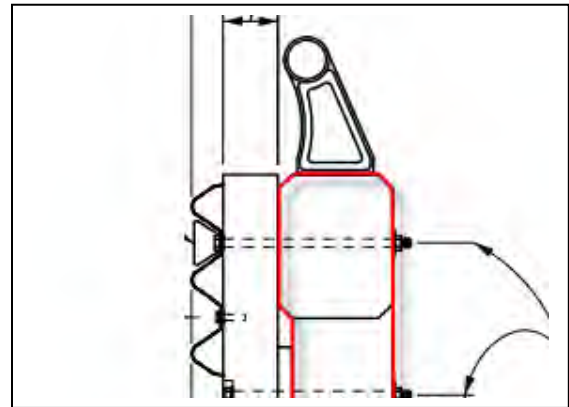

Figure 5.08.24 Thrie Beam Retrofit Conc. Perimeter

MICHIGAN STRUCTURE INSPECTION MANUAL
BRIDGE INSPECTION – ROUTINE AND CONDITION BASED IN-DEPTH INSPECTION

5.08.05 Timber Railing Routine NBI Inspection

Timber bridge railings are often used at parks or other locations where the speed limit and average daily traffic are very low. The timber used may be limited to horizontal rail sections or comprise the entire safety system. If the railing is painted or stained for an improved aesthetic appearance the NBI condition rating shall not be increased. Railings may consist of two or more materials, and the most severe deterioration should control the assigned ratings. The team leader shall perform the procedures listed for routine inspection, and review Chapter 7 of the BIRM for additional considerations during the inspection.

1. Inspect the entire length of each bridge railing on the supported spans for protective coating failure. Document the approximate location and estimate percentage of paint or galvanizing failure.
2. Inspect the entire length of each bridge railing for splits. Document the approximate location and estimated length to depth ratio of the splitting.
3. Inspect the entire length of each bridge railing for checks. Document the approximate location and estimated percentage of penetration into the section.
4. Inspect the entire length of each bridge railing for insect damage, decay, and section loss. When section loss is measurable evaluate the area to determine if it affects the integrity of the railing or if an in-depth inspection is warranted. Document the approximate location and estimated percentage of section loss.
5. Inspect the entire length of the bridge railing for loose or missing connections. Evaluate loose or missing connections and determine if they affect the integrity of the railing or if immediate actions are warranted. Document the location of loose, deteriorated, or damaged fasteners.
6. Inspect the entire length of each bridge railing on the supported spans for damage from vehicular impact. Document the approximate location and observed defects as a result of the impact (see Figure 5.08.25).
7. Record photos of deficiencies when a change in the condition rating occurs and review the in-depth inspection procedures for suggested follow-up activities.

MICHIGAN STRUCTURE INSPECTION MANUAL
BRIDGE INSPECTION – ROUTINE AND CONDITION BASED IN-DEPTH INSPECTION



Figure 5.08.25 Timber Railing Damage at the Transition Connection

The evaluation of timber railing shall conform to the summarized conditions provided in Table 5.08.05. The MDOT Bridge Safety [NBI Rating Guidelines](#) shall be used to assign an overall code to condition of the entire length present. This item for structures without railings, those that only serve to carry railway freight, and culverts that do not have railing fastened to the structure shall be coded “N”. A statement is required if the railing is constructed on only one side of the bridge or if a thrie beam retrofit is in place. Brush blocks are considered as part of the railing.

Table 5.08.05 Summarized Timber Railing Rating Guidelines

Good	Paint or other coating failures in very small and scattered locations. Minor weathering present. Minor deterioration or collision damage.
Fair	Moderate checks, splitting, or decay that affects less than 10% of the member thickness. Minor collision damage with the majority of connections securely attached.
Poor	Major checks, splitting, or decay that affects more than 10% of the member thickness. Moderate collision damage or loose connections without substantial impact on railing performance.
Serious	Decay that affects more than 15% of the member thickness. Collision damage or loose connections should be repaired prior to the next scheduled inspection.
Critical	Most of the railing components exhibit deterioration and/or loss of section. Collision damage and deterioration has progressed to the point where the railing may fail if impacted. Immediate repairs are required for the structure to remain open.

5.08.06 Timber Railing Michigan Bridge Element Inspection

Element level information shall be collected for all timber bridge railings using the Michigan Bridge Element Inspection Manual elements and condition states. Element 332 (Timber Bridge Railing) shall be

MICHIGAN STRUCTURE INSPECTION MANUAL
BRIDGE INSPECTION – ROUTINE AND CONDITION BASED IN-DEPTH INSPECTION

used when the primary surface exposed to impact is timber. There are currently no protective coating elements for timber materials.

As stated in the concrete railing section, FHWA permits the total length of railing to be entered on the element report for each kind of railing material that exists. Since this practice may lead to confusion and misunderstanding during the implementation of bridge maintenance or other management efforts, MDOT policy requires that the total quantity on the supported spans match the total quantity on the element inspection Report.

All of the elements shown are NBEs that have been created by AASHTO. Quantities and condition state information are reported directly to FHWA on an annual basis. The data provided must be accurate as it will be evaluated during future quality assurance and NBIP reviews.

5.08.07 Railing Work Recommendations

The team leader should provide work recommendations for all types of bridge railing systems regardless of condition. Several examples of recommendations that work to reduce the rate of deterioration or improve condition are provided in Table 5.08.06. Unfortunately, maintenance work on railing systems is typically only performed as-needed as a result of impact damage or severe deterioration. While the focus of preventive measures is often limited to the deck and superstructure, providing the bridge owner with options for consideration will increase the likelihood that repairs are completed during the scheduling of other maintenance activities.

Table 5.08.06 Work Recommendations for Railings

Concrete Railing Materials (NBI Rating ≥ 5)		
Recommendation	Defects	Additional Information
Water Repellent Treatment	Cracking, or Efflorescence without rust staining	Reduces rate of spalling and reinforcement corrosion
Vertical Joint Sealing	Debris Impaction, incompressible particles at expansion areas	Prevents damage during thermal expansion
Concrete Railing Patching	Delamination, or Spalling greater than 1" deep or 6" diameter	Improves NBI and element ratings
Steel Railing Materials (NBI Rating ≥ 5)		
Recommendation	Defects	Additional Information
Replace Coating	Chalking, Peeling, Effectiveness is limited	Reduces rate of corrosion and section loss
Repair Section Loss	Corrosion with measurable section loss	Improves NBI and element ratings
Repair Connections	Connections loose, missing, or broken	Improves NBI and element ratings
Replace Damaged Elements	Damage from vehicles is moderate	Improves NBI and element ratings

MICHIGAN STRUCTURE INSPECTION MANUAL
BRIDGE INSPECTION – ROUTINE AND CONDITION BASED IN-DEPTH INSPECTION

Timber Railing Materials (NBI Rating \geq 5)		
Recommendation	Defects	Additional Information
Water Repellent Treatment	Decay, affects less than 10% or less of the member	Preserves condition to protect deck
Replace/Install Coating	Chalking, Peeling, Effectiveness is limited	Reduces rate of decay and section loss
Repair Section Loss	Decay with measurable section loss	Improves NBI and element ratings
Repair Connections	Connections loose, missing, or broken	Improves NBI and element ratings

Prioritize work recommendations according to the general guidelines provided below. Reference the element, location, and describe the extent of rehabilitative measures required. Submit a Request for Action (RFA) for any activity that should be completed prior to the next scheduled routine inspection.

High Priority Work Recommendations

Any structural repairs or replacement of bridge elements that should be completed within 24 to 60 months. High Priority work recommendations consist of any activity that will function to maintain safe load carrying capacity or preserve existing primary component condition ratings.

Medium Priority Work Recommendations

Any structural or non-structural repairs that should be completed within 24 to 60 months. Medium priority work recommendations serve to improve existing component and element condition ratings that are currently in fair or better condition.

Low Priority Work Recommendations

Any repairs that should be scheduled in conjunction with other planned work at the structure. Low priority work recommendations may have little to no effect on primary component condition ratings.

5.08.08 Railing Request for Action

An RFA shall be submitted to the bridge owner when the bridge railing may fail if impacted or when other severe conditions exist that jeopardize safety. This may be caused by extensive deterioration of the underlying structural deck supporting the railing, missing connections, deterioration of the railing material itself, or other causes. It shall also be submitted for detailed inspections, whenever an action should be completed prior to the next scheduled routine inspection, or as documented review of element quantities in Condition State 4. Corrective action or repairs that do not require completion prior to the next scheduled routine inspection should be identified as a work recommendation on the BSIR.

Examples of defects or activities that trigger an RFA submittal for resolution and/or investigation of three railing materials are provided in Table 5.08.07. For other railing materials or defects submit the RFA. The RFA shall be submitted in MiB^{RIDGE} with proper documentation and photographs so an adequate review and resolution of the process may be completed.

**MICHIGAN STRUCTURE INSPECTION MANUAL
BRIDGE INSPECTION – ROUTINE AND CONDITION BASED IN-DEPTH INSPECTION**

Table 5.08.07 RFA Examples for Bridge Railing Systems

Request for Action	Railing Materials		
	Concrete	Steel	Timber
In-Depth Inspection	X	X	X
Condition State 4 Element Quantities	X	X	X
Severe Impact Damage	X	X	X
Vandalized/Missing Safety Features	X	X	X
Section Loss Compromising Strength	X	X	X
Severe Insect Infestation			X

5.08.09 Railing In-Depth Inspection

In-depth inspections shall be performed as-needed and condition based recommendations are provided in Table 5.08.08. Due to the importance of railing systems and the safety that they provide to the public, it is strongly recommended to perform a hands-on inspection when the condition rating of the Railing (BSIR #4) is coded 5 or less for concrete and steel systems, and 4 or less for timber ones. Repetitive detailed inspections should also be completed for railings that are rated in poor condition at the increased frequency described in the table or as the severity of defects dictate. Detailed inspection or documented review of railings is required for Michigan Bridge Element Inspection when any quantity, excluding protective systems (galvanizing, concrete surface coating, etc.), is coded in Condition State 4 (see Figure 5.08.26).

Table 5.08.08 Recommended Condition Based In-Depth Inspection Guideline for Bridge Railings

NBI Rating	Schedule Initial In-depth Within	In-Depth Frequency	Applicable Railing Materials		
			Concrete	Steel	Timber
5	24 Months	As-Needed	Concrete	Steel	
4	12 Months	48 Months	Concrete	Steel	Timber
3	6 Months	36 Months	Concrete	Steel	Timber

When a lane closure is necessary to perform the inspection because of safety concerns, in lieu of only closing the shoulder, the bridge owner will be notified prior to performing the work. At a minimum, it is expected that the locations where materials have been coded in Condition State 4, and other areas that display the greatest degree of distress will be inspected.

MICHIGAN STRUCTURE INSPECTION MANUAL
BRIDGE INSPECTION – ROUTINE AND CONDITION BASED IN-DEPTH INSPECTION



Figure 5.08.26 Steel Railing Posts in Condition State 4 Require Documented Review

Approval for each in-depth inspection should be documented through the submittal of an RFA to the bridge owner using MiB^{BRIDGE}. When the inspection is performed immediately in response to public safety concerns the inspection should be referenced on an RFA submitted after the work has been completed. These processes are necessary for confirming that the work has been completed and will be reviewed annually during QA and FHWA NBIP reviews.

Most in-depth inspections will require sounding the surface to identify defects and measuring the ones that are readily apparent. Concrete and timber railing surfaces should be sounded to identify locations of delamination or interior decay. Areas of severe corrosion on steel railings should be measured for determination of section loss. The railings shall be inspected for all of the defects identified in the appropriate material specific condition state table found in the Michigan Bridge Element Inspection Manual. On occasion, samples may be extracted for additional laboratory testing to determine whether repairs are adequate or replacement of the entire length is required (see Figure 5.08.27).

The minimum information included in the in-depth inspection report shall be a sketch of the areas examined with measured defects provided for each span. Areas that were not examined shall also be delineated on the drawing for future consideration. The level of detail provided must allow for an efficient recurrent in-depth inspection to be conducted in order to determine if the condition of the surface has changed. Photographs of the deficient areas should accompany the sketch and written report findings. Upon completion of an in-depth inspection that is completed in response to NBI condition ratings, the BSIR and element report should also be modified to reflect the data gathered when changes in the condition ratings are required.

MICHIGAN STRUCTURE INSPECTION MANUAL
BRIDGE INSPECTION – ROUTINE AND CONDITION BASED IN-DEPTH INSPECTION



Figure 5.08.27 Coring Concrete Railing for ASR Testing

MICHIGAN STRUCTURE INSPECTION MANUAL
BRIDGE INSPECTION – ROUTINE AND CONDITION BASED IN-DEPTH INSPECTION

5.09 Sidewalks or Curbs (BSIR #5)

Sidewalks allow pedestrians to safely traverse the supported spans and should be inspected similarly to the deck surface, but consideration for the use and functionality must be accommodated. Care should be paid to any hazards that may adversely affect pedestrian traffic. Examples include expansion joints that are not outfitted with cover plates at sidewalks, spalls, damaged electrical handhole covers, or any other issue that may harm an individual traversing the designated walkway (see Figure 5.09.01). Curbs serve to redirect precipitation runoff to designated drainage devices. NBI structures absent of a curb system generally show signs of increased deterioration along the fascia superstructure surfaces and substructure as meltwater laden with corrosive deicing materials flows freely from the deck surface.



Figure 5.09.01 Damaged Steel Sliding Plates Present a Hazard for Pedestrians

Structure Inventory & Appraisal (SI&A) Item 50 Curb or Sidewalk Widths should be reviewed during each inspection in order to verify that the measurements have been correctly recorded; this action is especially important if a deck replacement recently occurred. The width shall be measured from the toe of the curb to the inside face of the bridge railing. Item 50 consists of two segments which include 50A (Left Curb or Sidewalk Width) and 50B (Right Curb or Sidewalk Width)

Orientation may be determined by the direction of traffic carried on the structure. For bridges which have traffic in both directions the direction the reference shall be south to north or west to east. When sidewalks and curbs do not exist a value should not be added to Item 50.

MICHIGAN STRUCTURE INSPECTION MANUAL
BRIDGE INSPECTION – ROUTINE AND CONDITION BASED IN-DEPTH INSPECTION

5.09.01 Concrete Sidewalk or Curb Routine NBI Inspection

Concrete is the most prevalent material used for sidewalks and curbs and the deterioration rate of which, in comparison to the deck surface, is noticeably tardy. However, preventive maintenance treatments may not always be applied to sidewalks as the benefits compared to costs of such action are often debated by bridge owners. This may lead to material conditions that are comparable to the deck surface over an extended period of time. The team leader shall perform the procedures listed for routine inspection, and review Chapter 7 of the BIRM for additional considerations during the inspection. Sidewalks may consist of one or more materials, and the most severe deterioration should control the assigned ratings. The area to be evaluated includes the section extending above the structural deck.

1. Inspect the sidewalk or curb for cracking, and investigate whether any observed cracking is structural or non-structural. Document the approximate location, orientation, width and spacing of cracking.
2. Inspect the sidewalk or curb for delamination and spalling. When exposed reinforcement is observed evaluate the location to determine if it presents a safety hazard to pedestrians. Document the approximate location, percentage of sidewalk affected, and depth (if applicable) of both delamination and spalling.
3. Inspect the entire length of sidewalk or curb for scaling. Document the approximate location, percentage of deck area affected, and estimated depth of scaling.
4. Inspect the entire length of sidewalk or curb where shallow, deep, or full depth concrete patches are located. Concrete patches that are sound without signs of distress shall not be considered in the tabulation of poor surface area. Document the approximate, and percentage of deck area with deficient concrete patches.
5. Inspect the entire length of sidewalk for any deficiencies that may pose a hazard to pedestrians. Document the approximate location and provide descriptive information regarding the concern.
6. Inspect the sidewalk or curb for impact damage. Document the approximate location and degree of damage caused by snowplows or vehicles in the comments field on the BSIR.
7. Record photos of deficiencies when a change in the condition rating occurs and review the in-depth inspection procedures for suggested follow-up activities.

The evaluation of concrete sidewalks and curbs shall conform to the summarized conditions provided in Table 5.09.01. The MDOT Bridge Safety [NBI Rating Guidelines](#) shall be used to assign an overall code to condition of the entire length present. This item for structures without sidewalks or curbs shall be coded

MICHIGAN STRUCTURE INSPECTION MANUAL
BRIDGE INSPECTION – ROUTINE AND CONDITION BASED IN-DEPTH INSPECTION

“N”. A statement is required if sidewalk is only constructed on one side of the bridge. The evaluation of brush blocks shall be included during the inspection of railings.

Table 5.09.01 Summarized Concrete Sidewalk and Curb Rating Guidelines

Good	Open cracks less than 1/16" wide or sealed cracks spaced at 10' or more. Light shallow scaling may be present.
Fair	Excessive surface cracking present. Spalling, delaminations, and unsound repairs affecting between 2% and 10% of the area. Surface scaling may be 1/2" to 1" deep.
Poor	Delamination or spalling affecting between 10% and 25% of the area. Excessive cracking or scaling that does not present a hazard to pedestrians
Serious	Spalling affecting more than 25% of the surface area and does not present a trip hazard to pedestrians.
Critical	Emergency repairs required for the sidewalk to remain open.

5.09.02 Concrete Sidewalk or Curb Michigan Bridge Element Inspection

Element level information shall be collected for the surface of all reinforced concrete sidewalks using the Michigan Bridge Element Inspection Manual Condition States. The quantity to be collected includes the area from edge to edge and reference line to reference line. Element 840 (Reinforced Concrete Sidewalk) shall be used to collect condition state quantities whether or not a wearing surface is present. In cases where Element 816 (Thin Overlay), Element 850 (Healer Sealer), or Element 521 (Concrete Protective Coating) exist the condition of Element 840 shall be determined by any visible distress in the surface material.

Additionally, an element for the sidewalk approach has been developed in order to identify safety issues that may occur immediately on either end of the main span of a pedestrian structure. These defects should be evaluated with condition state information entered using Element 858 (Concrete Pedestrian Approach).

A flowchart illustrating the process of determining the applicable elements for concrete deck surfaces has been provided for clarification (see Figure 5.09.02). All of the elements shown are ADEs that were created for to improve pedestrian safety and determine the deterioration of sidewalks with and without preventive measures applied. The data provided must be accurate as it will be evaluated during future quality assurance reviews

MICHIGAN STRUCTURE INSPECTION MANUAL
BRIDGE INSPECTION – ROUTINE AND CONDITION BASED IN-DEPTH INSPECTION

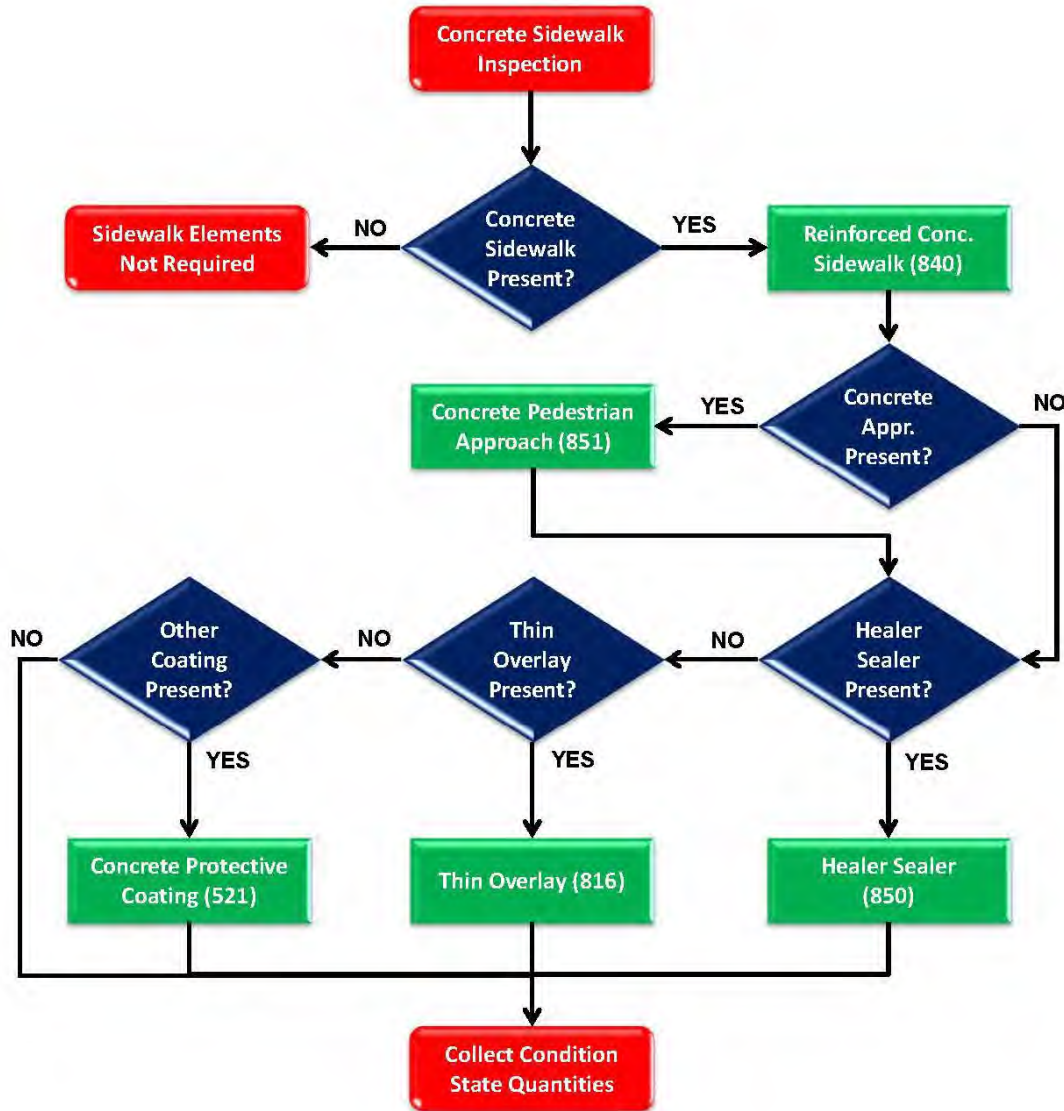

Figure 5.09.02 Deck Element Collection Process for Concrete Sidewalks

5.09.03 Steel Sidewalk or Curb Routine NBI Inspection

The use of steel for sidewalks and curbs is primarily limited to movable and lift bridges, but it may also be used to retrofit structures where a pedestrian crossing did not previously exist. Steel sidewalks may consist of open grid steel that is welded or riveted with or without concrete fill. The benefits of concrete fill include a smooth suitable walking surface that also helps to shield the components below from exposure to debris, precipitation, and deicing chemicals. Other less common steel sidewalks include corrugated or orthotropic systems with filler on the surface. The team leader shall perform the procedures listed for routine inspection, and review Chapter 7 of the BIRM for additional considerations during the inspection. Sidewalks may consist of one or more materials, and the most severe deterioration

MICHIGAN STRUCTURE INSPECTION MANUAL
BRIDGE INSPECTION – ROUTINE AND CONDITION BASED IN-DEPTH INSPECTION

should control the assigned ratings. The area to be evaluated includes the section extending above the structural deck.

1. Inspect the sidewalk or curb for protective coating failure. Note whether the failure is limited to the top application coat or to bare steel. Document the approximate location, percentage, and extent of paint or galvanizing failure.
2. Inspect the sidewalk or curb for corrosion and section loss. When section loss is measurable evaluate the area to determine if it affects the integrity of the sidewalk or if an in-depth inspection is warranted. Document the approximate location and estimated amount of section loss.
3. Inspect the sidewalk or curb for cracking. Cracks in orthotropic steel require follow-up actions to be performed. Document the approximate location, estimated length, and whether the cracks have been arrested.
4. Inspect the sidewalk or curb for loose or missing connections. Document the approximate location of loose, deteriorated, or damaged fasteners.
5. Inspect the sidewalk or curb for impact damage. Document the approximate location and degree of damage caused by snowplows or vehicles in the comments field on the BSIR.
6. Inspect the entire length of sidewalk for any deficiencies that may pose a hazard to pedestrians. Document the approximate location and provide descriptive information regarding the concern.
7. Record photos of deficiencies when a change in the condition rating occurs and review the in-depth inspection procedures for suggested follow-up activities.

The evaluation of steel sidewalks and curbs shall conform to the summarized conditions provided in Table 5.09.02. The MDOT Bridge Safety [NBI Rating Guidelines](#) shall be used to assign an overall code to condition of the entire length present. This item for structures without sidewalks or curbs shall be coded "N". A statement is required if sidewalk is only constructed on one side of the bridge. The evaluation of brush blocks shall be included during the inspection of railings.

MICHIGAN STRUCTURE INSPECTION MANUAL
BRIDGE INSPECTION – ROUTINE AND CONDITION BASED IN-DEPTH INSPECTION

Table 5.09.02 Summarized Steel Sidewalk and Curb Rating Guidelines

Good	Protective coating failure in very small and scattered locations.
Fair	Protective coating failure is limited to less than 5% of the surface area with minor loss of section. Loose fasteners or broken welds present but the connection is in place and functioning as intended.
Poor	Protective coating failure affecting between 5% and 10% of the surface area with measurable loss of section. Cracks that have not been arrested. Structural review not required.
Serious	Protective coating failure affecting more than 10% of the surface area with measurable loss of section. Missing fasteners or adjacent broken welds present that do not warrant a structural review.
Critical	Emergency repairs required for the sidewalk to remain open.

5.09.04 Steel Sidewalk or Curb Michigan Bridge Element Inspection

Element level information shall be collected for the surface of all steel sidewalks using the Michigan Bridge Element Inspection Manual Condition States. The quantity to be collected includes the area from edge to edge and reference line to reference line. Three elements have been developed which include Element 841 (Steel with Concrete Filled Grid Sidewalk), Element 842 (Steel with Open Grid Sidewalk), and Element 843 (Steel Corrugated/Orthotropic/Etc.). For steel grid that has been filled with concrete ensure that condition state quantities for any concrete protective coating or wearing surface elements are collected (see Figure 5.09.03). Similarly, if a steel protective coating is visible record condition state quantities for Element 515 (Steel Protective Coating). For Element 843 overlay materials shall not be collected.



Figure 5.09.03 Concrete Filled Steel Grid with Wearing Surface

**MICHIGAN STRUCTURE INSPECTION MANUAL
BRIDGE INSPECTION – ROUTINE AND CONDITION BASED IN-DEPTH INSPECTION**

Additionally, an element for the sidewalk approach has been developed in order to identify safety issues that may occur immediately on either end of the main span for pedestrian structures. Defects that are present should be evaluated with condition state information entered using Element 859 (Steel Pedestrian Approach). A flowchart illustrating the process of determining the applicable elements for steel sidewalks has been provided for clarification (see Figure 5.09.04). All of the elements shown are ADEs that were created for to improve pedestrian safety and determine the deterioration of sidewalks with and without preventive measures applied. The data provided must be accurate as it will be evaluated during future quality assurance reviews.

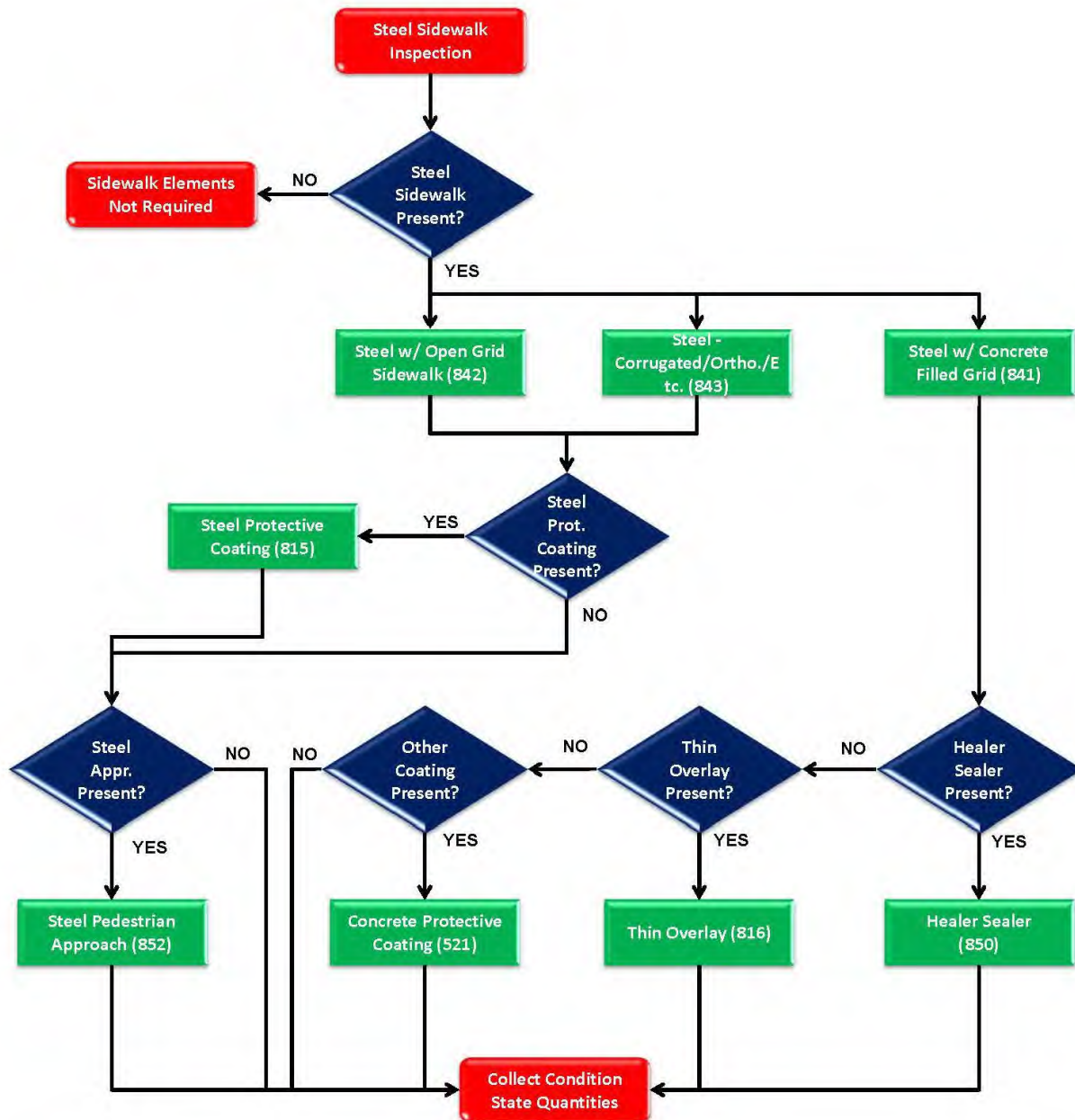

Figure 5.09.04 Deck Element Collection Process for Concrete Sidewalks

MICHIGAN STRUCTURE INSPECTION MANUAL
BRIDGE INSPECTION – ROUTINE AND CONDITION BASED IN-DEPTH INSPECTION

5.09.05 Timber Sidewalk or Curb Routine NBI Inspection

Aesthetics, cost, and the availability of materials are examples of the benefits that lead to the use of timber for as-constructed sidewalks and curbs (see Figure 5.09.05). The material may also be used as a retrofit in conjunction with sidewalk brackets due to its low weight to strength ratio. Conversely, durability concerns that exist for insect and fire damage usually limit installations using the material where long-term serviceability is required. The team leader shall perform the procedures listed for routine inspection, and review Chapter 7 of the BIRM for additional considerations during the inspection. Sidewalks may consist of one or more materials, and the most severe deterioration should control the assigned ratings.



Figure 5.09.05 Designated Pedestrian Walkway on Nail Laminated Deck

1. Inspect the entire length of sidewalk for surface abrasion. Document the approximate location, percent of section, and percentage of deck area affected.
2. Inspect the entire length of sidewalk for loose or missing connections. Evaluate loose or missing connections and determine if they affect the integrity of the sidewalk or if immediate actions are warranted. Document the location of loose, deteriorated, or damaged fasteners.
3. Inspect the entire length of sidewalk for insect damage, decay, and section loss. When section loss is measurable evaluate the area to determine if it affects the integrity of the railing or if an in-depth inspection is warranted. Document the approximate location and estimated percentage of section loss.

MICHIGAN STRUCTURE INSPECTION MANUAL
BRIDGE INSPECTION – ROUTINE AND CONDITION BASED IN-DEPTH INSPECTION

4. Inspect the entire length of sidewalk for splitting. Document the approximate location and estimated length to depth ratio of the splitting.

5. Record photos of deficiencies when a change in the condition rating occurs and review the in-depth inspection procedures for suggested follow-up activities.

The evaluation of timber sidewalks and curbs shall conform to the summarized conditions provided in Table 5.09.03. The MDOT Bridge Safety [NBI Rating Guidelines](#) shall be used to assign an overall code to condition of the entire area present. This item for structures without sidewalks or curbs shall be coded “N”. A statement is required if sidewalk is only constructed on one side of the bridge. The evaluation of brush blocks shall be included during the inspection of railings.

Table 5.09.03 Summarized Timber Sidewalk and Curb Rating Guidelines

Good	Checks or shakes penetrate less than 5% of the member thickness.
Fair	Decay or section loss that affects between 5% and 10% of the member section. Checks or shakes not in the tension zone that penetrate between 25% and 50% of the member thickness. Split length less than the member depth.
Poor	Decay or section loss that affects more than 10% of the member section but does not warrant a structural review. Check or shakes that penetrate more than 50% of the member thickness.
Serious	Checks or shakes that penetrate more than 5% of the member thickness in the tension zone. Cracking that has not been arrested and does not require structural review. Split length greater than the member depth.
Critical	Emergency repairs required for the sidewalk to remain open.

5.09.06 Timber Sidewalk or Curb Michigan Bridge Element Inspection

Elements do not exist for timber sidewalks and pedestrian approaches.

5.09.07 Sidewalk or Curb Work Recommendations

The team leader should provide work recommendations for sidewalks regardless of condition. When preventive maintenance such as a floodcoat is suggested applying the material to the sidewalk should be considered. In addition, since sidewalks may be closed without affecting vehicular traffic certain work activities may be conducted by agencies with direct maintenance forces during periods where the mobility policy restricts closing lanes. Several examples of recommendations that work to reduce the rate of deterioration or improve the NBI condition rating of sidewalks rated 5 or greater are provided in Table 5.09.04.

**MICHIGAN STRUCTURE INSPECTION MANUAL
BRIDGE INSPECTION – ROUTINE AND CONDITION BASED IN-DEPTH INSPECTION**

Table 5.09.04 Work Recommendations for Sidewalks or Curbs Rated in Fair or Good Condition

Concrete Sidewalk (NBI Rating \geq 5)		
Recommendation	Defects	Additional Information
Crack Chasing (Penetrating Sealer)	Cracking, limited, spaced 2' apart or greater	Limited to agencies with direct maintenance forces
Healer Sealer Floodcoat	Cracking, significant, many spaced 2' or less	Generally effective for approximately 6 to 10 years
Thin Overlay Floodcoat	Cracking, significant, many Spaced 2' or Less	Generally effective for more than 10 years
Deck Patching	Spalling, greater than 1" deep or 6" diameter	Improves Item 58, 58B, and element ratings
Steel Sidewalk (NBI Rating \geq 5)		
Recommendation	Defects	Additional Information
Healer Sealer Floodcoat (Filled Grid)	Scaling, or Corrosion causing causing cell growth	Generally effective for approximately 6 to 10 years
Thin Overlay Floodcoat (Filled Grid)	Scaling, or Corrosion causing causing cell growth	Generally effective for more than 10 years
Steel Repairs	Corrosion with measurable section loss	Improves NBI and element ratings
Repair Connections	Connections loose, missing, or broken	Improves NBI and element ratings
Timber Sidewalk (Item 58 \geq 5)		
Recommendation	Defects	Additional Information
Water Repellent Treatment	Decay, affects less than 10% or less of the member	Preserves condition to protect deck
Repair Section Loss	Decay with measurable section loss	Improves NBI and element ratings
Repair Connections	Connections loose, missing, or broken	Improves NBI and element ratings

Prioritize work recommendations according to the general guidelines provided below. Reference the element, location, and describe the extent of rehabilitative measures required. Submit a Request for Action (RFA) for any activity that should be completed prior to the next scheduled routine inspection.

High Priority Work Recommendations

Any structural repairs or replacement of bridge elements that should be completed within 24 to 60 months. High Priority work recommendations consist of any activity that will function to maintain safe load carrying capacity or preserve existing primary component condition ratings.

Medium Priority Work Recommendations

Any structural or non-structural repairs that should be completed within 24 to 60 months. Medium priority work recommendations serve to improve existing component and element condition ratings that are currently in fair or better condition.

MICHIGAN STRUCTURE INSPECTION MANUAL
BRIDGE INSPECTION – ROUTINE AND CONDITION BASED IN-DEPTH INSPECTION

Low Priority Work Recommendations

Any repairs that should be scheduled in conjunction with other planned work at the structure. Low priority work recommendations may have little to no effect on primary component condition ratings.

5.09.08 Sidewalk or Curb Work Request for Action

An RFA shall be submitted to the bridge owner when the condition of the sidewalk poses a hazard to pedestrians, if a detailed inspection is required, or whenever an action should be completed prior to the next scheduled inspection. Corrective action or repairs that do not require completion prior to the next scheduled inspection should be listed as a work recommendation.

Examples of items that trigger an RFA submittal for resolution and/or investigation for sidewalks are provided in Table 5.09.05. The RFA shall be submitted in MiB^{RIDGE} with proper documentation and photographs so an adequate review and resolution of the process may be completed.

Table 5.09.05 Sidewalk Defects Initiating a Request for Action

Request for Action	Primary Sidewalk Materials		
	Concrete	Steel	Timber
In-Depth Inspection	X	X	X
Severe Impact Damage	X	X	X
Trip Hazard, Deep Spalling	X		
Trip Hazard, Damaged Steel Sliding Joint Covers	X	X	
Trip Hazard, Damaged Utility Hand Hole Covers	X	X	
Trip Hazard, Excessive Settlement at Pedestrian Approach	X	X	X

5.09.09 Sidewalk or Curb In-Depth Inspection

In-depth inspections shall be performed as-needed and condition based recommendations are provided in Table 5.09.06. A hands-on inspection should be completed to document the deficiencies present when the condition rating code for the Sidewalk (BSIR #5) is 5 or less for concrete and steel sidewalks, and 4 or less for timber ones. Repetitive detailed inspections should also be completed for sidewalks that are rated in poor condition at the increased frequency described in the table or as the severity of defects dictate. Detailed inspection or documented review of sidewalks is not required for Michigan Bridge Element Inspection. However, it is strongly recommended to take action that includes repair or closure of the sidewalk when the cause of the defect in Condition State 4 may present a hazard to pedestrians traversing the bridge.

MICHIGAN STRUCTURE INSPECTION MANUAL
BRIDGE INSPECTION – ROUTINE AND CONDITION BASED IN-DEPTH INSPECTION

Table 5.09.06 Recommended Condition Based In-Depth Inspection Guideline for Sidewalks

NBI Rating	Schedule Initial In-depth Within	In-Depth Frequency	Applicable Sidewalk Materials		
5	24 Months	As-Needed	Concrete	Steel	
4	12 Months	48 Months	Concrete	Steel	Timber
3	6 Months	36 Months	Concrete	Steel	Timber

The area that will be examined is dependent on the activity performed, degree of detail required, and ultimately be determined at the discretion of the bridge owner. Many activities do not require closing the sidewalk, but when closure is required adequate signing should be installed so pedestrian safety is not affected. At a minimum, it is expected that the locations will concentrate on the areas that appear in the greatest degree of distress and influence the condition rating.

Approval for each in-depth inspection should be documented through the submittal of an RFA to the bridge owner using MiB^{RIDGE}. When the inspection is performed immediately in response to stability or capacity concerns the inspection should be referenced on an RFA submitted after the work has been completed. These processes are necessary for confirming that the work has been completed and will be reviewed annually during QA and FHWA NBIP reviews.

The majority of in-depth inspections will require sounding the surface to identify delamination, internal decay, or damaged welds according to the type of material present. Connections or other elements that are attached to the sidewalk should be closely inspected to determine their condition. Spalls, uneven surfaces, or any damaged adjacent feature that affects safety shall be evaluated to determine if timely action is required (see Figure 5.09.06). The sidewalk shall be inspected for all of the defects identified in the appropriate material specific condition state table found in the Michigan Bridge Element Inspection Manual.

MICHIGAN STRUCTURE INSPECTION MANUAL
BRIDGE INSPECTION – ROUTINE AND CONDITION BASED IN-DEPTH INSPECTION



Figure 5.09.06 Damaged Steel Electrical Junction Box Cover May Injure Pedestrians

Documentation for hands-on inspection of sidewalks should include a span by span sketch of the areas examined. Areas that were not examined should also be delineated on the drawing for future reference. The level of detail provided must allow for an efficient recurrent in-depth inspection to be conducted in order to determine if the condition of the surface has changed. Photographs of the deficient areas should accompany the sketch and written report findings. Upon completion of an in-depth inspection that is completed in response to NBI condition ratings, the BSIR and element report should also be modified to reflect the data gathered when changes in the condition ratings are required.

MICHIGAN STRUCTURE INSPECTION MANUAL
BRIDGE INSPECTION – ROUTINE AND CONDITION BASED IN-DEPTH INSPECTION

5.10 Deck Bottom Surface (BSIR #6)

Observations during the inspection of the deck bottom surface allow for an improved understanding of the overall condition of the deck and permit judgment for the recommended installation of a system to protect motorists and pedestrians from potential hazards or to perform other corrective actions. The team leader must inspect the area for signs of deterioration and the existence of any materials that may separate from the surface prior to the next scheduled routine inspection. Further investigation may be required at locations where false decking was previously installed or to confirm suspected deficiencies (see Figure 5.10.01).



Figure 5.10.01 Tee Beam Superstructure with Plywood False Decking

5.10.01 Concrete Deck Bottom Surface Routine NBI Inspection

Inspection of the concrete deck bottom surfaces provides important information that may not be readily obtained from the observations made while inspecting the top surface (see Figure 5.10.02). For example, leaching cracks with rust staining are signs that corrosion of the steel reinforcement has initiated and without remedial actions deck deterioration will accelerate. The underside also provides an indication of whether substantial full-depth deficiencies are localized or occur throughout the entire structural deck. Proper inspection of the deck bottom surface is imperative as it determines the type of repair activities that may be accomplished. The team leader shall perform the procedures listed for routine inspection, and review Chapter 7 of the BIRM for additional considerations during the inspection.

MICHIGAN STRUCTURE INSPECTION MANUAL
BRIDGE INSPECTION – ROUTINE AND CONDITION BASED IN-DEPTH INSPECTION

1. Inspect the deck bottom surface for cracking, and investigate whether any observed cracking is structural or non-structural. Document the approximate location, orientation, width, and spacing of the cracking.
2. Inspect the deck bottom surface for efflorescence and heavy rust staining. Document the approximate location, percentage of deck area affected, and degree of the build-up.
3. Inspect the deck bottom surface for delamination and spalling. Document the approximate location, percentage of deck area affected, and depth (if applicable) of both delamination and spalling.
4. Inspect the deck bottom surface for scaling. Document the approximate location, percentage of deck area affected, and estimated depth of scaling.
5. Inspect the stay-in-place forms for surface corrosion and whether they are flush with the deck bottom. Document the approximate location, percentage of deck area affected, and extent of corrosion.
6. Record photos of deficiencies when a change in the condition rating occurs and review the in-depth inspection procedures for suggested follow-up activities.



Figure 5.10.02 Deck Bottom Surface in Critical Condition

The evaluation of concrete deck bottom surfaces shall conform to the summarized conditions provided in Table 5.10.01. The MDOT Bridge Safety [NBI Rating Guidelines](#) shall be used to assign an overall code to

MICHIGAN STRUCTURE INSPECTION MANUAL
BRIDGE INSPECTION – ROUTINE AND CONDITION BASED IN-DEPTH INSPECTION

condition of the entire area present. This item for culverts, filled arch bridges, and other structures without decks shall be coded “N”. While entering the BSIR the team leader must use a list box that indicates whether any false decking present was removed during the inspection. Review the in-depth inspection procedures for more information regarding false decking removal requirements.

Table 5.10.01 Summarized Concrete Bottom Surface Rating Guidelines

Good	Open cracks less than 1/16" wide spaced at 10' or more. Light shallow scaling present. No rust on stay-in-place forms.
Fair	Delamination, spalling, heavily map cracked areas, or freckled rust on stay-in-place forms affecting between 2% and 10% of the area. Excessive cracking or heavy scaling up to 1" deep.
Poor	Delamination, spalling, heavily map cracked areas, or light to moderate corrosion on stay-in-place forms affecting between 10% and 25% of the total surface area. Efflorescence with heavy rust staining.
Serious	Delamination, spalling, heavily map cracked areas, or moderate to severe corrosion on stay-in-place forms affecting more than 25% of the total surface area. Local failures may be possible.
Critical	The deck will not support design loads and is posted. Emergency repairs may be required.

5.10.02 Concrete Deck Bottom Surface Michigan Bridge Element Inspection

Element level information shall be collected for the bottom surface of concrete decks using the Michigan Bridge Element Inspection Manual elements and condition states. If the deck does not have stay-in-place forms throughout the entire bottom deck surface then condition state quantities for Element 811 (Reinforced Concrete Deck Bottom Surface) shall be collected. When the bottom surface is partially or completely covered by stay-in-place forms then element level information shall be collected for Element 822 (Stay-In-Place Forms). Once false decking or metal mesh panels have been placed to capture debris then the quantity and condition of the materials present shall be identified as Element 820 (False Decking) or Element 821 (Maintenance Sheeting). Condition state information shall be collected for the galvanizing on the forms using Element 515 (Steel Protective Coating), but collecting the condition of the protective coating of metal mesh panels is unnecessary.

Depending on the specific attributes at a location all of the elements may exist on a single structure. For example, a bridge that was previously widened may have exposed concrete and stay-in-place forms present. If delamination or spalling of the bottom surface without stay-in-place forms occurs false decking and/or maintenance sheeting may be installed to protect motorists.

A flowchart illustrating the process of determining the applicable elements for concrete deck bottom surfaces has been provided for clarification (see Figure 5.10.03). All of the elements shown are ADEs that were created for improved deterioration modeling, analysis, and planning efforts. Quantities and condition state information are linked to other NBEs or BMEs that are reported to FHWA on an annual basis. The data provided must be accurate as it will be evaluated during future quality assurance and NBIP reviews.

MICHIGAN STRUCTURE INSPECTION MANUAL
 BRIDGE INSPECTION – ROUTINE AND CONDITION BASED IN-DEPTH INSPECTION

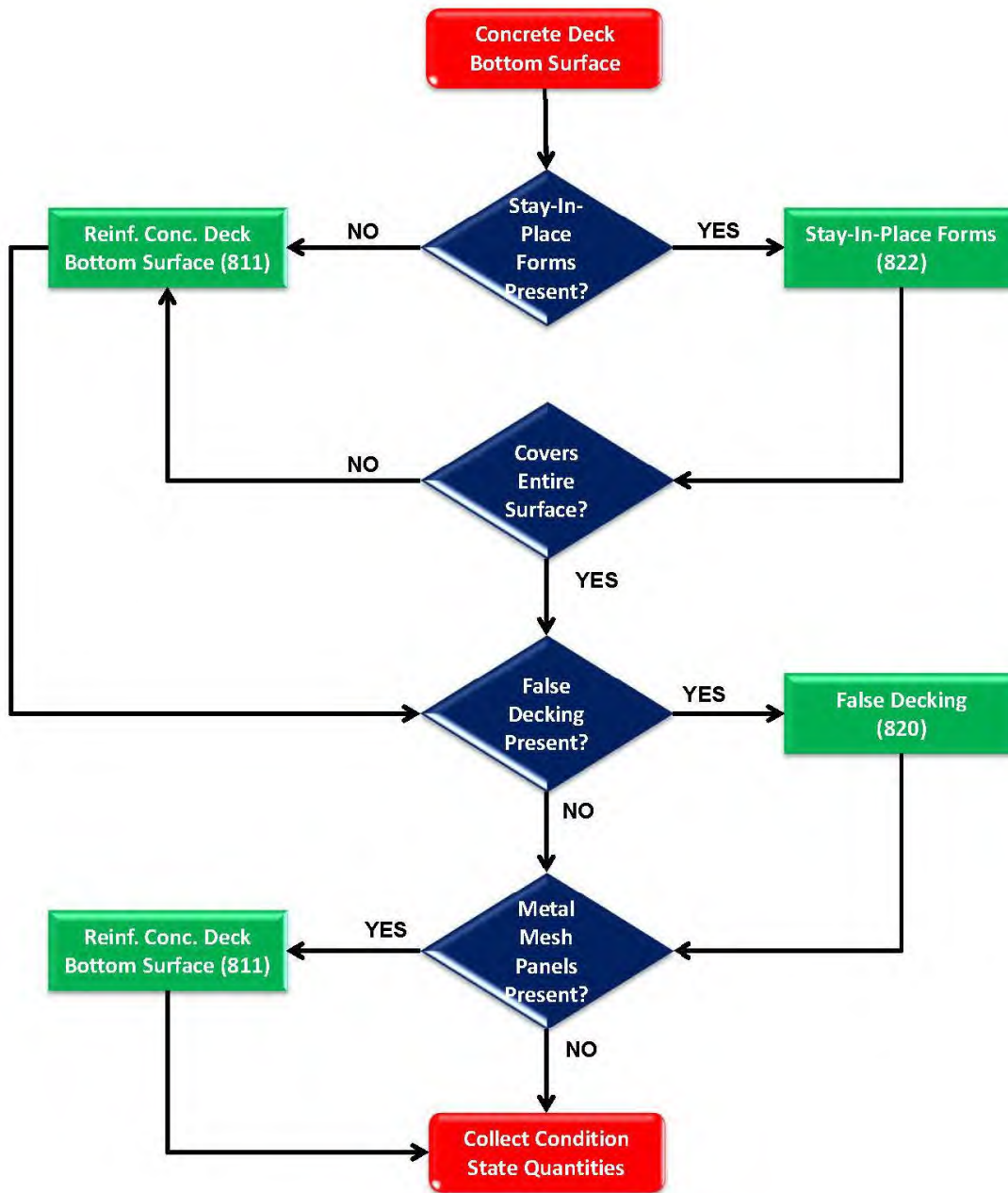

Figure 5.10.03 Element Collection Process for Concrete Deck Bottom Surfaces

MICHIGAN STRUCTURE INSPECTION MANUAL
BRIDGE INSPECTION – ROUTINE AND CONDITION BASED IN-DEPTH INSPECTION

5.10.03 Steel Deck Bottom Surface Routine NBI Inspection

Inspecting the bottom surface of grid, orthotropic, or corrugated decks allows for the detection of defects that are not visible from the top surface. Fatigue cracking and broken welds are common on steel decks and the repairs may normally be scheduled along with other routine maintenance activities. However, cracking in orthotropic decks is a serious matter that requires urgent attention and resolution as these types of decks are considered fracture critical. The team leader shall perform the procedures listed for routine inspection, and review Chapter 7 of the BIRM for additional considerations during the inspection.

1. Inspect the steel deck bottom surface for protective coating failure. Note whether the failure is limited to the top application coat or to bare steel. Document the approximate location, percentage, and extent of coating failure.
2. Inspect the steel deck bottom surface for corrosion and section loss. When section loss is measurable evaluate the area to determine if an in-depth inspection and subsequent load analysis is warranted. Document the approximate location and estimated amount of section loss.
3. Inspect the steel deck bottom surface for cracking. Cracks in orthotropic steel require follow-up actions to be performed. Document the approximate location, estimated length, and whether the cracks have been arrested.
4. Inspect the steel deck bottom surface for loose or missing connections. Document the approximate location of loose, deteriorated, or damaged fasteners.
5. Inspect the entire area of steel deck bottom surface for impact damage and bent bars. Document the approximate location and degree of deformation.
6. Record photos of deficiencies when a change in the condition rating occurs and review the in-depth inspection procedures for suggested follow-up activities.

The evaluation of steel deck bottom surfaces shall conform to the summarized conditions provided in Table 5.1.02. The MDOT Bridge Safety [NBI Rating Guidelines](#) shall be used to assign an overall code to condition of the entire area present. This item for culverts, filled arch bridges, and other structures without decks shall be coded “N”. While entering the BSIR the team leader must document the percentage of any false decking present was removed during the inspection. Review the in-depth inspection procedures for more information regarding false decking removal requirements.

MICHIGAN STRUCTURE INSPECTION MANUAL
BRIDGE INSPECTION – ROUTINE AND CONDITION BASED IN-DEPTH INSPECTION

Table 5.10.02 Summarized Steel Bottom Surface Rating Guidelines

Good	Protective coating failures in very small and scattered locations.
Fair	Protective coating failure is limited to less than 5% of the surface area with minor loss of section. Cracks that have self-arrested or have been arrested may be present. Loose fasteners present but the connection is functioning as intended.
Poor	Protective coating failure affecting between 5% and 10% of the surface area with measurable loss of section. Cracks that have not been arrested or missing fasteners. Structural review not required.
Serious	Protective coating failure affecting more than 10% of the surface area with measurable loss of section. Cracks or missing fasteners that do warrant a structural review.
Critical	The deck will not support design loads and is posted. Emergency repairs may be required.

5.10.04 Steel Deck Bottom Surface Michigan Bridge Element Inspection

No elements exist for steel deck bottom surfaces. However, the quantity of defects identified on the bottom surface must be included in applicable steel deck elements that are identified in Section 5.11.

5.10.05 Timber Deck Bottom Surface Routine NBI Inspection

The inspection of timber deck bottom surfaces is required in order to verify the presence of defects that are not visible from the top surface. Areas that are especially susceptible to deterioration include locations where the deck bears on the superstructure, connections between deck members or the superstructure itself, and other places that are exposed to precipitation. The team leader shall perform the procedures listed for routine inspection and review Chapter 7 of the BIRM for additional considerations.

1. Inspect the timber deck bottom surface for protective coating failure (if present). Document the approximate location, percentage, and extent of coating failure
2. Inspect the timber deck bottom surface for insect damage, decay, and section loss. When section loss is measurable evaluate the area to determine if an in-depth inspection and subsequent load analysis is warranted. Document the approximate location and estimated amount of section loss.
3. Inspect the timber deck bottom surface for splitting. Document the approximate location and length in respect to the member depth.
4. Inspect the timber deck bottom surface for loose or failed connections. Document the approximate location of inadequate, deteriorated, or damaged connections.

MICHIGAN STRUCTURE INSPECTION MANUAL
BRIDGE INSPECTION – ROUTINE AND CONDITION BASED IN-DEPTH INSPECTION

5. Inspect the timber deck bottom surface for check or shakes. Document the approximate location, note whether they occur in tension or compression zones, and the length in respect to member depth.

6. Record photos of deficiencies when a change in the condition rating occurs and review the in-depth inspection procedures for suggested follow-up activities.

The evaluation of timber deck bottom surfaces shall conform to the summarized conditions provided in Table 5.10.03. The MDOT Bridge Safety [NBI Rating Guidelines](#) shall be used to assign an overall code to condition of the entire area present. This item for culverts, filled arch bridges, and other structures without decks shall be coded “N”.

Table 5.10.03 Summarized Timber Bottom Surface Rating Guidelines

Good	Checks or shakes penetrate less than 5% of the member thickness.
Fair	Decay or section loss that affects between 5% and 10% of the member section. Checks or shakes not in the tension zone that penetrate between 25% and 50% of the member thickness. Split length less than the member depth.
Poor	Decay or section loss that affects more than 10% of the member section. Check or shakes that penetrate more than 50% of the member thickness.
Serious	Decay or section loss that affects more than 10% of the member section. Check or shakes that penetrate more than 50% of the member thickness. Split length greater than the member depth.
Critical	The deck will not support design loads and is posted. Emergency repairs may be required.

5.10.06 Timber Deck Bottom Surface Michigan Bridge Element Inspection

No elements exist for timber deck bottom surfaces. However, the quantity of defects identified on the bottom surface must be included in the corresponding timber deck element identified in Section 5.11.

5.10.07 Deck Bottom Surface Work Recommendations

The team leader should provide work recommendations that work to effectively preserve the condition of any concrete deck bottom surface and for other types on an as-needed basis. Several examples of recommendations that work to improve the condition, alleviate the rate of surface deterioration, or resolve specific defects when Item 58 and Item 58B are in fair or good condition are provided below in Table 5.10.04. Section 5.05.09 may also be referenced as treatments to the top surface of the deck often work to delay further deterioration to the bottom. When the concrete deck bottom exhibits signs of distress that result in a fair or poor rating a recommendation for scaling to remove loose concrete may be provided. This should occur any time there is sufficient cause stemming from the observation of spalls and/or delamination. If a significant amount of the surface area has deteriorated, whereby scaling may not relieve the concern for the issue, then the installation of metal mesh panels is recommended. Factors

MICHIGAN STRUCTURE INSPECTION MANUAL
BRIDGE INSPECTION – ROUTINE AND CONDITION BASED IN-DEPTH INSPECTION

that should be considered prior to installing panels include the adjacent condition of the deck surface over the traveled way, type of aggregate, area of delamination and/or spalling, and programmed year for rehabilitation.

Table 5.10.04 Work Recommendations for Deck Bottom Surfaces Rated in Fair or Good Condition

Concrete Deck Bottom Surface (Item 58A & 58B ≥ 5)		
Recommendation	Defects	Additional Information
Healer Sealer Floodcoat	Cracking, significant, many spaced 2' or less	Generally effective for approximately 6 to 10 years
Thin Overlay Floodcoat	Cracking, significant, many Spaced 2' or Less	Generally effective for more than 10 years
Maintenance Sheeting	Delamination, or Spalling above vehicular or pedestrian routes	See Section 5.11 for additional information
Steel (Item 58 & 58B ≥ 5)		
Recommendation	Defects	Additional Information
Healer Sealer Floodcoat (Filled Grid)	Scaling, or Corrosion causing cell growth	Generally effective for approximately 6 to 10 years
Thin Overlay Floodcoat (Filled Grid)	Scaling, or Corrosion causing cell growth	Generally effective for more than 10 years
Steel Repairs	Corrosion with measurable section loss	Improves NBI and element ratings
Repair Connections	Connections loose, missing, or broken	Improves NBI and element ratings
Timber (Item 58A & 58B ≥ 5)		
Recommendation	Defects	Additional Information
Water Repellent Treatment	Decay, affects less than 10% or less of the member	Preserves condition to protect deck
Repair Section Loss	Decay with measurable section loss	Improves NBI and element ratings
Repair Connections	Connections loose, missing, or broken	Improves NBI and element ratings

Prioritize work recommendations according to the general guidelines provided below. Reference the element, location, and describe the extent of rehabilitative measures required. Submit a Request for Action (RFA) for any activity that should be completed prior to the next scheduled routine inspection.

High Priority Work Recommendations

Any structural repairs or replacement of bridge elements that should be completed within 24 to 60 months. High Priority work recommendations consist of any activity that will function to maintain safe load carrying capacity or preserve existing primary component condition ratings.

Medium Priority Work Recommendations

Any structural or non-structural repairs that should be completed within 24 to 60 months. Medium

MICHIGAN STRUCTURE INSPECTION MANUAL
BRIDGE INSPECTION – ROUTINE AND CONDITION BASED IN-DEPTH INSPECTION

priority work recommendations serve to improve existing component and element condition ratings that are currently in fair or better condition.

Low Priority Work Recommendations

Any repairs that should be scheduled in conjunction with other planned work at the structure. Low priority work recommendations may have little to no effect on primary component condition ratings.

5.10.08 Deck Bottom Surface Request for Action

An RFA should be submitted when the condition of the concrete bottom surface poses a hazard to motorists or pedestrians, if a detailed inspection is required, or whenever an action should be completed prior to the next scheduled inspection. The RFA shall be submitted in MiB^{RIDGE} with proper documentation and photographs so an adequate review and resolution of the process may be completed.

Examples of items that trigger an RFA submittal for resolution and/or investigation of deck bottom surfaces are provided in Table 5.10.05. For other systems an RFA shall be submitted as-needed requesting the in-depth inspection. The RFA shall be submitted in MiB^{RIDGE} with proper documentation and photographs so an adequate review and resolution of the process may be completed.

Table 5.10.05 Deck Bottom Surface Defects Initiating a Request for Action

Request for Action	Concrete	Steel	Timber
In-Depth Inspection	X	X	X
Delamination/Spalling Above Vehicular or Pedestrian Routes	X		
Structural Cracking	X	X	
Section Loss Compromising Strength		X	X

5.10.09 Deck Bottom Surface In-Depth Inspection

In-depth inspections shall be performed as-needed and condition based recommendations are provided in Table 5.10.06. **In addition, Table 5.10.07 provides mandatory practices for bridges which contain false decking.** Since critical, economical, and safety implications exist, when the condition of the deck bottom surface (Item 58B, BSIR #6) deteriorates, a hands-on inspection should be completed once the condition rating code is 6 or less. Once the surface deteriorates and becomes poor it is suggested to complete repetitive in-depth inspections at a 48 or 36 month frequency according to the deficiencies identified and condition rating. Detailed inspection or documented review of deck bottom surfaces is not required for Michigan Bridge Element Inspection. However, evidence of delamination and spalling observed on the bottom surface of concrete decks may permit an as-needed hands-on inspection at any time regardless of previous appraisal ratings.

MICHIGAN STRUCTURE INSPECTION MANUAL
BRIDGE INSPECTION – ROUTINE AND CONDITION BASED IN-DEPTH INSPECTION

Table 5.10.06 Recommended Condition Based In-Depth Inspection Guideline for Deck Bottom Surfaces

NBI Rating (Item 58B)	Schedule Initial In-depth Within	In-Depth Frequency	Applicable Deck Materials		
			Concrete	Steel	Timber
6	24 Months	As-Needed	Concrete	Steel	
4	12 Months	48 Months	Concrete	Steel	Timber
3	6 Months	36 Months	Concrete	Steel	Timber

The number of lanes or amount of surface area that will be closed to traffic for examination will be dependent on the activity performed, degree of detail required, and ultimately be determined at the discretion of the bridge owner. Isolated areas of observable distress may only require single lane closures while dispersed or uniform deterioration usually require closure of multiple lanes. The inspection must always commence with any area that may pose an immediate danger to the safety of anyone on the route or waterway below the structure. These access requirements must be discussed in advance of a scheduled in-depth inspection so adequate resources are available for an efficient, safe, and successful inspection.

Approval for each in-depth inspection should be documented through the submittal of an RFA to the bridge owner using MiB^{RIDGE}. When the inspection is performed immediately in response to public safety concerns the inspection should be referenced on an RFA submitted after the work has been completed. These processes are necessary for confirming that the work has been completed and will be reviewed annually during QA and FHWA NBIP reviews.

The majority of in-depth inspections will require sounding the bottom surface with a hammer and marking delaminated, spalled, cracked, or other defect areas so they are visible in photographs. Permanent marking paint may not be used on fascia soffit. The bottom surface shall be inspected for all of the defects identified in the appropriate material specific condition state table found in the Michigan Bridge Element Inspection Manual. A cursory inspection of other adjacent elements such as the stringers, bearings, and primary diaphragms may also be performed while completing the inspection.

When this occurs the suspect areas should be sounded along with an additional 25% of the surface area over the traveled way. The perimeter of the defect areas should be marked well so that the defects are visible from distances associated with a routine inspection. When it is possible the bridge owner should arrange for the debonding concrete to be scaled from the surface or schedule the installation of a system to protect motorists, pedestrians, or recreational travelers.

The minimum information included in the in-depth report for bottom deck surface surveys shall be a sketch of the areas examined with measurements of each corresponding defect provided. Repetitive inspection investigations should focus on identifying additional areas of delamination, recording the locations where spalling has occurred since the previous one, and evaluating the need for installation of system to capture debonded material. When there is high degree of likelihood that false decking or

MICHIGAN STRUCTURE INSPECTION MANUAL
BRIDGE INSPECTION – ROUTINE AND CONDITION BASED IN-DEPTH INSPECTION

maintenance sheeting installation will be recommended precise measurements of each bay spacing over the traveled way must be taken to determine the as-constructed web to web beam spacing.

Mandatory Requirements for Bridges Containing Plywood False Decking:

Less than 300 Michigan bridges currently contain plywood false decking that was installed to protect motorists and others from falling deck materials during non-construction periods. The use of readily available plywood and lumber allows for an expedited resolution to capture falling debris because the material may easily be modified for installation at nearly any structure (see Figure 5.10.04). Since plywood obscures the ability to observe the deck bottom surface the need for a new system that permitted observation of the entire area was developed during 2010. Maintenance Sheeting incorporates sections of metal mesh with 1" square openings that are attached to a galvanized square tube frame using specially fabricated heavy-duty brackets (see Figure 5.10.05). While this relatively new system allows for the inspection of 100% of the bottom surface to be completed with the protective measures in-place, adequate planning, precise measurements of beam spacing, and additional budget are required.



Figure 5.10.04 Structure Where Plywood False Decking Coverage Requires In-Depth Inspection

The in-depth inspection requirements of the concrete deck bottom surface for bridges which contain plywood false decking are contingent on the amount of surface area that is being protected by the system. There are no special requirements for the bottom surface of spans containing false decking when 75% or less of the surface area is obstructed as the determination shall be made for each structure on a case-by-case basis. False decking removal on structures with less than 75% of the surface covered may be necessary to inspect pin and hangers, fracture critical elements, or whenever engineering judgment decrees further evaluation is necessary.

When more than 75% of the surface area is covered by false decking a representative portion of the plywood and lumber shall be temporarily removed to permit an arms-length inspection every four years

MICHIGAN STRUCTURE INSPECTION MANUAL
BRIDGE INSPECTION – ROUTINE AND CONDITION BASED IN-DEPTH INSPECTION

unless engineering judgment determines that an increased frequency for the removal is necessary. A representative portion for the purposes of false decking removal shall be defined as a minimum of 24 sft. of material in every other bay of a structure with eight or less bays, and every third bay of a structure with nine or more bays. Once the portions of the plywood are removed the team leader shall ascend to the opening and review the exposed surface using a flashlight and proper respiratory protection. If deck rehabilitation or replacement is not programmed within 5 years subsequent to the date of inspection then a recommendation for metal mesh panel installation to permit adequate inspection should be provided on the BSIR.

Table 5.10.07 Required In-Depth Inspection for Deck Bottom Surfaces Containing Plywood False Decking

Surface Area of Protected Span	Schedule Initial In-depth Within	In-Depth Frequency	Removal Requirements	
			≤ 8 Bays	≥ 9 Bays
< 75%	N/A	As-Needed	As-Needed	As-Needed
≥ 75%	12 Months	48 Months	Every Other Bay (24 sft. Each)	Every Third Bay (24 sft. Each)

Due to these requirements, effective for all inspections after March 31, 2015, it is highly recommended that future installations of plywood false decking only occur for short-term use where sequential replacement with maintenance sheeting will occur or in cases where the bridge has already been programmed for significant rehabilitation/replacement within 4 years. The bridge owner is responsible for ensuring that concealed surfaces are adequately inspected and to facilitate temporary removal of plywood on a case-by-case basis.



Figure 5.10.05 Typical Maintenance Sheeting

**MICHIGAN STRUCTURE INSPECTION MANUAL
BRIDGE INSPECTION – ROUTINE AND CONDITION BASED IN-DEPTH INSPECTION**

5.11 Deck (BSIR #7, SI&A Item 58)

The team leader must evaluate the bridge deck or slab for signs of deterioration. The deck condition is to be assessed as a 3D component and includes summarizing the defects from the top, bottom, and fascia surfaces. Proper rating and identification of defects is crucial as the deck condition rating is one of the primary factors for the selection of rehabilitation projects and life cycle analysis. When a wearing surface is not employed and the structural deck is exposed the condition of the surface must be considered in the overall rating. The condition rating of the deck or slab does not take into consideration wearing surfaces, joints, curbs, sidewalks, parapets, fascia, railings, or scuppers. In addition, for slab structures, the condition of the slab will determine the condition ratings for both SI&A Items 58 (Deck) and 59 (Superstructure). For Tee Beam structures the condition of the deck/top flange will impact the overall condition of the superstructure (Item 59).

This deck item for culverts, filled arch bridges, and other structures without decks shall be coded “N” SI&A Item 58 (Deck). While entering the BSIR the team leader must indicate the percentage of deck that has false decking present and note if any portions were removed during the inspection. Review the in-depth inspection procedures in Section 5.10.09 for more information regarding the requirements for false decking removal.

During deck inspection the team leader must review SI&A inventory coding to ensure that the safe operating capacity is correctly displayed for bridges requiring posting. When posting signs are required and not installed the bridge owner shall be notified through issuance of an RFA. In general, the relationships identified in Table 5.11.01 represent load posting deficiencies or erroneous data that must be corrected in a timely fashion as delays could result in non-compliance actions.

Table 5.11.01 Common Load Posting Deficiencies

State	Inventory Item and Coding
1	Item 70 < 5 and Item 41 = A
2	Item 70 or Item 41 = null
3	Item 41 = B
4	Item 64 < 2.7 mT and Item 41 ≠ G or K and Item 103 = null
5	Item 64 < 2.7 mT and Item 41 = A or B and Item 103 = T

5.11.01 Concrete Deck or Slab Routine NBI Inspection

During the late 1970’s MDOT began installing epoxy coated steel within the top mat of reinforcement to reduce the rate of cracking, delamination, and spalling caused by steel corrosion in concrete decks and slabs. Afterward, the practice of using epoxy coated steel was extended to include the bottom mat of deck reinforcement and other components. This practice has proven successful in extending the serviceability and reducing the demand of deck patching and other reactive maintenance activities. Over time, this will also allow bridge engineers and maintenance crews to focus additional attention on

MICHIGAN STRUCTURE INSPECTION MANUAL
BRIDGE INSPECTION – ROUTINE AND CONDITION BASED IN-DEPTH INSPECTION

preventative maintenance activities that will reduce freeze-thaw damage and improve ride quality as decks with uncoated reinforcement are replaced. The observations identified on the top and bottom surfaces shall be used to assign the overall condition rating. Defects that occur only in the wearing course that do not extend into the structural deck section shall be excluded (see Figure 5.11.01). The team leader shall perform the procedures listed for routine inspection and review Chapter 7 of the BIRM for additional considerations during the inspection.



Figure 5.11.01 Deteriorated Thin Overlay with No Defects Observed in the Structural Deck

1. Inspect the concrete deck for cracking, and investigate whether any observed cracking is structural or non-structural. Document the approximate location, orientation, width, and spacing of the cracking.
2. Inspect the concrete deck for delamination and spalling. When exposed reinforcement is observed evaluate the area to determine if it poses a safety hazard to motorists and warrants an immediate action. Document the approximate location, percentage of deck area affected, and depth (if applicable) of both delamination and spalling.
3. Inspect the concrete deck for surface scaling. Document the approximate location, percentage of deck area affected, and estimated depth of scaling.
4. Inspect the concrete deck where shallow, deep, or full depth concrete patches are located. Concrete patches that are sound without signs of distress shall not be considered in the tabulation of poor surface area. Document the approximate location, and percentage of deck area with deficient concrete patches.

MICHIGAN STRUCTURE INSPECTION MANUAL
BRIDGE INSPECTION – ROUTINE AND CONDITION BASED IN-DEPTH INSPECTION

5. If present, inspect the stay-in-place forms for surface corrosion and whether they are flush with the deck bottom. Document the approximate location, percentage of deck area affected, and extent of corrosion.

6. Record photos of deficiencies when a change in the condition rating occurs and review the in-depth inspection procedures for suggested follow-up activities. Review Section 5.13 for additional concrete slab inspection procedures.

The evaluation of concrete decks shall conform to the summarized conditions provided in Table 5.11.02. The MDOT Bridge Safety [NBI Rating Guidelines](#) shall be used to assign an overall code to condition of the entire area present.

Table 5.11.02 Summarized Concrete Deck or Slab Rating Guidelines

Good	Open cracks less than 1/16" wide or sealed cracks spaced at 10' or more. Light shallow scaling present. Minor deterioration in intermittent locations that has no effect on structural capacity.
Fair	Excessive cracking or heavy scaling up to 1" deep. Deterioration of the combined area of both deck surfaces is between 2% and 10% of the total area.
Poor	Delamination, spalling, heavily map cracked areas, or efflorescence with heavy rust staining. Deterioration of the combined area of both deck surfaces is between 10% and 25% of the total area. Structural review and/or load analysis is not required.
Serious	Excessive delamination, spalling, or cracking that may affect capacity. Deterioration of the combined area of both deck surfaces is more than 25% of the total area. Structural review and/or load analysis may be necessary to determine if the structure can continue to function without restricted loading.
Critical	The deck will not support design loads and is posted, emergency repairs or temporary shoring is required.

5.11.02 Concrete Deck or Slab Michigan Bridge Element Inspection

Elements shall be collected for concrete decks using the Michigan Bridge Element Inspection Manual condition states. The evaluation shall consist of a 2D assessment of the deck surface area by reviewing the top, bottom, and fascia surfaces. When multiple defects are within the same vicinity the worst condition state shall be applied to the area. Visualizing a 1' by 1' grid placed across the surfaces may assist in the evaluation and determining which type of defect controls the condition state (see Figure 5.11.02). Defects that occur on the top and bottom at identical locations should not be counted twice. Therefore, it is advantageous to make a sketch depicting the areas of deterioration on each surface for bridges with large decks. Areas that are unexposed shall be evaluated according to visible signs in the materials covering them.

SI&A Item 108C must be reviewed to determine the type of reinforcement used. Several ADEs for both decks and slabs were developed in order to determine the deterioration rates for various types of reinforcement. For decks that have been widened and utilize dissimilar reinforcement amongst the sections of varying age select each element that applies and enter the respective quantity for each. For

MICHIGAN STRUCTURE INSPECTION MANUAL
BRIDGE INSPECTION – ROUTINE AND CONDITION BASED IN-DEPTH INSPECTION

decks that utilize a mixture of reinforcement amongst the same section, use the element that provides the least resistance to corrosion. An example for such a circumstance is the use of stainless steel in the top mat and “black bar” reinforcement in the bottom mat. For this instance, where the “black bar” will have greater control over the rate of deterioration, use Element 800 (Reinforced Concrete Black Bars).



Figure 5.11.02 Element Level Deck Evaluation Consists of Identifying Defects within Each Square Foot of Area

MICHIGAN STRUCTURE INSPECTION MANUAL
BRIDGE INSPECTION – ROUTINE AND CONDITION BASED IN-DEPTH INSPECTION

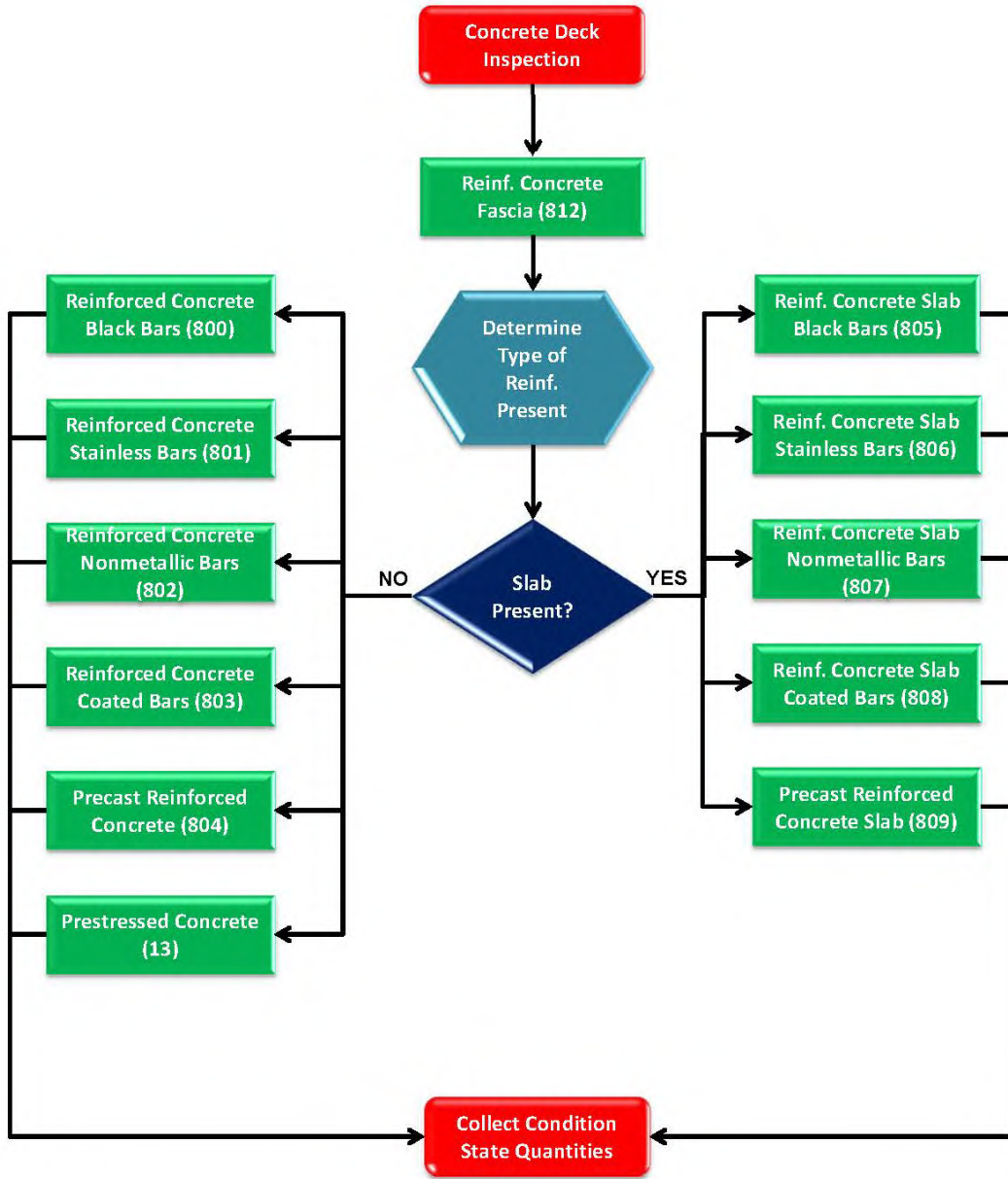

Figure 5.11.03 Concrete Deck Element Collection Process

A flowchart illustrating the process of determining the applicable elements for concrete deck surfaces has been provided for clarification (see Figure 5.11.03). The majority of the elements shown are ADEs that were created for improved deterioration modeling, analysis, and planning efforts. Quantities and condition state information are linked to other NBEs that are reported to FHWA on an annual basis. The data provided must be accurate as it will be evaluated during future quality assurance and NBIP reviews.

MICHIGAN STRUCTURE INSPECTION MANUAL
BRIDGE INSPECTION – ROUTINE AND CONDITION BASED IN-DEPTH INSPECTION

5.11.03 Steel Deck Routine NBI Inspection

The primary use of steel decks in Michigan occurs at complex structures in order to reduce the dead load of movable spans (see Figure 5.11.04). The most common are riveted or welded grid decks that bear directly on the superstructure. Grid decks consist of a series of bearing bars at uniform spacing that are perpendicular to the direction of traffic when supported by stringers, and parallel to the direction of traffic when they are attached to floor beams. Cross bars in the opposite position maintain spacing and distribute live load to the bearing bars. Grid deck cores that are filled with concrete preserve the condition of the steel decking and structural components below.

Fixed simply supported spans may use corrugated or orthotropic steel decks. Corrugated steel decks appear similar to stay-in-place forms at first glance and consist of a series of sections that are bolted or welded to the superstructure. The corrugations are filled with a wearing course that enables preservation of the steel and a smooth riding surface. Orthotropic steel decks utilize a series of ribs and a flat steel plate that is covered with a wearing course to protect the steel and provide skid resistance. The observations identified on the top and bottom surfaces shall be used to assign the overall condition rating. Defects that occur only in the wearing course that do not extend into the structural deck section shall be excluded. The team leader shall perform the procedures listed for routine inspection, and review Chapter 7 of the BIRM for additional considerations during the inspection.

1. Inspect the steel deck surfaces for protective coating failure. Note whether the failure is limited to the top application coat or to bare steel. Document the approximate location, percentage, and extent of coating failure.
2. Inspect the steel deck for corrosion and section loss. When section loss is measurable evaluate the area to determine if an in-depth inspection and subsequent load analysis is warranted. Document the approximate location and estimated amount of section loss.
3. Inspect the steel deck for cracking. Cracks in orthotropic steel require follow-up actions to be performed. Document the approximate location, estimated length, and whether the cracks have been arrested.
4. Inspect the steel deck for loose or missing connections. Document the approximate location of loose, deteriorated, or damaged fasteners.
5. Inspect the entire area of steel deck for impact damage and bent bars. Document the approximate location and degree of deformation.
6. Record photos of deficiencies when a change in the condition rating occurs and review the in-depth inspection procedures for suggested follow-up activities.

**MICHIGAN STRUCTURE INSPECTION MANUAL
BRIDGE INSPECTION – ROUTINE AND CONDITION BASED IN-DEPTH INSPECTION**



Figure 5.11.04 Twin Bascule Welded Steel Grid Decks

The evaluation of steel decks shall conform to the summarized conditions provided in Table 5.11.03. The MDOT Bridge Safety [NBI Rating Guidelines](#) shall be used to assign an overall code to condition of the entire area present.

Table 5.11.03 Summarized Steel Deck Rating Guidelines

Good	Protective coating failures in very small and scattered locations. Minor deterioration in intermittent locations that has no effect on structural capacity.
Fair	Protective coating failures with minor loss of section. Cracks are arrested. All connections functioning as intended. Deterioration of the combined area of both deck surfaces is between 2% and 10% of the total area.
Poor	Protective coating failure with measurable section loss. Cracks have not been arrested or missing fasteners are present. Deterioration of the combined area of both deck surfaces is between 10% and 25% of the total area. Structural review and/or load analysis is not required.
Serious	Protective coating failure with measurable loss of section. Cracks or missing fasteners may affect design capacity. Deterioration of the combined area of both deck surfaces is more than 25% of the total area. Structural review and/or load analysis may be necessary to determine if the structure can continue to function without restricted loading.
Critical	The deck will not support design loads and is posted, emergency repairs or temporary shoring is required.

5.11.04 Steel Deck Michigan Bridge Element Inspection

Elements shall be collected for steel decks using the Michigan Bridge Element Inspection Manual condition states. When multiple defects are within the same vicinity the worst condition state shall be applied to the area. Defects that occur on the top and bottom at identical locations should not be counted twice. Areas that are unexposed shall be evaluated according to visible signs in the materials covering them.

MICHIGAN STRUCTURE INSPECTION MANUAL
BRIDGE INSPECTION – ROUTINE AND CONDITION BASED IN-DEPTH INSPECTION

Wearing surfaces are often placed on Element 29 (Steel with Concrete Filled Grid) and will exist for Element 30 (Steel – Corrugated/Orthotropic/Etc.). Collect condition state quantities for the associated wearing surface and/or protective coating elements and use the visible signs in the materials covering them to evaluate the condition of the deck.

All of the steel deck elements are NBEs and quantities and condition state information are reported directly to FHWA on an annual basis. The data provided must be accurate as it will be evaluated during future quality assurance and NBIP reviews.

5.11.05 Timber Deck Routine NBI Inspection

Timber deck designs may be categorized into five types that are all subject to similar defects. The simplest are plank decks which consist of a series of timbers placed perpendicular to the direction of traffic with each one fastened to the superstructure through the use of nails, bolts, or clamps. Plank decks often utilize running planks as a wearing surface to reduce abrasion to the deck surface. Nailed laminated decks are similar to plank decks but the timber sections are oriented so the narrowest dimension bears on the superstructure. During construction each timber is placed in position, nailed to the previous planks installed, and the deck is connected to the superstructure in similar fashion to plank decks. Glulam deck panels consist of timber sections oriented perpendicular to the direction of traffic that are bonded to one another. The benefits of these decks are increased strength, decreased labor costs, and reduced time during construction. Another integration of glulam timbers is found in stress laminated deck systems. In this configuration the glulam timbers are placed parallel with traffic and high strength steel is tensioned enabling decreased deflection (see Figure 5.11.05). The newest type of design incorporates veneer lumber that is glued together with specific grain orientations. This system allows for the fabrication of superior tee or box beam shapes that may span greater lengths.

The observations identified on the top and bottom surfaces shall be used to assign the overall condition rating. Defects that occur only in the wearing course that do not extend into the structural deck section shall be excluded. The team leader shall perform the procedures listed for routine inspection, and review Chapter 7 of the BIRM for additional considerations during the inspection.

1. Inspect the timber deck for protective coating failure (if present). Document the approximate location, percentage, and extent of coating failure.
2. Inspect the timber deck for decay and section loss. When section loss is measurable evaluate the area to determine if an in-depth inspection and subsequent load analysis is warranted. Document the approximate location and estimated amount of section loss.
3. Inspect the timber deck for splitting. Document the approximate location and length in respect to the member depth.
4. Inspect the timber deck for loose or failed connections. Document the approximate location of inadequate, deteriorated, or damaged connections.

MICHIGAN STRUCTURE INSPECTION MANUAL
BRIDGE INSPECTION – ROUTINE AND CONDITION BASED IN-DEPTH INSPECTION

5. Inspect the timber deck for insect damage. Document the approximate location, and extent of the suspected damage.
6. Inspect the timber deck for check or shakes. Document the approximate location, note whether they occur in tension or compression zones, and the length in respect to member depth.



Figure 5.11.05 Post Tensioning Glulam Deck Panels

The evaluation of timber decks shall conform to the summarized conditions provided in Table 5.11.04. The MDOT Bridge Safety [NBI Rating Guidelines](#) shall be used to assign an overall code to condition of the entire area present.

Table 5.11.04 Summarized Timber Deck Rating Guidelines

Good	Checks or shakes penetrate less than 5% of the member thickness. Minor deterioration in intermittent locations that has no effect on structural capacity.
Fair	Decay or section loss affecting 5% to 10% of the member section. Checks, shakes, and splits have no effect on capacity. Deterioration of the combined area of both deck surfaces is between 2% and 10% of the total area.
Poor	Decay, section loss, checks, shakes, or splits that do not warrant structural review. Deterioration of the combined area of both deck surfaces is between 10% and 25% of the total area. Structural review and/or load analysis is not required.
Serious	Decay or section loss that affects more than 10% of the member section. Checks, shakes, splits may warrant structural review. Deterioration of the combined area of both deck surfaces is more than 25% of the total area. Structural review and/or load analysis may be necessary to determine if the structure can continue to function without restricted loading.
Critical	The deck will not support design loads and is posted, emergency repairs or temporary shoring is required.

**MICHIGAN STRUCTURE INSPECTION MANUAL
BRIDGE INSPECTION – ROUTINE AND CONDITION BASED IN-DEPTH INSPECTION**

5.11.06 Timber Deck Michigan Bridge Element Inspection

Elements shall be collected for timber decks and slabs using the Michigan Bridge Element Inspection Manual condition states. The quantity to be collected includes the area from edge to edge and reference line to reference line. When multiple defects are within the same vicinity the worst condition state shall be applied to the area. Defects that occur on the top and bottom at identical locations should not be counted twice. Areas that are unexposed shall be evaluated according to visible signs in the materials covering them. Bituminous wearing surfaces or timber running planks are often placed on Element 31 (Timber Deck) Element 54 (Timber Slab). Collect condition state quantities for the associated wearing surface and use the visible signs in the materials covering them to evaluate the condition of the deck.

The timber deck and slab elements are NBEs and quantities and condition state information are reported directly to FHWA on an annual basis. The data provided must be accurate as it will be evaluated during future quality assurance and NBIP reviews.

5.11.07 Deck Work Recommendations

Review sections 5.05.09 and 5.10.07 for applicable examples of work recommendations for decks.

5.11.08 Deck Request for Action

Review sections 5.05.10 and 5.10.08 for applicable examples of triggers that should result in an RFA submittal.

5.11.09 Deck In-Depth Inspection

In-depth inspections shall be performed as-needed and condition based recommendations are provided in Table 5.11.05. A hands-on inspection should be completed to document the deficiencies present once the Deck (Item 58, BSIR #7) condition rating code is 6 or less. Once the surface deteriorates and becomes poor it is suggested to complete repetitive detailed inspections at a 48 month frequency. Detailed inspection or documented review of decks is required for Michigan Bridge Element Inspection when any quantity is coded in Condition State 4.

Table 5.11.05 Recommended Condition Based In-Depth Inspection Guideline for Decks or Slabs

NBI Rating (Item 58)	Schedule Initial In-depth Within	In-Depth Frequency	Applicable Deck Materials		
			Concrete	Steel	Timber
6	24 Months	As-Needed	Concrete	Steel	Timber
4	12 Months	48 Months	Concrete	Steel	Timber

Review sections 5.05.11 and 5.10.09 for areas to examine, requesting the in-depth inspection, activities, and documentation requirements.

MICHIGAN STRUCTURE INSPECTION MANUAL
BRIDGE INSPECTION – ROUTINE AND CONDITION BASED IN-DEPTH INSPECTION

5.12 Drainage (BSIR #8)

Proper drainage of the deck is vital to ensure that motorist safety is not compromised during a precipitation event. Ponding water can lead to hydroplaning, areas of excessive ice formation during the winter months, and increased freeze-thaw damage to the deck, joints, or curb (see Figure 5.12.01). The inspector should look for signs of excessive amounts of surface water present or poor drainage that includes the prevention of water from escaping the surface due to debris accumulation. There is no NBI rating or Michigan Bridge Elements for drainage. The deck drains and the area adjacent to them are to be considered in the evaluation of the deck.

The inspector should note any factors affecting drainage in the comments field of BSIR item 8, and a work recommendation if the impacted drainage is minor. For matters where drainage impacts public safety an RFA should be submitted to the bridge owner that adequately describes the cause of the problem and potential consequences of failing to take action.



Figure 5.12.01 Ponding Water Near the Reference Line

MICHIGAN STRUCTURE INSPECTION MANUAL
BRIDGE INSPECTION – ROUTINE AND CONDITION BASED IN-DEPTH INSPECTION

5.13 Stringer (BSIR #9, SI&A Item 59 - Superstructure)

Restrictions in funding during the past several years for bridge rehabilitation and replacement projects have led to declining condition ratings for many structures in the inventory. These limitations are directly attributable to increasing demands for temporary support installations and other short-term superstructure repairs that permit MDOT owned structures to remain open for traffic. This has also led to an increasing demand for local agency owners to prioritize which poor structures on their systems receive attention, and the necessity to close other bridges where repairs cannot be installed. In order to reduce the frequency of unplanned immediate actions, additional emphasis must be placed on performing in-depth inspections when the level of deterioration cannot be confirmed at distances normally associated during the routine inspection. Bridge owners and team leaders should perform these inspections as often, or more, as the guidelines provided in this section describe to prevent unplanned work activities and critical findings.

5.13.01 Reinforced Concrete Tee Beam Routine NBI Inspection

Cast-in-place concrete tee beams were often constructed from early in the 20th century through the 1960's. As labor costs increased and advancements were achieved in other designs and materials the use of the cast-in-place tee beam superstructure has declined. These types of beams utilize an integral deck resulting in deck condition ratings that affect the superstructure rating (see Figure 5.13.01). The stringer (superstructure) rating may be less than the deck condition rating when defects on the stem of the beam are more severe than the flange. The team leader shall perform the procedures listed for routine inspection, and review Chapter 9 of the BIRM for additional considerations during the inspection.



Figure 5.13.01 Uniform Depth Concrete Tee Beams

MICHIGAN STRUCTURE INSPECTION MANUAL
BRIDGE INSPECTION – ROUTINE AND CONDITION BASED IN-DEPTH INSPECTION

1. Inspect the interface between the concrete tee beam stems and bearings for crushing. Document the location and length that is affected if crushing is observed.
2. Inspect each concrete tee beam stem for cracking within 5 feet of bearing locations. Determine whether the stem is solely affected or the cracking extends into the top flange of the beam. Document the approximate location, orientation, estimated width, and spacing of the cracking.
3. Inspect each concrete tee beam for spalling and delamination within 5 feet of bearing locations. When section loss is observed evaluate the deterioration to determine if an in-depth inspection is required. Document the approximate location, estimated percentage of section loss, and note whether reinforcement is exposed.
4. Inspect the remaining length of each concrete tee beam stem for cracking in flexural zones. Document the approximate location, orientation, estimated width, and spacing of the cracking.
5. Inspect the remaining length of each concrete tee beam top flange in negative moment regions for cracking. If cracking is observed determine whether the top flange is solely affected or whether the cracking extends into the tee beam stem. Document the approximate location, orientation, estimated width, spacing of the cracking, and elements affected.
6. Inspect the entire length of each concrete tee beam stem for efflorescence and heavy rust staining. Document the approximate location, percentage of deck area affected, and degree of the build-up.
7. Inspect the entire length of each concrete tee beam for exposed reinforcement or impact damage. Document the approximate location and beams affected. Review [Chapter 9, Damage Inspection](#) for inspection and documentation requirements.
8. Inspect secondary diaphragm members for deterioration and document any deficiencies observed.
9. Inspect the surfaces of each concrete tee beam that are exposed to drainage and document any deficiencies observed.
10. Record photos of deficiencies when a change in the condition rating occurs and review the in-depth inspection procedures for suggested follow-up activities.

The evaluation of concrete tee beams shall conform to the summarized conditions provided in Table 5.13.01. The MDOT Bridge Safety [NBI Rating Guidelines](#) shall be used to assign an overall code to condition

MICHIGAN STRUCTURE INSPECTION MANUAL
BRIDGE INSPECTION – ROUTINE AND CONDITION BASED IN-DEPTH INSPECTION

of the entire area present. Since the deck component acts as the compression flange of concrete tee beams the deficiencies observed during deck inspection may influence the superstructure rating. The condition of the bearings may also be factored into the superstructure rating; however, they may not negate deterioration or improve the component rating.

Table 5.13.01 Summarized Concrete Tee Beam Rating Guidelines

Good	Hairline cracks in C.I.P. concrete or sealed cracks spaced at more than 3' with no other defects present. Members retain full section properties and function as designed with limited deterioration.
Fair	Cracks in C.I.P. concrete 1/16" wide or less or hairline cracks in P.S. concrete spaced at 1' to 3'. Moderate delamination, spalling, or exposed prestressing reinforcement without section loss. Minor efflorescence present. Members continue to function as designed with moderate deterioration affecting structural members and minor section loss in low or no stress areas. Moderate impact damage that does not require mitigation.
Poor	Cracks in C.I.P. 1/16" wide or greater or hairline cracks in P.S. concrete spaced at less than 1'. Moderate delamination and spalling or exposed prestressing reinforcement without section loss. All members continue to function as designed with considerable deterioration affecting structural members and up to 10% section loss in scattered and isolated areas. Substantial impact damage may be present.
Serious	Structural cracking or reinforcement section loss that may affect load capacity. Considerable deterioration affecting structural members with section loss up to 25% in scattered and isolated areas. Structural evaluation or load analysis may be necessary to determine if the structure can continue to function without restricted loading.
Critical	The superstructure will not support design loads. Posting, emergency repairs installed, or temporary shoring is required.

5.13.02 Concrete Tee Beam Michigan Bridge Element Inspection

Element level information shall be collected for concrete tee beam superstructures using the Michigan Bridge Element Inspection Manual elements and condition states. Element 110 (Reinforced Concrete Open Girder/Beam) shall be used to identify defects on the web and bottom flange (stem) of the beam. Where deterioration of diaphragms is observed the effected length of the adjacent beams shall be coded to reflect the condition state of the secondary member. Element 16 (Reinforced Concrete Top Flange) shall be used for all tee beam designs to capture defects that occur on the bottom surfaces of the compression flange and top surfaces when there are no wearing surfaces present. When there are no deficiencies observed on the top surface or when a wearing surface is present then the condition state quantities should directly correlate to the values entered for Element 811 (Deck Bottom Surface). When any portion of the tee beam stem has been coated with a protective coating then condition state quantities for Element 521 (Concrete Protective Coating) shall be collected.

Additional ADEs have also been created to specifically identify beam end deterioration or repair for improved management and decision making. Element 826 (Beam End Deterioration) and Element 844 (Beam End Contact) may **only** be added when deterioration is present within 5 feet of the beam end, or when permanent repairs have been implemented to resolve the deficiency. Element 845 (Short Height

**MICHIGAN STRUCTURE INSPECTION MANUAL
BRIDGE INSPECTION – ROUTINE AND CONDITION BASED IN-DEPTH INSPECTION**

Beam End Temporary Support) and Element 846 (Full Height Beam End Temporary Support) shall **only** be collected at locations where temporary supports are in-place. Two short height temporary supports are generally required to provide adequate bearing for one beam end. Therefore, the quantity to be collected is for the number of beam ends that are supported and not the amount of supports installed. A flowchart illustrating the process of determining the applicable elements for concrete tee beam designs has been provided for clarification (see Figure 5.13.02). Quantities and condition state information for the NBEs are reported to FHWA on an annual basis. The data provided must be accurate as it will be evaluated during future quality assurance and NBIP reviews.

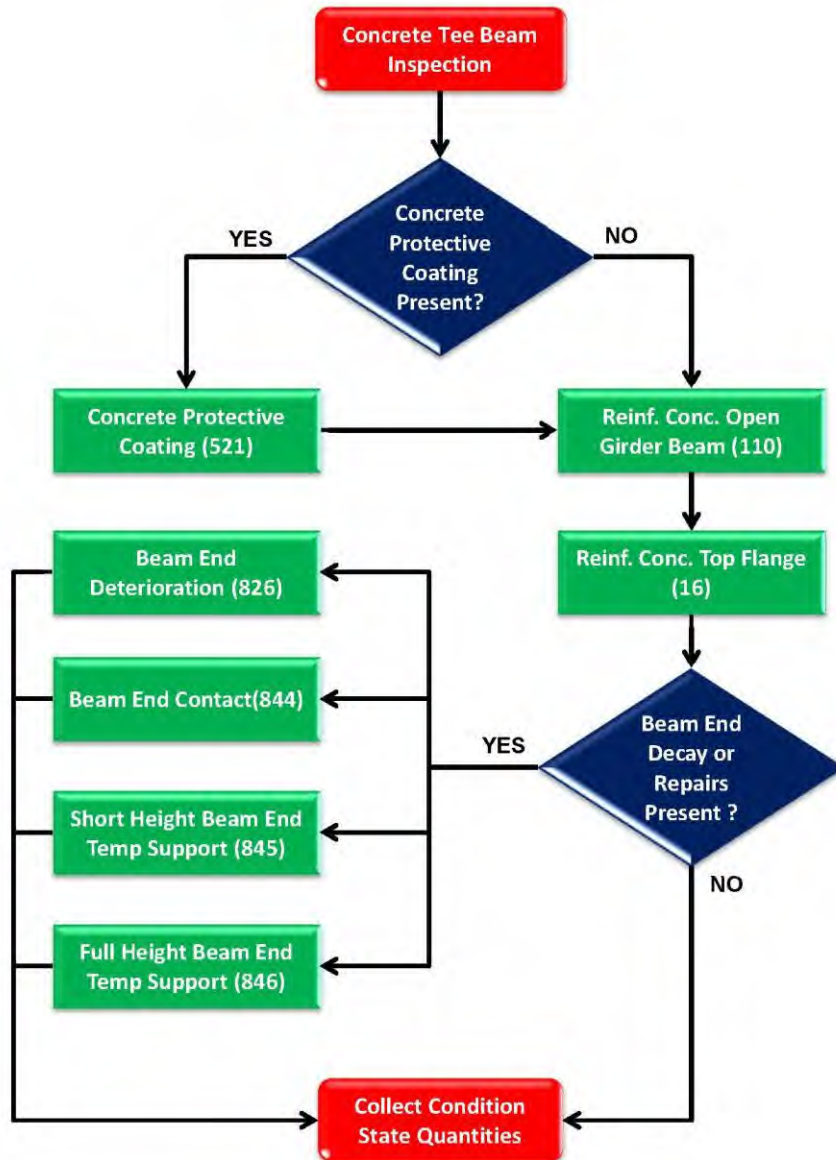

Figure 5.13.02 Concrete Tee Beam Element Collection Process

MICHIGAN STRUCTURE INSPECTION MANUAL
BRIDGE INSPECTION – ROUTINE AND CONDITION BASED IN-DEPTH INSPECTION

5.13.03 Cast-In-Place Slab Routine NBI Inspection

Cast-in-place slabs utilize a superstructure that acts as a means to distribute live loads to the substructure and provide the riding surface for vehicles. On the majority of slab structures there is not a clear delineation between slab and substructure, as these components were often cast integrally during construction. Due to this characteristic slab bridges are often confused with culvert structures. However, these types of bridges are not designed to take advantage of submergence for increased conveyance of flows during peak storm events and do not have fill placed on the superstructure. The team leader shall perform the procedures listed for the routine inspection and review Chapter 9 of the BIRM for additional considerations during the inspection.

1. Inspect the full width of the slab where contact occurs at the substructure or bearings for cracking, and investigate whether any observed cracking is structural or non-structural. Document the approximate location, orientation, estimated width, and spacing of the cracking.
2. Inspect the full width of the slab where contact occurs at the substructure or bearings for delamination and spalling. Document the approximate location, estimated percentage of section loss, and note whether reinforcement is exposed.
3. Inspect the remaining length of the slab for cracking. Document the approximate location, orientation, estimated width, and spacing of the cracking.
4. Inspect the remaining length of the slab for delamination and spalling. Document the approximate location, estimated area, and note whether reinforcement is exposed.
5. Inspect areas exposed to drainage for deterioration. Document the approximate location, type of defect, and cause of the damage.
6. Record photos of deficiencies when a change in the condition rating occurs and review the in-depth procedures for suggested follow-up activities.

The evaluation of cast-in-place slabs shall conform to the summarized conditions provided in Table 5.13.02. The MDOT Bridge Safety [NBI Rating Guidelines](#) shall be used to assign an overall code to condition of the entire area present. Since the deck and superstructure components for slabs are identical the ratings should be similar. The condition of the bearings (if present) may also be factored into the superstructure rating; however, they may not negate deterioration or improve the component rating.

MICHIGAN STRUCTURE INSPECTION MANUAL
BRIDGE INSPECTION – ROUTINE AND CONDITION BASED IN-DEPTH INSPECTION

Table 5.13.02 Summarized Concrete Slab Rating Guidelines

Good	Hairline cracks in C.I.P. concrete or sealed cracks spaced at more than 3' with no other defects present. Members retain full section properties and function as designed with limited deterioration.
Fair	Cracks in C.I.P. concrete 1/16" wide or less or hairline cracks in P.S. concrete spaced at 1' to 3'. Moderate delamination, spalling, or exposed prestressing reinforcement without section loss. Minor efflorescence present. Members continue to function as designed with moderate deterioration affecting structural members and minor section loss in low or no stress areas. Moderate impact damage that does not require mitigation.
Poor	Cracks in C.I.P. 1/16" wide or greater or hairline cracks in P.S. concrete spaced at less than 1'. Moderate delamination and spalling or exposed prestressing reinforcement without section loss. All members continue to function as designed with considerable deterioration affecting structural members and up to 10% section loss in scattered and isolated areas. Substantial impact damage may be present.
Serious	Structural cracking or reinforcement section loss that may affect load capacity. Considerable deterioration affecting structural members with section loss up to 25% in scattered and isolated areas. Structural evaluation or load analysis may be necessary to determine if the structure can continue to function without restricted loading.
Critical	The superstructure will not support design loads. Posting, emergency repairs installed, or temporary shoring is required.

5.13.04 Cast-In-Place Slab Michigan Bridge Element Inspection

Element level information shall be collected for concrete slabs using the Michigan Bridge Element Inspection Manual elements and condition states. Review Section 5.11 for applicable elements and other information.

MICHIGAN STRUCTURE INSPECTION MANUAL
BRIDGE INSPECTION – ROUTINE AND CONDITION BASED IN-DEPTH INSPECTION

5.13.05 Precast Slab Routine NBI Inspection

Precast slabs appear similar to side-by-side box beams and many of the characteristics of transverse post-tensioning and shear keys to achieve monolithic behavior are identical. The majority of precast units have a series of circular voids to reduce dead load and conserve materials which ultimately saves costs during the construction phase. Modern precast slabs utilize prestressing strands to resist tension while older beams may only incorporate conventional longitudinal reinforcement. Since each slab section is generally 36" to 48" wide the plan drawings must be reviewed to confirm that the superstructure is a precast slab and not a box beam. The team leader shall perform the procedures listed for the routine inspection and review Chapter 9 of the BIRM for additional considerations during the inspection.

1. Inspect the full width of each precast slab unit where contact occurs at the substructure or bearings for cracking, and investigate whether any observed cracking is structural or non-structural. Document the approximate location, orientation, estimated width, and spacing of the cracking.
2. Inspect the full width of each precast slab unit where contact occurs at the substructure or bearings for delamination and spalling. Document the approximate, estimated percentage of section loss, and note whether reinforcement is exposed.
3. Inspect the remaining length of the slab for cracking. Reflective longitudinal cracking in the wearing surface may be a result of a reduction in the post tensioning applied to the precast units and warrant an in-depth inspection. Document the approximate location, orientation, estimated width, and spacing of the cracking.
4. Inspect the remaining length of each precast slab unit for delamination and spalling. Document the approximate location, estimated area, and note whether reinforcement is exposed.
5. Inspect areas exposed to drainage for deterioration. Document the approximate location, type of defect, and cause of the damage.
6. Inspect all surfaces for signs of corrosion on prestressing reinforcement. Document the approximate locations and estimate the amount of section loss observed.
7. Inspect precast slab units with weep holes to verify that they are clear for drainage. Document the approximate location of ones that are plugged.
8. Record photos of deficiencies when a change in the condition rating occurs and review the in-depth procedures for suggested follow-up activities.

The evaluation of precast slabs shall conform to the summarized conditions provided in Table 5.13.03. The MDOT Bridge Safety [NBI Rating Guidelines](#) shall be used to assign an overall code to condition of the

MICHIGAN STRUCTURE INSPECTION MANUAL
BRIDGE INSPECTION – ROUTINE AND CONDITION BASED IN-DEPTH INSPECTION

entire area present. Since the deck and superstructure components for slabs are identical the ratings should be similar. The condition of the bearings (if present) may also be factored into the superstructure rating; however, they may not negate deterioration or improve the component rating.

Table 5.13.03 Summarized Precast Concrete Slab Rating Guidelines

Good	Hairline cracks in C.I.P. concrete or sealed cracks spaced at more than 3' with no other defects present. Members retain full section properties and function as designed with limited deterioration.
Fair	Cracks in C.I.P. concrete 1/16" wide or less or hairline cracks in P.S. concrete spaced at 1' to 3'. Moderate delamination, spalling, or exposed prestressing reinforcement without section loss. Minor efflorescence present. Members continue to function as designed with moderate deterioration affecting structural members and minor section loss in low or no stress areas. Moderate impact damage that does not require mitigation.
Poor	Cracks in C.I.P. concrete 1/16" wide or greater or hairline cracks in P.S. concrete spaced at less than 1'. Moderate delamination and spalling or exposed prestressing reinforcement without section loss. All members continue to function as designed with considerable deterioration affecting structural members and up to 10% section loss in scattered and isolated areas. Substantial impact damage may be present.
Serious	Structural cracking or reinforcement section loss that may affect load capacity. Considerable deterioration affecting structural members with section loss up to 25% in scattered and isolated areas. Structural evaluation or load analysis may be necessary to determine if the structure can continue to function without restricted loading.
Critical	The superstructure will not support design loads. Posting, emergency repairs installed, or temporary shoring is required.

5.13.06 Precast Slab Michigan Bridge Element Inspection

Element level information shall be collected for concrete slabs using the Michigan Bridge Element Inspection Manual elements and condition states. Review section 5.11 for applicable elements and additional information.

5.13.07 Prestressed Concrete Box Beams Routine NBI Inspection

Prestressed concrete box beams are easily discerned by the shape of their cross-section and utilize high strength steel strands in conjunction with conventional low carbon steel reinforcement that allow for extended span lengths when compared to traditional cast-in-place beams and slabs. Tensioning of the strands allows for the entire cross section to remain in compression during in-service loading. Generally, prestressed concrete box beam superstructures are composed of 36" to 48" wide sections of varying depths that are placed side-by-side or spread apart. The team leader shall perform the procedures listed for the routine inspection and review Chapter 9 of the BIRM for additional considerations during the inspection.

1. Inspect the interface between the bottom flange and bearings for crushing. Document the location that is affected if crushing is observed.

MICHIGAN STRUCTURE INSPECTION MANUAL
BRIDGE INSPECTION – ROUTINE AND CONDITION BASED IN-DEPTH INSPECTION

2. Inspect each box beam for cracking within 5 feet of bearing locations. Document the location, orientation, estimated width, and spacing of the cracking.
3. Inspect each box beam for spalling and delamination within 5 feet of bearing locations. When section loss is observed evaluate the deterioration to determine if an in-depth inspection is required. Document the location, estimated percentage of section loss, and note whether reinforcement is exposed.
4. Inspect the remaining length of each box beam for cracking in flexural zones. Document the approximate location, orientation, estimated width, and spacing of the cracking.
5. Inspect the deck and adjacent beam surfaces in negative moment regions for cracking. If cracking is observed document the approximate location, orientation, estimated width, spacing of the cracking, and elements affected.
6. Inspect the entire length of each box beam for efflorescence and heavy rust staining. Document the approximate location, length of beam affected, and degree of build-up.
7. Inspect the entire length of each box beam for exposed reinforcement or impact damage. Document the location and approximate area affected in the comment field of the BSIR.
8. Inspect all surfaces for signs of corrosion prestressing reinforcement. Document the approximate locations and estimate the amount of section loss observed.
9. Inspect areas exposed to drainage for deterioration. Document the approximate location, type of defect, and cause of the damage.
10. Inspect precast slab units with weep holes to verify that they are clear for drainage. Document the approximate location of ones that are plugged.
11. Record photos of deficiencies when a change in the condition rating occurs and review the in-depth procedures for suggested follow-up activities.

The evaluation of concrete box beams shall conform to the summarized conditions provided in Table 5.13.04. The MDOT Bridge Safety [NBI Rating Guidelines](#) shall be used to assign an overall code to condition of the entire area present. The condition of the bearings (if present) may also be factored into the superstructure rating; however, they may not negate deterioration or improve the component rating.

MICHIGAN STRUCTURE INSPECTION MANUAL
BRIDGE INSPECTION – ROUTINE AND CONDITION BASED IN-DEPTH INSPECTION

Table 5.13.04 Summarized Concrete Box Beam Rating Guidelines

Good	Hairline cracks in C.I.P. concrete or sealed cracks spaced at more than 3' with no other defects present. Members retain full section properties and function as designed with limited deterioration.
Fair	Cracks in C.I.P. concrete 1/16" wide or less or hairline cracks in P.S. concrete spaced at 1' to 3'. Moderate delamination, spalling, or exposed prestressing reinforcement without section loss. Minor efflorescence present. Members continue to function as designed with moderate deterioration affecting structural members and minor section loss in low or no stress areas. Moderate impact damage that does not require mitigation.
Poor	Cracks in C.I.P. 1/16" wide or greater or hairline cracks in P.S. concrete spaced at less than 1'. Moderate delamination and spalling or exposed prestressing reinforcement without section loss. All members continue to function as designed with considerable deterioration affecting structural members and up to 10% section loss in scattered and isolated areas. Substantial impact damage may be present.
Serious	Structural cracking or reinforcement section loss that may affect load capacity. Considerable deterioration affecting structural members with section loss up to 25% in scattered and isolated areas. Structural evaluation or load analysis may be necessary to determine if the structure can continue to function without restricted loading.
Critical	The superstructure will not support design loads. Posting, emergency repairs installed, or temporary shoring is required.

5.13.08 Prestressed Concrete Box Beams Michigan Bridge Element Inspection

Element level information shall be collected for box beam superstructures using the Michigan Bridge Element Inspection Manual elements and condition states. Element 823 (Prestressed Concrete Box Beams) shall be used to identify defects on the exposed surfaces of the beams. If a structural deck does not exist then Element 15 (Prestressed Concrete Top Flange) shall be used to collect condition state quantities for the top surface, along with the appropriate wearing surface. When any portion of the box beam has been coated with a protective coating then condition state quantities for Element 521 (Concrete Protective Coating) shall be collected (see Figure 5.13.03).

MICHIGAN STRUCTURE INSPECTION MANUAL
BRIDGE INSPECTION – ROUTINE AND CONDITION BASED IN-DEPTH INSPECTION



Figure 5.13.03 Concrete Surface Coating on Side-by-Side Box Beams

Element 823 has been created to distinguish the deterioration that occurs on prestressed concrete box beams compared to segmental girders. Element 826 (Beam End Deterioration) may only be added when deterioration is present within 5 feet of the beam end. A flowchart illustrating the process of determining the applicable elements for concrete box beam designs has been provided for clarification (see Figure 5.13.04). Quantities and condition state information for the element is linked to an NBE that is reported to FHWA on an annual basis. The data provided must be accurate as it will be evaluated during future quality assurance and NBIP reviews.

MICHIGAN STRUCTURE INSPECTION MANUAL
BRIDGE INSPECTION – ROUTINE AND CONDITION BASED IN-DEPTH INSPECTION

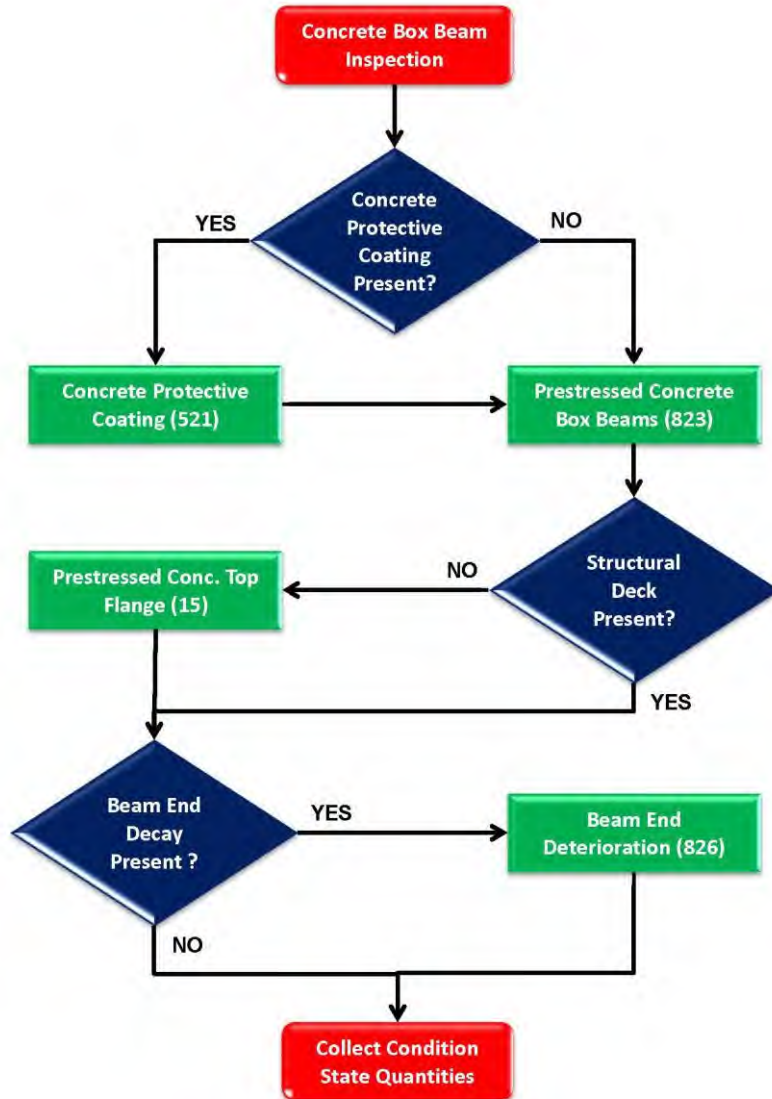

Figure 5.13.04 Concrete Box Beam Element Collection Process

MICHIGAN STRUCTURE INSPECTION MANUAL
BRIDGE INSPECTION – ROUTINE AND CONDITION BASED IN-DEPTH INSPECTION

5.13.09 Prestressed Concrete I-Beam Routine NBI Inspection

Prestressed concrete beams are easily discerned by the shape of their cross-section and utilize high strength steel tendons in conjunction with conventional low carbon steel reinforcement that allow for extended span lengths compared to traditional cast-in-place beams and slabs. Tensioning of the tendons allows for the entire cross section to remain in compression during in-service loading. Generally, prestressed concrete I-beam superstructures are configured using either one of the AASHTO Type 1 through IV shapes or the Michigan 1800 girder. The team leader shall perform the procedures listed for the routine inspection and review Chapter 9 of the BIRM for additional considerations during the inspection.

1. Inspect the interface between the bottom flange and bearings for crushing. Document the location that is affected if crushing is observed.
2. Inspect each I-beam for cracking within 5 feet of bearing locations. Document the location, orientation, estimated width, and spacing of the cracking.
3. Inspect each I-beam for spalling and delamination within 5 feet of bearing locations. When section loss is observed evaluate the deterioration to determine if an in-depth inspection is required. Document the location, estimated percentage of section loss, and note whether reinforcement is exposed.
4. Inspect the remaining length of each I-beam for cracking in flexural zones. Document the approximate location, orientation, estimated width, and spacing of the cracking.
5. Inspect the deck and adjacent beam surfaces for cracking in negative moment regions. If cracking is observed document the approximate location, orientation, estimated width, spacing of the cracking, and elements affected.
6. Inspect the entire length of each I-beam for efflorescence and heavy rust staining. Document the approximate location, length of beam affected, and degree of build-up.
7. Inspect the entire length of each I-beam for exposed reinforcement or impact damage. Document the location and approximate area affected in the comment field of the BSIR.
8. Inspect secondary diaphragm members for defects and identify any features that reduce the overall condition rating in the comment field of the BSIR.
9. Inspect all surfaces for signs of corrosion on prestressing reinforcement. Document the approximate locations and estimate the amount of section loss observed.
10. Inspect areas exposed to drainage for deterioration. Document the approximate location, type of defect, and cause of the damage.

MICHIGAN STRUCTURE INSPECTION MANUAL
BRIDGE INSPECTION – ROUTINE AND CONDITION BASED IN-DEPTH INSPECTION

11. Record photos of deficiencies when a change in the condition rating occurs and review the in-depth procedures for suggested follow-up activities.

The evaluation of concrete I-beams shall conform to the summarized conditions provided in Table 5.13.05. The MDOT Bridge Safety [NBI Rating Guidelines](#) shall be used to assign an overall code to condition of the entire area present. The condition of the bearings (if present) may also be factored into the superstructure rating; however, they may not negate deterioration or improve the component rating.

Table 5.13.05 Summarized Prestressed Concrete I-Beam Rating Guidelines

Good	Hairline cracks in C.I.P. concrete or sealed cracks spaced at more than 3' with no other defects present. Members retain full section properties and function as designed with limited deterioration.
Fair	Cracks in C.I.P. concrete 1/16" wide or less or hairline cracks in P.S. concrete spaced at 1' to 3'. Moderate delamination, spalling, or exposed prestressing reinforcement without section loss. Minor efflorescence present. Members continue to function as designed with moderate deterioration affecting structural members and minor section loss in low or no stress areas. Moderate impact damage that does not require mitigation.
Poor	Cracks in C.I.P. 1/16" wide or greater or hairline cracks in P.S. concrete spaced at less than 1'. Moderate delamination and spalling or exposed prestressing reinforcement without section loss. All members continue to function as designed with considerable deterioration affecting structural members and up to 10% section loss in scattered and isolated areas. Substantial impact damage may be present.
Serious	Structural cracking or reinforcement section loss that may affect load capacity. Considerable deterioration affecting structural members with section loss up to 25% in scattered and isolated areas. Structural evaluation or load analysis may be necessary to determine if the structure can continue to function without restricted loading.
Critical	The superstructure will not support design loads. Posting, emergency repairs installed, or temporary shoring is required.

5.13.10 Prestressed Concrete I-Beam Michigan Bridge Element Inspection

Element level information shall be collected for concrete I-beam superstructures using the Michigan Bridge Element Inspection Manual elements and condition states. Element 104 (Prestressed Concrete Closed Web/Box Girder) shall be used to identify defects on the surfaces of the beams. Where deterioration of diaphragms is observed the effected length of the adjacent beams shall be coded to reflect the condition state of the secondary member. When any portion of the concrete I-beam has been coated with a protective coating then condition state quantities for Element 521 (Concrete Protective Coating) shall be collected.

Additional ADEs have also been created to specifically identify beam end deterioration or repair for improved management and decision making. Element 826 (Beam End Deterioration) and Element 844 (Beam End Contact) may only be added when deterioration is present within 5 feet of the beam end, or when permanent repairs have been implemented to resolve the deficiency. Element 846 (Full Height Beam End Temporary Support) shall only be collected at locations where temporary supports are in-place. A flowchart illustrating the process of determining the applicable elements for concrete tee beam designs

**MICHIGAN STRUCTURE INSPECTION MANUAL
BRIDGE INSPECTION – ROUTINE AND CONDITION BASED IN-DEPTH INSPECTION**

has been provided for clarification (see Figure 5.13.05). Quantities and condition state information for the NBEs are reported to FHWA on an annual basis. The data provided must be accurate as it will be evaluated during future quality assurance and NBIP reviews.

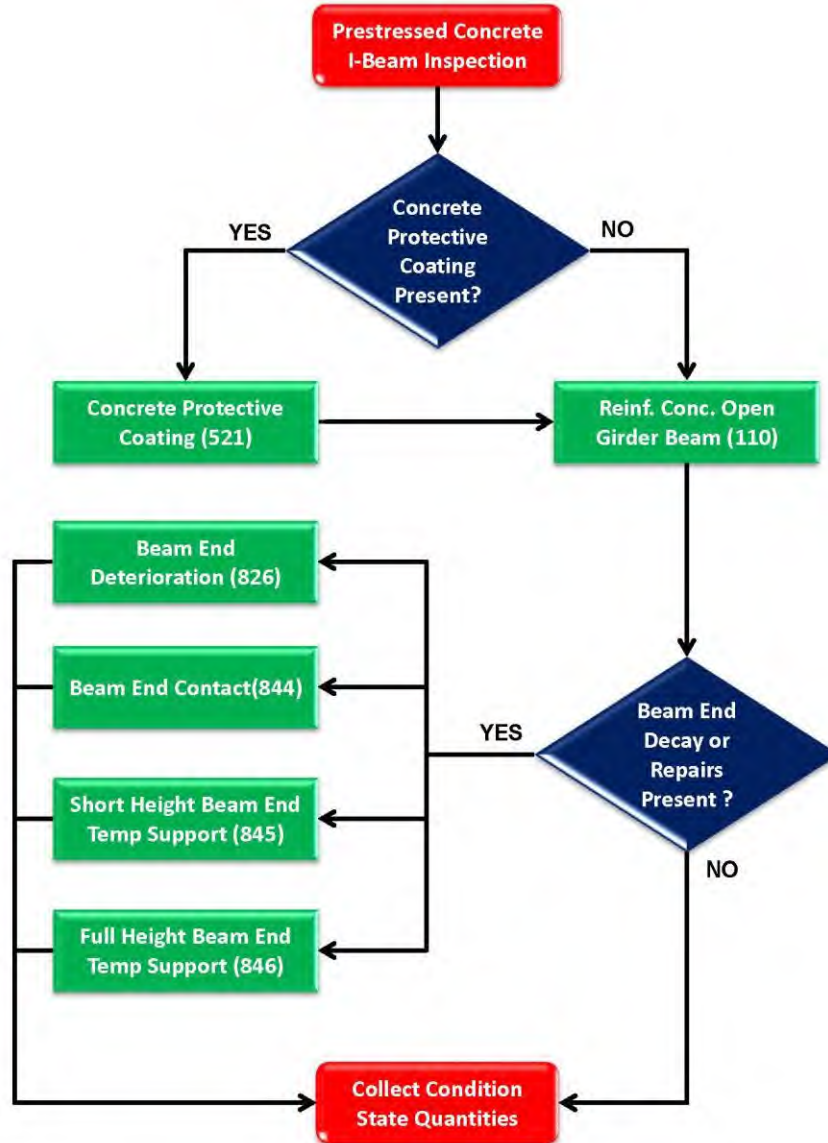

Figure 5.13.05 Prestressed Concrete I-Beam Element Collection Process

MICHIGAN STRUCTURE INSPECTION MANUAL
BRIDGE INSPECTION – ROUTINE AND CONDITION BASED IN-DEPTH INSPECTION

5.13.11 Concrete Arch Routine NBI Inspection

Concrete arches may consist of several configurations which require varying degrees of effort to properly inspect. For example, arch designs with spandrel bents and a floor system will entail a substantial amount of effort in order to observe all of the surface areas compared to closed earth-filled spandrel arches (see Figure 5.13.06). Whereas, a closed spandrel arch without earth backfill may require the greatest effort as access is limited, confined space safety implications are considered, and the use of rigging equipment inside the structure may be needed. The team leader shall perform the procedures listed for the routine inspection and review Chapter 9 of the BIRM for additional considerations during the inspection.

1. Inspect the adjacent areas where the arch bears on the skewback for cracking, efflorescence, rust staining, delamination and spalling. Document the location, orientation, estimated width, and spacing of the cracking. Note the degree of efflorescence build up. Note if reinforcement is exposed and document the estimated percentage of section loss. When section loss is observed, evaluate the deterioration to determine if an in-depth inspection is required.
2. Inspect the adjacent areas where the spandrel column bears on the arch for cracking, efflorescence, rust staining, delamination and spalling. Document the location, orientation, estimated width, and spacing of the cracking. Note the degree of efflorescence build up. Note if reinforcement is exposed and document the estimated percentage of section loss. When section loss is observed, evaluate the deterioration to determine if an in-depth inspection is required.
3. Inspect the adjacent areas where the spandrel cap intercepts the spandrel column for cracking, efflorescence, rust staining, delamination and spalling. Document the location, orientation, estimated width, and spacing of the cracking. Note the degree of efflorescence build up. Note if reinforcement is exposed and document the estimated percentage of section loss. When section loss is observed, evaluate the deterioration to determine if an in-depth inspection is required.
4. Inspect the adjacent areas where the floor system bears on the spandrel cap for cracking, efflorescence, rust staining, delamination and spalling. Document the location, orientation, estimated width, and spacing of the cracking. Note the degree of efflorescence build up. Note if reinforcement is exposed and document the estimated percentage of section loss. When section loss is observed, evaluate the deterioration to determine if an in-depth inspection is required.
5. Inspect the adjacent areas where the spandrel wall bears on the spandrel arch for cracking, efflorescence, rust staining, delamination and spalling. Document the location, orientation, estimated width, and spacing of the cracking. Note the degree of efflorescence build up. Note if reinforcement is exposed and document the estimated percentage of section loss. When section loss is observed, evaluate the deterioration to determine if an in-depth inspection is required.
6. Inspect cantilevered sections of spandrel bent and bent caps for cracking, efflorescence, rust staining, delamination and spalling. Document the location, orientation, estimated width, and

MICHIGAN STRUCTURE INSPECTION MANUAL
BRIDGE INSPECTION – ROUTINE AND CONDITION BASED IN-DEPTH INSPECTION

spacing of the cracking. Note the degree of efflorescence build up. Note if reinforcement is exposed and document the estimated percentage of section loss. When section loss is observed, evaluate the deterioration to determine if an in-depth inspection is required.

7. Inspect the struts that are fixed between arch ribs for cracking. Document the location, orientation, estimated width, and spacing of the cracking. Document the location, orientation, estimated width, and spacing of the cracking. Note the degree of efflorescence build up. Note if reinforcement is exposed and document the estimated percentage of section loss. When section loss is observed, evaluate the deterioration to determine if an in-depth inspection is required.
8. Inspect the flange and bearings of the floor system members for crushing. Document the location that is affected if crushing is observed.
9. Inspect each floor system for cracking, efflorescence, rust staining, delamination and spalling. Document the location, orientation, estimated width, and spacing of the cracking. Note the degree of efflorescence build up. Note if reinforcement is exposed and document the estimated percentage of section loss. When section loss is observed, evaluate the deterioration to determine if an in-depth inspection is required. Special attention should be placed within 5 feet of the bearing areas.
10. Inspect the arch ribs for cracking, efflorescence, rust staining, delamination and spalling. Document the location, orientation, estimated width, and spacing of the cracking. Note the degree of efflorescence build up. Note if reinforcement is exposed and document the estimated percentage of section loss. When section loss is observed, evaluate the deterioration to determine if an in-depth inspection is required.
11. Inspect the spandrel walls for cracking, efflorescence, rust staining, delamination and spalling. Document the location, orientation, estimated width, and spacing of the cracking. Note the degree of efflorescence build up. Note if reinforcement is exposed and document the estimated percentage of section loss. When section loss is observed, evaluate the deterioration to determine if an in-depth inspection is required.
12. Inspect arch surfaces that are exposed to drainage for deterioration. Document the approximate location, type of defect, and cause of the damage.
13. Record photos of deficiencies when a change in the condition rating occurs and review the in-depth procedures for suggested follow-up activities.

The evaluation of concrete arches shall conform to the summarized conditions provided in Table 5.13.06. The MDOT Bridge Safety [NBI Rating Guidelines](#) shall be used to assign an overall code to condition of the entire area present. The condition of the bearings (if present) may also be factored into the superstructure rating; however, they may not negate deterioration or improve the component rating.

MICHIGAN STRUCTURE INSPECTION MANUAL
BRIDGE INSPECTION – ROUTINE AND CONDITION BASED IN-DEPTH INSPECTION

Table 5.13.06 Summarized Concrete Arch Rating Guidelines

Good	Hairline cracks in C.I.P. concrete or sealed cracks spaced at more than 3' with no other defects present. Members retain full section properties and function as designed with limited deterioration.
Fair	Cracks in C.I.P. concrete 1/16" wide or less or hairline cracks in P.S. concrete spaced at 1' to 3'. Moderate delamination, spalling, or exposed prestressing reinforcement without section loss. Minor efflorescence present. Members continue to function as designed with moderate deterioration affecting structural members and minor section loss in low or no stress areas. Moderate impact damage that does not require mitigation.
Poor	Cracks in C.I.P. 1/16" wide or greater or hairline cracks in P.S. concrete spaced at less than 1'. Moderate delamination and spalling or exposed prestressing reinforcement without section loss. All members continue to function as designed with considerable deterioration affecting structural members and up to 10% section loss in scattered and isolated areas. Substantial impact damage may be present.
Serious	Structural cracking or reinforcement section loss that may affect load capacity. Considerable deterioration affecting structural members with section loss up to 25% in scattered and isolated areas. Structural evaluation or load analysis may be necessary to determine if the structure can continue to function without restricted loading.
Critical	The superstructure will not support design loads. Posting, emergency repairs installed, or temporary shoring is required.

5.13.12 Concrete Arch Michigan Bridge Element Inspection

Element level information shall be collected for concrete arch superstructures using the Michigan Bridge Element Inspection Manual elements and condition states. Element 144 (Reinforced Concrete Arch) shall be used to identify defects that occur on the spandrel columns, caps, struts, walls, and arch ribs. When deterioration is observed on spandrel columns or other vertical members the reduced condition state shall apply to the length along the arch. When a floor system is present collect condition state quantities for the associated elements including those elements specifically developed for beam end deterioration.

The total arch quantity shall be the sum of the horizontal length of each arch. For example, four arches comprise each span for the bridge shown in Figures 5.13.06 and 5.13.07. The total quantity of Element 144 would be calculated as $L_{Total} = (L_1 + L_2 + L_3 + L_4 + L_5) \times 4$ in feet.

MICHIGAN STRUCTURE INSPECTION MANUAL
BRIDGE INSPECTION – ROUTINE AND CONDITION BASED IN-DEPTH INSPECTION



Figure 5.13.06 Open Spandrel Concrete Arch with Multiple Ribs



Figure 5.13.07 Horizontal Length along the Traveled Way Must Be Used for Arches

A flowchart illustrating the process of determining the applicable elements for concrete arch structures has been provided for clarification (see Figure 5.13.08). Quantities and condition state information for the NBE and BMEs are reported to FHWA on an annual basis. The data provided must be accurate as it will be evaluated during future quality assurance and NBIP reviews.

MICHIGAN STRUCTURE INSPECTION MANUAL
BRIDGE INSPECTION – ROUTINE AND CONDITION BASED IN-DEPTH INSPECTION

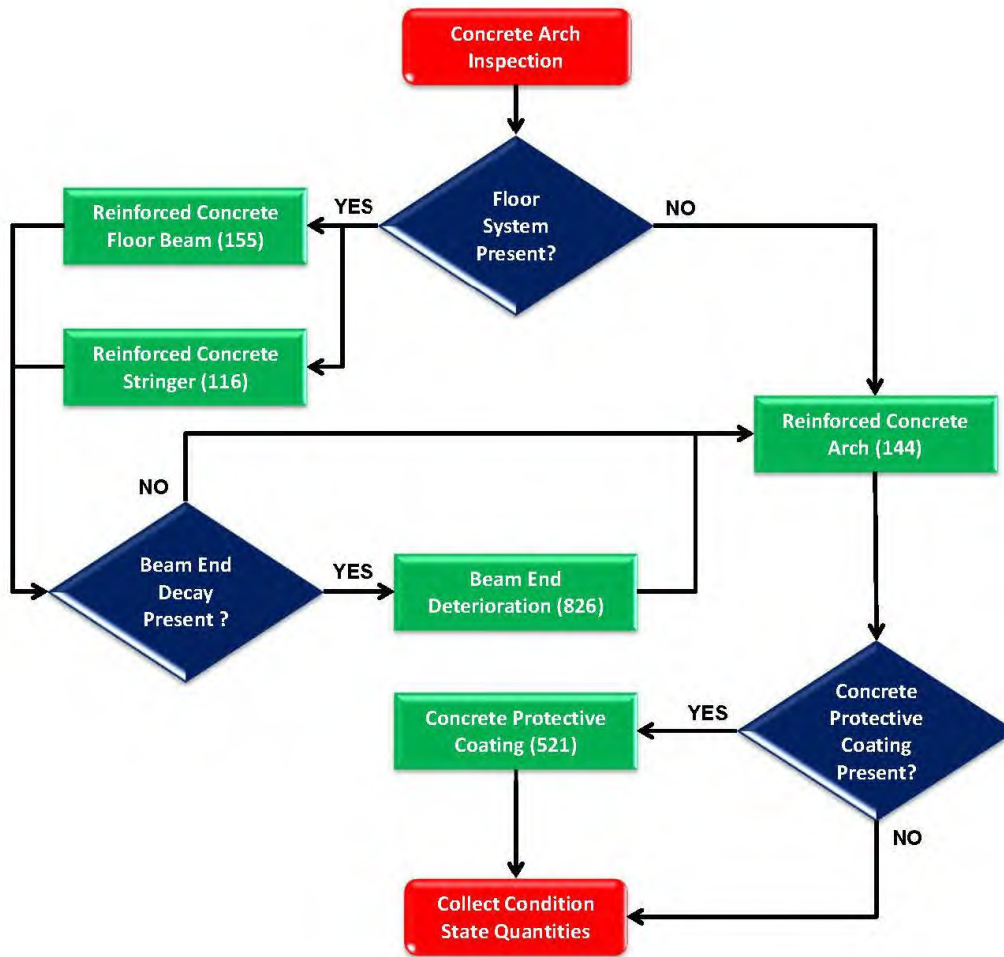

Figure 5.13.08 Reinforced Concrete Arch Element Collection Process

MICHIGAN STRUCTURE INSPECTION MANUAL
BRIDGE INSPECTION – ROUTINE AND CONDITION BASED IN-DEPTH INSPECTION

5.13.13 Load Path Redundant Rolled Beam and Girder Routine NBI Inspection

This section relates to superstructures consisting of three or more rolled steel beams or plate girders with offset spacing that permits load path redundancy. Rolled steel beams are generally used for span lengths that do not exceed 90 feet and are the most common steel elements employed. These shapes are standardized and the physical dimensions are provided in the American Institute of Steel Construction Manual. Plate girders are custom fabricated elements where the flanges are welded to the web plate or fastened using rivets, bolts, and angles. Due to additional costs these plate girders are primarily used for curved superstructures or span lengths that are greater than 90 feet (see Figure 5.13.09). The team leader shall perform the procedures listed and review Chapter 10 of the BIRM for additional considerations during the inspection.



Figure 5.13.09 Curved Steel Plate Girders with Primary Cross Frame Diaphragms

1. Inspect each steel stringer for protective coating failure within 5 feet of bearing locations. Note whether the failure is limited to the top application coat or to bare steel. Document the approximate location, percentage, and extent of coating failure.
2. Inspect each steel stringer for corrosion, section loss, and buckling within 5 feet of bearing locations. Document the location, length of beam affected, and estimated extent of section loss.
3. Inspect the web surfaces for cracking at bearing locations. When cracking has been previously arrested or repairs have been installed observe the surrounding surface area to verify that further propagation is not occurring. Document the approximate location and estimated length of the cracking.
4. Inspect bearing stiffeners and end diaphragms at bearing locations for defects. Document the approximate location of corrosion, section loss, or connection failures when present.

MICHIGAN STRUCTURE INSPECTION MANUAL
BRIDGE INSPECTION – ROUTINE AND CONDITION BASED IN-DEPTH INSPECTION

5. Inspect the remaining length of each steel stringer for protective coating failure. Note whether the failure is limited to the top application coat or to bare steel. Document the approximate location, percentage, and extent of coating failure.
6. Inspect the remaining length of the beam for corrosion, section loss, and buckling while focusing on the condition of the flanges, welded cover plates, or distortion induced by pack rust between insert plates or angles in built-up members. Document the location of protective coating failures and extent of corrosion.
7. Inspect the remaining length of the beam for fatigue cracking at diaphragm connections and cover plate terminations. Document the approximate location and estimated length of the cracking.
8. Inspect the remaining length of the beam for high load hit damage. Document superstructure damage according to [Chapter 9, Damage Inspection](#).
9. Inspect the connections at primary and secondary members for corrosion, cracked welds, and loose or missing fasteners. Document the condition of secondary members when connection failures or other defects are observed.
10. Inspect surfaces that are exposed to drainage for deterioration. These areas may occur near deck drains or ineffective joints. Document the approximate location, type of defect, and cause of the damage.
11. Record photos of deficiencies when a change in the condition rating occurs and review the in-depth inspection procedures for suggested follow-up activities.

The evaluation of load path redundant steel superstructure systems shall conform to the summarized conditions provided in Table 5.13.07. The MDOT Bridge Safety [NBI Rating Guidelines](#) shall be used to assign an overall code to condition of the entire area present. The condition of the bearings (if present) may also be factored into the superstructure rating; however, they may not negate deterioration or improve the component rating.

MICHIGAN STRUCTURE INSPECTION MANUAL
BRIDGE INSPECTION – ROUTINE AND CONDITION BASED IN-DEPTH INSPECTION

Table 5.13.07 Summarized Load Path Redundant Steel Superstructure Rating Guidelines

Good	Very limited partial protective coating failures that do not expose bare steel. Members retain full section properties and function as designed with limited deterioration.
Fair	Protective coating failures with minor loss of section. Cracks are arrested. All connections functioning as intended. Members continue to function as designed with moderate deterioration affecting structural members and minor section loss in low or no stress areas. Moderate impact damage that does not require mitigation.
Poor	Significant protective coating failure and limited loss of section. Cracks not arrested or missing fasteners are present. All members continue to function as designed with considerable deterioration affecting structural members and up to 10% section loss in scattered and isolated areas. Substantial impact damage may be present.
Serious	Protective coating failed with measurable loss of section. Cracks or missing fasteners may affect design capacity. Considerable deterioration affecting structural members with section loss up to 25% in scattered and isolated areas. Structural evaluation or load analysis may be necessary to determine if the structure can continue to function without restricted loading.
Critical	The superstructure will not support design loads. Posting, emergency repairs installed, or temporary shoring is required.

5.13.14 Load Path Redundant Rolled Beam and Girder Michigan Bridge Element Inspection

Element level information shall be collected for load path redundant steel superstructure systems using the Michigan Bridge Element Inspection Manual elements and condition states. Element 107 (Steel Open Girder/Beam) shall be used to identify defects that occur on the primary member as well as the affected length of where deterioration is observed on secondary members. For curved bridges, where the diaphragms are primary members, condition state quantities shall be collected using Element 825 (Primary Steel Diaphragm). Element 515 (Steel Protective Coating) shall be used to quantify the condition of protective coating on the exposed surfaces.

Additional elements have also been created to specifically identify beam end deterioration or repair for improved management and decision making. Element 826 (Beam End Deterioration) and Element 844 (Beam End Contact) may **only** be added when deterioration is present within 5 feet of the beam end, or when permanent repairs have been implemented to resolve the deficiency. Element 846 (Full Height Beam End Temporary Support) shall **only** be collected at locations where temporary supports are in-place. A flowchart illustrating the process of determining the applicable elements for steel load path redundant designs has been provided for clarification (see Figure 5.13.10). Quantities and condition state information for the NBEs are reported to FHWA on an annual basis. The data provided must be accurate as it will be evaluated during future quality assurance and NBIP reviews.

**MICHIGAN STRUCTURE INSPECTION MANUAL
BRIDGE INSPECTION – ROUTINE AND CONDITION BASED IN-DEPTH INSPECTION**

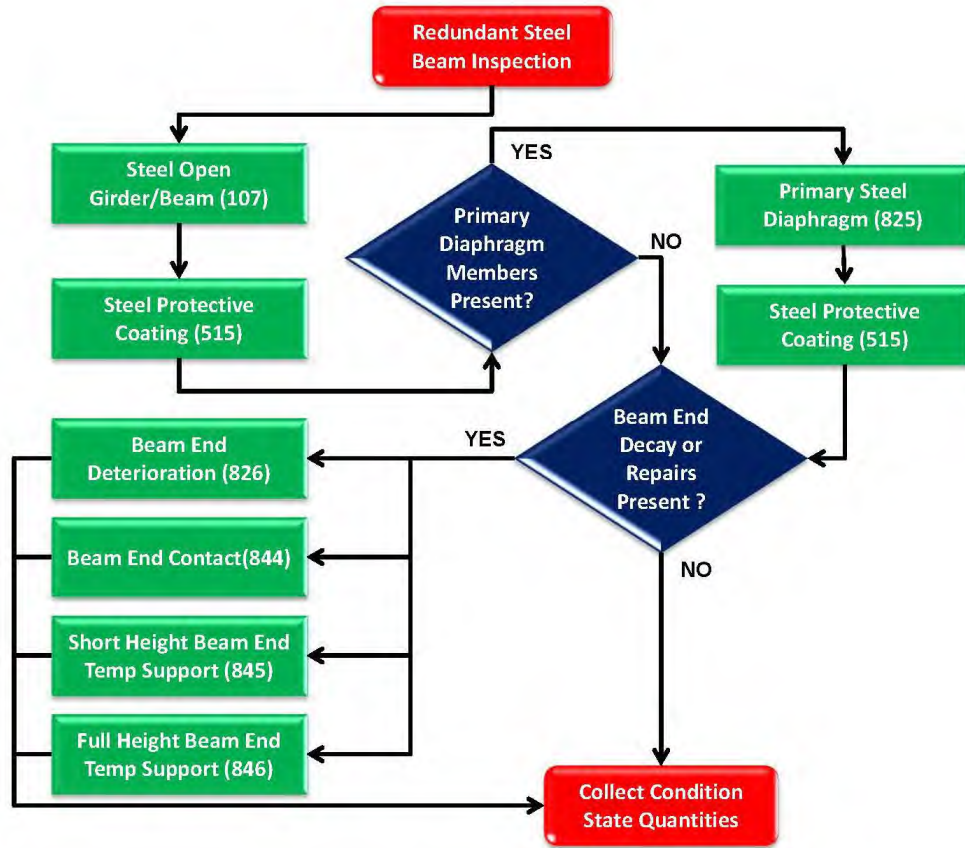

Figure 5.13.10 Load Path Redundant Steel Superstructure Element Collection Process

MICHIGAN STRUCTURE INSPECTION MANUAL
BRIDGE INSPECTION – ROUTINE AND CONDITION BASED IN-DEPTH INSPECTION

5.13.15 Two Girder Steel Routine NBI Inspection

This section relates to deck and through girder bridges where only two steel members are employed to transmit loads from the floor system to the bearings (see Figure 5.13.11). Since the structural system is not load path redundant a routine and fracture critical inspection must be performed. In circumstances where each kind of inspection is not performed by the same team leader, it is recommended to coordinate the work so it is completed concurrently to reduce mobility effects and duplication of effort. The team leader completing the routine inspection must take into account the findings from the fracture critical inspection when completing the routine and element level documentation. While these systems use plate girders that are either welded or fastened together similar to the previous section, there are no general maximum span lengths. Extra attention must be paid to signs of deterioration at the floor beams as they may also be fracture critical. The team leader shall perform the procedures listed for the routine inspection, and review Chapter 10 of the BIRM for additional considerations during the inspection. In addition, the BIRM and [Chapter 7](#) of the MiSIM shall be referenced for information relating to the fracture critical elements on the structure.



Figure 5.13.11 Non-Redundant Fracture Critical Two Girder Superstructure System

1. Inspect each girder, floor beam, and stringer for protective coating failure within 5 feet of bearing locations. Note whether the failure is limited to the top application coat or to bare steel. Document the approximate location, percentage, and extent of coating failure.
2. Inspect each steel girder, floor beam, and stringer for corrosion, section loss, and buckling within 5 feet of bearing locations. Document the location, length of beam affected, and estimated extent of section loss.
3. Inspect the web surfaces of each steel girder, floor beam, and stringer for cracking at bearing locations. When cracking has been previously arrested or repairs have been installed observe the

MICHIGAN STRUCTURE INSPECTION MANUAL
BRIDGE INSPECTION – ROUTINE AND CONDITION BASED IN-DEPTH INSPECTION

surrounding surface area to verify that further propagation is not occurring. Document the approximate location and estimated length of the cracking.

4. Inspect bearing stiffeners and end diaphragms at bearing locations for defects. Document the approximate location of corrosion, section loss, or connection failures when present.
5. Inspect the remaining length of each steel girder, floor beam, and stringer for protective coating failure. Note whether the failure is limited to the top application coat or to bare steel. Document the approximate location, percentage, and extent of coating failure.
6. Inspect the remaining length of the steel girders, floor beams, and stringers for corrosion, section loss, and buckling while focusing on the condition of the flanges, welded cover plates, or distortion induced by pack rust between insert plates or angles in built-up members. Document the location of protective coating failures and extent of corrosion.
7. Inspect the remaining length of each girder, floor beam, and stringer for fatigue cracking. Cracks observed in fracture critical members are serious and immediate action such as bridge closure may be necessary. Contact the bridge owner when cracking is observed and document the approximate location and estimated length of the cracking.
8. Inspect the remaining length of each steel girder, floor beam, and stringer for high load hit damage. Document superstructure damage according to [Chapter 9, Damage Inspection](#).
9. Inspect the connections at primary and secondary members for corrosion, cracked welds, and loose or missing fasteners. Document the condition of secondary members when connection failures or other defects are observed.
10. Inspect surfaces that are exposed to drainage for deterioration. Document the approximate location, type of defect, and cause of the deterioration.
11. Record photos of deficiencies when a change in the condition rating occurs and review the in-depth inspection procedures for suggested follow-up activities.

The evaluation of two girder steel superstructure systems shall conform to the summarized conditions provided in Table 5.13.08. The MDOT Bridge Safety [NBI Rating Guidelines](#) shall be used to assign an overall code to condition of the entire area present. The condition of the bearings (if present) may also be factored into the superstructure rating; however, they may not negate deterioration or improve the component rating.

MICHIGAN STRUCTURE INSPECTION MANUAL
BRIDGE INSPECTION – ROUTINE AND CONDITION BASED IN-DEPTH INSPECTION

Table 5.13.08 Summarized Two Girder Steel Superstructure Rating Guidelines

Good	Very limited partial protective coating failures that do not expose bare steel. Members retain full section properties and function as designed with limited deterioration.
Fair	Protective coating failures with minor loss of section. Cracks are arrested. All connections functioning as intended. Members continue to function as designed with moderate deterioration affecting structural members and minor section loss in low or no stress areas. Moderate impact damage that does not require mitigation.
Poor	Significant protective coating failure and limited loss of section. Cracks not arrested or missing fasteners are present. All members continue to function as designed with considerable deterioration affecting structural members and up to 10% section loss in scattered and isolated areas. Substantial impact damage may be present.
Serious	Protective coating failed with measurable loss of section. Cracks or missing fasteners may affect design capacity. Considerable deterioration affecting structural members with section loss up to 25% in scattered and isolated areas. Structural evaluation or load analysis may be necessary to determine if the structure can continue to function without restricted loading.
Critical	The superstructure will not support design loads. Posting, emergency repairs installed, or temporary shoring is required.

5.13.16 Two Girder Steel Michigan Bridge Element Inspection

Element level information shall be collected for two girder steel superstructure systems using the Michigan Bridge Element Inspection Manual elements and condition states. Element 107 (Steel Open Girder/Beam) shall be used to identify defects that occur on the primary member as well as the affected length of where deterioration is observed on secondary members. Element 152 (Steel Floor Beam) and Element 113 (Steel Stringer) shall be used to capture condition state quantities for floor system members. Where the diaphragms are primary members, condition state quantities shall be collected using Element 825 (Primary Steel Diaphragm). Element 515 (Steel Protective Coating) shall be used to quantify the condition of protective coating on the exposed surfaces.

Additional elements have also been created to specifically identify beam end deterioration or repair for improved management and decision making. Element 826 (Beam End Deterioration) and Element 844 (Beam End Contact) may only be added when deterioration is present within 5 feet of the beam end, or when permanent repairs have been implemented to resolve the deficiency. Element 846 (Full Height Beam End Temporary Support) shall only be collected at locations where temporary supports are in-place. A flowchart illustrating the process of determining the applicable elements for two girder steel designs has been provided for clarification (see Figure 5.13.12). Quantities and condition state information for the NBEs are reported to FHWA on an annual basis. The data provided must be accurate as it will be evaluated during future quality assurance and NBIP reviews.

MICHIGAN STRUCTURE INSPECTION MANUAL
 BRIDGE INSPECTION – ROUTINE AND CONDITION BASED IN-DEPTH INSPECTION

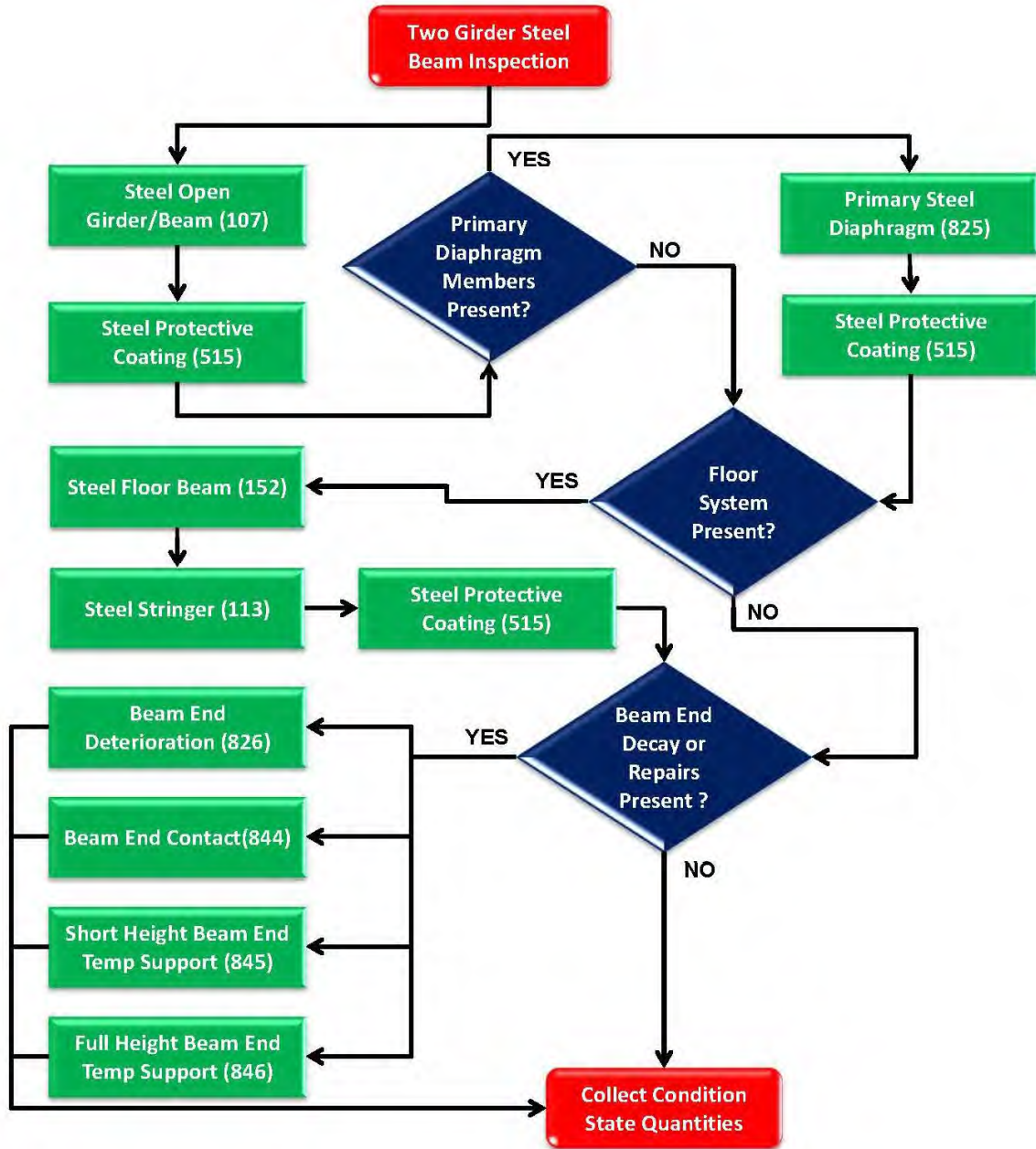

Figure 5.13.12 Two Girder Steel Superstructure Element Collection Process

MICHIGAN STRUCTURE INSPECTION MANUAL
BRIDGE INSPECTION – ROUTINE AND CONDITION BASED IN-DEPTH INSPECTION

5.13.17 Steel Box Girder Routine NBI Inspection

This section relates to superstructures composed of one or more steel box girders. Box girders may be constructed for simple or continuous spans and are often used on curved alignments because of their ability to resist torsion. Box girders consist of two offset web plates that may be perpendicular to the bottom flange plate or rotated opposite of one another to form a trapezoid. In cases where a steel top flange is not utilized, composite action is incorporated through the use of shear anchoring devices and compressive forces are transferred through the deck section. Internal stiffeners, diaphragms, and bracing inside the box section shall be evaluated as primary members. When only one or two boxes are used there is no load path redundancy and fracture critical inspections must be performed. In circumstances where each kind of inspection is not performed by the same team leader, it is recommended to coordinate the work so it is completed concurrently to reduce mobility effects and duplication of effort. The team leader completing the routine inspection must take into account the findings from the fracture critical inspection when completing the routine and element level documentation.

The team leader shall perform the procedures listed for the routine inspection, and review [Chapter 7](#) of the MiSIM as well as Chapter 10 of the BIRM for additional considerations during the inspection. Prior to entering a box girder the team leader will review the as-built drawings to determine if the box girder is a confined space and consult an occupational safety specialist for additional guidance when uncertainty exists.

1. Inspect the web surfaces of the box girder(s), primary diaphragms, internal stiffeners, and bracing for protective coating failures at bearing and fastened locations. Note whether the failure is limited to the top application coat or to bare steel. Document the approximate location, percentage, and extent of coating failure.
2. Inspect the web surfaces of the box girder(s), primary diaphragms, internal stiffeners, and bracing for corrosion, section loss, and buckling at bearing and fastened locations during each inspection. Document the location, length of beam affected, and estimated extent of section loss.
3. Inspect the web surfaces of the box girder(s), primary diaphragms, internal stiffeners, and bracing for cracking at bearing and fastened locations. If either defect is observed document the location and submit an RFA to the bridge owner for immediate action. When cracking has been previously arrested or repairs have been installed observe the surrounding surface area to verify that further propagation is not occurring. Document the approximate location and estimated length of the cracking.
4. Inspect the remaining length of the box girders while focusing on the condition of the flanges, and cover plates if they exist. Document the approximate location of protective coating failures and extent of corrosion.
5. Inspect the remaining length of the steel box girders for fatigue cracking. Especially review areas adjacent to diaphragm connections, and flange or longitudinal stiffener splice welds.

MICHIGAN STRUCTURE INSPECTION MANUAL
BRIDGE INSPECTION – ROUTINE AND CONDITION BASED IN-DEPTH INSPECTION

Cracks observed in fracture critical members are serious and immediate action such as bridge closure may be necessary. Contact the bridge owner when cracking is observed and document the approximate location and estimated length of the cracking.

6. Inspect the remaining length of each steel girder, floor beam, and stringer for high load hit damage. Document superstructure damage according to [Chapter 9, Damage Inspection](#).
7. Inspect the connections at primary and secondary members for corrosion, cracked welds, and loose or missing fasteners. Document the condition of secondary members when connection failures or other defects are observed.
8. Inspect surfaces that are exposed to drainage for deterioration. Document the approximate location, type of defect, and cause of the damage.
9. Record photos of deficiencies when a change in the condition rating occurs and review the in-depth inspection procedures for suggested follow-up activities.

The evaluation of box girder steel superstructure systems shall conform to the summarized conditions provided in Table 5.13.09. The MDOT Bridge Safety [NBI Rating Guidelines](#) shall be used to assign an overall code to condition of the entire area present. The condition of the bearings (if present) may also be factored into the superstructure rating; however, they may not negate deterioration or improve the component rating.

Table 5.13.09 Summarized Steel Box Girder Rating Guidelines

Good	Very limited partial protective coating failures that do not expose bare steel. Members retain full section properties and function as designed with limited deterioration.
Fair	Protective coating failures with minor loss of section. Cracks are arrested. All connections functioning as intended. Members continue to function as designed with moderate deterioration affecting structural members and minor section loss in low or no stress areas. Moderate impact damage that does not require mitigation.
Poor	Significant protective coating failure and limited loss of section. Cracks not arrested or missing fasteners are present. All members continue to function as designed with considerable deterioration affecting structural members and up to 10% section loss in scattered and isolated areas. Substantial impact damage may be present.
Serious	Protective coating failed with measurable loss of section. Cracks or missing fasteners may affect design capacity. Considerable deterioration affecting structural members with section loss up to 25% in scattered and isolated areas. Structural evaluation or load analysis may be necessary to determine if the structure can continue to function without restricted loading.
Critical	The superstructure will not support design loads. Posting, emergency repairs installed, or temporary shoring is required.

**MICHIGAN STRUCTURE INSPECTION MANUAL
BRIDGE INSPECTION – ROUTINE AND CONDITION BASED IN-DEPTH INSPECTION**

5.13.18 Steel Box Girder Michigan Bridge Element Inspection

Element level information shall be collected for steel box girder systems using the Michigan Bridge Element Inspection Manual elements and condition states. Element 102 (Steel Closed Web/Box Girder) shall be used to identify defects that occur on the primary members. In cases where the box girder has been classified as fracture critical, the diaphragms are generally considered a primary member and the conditions state quantities shall be collected as Element 825 (Primary Steel Diaphragm). Element 515 (Steel Protective Coating) shall be used to quantify the condition of protective coating on the exposed surfaces. The interior surfaces, if accessible, of the box shall be included in the calculation of total surface area. A flowchart illustrating the process of determining the applicable elements for steel box girder designs has been provided for clarification (see Figure 5.13.13). Quantities and condition state information for the NBEs are reported to FHWA on an annual basis. The data provided must be accurate as it will be evaluated during future quality assurance and NBIP reviews.

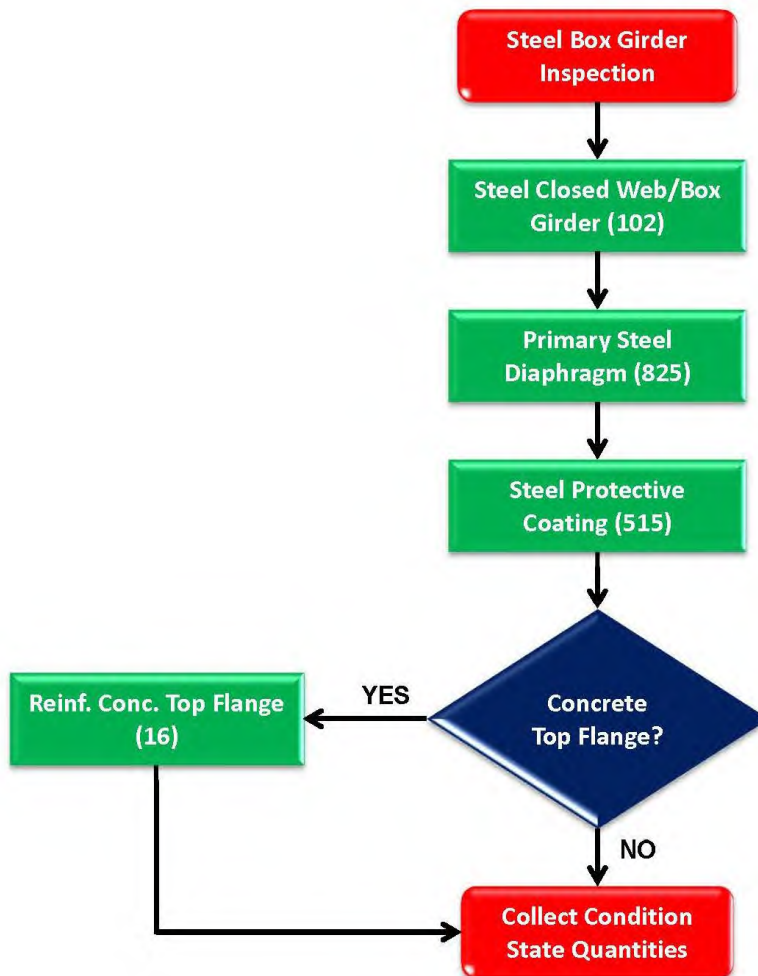

Figure 5.13.13 Steel Box Girder Element Collection Process

MICHIGAN STRUCTURE INSPECTION MANUAL
BRIDGE INSPECTION – ROUTINE AND CONDITION BASED IN-DEPTH INSPECTION

5.13.19 Steel Truss Routine NBI Inspection

This section relates to steel through, pony, deck, or truss systems that are used as a supplemental means to strengthen other types of superstructures. The areas of trusses are delineated by means of the top chord, bottom chord, and web consisting of vertical and diagonal elements that attach to each of the chords. The variety of built-up and rolled shapes used to construct them makes many trusses unique while the categorization of forces is often easy to determine. In instances where it is difficult to determine whether a member acts to resist compression or tension, the team leader should review the force diagram on the plan drawings. All primary members acting in tension on trusses are fracture elements, and pins or portions of floor systems may be as well. All members subject to stress reversals shall be inspected as fracture critical elements. In circumstances where the routine and fracture critical inspection are not performed by the same team leader, it is recommended to coordinate the work so it is completed concurrently to reduce mobility effects and duplication of effort. The team leader completing the routine inspection must take into account the findings from the fracture critical inspection when completing the routine and element level documentation. The team leader shall perform the procedures listed for the routine inspection review [Chapter 7](#) of the MiSIM, and Chapter 10 of the BIRM for additional considerations during the inspection.

1. Inspect truss and floor system members for protective coating failures. Pay special attention to failures within 5 feet of bearing areas or connections and note whether the failure is limited to the top application coat or to bare steel. Document the approximate location, percentage, and extent of coating failure.
2. Inspect the webs of truss members, floor beams, and stringers for cracking near bearing areas. When cracking has been previously arrested or repairs have been installed observe the surrounding surface area to verify that further propagation is not occurring. Document the approximate location and estimated length of the cracking.
3. Inspect the webs of truss members, floor beams, and stringers for corrosion, section loss, and buckling within 5 feet of bearing locations. Document the location, length of beam affected, and estimated extent of section loss.
4. Inspect the entire length of tension members for cracking. When cracking has been previously repaired observe the surrounding surface area to verify that further propagation is not occurring. Cracks in fracture critical elements require prompt attention and usually necessitate immediate action. Document the approximate location and estimated length of the cracking.
5. Inspect the entire length of tension members for corrosion and section loss. Document the approximate location, length of member affected, and estimated extent of section loss.
6. Inspect tension members for loose or deteriorated connections. Document the condition of the connections and associated defects when deterioration is observed.

MICHIGAN STRUCTURE INSPECTION MANUAL
BRIDGE INSPECTION – ROUTINE AND CONDITION BASED IN-DEPTH INSPECTION

7. Inspect the entire length of compression members for misalignment. Document the location and position of the member in respect to other elements.
8. Inspect the entire length of compression members for corrosion, section loss, and buckling. Document the approximate location, length of member affected, and estimated extent of section loss.
9. Inspect built-up members for distortion induced by pack rust. When distortion is observed, inspect the fasteners to ensure that they have not been compromised. Document the location where distortion has occurred.
10. Inspect the truss and floor system members for the problematic details provided in [Chapter 7](#) or Section 6.4.5 of the BIRM.
11. Inspect gusset plates for corrosion, section loss, out-of-plane distortion, and cracking around welds or fasteners. Document the location and type of defect observed.
12. Inspect truss and floor system members for impact damage. Document superstructure damage according to [Chapter 9, Damage Inspection](#).
13. Inspect secondary members for deterioration and cracking. Document the location and type of defect observed.
14. Inspect the connections at primary and secondary members for corrosion, cracked welds, and loose or missing fasteners. Document the condition of secondary members when connection failures or other defects are observed.
15. Inspect surfaces that are exposed to drainage for deterioration. Document the approximate location, type of defect, and cause of the damage.
16. Record photos of deficiencies when a change in the condition rating occurs and review the in-depth inspection procedures for suggested follow-up activities.

The evaluation of steel truss superstructure systems shall conform to the summarized conditions provided in Table 5.13.10. The MDOT Bridge Safety [NBI Rating Guidelines](#) shall be used to assign an overall code to condition of the entire area present. The condition of the bearings (if present) may also be factored into the superstructure rating; however, they may not negate deterioration or improve the component rating.

Table 5.13.10 Summarized Steel Truss Rating Guidelines

MICHIGAN STRUCTURE INSPECTION MANUAL
BRIDGE INSPECTION – ROUTINE AND CONDITION BASED IN-DEPTH INSPECTION

Good	Very limited partial protective coating failures that do not expose bare steel. Members retain full section properties and function as designed with limited deterioration.
Fair	Protective coating failures with minor loss of section. Cracks are arrested. All connections functioning as intended. Members continue to function as designed with moderate deterioration affecting structural members and minor section loss in low or no stress areas. Moderate impact damage that does not require mitigation.
Poor	Significant protective coating failure and limited loss of section. Cracks not arrested or missing fasteners are present. All members continue to function as designed with considerable deterioration affecting structural members and up to 10% section loss in scattered and isolated areas. Substantial impact damage may be present.
Serious	Protective coating failed with measurable loss of section. Cracks or missing fasteners may affect design capacity. Considerable deterioration affecting structural members with section loss up to 25% in scattered and isolated areas. Structural evaluation or load analysis may be necessary to determine if the structure can continue to function without restricted loading.
Critical	The superstructure will not support design loads. Posting, emergency repairs installed, or temporary shoring is required.

5.13.20 Steel Truss Michigan Bridge Element Inspection

Element level information shall be collected for steel truss structures using the Michigan Bridge Element Inspection Manual elements and condition states. Element 120 (Steel Truss) shall be used to identify defects that occur on the primary members. In addition, three ADEs have been created to collect condition state quantities for improved safety and analysis. Gusset plates that connect the main truss panels shall be evaluated and condition state quantities will be collected for each one as Element 162 (Steel Gusset Plate). Fracture critical tension members, inspected during each routine and fracture critical inspection, shall be recorded as Element 824 (Steel Truss or Steel Arch Tension Member). Portal bracing and other primary diaphragms shall be identified as Element 825 (Primary Steel Diaphragm). Elements for the floor system and any beam end deterioration observed shall also be collected as applicable.

The total truss quantity shall be the sum of the horizontal length of each truss (see Figure 5.13.14). For the majority of trusses, this number shall be multiplied by 2 in order to account for the truss on the opposite side. The total quantity of Element 120 would be calculated as $L_{Total} = (L_1 + L_2 + L_3) \times 2$ in feet. Distresses observed in diagonal members are to be reported for the length of the affected panel.

A flowchart illustrating the process of determining the applicable elements for concrete tee beam designs has been provided for clarification (see Figure 5.13.15). Quantities and condition state information for the NBEs are reported to FHWA on an annual basis. The data provided must be accurate as it will be evaluated during future quality assurance and NBIP reviews.

**MICHIGAN STRUCTURE INSPECTION MANUAL
BRIDGE INSPECTION – ROUTINE AND CONDITION BASED IN-DEPTH INSPECTION**

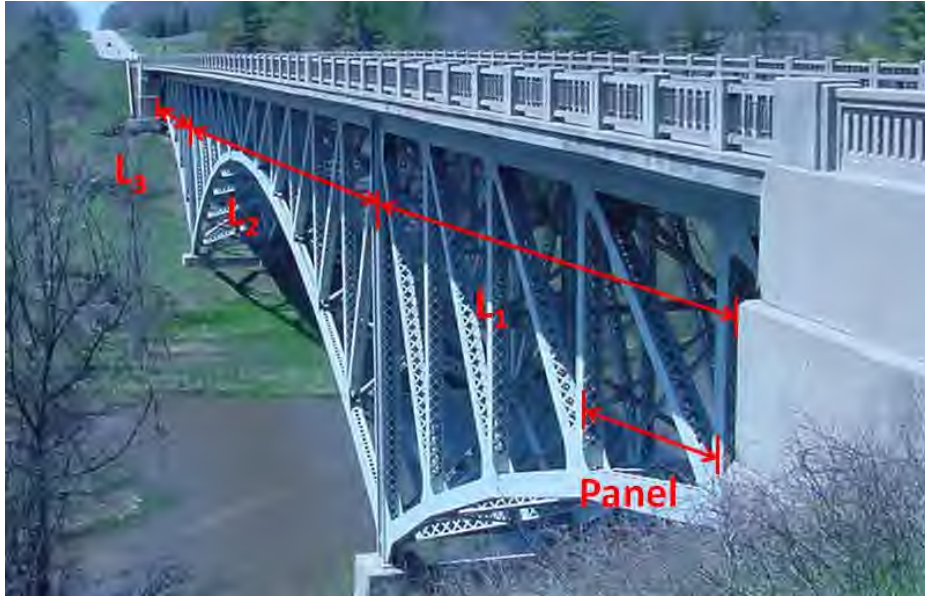

Figure 5.13.14 Horizontal Length along the Traveled Way Must Be Used for Trusses

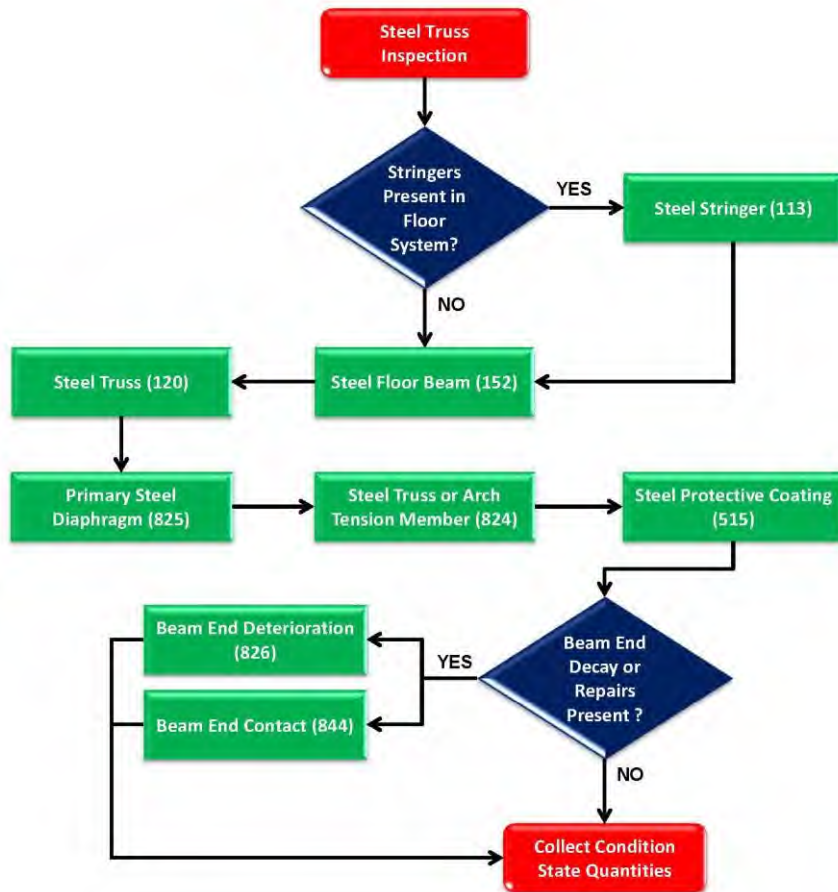

Figure 5.13.15 Steel Truss Element Collection Process

MICHIGAN STRUCTURE INSPECTION MANUAL
BRIDGE INSPECTION – ROUTINE AND CONDITION BASED IN-DEPTH INSPECTION

5.13.21 Steel Arch Routine NBI Inspection

This section relates to steel through, tied, and deck arch systems. Each arch design utilizes different features to transfer loads from the deck to the substructure. Although arches remain in a state of compression they may contain floor systems or other elements that are fracture critical (see Figure 5.13.16). In circumstances where the routine and fracture critical inspection are not performed by the same team leader, it is recommended to coordinate the work so it is completed concurrently to reduce mobility effects and duplication of effort. The team leader completing the routine inspection must take into account the findings from the fracture critical inspection when completing the routine and element level documentation. The team leader shall perform the procedures listed for the routine inspection, review [Chapter 7](#) of the MiSIM, and Chapter 10 of the BIRM for additional considerations during the inspection.



Figure 5.13.16 Steel Through Arch with Fracture Critical Floor Beams and Suspension Hangers

1. Inspect arch and floor system members for protective coating failures. Pay special attention to failures within 5 feet of bearing areas or connections and note whether the failure is limited to the top application coat or to bare steel. Document the approximate location, percentage, and extent of coating failure.
2. Inspect the arch webs, floor beams, and stringers for cracking near bearing areas. When cracking has been previously arrested or repairs have been installed observe the surrounding surface area to verify that further propagation is not occurring. Document the approximate location and estimated length of the cracking.
3. Inspect the arch webs, floor beams, and stringers for corrosion, section loss, and buckling within 5 feet of bearing locations. Document the location, length of beam affected, and estimated extent of section loss.

MICHIGAN STRUCTURE INSPECTION MANUAL
BRIDGE INSPECTION – ROUTINE AND CONDITION BASED IN-DEPTH INSPECTION

4. Inspect the entire length of tension members for cracking. When cracking has been previously repaired observe the surrounding surface area to verify that further propagation is not occurring. If tension member is considered to be fracture critical review [Chapter 7 Fatigue Sensitive and Fracture Critical Member Inspection](#). Cracks in fracture critical elements require prompt attention and usually necessitate immediate action. Document the approximate location and estimated length of the cracking.
5. Inspect the entire length of tension members for corrosion and section loss. Document the approximate location, length of member affected, and estimated extent of section loss.
6. Inspect tension members for loose or deteriorated connections. Document the condition of the connections and associated defects when deterioration is observed.
7. Inspect the entire length of compression members for misalignment. Document the location and position of the member in respect to other elements.
8. Inspect the entire length of compression members for corrosion, section loss, and buckling. Document the approximate location, length of member affected, and estimated extent of section loss.
9. Inspect built-up members for distortion induced by pack rust. When distortion is observed inspect the fasteners to ensure that they have not been compromised. Document the location where distortion has occurred.
10. Inspect the truss and floor system members for the problematic details provided in [Chapter 7](#) or Section 6.4.5 of the BIRM.
11. Inspect gusset plates for corrosion, section loss, out-of-plane distortion, and cracking around welds or fasteners. Document the location and type of defect observed.
17. Inspect truss and floor system members for impact damage. Document superstructure damage according to [Chapter 9 Damage Inspection](#).
18. Inspect secondary members for deterioration and cracking. Document the location and type of defect observed.
19. Inspect the connections at primary and secondary members for corrosion, cracked welds, and loose or missing fasteners. Document the condition of secondary members when connection failures or other defects are observed.

MICHIGAN STRUCTURE INSPECTION MANUAL
BRIDGE INSPECTION – ROUTINE AND CONDITION BASED IN-DEPTH INSPECTION

20. Inspect surfaces that are exposed to drainage for deterioration. Document the approximate location, type of defect, and cause of the damage.
21. Record photos of deficiencies when a change in the condition rating occurs and review the in-depth inspection procedures for suggested follow-up activities.

The evaluation of steel arch superstructure systems shall conform to the summarized conditions provided in Table 5.13.11. The MDOT Bridge Safety [NBI Rating Guidelines](#) shall be used to assign an overall code to condition of the entire area present. The condition of the bearings (if present) may also be factored into the superstructure rating; however, they may not negate deterioration or improve the component rating.

Table 5.13.11 Summarized Steel Arch Rating Guidelines

Good	Very limited partial protective coating failures that do not expose bare steel. Members retain full section properties and function as designed with limited deterioration.
Fair	Protective coating failures with minor loss of section. Cracks are arrested. All connections functioning as intended. Members continue to function as designed with moderate deterioration affecting structural members and minor section loss in low or no stress areas. Moderate impact damage that does not require mitigation.
Poor	Significant protective coating failure and limited loss of section. Cracks not arrested or missing fasteners are present. All members continue to function as designed with considerable deterioration affecting structural members and up to 10% section loss in scattered and isolated areas. Substantial impact damage may be present.
Serious	Protective coating failed with measurable loss of section. Cracks or missing fasteners may affect design capacity. Considerable deterioration affecting structural members with section loss up to 25% in scattered and isolated areas. Structural evaluation or load analysis may be necessary to determine if the structure can continue to function without restricted loading.
Critical	The superstructure will not support design loads. Posting, emergency repairs installed, or temporary shoring is required.

5.13.22 Steel Arch Michigan Bridge Element Inspection

Element level information shall be collected for steel arch structures using the Michigan Bridge Element Inspection Manual elements and condition states. Element 141 (Steel Arch) shall be used to identify defects that occur on the primary members. In addition, three ADEs have been created to collect condition state quantities for improved safety and analysis. Gusset plates that connect the main arch panels shall be evaluated and condition state quantities will be collected for each one as Element 162 (Steel Gusset Plate). Fracture critical tension members, inspected during each routine and fracture critical inspection, shall be recorded as Element 824 (Steel Truss or Steel Arch Tension Member). Portal bracing and other primary diaphragms shall be identified as Element 825 (Primary Steel Diaphragm). Elements for the floor system and any beam end deterioration observed shall also be collected as applicable.

Review Section 5.13.11 for calculating the total arch quantity. Distress observed in diagonal members is to be reported for the length of the affected panel.

**MICHIGAN STRUCTURE INSPECTION MANUAL
BRIDGE INSPECTION – ROUTINE AND CONDITION BASED IN-DEPTH INSPECTION**

A flowchart illustrating the process of determining the applicable elements for steel arch designs has been provided for clarification (see Figure 5.13.17). Quantities and condition state information for the NBEs are reported to FHWA on an annual basis. The data provided must be accurate as it will be evaluated during future quality assurance and NBIP reviews.

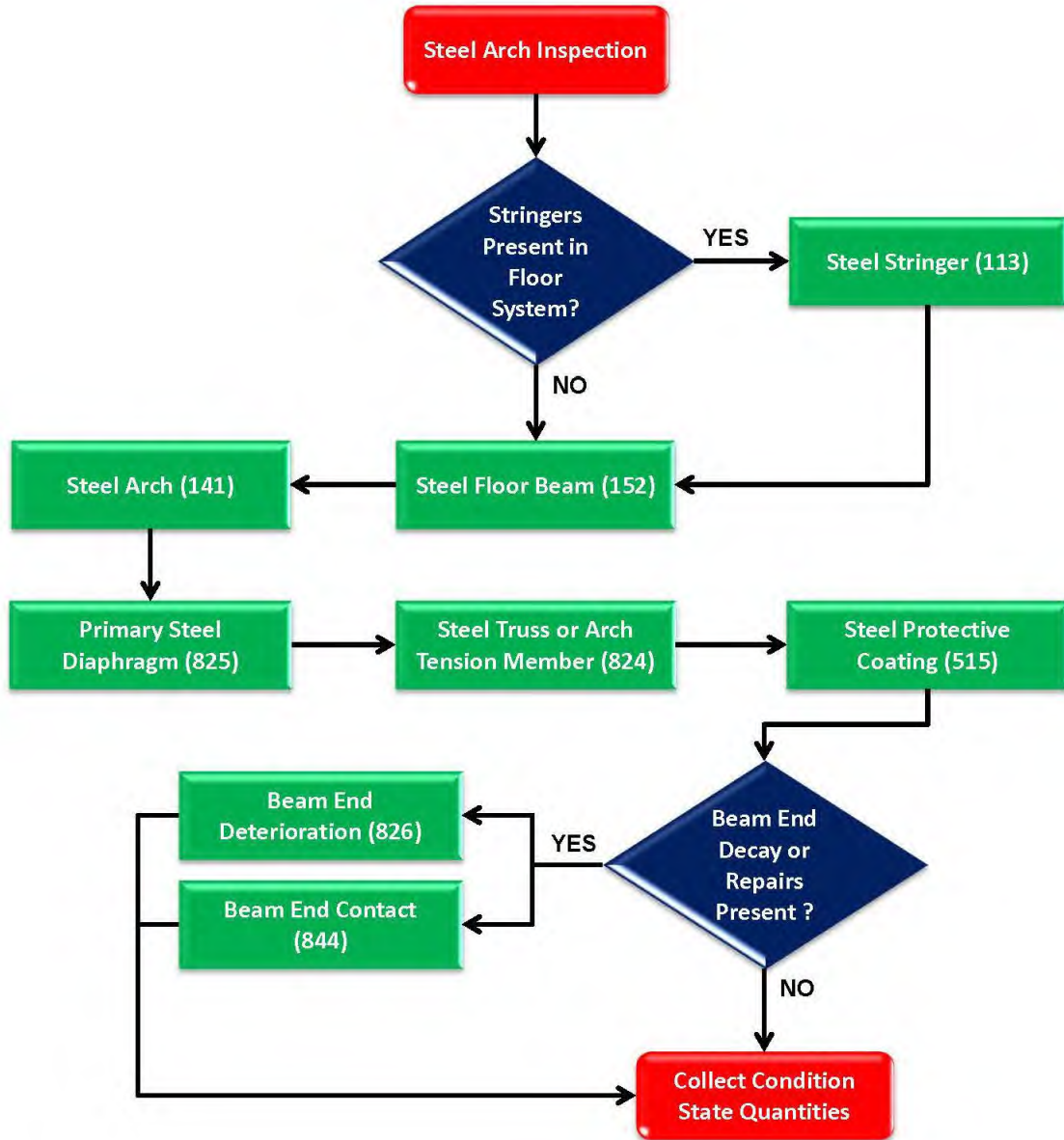

Figure 5.13.17 Steel Arch Element Collection Process

MICHIGAN STRUCTURE INSPECTION MANUAL
BRIDGE INSPECTION – ROUTINE AND CONDITION BASED IN-DEPTH INSPECTION

5.13.23 Stringer (Superstructure) Work Recommendations

The team leader should provide work recommendations for stringers when defects on the element or protective coating are identified. Several examples of recommendations that mitigate or reduce the rate of further deterioration are provided in Table 5.13.12. For example, while temporary supports may eliminate immediate structural capacity concerns, recommendations for permanent repairs or superstructure replacement should also be provided when the need for them arises.

Table 5.13.12 Work Recommendations for Various Superstructure Materials

Concrete Stringer Materials		
Recommendation	Defects	Additional Information
Temporary Supports	Section loss, reduced bearing surface greater than 25%	Recommendation for permanent repairs should also be provided (not applicable for box girders).
Crack Injection	Cracking, Damage, unsealed minor or moderate	Recommended to limit reinforcement corrosion.
Beam End Patching/Encasement	Section loss, reduced bearing surface greater than 25%	Requires review prior to implementation and consideration for repairing element that led to deterioration.
Superstructure Patching	Spalling, greater than in 6" in diameter or 1" deep	Recommended to restore section and provide adequate reinforcement coverage.
Steel Stringer Materials		
Recommendation	Defects	Additional Information
Spot Painting	Spot Rusting	Limited to isolated locations. No lead present.
Zone Painting	General Rusting, Cracking/Peeling/Curling	Limited to concentrated areas. Usually near joints or locations exposed to drainage.
Full Painting	Pinpoint Rusting, Chalking, All Others	Recommended when > 15% of the coating has failed.
Temporary Supports	Section loss, measurable and greater than 10% for steel or reduced bearing surface greater than 25% for concrete	Recommendation for permanent repairs should also be provided.
Steel Repairs	Section loss, measurable and greater than 10%	Requires review prior to implementation and consideration for repairing element that led to deterioration.
Arrest Cracking	Cracking, caused by fatigue or impact	May require immediate action.
Heat Straightening	Damage, high load impact	Evaluate each case individually.

MICHIGAN STRUCTURE INSPECTION MANUAL
BRIDGE INSPECTION – ROUTINE AND CONDITION BASED IN-DEPTH INSPECTION

Prioritize work recommendations according to the general guidelines provided below. Reference the element, location, and describe the extent of rehabilitative measures required. Submit a Request for Action (RFA) for any activity that should be completed prior to the next scheduled routine inspection.

High Priority Work Recommendations

Any structural repairs or replacement of bridge elements that should be completed within 24 to 60 months. High Priority work recommendations consist of any activity that will function to maintain safe load carrying capacity or preserve existing primary component condition ratings.

Medium Priority Work Recommendations

Any structural or non-structural repairs that should be completed within 24 to 60 months. Medium priority work recommendations serve to improve existing component and element condition ratings that are currently in fair or better condition.

Low Priority Work Recommendations

Any repairs that should be scheduled in conjunction with other planned work at the structure. Low priority work recommendations may have little to no effect on primary component condition ratings.

5.13.24 Stringer (Superstructure) Request for Action

An RFA shall be submitted to the bridge owner when immediate repairs are necessary, deterioration or damage is present that requires further evaluation, or anytime a detailed inspection is necessary to fully ascertain the condition of a superstructure element. Corrective action or repairs that do not require completion prior to the next scheduled routine inspection should be identified as a work recommendation on the BSIR. Several examples of defects or suspected deficiencies that trigger an RFA submittal for resolution and/or investigation are provided in Table 5.13.13. For other materials an RFA shall be submitted as-needed requesting the in-depth inspection, repair, or other action. The RFA shall be submitted in MiB^{RIDGE} with proper documentation and photographs so an adequate review and resolution of the process may be completed.

MICHIGAN STRUCTURE INSPECTION MANUAL
BRIDGE INSPECTION – ROUTINE AND CONDITION BASED IN-DEPTH INSPECTION

Table 5.13.13 RFA Examples for Superstructures

Request for Action	Beam/Girder Material	
	Concrete	Steel
In-depth Inspection Required	X	X
Element Quantities in Condition State 4	X	X
10% or Greater Section Loss or Buckling		X
25% or Greater Reduced Bearing Surface	X	
Exposed Prestressing Reinforcement	X	
Beam End Contact	X	X
Moderate Section Loss on Temporary Support	X	X
Structural Cracking in Primary Members	X	X
Cracking in Welded Connections		X
Required Strengthening or Reduced Inspection Frequency Resulting from Load Rating	X	X
Observed Damage Meeting Type 2 or 3 Criteria	X	X
Instable Bridge Sign Connection	X	X
Prestressed Concrete Spalling Resulting in Strand Exposure	X	

5.13.25 Stringer (Superstructure) In-Depth Inspection

In-depth inspections shall be performed as-needed and condition based recommendations are provided in Table 5.13.14. Once the Stringer (Item 59, BSIR #9) is coded 6 or less for all materials an in-depth inspection should be completed to establish a detailed record of the deterioration. Once the superstructure deteriorates and becomes poor it is suggested to complete repetitive detailed inspections at a 48 month frequency or less. Detailed inspection or documented review of superstructure elements is required for Michigan Bridge Element Inspection when any quantity, excluding protective systems (steel protective coating, concrete protective coating, etc.), is coded in Condition State 4.

Table 5.13.14 Recommended Condition Based In-Depth Inspection Guidelines for Superstructures

NBI Item 59	Schedule Initial In-depth Within	In-Depth Frequency	Applicable Superstructure Materials		
			Concrete	Steel	Timber
6	12 Months	48 Months	Concrete	Steel	Timber
≤ 4	6 Months	24 Months	Concrete	Steel	Timber

The number of lanes or amount of surface area that will be closed to traffic for examination will be dependent on the activity performed, degree of detail required, and ultimately be determined at the discretion of the bridge owner. These access requirements must be discussed in advance of a scheduled

MICHIGAN STRUCTURE INSPECTION MANUAL
BRIDGE INSPECTION – ROUTINE AND CONDITION BASED IN-DEPTH INSPECTION

in-depth inspection so adequate resources are available for an efficient, safe, and successful inspection. At a minimum, it is expected that the locations will concentrate on the areas that show the greatest degree of distress and influence the condition rating and condition state quantities.

Approval for each in-depth inspection should be documented through the submittal of an RFA to the bridge owner using MiB^{RIDGE}. When the inspection is performed immediately in response to stability or capacity concerns the inspection should be referenced on an RFA submitted after the work has been completed. These processes are necessary for confirming that the work has been completed and will be reviewed annually during QA and FHWA NBIP reviews.

Steel beams or girders require all dirt and rust scale to be removed from the surfaces where measurements with an ultrasonic thickness gauge will occur. This process may require extensive time for performing section loss measurements of beam ends located underneath leaking joints. Locations where measurements will be performed should be cleaned to a Society for Protective Coatings SSPC SP3 degree of cleanliness. Readings of the remaining thickness shall be measured on the areas where measurable section loss has occurred. During beam end inspection the readings shall be measured at the thinnest locations within 5 feet of the end of the beam at bearings, and at pin and hanger assembly locations within 2 feet.

When pin and hangers are examined, measurements shall also be taken at the pin plates. When pack rust between riveted pin plates interferes or prevents an accurate reading on the D-Gauge from being obtained, the bridge owner shall be notified. The pins should be examined to determine if they meet current requirements and are properly operating. The distance between pins should be recorded when excessive wear is suspected and for non-redundant designs. The fatigue life of the pin and hanger assembly should be reviewed and evaluated.

Welds in the tension zones that are transverse to the stress and other fatigue prone details must be inspected for fatigue cracking. Review the AASHTO Fatigue Categories in Chapter 6 of the BIRM prior to the evaluation. When cracking is suspected the area shall be cleaned and tested with dye penetrant.

The entire length of steel beams shall be inspected for buckling and distortion. For distortion that occurred as a result of a high load impact perform the inspection and documentation requirements in [Chapter 9, Damage Inspection](#).

Concrete beams shall be inspected for cracking, delamination, spalling, and reinforcement section loss. Areas of distress shall be sounded to determine the limits of deficient material. Spalls, delamination, cracks, and other defects shall be measured from a known reference point on the plans. Exposed corroded reinforcing steel shall be cleaned with a hand scraper or brush prior to measuring the remaining section. Excessive deflection or structural cracking may require load testing or installation of specialized monitor devices. Beam ends with section loss shall be measured to determine the amount of reduced bearing area.

During the in-depth inspection of superstructure steel, concrete, or other materials any other primary and secondary must also be inspected. The condition and connections of cross frames, stiffeners,

MICHIGAN STRUCTURE INSPECTION MANUAL
BRIDGE INSPECTION – ROUTINE AND CONDITION BASED IN-DEPTH INSPECTION

intermediate diaphragms, end diaphragms, bracing, and the bearings must also be documented when they influence the stringer rating.

During in-depth inspections of concrete or steel girders where section loss or reduced bearing area may result in the need for temporary supports then additional measurements should be recorded (see Figure 5.13.18). This will help to reduce the number of field visits should the bridge owner or engineer determine that supports must be installed. Dimensions should be rounded to the nearest 1/8 inch.

When other Nondestructive Methods are required for proper assessment then Chapter 15 of the BIRM shall be reviewed for additional information.

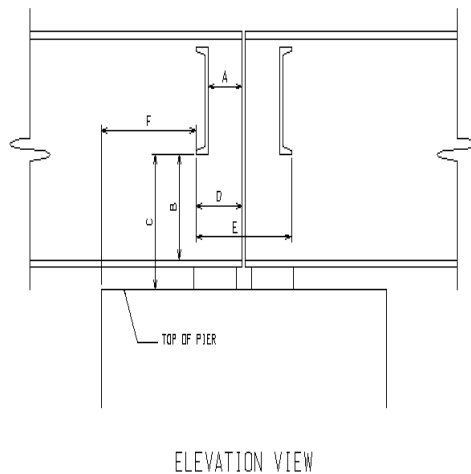

Figure 5.13.18 Measurements Required for Temporary Support Installation

Document the stringer section loss inspection findings by preparing a table of the original thickness, measured thickness, and percentage of loss. MDOT Forms [0267](#), [0267-1](#), and [0267-2](#) may be used for detailed beam end surveys. Provide sketches of major components and deterioration that are of relative proportion. When corrective action is necessary, mark the locations on the plan of the superstructure showing the areas requiring repairs.

5.14 Paint (BSIR #10, SI&A Item 59A)

The proper condition rating of steel coating systems is vital in determining when action is necessary to preserve the condition of the underlying material. The Society for Protective Coatings (SSPC-VIS 2) classifies rusting according to three main types of distribution in order to properly evaluate the visible condition of the surface. Identification of the type of corrosion distribution allows for accurate condition rating and improved decisions during bridge scoping activities. The evaluation of the protective system should not only focus on the amount of corrosion that is present during an inspection, but also include the degradation factors of cracking, peeling, curling, and chalking. In general terms, the categories and their descriptive features are provided in Table 5.14.01.

MICHIGAN STRUCTURE INSPECTION MANUAL
BRIDGE INSPECTION – ROUTINE AND CONDITION BASED IN-DEPTH INSPECTION

Table 5.14.01 Coating Corrosion and Degradation Categories

	Category	Description	Reference Figure
Corrosion	Spot Rusting	Limited corrosion occurring to a small number of specific areas	5.14.01
	General Rusting	Intermittent corrosion occurring throughout the majority of surface areas	5.14.02
	Pinpoint Rusting	Widespread freckled corrosion occurring throughout the majority of surface areas	5.14.03
Degradation	Cracking/Peeling/Curling	Usually occurs from improper surface preparation, poor environmental conditions during application, or excessive film thickness.	5.14.04
	Chalking	Caused by ultraviolet light breakdown of the top coat which leads to a dull or white powdery surface	5.14.05

5.14.01 Paint Routine NBI Inspection

The categories and factors described enable efficient bridge maintenance and rehabilitative actions to be prioritized and scheduled. For example, beams with visible spot rusting or general rusting that occurs near the ends without other corrosion present may only warrant spot or zone painting. While in cases where chalking, general, or pinpoint rusting occur throughout require the entire surface to be cleaned and coated. The team leader shall perform the procedures listed for the routine inspection, and review Chapter 6 of the BIRM for additional considerations during the inspection.

1. Review plans and/or previous construction records to verify that SI&A item 78, Paint Type, is coded correctly
2. Inspect the primary member surfaces located within 5 feet of bearings or joints for protective coating failures. Document the approximate location, estimated area, and the type of degradation or corrosion observed.
3. Inspect the outside surface of fascia beams, excluding the beam ends, for protective coating failures. Document the approximate location, estimated area, and the type of degradation or corrosion.
4. Inspect the remaining surfaces of primary and secondary members for protective coating failures. Document the approximate location, estimated area, and the type of degradation or corrosion.
5. Review each of the zones for the amount of coating failure. If the conditions are not consistent throughout document the variation in the comment field of the BSIR.
6. Record photos of deficiencies when a change in the condition rating occurs and review the in-depth inspection procedures for suggested follow-up activities.

MICHIGAN STRUCTURE INSPECTION MANUAL
BRIDGE INSPECTION – ROUTINE AND CONDITION BASED IN-DEPTH INSPECTION

The evaluation of the paint system shall conform to the summarized conditions provided in Table 5.14.02. The MDOT Bridge Safety [NBI Rating Guidelines](#) shall be used to assign an overall code to condition of the entire area present. The condition of the coating system may influence the rating of Item 59 (Superstructure). The team leader must note the type of coating system including uncoated A-588 or galvanizing, and the year that the protective system was applied.

Table 5.14.02 Summarized Paint Protective System Rating Guidelines

Good	Minor pinpoint rusting in scattered locations or on sharp edges.
Fair	Moderate corrosion or degradation of the coating limited to 1% and 5% of the total surface area. If areas of paint failure are concentrated under open joints, consideration may be given to zone painting.
Poor	Large areas of corrosion or degradation of the coating occurring to 5% and 15% of the total surface area. If areas of paint failure are concentrated under open joints, consideration may be given to zone painting. Otherwise, schedule for complete repainting when coating failure has progressed beyond 15%.
Serious	Significant areas of corrosion or degradation of the coating comprising between 15% and 50% of the total surface area. Structure should be scheduled for complete recoating.
Critical	More than 50% of the coating has failed. Structure should be scheduled for complete recoating.

MICHIGAN STRUCTURE INSPECTION MANUAL
BRIDGE INSPECTION – ROUTINE AND CONDITION BASED IN-DEPTH INSPECTION



Figure 5.14.01 Spot Rusting



Figure 5.14.02 General Rusting

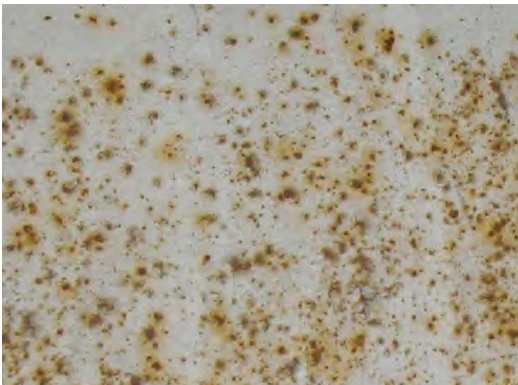

Figure 5.14.03 Pinpoint Rusting (Magnified)



Figure 5.14.04 Cracking/Peeling/Curling



Figure 5.14.05 Chalking

MICHIGAN STRUCTURE INSPECTION MANUAL
BRIDGE INSPECTION – ROUTINE AND CONDITION BASED IN-DEPTH INSPECTION

5.14.02 Paint Michigan Bridge Element Inspection

Element level information shall be collected for the protective coating systems present on each type of bridge element present using the Michigan Bridge Element Inspection Manual elements and condition states. Element 515 (Steel Protective Coating) shall be used for paint coating systems, oxide films, and other surfaces coated with galvanizing. This element not only applies to superstructures composed of steel but also to railings, bearings, and any other steel materials. Element 521 (Concrete Protective Coating) must be collected for all concrete surfaces that have been treated with a coating or sealer to inhibit the intrusion of moisture and chlorides. Examples of common concrete elements that may have coating system in-place include concrete railings, fascia, piers, and abutments. However, Element 850 (Healer Sealer) has been developed specifically for penetrating sealers that have been applied to deck surfaces. When a healer sealer has been applied to the deck then the team leader should use Element 850 in lieu of Element 521. When healer sealer is applied to other horizontal surfaces such as pier caps Element 521 shall be used. The primary cause of distinguishing healer sealers from other protective materials is for planning reapplications as reduced effectiveness is expected within 6 to 10 years. A flowchart illustrating the process is shown in Figure 5.14.06.

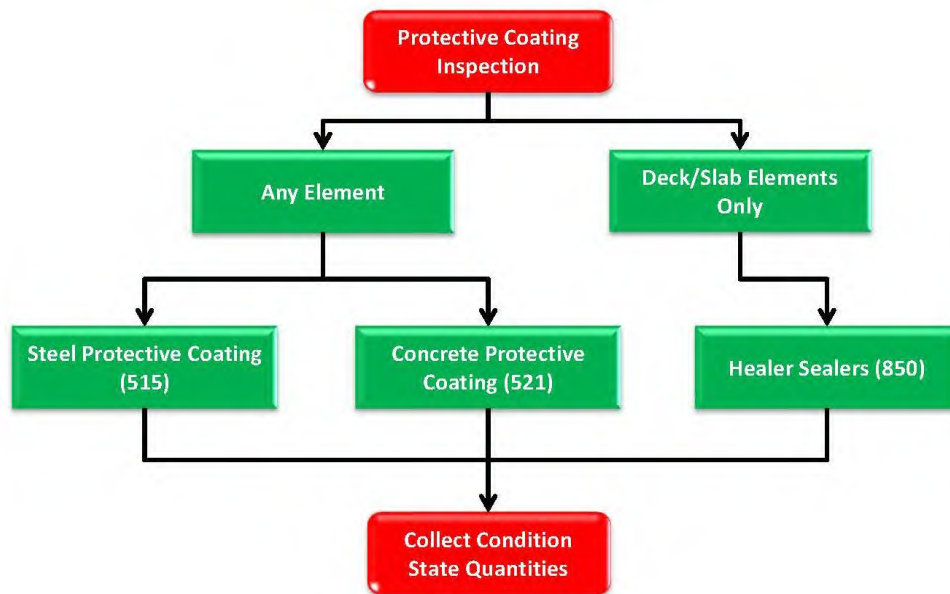

Figure 5.14.06 Protective Coating Element Collection Process

5.14.03 Paint Work Recommendations

The team leader should provide work recommendations for failing coating systems on structural steel. Several examples of recommendations that work to reduce the rate of deterioration or improve condition are provided in Table 5.14.03. At locations without lead and isolated locations of minor rusting spot cleaning and coating may be performed. This work enables reduction in the amount of labor and material costs that are associated with the normal setup and control of the material as spent materials are

MICHIGAN STRUCTURE INSPECTION MANUAL
BRIDGE INSPECTION – ROUTINE AND CONDITION BASED IN-DEPTH INSPECTION

collected with a vacuum type device. Where moderate corrosion or degradation of the coating is concentrated under open joints, and the remaining surfaces are free of defects, zone painting should be recommended to eliminate further corrosion and section loss. Full painting is often only necessary when greater than 15% of the total coating surface area has been compromised.

Table 5.14.03 Work Recommendations for Bridge Cleaning and Coating

Structural Steel Painting			
Recommendation	Defects	Item 59 Rating	Additional Information
Spot Painting	Spot Rusting	≥ 6	Limited to isolated locations. No lead present.
Zone Painting	General Rusting, Cracking/Peeling/Curling	≥ 4	Limited to concentrated areas. Usually near joints or locations exposed to drainage.
Full Painting	Pinpoint Rusting, Chalking, All Others	≥ 3	Recommended when > 15% of the coating has failed.

Prioritize work recommendations according to the general guidelines provided below. Reference the element, location, and describe the extent of rehabilitative measures required. Submit a Request for Action (RFA) for any activity that should be completed prior to the next scheduled routine inspection.

High Priority Work Recommendations

Any structural repairs or replacement of bridge elements that should be completed within 24 to 60 months. High Priority work recommendations consist of any activity that will function to maintain safe load carrying capacity or preserve existing primary component condition ratings.

Medium Priority Work Recommendations

Any structural or non-structural repairs that should be completed within 24 to 60 months. Medium priority work recommendations serve to improve existing component and element condition ratings that are currently in fair or better condition.

Low Priority Work Recommendations

Any repairs that should be scheduled in conjunction with other planned work at the structure. Low priority work recommendations may have little to no effect on primary component condition ratings.

5.14.04 Paint Request for Action

The reason for submitting a request for action may be due to section loss in areas where protective coatings have failed and the structural capacity of an element is compromised. However, RFAs should not be submitted solely because of paint failure. Review Sections 5.13 and 5.15 when corrosion is identified to determine whether additional actions are necessary.

MICHIGAN STRUCTURE INSPECTION MANUAL
BRIDGE INSPECTION – ROUTINE AND CONDITION BASED IN-DEPTH INSPECTION

5.14.05 In-Depth Inspection

In-depth inspections of paint coatings on structural steel are recommended to be performed prior to the expiration of the guarantee period for projects with warranty provisions and during the construction phase for all others. Coated surfaces should be inspected at arms-length for corrosion and degradation and it is recommended to follow the guidance in SSPC-VIS 2, Standard Method of Evaluating Degree of Rusting on Painted Steel Surfaces. When the inspection occurs prior to, or concurrent with the initial inspection (post-construction), comments shall be provided for Paint (BSIR #10) regarding the areas examined, deficiencies found, and confirmation that the construction engineer was notified.

5.15 Section Loss Under Joints (BSIR #11)

Since funding is limited for both MDOT and local agency bridge rehabilitation projects, locations that are prone to expedited corrosion through annual exposure of precipitation and deicing chemicals require additional attention. Section loss caused by leaking joints is the second most common cause of temporary support installations on MDOT owned bridges. While routine inspection activities have been able to identify buckling prior to span failure, a balanced approach of in-depth inspection should be performed to mitigate the need for temporary measures. Failing to complete these hands-on inspections may lead to unobservable section loss that increase the probability for substantial capacity reductions, emergency repairs, or bridge closure.



Figure 5.15.01 Identification of Beam End Corrosion Requires In-Depth Inspection

5.15.01 Section Loss Under Joints Routine NBI Inspection

Although common occurrences of section loss under joints are related to steel superstructures, the routine and in-depth inspection procedures apply to concrete superstructures as well (see Figure 5.15.01). This work will aid in the reduction of rehabilitative costs as less costly maintenance practices may be

MICHIGAN STRUCTURE INSPECTION MANUAL
BRIDGE INSPECTION – ROUTINE AND CONDITION BASED IN-DEPTH INSPECTION

applied to reduce the rate of deterioration. The team leader shall perform the procedures listed for the routine inspection, and review Chapters 8, 9, and 10 of the BIRM for additional considerations during the inspection.

1. Inspect steel beam ends for evidence of corrosion and section loss. Document the location, observed defect, and request an in-depth inspection for initial ratings of 2 or less.
2. Inspect concrete beam ends for structural cracking, exposed reinforcement, scaling, spalling, and section loss. Document the location, observed defect, and request an in-depth inspection for initial ratings of 2 or less.
3. Record photos of deficiencies when a change in the condition rating occurs and review the in-depth inspection procedures for suggested follow-up activities.

The evaluation of section loss occurring at the beam end shall conform to the summarized conditions provided in Table 5.15.01. The MDOT Bridge Safety [NBI Rating Guidelines](#) shall be used to assign an overall code to condition of the entire area present. The condition and observations should influence the rating of Item 59 (Stringer). This item for bridges with timber superstructures, slabs, and culverts shall be coded N.

Table 5.15.01 Summarized Section Loss Under Joints Rating Guidelines

GOOD	<p>Steel: No loss of paint protection, corrosion, or evidence of section loss due to corrosion.</p> <p>Concrete: Superficial surface scaling without reinforcement exposure or reduced bearing.</p>
FAIR	<p>Steel: Rusty beam ends or section loss less than 10%.</p> <p>Concrete: Distress limited to non-structural cracking or spalling without exposed reinforcement.</p>
POOR	<p>Steel: 10% or greater section loss that does not require repair or action due to load capacity analysis or structural review.</p> <p>Concrete: Cracking, exposed reinforcement, or bearing surface reduction that does not require action due to load analysis or structural review.</p>
FAILED	<p>All: Excessive deterioration requiring engineered repairs or temporary supports.</p>

5.15.02 Section Loss Under Joints Michigan Bridge Element Inspection

Element level information shall be collected for beam end deterioration using the Michigan Bridge Element Inspection Manual elements and condition states. Four elements have been created specifically to identify beam end deterioration or temporary repairs for improved management and decision making. These elements should only be added when conditions warrant, and quantities in condition state 3 or 4 require an RFA to be submitted requesting in-depth inspection.

MICHIGAN STRUCTURE INSPECTION MANUAL
BRIDGE INSPECTION – ROUTINE AND CONDITION BASED IN-DEPTH INSPECTION

Element 826 (Beam End Deterioration) may only be added when deterioration is present within 5 feet of the beam end, or when permanent repairs have been implemented to resolve the deficiency. Beam ends with bolted repairs shall be coded in condition state 1. For beam ends without bolted repairs, once corrosion is observed a hands-on inspection should be performed to document the extent of section loss. The results of this inspection will determine the applicable condition state and actions that must be taken.

Element 844 (Beam End Contact) shall be added any time the beam ends have been cut to provide adequate distance for thermal expansion, or in all cases where the beam ends are in contact with one another. When steel beam ends are in contact a hands-on inspection is recommended as the distress is usually not visible from the grade beneath the structure.

Element 845 (Short Height Temporary Support) and Element 846 (Full Height Temporary Support) shall be added to identify the beam ends that are being supported. In most cases two short height temporary supports are required to for adequate support of one beam end. The quantity identified on the element report should reflect the number of beam ends supported and not the number in-place. When section loss or other beam end deterioration was the primary contributor of the support installation Element 826 shall also be used. This will allow for an easy distinction to be garnered regarding the root cause of the support installation and whether beam end deterioration or substructure defects were the controlling reason.

A flowchart illustrating the process of determining the applicable elements for section loss has been provided for clarification (see Figure 5.15.02). Quantities and condition state information for these elements are vital as they will help to prioritize requests for special needs funding and repair. The data provided must be accurate as it will be evaluated during future quality assurance reviews.

MICHIGAN STRUCTURE INSPECTION MANUAL
BRIDGE INSPECTION – ROUTINE AND CONDITION BASED IN-DEPTH INSPECTION

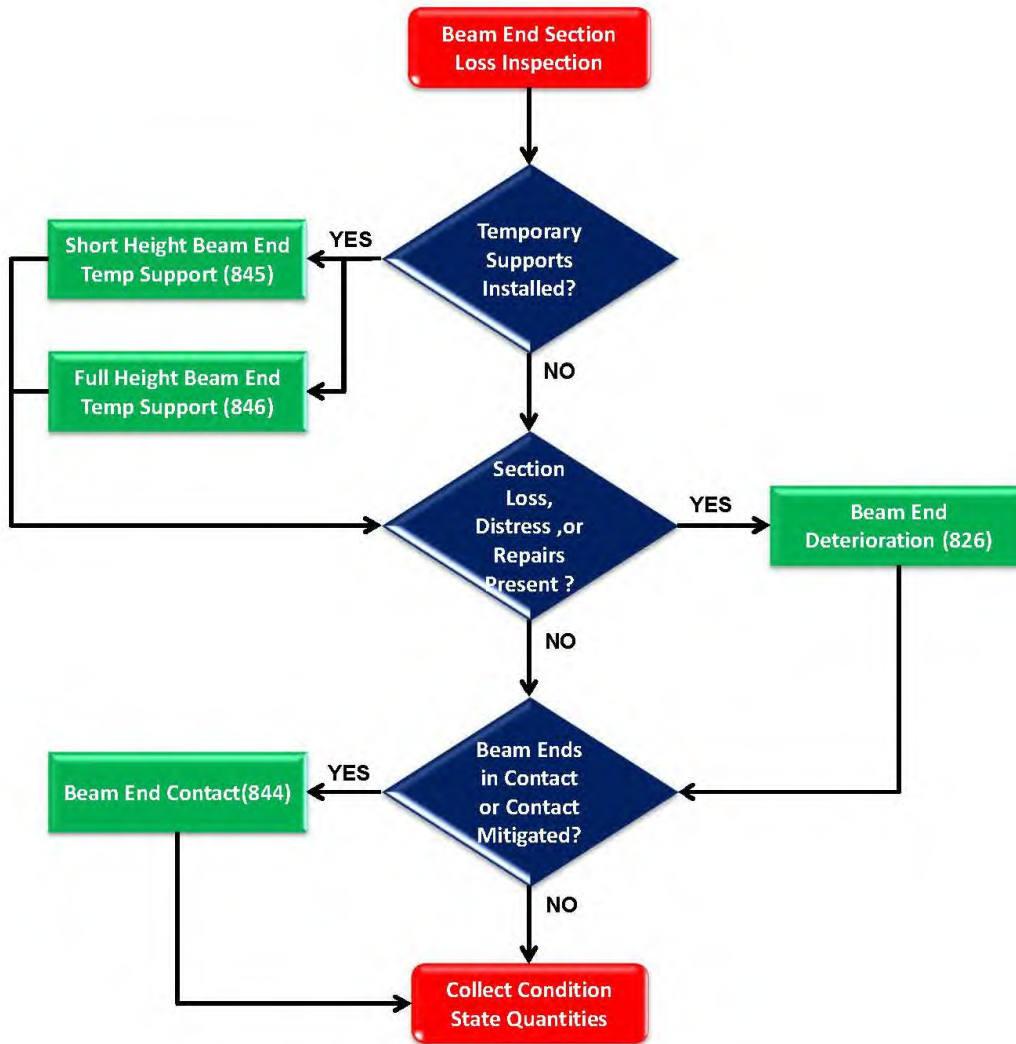

Figure 5.15.02 Elements Related to Section Loss Collection Process

5.15.03 Section Loss Under Joint Work Recommendations

The team leader should provide work recommendations to preserve the condition of beam ends whenever deterioration is imminent, suspected, or observed. This should not only include measures that prevent substantial capacity reductions from occurring, but also include activities that delay further deterioration of the elements. The team leader may provide both temporary and permanent options on the report as limitations may prevent long-lasting remedial actions from happening immediately. Several examples of recommendations that work to reduce the rate of deterioration or improve condition are provided in Table 5.15.02.

MICHIGAN STRUCTURE INSPECTION MANUAL
BRIDGE INSPECTION – ROUTINE AND CONDITION BASED IN-DEPTH INSPECTION

Table 5.15.02 Work Recommendations for Section Loss Under Joints

Section Loss Under Joints		
Recommendation	Defects	Additional Information
Reseal Joints	Leakage, pourable joints loss of adhesion	Effectiveness dependent on preparation and cycles.
Gland Replacement	Leakage, caused by punctured or ripped gland	Reduces cost when full replacement is unnecessary.
Joint Replacement	Leakage, Multiple others, joint performance is compromised	Generally effective for more than 20 years.
Temporary Supports	Section loss, measurable and greater than 10% for steel or reduced bearing surface greater than 25% for concrete	Recommendation for permanent repair should be provided.
Steel Beam End Repairs	Section loss, measurable and greater than 10%	Requires review prior to implementation and consideration for repairing element that led to deterioration.
Beam End Patching/Encasement	Section loss, reduced bearing surface greater than 25%	Requires review prior to implementation and consideration for repairing element that led to deterioration.

Prioritize work recommendations according to the general guidelines provided below. Reference the element, location, and describe the extent of rehabilitative measures required. Submit a Request for Action (RFA) for any activity that should be completed prior to the next scheduled routine inspection.

High Priority Work Recommendations

Any structural repairs or replacement of bridge elements that should be completed within 24 to 60 months. High Priority work recommendations consist of any activity that will function to maintain safe load carrying capacity or preserve existing primary component condition ratings.

Medium Priority Work Recommendations

Any structural or non-structural repairs that should be completed within 24 to 60 months. Medium priority work recommendations serve to improve existing component and element condition ratings that are currently in fair or better condition.

Low Priority Work Recommendations

Any repairs that should be scheduled in conjunction with other planned work at the structure. Low priority work recommendations may have little to no effect on primary component condition ratings.

MICHIGAN STRUCTURE INSPECTION MANUAL
BRIDGE INSPECTION – ROUTINE AND CONDITION BASED IN-DEPTH INSPECTION

5.15.04 Section Loss Under Joints Request for Action

An RFA should be submitted when the condition of the beam end may require a reduced load capacity posting, if a detailed inspection is required, or whenever an action should be completed prior to the next scheduled inspection. The RFA shall be submitted in MiB^{RIDGE} with proper documentation and photographs so an adequate review and resolution of the process may be completed. Examples of defects that trigger an RFA submittal for resolution and/or investigation of concrete and steel beam ends are provided in Table 5.15.03. For other materials an RFA shall be submitted as-needed requesting the in-depth inspection.

Table 5.15.03 RFA Examples for Section Loss Under Joints

Request for Action	Beam/Girder Material	
	Concrete	Steel
In-depth Inspection Required	X	X
Element Quantities in Condition State 4	X	X
10% or Greater Section Loss		X
25% or Greater Reduced Bearing Surface	X	
Exposed Prestressing Reinforcement	X	
Beam End Contact	X	X
Moderate Section Loss on Temporary Support	X	X

5.15.05 Section Loss Under Joints In-Depth Inspection

In-depth inspection of beam ends shall be performed as-needed and condition based requirements are provided in Table 5.15.04. A hands-on inspection is recommended once the condition rating code for Section Loss (BSIR #11) is 2 or less, and **must be performed when the extent of deterioration cannot be identified during the routine inspection**. This work is necessary for the safety of the motoring public and for proper planning of repairs. It is also being implemented because the point of origin for beam end deterioration is usually not visible from locations at which routine inspections are conducted. Usually once measurable section loss is identified on visible portions of the web severe deterioration has already occurred near the web to flange interface. Detailed inspection or documented review for beam end elements is required for Michigan Bridge Element Inspection when any quantity, excluding protective systems (galvanizing, concrete surface coating, etc.), is coded in condition state 4.

Table 5.15.04 Mandatory Condition Based In-Depth Inspection Requirements for Section Loss

Section Loss Under Joints Rating	Schedule Initial In-depth Within	In-Depth Frequency	Applicable Stringer Materials	
2	12 Months	48 Months	Concrete	Steel
≤ 1	6 Months	24 Months	Concrete	Steel

MICHIGAN STRUCTURE INSPECTION MANUAL
BRIDGE INSPECTION – ROUTINE AND CONDITION BASED IN-DEPTH INSPECTION

Approval for each in-depth inspection should be documented through the submittal of an RFA to the bridge owner using MiB^{RIDGE}. When the inspection is performed immediately in response to public safety concerns the inspection should be referenced on an RFA submitted after the work has been completed. These processes are necessary for confirming that the work has been completed and will be reviewed annually during QA and FHWA NBIP reviews. MDOT will also perform quarterly monitoring

Review Section 5.13.23 for the procedures and documentation of beam end inspection.

5.16 Bearings (BSIR #12)

The accurate condition rating of bearings is essential as restricted movement causes internal stresses that may result in extensive damage or instability. Bearings serve to transfer loads from the superstructure to the substructure, and also permit rotation, expansion, and contraction of the superstructure. Bearings are commonly divided into two categories; fixed and movable which denote the portions of the span where the devices permit or restrict horizontal translation. Although fixed bearings restrict thermal movement rotation may occur at these locations.

5.16.01 Bearings Routine NBI Inspection

The evaluation of the bearing should account for deterioration of the bearing and include the sole plate, masonry plate, anchor bolts, and supporting materials (see Figure 5.16.01). The team leader shall perform the procedures listed for the routine inspection, and review Chapter 11 of the BIRM for additional considerations during the inspection.

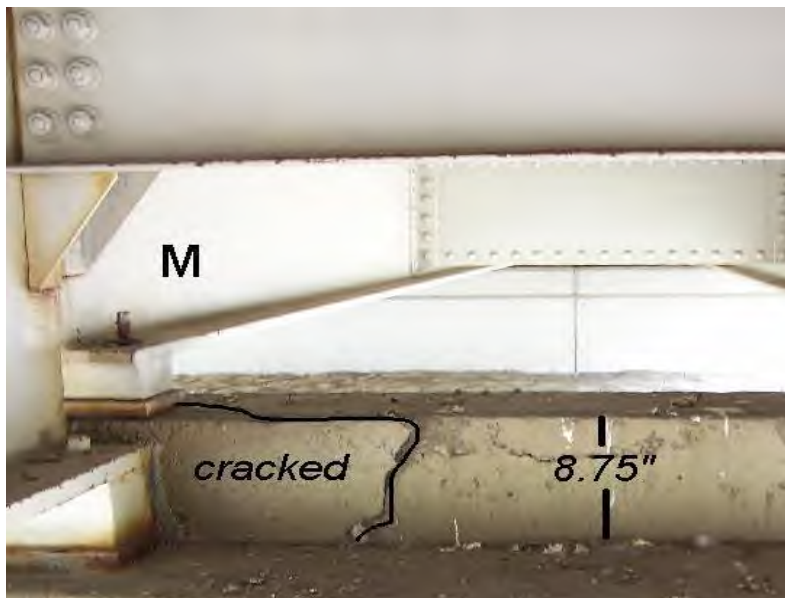

Figure 5.16.01 Cracked Bolster Prompts Planning for Temporary Supports

1. Inspect the bearings for proper alignment while accounting for the current ambient temperature at the time of inspection. Document the location of bearings that are not in proper position.

MICHIGAN STRUCTURE INSPECTION MANUAL
BRIDGE INSPECTION – ROUTINE AND CONDITION BASED IN-DEPTH INSPECTION

2. Inspect bearings for restricted movement. Document locations where corrosion or other defects may inhibit adequate expansion of the superstructure.
3. Inspect the bearings for proper contact area amongst the individual elements. The sole plate, bearing, and masonry plate should be in full contact with one another. Document locations where the sole plate is not resting on the bearing or load distribution is not transferred through the entire system.
4. Inspect steel bearings for cracking and corrosion. Document the location where protective coating failure and/or section loss has occurred, approximate area and degree affected, and any other observed signs of distress.
5. Inspect elastomeric bearings for bulging. Document the location and approximate percent that bulging is occurring in comparison to the overall thickness.
6. Inspect the underlying substructure materials for defects to ensure that the bearing is resting on a sustainable support. Document any structural cracks, delamination, spalling, or other deterioration that may compromise load distribution to the substructure supporting element.
7. Record photos of deficiencies when a change in the condition rating occurs and review the in-depth inspection procedures for suggested follow-up activities.

The evaluation of section loss occurring at the beam end shall conform to the summarized conditions provided in Table 5.16.01. The MDOT Bridge Safety [NBI Rating Guidelines](#) shall be used to assign an overall code to condition of the entire area present. The condition and observations should influence the rating of Item 59 (Superstructure). This item for bridges with timber superstructures, slabs, and culverts shall be coded N.

Table 5.16.01 Summarized Bearing Rating Guidelines

Good	Minor coating failures in scattered locations on steel bearing components. All bearing components function as designed.
Fair	Moderate deterioration affecting bearing components. Minor misalignment, section loss, or loss of bearing in low or no stress areas.
Poor	Considerable deterioration affecting bearing components with section loss up to 10% in scattered and isolated areas, misalignment, and/or loss of bearing. All members continue to function as designed.
Serious	Considerable deterioration affecting bearing components with section loss up to 25% in scattered and isolated areas. Structural and/or load analysis may be necessary to determine if the structure can continue to function without restricted loading.
Critical	Deterioration has progressed to the point where the structure will not support design loads and must be posted for reduced loads.

MICHIGAN STRUCTURE INSPECTION MANUAL
BRIDGE INSPECTION – ROUTINE AND CONDITION BASED IN-DEPTH INSPECTION

5.16.02 Bearing Michigan Bridge Element Inspection

Element level information shall be collected for all bearings using the Michigan Bridge Element Inspection Manual elements and condition states. Element 310 (Elastomeric Bearing) shall be used for all bearings where elastomer is the primary material whether or not reinforcement is present (see Figure 5.16.02). These include plain or laminated bearings with steel reinforcing plates that allow expansion.



Figure 5.16.02 Elastomeric Bearing

Roller, rocker, or sliding steel bearings where the surfaces are visible for inspection are identified as Element 311 (Moveable Bearing). There may be multiple rollers, rockers, or various types of surfaces with some consisting of bronze, lubricated steel, or lead to aid movement (see Figure 5.16.03).



Figure 5.16.03 Movable Bearing

MICHIGAN STRUCTURE INSPECTION MANUAL
BRIDGE INSPECTION – ROUTINE AND CONDITION BASED IN-DEPTH INSPECTION

Bearings which are not visible for inspection, even at a hands-on distance, are identified as Element 312 (Enclosed/Concealed Bearing). The rating should be contingent on visible factors that are reliant on proper performance. Enclosed bearings may often be noticed during inspection of box girders at dependent backwall abutments (see Figure 5.16.04).



Figure 5.16.04 Enclosed/Concealed Bearing

Element 313 (Fixed Bearing) must be used for bearing devices which permit rotation but do not allow horizontal translation (see Figure 5.16.05). Generally, the masonry plate and bearing device are fastened to one another and a pin or convex form in the sole plate accommodates rotation under live load.



Figure 5.16.05 Fixed Bearing

Element 314 (Pot Bearing) defines systems which utilize a steel ring to contain neoprene (see Figure 5.16.06). The elastomer allows rotation while those fabricated to allow translation are fitted with a stainless steel plate that bears on a synthetic disk. Guide bars may be attached to the sole plate to restrict thermal movement or constrain it to a single direction. Similar to pot bearing devices, Element 351 (Disc Bearing) instead incorporates a dense plastic in lieu of elastomer that compresses to permit rotation (see Figure 5.16.07). The use of synthetic disks to provide translation and guide bars is similar to pot bearings.

MICHIGAN STRUCTURE INSPECTION MANUAL
BRIDGE INSPECTION – ROUTINE AND CONDITION BASED IN-DEPTH INSPECTION



Figure 5.16.06 Pot Bearing



Figure 5.16.07 Disk Bearing

Element 316 (Other Bearing) shall be used for bearings that may not be categorized according to any of the previously described types (see Figure 5.16.08). These are limited to obsolete devices that are usually associated with structures constructed decades ago. Condition state quantities for Element 515 (Steel Protective Coating) shall be collected for all painted steel bearings. All of the bearing elements are BMEs that have been created by AASHTO. Quantities and condition state information are reported directly to FHWA on an annual basis. The data provided must be accurate as it will be evaluated during future quality assurance and NBIP reviews.



Figure 5.16.08 Other Bearing

5.16.03 Bearing Work Recommendations

The team leader should provide work recommendations to preserve the functional condition of the bearings so adequate rotation, translation, and distribution of loads from the superstructure to the substructure is maintained. Several examples of recommendations that work to eliminate the need for bearing replacement when they are in fair or good condition are provided in Table 5.16.02.

MICHIGAN STRUCTURE INSPECTION MANUAL
BRIDGE INSPECTION – ROUTINE AND CONDITION BASED IN-DEPTH INSPECTION

Table 5.16.02 Work Recommendations for Bearings

Bearings (Item 59C ≥ 5)		
Debris Removal	Corrosion, Section Loss	Removing sediment and debris will reduce opportunities for prolonged trapped moisture.
Shim	Loss of contact between masonry plate or sole plate and bearing device	Separation due to pack rust or improper design/construction.
Clean and Coat	Protective Coating Failure, Corrosion, or Section Loss	Limited to steel bearings and joint leakage (if applicable) should be addressed to reduce deterioration rate.
Realign	Alignment, lateral or vertical that is inconsistent with temperature conditions	Prevents further misalignment that may lead to bearing failure.
Lubricate	Restricted Movement	Minor restrictions may be eliminated with proper cleaning and lubrication of the sliding surfaces.

Prioritize work recommendations according to the general guidelines provided below. Reference the element, location, and describe the extent of rehabilitative measures required. Submit a Request for Action (RFA) for any activity that should be completed prior to the next scheduled routine inspection.

High Priority Work Recommendations

Any structural repairs or replacement of bridge elements that should be completed within 24 to 60 months. High Priority work recommendations consist of any activity that will function to maintain safe load carrying capacity or preserve existing primary component condition ratings.

Medium Priority Work Recommendations

Any structural or non-structural repairs that should be completed within 24 to 60 months. Medium priority work recommendations serve to improve existing component and element condition ratings that are currently in fair or better condition.

Low Priority Work Recommendations

Any repairs that should be scheduled in conjunction with other planned work at the structure. Low priority work recommendations may have little to no effect on primary component condition ratings.

MICHIGAN STRUCTURE INSPECTION MANUAL
BRIDGE INSPECTION – ROUTINE AND CONDITION BASED IN-DEPTH INSPECTION

5.16.04 Bearing Request for Action

An RFA shall be submitted to the bridge owner when the bearings no longer function as designed, deterioration is extensive, or when a detailed inspection is required. Corrective actions that do not require completion prior to the next scheduled routine inspection should be identified as a work recommendation on the BSIR. Several examples of defects or suspected deficiencies that trigger an RFA submittal for resolution and/or investigation concerning bearings are provided in Table 5.16.03. For other materials an RFA shall be submitted as-needed requesting the in-depth inspection. The RFA shall be submitted in MiB^{RIDGE} with proper documentation and photographs so an adequate review and resolution of the process may be completed.

Table 5.16.03 Bearing Defects Initiating a Request for Action

Request for Action	Bearing Material	
	Elastomeric	Steel
In-depth Inspection Required	X	X
Element Quantities in Condition State 4	X	X
25% or Greater Reduced Bearing Surface	X	X
Excessive Bulging, Splitting, or Tearing	X	
10% or Greater Section Loss		X
Restricted Movement		X
Moderate Lateral or Vertical Misalignment		X

5.16.05 Bearing In-Depth Inspection

In-depth inspections of bearings shall be performed as-needed, especially when the bridge shows signs of distress due to inadequately functioning bearings, and condition based recommendations are provided in Table 5.16.04. Since improper function or loss of bearing may cause structural damage it is strongly recommended to perform a hands-on inspection when the condition of the Bearings (BSIR #12) is coded 5 or less because of movable bearing condition, and 4 or less for all types. Detailed inspection or documented review of bearings is required for Michigan Bridge Element Inspection when any quantity, excluding protective systems (galvanizing, steel coating, etc.) is coded in Condition State 4 (see Figure 5.16.08)

Table 5.16.04 Recommended Condition Based In-Depth Inspection Guideline for Bearings

NBI Rating	Schedule Initial In-depth Within	In-Depth Frequency	Bearing Type	
5	24 Months	As-Needed	Movable	
4	12 Months	48 Months	Movable	Fixed
3	6 Months	36 Months	Movable	Fixed

MICHIGAN STRUCTURE INSPECTION MANUAL
BRIDGE INSPECTION – ROUTINE AND CONDITION BASED IN-DEPTH INSPECTION

When a lane closure is necessary to perform the inspection because of safety concerns, in lieu of only closing the shoulder, the bridge owner will be notified prior to performing the work. At a minimum, it is expected that the locations where materials have been coded in Condition State 4, and other areas that display the greatest degree of distress will be inspected.

Approval for each in-depth inspection should be documented through the submittal of an RFA to the bridge owner using MiB^{RIDGE}. When the inspection is performed immediately in response to public safety concerns the inspection should be referenced on an RFA submitted after the work has been completed. These processes are necessary for confirming that the work has been completed and will be reviewed annually during QA and FHWA NBIP reviews.

The hands-on inspection should begin by removing any debris or rust scale present on bearing surfaces through use of a hand scraper or brush. The inspection should include an evaluation for all of the defects identified in Michigan Bridge Element Inspection Manual Condition State Table 11. In addition, bearings require inspection for cracking and proper functioning. Measure gaps that exist between the masonry or sole plate so shimming may be performed. Verify whether delamination or cracking is present on substructure components directly below the bearing. Measure the rotation of bearings exhibiting excessive tilt that is not in conformance for temperatures at the time of inspection. Inspect anchor bolts for signs of distress. Check sliding surfaces for gouging and make sure the movement is not restricted due to corrosion or other phenomena that could restrict the bearing.



Figure 5.16.08 Cracked H-Bearing Necessitates Detailed Inspection

The minimum information included in the in-depth inspection report shall be a plan of superstructure sheet denoting the locations inspected and defects identified. Photographs of deficient bearings should accompany the written report findings. Upon completion of an in-depth inspection that is completed in response to NBI condition ratings, the BSIR and element report should also be modified to reflect the data gathered when changes in the condition ratings are required.

MICHIGAN STRUCTURE INSPECTION MANUAL
BRIDGE INSPECTION – ROUTINE AND CONDITION BASED IN-DEPTH INSPECTION

5.17 Abutments (BSIR #13, SI&A Item 60* Substructure)

This section relates to the inspection of abutments and wingwalls. Abutments serve as a means to transmit loads and are located at each structure's point of beginning and termination (Reference Lines). In conjunction with wingwalls they also provide stability to the adjacent pavement subgrade. Abutments may be composed of one primary material or a combination of several with multiple designs for each. The type ultimately utilized is contingent to site and period specific loading requirements, soils, scour potentials, component elevation requirements, and thermal effects. It is vital to review the type of foundations present for bridges that cross a waterway as it will determine the immediacy of remedial actions that must be taken when active scour is identified.

* Note SI&A Item 60 (Substructure) overall NBI condition rating is the lesser value obtained from BSIR #13 (Abutment) and BSIR #14 (Pier) ratings.

5.17.01 Concrete Abutment Routine NBI Inspection

The common members that shall be evaluated during the inspection of concrete abutments include exposed surfaces of the backwall, footing, pile cap, stem, and check wall. The team leader shall perform the procedures listed for the routine inspection, and review Chapter 12 of the BIRM for additional considerations during the inspection.

1. Inspect the exposed abutment surfaces for protective coating failure. Document the approximate location and estimated percentage of surface coating failure.
2. Inspect the back wall for cracking, and investigate whether any observed cracking is structural or non-structural. Document the approximate location, orientation, width, and spacing of the cracking.
3. Inspect the back wall for delamination and spalling. Document the approximate location of delamination or spalling while indicating if reinforcement is exposed.
4. Inspect abutments with independent back walls to ensure that adequate clearance is provided for superstructure expansion. Document the location when there is inadequate space between the abutment back wall and beam ends.
5. Inspect the abutment stem and wingwalls for cracking, and investigate whether any observed cracking is structural or non-structural. Sound areas beneath bearings that are exhibiting signs of distress. Document the approximate location, orientation, width, and spacing of the cracking.
6. Inspect the abutment stem and wingwalls for delamination and spalling. Sound areas beneath bearings that are exhibiting signs of distress. Document the approximate location of delamination or spalling while indicating if reinforcement is exposed.

MICHIGAN STRUCTURE INSPECTION MANUAL
BRIDGE INSPECTION – ROUTINE AND CONDITION BASED IN-DEPTH INSPECTION

7. Inspect abutments and wingwalls for signs of movement or settlement. Observe the alignment to detect vertical, lateral, or rotational displacement. Document the location and type of movement.
8. Inspect weep holes in the base of the abutment stem (if applicable) to determine if they are functioning adequately. Document the approximate location of clogged or ineffective drain systems.
9. Inspect the base of the abutment stem or footing for scour. Document the location of footing exposure and areas where scouring is below the limits of the footing.
10. Inspect the scour countermeasures for effectiveness and damage. Document the location where countermeasures have limited effectiveness.
11. Inspect surfaces that are exposed to drainage for deterioration. Document the approximate location, type of defect, and cause of the damage.
12. Record photos of deficiencies when a change in the condition rating occurs and review the in-depth inspection procedures for suggested follow-up activities.

The evaluation of concrete abutments shall conform to the summarized conditions provided in Table 5.17.01. The MDOT Bridge Safety [NBI Rating Guidelines](#) shall be used to assign an overall code to condition of the entire area present. The Item 113 rating may have a significant effect on this item if scour has substantially affected the overall condition of the substructure. The location, size, and depth of any scour must be noted in the comments.

Table 5.17.01 Summarized Concrete Abutment Rating Guidelines

Good	Insignificant cracks or moderate cracks that are sealed. All components retain full section properties and function as designed.
Fair	Moderate delamination, spalling, or efflorescence. Reinforcement exposure without section loss. Moderate deterioration affecting structural components including minor settlement, shallow scour, or impact damage. All members continue to function as designed.
Poor	Considerable cracking, spalling, and efflorescence with heavy build-up or rust staining. Considerable deterioration affecting structural members including partial settlement or scour. All members continue to function as designed.
Serious	Considerable areas of spalling, exposed reinforcement with section loss, or heavy rust staining. Considerable deterioration or damage affecting structural members. Structural evaluation, hydraulic, and/or load analysis may be necessary to determine if the structure can continue to function without restricted loading or immediate repairs.
Critical	Deterioration has progressed to the point where the structure will not support design loads and posting, emergency repairs, or shoring with structurally engineered temporary supports is required.

MICHIGAN STRUCTURE INSPECTION MANUAL
BRIDGE INSPECTION – ROUTINE AND CONDITION BASED IN-DEPTH INSPECTION

5.17.02 Concrete Abutment Michigan Bridge Element Inspection

Element level information shall be collected for all concrete abutments using the Michigan Bridge Element Inspection Manual elements and condition states. Element 215 (Reinforced Concrete Abutment) shall be used when cast-in-place concrete is the primary substructure material that transfers load from the superstructure to the foundation and retains approach roadway embankment. Include the deficiencies observed on the surfaces of monolithic wingwalls in the evaluation of the abutment (see Figure 5.17.01). If a joint separates the wingwall from the abutment then use Element 852 (Wingwall) and collect condition state quantities for the deficiencies observed. If footings, pile, or scour countermeasures are exposed for visual inspection, add the applicable material specific elements and rate them according to the area that may be inspected. Collect elements for any protective coatings that have been applied to the surface. A flowchart illustrating the process of determining the applicable elements for section loss has been provided for clarification (see Figure 5.17.02).



Figure 5.17.01 Abutment with Monolithic Wingwall
Deterioration included with Rating of Abutment

**MICHIGAN STRUCTURE INSPECTION MANUAL
BRIDGE INSPECTION – ROUTINE AND CONDITION BASED IN-DEPTH INSPECTION**

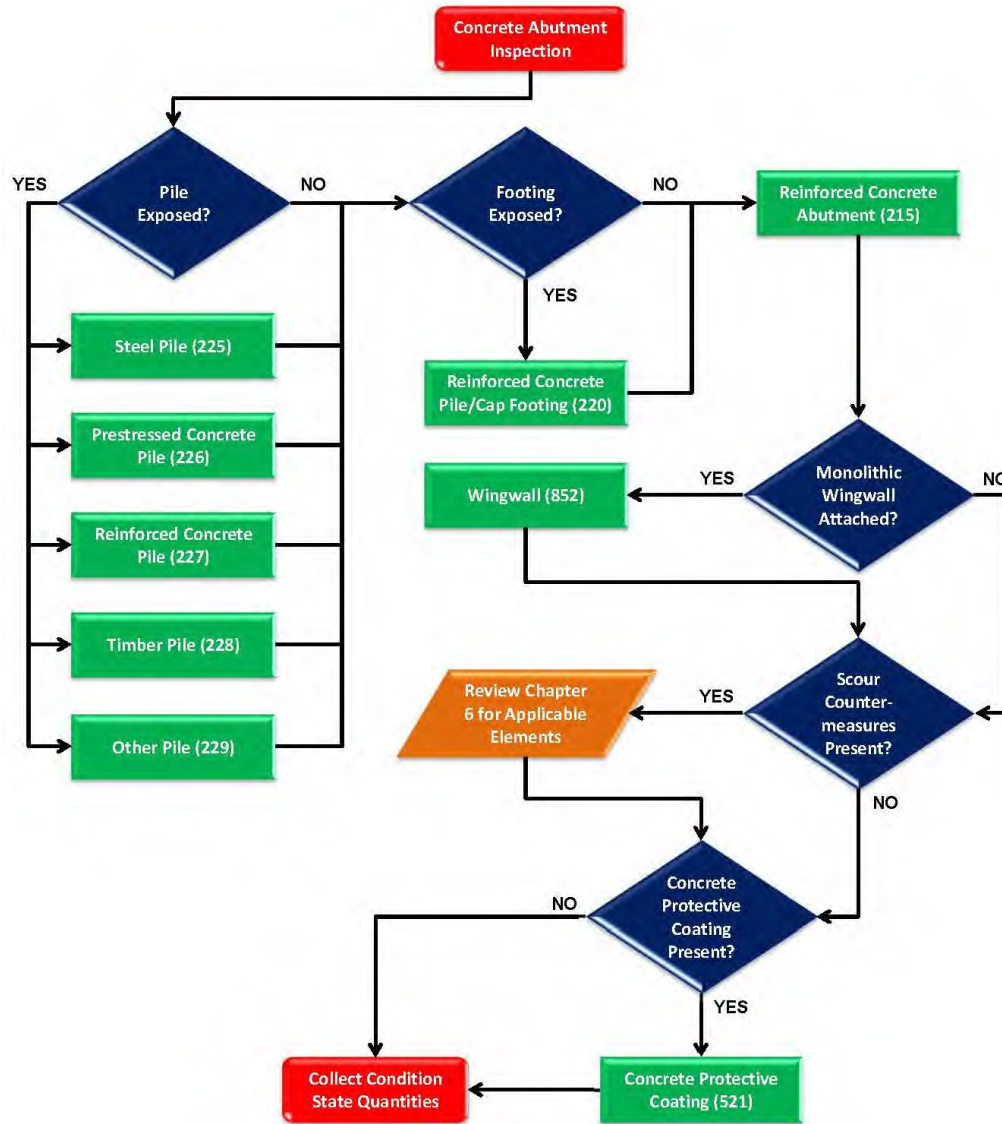

Figure 5.17.02 Concrete Abutment Element Collection Process

MICHIGAN STRUCTURE INSPECTION MANUAL
BRIDGE INSPECTION – ROUTINE AND CONDITION BASED IN-DEPTH INSPECTION

5.17.03 Mechanically Stabilized Earth (MSE) Walls Routine NBI Inspection

Among the many advantages of erecting Mechanically Stabilized Earth (MSE) walls in lieu of full height concrete abutments, are the realization of significant cost savings during the construction phase. MSE abutment designs may be separated into two general types; one in which the engineered fill acts to support loads from the structure and approach roadway embankment, and a second type that incorporates piles for transfer of structural loads and engineered fill to resist approach roadway embankment loads. MSE wall systems are founded on a base pad that provides a level surface to erect precast wall panels. Since base pads are usually unreinforced, exposure and undermining can result in severe implications for stability of the fill. Each of the panels resists shear loads through the inclusion of attached horizontal reinforcement that is distributed throughout the compacted backfill. Additional features which require inspection include coping, drainage, and any visible materials which should not be exposed. The team leader shall perform the procedures listed for the routine inspection, and review Chapter 12 of the BIRM for additional considerations during the inspection.

1. Inspect the exposed pile cap and back wall for cracking, and investigate whether any observed cracking is structural or non-structural. Document the approximate location, orientation, width, and spacing of the cracking.
2. Inspect the exposed pile cap and back wall for delamination and spalling. Document the approximate location of delamination or spalling while indicating if reinforcement is exposed.
3. Inspect panels, slip joints, coping and corner panel surfaces for protective coating failure. Document the approximate location and estimated percentage of surface coating failure.
4. Inspect the approach pavement joints, areas located behind curb near above the wall system, or other places where voids underneath the approach slab may be detected. Document the location where voids have developed.
5. Inspect panels for signs of movement or joint failure. Observe the alignment of individual panels as well as the entire system to detect vertical, lateral, or rotational displacement. Document the location, type of movement, and quantity of panels affected.
6. Inspect the panels, slip joints, coping and corner panels for cracking and staining caused by moisture. Document the location where cracking is suspected to extend through the entire panel, signs of excessive moisture are present, and quantity of panels affected.
7. Inspect the wall system for exposed geotextile fabric and loss of engineered fill. Document the location where fabric is exposed or loss of fill is occurring.
8. Inspect the wall system for vegetation growth between the panels. Document locations where vegetation is growing that could damage geotextile fabric retaining engineered fill.

MICHIGAN STRUCTURE INSPECTION MANUAL
BRIDGE INSPECTION – ROUTINE AND CONDITION BASED IN-DEPTH INSPECTION

9. Inspect the wall system for vehicular damage. Document the location and degree of damage.
10. Inspect the wall system for signs of inadequate drainage. Observe the drainage inlets and outlets (if applicable) for debris or blockage which could hamper effectiveness.
11. Inspect the wall system for erosion. Evaluate the base of the wall perimeter to determine if the leveling pad is exposed or undermining has occurred. Document the location of erosion and leveling pad exposure.
12. Record photos of deficiencies when a change in the condition rating occurs and review the in-depth inspection procedures for suggested follow-up activities.

The evaluation of MSE abutments shall conform to the summarized conditions provided in Table 5.17.02. The MDOT Bridge Safety [NBI Rating Guidelines](#) shall be used to assign an overall code to condition of the entire area present. The Item 113 rating may have a significant effect on this item if scour has substantially affected the overall condition of the substructure. The location, size, and depth of any scour must be noted in the comments.

Table 5.17.02 Summarized MSE Abutment Rating Guidelines

Good	Structural cracking or staining of panels is minor and limited to a few locations. All components retain full section properties and function as designed.
Fair	Connections visible at isolated locations where panels are bowing. Joint width between panels is substantially uniform. Moderate deterioration affecting structural components including minor settlement, shallow scour, or impact damage. All members continue to function as designed.
Poor	Moderate uniform tilting of walls that does not require structural review. Structural cracking limited to between 10% and 25% of the area. Erosion has exposed the wall base without undermining. Considerable deterioration affecting structural members including partial settlement or scour. All members continue to function as designed.
Serious	Structural cracking occurring on greater than 25% of area. Exposed geotextile fabric or loss of backfill. Considerable deterioration or damage affecting structural members. Structural evaluation, hydraulic, and/or load analysis may be necessary to determine if the structure can continue to function without restricted loading or immediate repairs.
Critical	Deterioration has progressed to the point where the structure will not support design loads and posting, emergency repairs, or shoring with structurally engineered temporary supports is required.

MICHIGAN STRUCTURE INSPECTION MANUAL
BRIDGE INSPECTION – ROUTINE AND CONDITION BASED IN-DEPTH INSPECTION

5.17.04 Mechanically Stabilized Earth Walls Element Inspection

Element level information shall be collected for all MSE abutments using the Michigan Bridge Element Inspection Manual elements and condition states. Element 860 (MSE Abutment) shall be used for all mechanically stabilized earth wall abutments. The collection of condition state quantities shall include all deficiencies on the stub, precast panels, and any additional features present. If footings or pile are exposed for visual inspection, add the applicable material specific elements and rate it according to the area that may be inspected. When the base pad is exposed it shall be considered in the evaluation of the abutment, and the length that may be observed coded in Condition State 4. A flowchart illustrating the process of determining the applicable elements for section loss has been provided for clarification (see Figure 5.17.03).

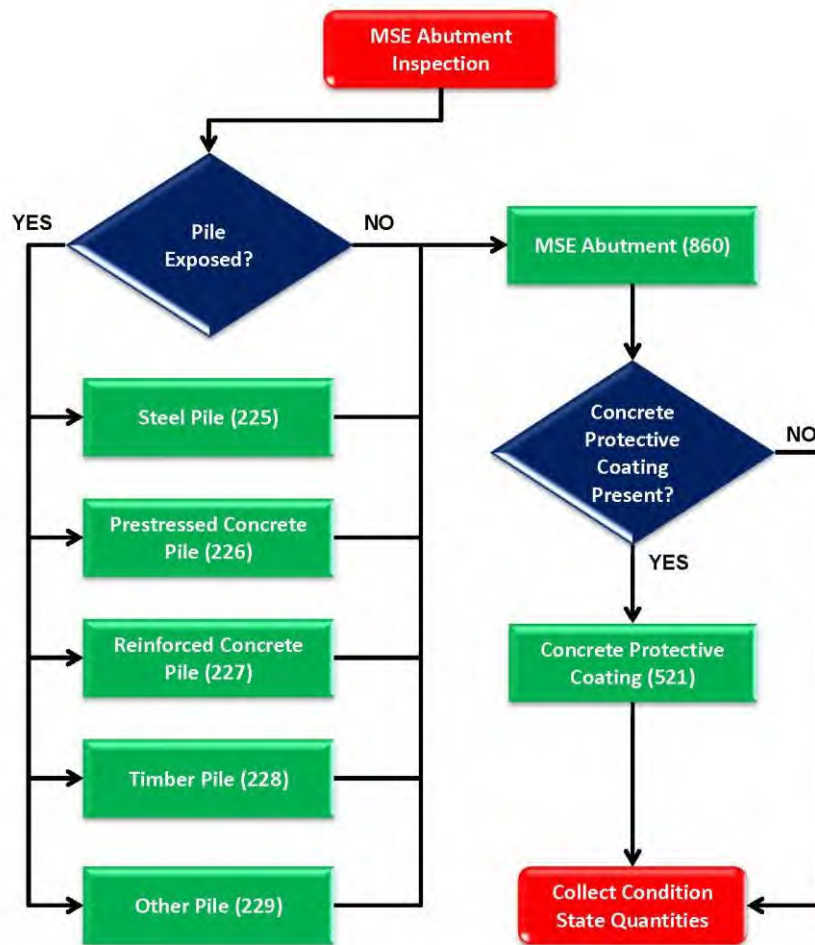

Figure 5.17.03 MSE Abutment Element Collection Process

MICHIGAN STRUCTURE INSPECTION MANUAL
BRIDGE INSPECTION – ROUTINE AND CONDITION BASED IN-DEPTH INSPECTION

5.17.05 Timber Abutment Routine NBI Inspection

Abutments composed solely or primarily of timber require inspection for insect damage, decay, splitting, and other defects. Timber wingwalls constructed with similar materials and methods will be rated within the abutment. Since decay often occurs from the inside-out it is important to perform additional investigation when rotting is suspected. Timber pile bent abutments located in water or saturated soils are also susceptible to advanced loss near the waterline. The team leader shall perform the procedures listed for the routine inspection, and review Chapter 12 of the BIRM for additional considerations during the inspection.

1. Inspect the timber abutment and wingwalls for insect damage, decay, and section loss. When section loss is measurable evaluate the area to determine if an in-depth inspection and subsequent load analysis is warranted. Document the approximate location and estimated amount of section loss.
2. Inspect the timber abutment and wingwalls for splitting. Document the approximate location and length in respect to the member depth.
3. Inspect the timber abutment and wingwalls for loose or failed connections. Document the approximate location of inadequate, deteriorated, or damaged connections.
4. Inspect the timber abutment and wingwalls for check or shakes. Document the approximate location, note whether they occur in tension or compression zones, and the length in respect to member depth.
5. Inspect the base of the abutment stem or footing for scour. Document the location of footing exposure and areas where scouring is below the limits of the footing.
6. Inspect surfaces that are exposed to drainage for deterioration. Document the approximate location, type of defect, and cause of the damage.
7. Record photos of deficiencies when a change in the condition rating occurs and review the in-depth inspection procedures for suggested follow-up activities.

The evaluation of timber abutments shall conform to the summarized conditions provided in Table 5.17.03. The MDOT Bridge Safety [NBI Rating Guidelines](#) shall be used to assign an overall code to condition of the entire area present. The Item 113 rating may have a significant effect on this item if scour has substantially affected the overall condition of the substructure. The location, size, and depth of any scour must be noted in the comments.

**MICHIGAN STRUCTURE INSPECTION MANUAL
BRIDGE INSPECTION – ROUTINE AND CONDITION BASED IN-DEPTH INSPECTION**

Table 5.17.03 Summarized Timber Abutment Rating Guidelines

Good	Checks or shakes penetrate less than 5% of the member thickness. All components retain full section properties and function as designed.
Fair	Decay or section loss affecting 5% to 10% of the member section. Checks, shakes, and splits have no effect on capacity. Moderate deterioration affecting structural components including minor settlement, shallow scour, or impact damage. All members continue to function as designed.
Poor	Extensive decay, section loss, checks, shakes, or splits that do not warrant structural review. Considerable deterioration affecting structural members including partial settlement or scour. All members continue to function as designed.
Serious	Decay or section loss that affects more than 10% of the member section. Checks, shakes, splits may warrant action. Considerable deterioration or damage affecting structural members. Structural evaluation, hydraulic, and/or load analysis may be necessary to determine if the structure can continue to function without restricted loading or immediate repairs.
Critical	Deterioration has progressed to the point where the structure will not support design loads and posting, emergency repairs, or shoring with structurally engineered temporary supports is required.

5.17.06 Timber Abutment Element Inspection

Element level information shall be collected for all timber abutments using the Michigan Bridge Element Inspection Manual elements and condition states. Element 216 (Timber Abutment) shall be used for all abutments where timber is the primary material used (see Figure 5.17.04). For timber abutments with concrete bent caps multiple material specific condition state tables may be required. If footings, pile, or scour countermeasures are exposed for visual inspection, add the applicable material specific elements and rate them according to the area that may be inspected. A flowchart illustrating the process of determining the applicable elements for section loss has been provided for clarification (see Figure 5.17.05).



Figure 5.17.04 Timber Bent Abutment with Natural Plain Rip Rap

MICHIGAN STRUCTURE INSPECTION MANUAL
BRIDGE INSPECTION – ROUTINE AND CONDITION BASED IN-DEPTH INSPECTION

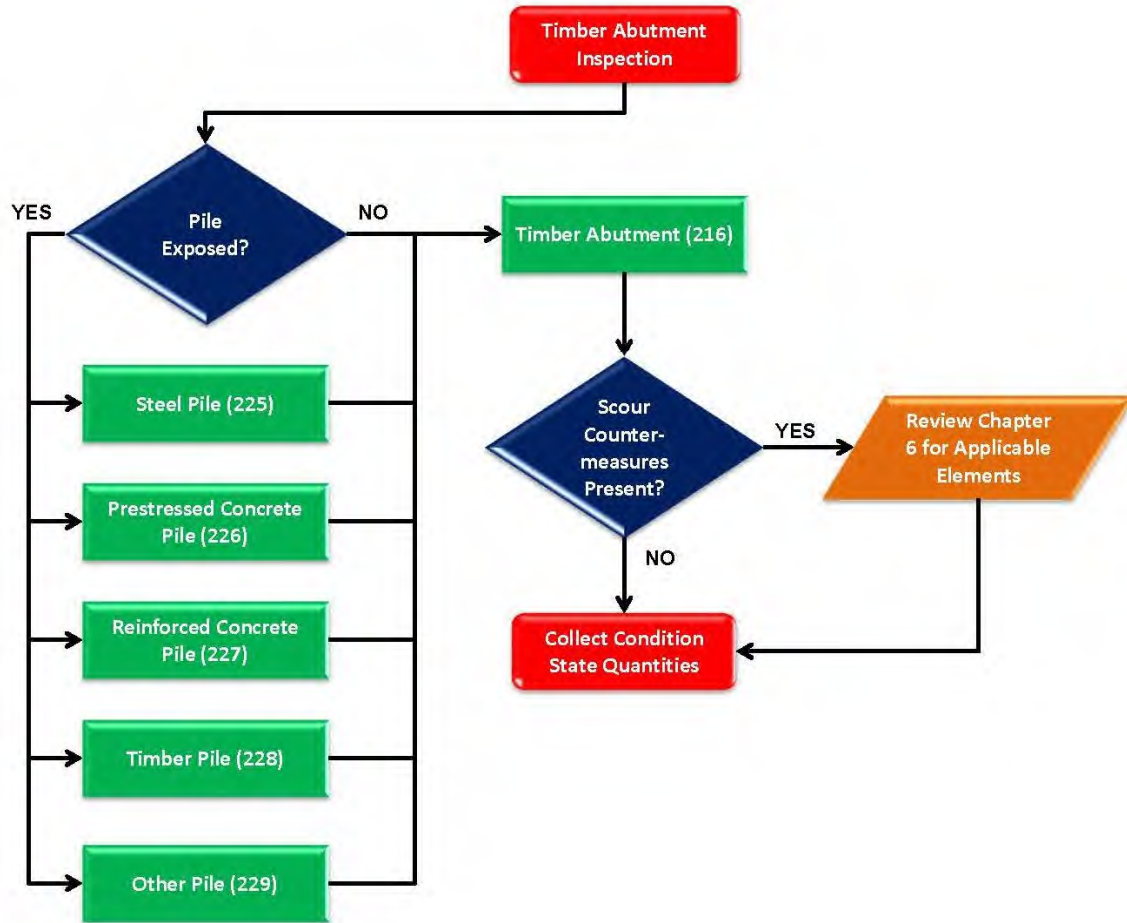

Figure 5.17.05 Timber Abutment Element Collection Process

5.17.07 Abutment Work Recommendations

The team leader should provide work recommendations for abutments when defects are present. Several examples of recommendations that work to resolve or delay additional deterioration when BSIR Item #13 is in fair or good condition are provided below in Table 5.17.04. Consideration for measures that are not directly associated with the abutment, such as resealing end joints or installation of pressure relief joints, should also be included when other actions could extend the condition of the abutment.

MICHIGAN STRUCTURE INSPECTION MANUAL
BRIDGE INSPECTION – ROUTINE AND CONDITION BASED IN-DEPTH INSPECTION

Table 5.17.04 Work Recommendations for Abutments

Recommendation	Defects	Additional Information
Substructure Patching	Spalling, Delamination, Exposed Reinforcement	Defects located below bearing devices may require temporary supports for proper repairs.
Crack Injection	Wide Cracks, loss of engineered fill	Recommended to limit reinforcement corrosion.
Repair Drainage Devices	Drainage, MSE wall or reinforced concrete	Drainage systems must function properly to prevent localized failure or ponding below the structure.
Scour Countermeasures	Scour, exposure or undermining of the footing	Consult a hydraulics engineer for additional information.

Prioritize work recommendations according to the general guidelines provided below. Reference the element, location, and describe the extent of rehabilitative measures required. Submit a Request for Action (RFA) for any activity that should be completed prior to the next scheduled routine inspection.

High Priority Work Recommendations

Any structural repairs or replacement of bridge elements that should be completed within 24 to 60 months. High Priority work recommendations consist of any activity that will function to maintain safe load carrying capacity or preserve existing primary component condition ratings.

Medium Priority Work Recommendations

Any structural or non-structural repairs that should be completed within 24 to 60 months. Medium priority work recommendations serve to improve existing component and element condition ratings that are currently in fair or better condition.

Low Priority Work Recommendations

Any repairs that should be scheduled in conjunction with other planned work at the structure. Low priority work recommendations may have little to no effect on primary component condition ratings.

5.17.08 Abutment Request for Action

An RFA shall be submitted to the bridge owner when the abutment no longer functions as designed, deterioration has caused reduced bearing area, or when a detailed inspection is required. Corrective actions that do not require completion prior to the next scheduled routine inspection should be identified as a work recommendation on the BSIR. Several examples of defects or suspected deficiencies that trigger an RFA submittal for resolution and/or investigation concerning abutments are provided in Table 5.17.05. For other materials an RFA shall be submitted as-needed requesting the in-depth inspection. The RFA shall be submitted in MiB^{RIDGE} with proper documentation and photographs so an adequate review and resolution of the process may be completed.

Table 5.17.05 Abutments Defects Initiating a Request for Action

MICHIGAN STRUCTURE INSPECTION MANUAL
BRIDGE INSPECTION – ROUTINE AND CONDITION BASED IN-DEPTH INSPECTION

Request for Action	Primary Materials		
	Concrete	MSE	Timber
In-depth Inspection	X	X	X
Element Quantities in Condition State 4	X	X	X
25% or Greater Reduced Bearing Surface	X	X	X
Settlement or Displacement	X	X	X
Scour Exceeding Tolerable Limits	X	X	X
Leveling Pad Exposure		X	
Internal Rot/Decay			X
Vehicular Damage	X	X	X

5.17.09 In-Depth Inspection

In-depth inspections shall be performed as-needed and condition based recommendations are provided in Table 5.17.06. Bridges which have substructure components in water depths exceeding 10 feet require an underwater diving inspection to be performed in accordance with NBIS and [Chapter 8](#). Once active scour that undermines or exposes the footing is identified an underwater or in-depth inspection may be required. Once the Abutment (Item 60, BSIR # 13) condition rating is coded 5 an in-depth inspection should be performed at intervals that do not exceed 48 months. The frequency of the in-depth inspection should be reduced to 36 months once it is rated in poor condition. Detailed inspection or documented review of abutments is required for Michigan Bridge Element Inspection when any quantity, excluding protective systems (galvanizing, concrete surface coating, etc.), is coded in condition state 4 (see Figure 5.17.06).

Table 5.17.06 Recommended Condition Based In-Depth Inspection Guideline for Bridge Railings

NBI Rating	Schedule Initial In-depth Within	In-Depth Frequency	Applicable Materials		
5	24 Months	48 Months	Concrete	MSE	Timber
≤ 4	12 Months	36 Months	Concrete	MSE	Timber

When a lane closure is necessary to perform the inspection because of safety concerns the bridge owner will be notified prior to performing the work. At a minimum, it is expected that the locations where materials have been coded in Condition State 4, and other areas that display the greatest degree of distress will be inspected. In-depth inspections over navigable water may require U.S. Coast Guard notification and consent prior to performing the work.

MICHIGAN STRUCTURE INSPECTION MANUAL
BRIDGE INSPECTION – ROUTINE AND CONDITION BASED IN-DEPTH INSPECTION



Figure 5.17.06 Severe Abutment Spalling Caused by Pavement Pressure

Approval for each in-depth inspection should be documented through the submittal of an RFA to the bridge owner using MiB^{RIDGE}. When the inspection is performed immediately in response to public safety concerns the inspection should be referenced on an RFA submitted after the work has been completed. These processes are necessary for confirming that the work has been completed and will be reviewed annually during QA and FHWA NBIP reviews.

In-depth inspection requirements of the abutments will vary according to the type of defects identified or suspected. When severe cracking or spalling is recognized below bearings this inspection may consist of sounding the surfaces and estimating the percentage of loss below each masonry plate. Inspection of submerged surfaces will require wade and probe, boat and probe, or underwater diving to confirm condition and verify the limits of scour. Suspected settlement, displacement, or rotation may require regular monitoring through the use of survey or specialized equipment. In each case, the scope of the inspection should adequately determine the severity of the defects present and ensure safety of the motoring public.

The minimum information included in the in-depth inspection report shall be a sketch of the areas examined with measured defects provided for each substructure unit. Areas that were not examined because defects were not observed shall also be delineated on the drawing for future consideration. The level of detail provided must allow for an efficient recurrent in-depth inspection to be conducted in order to determine if the condition of the substructure has changed. Photographs of the deficient areas should accompany the sketch and written report findings. Upon completion of an in-depth inspection that is completed in response to NBI condition ratings, the BSIR and element report should also be modified to reflect the data gathered when changes in the condition ratings are required.

MICHIGAN STRUCTURE INSPECTION MANUAL
BRIDGE INSPECTION – ROUTINE AND CONDITION BASED IN-DEPTH INSPECTION

5.18 Piers (BSIR #14, SI&A Item 60* Substructure)

This section relates to the inspection of piers, pier caps, collision walls, footings and other substructure components in proximity of the piers below the bearings. Piers serve as a means to transmit loads for multiple span structures (see Figure 5.18.01). Since they are often located in water or near traffic they are at an increased risk for damage caused by scour or impact. Steel piers may also contain fracture critical or fatigue sensitive details which require a hands-on inspection. The team leader shall perform the procedures listed for the routine inspection, and review Chapter 12 of the BIRM for additional considerations during the inspection.

* Note SI&A Item 60 (Substructure) overall NBI condition rating is the lesser value obtained from BSIR #13 (Abutment) and BSIR #14 (Pier) ratings.



Figure 5.18.01 Two Column Pier Supporting Fracture Critical Structure

5.18.01 Concrete Pier Routine NBI Inspection

The common members that shall be evaluated during the inspection of concrete piers shall include the pier cap, pier wall, column, and any exposed footings or deep foundation elements. The team leader shall perform the procedures listed for the routine inspection, and review Chapter 12 of the BIRM for additional considerations during the inspection.

1. Inspect pier surfaces for protective coating failure. Document the approximate location and estimated percentage of surface coating failure.
2. Inspect the cap, wall, or column for cracking, and investigate whether any observed cracking is structural or non-structural. Sound areas beneath bearings that are exhibiting signs of distress. Document the approximate location, orientation, width, and spacing of the cracking.

MICHIGAN STRUCTURE INSPECTION MANUAL
BRIDGE INSPECTION – ROUTINE AND CONDITION BASED IN-DEPTH INSPECTION

3. Inspect the cap, wall, or column for delamination and spalling. Sound areas beneath bearings that are exhibiting signs of distress. Document the approximate location of delamination or spalling while indicating if reinforcement is exposed.
4. Inspect piers for signs of movement or settlement. Observe the alignment to detect vertical, lateral, or rotational displacement. Document the location and type of movement.
5. Inspect the pier footing for scour. Document the location of footing exposure and areas where scouring is below the limits of the footing.
6. Inspect the scour countermeasures for effectiveness and damage. Document the location where countermeasures have limited effectiveness.
7. Inspect surfaces that are exposed to drainage for deterioration. Document the approximate location, type of defect, and cause of the damage.
8. Inspect pier walls, columns, and any protection systems for impact damage from vehicles or vessels. Document the location and degree of damage.
9. Record photos of deficiencies when a change in the condition rating occurs and review the in-depth inspection procedures for suggested follow-up activities.

The evaluation of concrete piers shall conform to the summarized conditions provided in Table 5.18.01. The MDOT Bridge Safety [NBI Rating Guidelines](#) shall be used to assign an overall code to condition of the entire area present. The SI&A Item 113, Scour Criticality rating may have a significant effect on this item if scour has substantially affected the overall condition of the substructure. The location, size, and depth of any scour must be noted in the comments.

Table 5.18.01 Summarized Concrete Pier Rating Guidelines

Good	Insignificant cracks or moderate cracks that are sealed. All members retain full section properties and function as designed.
Fair	Moderate delamination, spalling, or efflorescence. Reinforcement exposure without section loss. Moderate deterioration affecting structural components including minor settlement, shallow scour, or impact damage.
Poor	Considerable cracking, spalling, and efflorescence with heavy build-up or rust staining. Considerable deterioration affecting structural members including partial settlement or scour. All members continue to function as designed.
Serious	Considerable areas of spalling, exposed reinforcement with section loss, or heavy rust staining. Considerable deterioration or damage affecting structural members. Structural evaluation, hydraulic, and/or load analysis may be necessary to determine if the structure can continue to function without restricted loading or immediate repairs.
Critical	Deterioration has progressed to the point where the structure will not support design loads and posting, emergency repairs, or shoring with structurally engineered temporary supports is required.

MICHIGAN STRUCTURE INSPECTION MANUAL
BRIDGE INSPECTION – ROUTINE AND CONDITION BASED IN-DEPTH INSPECTION

5.18.02 Concrete Pier Michigan Bridge Element Inspection

Element level information shall be collected for all concrete piers using the Michigan Bridge Element Inspection Manual elements and condition states. The number of elements required during the pier evaluation will be contingent on the width and design. Use Element 205 (Reinforced Concrete Column) for piers with single or multiple columns that are less than 10 feet wide (see Figure 5.18.02). For widths greater than 10 feet wide, collect condition state quantities with Element 210 (Reinforced Concrete Pier Wall). Do not add Element 234 (Reinforced Concrete Pier Cap) for pier walls that do not have a well-defined cap. If footings, piles, or scour countermeasures are exposed for visual inspection, add the applicable material specific elements and rate them according to the area that may be inspected. Collect elements for any protective coatings that have been applied to the surface. A flowchart illustrating the process of determining the applicable elements for section loss has been provided for clarification (see Figure 5.18.03).



Figure 5.18.02 Element 234 Reinforced Concrete Column

**MICHIGAN STRUCTURE INSPECTION MANUAL
BRIDGE INSPECTION – ROUTINE AND CONDITION BASED IN-DEPTH INSPECTION**

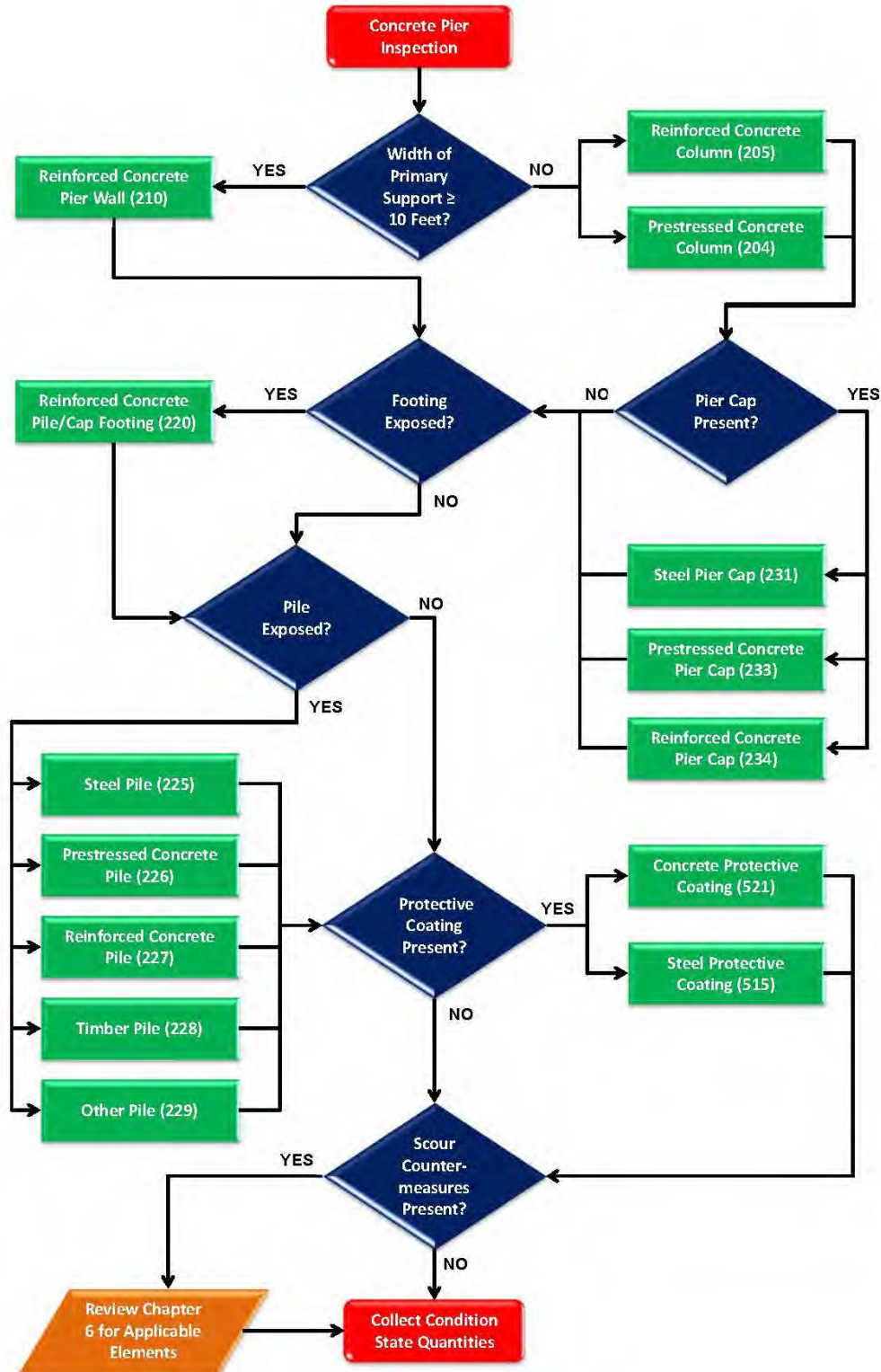

Figure 5.18.03 Concrete Pier Element Collection Process

MICHIGAN STRUCTURE INSPECTION MANUAL
BRIDGE INSPECTION – ROUTINE AND CONDITION BASED IN-DEPTH INSPECTION

5.18.03 Steel Pier Routine NBI Inspection

Steel bent, trestle, or any other configurations shall be inspected for corrosion, fatigue cracking, collision, coating failures, and other defects. Steel piers located in water or saturated soils are also susceptible to advanced loss near the waterline. The team leader shall perform the procedures listed for the routine inspection, and review Chapter 12 of the BIRM for additional considerations during the inspection.

1. Inspect steel pier surfaces for protective coating failure. Note whether the failure is limited to the top application coat or to bare steel. Document the approximate location, percentage, and extent of coating failure.
2. Inspect the steel cap and for cracking at bearing locations. When cracking has been previously arrested or repairs have been installed observe the surrounding surface area to verify that further propagation is not occurring. Document the approximate location and estimated length of the cracking.
3. Inspect the steel cap and columns for corrosion, section loss, and buckling. Document the location, length of area affected, and estimated extent of section loss.
4. Inspect steel piers for signs of movement or settlement. Observe the alignment to detect vertical, lateral, or rotational displacement. Document the location and type of movement.
5. Inspect the pier footing for scour. Document the location of footing exposure and areas where scouring is below the limits of the footing.
6. Inspect the scour countermeasures for effectiveness and damage. Document the location where countermeasures have limited effectiveness.
7. Inspect surfaces that are exposed to drainage for deterioration. Document the approximate location, type of defect, and cause of the damage.
8. Inspect steel columns and any protection systems present for impact damage from vehicles or vessels. Document the location and degree of damage.
9. Record photos of deficiencies when a change in the condition rating occurs and review the in-depth inspection procedures for suggested follow-up activities.

The evaluation of steel piers shall conform to the summarized conditions provided in Table 5.18.02. The MDOT Bridge Safety [NBI Rating Guidelines](#) shall be used to assign an overall code to condition of the entire area present. The Item 113 rating may have a significant effect on this item if scour has substantially affected the overall condition of the substructure. The location, size, and depth of any scour must be noted in the comments.

MICHIGAN STRUCTURE INSPECTION MANUAL
BRIDGE INSPECTION – ROUTINE AND CONDITION BASED IN-DEPTH INSPECTION

Table 5.18.02 Summarized Steel Pier Rating Guidelines

Good	Protective coating failure in very small and scattered locations. All members retain full section properties and function as designed.
Fair	Protective coating failure is limited to less than 5% of the surface area with minor loss of section. Loose fasteners or broken welds present but the connection is in place and functioning as intended. Moderate deterioration affecting structural components including minor settlement, shallow scour, or impact damage.
Poor	Protective coating failure affecting between 5% and 10% of the surface area with some loss of section. Cracks that have not been arrested but do not require structural review. Considerable deterioration affecting structural members including partial settlement or scour. All members continue to function as designed.
Serious	Protective coating failure affecting more than 10% of the surface area with measurable loss of section. Missing fasteners or adjacent broken welds present that do not warrant a structural review. Considerable deterioration or damage affecting structural members. Structural evaluation, hydraulic, and/or load analysis may be necessary to determine if the structure can continue to function without restricted loading or immediate repairs.
Critical	Deterioration has progressed to the point where the structure will not support design loads and posting, emergency repairs, or shoring with structurally engineered temporary supports is required.

5.18.04 Steel Pier Michigan Bridge Element Inspection

Element level information shall be collected for all steel piers using the Michigan Bridge Element Inspection Manual elements and condition states. The number of elements required during the pier evaluation will be contingent on the width and design. Use Element 202 (Steel Column) for piers with pile caps or footings, and Element 225 (Steel Pile) for steel bents. Do not use Element 220 (Reinforced Concrete Pile Cap/Footing) unless the pile cap was constructed at grade. If footings, piles, or scour countermeasures are exposed for visual inspection, add the applicable material specific elements and rate them according to the area that may be inspected. Collect elements for any protective coatings that have been applied to the surface. A flowchart illustrating the process of determining the applicable elements for section loss has been provided for clarification (see Figure 5.18.04).

**MICHIGAN STRUCTURE INSPECTION MANUAL
BRIDGE INSPECTION – ROUTINE AND CONDITION BASED IN-DEPTH INSPECTION**

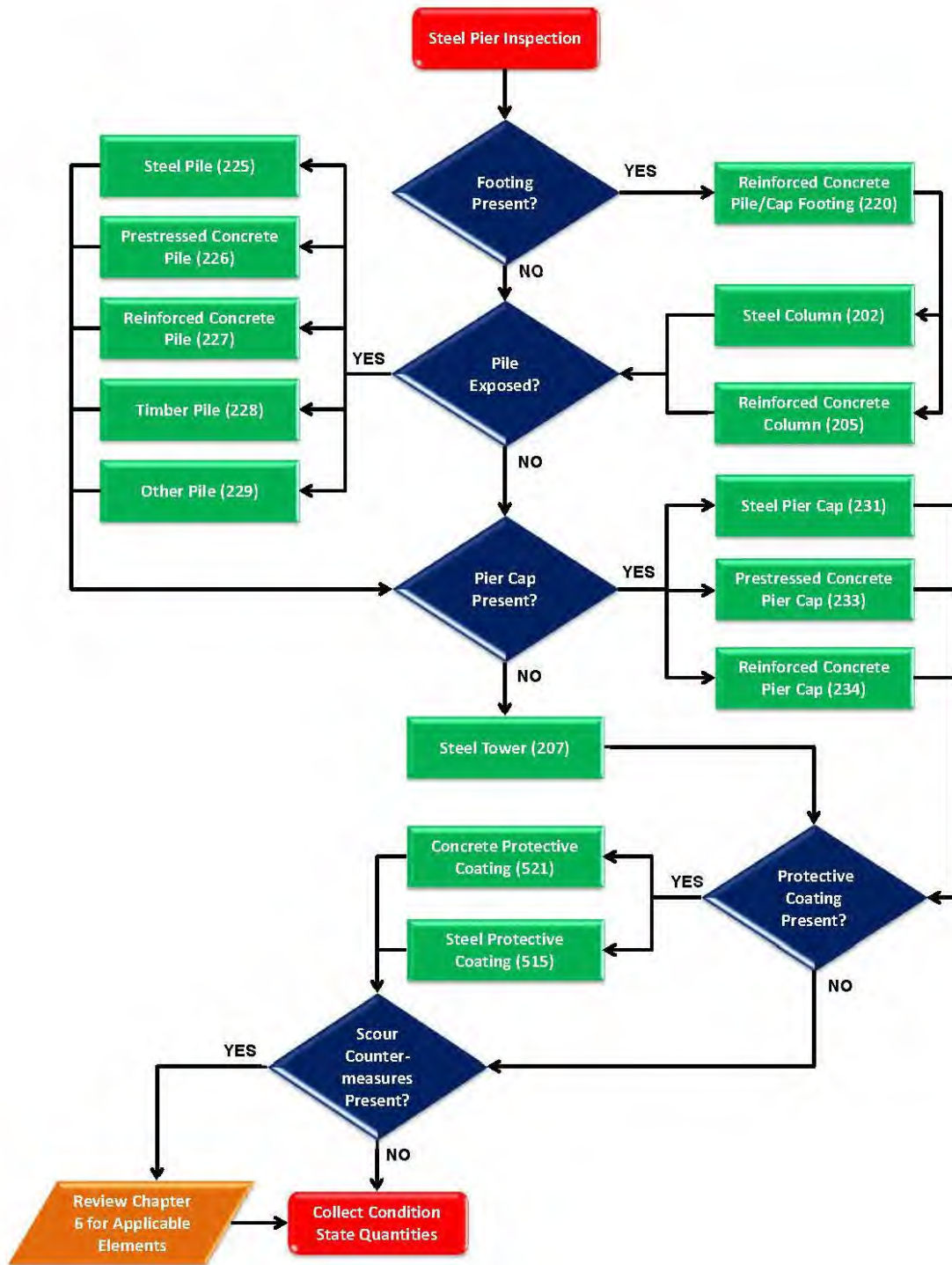

Figure 5.18.04 Concrete Pier Element Collection Process

MICHIGAN STRUCTURE INSPECTION MANUAL
BRIDGE INSPECTION – ROUTINE AND CONDITION BASED IN-DEPTH INSPECTION

5.18.05 Timber Pier Routine NBI Inspection

Piers composed primarily of timber require inspection for insect damage, decay, splitting, and other defects. Since decay often occurs from the inside-out it is important to perform additional investigation when rotting is suspected (see Figure 5.18.05). Timber piers located in water or saturated soils are also susceptible to advanced loss near the waterline. The team leader shall perform the procedures listed for the routine inspection, and review Chapter 12 of the BIRM for additional considerations during the inspection.



Figure 5.18.05 Hollow Timber Column

1. Inspect the timber cap and columns for insect damage, decay, and section loss. When section loss is measurable evaluate the area to determine if an in-depth inspection and subsequent load analysis is warranted. Document the approximate location and estimated amount of section loss.
2. Inspect the timber cap and columns for splitting. Document the approximate location and length in respect to the member depth.
3. Inspect the timber cap and columns for loose or failed connections. Document the approximate location of inadequate, deteriorated, or damaged connections.
4. Inspect the timber cap and columns for check or shakes. Document the approximate location, note whether they occur in tension or compression zones, and the length in respect to member depth.
5. Inspect surfaces that are exposed to drainage for deterioration. Document the approximate location, type of defect, and cause of the damage.

MICHIGAN STRUCTURE INSPECTION MANUAL
BRIDGE INSPECTION – ROUTINE AND CONDITION BASED IN-DEPTH INSPECTION

6. Inspect pier walls, columns, and any protection systems for impact damage from vehicles or vessels. Document the location and degree of damage.

7. Record photos of deficiencies when a change in the condition rating occurs and review the in-depth inspection procedures for suggested follow-up activities.

The evaluation of timber piers shall conform to the summarized conditions provided in Table 5.18.03. The MDOT Bridge Safety [NBI Rating Guidelines](#) shall be used to assign an overall code to condition of the entire area present. The Item 113 rating may have a significant effect on this item if scour has substantially affected the overall condition of the substructure. The location, size, and depth of any scour must be noted in the comments.

Table 5.18.03 Summarized Timber Pier Rating Guidelines

Good	Checks or shakes penetrate less than 5% of the member thickness. All members retain full section properties and function as designed.
Fair	Decay or section loss affecting 5% to 10% of the member section. Checks, shakes, and splits have no effect on capacity. Moderate deterioration affecting structural components including minor settlement, shallow scour, or impact damage.
Poor	Extensive decay, section loss, checks, shakes, or splits that do not warrant structural review. Considerable deterioration affecting structural members including partial settlement or scour. All members continue to function as designed.
Serious	Decay or section loss that affects more than 10% of the member section. Checks, shakes, splits may warrant action. Considerable deterioration or damage affecting structural members. Structural evaluation, hydraulic, and/or load analysis may be necessary to determine if the structure can continue to function without restricted loading or immediate repairs.
Critical	Deterioration has progressed to the point where the structure will not support design loads and posting, emergency repairs, or shoring with structurally engineered temporary supports is required.

5.18.06 Timber Pier Michigan Bridge Element Inspection

Element level information shall be collected for all timber piers using the Michigan Bridge Element Inspection Manual elements and condition states. The number of elements required during the pier evaluation will be contingent on the width and design. Use the guidelines provided in Sections 5.18.02 and 5.18.04 and apply them in similar fashion for timber piers.

MICHIGAN STRUCTURE INSPECTION MANUAL
BRIDGE INSPECTION – ROUTINE AND CONDITION BASED IN-DEPTH INSPECTION

5.18.07 Pier Work Recommendations

The team leader should provide work recommendations for piers when defects are present. Several examples of recommendations that work to resolve or delay additional deterioration when Item 60 is in fair or good condition are provided below in Table 5.18.04. Consideration for measures that is not directly associated with the abutment, such as resealing end joints or installation of pressure relief joints, should also be included when other actions could extend the condition of the abutment.

Table 5.18.04 Work Recommendations for Piers

Recommendation	Defects	Additional Information
Substructure Patching	Spalling, Delamination, Exposed Reinforcement	Defects located below bearing devices may require temporary supports for proper repairs.
Structural Crack Injection	Unsealed Moderate Width Cracks	Recommended to limit reinforcement corrosion.
Scour Countermeasures	Scour, exposure or undermining of the footing	Consult a hydraulics engineer for additional information.
Spot Painting	Spot Rusting	Limited to isolated locations. No lead present.
Zone Painting	General Rusting, Cracking/Peeling/Curling	Limited to concentrated areas. Usually near joints or locations exposed to drainage.
Full Painting	Pinpoint Rusting, Chalking, All Others	Recommended when > 15% of the coating has failed.
Temporary Supports	Section loss, measurable and greater than 10% for steel or reduced bearing surface greater than 25% for concrete	Recommendation for permanent repairs should also be provided.
Steel Repairs	Section loss, measurable and greater than 10%	Requires review prior to implementation and consideration for repairing element that led to deterioration.

Prioritize work recommendations according to the general guidelines provided below. Reference the element, location, and describe the extent of rehabilitative measures required. Submit a Request for Action (RFA) for any activity that should be completed prior to the next scheduled routine inspection.

High Priority Work Recommendations

Any structural repairs or replacement of bridge elements that should be completed within 24 to 60 months. High Priority work recommendations consist of any activity that will function to maintain safe load carrying capacity or preserve existing primary component condition ratings.

Medium Priority Work Recommendations

Any structural or non-structural repairs that should be completed within 24 to 60 months. Medium

MICHIGAN STRUCTURE INSPECTION MANUAL
BRIDGE INSPECTION – ROUTINE AND CONDITION BASED IN-DEPTH INSPECTION

priority work recommendations serve to improve existing component and element condition ratings that are currently in fair or better condition.

Low Priority Work Recommendations

Any repairs that should be scheduled in conjunction with other planned work at the structure. Low priority work recommendations may have little to no effect on primary component condition ratings.

5.18.08 Pier Request for Action

An RFA shall be submitted to the bridge owner when the pier no longer functions as designed, deterioration has caused reduced bearing area, or when a detailed inspection is required. Corrective actions that do not require completion prior to the next scheduled routine inspection should be identified as a work recommendation on the BSIR. Several examples of defects or suspected deficiencies that trigger an RFA submittal for resolution and/or investigation concerning abutments are provided in Table 5.18.05. For other materials an RFA shall be submitted as-needed requesting the in-depth inspection. The RFA shall be submitted in MiB^{RIDGE} with proper documentation and photographs so an adequate review and resolution of the process may be completed.

Table 5.18.05 Pier Defects Initiating a Request for Action

Request for Action	Primary Materials		
	Concrete	Steel	Timber
In-depth Inspection	X	X	X
Element Quantities in Condition State 4	X	X	X
25% or Greater Reduced Bearing Surface	X	X	X
Settlement or Displacement	X	X	X
Scour Exceeding Tolerable Limits	X	X	X
Excessive Section Loss	X	X	X
Internal Rot/Decay			X
Vehicular or Vessel Damage	X	X	X

5.18.09 Pier In-Depth Inspection

In-depth inspections shall be performed as-needed and condition based recommendations are provided in Table 5.18.06. As described in [Chapter 8](#), bridges which have substructure components in water depths exceeding 10 feet require an underwater diving inspection to be performed in accordance with NBIS. Once active scour that undermines or exposes the footing is identified an underwater or in-depth inspection may be required. Once the Pier (Item 60, BSIR # 14) condition rating is coded 5 an in-depth inspection should be performed at intervals that do not exceed 48 months. The frequency of the in-depth inspection should be reduced to 36 months once it is rated in poor condition. Detailed inspection or documented review of piers is required for Michigan Bridge Element Inspection when any quantity, excluding protective systems (galvanizing, concrete surface coating, etc.), is coded in Condition State 4 (see Figure 5.18.06).

MICHIGAN STRUCTURE INSPECTION MANUAL
BRIDGE INSPECTION – ROUTINE AND CONDITION BASED IN-DEPTH INSPECTION

Table 5.18.06 Recommended Condition Based In-Depth Inspection Guideline for Piers

NBI Rating	Schedule Initial In-depth Within	In-Depth Frequency	Applicable Materials		
5	24 Months	48 Months	Concrete	Steel	Timber
≤ 4	12 Months	36 Months	Concrete	Steel	Timber

When a lane closure is necessary to perform the inspection because of safety concerns the bridge owner will be notified prior to performing the work. At a minimum, it is expected that the locations where materials have been coded in Condition State 4, and other areas that display the greatest degree of distress will be inspected. In-depth inspections over navigable water may require U.S. Coast Guard notification and consent prior to performing the work.

Approval for each in-depth inspection should be documented through the submittal of an RFA to the bridge owner using MiB^{RIDGE}. When the inspection is performed immediately in response to public safety concerns the inspection should be referenced on an RFA submitted after the work has been completed. These processes are necessary for confirming that the work has been completed and will be reviewed annually during QA and FHWA NBIP reviews.

In-depth inspection requirements of the piers will vary according to the type of defects identified or suspected. When severe cracking or spalling is recognized below bearings this inspection may consist of sounding the surfaces and estimating the percentage of loss below each masonry plate. Inspection of submerged surfaces will require wade and probe, boat and probe, or underwater diving to confirm and verify the limits of scour. Suspected settlement, displacement, or rotation may require regular monitoring through the use of survey or specialized equipment. Observed corrosion or decay on steel and timber bents, usually at the normal water surface elevation, generally require verification that the remaining section has adequate capacity. In each case, the scope of the inspection should adequately determine the severity of the defects present and ensure safety of the motoring public.

The minimum information included in the in-depth inspection report shall be a sketch of the areas examined with measured defects provided for each substructure unit. Areas that were not examined because defects were not observed shall also be delineated on the drawing for future consideration. The level of detail provided must allow for an efficient recurrent in-depth inspection to be conducted in order to determine if the condition of the substructure has changed. Photographs of the deficient areas should accompany the sketch and written report findings. Upon completion of an in-depth inspection that is completed in response to NBI condition ratings, the BSIR and element report should also be modified to reflect the data gathered when changes in the condition ratings are required.

MICHIGAN STRUCTURE INSPECTION MANUAL
BRIDGE INSPECTION – ROUTINE AND CONDITION BASED IN-DEPTH INSPECTION

5.19 Slope Protection (BSIR #15)

This section relates to the physical condition of the slope protection ahead of and on the sides of abutments for bridges that do not cross water. Protection of abutments at water crossings shall be evaluated in the Channel (Item 61, BSIR #20) rating. This rating could have impact on the evaluation and the rating assigned to BIR #13 Abutments, especially in cases where loss of fill supporting a spread footing is observed (see Figure 5.19.01).



Figure 5.19.01 Loss of Approach Roadway Embankment Fill

5.19.01 Slope Protection Routine NBI Inspection

The team leader shall perform the procedures listed for the routine inspection of slope protection and review applicable BIRM sections for additional considerations during the inspection.

1. Inspect concrete slope protection blocks and headers for cracking, scaling, or spalling. If deficiencies are identified document the approximate location and estimated area affected.
2. Inspect grouted or regular riprap for effectiveness or damage. Document the approximate location and estimated area affected where grout is failing or the protection system has limited effectiveness.
3. Inspect the slope protection for erosion or undermining. Document the approximate location where erosion of the substrate has caused a void or settlement of the material.

MICHIGAN STRUCTURE INSPECTION MANUAL
BRIDGE INSPECTION – ROUTINE AND CONDITION BASED IN-DEPTH INSPECTION

The evaluation of slope protection shall conform to the summarized conditions provided in Table 5.19.01. The MDOT Bridge Safety [NBI Rating Guidelines](#) shall be used to assign an overall code to condition of the entire area present. Since this rating has been reclassified for bridges that do not span a waterway, the Item 113 rating will not have an effect on condition rating of the substructure.

Table 5.19.01 Summarized Slope Protection Rating Guidelines

Good	Minor deterioration and/or cracking of the materials. Slope protection will function as designed.
Fair	Moderate cracking, scaling, scattered spalls, or minor settlement. Slope protection will function as designed.
Poor	Considerable cracking, scaling, scattered spalls, and partial settlement. Slope protection will continue to function as designed.
Serious	Considerable deterioration affecting the primary materials. Slope protection repairs or other corrective action should be scheduled.
Critical	Limited effectiveness due to undermining or deterioration of the materials.

5.19.02 Slope Protection Michigan Bridge Element Inspection

Michigan Bridge Elements do not exist for slope protection of bridges that do not cross waterways.

5.19.03 Slope Protection Work Recommendations

The team leader should provide work recommendations for patching or repair of deficient or undermined slope protection.

5.19.04 Slope Protection Request for Action

Submit an RFA to the bridge owner when erosion or undermining of the slope protection is observed.

5.19.05 Slope Protection In-Depth Inspection

Slope protection does not usually require an in-depth inspection as the deficiencies may be readily evaluated during a routine inspection. If an in-depth inspection is ever required review the BIRM and document the work performed in the same manner as other components included within this manual.

MICHIGAN STRUCTURE INSPECTION MANUAL
BRIDGE INSPECTION – ROUTINE AND CONDITION BASED IN-DEPTH INSPECTION

5.20 Approach (BSIR #16)

The purpose of the approach is to provide a smooth transitional surface from the pavement to the supported deck. The section may be composed of reinforced concrete, HMA, composite pavement, or other materials that are suitable for the location. Material selection is dependent on site specific locations, ADT considerations, and the bridge design. Settlement, incorrect vertical alignment, or poor construction quality may lead to additional impact that accelerates deck deterioration (see Figure 5.20.01).



Figure 5.20.01 Approach Slab Settlement at Pavement Seat

5.20.01 Concrete Approach NBI Routine Inspection

Concrete approaches may be grouped into two categories; sliding slabs that are integral with the structural deck and bear on a sleeper slab that is located at the termination of the pavement section, and approach slabs which bear on a formed pavement seat in the abutment. The majority of sliding approach slabs are 20 feet in length, but shorter ones are present at many locations in urban areas due to geometrical constraints caused by adjacent service routes. An expansion joint device located at the sleeper slab accommodates expansion of the superstructure. Stationary approach slabs are usually 20 feet or greater in length and incorporate one or more fiber filled joints to accommodate expansion of the pavement, while superstructure expansion occurs at a location within the supported structure. The team leader shall perform the procedures provided for the routine inspection of approaches and review Chapter 2 of the BIRM.

MICHIGAN STRUCTURE INSPECTION MANUAL
BRIDGE INSPECTION – ROUTINE AND CONDITION BASED IN-DEPTH INSPECTION

1. Inspect the approach for cracking. Document the approximate location, orientation, width, and spacing of the cracking.
2. Inspect the approach for spalling. When exposed reinforcement or deep pot holing is observed evaluate the area to determine if it poses a safety hazard to motorists and warrants an immediate action. Document the approximate location and estimated percentage of the approach affected.
3. Inspect the concrete wearing surface for scaling. Document the approximate location, percentage of deck area affected, and average estimated depth of scaling.
4. Inspect the approach and sleeper slab (if applicable) for settlement. Document the location and estimated amount of settlement.
5. Record photos of deficiencies when changes in the condition rating occurs and perform any necessary follow-up activities with the bridge owner when necessary.

The evaluation of concrete approaches shall conform to the summarized conditions provided in Table 5.20.01. The MDOT Bridge Safety [NBI Rating Guidelines](#) shall be used to assign an overall code to condition of the entire area present. Since this rating has been reclassified for bridges that do not span a waterway, the Item 113 rating will not have an effect on condition rating of the substructure.

Table 5.20.01 Summarized Concrete Approach Rating Guidelines

Good	Open cracks less than 1/16" or sealed cracks spaced at 10' or more. Light shallow scaling or raveling allowed on the surface. Approach pavement will function as designed.
Fair	Excessive cracking or heavy scaling up to 1" deep. Spalling, delamination, or unsound repairs affecting between 2% and 10% of the area. Settlement of the slab or pavement is less than 3/4" at the bridge seat or sleeper slab.
Poor	Spalling, delamination, or unsound repairs affecting between 10% and 25% of the area. Settlement of the slab or pavement is more than 3/4" at the bridge seat or sleeper slab.
Serious	Spalling affecting more than 25% of the surface area. Settlement of the slab or pavement impacts ride quality. Emergency repairs may be required.
Critical	Emergency approach repairs required for the bridge to remain open.

5.20.02 Concrete Approach Michigan Bridge Element Inspection

Element level information shall be collected for all concrete approaches using the Michigan Bridge Element Inspection Manual condition state definitions. The quantity to be collected includes the area from edge to edge and reference line to termination. When the termination of the slab cannot be identified because of an HMA overlay or other obstruction the length of evaluation shall be 25 feet. Element 320 (Prestressed Concrete Approach Slab) shall be used for all prestressed or post tensioned slabs. When only conventional mild reinforcement is used Element 321 (Reinforced Concrete Approach

MICHIGAN STRUCTURE INSPECTION MANUAL
BRIDGE INSPECTION – ROUTINE AND CONDITION BASED IN-DEPTH INSPECTION

Slab) shall be used. The only wearing surface element that shall be collected is Element 818 (Asphalt Overlay w/out Membrane). Do not collect element and condition state information for thin overlay wearing surfaces or healer sealer concrete protective coatings.

Approach elements are BMEs that were created for improved deterioration modeling, analysis, and planning efforts. Quantities and condition state information are reported to FHWA on an annual basis. The data provided must be accurate as it will be evaluated during future quality assurance and NBIP reviews.

5.20.03 HMA Approach Routine NBI Inspection

The use of HMA for approaches is generally limited to rural locations and bridges where expansion is accommodated between the supported slabs or through a fully integral design. The removal and replacement of the material is rapid compared to concrete but shortcomings exist including reduced durability. The team leader shall perform the procedures provided for the routine inspection of HMA approaches and review Chapter 2 of the BIRM.

1. Inspect the bituminous approach for cracking. Document the approximate location, orientation, width and spacing of the cracking.
2. Inspect the bituminous approach for potholing. If exposed reinforcement or deep potholing is observed evaluate the area to determine if it poses a safety hazard to motorists and warrants an immediate action. Document the approximate location, percentage of deck area affected, and depth (if applicable) of spalling.
3. Inspect the bituminous approach for longitudinal joint failure. Document the approximate location and length of failure.
4. Inspect the bituminous approach for rutting, shoving, or raveling. Document the approximate location, type of defect, and percentage of deck area affected.
5. Record photos of deficiencies when a change in the condition rating occurs and review the in-depth inspection procedures for suggested follow-up activities.

The evaluation of slope protection shall conform to the summarized conditions provided in Table 5.20.02. The MDOT Bridge Safety [NBI Rating Guidelines](#) shall be used to assign an overall code to condition of the entire area present. Since this rating has been reclassified for bridges that do not span a waterway, the Item 113 rating will not have an effect on condition rating of the substructure.

MICHIGAN STRUCTURE INSPECTION MANUAL
BRIDGE INSPECTION – ROUTINE AND CONDITION BASED IN-DEPTH INSPECTION

Table 5.20.02 Summarized HMA Approach Rating Guidelines

Good	Cracks at spacing of 50' or more. Minor deformations with no spalling, segregation, or longitudinal joint failure. Light shallow scaling or raveling allowed on the surface. Approach pavement will function as designed.
Fair	Block cracking, raveling, and other deterioration present throughout affecting between 2% and 10% of the area. Settlement of the slab or pavement is less than 3/4" at the bridge seat or sleeper slab.
Poor	Block cracking, raveling, other deterioration present throughout affecting between 10% and 25% of the area. Settlement of the slab or pavement is more than 3/4" at the bridge seat or sleeper slab.
Serious	Spalling affecting more than 25% of the surface area. Ride quality may be impacted. Settlement of the slab or pavement impacts ride quality. Emergency repairs may be required.
Critical	Emergency approach repairs required for the bridge to remain open.

5.20.04 HMA Approach Michigan Bridge Element Inspection

Michigan Bridge Elements do not exist for approaches composed solely of HMA.

5.20.05 Approach Work Recommendations

Recommendations to resolve approach defects should be provided, especially for slabs that are integral with the deck. Repairs for slab and/or sleeper slabs that have settled are important as the decreased ride quality may also adversely affect the condition of the bridge if they are not mitigated. Several examples of items that work to resolve or delay additional deterioration when the approach is in fair or good condition are provided below in Table 5.20.03.

Table 5.20.03 Work Recommendations for Approaches

Approach Slab		
Recommendation	Defects	Additional Information
Approach Slab Patching	Spalling, greater than 1" deep or 6" diameter	Recommend when ride quality is impacted
Approach Slab Mudjacking	Settlement	Recommend when ride quality is impacted
Approach HPR or Overband Crack Seal	Cracking, spaced at 50' or greater	Generally effective for less than 5 years
Approach HMA Patching	Spalling, does not extend to structural deck	Improves Item 58B and element ratings

MICHIGAN STRUCTURE INSPECTION MANUAL
BRIDGE INSPECTION – ROUTINE AND CONDITION BASED IN-DEPTH INSPECTION

5.20.06 Approach Request for Action

Submit an RFA to the bridge owner when significant undermining, spalling, or settlement has occurred that severely impacts ride quality or is an inherent hazard for public safety.

5.20.07 Approach In-Depth Inspection

Approach slabs rarely require an in-depth inspection as the deficiencies may be readily evaluated during a routine inspection. If an in-depth inspection is ever required review the BIRM and document the work performed in the same manner as other components included within this manual.

5.21 Approach Shoulders and Sidewalks (BSIR #17)

The purpose of this item is to evaluate and rate the overall condition of the approach shoulders, sidewalks, and curbs and gutters. It includes those shoulders that are carried across the structure on grade.

5.21.01 Approach Shoulders and Sidewalks Routine NBI Inspection

The team leader shall perform the procedures provided for the routine inspection of approach shoulders and sidewalks and review Chapter 2 of the BIRM.

1. Inspect concrete, HMA, or gravel shoulders and sidewalks for adequate slope to permit drainage.
2. Inspect concrete or HMA shoulders and sidewalks for excessive cracking.
3. Inspect concrete or HMA shoulders and sidewalks for scaling, spalling, raveling, and potholing.
4. Inspect concrete or HMA shoulders and sidewalks for excessive settlement.
5. Inspect sidewalks for defects that present a hazard to pedestrians.
6. Document the approximate location and type of any significant defects that affect the performance of approach shoulders and sidewalks.

The evaluation of approach shoulders and sidewalks shall conform to the summarized conditions provided in Table 5.21.01. The MDOT Bridge Safety [NBI Rating Guidelines](#) shall be used to assign an overall code to condition of the entire area present. The inspector must note in the comment field on the BSIR the factors and quantities that influenced the judgment for the rating.

MICHIGAN STRUCTURE INSPECTION MANUAL
BRIDGE INSPECTION – ROUTINE AND CONDITION BASED IN-DEPTH INSPECTION

Table 5.21.01 Summarized Approach Shoulders and Sidewalks Rating Guidelines

Good	Minor deterioration or wear on the approach shoulders, sidewalks, and curb and gutter. All components will function as designed.
Fair	Moderate deterioration or wear on the approach shoulders, sidewalks, and curb and gutter. Settlement is less than 3/4 inches at the bridge seat. All components will function as designed.
Poor	Considerable deterioration or wear on the approach shoulders, sidewalks, and curb and gutter. Settlement is more than 3/4 inches at the bridge seat. All components will function as designed.
Serious	Serious deterioration or wear on the approach shoulders, sidewalks, and curb and gutter. Urgent surface repairs may be required by the crews.
Critical	Deterioration has progressed to the point where the approach shoulders, sidewalks, and curb and gutter will not function as designed. Emergency repairs may be required by the crews.

5.21.02 Approach Shoulders and Sidewalks Michigan Bridge Element Inspection

Michigan Bridge Elements are not required for the majority of approach shoulders and sidewalks; however, element level information shall be collected pedestrian bridge approach span(s) to the main span(s) of the pedestrian structure. Element 858 (Concrete Pedestrian Approach) and Element 859 (Steel Pedestrian Approach) shall be used to provide element level information for the entire ramp or staircase. Multiple condition state tables may be referenced to determine condition state quantities.

5.21.03 Approach Shoulders and Sidewalks Work Recommendations

Provide work recommendations for approach shoulders and sidewalks that are in poor condition.

5.21.04 Approach Shoulders and Sidewalks Request for Action

Submit an RFA to the bridge owner when an inherent hazard exists for pedestrian safety.

5.21.05 Approach Shoulders and Sidewalks In-Depth Inspection

Approach shoulders and sidewalks rarely require an in-depth inspection as the deficiencies may be readily evaluated during a routine inspection. If an in-depth inspection is required review the BIRM and document the work performed in the same manner as other components included within this manual.

MICHIGAN STRUCTURE INSPECTION MANUAL
BRIDGE INSPECTION – ROUTINE AND CONDITION BASED IN-DEPTH INSPECTION

5.22 Approach Slopes (BSIR #18)

Approach slopes are vulnerable to erosion from surface runoff during heavy precipitation events or when failure of buried storm water discharge pipes occurs (see Figure 5.22.01).



Figure 5.22.01 Washout Discovered Near Approach While Performing Deck Patching

5.22.01 Approach Slopes Routine NBI Inspection

This item is for noting poor characteristics or situations associated with the road approach slopes. There is no rating scale. The inspector can note in the comments if there are washouts, erosion that can affect the guardrail supports or the road shoulders. Evidence of erosion of the slopes that affect the stability of the abutments should be reported in the condition rating of the Abutments (BSIR #12).

5.22.02 Approach Slopes Michigan Bridge Element Inspection

Michigan Bridge Elements do not exist for approach slopes.

5.22.03 Approach Slopes Work Recommendations

Provide work recommendations when required to mitigate minor or moderate erosion.

5.22.04 Approach Slopes Request for Action

Submit an RFA to the bridge owner when severe erosion or undermining of the approach slope is observed.

5.22.05 Approach Slopes In-depth Inspection

Approach slopes rarely require an in-depth inspection as the deficiencies may be readily evaluated during a routine inspection. If an in-depth inspection is required review the BIRM and document the work performed in the same manner as other components included within this manual.

MICHIGAN STRUCTURE INSPECTION MANUAL
BRIDGE INSPECTION – ROUTINE AND CONDITION BASED IN-DEPTH INSPECTION

5.23 Utilities (BSIR #19)

The type of utilities attached to MDOT or local agency owned bridges may include phone, electric, water, gas, and others. When distress is observed to the utility casing or attachment hanger the utility owner and bridge owner should be notified. To determine the owner of utilities attached to MDOT owned bridges contact the jurisdictional Transportation Service Center for information.

5.23.01 Utilities Routine NBI Inspection

This item is for noting poor characteristics of utilities attached to and affecting the bridge. There is no rating scale. The inspector can note in the comment field the situations observed.

5.23.02 Utilities Michigan Bridge Element Inspection

Element level information shall be collected for overhead adhesive anchors that are in sustained tensile-load. Use of these anchors is chiefly limited to vertical hangers attached to bridge decks for utilities and traffic signals. This action is necessary and required in response to a National Transportation Safety Board memorandum following failure of the anchors. Element 880 (Adhesive Anchors, Overhead) has been created to develop an inventory and provide condition state information for these types of attachments. The quantity to be collected includes each connection location, which may contain one or more adhesively anchored rods, bolts, or bar (see Figure 5.23.01).



Figure 5.23.01 Telephone Conduit Banks with overhead Adhesive Anchors

5.23.03 Utilities Work Recommendations

Recommendations should not be entered for utilities. When defects are present that influence functionality the utility owner should be contacted.

MICHIGAN STRUCTURE INSPECTION MANUAL
BRIDGE INSPECTION – ROUTINE AND CONDITION BASED IN-DEPTH INSPECTION

5.23.04 Utilities Request for Action

An RFA shall be submitted to the bridge owner when distress is observed on the attachment or primary housing material that endangers public safety.

5.23.05 Utilities In-Depth Inspection

In-depth inspection of utilities is usually not required. When deficiencies are identified that affect the utility then the owner shall be notified and additional actions coordinated.

MICHIGAN STRUCTURE INSPECTION MANUAL
BRIDGE INSPECTION – ROUTINE AND CONDITION BASED IN-DEPTH INSPECTION

5.24 Channel (BSIR #20)

Proper channel inspection and rating is as vital as thorough evaluation of structural bridge components. Changes to the stream stability and condition may affect the velocity of water through the opening, create widespread or isolated locations of erosion, and cause realignment of the stream. The solitary or combined affects may require timely repair to prevent bridge closure or immediate action.



Figure 5.24.01 Debris Accumulation Should Be Included in the Channel Rating

5.24.01 Channel Routine NBI Inspection

Scour and accumulation of debris on the superstructure or substructure may cause damage severe enough to affect the condition of these components and should be documented on the appropriate item of the BSIR 9, 13, &14 (SI&A Items 59 or 60) and included in the condition rating of the Channel (see Figure 5.24.01). This item is for noting condition of the channel, riprap, slope protection of bridges over water, or stream control devices. The team leader shall perform the procedures provided for the routine inspection of the channel and review Chapter 13 of the BIRM.

1. Inspect the channel bank protection for sloughing due to undercutting. Document the approximate location and describe the severity.
2. Inspect the channel misalignment or lateral movement. Document the relative change and degree to which it is impacting the structure.
3. Inspect the channel bank and river control devices for damage. Document the approximate location and describe the severity.

MICHIGAN STRUCTURE INSPECTION MANUAL
BRIDGE INSPECTION – ROUTINE AND CONDITION BASED IN-DEPTH INSPECTION

4. Inspect the channel bank for undermining. Document the approximate location and describe the severity.
5. Inspect the channel for debris built up along or impacting the substructure elements. Document the location and describe the severity.
6. Record photos of deficiencies when a change in the condition rating occurs and review the in-depth inspection procedures for suggested follow-up activities.

The evaluation of the channel shall conform to the summarized conditions provided in Table 5.24.01. The MDOT Bridge Safety [NBI Rating Guidelines](#) shall be used to assign an overall code to condition of the entire area present. The inspector must note in the comment field on the BSIR the factors and quantities that influenced the judgment for the rating.

Table 5.24.01 Summarized Channel Rating Guidelines

Good	Bank protection is in need of minor repairs. River control devices and embankment protection have a little minor damage. Banks and/or channel, have minor amounts of drift.
Fair	Bank protection is being eroded. River control devices and/or embankment have major damage. Trees and brush restrict the channel.
Poor	Bank and embankment protection is severely undermined. River control devices have severe damage. Large deposits of debris are in the channel.
Serious	Bank protection has failed. River control devices have been destroyed. Streambed, aggradation, degradation or lateral movement has changed to threaten the bridge and/or approach roadway now.
Critical	The channel has changed to the extent the bridge is near a state of collapse.

5.24.02 Channel Michigan Bridge Element Inspection

Michigan Bridge Elements do not exist for the channel. Element level information for installed scour countermeasures shall be evaluated and collected during inspection of the abutments or piers.

5.24.03 Channel Work Recommendations

Recommendations for river control devices should not be provided during routine inspections. Installation of spur dikes or other devices to control the channel should be reviewed by a hydraulics engineer as improper placement may increase the rate of erosion. When the channel is rated in fair or poor condition the team leader may provide a recommendation for evaluation of devices or countermeasures that stabilize or improve the channel.

Prioritize work recommendations according to the general guidelines provided below. Reference the element, location, and describe the extent of rehabilitative measures required. Submit a Request for Action (RFA) for any activity that should be completed prior to the next scheduled routine inspection.

MICHIGAN STRUCTURE INSPECTION MANUAL
BRIDGE INSPECTION – ROUTINE AND CONDITION BASED IN-DEPTH INSPECTION

High Priority Work Recommendations

Any structural repairs or replacement of bridge elements that should be completed within 24 to 60 months. High Priority work recommendations consist of any activity that will function to maintain safe load carrying capacity or preserve existing primary component condition ratings.

Medium Priority Work Recommendations

Any structural or non-structural repairs that should be completed within 24 to 60 months. Medium priority work recommendations serve to improve existing component and element condition ratings that are currently in fair or better condition.

Low Priority Work Recommendations

Any repairs that should be scheduled in conjunction with other planned work at the structure. Low priority work recommendations may have little to no effect on primary component condition ratings.

5.24.04 Channel Request for Action

An RFA should be submitted to the bridge owner when serious concerns exist for the condition of the channel and its influence on the stability of the structure. Conditions that require immediate actions that result in bridge closure due to scour should be documented per [Chapter 10, Critical Findings](#).

5.24.05 Channel In-Depth Inspection

The elevation of the river bed relative to an established datum must be measured for all structures over water. These measurements must be taken at the previous locations along the length of the bridge that is over water and recorded on the Steam Cross Section Report form. This information must be compared to the previous data, if available, in the form of a graph. Cross-sections shall be completed along the upstream and downstream face of the structure. Additional cross sections at additional distances upstream and downstream may be needed to determine the overall stability of the channel.

Channel Cross Sections should be obtained per the recommendations shown in MDOT's [Guidelines for Bridge Inspection Frequencies](#). Scour critical bridges with active erosion or observed scour should have cross sections recorded every two years or after a flood event where the scour POA was reviewed and monitoring occurred. For scour critical bridges without active erosion or observed scour the cross sections should be performed every four years or after a flood event where the scour POA was reviewed and monitoring occurred. Bridges with minor observed scour or erosion must have a minimum of one cross section in the file; including additional cross sections as changes in the channel are observed and every 60 months for locations requiring underwater diving. For structures over water without substructures in the water and no channel erosion a minimum of one cross-section must be in the file with additional ones as changes occur.

**MICHIGAN STRUCTURE INSPECTION MANUAL
BRIDGE INSPECTION – ROUTINE AND CONDITION BASED IN-DEPTH INSPECTION**

5.25 Drainage Culverts (BSIR #21)

This item is for noting damage or poor drainage characteristics in the approach drains. There is no rating scale. The inspector can note in the comments if there is ponding of water at the casting due to buildup of debris or erosion of approach fill into the manhole (see Figure 5.25.01).



Figure 5.25.01 Settled Approach Basin Full of Debris

MICHIGAN STRUCTURE INSPECTION MANUAL
BRIDGE INSPECTION – ROUTINE AND CONDITION BASED IN-DEPTH INSPECTION

5.26 BSIR Other Items

The BSIR includes additional appraisal and distinct inspection items. With the advent of Michigan Bridge Element Inspection, and the anticipated changes that are to be scheduled for the BSIR, the items for temporary supports and high load hit will eventually be eliminated. Until the changes have been implemented with MiB^{RIDGE} continue to code all of the Other Items during each routine inspection.

5.26.01 Waterway Adequacy (SI&A Item 71)

This item is for appraising the waterway opening with respect to the passage of flow through the bridge. The evaluation accounts for the functional classification in conjunction with the frequency for overtopping and traffic delays (see Table 5.26.01). During the appraisal coding the team leader shall consider the velocity of the flow that is anticipated. Where the rise in the water level occurs slowly during flood events, usually at locations outside of the primary channel that drains the watershed, the appraisal rating may be adjusted according to engineering judgment.

Table 5.26.01 SI&A Item 71 Waterway Adequacy Appraisal Table

Functional Classification			Description
Principal Arterials - Interstates, Freeways, or Expressways	Other Principal Arterials and Major Collectors	Minor Collectors, Locals	Code
N	N	N	Bridge not over a waterway.
9	9	9	Bridge deck and roadway approaches above flood water elevations (high water). Chance of overtopping is remote.
8	8	8	Bridge deck above roadway approaches. Slight Chance of overtopping roadway approaches.
6	6	7	Slight chance of overtopping bridge deck and roadway approaches.
4	5	6	Bridge deck above roadway approaches. Occasional overtopping of roadway approaches with insignificant traffic delays
3	4	5	Bridge deck above roadway approaches. Occasional overtopping of roadway approaches with significant traffic delays
2	3	4	Occasional overtopping of bridge deck and roadway approaches with significant traffic delays.
2	2	3	Frequent overtopping of bridge deck and roadway approaches with significant traffic delays.
2	2	2	Occasional or frequent overtopping of bridge deck and roadway approaches with severe traffic delays.
0	0	0	Bridge closed.

MICHIGAN STRUCTURE INSPECTION MANUAL
BRIDGE INSPECTION – ROUTINE AND CONDITION BASED IN-DEPTH INSPECTION

5.26.02 Approach Roadway Alignment (SI&A Item 72)

This item is to rate the sufficiency of the approach roadway alignment in comparison to the overall adjoining route. The coding should take into consideration whether a vehicle speed reduction is required solely due to the structure alignment. Poor ratings are reserved for substantial speed reductions, Fair ratings minor speed reductions, and Good ratings for no speed reductions.

5.26.03 Temporary Support or Conditions (SI&A Item 103, BSIR Other Item)

The coding of this item indicates where temporary structures or conditions exist. This includes bridges with engineered temporary supports in-place that may be full or short height. For structures requiring these temporary supports to allow legal loads or unrestricted traffic to cross the structure, SI&A Item 103 (Temporary Conditions) must be coded "T" and SI&A Item 41 (Open, Posted, Closed Status) must be coded "D".

5.26.04 High Load Hit

This item is for identifying Type II or Type III impact damage. See MiSIM [Chapter 9, Damage Inspection](#) for additional details for documenting damage.

5.26.05 Special Inspection Equipment

This item is for identifying special inspection equipment that should be used during routine inspection. Additional information or basic items such as binoculars and specific areas that require this type of equipment should be documented in the "General Notes" section of the BSIR.

5.26.06 Underwater Inspection Method (SI&A Item 176)

This item is for noting the type of Underwater Inspection that is conducted at the bridge site. All structures crossing a waterway must document the underwater inspection method required. In general, the coding for Underwater Inspection Method (SI&A Item 176) should comply with the following methods and water depths:

- 0) Not required – Where all substructures are on dry land
- 1) Wade and Probe – Water depths of 4 feet or less
- 2) Boat and Probe – Water depths of 4 feet to 10 feet
- 3) Underwater Diving Inspection – Water depths exceeding 10 feet