

**State Vehicle Purchasing Program
VEHICLE PACKET**

FOR

MEDIUM CLASS OF BUSES

7 years/200,000 miles

**Non-lift buses - Lift buses with Alternate Floor Plans
(26, 29, and 32 Foot Buses, Respectively)**



From August 10, 2023 to August 9, 2025

STATE OF MICHIGAN



**Office of Passenger Transportation
Program Administration Section**

Contents

I. INTRODUCTION.....	3
II. ORDERING AND SERVICE INFORMATION	4
III. VEHICLE INFORMATION	5
Medium Class of Buses Floor Plans	5
Bus Color Sheet – Class 1: Ford	8
Bus Color Sheet – Class 2: International.....	9
Bus Color Sheet – Class 2: Freightliner	10
Bus Title and Delivery Information	11
IV. ACCEPTANCE/INSPECTION CHECKLIST.....	188

I. Introduction

Purpose

This packet contains vehicle ordering information and related forms for purchasing from the State Vehicle Purchasing Program.

Instructions

1. Please read the *State Vehicle Purchasing Program Guidelines* (available on the MDOT website) before ordering any vehicle. These *Guidelines* provide information, procedures, and a checklist to assist with a vehicle purchase.
2. Complete the Bus Color Sheet (if ordering stripes and/or colors), Bus Title and Delivery Information, and New Vehicle Order Form (found on the MDOT State Vehicles & Contracts website under “Medium Bus”).
3. Submit the completed forms (section III) to the vendor.
4. After receiving the vehicle, complete the Post Delivery Audit Work Sheets (section IV).

II. Ordering and Service Information

- To order a medium bus, complete the separate New Vehicle Order Form (found on the MDOT State Revenue Vehicle Contracts & Revenue Vehicle Procurement website under “Medium Bus”) for the respective bus vendor.

Vendor	Hoekstra Transportation Class I & II Metal Gage Body	TESCO Class I & II Metal Cage Body
State Vehicle Purchasing Program Contract #	230000001329	230000001331
Funding Sources	100% paid State and Federal except optional equipment purchased outside of the contract	100% paid State and Federal except optional equipment purchased outside of the contract
Order Contact	Steve Bolin Commercial Products Manager/Contract Admin. Hoekstra Transportation, Inc. 3741 Roger B Chaffee Blvd. Grand Rapids, MI 49548 (616) 389-1130 Office (616) 299-5170 Mobile (616) 245-7726 Fax Sbolin@Hoekstrainc.com	Blair Taseff Regional Account Manager/Contract Admin. Transportation Equipment Sales Corp. (TESCO) 6401 Seaman Road PO Box 167230 Oregon, OH 43618 800-227-3572 Office 440-653-0193 Mobile 419-836-8460 Fax btaseff@tescobus.com
Service Contact	Matt Reiffer Service Manager 3741 Roger B Chaffee Memorial Dr Grand Rapids, Michigan 49548 (616) 245-7440 or (800) 444-4104 ext 1125 Fax: (616) 245-7726 mreiffer@Hoekstrainc.com	Josh Wise Warranty Manager 6401 Seaman Rd Oregon, Ohio 43616 419-720-7471 1-800-227-3572 Jwise@tescobus.com
Manufacturer	Champion Bus Mark Husted Government Bid Sales 2367 Century Drive Goshen, IN 46528 (810)569-9785 Fax (810)724-6478 E-mail: mhusted@forestriverinc.com	Glaval Bus Don Hasty 914 Co Rd 1 Elkhart, IN 46514 1-800-748-7440 X52168 Email dhasty@forestriverinc.com

State of Michigan Contacts

MDOT	Jeff Turner Office of Passenger Transportation (517) 335-3282 Fax: (517) 373-7997 E-mail: turnerj3@michigan.gov	Rob Pearson Office of Passenger Transportation (517) 335-0904 Fax: (517) 373-7997 E-mail: pearsonr1@michigan.gov
-------------	---	---

III. Vehicle Information

Medium Class of Buses Floor Plans

26 Foot

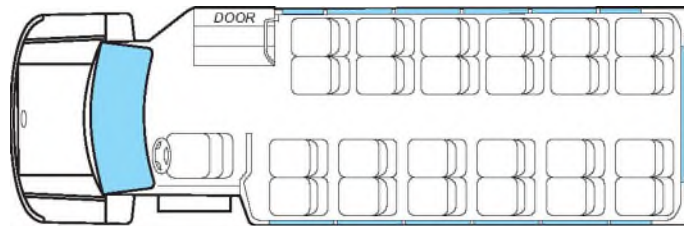

A. 24 Passenger bus without lift



B. 14+2 Passenger bus with lift



C. 10+3 Passenger bus with lift

29 Foot

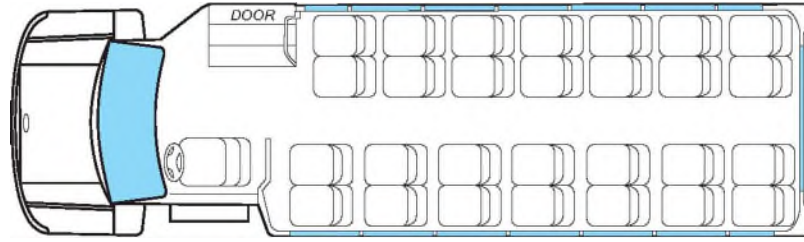

D. 28 Passenger bus without lift

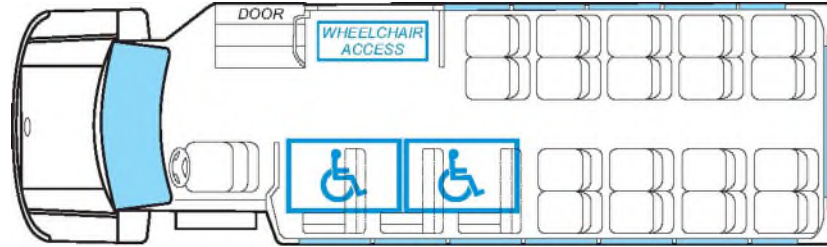

E. 18+2 Passenger bus with lift



F. 14+3 Passenger bus with lift



G. 10+4 Passenger bus with lift

32 Foot

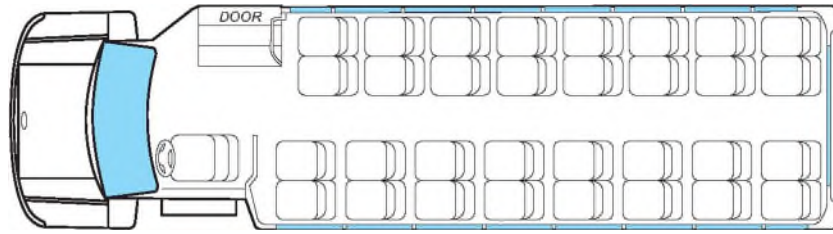

H. 32 Passenger bus without lift

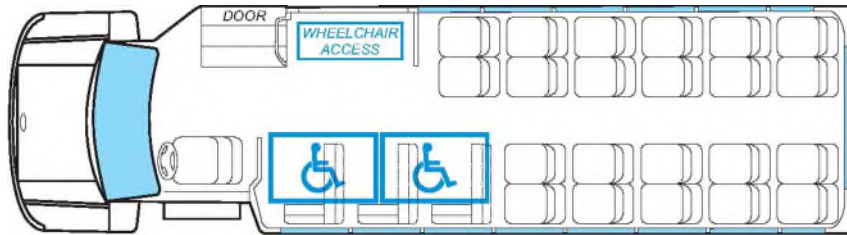

I. 22+2 Passenger bus with lift



J. 18+3 Passenger bus with lift



K. 14+4 Passenger bus with lift

Bus Color Sheet – Class I: Ford

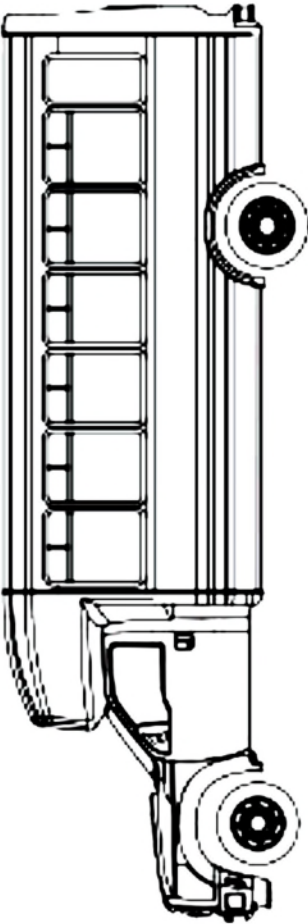
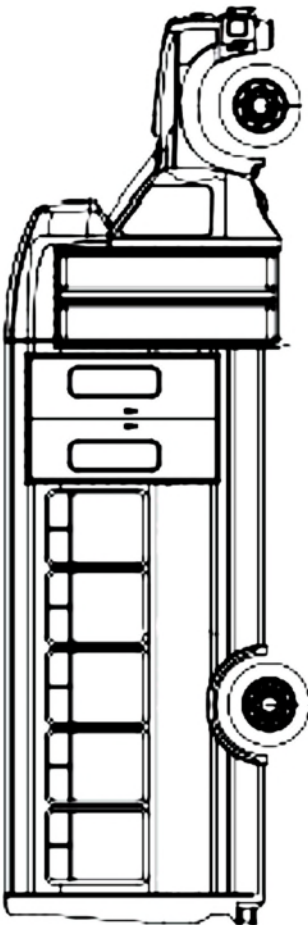
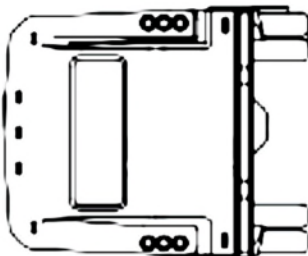
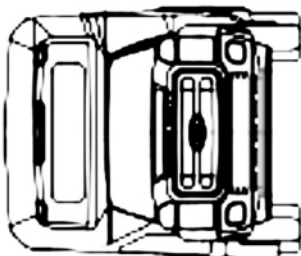

Bus Color Sheet – Class II: International

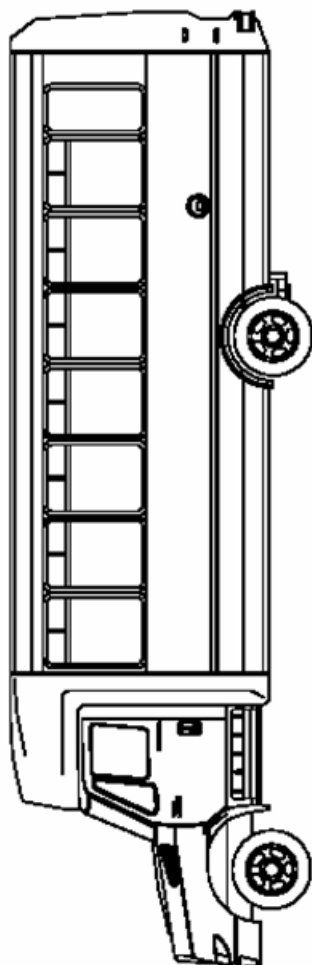
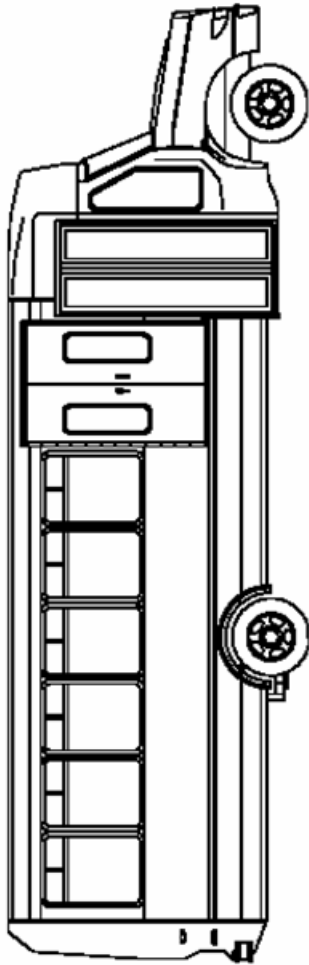
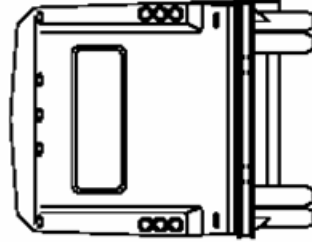
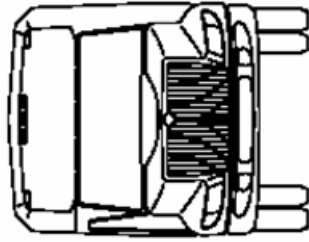

Bus Color Sheet – Class II: Freightliner

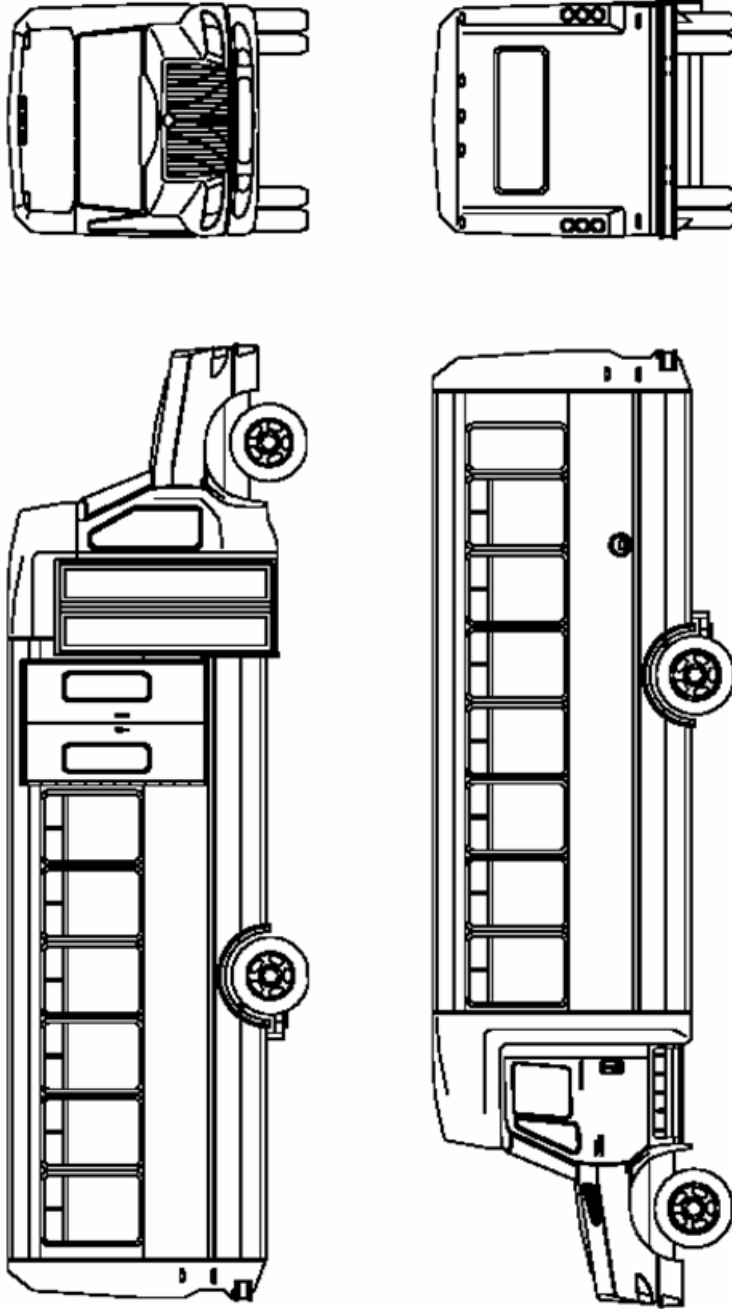

Vehicle Title and Delivery Information

DATE _____

TRANSIT AGENCY _____

CONTRACT NO. _____ FED I.D. # _____

TITLE INFORMATION	
Name of City, County, or Agency	
Street Address (Post Office Box Not Acceptable)	
First Secured Party (if required)	
Tax I.D. Number	Ford FIN Number
City	Zip Code

DELIVERY ADDRESS		
Name of Operating Transit Agency		
Street Address (Post Office Box Not Acceptable)		
City	Zip Code	County
Contact Person	Telephone Number	

**Michigan Department of Transportation
Office of Passenger Transportation
POST-DELIVERY AUDITS**

**ATTACHMENT A-7
CHECKLIST**

Contract #		Vehicle Description	
Dealer		Manufacturer	
Contract Term		Contract Admin.	

Post Delivery Audit

	Item	Completion Date	Initials
1	Buy America Certification stating regulations are still being met, if required*		
2	Bid Certification		
2.1	Vehicle sight inspection		
2.2	Vehicle road test		
2.3	Were there 11 or more vehicles purchased? Yes <input type="checkbox"/> No <input type="checkbox"/>		
2.4	If yes obtain Inspectors report		
2.5	Certification vehicle meets bid specifications		
2.5	Federal Motor Vehicle Safety Standard's certification		

To be completed by transit agency

*Procurements over \$100,000, increasing to \$150,000 for grants awarded December 26, 2014 or later

**Michigan Department of Transportation
Office of Passenger Transportation
POST-DELIVERY AUDITS**

**ATTACHMENT A-8
FEDERAL MOTOR VEHICLE SAFETY STANDARDS CERTIFICATIONS**

Check one that applies:

- The vehicles proposed under this contract are subject to the Federal Motor Vehicle Safety Standards (FMVSS) issued by the National Highway Traffic Safety Administration (NHTSA) in part 571 of this title.

- The vehicles proposed under this contract are not subject to the Federal Motor Vehicle Safety Standards (FMVSS) issued by the National Highway Traffic Safety Administration (NHTSA) in part 571 of this title.

As required by Title 49 of the CFR, Part 663 – Subpart D, I have received a copy of the manufacturer's self-certification information concerning these vehicles compliance with relevant Federal Motor Vehicle Safety Standards. I have had this certification in my possession at both the pre-award and post-delivery stages of the procurement.

	Post-Delivery
Vehicle Description	
Manufacturer	
Agency Contact Name	
Date	

To be completed by transit agency
Vendor to provide Post-delivery FMVSS Certification

**Michigan Department of Transportation
Office of Passenger Transportation
POST-DELIVERY AUDITS**

**ATTACHMENT A-9
BUY AMERICA CERTIFICATION
Post-Delivery**

In Accordance with the "Buy America" regulations adopted by the Federal Transit Administration on January 9, 1991, I certify that the vehicles delivered under this contract are in compliance with the requirements of section 165(b)(3), of the Surface Transportation Assistance Act of 1982, as amended, and the regulations of 49 CFR 661.11.

Date	
Vehicle Description	
Dealer	
Manufacturer	
Agency Contact Name	
Position Title	

To be complete by transit agency

**Michigan Department of Transportation
Office of Passenger Transportation
POST-DELIVERY AUDITS**

**ATTACHMENT A-10
BUY AMERICA POST-DELIVERY AUDIT
Component Parts**

	Component	Supplier/Manufacturer	Address	Country of Origin	Cost or % of Domestic Origin
1					
2					
3					
4					
5					
6					
7					
8					
9					
10					

Vendor:

Vendor's Signature: _____

PLEASE MAKE ADDITIONAL COPIES IF NECESSARY

Completed by vendor – vendor can provide actual domestic content worksheet

**Michigan Department of Transportation
Office of Passenger Transportation
POST-DELIVERY AUDITS**

**ATTACHMENT A-11
BUY AMERICA POST-DELIVERY AUDIT
Sub-component Parts**

	Subcomponent	Supplier/Manufacturer	Address	Country of Origin	Cost or % of Domestic Origin
1					
2					
3					
4					
5					
6					
7					
8					
9					
10					

Vendor:

Vendor's Signature: _____

PLEASE MAKE ADDITIONAL COPIES IF NECESSARY

Completed by vendor – vendor can provide actual domestic content worksheet

**Michigan Department of Transportation
Office of Passenger Transportation
POST-DELIVERY AUDITS**

**ATTACHMENT A-12
BID SPECIFICATION AUDIT CERTIFICATION
Post-Delivery**

I have road tested and visually inspected the vehicle purchased. I certify that the vehicle delivered under this contract meets the contract specifications used for this solicitation.

- There were fewer than eleven vehicles procured under this purchase.

- There were eleven or more vehicles procured under this purchase. A copy of the inspector's report is attached.

Date	
Vehicle Description	
Dealer	
Manufacturer	
Agency Contact Name	
Position Title	

To be completed by transit agency

Complete MDOT Form 3188 – Post-delivery Purchaser’s Requirements Certification

Complete MDOT Form 3189 – Post-delivery FMVSS Compliance Certification

PDF Forms can be found at:

<https://mdotjboss.state.mi.us/webforms/SearchForms.htm?title=&area=Passenger+Transportation-Procurement+Forms&Submit=Search&formNumber=>

IV. Acceptance/Inspection Checklist

Medium Bus Vehicle Acceptance/Inspection Checklist can be found on Office of Passenger Transportation web site:

<https://www.michigan.gov/mdot/travel/mobility/pub-transit/state-vehicle-contracts-and-procurement>