



STATE OF MICHIGAN
CENTRAL PROCUREMENT SERVICES
 Department of Technology, Management, and Budget
 320 S. WALNUT ST., LANSING, MICHIGAN 48933
 P.O. BOX 30026 LANSING, MICHIGAN 48909

CONTRACT CHANGE NOTICE

Change Notice Number **3**
 to
 Contract Number **21000000606**

CONTRACTOR	HOEKSTRA TRANSPORTATION, INC
	3741 Roger B Chaffee
	Grand Rapids, MI 49548
	Steve Bolin
	(616) 299-5170
	sbolin@hoekstratruck.com
	CV0045588

STATE	Program Manager	Jeff Turner	MDOT
		(517) 335-3282	
	Turnerj3@michigan.gov		
	Contract Administrator	Yvon Dufour	DTMB
(517) 249-0455			
dufour@michigan.gov			

CONTRACT SUMMARY

SMALL CLASS OF NON-LIFT AND LIFT TRANSIT BUSES

INITIAL EFFECTIVE DATE	INITIAL EXPIRATION DATE	INITIAL AVAILABLE OPTIONS	EXPIRATION DATE BEFORE
April 1, 2021	March 31, 2023	2 - 1 Year	March 31, 2024

PAYMENT TERMS	DELIVERY TIMEFRAME

ALTERNATE PAYMENT OPTIONS	EXTENDED PURCHASING
<input type="checkbox"/> P-Card <input type="checkbox"/> PRC <input type="checkbox"/> Other	<input checked="" type="checkbox"/> Yes <input type="checkbox"/> No

MINIMUM DELIVERY REQUIREMENTS

DESCRIPTION OF CHANGE NOTICE

OPTION	LENGTH OF OPTION	EXTENSION	LENGTH OF EXTENSION	REVISED EXP. DATE
<input checked="" type="checkbox"/>	one year	<input type="checkbox"/>		March 31, 2025
CURRENT VALUE	VALUE OF CHANGE NOTICE	ESTIMATED AGGREGATE CONTRACT VALUE		
\$45,600,000.00	\$0.00	\$45,600,000.00		

DESCRIPTION

Effective 2/1/2024, the second option year available on this contract is hereby exercised. The revised contract expiration date is 3/31/2025. In addition, the following amendment is hereby incorporated into the contract, inserted in Standard Terms and Conditions as section 8:

8. Extended Purchasing Program. This contract is extended to MiDEAL members. MiDEAL members include local units of government, school districts, universities, community colleges, and nonprofit hospitals. A current list of MiDEAL members is available at www.michigan.gov/mideal. In addition, other States (including governmental subdivisions and authorized entities) are permitted to separately contract with the Contractor for the purchase of buses using the Technical Specifications and Pricing in this Contract, by way of a separate agreement between any such State(s) and Contractor. The separate contract(s) between State(s) and Contractor(s) allows for modifications upon mutual agreement by both parties. Any such separate agreement that Contractor may enter into does not alter this Contract in any way, and the State of Michigan does not become a party to any such agreement and does not assume any liability or responsibilities pertaining to any such separate agreement. With respect to any such contract, Contractor will pay the State of Michigan .25% of all amounts Contractor invoices or bills under that separate contract, regardless of whether Contractor is paid for such invoiced amounts. Contractor will make such payments within 30 calendar days from the last day of each calendar quarters. Contractor must submit invoices to, and receive payment from,

extended purchasing program members on a direct and individual basis.



STATE OF MICHIGAN
CENTRAL PROCUREMENT SERVICES
 Department of Technology, Management, and Budget
 320 S. WALNUT ST., LANSING, MICHIGAN 48933
 P.O. BOX 30026 LANSING, MICHIGAN 48909

CONTRACT CHANGE NOTICE

Change Notice Number 2
 to
 Contract Number 21000000606

CONTRACTOR	HOEKSTRA TRANSPORTATION, INC
	3741 Roger B Chaffee
	Grand Rapids, MI 49548
	Steve Bolin
	(616) 299-5170
	sbolin@hoekstratruck.com
	CV0045588

STATE	Program Manager	Jeff Turner	MDOT
		(517) 335-3282	
	Turnerj3@michigan.gov		
	Contract Administrator	Yvon Dufour	DTMB
(517) 249-0455			
dufour@michigan.gov			

CONTRACT SUMMARY

SMALL CLASS OF NON-LIFT AND LIFT TRANSIT BUSES

INITIAL EFFECTIVE DATE	INITIAL EXPIRATION DATE	INITIAL AVAILABLE OPTIONS	EXPIRATION DATE BEFORE
April 1, 2021	March 31, 2023	2 - 1 Year	March 31, 2023

PAYMENT TERMS	DELIVERY TIMEFRAME

ALTERNATE PAYMENT OPTIONS	EXTENDED PURCHASING
<input type="checkbox"/> P-Card <input type="checkbox"/> PRC <input type="checkbox"/> Other	<input type="checkbox"/> Yes <input checked="" type="checkbox"/> No

MINIMUM DELIVERY REQUIREMENTS

DESCRIPTION OF CHANGE NOTICE

OPTION	LENGTH OF OPTION	EXTENSION	LENGTH OF EXTENSION	REVISED EXP. DATE
<input checked="" type="checkbox"/>	One year	<input type="checkbox"/>		March 31, 2024

CURRENT VALUE	VALUE OF CHANGE NOTICE	ESTIMATED AGGREGATE CONTRACT VALUE
\$45,600,000.00	\$0.00	\$45,600,000.00

DESCRIPTION

Effective 2/6/2023, the first option year available on this contract is hereby exercised. The revised contract expiration date is 3/31/2024. All other terms, conditions, specifications and pricing remain the same. Per DTMB request, agency agreement, and DTMB Procurement approval.



STATE OF MICHIGAN
CENTRAL PROCUREMENT SERVICES
 Department of Technology, Management, and Budget
 320 S. WALNUT ST., LANSING, MICHIGAN 48933
 P.O. BOX 30026 LANSING, MICHIGAN 48909

CONTRACT CHANGE NOTICE

Change Notice Number **1**
 to
 Contract Number **21000000606**

CONTRACTOR	HOEKSTRA TRANSPORTATION, INC
	3741 Roger B Chaffee
	Grand Rapids, MI 49548
	Steve Bolin
	(616) 299-5170
	sbolin@hoekstratruck.com
	CV0045588

STATE	Program Manager	Jeff Turner	MDOT
		(517) 335-3282	
	Turnerj3@michigan.gov		
	Contract Administrator	Yvon Dufour	DTMB
(517) 249-0455			
dufoury@michigan.gov			

CONTRACT SUMMARY				
SMALL CLASS OF NON-LIFT AND LIFT TRANSIT BUSES				
INITIAL EFFECTIVE DATE	INITIAL EXPIRATION DATE	INITIAL AVAILABLE OPTIONS	EXPIRATION DATE BEFORE	
April 1, 2021	March 31, 2023	2 - 1 Year	March 31, 2023	
PAYMENT TERMS		DELIVERY TIMEFRAME		
ALTERNATE PAYMENT OPTIONS			EXTENDED PURCHASING	
<input type="checkbox"/> P-Card <input type="checkbox"/> PRC <input type="checkbox"/> Other			<input type="checkbox"/> Yes <input checked="" type="checkbox"/> No	
MINIMUM DELIVERY REQUIREMENTS				
DESCRIPTION OF CHANGE NOTICE				
OPTION	LENGTH OF OPTION	EXTENSION	LENGTH OF EXTENSION	REVISED EXP. DATE
<input type="checkbox"/>		<input type="checkbox"/>		March 31, 2023
CURRENT VALUE	VALUE OF CHANGE NOTICE	ESTIMATED AGGREGATE CONTRACT VALUE		
\$45,600,000.00	\$0.00	\$45,600,000.00		
DESCRIPTION				
Effective 6/16/2022 pricing on this contract is hereby updated, per revised Schedule G (attached). All other terms, conditions, specifications and pricing remain the same. Per contractor request and agency agreement, and DTMB Procurement approval.				

STATE OF MICHIGAN

Contract No. 21000000606

Small Class of Non-Lift and Lift Transit Buses

SCHEDULE G PRICING

MICHIGAN SMALL CLASS OF BUSES SPECIFICATION

Class 1 - Minimum 5 Years/150,000 Miles

Class 2 - Minimum 7 Years/200,000 Miles

Body Manufacturer:	Champion Bus	
Bidder Company Name:	Hoekstra Transportation Inc.	
Bidder Address:	3741 Roger B Chaffee Blvd. Grand Rapids, MI. 49548	
Preparer's Name:	Steve Bolin	
Inspection Facility:	Hoekstra Transportation Inc.	
Address of Inspection Facility:	3741 Roger B Chaffee Blvd. Grand Rapids, MI. 49548	
II		
	Description	Unit Price
	Base Bus Floor Plans – Class One	
	138" (min) Wheelbase Bus – Vinyl Seat Covers	
A.	10 passenger without lift	\$97,957.00
B.	4 + 2 passenger with lift	\$116,666.00
C.	11 passenger without lift	\$96,765.00
D.	5 + 2 passenger with lift	\$111,794.00
	138" (min) Wheelbase Bus – Fabric Seat Covers	
E.	10 passenger without lift	\$98,797.00
F.	4 + 2 passenger with lift	\$117,506.00
G.	11 passenger without lift	\$97,689.00
H.	5 + 2 passenger with lift	\$112,718.00
	Base Bus Floor Plans – Class Two	
	158" (min) Wheelbase Bus – Vinyl Seat Covers	
I.	18 passenger without lift	\$111,070.00
J.	10 + 1 passenger with lift	\$119,824.00
K.	8 + 2 passenger with lift	\$120,643.00
L.	4 + 2 passenger with lift	\$125,233.00
	158" (min) Wheelbase Bus – Fabric Seat Covers	
M.	18 passenger without lift	\$112,582.00
N.	10 + 1 passenger with lift	\$121,000.00
O.	8 + 2 passenger with lift	\$121,651.00
P.	4 + 2 passenger with lift	\$126,577.00
	158" (min) Wheelbase Bus – Vinyl Seat Covers	
Q.	22 passenger without lift	\$115,272.00
R.	6 + 2 passenger with lift	\$124,989.00
S.	10 + 2 passenger with lift	\$123,685.00

T.	4 + 2 passenger with lift	\$129,119.00
	158" (min) Wheelbase Bus – Fabric Seat Covers	
U.	22 passenger without lift	\$117,120.00
V.	6 + 2 passenger with lift	\$126,333.00
W.	10 + 2 passenger with lift	\$124,861.00
X.	4 + 2 passenger with lift	\$130,631.00
SUBTOTAL (Buses A-X)		
AA.	Equipment Options	
1	Air Conditioning – Split System	\$12,500.00
2	Air Conditioning - Rooftop System	\$17,000.00
3	Auxiliary Coolant Heater	\$4,000.00
4	Auxiliary Air Heater	\$4,413.00
5	Destination Sign – Roller Curtain	\$3,800.00
6	Destination Sign – LED	\$5,700.00
7	Donation box (in lieu of standard farebox – deduct)	-\$900.00
8	Driver Side Running Board/Steps/Grab Handle	\$400.00
9	Farebox Electrical Prep Only (less standard farebox- deduct)	-\$1,800.00
10	Limited Slip Differential	\$300.00
11	Rear Emergency Exit Window	-\$1,400.00
12	Paint - One stripe	\$1,884.00
13	Paint - Roof second color	\$800.00
14	Paint - Different Full body	\$6,190.00
15	Reflective Vinyl Belt Stripe	\$700.00
16	Lift – Type I (in lieu of standard lift - deduct)	-\$1,100.00
17	Lift – Type II – Powered outer barrier (in lieu of standard lift)	-\$900.00
18	Lift - Folding Platform (in lieu of standard lift)	-\$900.00
19	Alternate Standard Lift Manufacturer	\$0.00
20	Wheelchair Single Point Securement System (in lieu of one standard L-Track position)	\$328.00
21	Additional Wheelchair Position – L Track System	\$1,163.00
22	Additional Wheelchair Position – Single Point System	\$1,335.00
23	Portable Oxygen Tank Holder	\$338.00
24	Assistive Blue Loop Straps	\$65.00
25	Two-way radio prep package	\$200.00
26	Radio - AM/FM stereo system w/ four speakers	\$333.00
27	Public Address (PA) System Only w/ two speakers	\$272.00
28	Radio – AM/FM/PA System w/ four speakers	\$500.00
29	Radio – Speaker only (additional)	\$100.00
30	Raised Flooring (No Wheel Wells)	\$1,100.00
31	Entrance Stepwell Heater	\$150.00
32	Manual Entrance Door	\$0.00
33	Seating – Forward Facing Standard Double Seat – Vinyl	\$1,283.00
34	Seating – Forward Facing Standard Double Seat – Fabric	\$1,457.00
35	Seating – Forward Facing Standard Double Seat – Vinyl (Deduct)	-\$1,283.00
36	Seating – Forward Facing Standard Double Seat – Fabric (Deduct)	-\$1,457.00
37	Seating – Forward Facing Double Fold-A-Way – Vinyl	\$1,846.00
38	Seating – Forward Facing Double Fold-A-Way – Fabric	\$2,027.00
39	Seating – Forward Facing Double Fold-A-Way – Vinyl (Deduct)	-\$1,846.00
40	Seating – Forward Facing Double Fold-A-Way – Fabric (Deduct)	-\$2,027.00

41	Seating – Single Flip-up – Vinyl	\$1,100.00
42	Seating – Single Flip-up – Fabric	\$1,200.00
43	Seating – Double Flip-up – Vinyl	\$1,749.00
44	Seating – Double Flip-up – Fabric	\$1,930.00
45	Seating – Double w/Single Integrated Child Seat (ICS) - Vinyl	\$2,137.00
46	Seating – Double w/Single Integrated Child Seat (ICS) – Fabric	\$2,311.00
47	Seating – Double w/Single Integrated Child Seat (ICS) – Vinyl (Deduct)	-\$2,137.00
48	Seating – Double w/Single Integrated Child Seat (ICS) – Fabric (Deduct)	-\$2,311.00
49	Seating – Double w/Double Integrated Child Seat (ICS) - Vinyl	\$2,836.00
50	Seating – Double w/Double Integrated Child Seat (ICS) - Fabric	\$3,017.00
51	Power Seat Base (Driver)	\$610.00
52	Alternate Engine - CNG Class II - Dedicated	\$25,063.00
53	Alternate Engine LPG 40 GGE Class I - Dedicated	\$17,043.00
54	Alternate Engine LPG 40 GGE Class II - Dedicated	\$18,045.00
55	Alternate Engine LPG 64 GGE Class II - Dedicated	\$21,053.00
56	Alternate Engine LPG 24 GGE Class I - Bi-fuel	\$11,028.00
57	Alternate Engine LPG 24 GGE Class II - Bi-fuel	\$11,028.00
58	Stop Request System	\$856.00
59	Back-up Sensor System	\$802.00
60	Back-up Camera System	\$0.00
61	Video Surveillance – Two Camera System	\$3,010.00
62	Video Surveillance - Four Camera System	\$3,510.00
63	Video Surveillance - Six Camera System	\$5,010.00
64	Video Surveillance - DVR System Upgrade	\$538.00
65	Video Surveillance – Extra Interior Cameras	\$500.00
66	Video Surveillance – Extra Exterior Cameras	\$500.00
67	Video Surveillance Prep Package	\$1,000.00
68	Rear Suspension Assist System	\$1,300.00
69	Spare Tire - Steer Axle	\$300.00
70	Spare Tire - Drive Asle	\$300.00
71	Entry Door Grab Handles	\$325.00
72	Interior Mirror	\$50.00
73	Ceiling Handrails	\$251.00
74	Wheelchair Lift Plexiglass Barriers	\$150.00
75	Slide-out Battery Tray	\$0.00
76	Bike Rack	\$3,541.00
77	Yellow Seatback Grab Handles	\$50.00
78	OEM Chassis Cruise Control	\$400.00
79	Alternate Flooring Manufacturer	\$0.00

NOTES:

Seating – Rear five place passenger – Vinyl	\$640.00
Seating – Rear five place passenger - Fabric	\$731.00



STATE OF MICHIGAN PROCUREMENT
 Department of Technology, Management, and Budget
 525 W. Allegan St., Lansing, Michigan 48913
 P.O. Box 30026 Lansing, Michigan 48909

NOTICE OF CONTRACT

NOTICE OF CONTRACT NO. **210000000606**

between

THE STATE OF MICHIGAN

and

CONTRACTOR	Hoekstra Transportation, Inc.
	3741 Roger B Chaffee
	Grand Rapids, MI 49548
	Steve Bolin
	(616) 299-5170
	sbolin@hoekstratruck.com
	CV0045588

STATE	Program Manager	Jeff Turner	MDOT
		(517) 335-3282	
	Turnerj3@michigan.gov		
	Contract Administrator	Yvon Dufour	DTMB
(517) 249-0455			
dufoury@michigan.gov			

CONTRACT SUMMARY			
DESCRIPTION: Small Class of Non-Lift and Lift Transit Buses			
INITIAL EFFECTIVE DATE	INITIAL EXPIRATION DATE	INITIAL AVAILABLE OPTIONS	EXPIRATION DATE BEFORE CHANGE(S) NOTED BELOW
April 1, 2021	March 31, 2023	2, one year	
PAYMENT TERMS		DELIVERY TIMEFRAME	
45 Days		90-120 Days	
ALTERNATE PAYMENT OPTIONS			EXTENDED PURCHASING
<input type="checkbox"/> P-card <input type="checkbox"/> Direct Voucher (DV) <input type="checkbox"/> Other			<input type="checkbox"/> Yes <input checked="" type="checkbox"/> No
MINIMUM DELIVERY REQUIREMENTS			
F.O.B. Destination			
MISCELLANEOUS INFORMATION			
ESTIMATED CONTRACT VALUE AT TIME OF EXECUTION			\$45,600,000.00

FOR THE CONTRACTOR:

Hoekstra Transportation, Inc.
Company Name

Authorized Agent Signature

Authorized Agent (Print or Type)

Date

FOR THE STATE:

Signature

Jared Ambrosier – Sourcing Director
Name & Title

DTMB Procurement
Agency

Date

STANDARD CONTRACT TERMS

This STANDARD CONTRACT (“**Contract**”) is agreed to between the State of Michigan (the “**State**”) and Hoekstra Transportation (“**Contractor**”), a Michigan Corporation. This Contract is effective on April 1, 2021 (“**Effective Date**”), and unless terminated, expires on March 31, 2023.

Contract may be renewed for up to two (2) additional one (1) year period(s). Renewal is at the sole discretion of the State and will automatically extend the Term of this Contract. The State will document its exercise of renewal options via Contract Change Notice.

The parties agree as follows:

- 1. Duties of Contractor.** Contractor must perform the services and provide the deliverables described in **Schedule A – Statement of Work** (the “**Contract Activities**”). An obligation to provide delivery of any commodity is considered a service and is a Contract Activity.

Contractor must furnish all labor, equipment, materials, and supplies necessary for the performance of the Contract Activities, and meet operational standards, unless otherwise specified in Schedule A.

Contractor must: (a) perform the Contract Activities in a timely, professional, safe, and workmanlike manner consistent with standards in the trade, profession, or industry; (b) meet or exceed the performance and operational standards, and specifications of the Contract; (c) provide all Contract Activities in good quality, with no material defects; (d) not interfere with the State’s operations; (e) obtain and maintain all necessary licenses, permits or other authorizations necessary for the performance of the Contract; (f) cooperate with the State, including the State’s quality assurance personnel, and any third party to achieve the objectives of the Contract; (g) return to the State any State-furnished equipment or other resources in the same condition as when provided when no longer required for the Contract; (h) not make any media releases without prior written authorization from the State; (i) assign to the State any claims resulting from state or federal antitrust violations to the extent that those violations concern materials or services supplied by third parties toward fulfillment of the Contract; (j) comply with all State physical and IT security policies and standards which will be made available upon request; and (k) provide the State priority in performance of the Contract except as mandated by federal disaster response requirements. Any breach under this paragraph is considered a material breach.

Contractor must also be clearly identifiable while on State property by wearing identification issued by the State, and clearly identify themselves whenever making contact with the State.

- 2. Notices.** All notices and other communications required or permitted under this Contract must be in writing and will be considered given and received: (a) when

STANDARD CONTRACT TERMS

verified by written receipt if sent by courier; (b) when actually received if sent by mail without verification of receipt; or (c) when verified by automated receipt or electronic logs if sent by facsimile or email.

If to State:	If to Contractor:
Yvon Dufour 525 W. Allegan, Constitution Hall, 1 st Floor NE Lansing, MI 48933 dufoury@michigan.gov (517) 284-6996	Steve Bolin Hoekstra Transportation Inc. 3741 Roger B Chaffee Blvd. Grand Rapids, MI. 49548 SBolin@HoekstraInc.com 616-389-1130 Office

3. **Contract Administrator.** The Contract Administrator for each party is the only person authorized to modify any terms of this Contract, and approve and execute any change under this Contract (each a “**Contract Administrator**”):

State:	Contractor:
Yvon Dufour 525 W. Allegan, Constitution Hall, 1 st Floor NE Lansing, MI 48933 dufoury@michigan.gov (517) 249-0455	Steve Bolin Hoekstra Transportation Inc. 3741 Roger B Chaffee Blvd. Grand Rapids, MI. 49548 SBolin@HoekstraInc.com 616-389-1130 Office

4. **Program Manager.** The Program Manager for each party will monitor and coordinate the day-to-day activities of the Contract (each a “**Program Manager**”):

State:	Contractor:
Jeff Turner 425 W Ottawa St Lansing, MI 48908 turnerj3@michigan.gov 517-335-1700	Steve Bolin Hoekstra Transportation Inc. 3741 Roger B Chaffee Blvd. Grand Rapids, MI. 49548 SBolin@HoekstraInc.com 616-389-1130 Office

5. **Performance Guarantee.** Contractor must at all times have financial resources sufficient, in the opinion of the State, to ensure performance of the Contract and must provide proof upon request. The State may require a performance bond (as specified in Schedule A – Statement of Work) if, in the opinion of the State, it will ensure performance of the Contract.
6. **Insurance Requirements.** Contractor, at its sole expense, must maintain the insurance coverage identified below. All required insurance must: (a) protect the State from claims that may arise out of, are alleged to arise out of, or result from Contractor's or a subcontractor's performance; (b) be primary and non-contributing to any comparable liability insurance (including self-insurance) carried by the State; and

STANDARD CONTRACT TERMS

(c) be provided by a company with an A.M. Best rating of "A-" or better, and a financial size of VII or better.

Required Limits	Additional Requirements
Commercial General Liability Insurance	
Minimum Limits: \$1,000,000 Each Occurrence \$1,000,000 Personal & Advertising Injury \$2,000,000 Products/Completed Operations \$2,000,000 General Aggregate	Policy must be endorsed to add “the State of Michigan, its departments, divisions, agencies, offices, commissions, officers, employees, and agents” as additional insureds using endorsement CG 20 10 11 85, or both CG 20 10 12 19 and CG 20 37 12 19.
Automobile Liability Insurance	
Minimum Limits: \$1,000,000 Per Accident	Policy must: (1) be endorsed to add “the State of Michigan, its departments, divisions, agencies, offices, commissions, officers, employees, and agents” as additional insureds; and (2) include Hired and Non-Owned Automobile coverage.
Workers' Compensation Insurance	
Minimum Limits: Coverage according to applicable laws governing work activities	Waiver of subrogation, except where waiver is prohibited by law.
Employers Liability Insurance	
Minimum Limits: \$500,000 Each Accident \$500,000 Each Employee by Disease \$500,000 Aggregate Disease	
Garagekeepers Liability Insurance	
Minimum Limits: \$1,000,000 Per Occurrence	Contractor must have their policy: (1) endorsed to add “the State of Michigan, its departments, divisions, agencies, offices, commissions, officers, employees, and agents” as additional insureds; and (2) include Garagekeepers Legal Liability coverage.

If any of the required policies provide **claims-made** coverage, the Contractor must:
 (a) provide coverage with a retroactive date before the Effective Date of the Contract or the beginning of Contract Activities; (b) maintain coverage and provide evidence of

STANDARD CONTRACT TERMS

coverage for at least three (3) years after completion of the Contract Activities; and (c) if coverage is cancelled or not renewed, and not replaced with another claims-made policy form with a retroactive date prior to the Contract Effective Date, Contractor must purchase extended reporting coverage for a minimum of three (3) years after completion of work.

Contractor must: (a) provide insurance certificates to the Contract Administrator, containing the agreement or delivery order number, at Contract formation and within twenty (20) calendar days of the expiration date of the applicable policies; (b) require that subcontractors maintain the required insurances contained in this Section; (c) notify the Contract Administrator within five (5) business days if any insurance is cancelled; and (d) waive all rights against the State for damages covered by insurance. Failure to maintain the required insurance does not limit this waiver.

This Section is not intended to and is not to be construed in any manner as waiving, restricting or limiting the liability of either party for any obligations under this Contract (including any provisions hereof requiring Contractor to indemnify, defend and hold harmless the State).

- 7. Administrative Fee and Reporting.** Contractor must pay an administrative fee of .25% on all payments made to Contractor under the Contract including transactions with the State (including its departments, divisions, agencies, offices, and commissions), MiDEAL members, and other states (including governmental subdivisions and authorized entities). Administrative fee payments must be made online by check or credit card at: <https://www.thepayplace.com/mi/dtmb/adminfee>

Contractor must submit an itemized purchasing activity report, which includes at a minimum, the name of the purchasing entity and the total dollar volume in sales. Reports should be mailed to MiDeal@michigan.gov.

The administrative fee and purchasing activity report are due within 30 calendar days from the last day of each calendar quarter.

- 8. Reserved.**

- 9. Independent Contractor.** Contractor is an independent contractor and assumes all rights, obligations and liabilities set forth in this Contract. Contractor, its employees, and agents will not be considered employees of the State. No partnership or joint venture relationship is created by virtue of this Contract. Contractor, and not the State, is responsible for the payment of wages, benefits and taxes of Contractor's employees and any subcontractors. Prior performance does not modify Contractor's status as an independent contractor.

- 10. Subcontracting.** Contractor may not delegate any of its obligations under the Contract without the prior written approval of the State. Contractor must notify the State at least 90 calendar days before the proposed delegation and provide the State any information it requests to determine whether the delegation is in its best interest. If approved, Contractor must: (a) be the sole point of contact regarding all contractual

STANDARD CONTRACT TERMS

matters, including payment and charges for all Contract Activities; (b) make all payments to the subcontractor; and (c) incorporate the terms and conditions contained in this Contract in any subcontract with a subcontractor. Contractor remains responsible for the completion of the Contract Activities, compliance with the terms of this Contract, and the acts and omissions of the subcontractor. The State, in its sole discretion, may require the replacement of any subcontractor.

- 11. Staffing.** The State's Contract Administrator may require Contractor to remove or reassign personnel by providing a notice to Contractor.
- 12. Background Checks.** Pursuant to Michigan law, all agencies subject to IRS Pub. 1075 are required to ask the Michigan State Police to perform fingerprint background checks on all employees, including Contractor and Subcontractor employees, who may have access to any database of information maintained by the federal government that contains confidential or personal information, including, but not limited to, federal tax information. Further, pursuant to Michigan law, any agency described above is prohibited from providing Contractors or Subcontractors with the result of such background check. For more information, please see Michigan Public Act 427 of 2018. Upon request, or as may be specified in Schedule A, Contractor must perform background checks on all employees and subcontractors and its employees prior to their assignment. The scope is at the discretion of the State and documentation must be provided as requested. Contractor is responsible for all costs associated with the requested background checks. The State, in its sole discretion, may also perform background checks.
- 13. Assignment.** Contractor may not assign this Contract to any other party without the prior approval of the State. Upon notice to Contractor, the State, in its sole discretion, may assign in whole or in part, its rights or responsibilities under this Contract to any other party. If the State determines that a novation of the Contract to a third party is necessary, Contractor will agree to the novation and provide all necessary documentation and signatures.
- 14. Change of Control.** Contractor will notify within 30 days of any public announcement or otherwise once legally permitted to do so, the State of a change in Contractor's organizational structure or ownership. For purposes of this Contract, a change in control means any of the following: (a) a sale of more than 50% of Contractor's stock; (b) a sale of substantially all of Contractor's assets; (c) a change in a majority of Contractor's board members; (d) consummation of a merger or consolidation of Contractor with any other entity; (e) a change in ownership through a transaction or series of transactions; (f) or the board (or the stockholders) approves a plan of complete liquidation. A change of control does not include any consolidation or merger effected exclusively to change the domicile of Contractor, or any transaction or series of transactions principally for bona fide equity financing purposes.

In the event of a change of control, Contractor must require the successor to assume this Contract and all of its obligations under this Contract.

STANDARD CONTRACT TERMS

- 15. Ordering.** Contractor is not authorized to begin performance until receipt of authorization as identified in Schedule A.
- 16. Acceptance.** Contract Activities are subject to inspection and testing by the State within 30 calendar days of the State's receipt of them ("**State Review Period**"), unless otherwise provided in Schedule A. If the Contract Activities are not fully accepted by the State, the State will notify Contractor by the end of the State Review Period that either: (a) the Contract Activities are accepted but noted deficiencies must be corrected; or (b) the Contract Activities are rejected. If the State finds material deficiencies, it may: (i) reject the Contract Activities without performing any further inspections; (ii) demand performance at no additional cost; or (iii) terminate this Contract in accordance with Section 23, Termination for Cause.

Within 10 business days from the date of Contractor's receipt of notification of acceptance with deficiencies or rejection of any Contract Activities, Contractor must cure, at no additional cost, the deficiency and deliver unequivocally acceptable Contract Activities to the State. If acceptance with deficiencies or rejection of the Contract Activities impacts the content or delivery of other non-completed Contract Activities, the parties' respective Program Managers must determine an agreed to number of days for re-submission that minimizes the overall impact to the Contract. However, nothing herein affects, alters, or relieves Contractor of its obligations to correct deficiencies in accordance with the time response standards set forth in this Contract.

If Contractor is unable or refuses to correct the deficiency within the time response standards set forth in this Contract, the State may cancel the order in whole or in part. The State, or a third party identified by the State, may perform the Contract Activities and recover the difference between the cost to cure and the Contract price plus an additional 10% administrative fee.

- 17. Delivery.** Contractor must deliver all Contract Activities F.O.B. destination, within the State premises with transportation and handling charges paid by Contractor, unless otherwise specified in Schedule A. All containers and packaging become the State's exclusive property upon acceptance.
- 18. Risk of Loss and Title.** Until final acceptance, title and risk of loss or damage to Contract Activities remains with Contractor. Contractor is responsible for filing, processing, and collecting all damage claims. The State will record and report to Contractor any evidence of visible damage. If the State rejects the Contract Activities, Contractor must remove them from the premises within 10 calendar days after notification of rejection. The risk of loss of rejected or non-conforming Contract Activities remains with Contractor. Rejected Contract Activities not removed by Contractor within 10 calendar days will be deemed abandoned by Contractor, and the State will have the right to dispose of it as its own property. Contractor must reimburse the State for costs and expenses incurred in storing or effecting removal or disposition of rejected Contract Activities.

STANDARD CONTRACT TERMS

19. Warranty Period. The warranty period, if applicable, for Contract Activities is a fixed period commencing on the date specified in Schedule A. If the Contract Activities do not function as warranted during the warranty period, the State may return such non-conforming Contract Activities to the Contractor for a full refund.

20. Terms of Payment. Invoices must conform to the requirements communicated from time-to-time by the State. All undisputed amounts are payable within 45 days of the State's receipt. Contractor may only charge for Contract Activities performed as specified in Schedule A. Invoices must include an itemized statement of all charges. The State is exempt from State sales tax for direct purchases and may be exempt from federal excise tax, if Services purchased under this Agreement are for the State's exclusive use. All prices are exclusive of taxes, and Contractor is responsible for all sales, use and excise taxes, and any other similar taxes, duties and charges of any kind imposed by any federal, state, or local governmental entity on any amounts payable by the State under this Contract.

The State has the right to withhold payment of any disputed amounts until the parties agree as to the validity of the disputed amount. The State will notify Contractor of any dispute within a reasonable time. Payment by the State will not constitute a waiver of any rights as to Contractor's continuing obligations, including claims for deficiencies or substandard Contract Activities. Contractor's acceptance of final payment by the State constitutes a waiver of all claims by Contractor against the State for payment under this Contract, other than those claims previously filed in writing on a timely basis and still disputed.

The State will only disburse payments under this Contract through Electronic Funds Transfer (EFT). Contractor must register with the State at <http://www.michigan.gov/SIGMAVSS> to receive electronic fund transfer payments. If Contractor does not register, the State is not liable for failure to provide payment. Without prejudice to any other right or remedy it may have, the State reserves the right to set off at any time any amount then due and owing to it by Contractor against any amount payable by the State to Contractor under this Contract.

21. Liquidated Damages. Liquidated damages, if applicable, will be assessed as described in Schedule A.

22. Stop Work Order. The State may suspend any or all activities under the Contract at any time. The State will provide Contractor a written stop work order detailing the suspension. Contractor must comply with the stop work order upon receipt. Within 90 calendar days, or any longer period agreed to by Contractor, the State will either: (a) issue a notice authorizing Contractor to resume work, or (b) terminate the Contract or delivery order. The State will not pay for Contract Activities, Contractor's lost profits, or any additional compensation during a stop work period.

23. Termination for Cause. The State may terminate this Contract for cause, in whole or in part, if Contractor, as determined by the State: (a) endangers the value, integrity, or security of any location, data, or personnel; (b) becomes insolvent, petitions for

STANDARD CONTRACT TERMS

bankruptcy court proceedings, or has an involuntary bankruptcy proceeding filed against it by any creditor; (c) engages in any conduct that may expose the State to liability; (d) breaches any of its material duties or obligations; or (e) fails to cure a breach within the time stated in a notice of breach. Any reference to specific breaches being material breaches within this Contract will not be construed to mean that other breaches are not material.

If the State terminates this Contract under this Section, the State will issue a termination notice specifying whether Contractor must: (a) cease performance immediately, or (b) continue to perform for a specified period. If it is later determined that Contractor was not in breach of the Contract, the termination will be deemed to have been a Termination for Convenience, effective as of the same date, and the rights and obligations of the parties will be limited to those provided in Section 24, Termination for Convenience.

The State will only pay for amounts due to Contractor for Contract Activities accepted by the State on or before the date of termination, subject to the State's right to set off any amounts owed by the Contractor for the State's reasonable costs in terminating this Contract. The Contractor must pay all reasonable costs incurred by the State in terminating this Contract for cause, including administrative costs, attorneys' fees, court costs, transition costs, and any costs the State incurs to procure the Contract Activities from other sources.

- 24. Termination for Convenience.** The State may immediately terminate this Contract in whole or in part without penalty and for any reason, including but not limited to, appropriation or budget shortfalls. The termination notice will specify whether Contractor must: (a) cease performance of the Contract Activities immediately, or (b) continue to perform the Contract Activities in accordance with Section 25, Transition Responsibilities. If the State terminates this Contract for convenience, the State will pay all reasonable costs, as determined by the State, for State approved Transition Responsibilities.
- 25. Transition Responsibilities.** Upon termination or expiration of this Contract for any reason, Contractor must, for a period of time specified by the State (not to exceed **90** calendar days), provide all reasonable transition assistance requested by the State, to allow for the expired or terminated portion of the Contract Activities to continue without interruption or adverse effect, and to facilitate the orderly transfer of such Contract Activities to the State or its designees. Such transition assistance may include, but is not limited to: (a) continuing to perform the Contract Activities at the established Contract rates; (b) taking all reasonable and necessary measures to transition performance of the work, including all applicable Contract Activities, training, equipment, software, leases, reports and other documentation, to the State or the State's designee; (c) taking all necessary and appropriate steps, or such other action as the State may direct, to preserve, maintain, protect, or return to the State all materials, data, property, and confidential information provided directly or indirectly to Contractor by any entity, agent, vendor, or employee of the State; (d) transferring title

STANDARD CONTRACT TERMS

in and delivering to the State, at the State's discretion, all completed or partially completed deliverables prepared under this Contract as of the Contract termination date; and (e) preparing an accurate accounting from which the State and Contractor may reconcile all outstanding accounts (collectively, "**Transition Responsibilities**"). This Contract will automatically be extended through the end of the transition period.

- 26. General Indemnification.** Contractor must defend, indemnify and hold the State, its departments, divisions, agencies, offices, commissions, officers, and employees harmless, without limitation, from and against any and all actions, claims, losses, liabilities, damages, costs, attorney fees, and expenses (including those required to establish the right to indemnification), arising out of or relating to: (a) any breach by Contractor (or any of Contractor's employees, agents, subcontractors, or by anyone else for whose acts any of them may be liable) of any of the promises, agreements, representations, warranties, or insurance requirements contained in this Contract; (b) any infringement, misappropriation, or other violation of any intellectual property right or other right of any third party; (c) any bodily injury, death, or damage to real or tangible personal property occurring wholly or in part due to action or inaction by Contractor (or any of Contractor's employees, agents, subcontractors, or by anyone else for whose acts any of them may be liable); and (d) any acts or omissions of Contractor (or any of Contractor's employees, agents, subcontractors, or by anyone else for whose acts any of them may be liable).

The State will notify Contractor in writing if indemnification is sought; however, failure to do so will not relieve Contractor, except to the extent that Contractor is materially prejudiced. Contractor must, to the satisfaction of the State, demonstrate its financial ability to carry out these obligations.

The State is entitled to: (i) regular updates on proceeding status; (ii) participate in the defense of the proceeding; (iii) employ its own counsel; and to (iv) retain control of the defense if the State deems necessary. Contractor will not, without the State's written consent (not to be unreasonably withheld), settle, compromise, or consent to the entry of any judgment in or otherwise seek to terminate any claim, action, or proceeding. To the extent that any State employee, official, or law may be involved or challenged, the State may, at its own expense, control the defense of that portion of the claim.

Any litigation activity on behalf of the State, or any of its subdivisions under this Section, must be coordinated with the Department of Attorney General. An attorney designated to represent the State may not do so until approved by the Michigan Attorney General and appointed as a Special Assistant Attorney General.

- 27. Infringement Remedies.** If, in either party's opinion, any piece of equipment, software, commodity, or service supplied by Contractor or its subcontractors, or its operation, use or reproduction, is likely to become the subject of a copyright, patent, trademark, or trade secret infringement claim, Contractor must, at its expense: (a) procure for the State the right to continue using the equipment, software, commodity, or service, or if this option is not reasonably available to Contractor, (b) replace or

STANDARD CONTRACT TERMS

modify the same so that it becomes non-infringing; or (c) accept its return by the State with appropriate credits to the State against Contractor's charges and reimburse the State for any losses or costs incurred as a consequence of the State ceasing its use and returning it.

- 28. Limitation of Liability and Disclaimer of Damages. IN NO EVENT WILL THE STATE'S AGGREGATE LIABILITY TO CONTRACTOR UNDER THIS CONTRACT, REGARDLESS OF THE FORM OF ACTION, WHETHER IN CONTRACT, TORT, NEGLIGENCE, STRICT LIABILITY OR BY STATUTE OR OTHERWISE, FOR ANY CLAIM RELATED TO OR ARISING UNDER THIS CONTRACT, EXCEED THE MAXIMUM AMOUNT OF FEES PAYABLE UNDER THIS CONTRACT.** The State is not liable for consequential, incidental, indirect, or special damages, regardless of the nature of the action.
- 29. Disclosure of Litigation, or Other Proceeding.** Contractor must notify the State within 14 calendar days of receiving notice of any litigation, investigation, arbitration, or other proceeding (collectively, "**Proceeding**") involving Contractor, a subcontractor, or an officer or director of Contractor or subcontractor, that arises during the term of the Contract, including: (a) a criminal Proceeding; (b) a parole or probation Proceeding; (c) a Proceeding under the Sarbanes-Oxley Act; (d) a civil Proceeding involving: (1) a claim that might reasonably be expected to adversely affect Contractor's viability or financial stability; or (2) a governmental or public entity's claim or written allegation of fraud; or (e) a Proceeding involving any license that Contractor is required to possess in order to perform under this Contract.
- 30. State Data.** All data and information provided to Contractor by or on behalf of the State, and all data and information derived therefrom, is the exclusive property of the State ("**State Data**"); this definition is to be construed as broadly as possible. Upon request, Contractor must provide to the State, or a third party designated by the State, all State Data within 10 calendar days of the request and in the format requested by the State. Contractor will assume all costs incurred in compiling and supplying State Data. No State Data may be used for any marketing purposes.
- 31. Reserved.**
- 32. Non-Disclosure of Confidential Information.** The parties acknowledge that each party may be exposed to or acquire communication or data of the other party that is confidential, privileged communication not intended to be disclosed to third parties. The provisions of this Section survive the termination of this Contract.
- a. Meaning of Confidential Information.** For the purposes of this Contract, the term "**Confidential Information**" means all information and documentation of a party that: (a) has been marked "confidential" or with words of similar meaning, at the time of disclosure by such party; (b) if disclosed orally or not marked "confidential" or with words of similar meaning, was subsequently summarized in writing by the disclosing party and marked "confidential" or with words of similar meaning; and, (c) should reasonably be recognized as confidential information of

STANDARD CONTRACT TERMS

the disclosing party. The term “Confidential Information” does not include any information or documentation that was: (a) subject to disclosure under the Michigan Freedom of Information Act (FOIA); (b) already in the possession of the receiving party without an obligation of confidentiality; (c) developed independently by the receiving party, as demonstrated by the receiving party, without violating the disclosing party’s proprietary rights; (d) obtained from a source other than the disclosing party without an obligation of confidentiality; or, (e) publicly available when received, or thereafter became publicly available (other than through any unauthorized disclosure by, through, or on behalf of, the receiving party). For purposes of this Contract, in all cases and for all matters, State Data is deemed to be Confidential Information.

- b. Obligation of Confidentiality.** The parties agree to hold all Confidential Information in strict confidence and not to copy, reproduce, sell, transfer, or otherwise dispose of, give or disclose such Confidential Information to third parties other than employees, agents, or subcontractors of a party who have a need to know in connection with this Contract or to use such Confidential Information for any purposes whatsoever other than the performance of this Contract. The parties agree to advise and require their respective employees, agents, and subcontractors of their obligations to keep all Confidential Information confidential. Disclosure to a subcontractor is permissible where: (a) use of a subcontractor is authorized under this Contract; (b) the disclosure is necessary or otherwise naturally occurs in connection with work that is within the subcontractor's responsibilities; and (c) Contractor obligates the subcontractor in a written contract to maintain the State's Confidential Information in confidence. At the State's request, any employee of Contractor or any subcontractor may be required to execute a separate agreement to be bound by the provisions of this Section.
- c. Cooperation to Prevent Disclosure of Confidential Information.** Each party must use its best efforts to assist the other party in identifying and preventing any unauthorized use or disclosure of any Confidential Information. Without limiting the foregoing, each party must advise the other party immediately in the event either party learns or has reason to believe that any person who has had access to Confidential Information has violated or intends to violate the terms of this Contract and each party will cooperate with the other party in seeking injunctive or other equitable relief against any such person.
- d. Remedies for Breach of Obligation of Confidentiality.** Each party acknowledges that breach of its obligation of confidentiality may give rise to irreparable injury to the other party, which damage may be inadequately compensable in the form of monetary damages. Accordingly, a party may seek and obtain injunctive relief against the breach or threatened breach of the foregoing undertakings, in addition to any other legal remedies which may be available, to include, in the case of the State, at the sole election of the State, the

STANDARD CONTRACT TERMS

immediate termination, without liability to the State, of this Contract or any Statement of Work corresponding to the breach or threatened breach.

- e. **Surrender of Confidential Information upon Termination.** Upon termination of this Contract or a Statement of Work, in whole or in part, each party must, within 5 calendar days from the date of termination, return to the other party any and all Confidential Information received from the other party, or created or received by a party on behalf of the other party, which are in such party's possession, custody, or control; provided, however, that Contractor must return State Data to the State following the timeframe and procedure described further in this Contract. Should Contractor or the State determine that the return of any Confidential Information is not feasible, such party must destroy the Confidential Information and must certify the same in writing within 5 calendar days from the date of termination to the other party. However, the State's legal ability to destroy Contractor data may be restricted by its retention and disposal schedule, in which case Contractor's Confidential Information will be destroyed after the retention period expires.

33. **Reserved.**

34. **Reserved.**

35. **Reserved.**

36. **Records Maintenance, Inspection, Examination, and Audit.** The State or its designee may audit Contractor to verify compliance with this Contract. Contractor must retain and provide to the State or its designee and the auditor general upon request, all financial and accounting records related to the Contract through the term of the Contract and for 4 years after the latter of termination, expiration, or final payment under this Contract or any extension ("**Audit Period**"). If an audit, litigation, or other action involving the records is initiated before the end of the Audit Period, Contractor must retain the records until all issues are resolved.

Within 10 calendar days of providing notice, the State and its authorized representatives or designees have the right to enter and inspect Contractor's premises or any other places where Contract Activities are being performed, and examine, copy, and audit all records related to this Contract. Contractor must cooperate and provide reasonable assistance. If any financial errors are revealed, the amount in error must be reflected as a credit or debit on subsequent invoices until the amount is paid or refunded. Any remaining balance at the end of the Contract must be paid or refunded within 45 calendar days.

This Section applies to Contractor, any parent, affiliate, or subsidiary organization of Contractor, and any subcontractor that performs Contract Activities in connection with this Contract.

37. **Warranties and Representations.** Contractor represents and warrants: (a) Contractor is the owner or licensee of any Contract Activities that it licenses, sells, or develops and Contractor has the rights necessary to convey title, ownership rights, or

STANDARD CONTRACT TERMS

licensed use; (b) all Contract Activities are delivered free from any security interest, lien, or encumbrance and will continue in that respect; (c) the Contract Activities will not infringe the patent, trademark, copyright, trade secret, or other proprietary rights of any third party; (d) Contractor must assign or otherwise transfer to the State or its designee any manufacturer's warranty for the Contract Activities; (e) the Contract Activities are merchantable and fit for the specific purposes identified in the Contract; (f) the Contract signatory has the authority to enter into this Contract; (g) all information furnished by Contractor in connection with the Contract fairly and accurately represents Contractor's business, properties, finances, and operations as of the dates covered by the information, and Contractor will inform the State of any material adverse changes; (h) all information furnished and representations made in connection with the award of this Contract is true, accurate, and complete, and contains no false statements or omits any fact that would make the information misleading; and that (i) Contractor is neither currently engaged in nor will engage in the boycott of a person based in or doing business with a strategic partner as described in 22 USC 8601 to 8606. A breach of this Section is considered a material breach of this Contract, which entitles the State to terminate this Contract under Section 23, Termination for Cause.

- 38. Conflicts and Ethics.** Contractor will uphold high ethical standards and is prohibited from: (a) holding or acquiring an interest that would conflict with this Contract; (b) doing anything that creates an appearance of impropriety with respect to the award or performance of the Contract; (c) attempting to influence or appearing to influence any State employee by the direct or indirect offer of anything of value; or (d) paying or agreeing to pay any person, other than employees and consultants working for Contractor, any consideration contingent upon the award of the Contract. Contractor must immediately notify the State of any violation or potential violation of these standards. This Section applies to Contractor, any parent, affiliate, or subsidiary organization of Contractor, and any subcontractor that performs Contract Activities in connection with this Contract.
- 39. Compliance with Laws.** Contractor must comply with all federal, state and local laws, rules and regulations.
- 40. Reserved.**
- 41. Reserved.**
- 42. Nondiscrimination.** Under the Elliott-Larsen Civil Rights Act, 1976 PA 453, MCL 37.2101, *et seq.*, the Persons with Disabilities Civil Rights Act, 1976 PA 220, MCL 37.1101, *et seq.*, and [Executive Directive 2019-09](#). Contractor and its subcontractors agree not to discriminate against an employee or applicant for employment with respect to hire, tenure, terms, conditions, or privileges of employment, or a matter directly or indirectly related to employment, because of race, color, religion, national origin, age, sex (as defined in Executive Directive 2019-09), height, weight, marital status, partisan considerations, any mental or physical disability, or genetic

STANDARD CONTRACT TERMS

information that is unrelated to the person's ability to perform the duties of a particular job or position. Breach of this covenant is a material breach of this Contract.

- 43. Unfair Labor Practice.** Under MCL 423.324, the State may void any Contract with a Contractor or subcontractor who appears on the Unfair Labor Practice register compiled under MCL 423.322.
- 44. Governing Law.** This Contract is governed, construed, and enforced in accordance with Michigan law, excluding choice-of-law principles, and all claims relating to or arising out of this Contract are governed by Michigan law, excluding choice-of-law principles. Any dispute arising from this Contract must be resolved in Michigan Court of Claims. Contractor consents to venue in Ingham County, and waives any objections, such as lack of personal jurisdiction or *forum non conveniens*. Contractor must appoint agents in Michigan to receive service of process.
- 45. Non-Exclusivity.** Nothing contained in this Contract is intended nor will be construed as creating any requirements contract with Contractor. This Contract does not restrict the State or its agencies from acquiring similar, equal, or like Contract Activities from other sources.
- 46. Force Majeure.** Neither party will be in breach of this Contract because of any failure arising from any disaster or acts of god that are beyond their control and without their fault or negligence. Each party will use commercially reasonable efforts to resume performance. Contractor will not be relieved of a breach or delay caused by its subcontractors. If immediate performance is necessary to ensure public health and safety, the State may immediately contract with a third party.
- 47. Dispute Resolution.** The parties will endeavor to resolve any Contract dispute in accordance with this provision. The dispute will be referred to the parties' respective Contract Administrators or Program Managers. Such referral must include a description of the issues and all supporting documentation. The parties must submit the dispute to a senior executive if unable to resolve the dispute within 15 business days. The parties will continue performing while a dispute is being resolved, unless the dispute precludes performance. A dispute involving payment does not preclude performance.

Litigation to resolve the dispute will not be instituted until after the dispute has been elevated to the parties' senior executive and either concludes that resolution is unlikely or fails to respond within 15 business days. The parties are not prohibited from instituting formal proceedings: (a) to avoid the expiration of statute of limitations period; (b) to preserve a superior position with respect to creditors; or (c) where a party makes a determination that a temporary restraining order or other injunctive relief is the only adequate remedy. This Section does not limit the State's right to terminate the Contract.

- 48. Media Releases.** News releases (including promotional literature and commercial advertisements) pertaining to the Contract or project to which it relates must not be

STANDARD CONTRACT TERMS

made without prior written State approval, and then only in accordance with the explicit written instructions of the State.

- 49. Website Incorporation.** The State is not bound by any content on Contractor’s website unless expressly incorporated directly into this Contract.
- 50. Schedules.** All Schedules and Exhibits that are referenced herein and attached hereto are hereby incorporated by reference. The following Schedules are attached hereto and incorporated herein:

Schedule A	Statement of Work
Schedule B	Specifications
Schedule C	Federal Clauses
Schedule D	Affidavit For Driver Delivery
Schedule E	Authorized Michigan Transit Agencies
Schedule F	Equipment Checklist
Schedule G	Pricing

- 51. Entire Agreement and Order of Precedence.** This Contract, which includes Schedule A – Statement of Work, and schedules and exhibits which are hereby expressly incorporated, is the entire agreement of the parties related to the Contract Activities. This Contract supersedes and replaces all previous understandings and agreements between the parties for the Contract Activities. If there is a conflict between documents, the order of precedence is: (a) first, this Contract, excluding its schedules, exhibits, and Schedule A – Statement of Work; (b) second, Schedule A – Statement of Work as of the Effective Date; and (c) third, schedules expressly incorporated into this Contract as of the Effective Date. NO TERMS ON CONTRACTOR’S INVOICES, ORDERING DOCUMENTS, WEBSITE, BROWSE-WRAP, SHRINK-WRAP, CLICK-WRAP, CLICK-THROUGH OR OTHER NON-NEGOTIATED TERMS AND CONDITIONS PROVIDED WITH ANY OF THE CONTRACT ACTIVITIES WILL CONSTITUTE A PART OR AMENDMENT OF THIS CONTRACT OR IS BINDING ON THE STATE FOR ANY PURPOSE. ALL SUCH OTHER TERMS AND CONDITIONS HAVE NO FORCE AND EFFECT AND ARE DEEMED REJECTED BY THE STATE, EVEN IF ACCESS TO OR USE OF THE CONTRACT ACTIVITIES REQUIRES AFFIRMATIVE ACCEPTANCE OF SUCH TERMS AND CONDITIONS.
- 52. Severability.** If any part of this Contract is held invalid or unenforceable, by any court of competent jurisdiction, that part will be deemed deleted from this Contract and the severed part will be replaced by agreed upon language that achieves the same or similar objectives. The remaining Contract will continue in full force and effect.

STANDARD CONTRACT TERMS

- 53. Waiver.** Failure to enforce any provision of this Contract will not constitute a waiver.
- 54. Survival.** The provisions of this Contract that impose continuing obligations, including warranties and representations, termination, transition, insurance coverage, indemnification, and confidentiality, will survive the expiration or termination of this Contract.
- 55. Contract Modification.** This Contract may not be amended except by signed agreement between the parties (a “**Contract Change Notice**”). Notwithstanding the foregoing, no subsequent Statement of Work or Contract Change Notice executed after the Effective Date will be construed to amend this Contract unless it specifically states its intent to do so and cites the section or sections amended.

FEDERAL PROVISIONS ADDENDUM

This addendum applies to purchases that will be paid for in whole or in part with funds obtained from the federal government. The provisions below are required, and the language is not negotiable. If any provision below conflicts with the State's terms and conditions, including any attachments, schedules, or exhibits to the State's Contract, the provisions below take priority to the extent a provision is required by federal law; otherwise, the order of precedence set forth in the Contract applies. Hyperlinks are provided for convenience only; broken hyperlinks will not relieve Contractor from compliance with the law.

1. Equal Employment Opportunity

If this Contract is a “**federally assisted construction contract**” as defined in [41 CFR Part 60-1.3](#), and except as otherwise may be provided under [41 CFR Part 60](#), then during performance of this Contract, the Contractor agrees as follows:

- a. The Contractor will not discriminate against any employee or applicant for employment because of race, color, religion, sex, sexual orientation, gender identity, or national origin. The Contractor will take affirmative action to ensure that applicants are employed, and that employees are treated during employment without regard to their race, color, religion, sex, sexual orientation, gender identity, or national origin. Such action shall include, but not be limited to the following:
Employment, upgrading, demotion, or transfer; recruitment or recruitment advertising; layoff or termination; rates of pay or other forms of compensation; and selection for training, including apprenticeship. The Contractor agrees to post in conspicuous places, available to employees and applicants for employment, notices to be provided setting forth the provisions of this nondiscrimination clause.
- b. The Contractor will, in all solicitations or advertisements for employees placed by or on behalf of the Contractor, state that all qualified applicants will receive consideration for employment without regard to race, color, religion, sex, sexual orientation, gender identity, or national origin.
- c. The Contractor will not discharge or in any other manner discriminate against any employee or applicant for employment because such employee or applicant has inquired about, discussed, or disclosed the compensation of the employee or applicant or another employee or applicant. This provision shall not apply to instances in which an employee who has access to the compensation information of other employees or applicants as a part of such employee's essential job functions discloses the compensation of such other employees or applicants to individuals who do not otherwise have access to such information, unless such disclosure is in response to a formal complaint or charge, in furtherance of an investigation, proceeding, hearing, or action, including an investigation conducted by the employer, or is consistent with the Contractor's legal duty to furnish information.

FEDERAL PROVISIONS ADDENDUM

- d. The Contractor will send to each labor union or representative of workers with which he has a collective bargaining agreement or other contract or understanding, a notice to be provided advising the said labor union or workers' representatives of the Contractor's commitments under this section, and shall post copies of the notice in conspicuous places available to employees and applicants for employment.
- e. The Contractor will comply with all provisions of [Executive Order 11246](#) of September 24, 1965, and of the rules, regulations, and relevant orders of the Secretary of Labor.
- f. The Contractor will furnish all information and reports required by [Executive Order 11246](#) of September 24, 1965, and by rules, regulations, and orders of the Secretary of Labor, or pursuant thereto, and will permit access to his books, records, and accounts by the administering agency and the Secretary of Labor for purposes of investigation to ascertain compliance with such rules, regulations, and orders.
- g. In the event of the Contractor's noncompliance with the nondiscrimination clauses of this contract or with any of the said rules, regulations, or orders, this Contract may be canceled, terminated, or suspended in whole or in part and the Contractor may be declared ineligible for further Government contracts or federally assisted construction contracts in accordance with procedures authorized in [Executive Order 11246](#) of September 24, 1965, and such other sanctions may be imposed and remedies invoked as provided in [Executive Order 11246](#) of September 24, 1965, or by rule, regulation, or order of the Secretary of Labor, or as otherwise provided by law.
- h. The Contractor will include the portion of the sentence immediately preceding paragraph (1) and the provisions of paragraphs (1) through (8) in every subcontract or purchase order unless exempted by rules, regulations, or orders of the Secretary of Labor issued pursuant to section 204 of [Executive Order 11246](#) of September 24, 1965, so that such provisions will be binding upon each subcontractor or vendor. The Contractor will take such action with respect to any subcontract or purchase order as the administering agency may direct as a means of enforcing such provisions, including sanctions for noncompliance:

Provided, however, that in the event a Contractor becomes involved in, or is threatened with, litigation with a subcontractor or vendor as a result of such direction by the administering agency, the Contractor may request the United States to enter into such litigation to protect the interests of the United States.

The applicant further agrees that it will be bound by the above equal opportunity clause with respect to its own employment practices when it participates in federally assisted construction work: *Provided*, that if the applicant so participating is a State or local government, the above equal opportunity clause is not

FEDERAL PROVISIONS ADDENDUM

applicable to any agency, instrumentality or subdivision of such government which does not participate in work on or under the contract.

The applicant agrees that it will assist and cooperate actively with the administering agency and the Secretary of Labor in obtaining the compliance of contractors and subcontractors with the equal opportunity clause and the rules, regulations, and relevant orders of the Secretary of Labor, that it will furnish the administering agency and the Secretary of Labor such information as they may require for the supervision of such compliance, and that it will otherwise assist the administering agency in the discharge of the agency's primary responsibility for securing compliance.

The applicant further agrees that it will refrain from entering into any contract or contract modification subject to Executive Order 11246 of September 24, 1965, with a contractor debarred from, or who has not demonstrated eligibility for, Government contracts and federally assisted construction contracts pursuant to the Executive Order and will carry out such sanctions and penalties for violation of the equal opportunity clause as may be imposed upon contractors and subcontractors by the administering agency or the Secretary of Labor pursuant to Part II, Subpart D of the Executive Order. In addition, the applicant agrees that if it fails or refuses to comply with these undertakings, the administering agency may take any or all of the following actions: Cancel, terminate, or suspend in whole or in part this grant (contract, loan, insurance, guarantee); refrain from extending any further assistance to the applicant under the program with respect to which the failure or refund occurred until satisfactory assurance of future compliance has been received from such applicant; and refer the case to the Department of Justice for appropriate legal proceedings.

2. Davis-Bacon Act (Prevailing Wage)

If this Contract is a **prime construction contract** in excess of \$2,000, the Contractor (and its Subcontractors) must comply with the Davis-Bacon Act ([40 USC 3141-3148](#)) as supplemented by Department of Labor regulations ([29 CFR Part 5](#), "Labor Standards Provisions Applicable to Contracts Covering Federally Financed and Assisted Construction"), and during performance of this Contract the Contractor agrees as follows:

- a. All transactions regarding this contract shall be done in compliance with the Davis-Bacon Act (40 U.S.C. 3141- 3144, and 3146-3148) and the requirements of 29C.F.R. pt. 5 as may be applicable. The contractor shall comply with 40 U.S.C. 3141-3144, and 3146-3148 and the requirements of 29 C.F.R. pt. 5 as applicable.
- b. Contractors are required to pay wages to laborers and mechanics at a rate not less than the prevailing wages specified in a wage determination made by the Secretary of Labor.
- c. Additionally, contractors are required to pay wages not less than once a week.

FEDERAL PROVISIONS ADDENDUM

3. Copeland “Anti-Kickback” Act

If this Contract is a contract for construction or repair work in excess of \$2,000 where the Davis-Bacon Act applies, the Contractor must comply with the Copeland “Anti-Kickback” Act ([40 USC 3145](#)), as supplemented by Department of Labor regulations ([29 CFR Part 3](#), “Contractors and Subcontractors on Public Building or Public Work Financed in Whole or in Part by Loans or Grants from the United States”), which prohibits the Contractor and subrecipients from inducing, by any means, any person employed in the construction, completion, or repair of public work, to give up any part of the compensation to which he or she is otherwise entitled, and during performance of this Contract the Contractor agrees as follows:

- a. **Contractor.** The Contractor shall comply with 18 U.S.C. § 874, 40 U.S.C. § 3145, and the requirements of 29 C.F.R. pt. 3 as may be applicable, which are incorporated by reference into this contract.
- b. **Subcontracts.** The Contractor or Subcontractor shall insert in any subcontracts the clause above and such other clauses as FEMA or the applicable federal awarding agency may by appropriate instructions require, and also a clause requiring the Subcontractors to include these clauses in any lower tier subcontracts. The prime contractor shall be responsible for the compliance by any subcontractor or lower tier subcontractor with all of these contract clauses.
- c. **Breach.** A breach of the contract clauses above may be grounds for termination of the contract, and for debarment as a Contractor and Subcontractor as provided in 29 C.F.R. § 5.12.

4. Contract Work Hours and Safety Standards Act

If the Contract is **in excess of \$100,000** and **involves the employment of mechanics or laborers**, the Contractor must comply with [40 USC 3702](#) and [3704](#), as supplemented by Department of Labor regulations ([29 CFR Part 5](#)), as applicable, and during performance of this Contract the Contractor agrees as follows:

- a. **Overtime requirements.** No Contractor or Subcontractor contracting for any part of the contract work which may require or involve the employment of laborers or mechanics shall require or permit any such laborer or mechanic in any workweek in which he or she is employed on such work to work in excess of forty hours in such workweek unless such laborer or mechanic receives compensation at a rate not less than one and one-half times the basic rate of pay for all hours worked in excess of forty hours in such workweek.
- b. **Violation; liability for unpaid wages; liquidated damages.** In the event of any violation of the clause set forth in paragraph (1) of this section the Contractor and any Subcontractor responsible therefor shall be liable for the unpaid wages. In addition, such Contractor and Subcontractor shall be liable to the United States (in the case of work done under contract for the District of Columbia or a territory,

FEDERAL PROVISIONS ADDENDUM

to such District or to such territory), for liquidated damages. Such liquidated damages shall be computed with respect to each individual laborer or mechanic, including watchmen and guards, employed in violation of the clause set forth in paragraph (1) of this section, in the sum of \$27 for each calendar day on which such individual was required or permitted to work in excess of the standard workweek of forty hours without payment of the overtime wages required by the clause set forth in paragraph (1) of this section.

- c. **Withholding for unpaid wages and liquidated damages.** The State shall upon its own action or upon written request of an authorized representative of the Department of Labor withhold or cause to be withheld, from any moneys payable on account of work performed by the Contractor or Subcontractor under any such contract or any other Federal contract with the same prime contractor, or any other federally-assisted contract subject to the Contract Work Hours and Safety Standards Act, which is held by the same prime contractor, such sums as may be determined to be necessary to satisfy any liabilities of such contractor or subcontractor for unpaid wages and liquidated damages as provided in the clause set forth in paragraph (2) of this section.
- d. **Subcontracts.** The Contractor or Subcontractor shall insert in any subcontracts the clauses set forth in paragraph (1) through (4) of this section and also a clause requiring the Subcontractors to include these clauses in any lower tier subcontracts. The prime contractor shall be responsible for compliance by any subcontractor or lower tier subcontractor with the clauses set forth in paragraphs (1) through (4) of this section.

5. Rights to Inventions Made Under a Contract or Agreement

If the Contract is funded by a federal “funding agreement” as defined under [37 CFR §401.2 \(a\)](#) and the recipient or subrecipient wishes to enter into a contract with a small business firm or nonprofit organization regarding the substitution of parties, assignment or performance of experimental, developmental, or research work under that “funding agreement,” the recipient or subrecipient must comply with [37 CFR Part 401](#), “Rights to Inventions Made by Nonprofit Organizations and Small Business Firms Under Government Grants, Contracts and Cooperative Agreements,” and any implementing regulations issued by the awarding agency.

6. Clean Air Act and the Federal Water Pollution Control Act

If this Contract is **in excess of \$150,000**, the Contractor must comply with all applicable standards, orders, and regulations issued under the Clean Air Act ([42 USC 7401-7671q](#)) and the Federal Water Pollution Control Act ([33 USC 1251-1387](#)), and during performance of this Contract the Contractor agrees as follows:

Clean Air Act

1. The Contractor agrees to comply with all applicable standards, orders or

FEDERAL PROVISIONS ADDENDUM

regulations issued pursuant to the Clean Air Act, as amended, 42 U.S.C. § 7401 et seq.

2. The Contractor agrees to report each violation to the State and understands and agrees that the State will, in turn, report each violation as required to assure notification to the Federal Emergency Management Agency or the applicable federal awarding agency, and the appropriate Environmental Protection Agency Regional Office.
3. The Contractor agrees to include these requirements in each subcontract exceeding \$150,000 financed in whole or in part with Federal assistance provided by FEMA or the applicable federal awarding agency.

Federal Water Pollution Control Act

1. The Contractor agrees to comply with all applicable standards, orders, or regulations issued pursuant to the Federal Water Pollution Control Act, as amended, 33 U.S.C. 1251 et seq.
2. The Contractor agrees to report each violation to the State and understands and agrees that the State will, in turn, report each violation as required to assure notification to the Federal Emergency Management Agency or the applicable federal awarding agency, and the appropriate Environmental Protection Agency Regional Office.
3. The Contractor agrees to include these requirements in each subcontract exceeding \$150,000 financed in whole or in part with Federal assistance provided by FEMA or the applicable federal awarding agency.

7. Debarment and Suspension

A “contract award” (see [2 CFR 180.220](#)) must not be made to parties listed on the government-wide exclusions in the [System for Award Management](#) (SAM), in accordance with the OMB guidelines at [2 CFR 180](#) that implement [Executive Orders 12549 \(51 FR 6370; February 21, 1986\)](#) and [12689 \(54 FR 34131; August 18, 1989\)](#), “Debarment and Suspension.” SAM Exclusions contains the names of parties debarred, suspended, or otherwise excluded by agencies, as well as parties declared ineligible under statutory or regulatory authority other than [Executive Order 12549](#).

- a. This Contract is a covered transaction for purposes of 2 C.F.R. pt. 180 and 2 C.F.R. pt. 3000. As such, the Contractor is required to verify that none of the Contractor’s principals (defined at 2 C.F.R. § 180.995) or its affiliates (defined at 2 C.F.R. § 180.905) are excluded (defined at 2 C.F.R. § 180.940) or disqualified (defined at 2 C.F.R. § 180.935).
- b. The Contractor must comply with 2 C.F.R. pt. 180, subpart C and 2 C.F.R. pt. 3000, subpart C, and must include a requirement to comply with these regulations in any lower tier covered transaction it enters into.

FEDERAL PROVISIONS ADDENDUM

- c. This certification is a material representation of fact relied upon by the State. If it is later determined that the contractor did not comply with 2 C.F.R. pt. 180, subpart C and 2 C.F.R. pt. 3000, subpart C, in addition to remedies available to the State, the Federal Government may pursue available remedies, including but not limited to suspension and/or debarment
- d. The bidder or proposer agrees to comply with the requirements of 2 C.F.R. pt. 180, subpart C and 2 C.F.R. pt. 3000, subpart C while this offer is valid and throughout the period of any contract that may arise from this offer. The bidder or proposer further agrees to include a provision requiring such compliance in its lower tier covered transactions.

8. Byrd Anti-Lobbying Amendment

Contractors who apply or bid for an award of **\$100,000 or more** shall file the required certification in Exhibit 1 – Byrd Anti-Lobbying Certification below. Each tier certifies to the tier above that it will not and has not used Federal appropriated funds to pay any person or organization for influencing or attempting to influence an officer or employee of any agency, a Member of Congress, officer or employee of Congress, or an employee of a Member of Congress in connection with obtaining any Federal contract, grant, or any other award covered by 31 U.S.C. § 1352. Each tier shall also disclose any lobbying with non-Federal funds that takes place in connection with obtaining any Federal award. Such disclosures are forwarded from tier to tier up to the recipient who in turn will forward the certification(s) to the awarding agency.

9. Procurement of Recovered Materials

Under [2 CFR 200.322](#), Contractors must comply with section 6002 of the Solid Waste Disposal Act, as amended by the Resource Conservation and Recovery Act.

- a. In the performance of this contract, the Contractor shall make maximum use of products containing recovered materials that are EPA-designated items unless the product cannot be acquired:
 - i. Competitively within a timeframe providing for compliance with the contract performance schedule;
 - ii. Meeting contract performance requirements; or
 - iii. At a reasonable price.
- b. Information about this requirement, along with the list of EPA- designated items, is available at EPA’s Comprehensive Procurement Guidelines web site, <https://www.epa.gov/smm/comprehensive-procurement-guideline-cpg-program>.
- c. The Contractor also agrees to comply with all other applicable requirements of Section 6002 of the Solid Waste Disposal Act.

FEDERAL PROVISIONS ADDENDUM

10. Additional FEMA Contract Provisions.

The following provisions apply to purchases that will be paid for in whole or in part with funds obtained from the Federal Emergency Management Agency (FEMA):

1. **Access to Records.** The following access to records requirements apply to this contract:
 - a. The Contractor agrees to provide the State, the FEMA Administrator, the Comptroller General of the United States, or any of their authorized representatives access to any books, documents, papers, and records of the Contractor which are directly pertinent to this contract for the purposes of making audits, examinations, excerpts, and transcriptions
 - b. The Contractor agrees to permit any of the foregoing parties to reproduce by any means whatsoever or to copy excerpts and transcriptions as reasonably needed
 - c. The Contractor agrees to provide the FEMA Administrator or his authorized representatives access to construction or other work sites pertaining to the work being completed under the contract

In compliance with the Disaster Recovery Act of 2018, the State and the Contractor acknowledge and agree that no language in this contract is intended to prohibit audits or internal reviews by the FEMA Administrator or the Comptroller General of the United States.

2. Changes.

See the provisions regarding modifications or change notice in the Contract Terms.

3. DHS Seal Logo and Flags.

The Contractor shall not use the DHS seal(s), logos, crests, or reproductions of flags or likenesses of DHS agency officials without specific FEMA pre-approval.

4. Compliance with Federal Law, Regulations, and Executive Orders.

This is an acknowledgement that FEMA financial assistance will be used to fund all or a portion of the contract. The Contractor will comply with all applicable Federal law, regulations, executive orders, FEMA policies, procedures, and directives.

5. No Obligation by Federal Government.

The Federal Government is not a party to this contract and is not subject to any obligations or liabilities to the State, Contractor, or any other party pertaining to any matter resulting from the Contract.”

6. Program Fraud and False or Fraudulent Statements or Related Acts

The Contractor acknowledges that 31 U.S.C. Chap. 38 (Administrative Remedies for False Claims and Statements) applies to the Contractor’s actions pertaining to this contract.

EXHIBIT 1

BYRD ANTI-LOBBYING CERTIFICATION

Contractor must complete this certification if the purchase will be paid for in whole or in part with funds obtained from the federal government and the purchase is greater than \$100,000.

APPENDIX A, 44 C.F.R. PART 18 – CERTIFICATION REGARDING LOBBYING

Certification for Contracts, Grants, Loans, and Cooperative Agreements

The undersigned certifies, to the best of his or her knowledge and belief, that:

1. No Federal appropriated funds have been paid or will be paid, by or on behalf of the undersigned, to any person for influencing or attempting to influence an officer or employee of an agency, a Member of Congress, an officer or employee of Congress, or an employee of a Member of Congress in connection with the awarding of any Federal contract, the making of any Federal grant, the making of any Federal loan, the entering into of any cooperative agreement, and the extension, continuation, renewal, amendment, or modification of any Federal contract, grant, loan, or cooperative agreement.
2. If any funds other than Federal appropriated funds have been paid or will be paid to any person for influencing or attempting to influence an officer or employee of any agency, a Member of Congress, an officer or employee of Congress, or an employee of a Member of Congress in connection with this Federal contract, grant, loan, or cooperative agreement, the undersigned shall complete and submit Standard Form-LLL, "Disclosure Form to Report Lobbying," in accordance with its instructions.
3. The undersigned shall require that the language of this certification be included in the award documents for all subawards at all tiers (including subcontracts, subgrants, and contracts under grants, loans, and cooperative agreements) and that all subrecipients shall certify and disclose accordingly.

This certification is a material representation of fact upon which reliance was placed when this transaction was made or entered into. Submission of this certification is a prerequisite for making or entering into this transaction imposed by section 1352, title 31, U.S. Code. Any person who fails to file the required certification shall be subject to a civil penalty of not less than \$10,000 and not more than \$100,000 for each such failure.

EXHIBIT 1

BYRD ANTI-LOBBYING CERTIFICATION

The Contractor, Hoekstra Transportation Inc., certifies or affirms the truthfulness and accuracy of each statement of its certification and disclosure, if any. In addition, the Contractor understands and agrees that the provisions of 31 U.S.C. Chap. 38, Administrative Remedies for False Claims and Statements, apply to this certification and disclosure, if any.



Signature of Contractor's Authorized Official

Steve Bolin, Commercial Sales Manager

Name and Title of Contractor's Authorized Official

1-26-21

Date

SCHEDULE A – STATEMENT OF WORK CONTRACT ACTIVITIES

Contract No. 21000000606

Small Bus and Light-Duty Small Bus

BACKGROUND

This contract is used to provide funding to authorized transit agencies in Michigan for the purchase of small class non-lift and lift transit buses.

SCOPE

The Contractor must provide Small Bus and Light-Duty Small Buses per **Schedule B – Specifications** and all other requirements of this solicitation.

REQUIREMENTS

1. General Requirements

1.1. Product Specifications

- A. Contractor must provide Small Bus and Light Duty Small buses per **Schedule B, Specifications** for Light-Duty Small and Small Bus. In the Specification documents, all cells in “Product Detail or Pre-Approved Alternate” column must be completed by Contractor for each item.

Brands or trade names are for identification purposes only and do not limit the Contractor to such brands or trade names.

- B. Chassis serial number, body number, axle ratio, gross vehicle weight rating (GVWR), seating capacity and paint codes shall be imprinted on a permanent decal(s) or stamped on a metal plate(s) and affixed in the driver's area of the vehicle (location to be approved by the State).
- a. The Contractor shall be capable of handling final inspection and corrections required by the State prior to acceptance of the small buses after a contract is awarded.
 - b. The Contractor must provide parts and service for a period of seven (7) years after the vehicles have been placed in service throughout the State of Michigan. The Contractor must supply body replacement parts within five (5) business days of a request by a transit agency unless the Contractor notifies the transit agency that the part is not available for shipment and provides the shipping date when the part will be available.
 - c. Regardless of options and seating plan ordered, the Contractor shall certify that all vehicles delivered shall not exceed the GVWR of chassis as bid (determined by engineering calculated loaded vehicle axle weights). Manufacturers shall comply with the chassis company's quality vehicle manufacturing program such as Ford's Quality Vehicle Modifier (QVM).

SCHEDULE A - STATEMENT OF WORK CONTRACT ACTIVITIES

1.1.1. Alternate Products and Equipment

A. In the **Schedule B, Specifications** for Light-Duty Small and Small Bus wherever brand, manufacturer, or product names are referenced it is included only for establishing a description of the minimum quality required for an item. This inclusion is not to be construed as advocating or prescribing the use of a particular brand, product, or item.

1.1.2. Warranties

The Contractor must provide warranties per **Schedule B, Specifications** for Small Bus and Light Duty Small buses, section C., Item 6.

Requests for warranty repairs should be emailed or phoned to the Contractor prior to corrective action.

The correction will be assigned to an employee, or contracted shop for correction.

The State reserves the right to require additional warranties other than those identified by the Contractor in its response to this RFP.

1.2. Recall Requirements and Procedures

Agencies will be contacted by, phone, email or mail depending on the nature of the recall.

1.3. Quality Assurance Program

The body modifiers use ISO9001.

1.4. Incentives

The Contractor allows trade-ins.

2. Service Levels

2.1. Time Frames

All Contract Activities must be delivered within 210 business days from receipt of order. The receipt of order date is pursuant to the **Notices** section of the Standard Contract Terms. Delivery will be made to the Ordering Entity.

2.2. Training

The Contractor will provide training when necessary, including but not limited to, aspects of ordering, shipping, billing, receiving, and vehicle maintenance. At the request of the State, the Contractor will provide in-service training on products, installation, and product safety issues. The Contractor will also provide training jointly with the Ordering Entity as needed during the period covered by the Contract at no additional charge.

2.3. Reporting

The Contractor must submit to the Program Manager quarterly reports which include agency name, vehicle(s) purchased, options, price, date ordered, date delivered, funding used: (Federal/State/Local).

The State reserves the right to request additional reports.

SCHEDULE A - STATEMENT OF WORK CONTRACT ACTIVITIES

2.4. Meetings

Meetings requested by the State include, but are not limited to, the pilot and production meetings as required per Section 7 - Acceptance, Inspection and Testing.

The State may request other meetings as it deems appropriate.

3. Staffing

3.1. Contractor Representative

The Contractor must appoint a Service Manager, or a Product Representative specifically assigned to State of Michigan accounts who will respond to State inquiries regarding the Contract Activities, answer questions related to ordering and delivery, etc. (the "Contractor Representative").

Steve Bolin – Commercial Sales Manager
Hoekstra Transportation
3741 Roger B Chaffee Blvd.
Grand Rapids, MI 49548
Office 616.389.1130
Mobile 616.299.5170
Email SBolin@Hoekstrainc.com

The Contractor must notify the Contract Administrator at least 14 calendar days before removing or assigning a new Contractor Representative.

3.2. Key Personnel

The Contractor must appoint one individual who will be directly responsible for the day to day operations of the Contract ("Key Personnel"). Key Personnel must be specifically assigned to the State account, be knowledgeable on the contractual requirements, and respond to State inquiries within 24 hours.

Contractor's Key Personnel must be available during the following times: 8:00 am – 5:00 pm

Steve Bolin – Commercial Sales Manager
Hoekstra Transportation
3741 Roger B Chaffee Blvd.
Grand Rapids, MI 49548
Office 616.389.1130
Mobile 616.299.5170
Email SBolin@Hoekstrainc.com

The Contractor may not remove or assign Key Personnel without the prior consent of the State. Prior consent is not required for reassignment for reasons beyond the Contractor's control, including illness, disability, death, leave of absence, personal emergency circumstances, resignation, or termination for cause. The State may request

SCHEDULE A - STATEMENT OF WORK CONTRACT ACTIVITIES

a résumé and conduct an interview before approving a change. The State may require a 30-calendar day training period for replacement personnel.

The Contractor must identify the Key Personnel, indicate where they will be physically located, describe the functions they will perform.

3.3. Non-Key Personnel

The Contractor must notify the Contract Administrator at least 10-calendar days before removing or assigning non-key personnel.

3.4. Organizational Chart

Provide an overall organizational chart that details staff members, by name and title, and subcontractors.

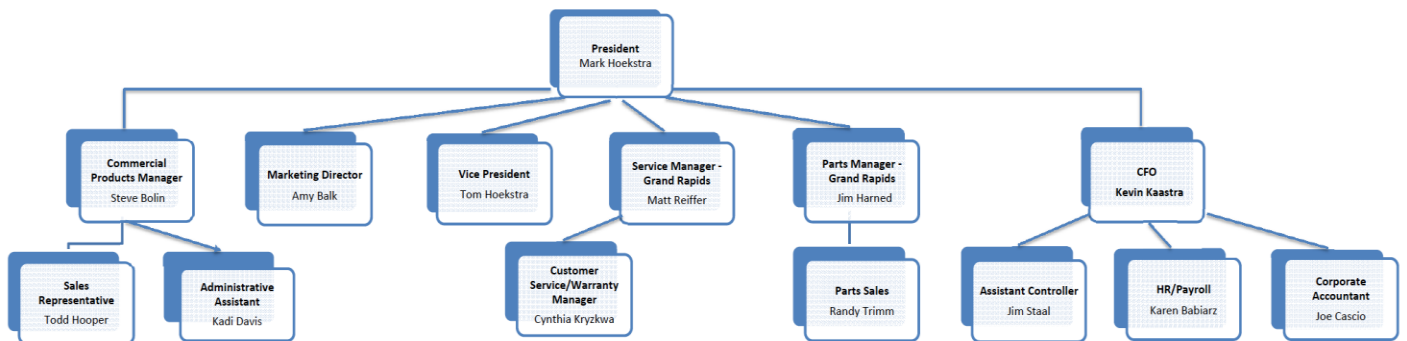

3.5. Customer Service Toll-Free Number

The Contractor must specify its toll-free number for the State to make contact with the Contractor Representative who must be available for calls during the hours of 8 am to 5 pm EST Monday through Friday, at a minimum. Identify customer service availability for this proposal by hours and days of the week.

(800) 444-4104
Hours: 7am to 5pm M-F
Steve Bolin x1130

3.6. Technical Support, Repairs and Maintenance

The Contractor must specify its toll-free number for the State to make contact with the Contractor for technical support, repairs and maintenance. The Contractor must be available for calls and service during the hours of 8 am to 5 pm EST Monday through Friday at a minimum. Identify availability for this proposal by hours and days of the week.

(800) 444-4104
Hours: 7am to 5pm M-F
Matt Reiffer x1125

SCHEDULE A - STATEMENT OF WORK CONTRACT ACTIVITIES

3.7. Disclosure of Subcontractors

If the Contractor intends to utilize subcontractors, the Contractor must disclose the following:

The legal business name; address; telephone number; a description of subcontractor's organization and the services it will provide; and information concerning subcontractor's ability to provide the Contract Activities.

The relationship of the subcontractor to the Contractor. Of the total bid, the price of the subcontractor's work. Whether the Contractor has a previous working experience with the subcontractor. If yes, provide the details of that previous relationship.

A complete description of the Contract Activities that will be performed or provided by the subcontractor.

Potential subcontractors for LPG and CNG alternate Fuel Systems:

Roush Cleantech – 12170 Globe St. Livonia, MI 48150

ICOM North America – 54790 Grand River Ave, New Hudson, MI 48165

Green Alternative Systems – 57475 County Road 3, Elkhart, IN 56517

4. Pricing

4.1. Price Term

Pricing is firm for the entire length of the Contract with exceptions per section "4.2 Price Changes".

4.2. Price Changes

A.

- i. Pricing is firm for a 365 day period ("Pricing Period"). The first pricing period begins on the Effective Date. Adjustments for changes in the chassis manufacturers OEM standard equipment may be requested, in writing, by either party and will take effect no earlier than the next Pricing Period subject to **D.**, and **E.** of this section.
- ii. Adjustments for changes in federal regulations may be submitted at any time during the contract term subject to **C.**, **D.**, and **E.** of this section.

B. The Ordering Entity shall receive the benefit of any decreases in the cost incurred by the Contractor. If the chassis manufacturers OEM standard equipment pricing increases during the Contract period by more than one hundred dollars (\$100.00), the Contractor may request a price revision to reflect the actual cost experienced. The request for a cost increase must be accompanied by evidence from the chassis manufacturer that a change actually affected the Contractor's cost. Additionally, it shall be the Contractor's responsibility to provide written notice to the State of its qualification for price reductions.

SCHEDULE A - STATEMENT OF WORK CONTRACT ACTIVITIES

- C.** If changes in federal regulations affect the cost of the Light-duty Small and Small buses during the Contract period by more than one hundred dollars (\$100.00), the Contractor may request a price revision to reflect the actual cost increase experienced. The request must be accompanied by evidence that the change actually affected the Contractor's cost.
- D.** Requests for price changes shall be received in writing at least 30 days prior to their effective date and are subject to written acceptance before becoming effective. In the event new prices are not acceptable, the Contract may be canceled.
- E.** Per Federal Transit Administration (FTA) requirements, a cost or price analysis is required for all price changes.
 - i.** The State may request a Review upon 30 days written notice that specifies what Deliverable is being reviewed. At the Review, each party may present supporting information including information created by, presented, or received from third parties.
 - ii.** Following the presentation of supporting information, both parties will have 30 days to review the supporting information and prepare any written response.
 - iii.** In the event the Review reveals no need for modifications of any type, pricing will remain unchanged unless mutually agreed to by the parties. However, if the Review reveals that change may be recommended, both parties will negotiate in good faith for 30 days unless extended by mutual agreement of the parties.
 - iv.** If the supporting information reveals a reduction in prices is necessary and Contractor agrees to reduce rates accordingly, then the State may elect to exercise the next one-year option, if available.
 - v.** If the supporting information reveals a reduction in prices is necessary and the parties are unable to reach agreement, then the State may eliminate all remaining Contract renewal options.
 - vi.** Any changes based on the Review must be implemented through the issuance of a Contract Change Notice.

5. Ordering

5.1. Authorizing Document

The appropriate authorizing document for the Contract will be *purchase order* from the authorizing transit agency.

5.2. Order Verification

The Contractor must have internal controls approved by Central Procurement Services, to verify abnormal orders and to ensure that only authorized individuals place orders.

SCHEDULE A - STATEMENT OF WORK CONTRACT ACTIVITIES

5.3 Quantity

The State is not obligated to purchase in any specific quantity. The estimated quantity to order shall be one (1) vehicle. The estimated quantity of production vehicles shall be 400 Light-Duty Small and Small Bus.

6. Delivery

6.1. Delivery Programs

The Contractor will be permitted to drive vehicle(s) to final destinations in compliance with the “**Schedule D - Affidavit for Driver Delivery**”, however, the affidavit must be completed and submitted with the Contractor’s proposal.

- A.** Delivery must be made between the hours of 8:00 a.m. and 4:00 p.m., Monday through Friday ONLY, excluding Holidays.
- B.** The Contractor agrees and will pay the Ordering Entity if they pick the vehicle up at the Contractor’s location. The rate will be equal to the rate paid to the Contractor’s drivers plus provide or reimburse the cost of gasoline/fuel.
- C.** The vehicle will be driven to the final destination and delivery will be scheduled with the Ordering Entity.

6.2. General Delivery

The State and/or the Ordering Entities have the right to refuse vehicle delivery if the following conditions are not met. For the delivery of all units that may be released against the Contract the following must apply:

- A.** The Contractor should produce the pilot model as the first Light-duty Small and Small bus ordered by the State for its transit agencies.
- B.** The Light-duty Small and Small bus should be:
 - i.** lift / non-lift equipped
 - ii.** air conditioned
 - iii.** the largest size on request by the transit agencies.
- C.** All necessary testing and equipment placement should be performed on the pilot models before final inspection/acceptance by the State.
- D.** The pilot model should serve as a standard for the following units as ordered but should not relieve the Contractor from an obligation to manufacture all units in compliance with all specifications.

SCHEDULE A - STATEMENT OF WORK CONTRACT ACTIVITIES

7. Acceptance, Inspection, and Testing

7.1. Acceptance

The State will use the following criteria to determine acceptance of the Contract Activities:

- A.** The Contractor shall complete all corrections required by the State or Ordering Entity prior to delivery and final acceptance.
- B.** Delivery of Production Chassis to the Body Manufacturer should be within 120 days after the Pre-Pilot Model Meeting.
- C.** Exact Production for Delivery Due Dates will be determined by the delivery schedule, plus (+) seven (7) calendar days from issue dated indicated on the Purchase Order. Delivery should be at the rate of one (1) unit per week minimum until completion of the quantity ordered.

7.2. Inspection

A. Pilot, Production Model and Plant Inspections:

- i. Pilot Model Review Meeting at the Manufacturer's facility, or at a mutually agreed upon location, shall be conducted within thirty (30) calendar days from the date of the Purchase Order.
- ii. Pilot Model Approvals, shall be completed by the State and/or receiving agency within thirty (30) calendar days after delivery of the pilot model by the ordering agency.
- iii. Periodic Production/Plant Inspections, by the Michigan Department of Transportation, Office of Passenger Transportation include two (2) per contract period.
- iv. Final inspection shall be made at a site(s) as agreed upon by the Contractor and the ordering agencies. The Contractor should be capable of handling final inspection and corrections required by the State prior to acceptance of the Light-duty Small and Small bus after a Contract is awarded. The Contractor should be responsible for transportation (air fare, rail fare, car rental, taxi, or mileage), lodging, parking expenses, meals, and tips for up to three (3) individuals, as determined by the Michigan Department of Transportation, Office of Passenger Transportation, for involvement in any of the above pilot model and production schedule review or plant inspections. All travel expenses should be based on the DTMB, Vehicle and Travel Services Schedule of Travel Rates for Classified and Unclassified Employees Effective January 1, 2011 or subsequent updates.
http://www.michigan.gov/dmb/0,4568,7-150-9141_13132---,00.html

SCHEDULE A - STATEMENT OF WORK CONTRACT ACTIVITIES

7.3. Testing

A. Testing - Prior to delivery, the Contractor must certify that:

- i. All quality assurance activities have been completed.
- ii. All applicable testing has been completed.
- iii. All material deficiencies discovered during the quality assurance activities and testing have been corrected.

The Deliverable or Service is in a suitable state of readiness for the State's review and approval.

B. If a Deliverable includes installation at the Ordering Entity location the Contractor must:

- i. Perform any applicable testing.
- ii. Correct all material deficiencies discovered during the quality assurance activities and testing.

Inform the State that the unit is in a suitable state of readiness for the State's review and approval.

C. To the extent that testing occurs at the Ordering Entity's location personnel are entitled to observe or otherwise participate in testing.

7.4. Final Acceptance

Final Acceptance is when the project is completed and functions according to the requirements listed in all previous sections of this document. Any intermediate acceptance of sub-Deliverables does not complete the requirement of Final Acceptance.

The State and /or the Ordering Entity have the right to refuse vehicle delivery when the conditions listed above are not met.

8. Invoice and Payment

8.1. Invoice Requirements

All invoices submitted to the State must include: **(a)** date; **(b)** purchase order number; **(c)** contract number; **(d)** quantity; **(e)** description of the Contract Activities; **(f)** line items for up-fitting options **(g)** unit price; **(h)** shipping cost (if any); and **(i)** total price; **(j)** Ordering Entity; **(k)** VIN number.

8.2. Payment Methods

The Ordering Entities will make payment for Contract Activities to the Contractor.

SCHEDULE A - STATEMENT OF WORK CONTRACT ACTIVITIES

8.3. Procedure

The Ordering Entities have been instructed to make immediate inspection on receipt of units and to process payment documents promptly. Payments, however, will be delayed if the Light-duty Small and Small bus fails to comply with specification requirements. Therefore, it is incumbent upon the Contractor to close pre-delivery inspection in accordance with the contract requirements.

9. Liquidated Damages

Late or improper completion of the Contract Activities will cause loss and damage to the State and it would be impracticable and extremely difficult to fix the actual damage sustained by the State. Therefore, if there is late or improper completion of the Contract Activities the State is entitled to collect liquidated damages in the amount of \$5,000 and an additional \$100 per day for each day Contractor fails to remedy the late or improper completion of the Work.

Unauthorized Removal of Key Personnel will interfere with the timely and proper completion of the Contract, to the loss and damage of the State, and it would be impracticable and extremely difficult to fix the actual damage sustained by the State. Therefore, the State may assess liquidated damages against Contractor as specified below.

The State is entitled to collect \$1,000 per individual per day for the removal of any Key Personnel without prior approval of the State.

The State is entitled to collect \$1,000 per individual per day for an unapproved or untrained key personnel replacement.

10. Additional Requirements

10.1. Environmental and Energy Efficiency Product Standards

The Contractor must identify any energy efficient, bio-based, or otherwise environmentally friendly products used in the products. Contractor must include any relevant third-party certification, including the verification of a United States Department of Agriculture certified bio-based product label. Contractor must describe how products that meet these requirements are identified or otherwise labelled and list any exceptions to this requirement.

SCHEDULE A - STATEMENT OF WORK CONTRACT ACTIVITIES

10.2. Hazardous Chemical Identification

In accordance with the federal Emergency Planning and Community Right-to-Know Act, 42 USC 11001, *et seq.*, as amended, the Contractor must provide a Material Safety Data Sheet listing any hazardous chemicals as defined in 40 CFR §370.2, to be delivered. Each hazardous chemical must be properly identified, including any applicable identification number, such as a National Stock Number or Special Item Number.

The Contractor must identify any hazardous chemicals that will be provided under any resulting contract.

10.3. Mercury Content

Pursuant to MCL 18.1261d, mercury-free products must be procured when possible. The Contractor must explain if it intends to provide products containing mercury, the amount or concentration of mercury, and whether cost competitive alternatives exist. If a cost competitive alternative does exist, the Contractor must provide justification as to why the particular product is essential. All products containing mercury must be labeled as containing mercury.

10.4. Brominated Flame Retardants

The State prefers to purchase products that do not contain brominated flame retardants (BFRs) whenever possible. The Contractor must disclose whether the products contain BFRs and describe how the products are identified or otherwise labelled.

STATE OF MICHIGAN

Contract No. 21000000606

**Schedule B
State of Michigan
Office of Passenger Transportation
Specifications for
Small Class of Buses, Class I - 5 Years/150,000 Miles (minimum); Class II - 7-Years/200,000 Miles (minimum)
of Non-lift and Lift Transit Buses with Alternate Seating**

I. PURPOSE OF SPECIFICATIONS

These specifications are setting forth the minimum requirements for a two-axle, transit class commercial non-lift bus or a Paratransit type commercial bus equipped with a commercial wheelchair lift. The body shall be mounted on a commercial or recreational vehicle (RV) chassis. At a minimum, buses must meet all applicable Michigan Motor Carrier Vehicle Codes, all applicable Federal Motor Vehicle Safety Standards (FMVSS), and the Americans with Disabilities Act (ADA).

Buses in these specifications shall be defined by the following classes:

- A. Small Class One: Minimum 11,500 GVWR
- B. Small Class Two: Minimum 14,200 GVWR

The Small Class of buses must be capable of seating a minimum of 11 adult forward facing passengers or an alternate capacity of ambulatory adult passengers and wheelchair passengers. The buses shall be fully and/or partially tested (a related full report shall be submitted with any partial test for each fuel type, Gasoline, and Propane) at the Penn State/Thomas D. Larson Pennsylvania Transportation Institute – the Altoona Bus Research and Testing Center and must certify the following with a copy of the “Altoona Bus Test Report”:

- A. The bus model(s) offered is a minimum Class One - 5 years/150,000, Class Two – 7 years/200,000 mile bus service life category.
- B. Will meet the requirements of Federal Register Rules and Regulations 49 CFR Part 665, Bus Testing Program.
- C. Testing is required for a manufacturer of a new bus model or a bus produced with a major change in component or configuration shall provide a copy of the test report(s) as specified in §665.11 and § 665.13.
- D. Bidders shall submit any and all reports related to the buses in this bid as specified in §665.11 and § 665.13

Chassis serial number, body number, axle ratio, gross vehicle weight rating (GVWR), seating capacity and paint codes shall be imprinted on a permanent decal(s) or stamped on a metal plate(s) and affixed in the driver's area of the bus (location to be approved by the State).

Regardless of options and seating plan ordered, the successful bidder shall be responsible for certifying that all buses delivered: 1) shall not exceed the GVWR of chassis as bid (determined by engineering calculated loaded vehicle axle weights), and 2) single wheelchair securement area buses shall not exceed 21' 11" in length measured bumper to bumper excluding the energy absorbing portion of the bumper (distance of travel allowed for compression of the bumper without body deformation). Manufacturers shall comply with the chassis company's quality vehicle manufacturing program such as Ford's Quality Vehicle Modifier (QVM).

A. Please refer to Schedule A Statement of Work, section 1.1, A. thru J. for additional specification requirements.

II. BODY SPECIFICATIONS

A. GENERAL DESIGN AND CONSTRUCTION

INSTRUCTIONS: Where applicable, Bidder should specify either suggested source or pre-approved alternate and/or provide detail for all items.

Specification Requirement	Suggested Source or Pre-Approved Alternate
1) SAFETY: The chassis and body shall be designed using only prudent, proven engineering principles with all work performed only by professional established firms. The bus purchased shall comply with all State regulations and requirements applicable to the design and manufacture of motor buses for the State of Michigan.	Complies with Specification - understand that the buses provided must comply with all State regulations and requirements applicable to the design and manufacture of buses for the State of Michigan
2) DRIVER SIZE and COMFORT: Design criteria of bus purchased shall be for all females from the 5th percentile, to	Complies with specification - understand that the buses provided must provide driver comfort and

<p>males of the 95th percentile, to be equally as comfortable in using all controls required to safely drive and maneuver the bus. All driver controls shall comply with FMVSS 101, with hand and foot controls required to operate the bus safely, including the placement of exterior adjustable mirrors, positioned to meet this safety requirement.</p>	<p>convenience and meet all applicable FMVSS standards.</p>
<p>3) QUALITY of WORKMANSHIP: All labor employed in both the manufacturing and assembly processes of the bus purchased shall be to the highest industry standards. The entire bus shall be within all established engineering tolerances set by all parties involved in the design and production of the bus. All added components shall be installed and positioned according to the component manufacturer's installation procedures which shall be available upon request.</p>	<p>Complies - will provide buses built to all Federal and State guidelines using Lien 5S production, ISO 9001 and Ford QVM guidelines.</p>
<p>4) WELDING: All welding procedures used throughout the construction of the bus, including materials, qualifications and training of personnel, shall be in accordance with the standards of the American Society for Testing and Materials (ASTM) and the American Welding Society (AWS). Contact surfaces of all material to be welded shall be clean, and free of grease, paint, rust and scale. After welding, all rough edges and surfaces on parts shall be ground smooth and coated with a corrosion inhibiting primer and paint.</p>	<p>Only certified welders that weld to standards outlined here will be used.</p>
<p>5) ATTACHMENT HARDWARE: All rivets, screws, bolts, nuts, washers and other types of fasteners used in the construction process, including those that would be exposed to the elements, shall be of appropriate size and strength rating for the application. They shall be sprayed with or dipped in a rust-resistant coating material, be plated, be stainless steel, or otherwise be made of rust-resistant type material, all of which will pass the 480 hour ASTM B117 Salt Spray test and the 480 hour ASTM D2247 Humidity Resistance test (see section C. Vendor/Manufacturer Requirements, subsection 8. Bid Documents, items v. & x.). Fasteners used by the respective component manufacturers in their assemblies are acceptable as part of the assembly.</p>	<p>Hardware meeting this requirement shall be used.</p>
<p>B. BODY STRUCTURE AND EXTERIOR PANELS</p>	
<p>BODY S</p>	
<p>1) Metal Rollover Frame, Cage-type Construction</p>	<p>See Schedule B – METAL – Small Bus Specifications AD2</p>
<p>a. The bus shall have a heavy-duty, unit-body structure type. The body structure (rollover frame, cage type of gauge #16 steel, 0.060" or equal, minimum) shall be of durable steel or aluminum construction insulated against electrolysis between dissimilar metals, and adequately reinforced at all joints and points of stress, with sufficient strength to comply with the FMVSS 220 rollover protection test. All body and floor structural members (tubes, channels, etc.) shall be Gas Metal Arc Welded (GMAC) or equal at each joint. A MIG welding system is acceptable provided it meets the requirements of this specification. Each bidder shall provide certification with the bid, that the bus meets the FMVSS 220 rollover protection test as bid (see section C. Vendor/Manufacturer Requirements, subsection 8. Bid Documents, item k.).</p>	<p>See Schedule B – METAL – Small Bus Specifications AD2</p>
<p>b. The bus shall be designed to withstand road shocks, stop, and start operations, seasonal weather and road extremes,</p>	<p>See Schedule B – METAL – Small Bus Specifications AD2</p>

<p>and other conditions found in Michigan transit bus service. The body shall be securely fastened to the chassis frame structure using a method of uniform attachment consisting of strategically placed rubber isolators/cushions <u>consistent with cab/chassis isolators/cushions</u> with connector bolts that permit body flexing independent of chassis flexing. Roof, side, front, and back panels shall be secured to the body vertical and horizontal frame members, and these, when fastened to the floor structural members, result in a permanent, fully-integrated structural unit adequately reinforced at all points where stress concentration may occur. The wall structure shall be welded or bolted to the floor with grade 8 bolts to provide adequate stability in the event of a non-static rollover event. The body floor sub-frame assembly, including lower skirt reinforcements, shall be, at a minimum, gauge number 14 (.075" thickness) galvanized steel (mill applied), or gauge number 16 stainless steel, or gauge number 12 aluminum, or gauge number 14 steel treated with corrosion resistant coating. All body floor sub-frame assembly shall meet the 480 hour salt spray test per ASTM procedure B-117, with no structural detrimental effects to normally visible surfaces. Certification of compliance with this requirement shall be published by an independent company and be submitted with the bid (see section C. Vendor/Manufacturer Requirements, subsection 8. Bid Documents, item v.). Wheelwells shall have minimum yield strength of gauge number 14 (.075" thickness) galvanized steel, gauge number 16 (.060" thickness) stainless steel, or gauge number 12 (.10" thickness) aluminum properly welded or secured with approved corrosion resistant fasteners to the floor structure. The entire body cage and frame including floor structure shall be properly coated with a corrosion resistant coating or a non-water permeable primer/paint. All components treated to resist corrosion shall be properly cleaned to remove greases, oils, and residues before application of the corrosion resistant material. Passage holes provided for wiring and hoses shall be thoroughly sealed to prevent dust and moisture intrusion and be sufficiently protected to ensure against wear from friction and the elements. When completed, all body side sections and roof sections including structure shall be at a minimum 1-1/4" thick. Where body segments are joined they shall be properly sealed to prevent intrusion of drafts, fumes, dust, and water to the interior of the bus body. Roof shall allow no pooling of water.</p>	
<p>c. All exterior side and roof panel material shall be fiberglass reinforced plastic (FRP), it shall have as a minimum, of 2.16 mm (0.080") thick material (comprised of various layers of gel-coat, reinforcement and resins) or .040" FRP with a 2.7mm (.106") Azdel backer. It shall be designed to resist impact caused by flying road debris. The material must resist rot, corrosion, and mildew and cannot be affected by cleaning related chemicals, road residue, or environmental exposure. Reinforcements shall be installed around all window openings in order to transfer stress around the opening. All door openings shall have full structural framing (tube) or imbedded reinforcements, equal to the structural members of the body that will adequately support concentrations of stress around openings. All exposed doorframe structure shall be made</p>	<p>See Schedule B – METAL – Small Bus Specifications AD2</p>

<p>of 400 series stainless steel (including the fasteners), which does not discolor with age. Where a stiffener or a backer material (substrate) is used for the exterior panels, it shall be bonded with waterproof adhesive to the exterior panel; it shall be a water resistant material that will not wick water; and it must be thoroughly sealed from the elements when installed so that the substrate will not be exposed to or absorb moisture and cause corrosion to the interior of the panel or any body structure. Exterior panel substrate shall not be of wood composition, plywood or a pressed wood product. Where body segments are joined, they shall be properly sealed to prevent intrusion of drafts, fumes, dust, and water to the interior of the bus body.</p>	
<p>d. All interior panels and trim may be made of scuff-resistant laminate/FRP or molded ABS finished material. Interior panels shall have as a minimum the physical properties of gauge number 24 (.024" thickness). Interior panel substrate shall not be of wood composition, plywood or a pressed wood product. Interior panel threaded fasteners or rivets shall secure panels to body framing structure. Where fasteners are in the panels only, a reinforcing nut or reinforcing panel shall be installed for added strength and fastener retention. Overhead compartment and fuse panel covers/doors only shall be made of the same material as interior panels or may be padded with plywood backers. Panels must allow for permanent adhesion of signage.</p>	<p>See Schedule B – METAL – Small Bus Specifications AD2</p>
<p>e. Exterior lower skirt panels shall be fiberglass or composite material and shall be sufficiently stiff to prevent vibration, drumming, or flexing while the bus is in service. Lower edge of skirt panels shall be re-enforced to prevent cracking/breaking due to excessive flexing. Body front and/or rear endcaps may be molded fiberglass panels installed with required structural framing or a FRP composite structure. Lower skirt panels may be one piece in length at manufacture but shall be repairable in sections. Lower skirt panels shall not use a wood substrate material for a panel stiffener. Where exterior panels are lapped, the upper or forward panels shall act as a watershed. Exterior panels that are cut shall have the cut edge sealed (paint or special sealing compound). Sealing and fastening of panel joints, including front and rear cap-to-body joints, shall prevent entrance of moisture and dirt. Joint sealing shall be made through use of a non-shrinking bonding sealant, and joint sealing shall not be solely dependent on an exterior trim strip or a trim cap nor shall the sealing of the panels be dependent on caulking alone. Any visible caulk shall be painted after water testing is complete. All exterior panels shall be buck riveted and/or bonded to the body frame structure.</p>	<p>See Schedule B – METAL – Small Bus Specifications AD2</p>
<p>f. The exterior body panels shall have on each side one heavy-duty rubrail. Rubrails (1½" x ½" minimum) shall be extruded UV resistant plastic with a flexible, rubber-type resilient material insert or a solid rubber-type of flexible, resilient material. Rubrails shall be located no less than 25" nor more than 43" above the ground on each side. Where the rubrails and fender opening guards are not an integral part of the body, installation of rubrails shall be made after the finish coat of paint is applied to the bus. Rubrails shall be sealed to prevent debris seepage into and from behind rubrail.</p>	<p>See Schedule B – METAL – Small Bus Specifications AD2</p>

<p>g. Gun installed huckbolt fastenings, buck rivets, bonding adhesives, or approved equivalent shall be utilized on all exterior body panels, rubrails, and all other locations where stress is concentrated. All rivets, screws, bolts, nuts, washers, clamps, and other types of fasteners used in the construction process, including those that would be exposed to the elements, on the exterior and interior of the unit shall be properly plated to resist corrosion. <u>No sheet metal screws shall be permitted, including self-tapping/drilling screws.</u> except for rubrails and rubber fender splash guards (see mudflaps/splash guards) which can be secured with stainless steel or equivalent plated locking-type, self-tapping fasteners. Fastener materials shall be compatible with materials being fastened. Where self-tapping fasteners are used, body panels shall be reinforced with steel backing, aluminum backing, or stainless-steel backing.</p>	<p>See Schedule B – METAL – Small Bus Specifications AD2</p>
<p>h. Window openings cut into body panels shall have a maximum frame clearance of 3/16" on each side to minimize the need for caulking (see Section 24, Windows). All openings cut into metal body exterior panels must have the exposed cut edges primed or properly coated to inhibit water intrusion and corrosion before further assembly or painting occurs. Window frames installed in the body openings shall be properly caulked/sealed to prevent intrusion of moisture and dust. Drip rails shall be installed the entire length of the bus body above windows and doors.</p>	<p>See Schedule B – METAL – Small Bus Specifications AD2</p>
<p>i. The Contractor shall submit roof, sidewall, and flooring drawings showing structure and structural specifications indicating metal size and type used. Include side sheathing and inside panels (see section C. Vendor/Manufacturer Requirements, subsection 8. Bid Documents, items e.).</p>	<p>See Schedule B – METAL – Small Bus Specifications AD2</p>
<p>2) Fiberglass Reinforced Plastic (FRP) Composite Unitized-type Body</p>	
<p>a. The bus body shall have a heavy-duty unitized structure and shall be of durable fiberglass reinforced plastic (FRP) composite construction. The body panels shall consist of an exterior high gloss gelcoat (.020" thickness, minimum) on a resin-hardened FRP (3/16" thickness, minimum) attached to a center layer of resin hardened Nida-Core® or equal honeycomb (¾" thickness, minimum) with an inner FRP panel (3/16" thickness, minimum); or may be ¾" polyurethane foam insulation gelcoated to ¼" FRP exterior with ¼" FRP interior, reinforced with steel perimeter and transverse supports, completely fiberglassed to adjoining body parts. It shall use proper adhesive materials to adequately bond and mechanically fasten all joints and points of stress with sufficient strength to comply with the FMVSS 220 rollover protection test. Each bidder shall provide certification with the bid, that the bus meets the FMVSS 220 rollover protection test as bid (see section C. Vendor/Manufacturer Requirements, subsection 8. Bid Documents, item k.).</p>	<p>Complies with specification: Fiberglass reinforced plastic body integrated with steel reinforced construction for secure attachment points. Interlocked resin saturated fiberglass matting and mechanical fasteners, forming a unibody design. Matrix of fiberglass reinforced plastic with an inner thickness of Nidacor resin-hardened honeycomb material. Also includes Nidacore (plastic honeycomb) around all openings (i.e. windows, roof hatches etc.)</p>
<p>b. The bus shall be designed to withstand road shocks, stop and start operations, seasonal weather and road extremes, and other conditions found in Michigan transit bus service. The body shall be securely fastened to the chassis frame structure using a method of uniform attachment consisting of strategically placed rubber isolators/cushions <u>consistent</u></p>	<p>Complies with specification – See equipment list F for greater detail</p>

<p>with cab/chassis isolators/cushions with connector bolts that permit body flexing independent of chassis flexing. Roof, side, front, and back panels shall be secured to the floor and lower body frame members; all of which shall result in a permanent, fully-integrated structural unit adequately reinforced at all points where stress concentration may occur. The body floor sub-frame assembly, including lower skirt reinforcements, shall be, at a minimum, gauge number 14 (.075" thickness) galvanized steel (mill applied), or gauge number 16 stainless steel, or gauge number 12 aluminum, or gauge number 14 steel treated with corrosion resistant coating, insulated against electrolysis between dissimilar metals. All body floor sub-frame assembly shall meet 1,000-hour salt spray test per ASTM procedure B-117, with no structural detrimental effects to normally visible (see section C. Vendor/Manufacturer Requirements, subsection 8. Bid Documents, item w.). Certification of compliance with this requirement shall be published by an independent company and be submitted with the bid. Wheelwells shall have minimum yield strength of gauge number 14 galvanized steel, gauge number 16 (.060" thickness) stainless steel, or gauge number 12 (.10" thickness) aluminum properly welded or secured with approved corrosion resistant fasteners to the floor structure. Passage holes provided for wiring and hoses shall be thoroughly sealed to prevent dust and moisture intrusion. The entire lower body frame shall be coated with corrosion resistant primer/paint (steel) or properly treated to resist corrosion (other materials). All treated components shall be properly cleaned to remove greases, oils, and residues before application of the corrosion resistant material.</p>	
<p>c. All exterior side and roof panels when completed shall be at a minimum 1-1/8" thick. Bond lines at the sidewalls, rear endcap, roof, and front cap shall be interlocked by adhesives, resin saturated fiberglass matting, and mechanical fasteners, forming a unibody design without exposed fasteners or protruding moldings. Imbedded reinforcements shall be installed at all door openings to support door mounting hardware and door operating mechanisms. All door openings shall have full structural metal framing to maintain integrity of the body structure. All exposed doorframe structure shall be made of 400 series stainless steel (including the fasteners), which does not discolor with age. Where a stiffener or a backer material (substrate) is used for the exterior panels, it shall be bonded with waterproof adhesive to the exterior panel; it shall be a water resistant material that will not wick water; and it must be thoroughly sealed from the elements when installed so that the substrate will not be exposed to or absorb moisture and cause corrosion to the interior of the panel or any body structure. Roof shall allow no pooling of water.</p>	<p>Complies with specification – See Equipment List F and the Technical Drawings included with proposal for greater details.</p>
<p>d. Interior panels may be an integral part of the FRP composite panel or may be made of scuff-resistant laminate/FRP finished material. Where threaded fasteners are in the interior panel only, an imbedded reinforcing nut or a reinforcing panel shall be integrated into the FRP composite for added strength and fastener retention. Overhead compartment and fuse panel covers/doors only shall be made of the same material as interior panels or</p>	<p>Complies with specification – See Equipment List F and the Technical Drawings included with proposal for greater details.</p>

<p>may be padded with plywood backers. Panels must allow for permanent adhesion of signage.</p>	
<p>e. Exterior panels may be an integral part of the FRP composite panel. Exterior panels shall be sufficiently stiff to prevent vibration, drumming, or flexing while the bus is in service. Lower skirt panels shall be sufficiently fastened and braced to prevent damage from ice and snow build-up. Lower skirt panels may be one piece in length at manufacture but shall be repairable in sections. Where panels are lapped, the upper and/or forward panels shall overlap the lower and/or rearward panels to prevent intrusion of water under the panels. Sealing and fastening of joints, including front and rear cap-to-body joints, shall prevent entrance of moisture and dirt. Any visible caulk shall be painted after water testing is complete. All exterior panels shall be bonded to the lower body frame. In no case shall the sealing of the panels be dependent on caulking alone.</p>	<p>Complies with specification – See Equipment List F and the Technical Drawings included with proposal for greater details.</p>
<p>f. The exterior body panels shall have on each side one heavy-duty rubrail. Rubrails (1½" x ½" minimum) shall be extruded UV resistant plastic with a flexible, rubber-type resilient material insert or a solid rubber-type of flexible, resilient material. Rubrails shall be located no less than 25" nor more than 43" above the ground on each side. Where the rubrails are not an integral part of the body, installation of rubrails shall be made after the finish coat of paint is applied to the bus. Rubrails shall be sealed to prevent debris seepage into and from behind rubrail.</p>	<p>Complies with specification – See Equipment List F and the Technical Drawings included with proposal for greater details. Rubrails included.</p>
<p>g. <u>No sheet metal screws shall be permitted, including self-tapping/drilling screws</u>, except for rubrails and rubber fender splash guards which can be secured with stainless steel locking-type, self-tapping fasteners. Fastener materials shall be compatible with materials being fastened and meet the 480 hour ASTM B117 Salt Spray test and the 480 hour ASTM D2247 Humidity Resistance test (see section C. Vendor/Manufacturer Requirements, subsection 8. Bid Documents, items v. & x.). Where self-tapping fasteners are used in body panels, the body panels shall have an imbedded reinforcing nut or a reinforcing panel shall be integrated into the FRP composite for added strength and fastener retention.</p>	<p>Complies with specification – See Equipment List F and the Technical Drawings included with proposal for greater details.</p>
<p>h. Window openings cut into body panels shall have a maximum frame clearance of 3/16" on each side, to minimize the need for caulking (see section B. Body Structure and Exterior Panels, subsection 24. Windows). All openings cut into body exterior panels must have the exposed edges of the cutout properly coated to prevent moisture intrusion before further assembly or painting occurs. Window frames installed in the body openings shall be properly caulked/sealed to prevent intrusion of moisture and dust. Drip rails shall be installed the entire length of the bus body above windows and doors.</p>	<p>Complies with specification – See Equipment List F and the Technical Drawings included with proposal for greater details.</p>
<p>i. The Contractor shall submit roof, sidewall, and flooring drawings showing structure and structural specifications indicating metal size and type used. Include side sheathing and inside panels (see section C. Vendor/Manufacturer Requirements, subsection 8. Bid Documents, items e.).</p>	<p>These drawings are included with this proposal as required.</p>

3) Passenger Door	
<p>a. The manufacturer shall provide a heavy duty electrically operated passenger entrance door. The passenger entrance door shall be an anodized aluminum frame, split-type double leaf swing door. This door shall have a flexible soft rubber cushion on the meeting edge 1½" in width, minimum. The door glass shall be see-through, AS-2 tint (70% luminous transmittance) safety glass. Under all operating conditions and bus speeds, an airtight, watertight, and dust-proof seal shall be formed between the door and the stepwell, between the door and body opening, and between the door leaf sections. The door leading edge opening speed shall not exceed 18 inches per second and the closing speed shall not exceed 12 inches per second to provide a total door closing or opening in 2 to 4 seconds. The front passenger entrance door shall not extend below the step frame. The door shall be located on the right side of the bus near the front wheel. Any door with an exposed (metal showing) outer frame shall be made of 304 stainless steel (including the fasteners), which does not discolor with age. The entrance door shall provide a 30" clear width opening, minimum. Door opening height from the top of the first step to the door header shall be a minimum of 76". Where interior height is low at the entrance header, the header shall be padded to prevent injury to those exiting the bus. Suggest Source: A&M Systems Inc .</p>	Complies – A&M suggested source as specified
<p>b. The doorframe strength and electric door operator strength shall be designed to match the entrance door size. Door fasteners shall be anchored through a metal frame, <u>NOT</u> through a wood frame. The operator for the entrance door shall be located in an overhead compartment above the passenger entrance doorway; it shall be concealed from passengers, and shall be easily accessible for servicing through an access door. The electronic control module shall be located in a separate weatherproof enclosure to prevent water damage. The access door shall be hinged to open up with a holding device or shall be a complete access cover that is secured with ¼" threaded knobs (knobs shall match access cover). The access door or cover shall be as large as will fit in the overhead compartment space. Door motor operation shall be limited electrically to control door travel at full open and full closed positions and shall be adjustable to keep the door closed during bus operation. Physical or internal doorstops shall be used to prevent marring or damage to doors and/or surrounding parts. An entrance door manual release that allows disconnection and simple re-engagement of the door operator shall be provided so that the entrance doors can be manually opened in the event of loss of electrical power or other emergency. The door operator motor shall not run continuously when the manual release is operated. Electric door operator, door linkage, and baseplate components shall be of a single manufacturer. Suggested source: A&M Systems Inc., Excell, Vapor.</p>	Complies – A&M suggested source as specified
<p>c. The passenger door control switch shall be located in the driver's compartment within easy reach of the driver and be clearly marked for "open" and "close" <u>icons</u> (switch shall operate the same on all buses). The control switch shall be</p>	Complies with specification – switch to be RED

powered by a constant battery feed circuit with circuit breaker protection. The control switch shall be "hold on" for operation and of a RED color different than the standard switch color.	
d. A method shall be provided to lock all entrances to the bus when it is not in use. Except for the OEM driver's door and ignition, all secondary door locks shall be keyed the same.	Complies with specification on all doors as required.
e. The Contractor shall submit detailed engineering drawing(s) for the design of the entrance door and door-opening device (see section C. Vendor/Manufacturer Requirements, subsection 8. Bid Documents, items c.).	See included drawings of entrance door as required. C - Door Eldorado.pdf
4) Passenger Stepwell	
a. All entrance steps and stepwells shall be gauge number 14 (.075" thickness) 400 series stainless steel, minimum. Steps and stepwells shall have adequate structural bracing. All metal trim hardware in the stepwell area shall be stainless steel. All fasteners in the stepwell area shall be stainless steel that will pass the 480 hour ASTM B117 Salt Spray test and the 480 hour ASTM D2247 Humidity Resistance test. Ground to first step shall not exceed 12" in height, each additional vertical step shall not exceed 9½" and all tread depths shall be 9" minimum. All steps in the entrance stepwell shall be of the same width. A suspension kneeling feature may be used to achieve the required 12" step height. Stepwells shall be covered with flooring material as described in section B. Body Structure and Exterior Panels, subsection 6. Flooring, item c. No aluminum step nosing shall be used. Any interior stainless steel except for exposed door frames shall be brushed, not painted.	Complies with specification – stainless steel steps. See D – Stepwell Drawing Eldorado As well as the VXW – Salt Spray documents included with this proposal.
b. The Contractor shall submit detailed engineering drawing(s) for the design of the entrance step configuration (see section C. Vendor/Manufacturer Requirements, subsection 8. Bid Documents, item d.).	Complies – see D – Stepwell Drawing Eldorado
5) Interior	
a. The interior of the bus shall provide a pleasant, aesthetically pleasing atmosphere. The door and driver instrument panel are to be painted or otherwise finished with a non-reflective, anti-glare finish that matches the overall interior tones of interior panels. All interior hinged access doors shall use quarter-turn, <u>non-corrosive</u> metal, thumb latches with positive stop mechanism (except the storage area in this section, item f., shall have one lockable latch) to hold the door positively closed. All interior markings shall be durable materials affixed to the interior panels' smooth surfaces or markings shall be durable materials affixed to metal plates fastened to the interior panels of the bus. The interior design and colors shall be approved by the State. No cloth shall be used for interior panels.	Complies with specification – White interior
b. All interior panels shall be made of laminate/FRP finished scuff-resistant materials. Overhead compartment and fuse panel covers/doors only shall be made of the same material as interior panels or may be padded with plywood backers. No cloth shall be used for interior panels. Panels must allow for permanent adhesion of signage.	Complies – white interior FRP
c. A white or light gray color shall be installed in the interior area above the seat rail lines, in the ceiling area, and on the rear endwall. All materials and treatments shall be	Complies – white interior FRP

<p>easily cleaned. Panel fastening devices shall match color of panels. All interior finished surfaces shall be impervious to diesel fuel, gasoline, and commercial cleaning agents. Finished surfaces shall not be damaged by controlled applications of graffiti-removing chemicals.</p>	
<p>d. The interior height of the passenger compartment at center aisle shall be 76" minimum. At 6" from the sidewall there shall be 67" of interior height, minimum, with a gradual contour to the center aisle (no bulkheads). Interior headroom at the back of bus (rear air conditioning evaporator area) may be reduced to a minimum of 60", but it shall increase to the normal ceiling height at the front of the rear seat cushion. The interior width at seat line shall be 90", minimum. No cloth shall be used for interior panels.</p>	<p>Complies with approved equal of 75 (75 - 80" based on model/class)</p>
<p>e. <u>All surfaces, items, or hardware in the passenger compartment having sharp edges, corners, or angles that could cause injury, shall be padded with a heavy-duty, vinyl-covered, energy absorbing material to match interior colors and finish.</u> Areas inside the passenger compartment of low headroom where a person is prone to strike his head shall be marked and padded. All handrails shall have rounded edges where exposed.</p>	<p>Complies. Padded where specified.</p>
<p>f. A storage area with a hinged, lockable, access door shall be provided in the interior area either above the windshield (without destination sign) or on the side above the driver as space permits. This area above the windshield shall also be constructed to adequately support up to 60 pounds of two-way radio communication equipment. Storage area door shall open upward, be hinged at the top and have a clip/spring to retain the door in the open position. Storage area shall leave access to any lighting or other electrical connectors contained inside. Storage area shall be insulated and watertight.</p>	<p>Complies – Overhead storage included. Shelf included and insulated area allows for access to connectors.</p>
<p>6) Flooring</p>	
<p>a. The floor deck may be integral with the basic structure or mounted on the structure securely to prevent chafing or horizontal movement. All floor fasteners shall be corrosion resistant steel and shall remain secured and corrosion resistant for the service life of the bus. The floor deck shall be ¾" C/D plywood of marine grade material or ¾" fiberglass encased composite material, minimum, with sealed edges to prevent moisture intrusion. The floor deck upper surface shall have all cracks and voids filled and the whole surface rough sanded before installing the flooring material. A layer of sealer shall be installed between floor deck edges that butt against structural members and other deck sections to prevent dust and moisture intrusion. Passage holes provided for wiring and hoses in the floor deck shall be thoroughly sealed to prevent dust and moisture intrusion. Passenger seating floor rail/track shall not be installed in the wheelchair lift or wheelchair securement areas. The floor deck, including the sealer, attachments, and coverings, shall be waterproof, non-hygroscopic, resistant to wet and dry rot, and resistant to mold growth. The floor deck shall not be sandwiched between the wall structural members and the floor structural members.</p>	<p>Complies with specification – ¾" marine grade as required. See Equipment List F for more details</p>
<p>b. The entire passenger area including the wheelchair securement area, entrance steps and stepwell area, shall</p>	<p>Complies as specified with suggested source GerFlor Tarabus flooring.</p>

<p>be overlaid with smooth, slip resistant flooring material. The resilient sheet flooring system (2.2 mm thickness minimum) shall be a high-quality vinyl with aluminum oxide and color quartz grains throughout the thickness, silicon carbide grains in the surface layer and a non-woven polyester/cellulose backing with glass fiber reinforcement. The flooring shall extend up the sidewall and rearwall to the seat rail line and shall be coved at the floor/wall joint to form a smooth watertight transition. A cove molding radius backing block, approved by the flooring manufacturer, shall be installed behind all floor coving and shall be 1.5" radius (minimum). Installation of flooring must be done strictly according to the flooring manufacturer's directions using the proper accessories, tools, and adhesives. Suggested Sources: Altro Transflor™ Meta, Altro Transflor™ Chroma or Gerflor Tarabus; Profusion.</p>	
<p>c. Step treads shall be one-piece resilient sheet flooring system matching the passenger compartment flooring. All step edges (nosings of step tread material) shall have a band of bright yellow contrasting color running full width of the step. Step tread to stepwell joints shall be sealed to prevent intrusion of moisture and debris. No aluminum step nosing shall be used.</p>	<p>Complies as specified with suggested source Geflor yellow to allow for rubber in lieu of the aluminum step nosing as required by MDOT and VEAT.</p>
<p>d. An aisle width standee line of bright yellow contrasting color shall be in the aisle just behind stepwell (must meet ADA contrast requirement). Suggested Sources: Altro Safety Step System or Gerflor</p>	<p>Complies as specified with suggested source Gerflor yellow</p>
<p>e. Color of all flooring and step tread shall be equal to Altro Transflor genome (grey) or bison (tan) or Gerflor Tarabus; Profusion as requested by the agencies.</p>	<p>Complies as specified with suggested source Gerflor</p>
<p>f. To provide easy access for service, the floor shall have a vapor and fumeproof bright aluminum diamond plate access panel to reservoir fill/check areas and fuel tank sending unit large enough to remove the sending unit and thick enough to prevent it from flexing under normal use.</p>	<p>Complies as specified</p>
<p>g. Standee decals shall be furnished and mounted at the center of the bus above the windshield.</p>	<p>Complies as specified</p>
<p>h. Wheel wells, when required, shall be thoroughly sealed to prevent intrusion of moisture and dirt. Metal wheel wells inside the passenger compartment shall be covered with flooring material or molded fiberglass (FRP or ABS).</p>	<p>Complies as specified</p>
<p>7) Emergency Exits</p>	
<p>a. Each bus shall be equipped with a rear exit door with a minimum opening of 1296 square inches (a rear exit window in place of the door is optional). All exposed exit door frame/jamb structure shall be made of 400 series stainless steel, a grade which does not discolor with aging. The rear door exit and side window exits shall meet federal requirements of FMVSS 217. The manufacturer shall provide a method to lock the rear exit door. The rear exit door shall have an audible alarm at the driver's area activated when the exit door latch handle starts to open and when the exit door is locked with the ignition on. A bus with a rear exit door shall have one small window on each side of the exit door in the rear endcap.</p>	<p>Complies as specified with Stainless Steel structure, lock and alarm. Foam core insulation.</p>
<p>b. The rear exit door shall have two windows, an upper window and a lower window, as a part of the door. The door glass shall be see-through, AS-2 tint (70% luminous transmittance) safety glass. The upper door window height shall match top of rear bus windows as close as practical,</p>	<p>Complies as specified.</p>

<p>one on each side of rear door. Door windows shall match design of bus rear windows. Heavy-duty door latch mechanism with handle guard shall provide a quick release for opening from inside and outside the bus but be designed to offer protection against accidental release. The door latch shall cause the door to compress the perimeter door seal to provide an airtight, dustproof and watertight seal around the door under all operating conditions and speeds. Door panels shall match exterior and interior body panels material construction (see section B., Body Structure and Exterior Panels, subsection 2, items c., and d.) and have foam insulation in between panels. All doors shall be fitted with screwed or bolted-on heavy-duty stainless-steel piano hinges or heavy-duty hinges of a noncorrosive material. A restraint shall be installed to prevent the door from opening beyond 105° or striking the rear panel of the bus when the door is opened.</p>	
<p>c. A passageway of 16" minimum width shall be provided to the rear exit door. No seats or other objects shall be placed in bus, which restricts passageway to rear exit door.</p>	<p>Complies as specified</p>
<p>d. One-closing static exhaust vent, a combination roof vent-emergency exit (23" by 23" minimum), shall be installed at the mid-point on the longitudinal center line of the roof of the passenger section of the bus. The roof vent-escape hatch shall provide fresh air flow inside the bus when opened and when the bus is in a forward motion. The escape hatch shall have an inside and an outside release handle. There is no warning buzzer requirement for the escape hatch. Suggested source: DMA 1122, Specialty Manufacturing Co., Transpec Inc.</p>	<p>Complies as specified with suggested source Transpec Inc.</p>
<p>e. Instructions for proper use of all emergency exits shall be marked in close proximity to the release mechanisms. All interior markings shall be durable materials permanently affixed to the interior panels' smooth surfaces or markings shall be durable materials permanently affixed to metal plates fastened to the interior panels of the bus. Instructions may be labels, of <u>highly</u> contrasting color, affixed to a location that shall be approved by the state. All emergency exits shall be marked on the exterior of the bus.</p>	<p>Complies as specified</p>
<p>f. Lever-type latches used for emergency windows shall secure the windows tightly shut, shall be easily operated, and shall not unlatch due to vibration during bus operation. The latches shall be made of non-corrosive materials and be designed for minimal maintenance needs. Side emergency window latches shall be located on the sides, <u>NOT</u> the bottom. Rear emergency window latches shall be in the bottom.</p>	<p>Complies as specified – side latches</p>
<p>g. Each exit used for passenger egress shall be identified with a red ½" LED indicator lamp, illuminated with the vehicle marker lighting when ignition is in the "ON" position, above each exit, so that it may be seen by a passenger in an adjacent seat. Suggested Source: Series 29, Sorenson Lighting Company</p>	<p>Complies as specified with Sorenson Red LEDs</p>
<p>8) Gauges</p>	
<p>a. Chassis Original Equipment Manufacturer (OEM) gauges shall be used in the driver's instrument cluster, but if they are not available, VDO brand gauges or Stewart Warner gauges shall be used. Each bus shall have an instrument cluster with the following non-glare needle-type gauges</p>	<p>Complies as specified with OEM gauges</p>

which are easily monitored by sight from the driver's position (lights in lieu of gauges are not acceptable).	
b. If available from OEM chassis manufacturer voltmeter and its wiring shall be compatible with generating capacities.	Complies as specified with OEM gages
c. Engine oil pressure gauge.	Complies as specified with OEM gages
d. Engine coolant temperature gauge.	Complies as specified with OEM gages
e. Fuel gauge.	Complies as specified with OEM gages
9) Farebox	
a. The farebox (a donation box is optional) shall be mounted with the trip handle toward the driver and within easy reach of the driver. The farebox shall be mounted on an adequately braced stanchion; shall be located over a flat floor surface near the driver; and shall be accessible to passengers entering the bus (meet ADA requirements). An indirect farebox light shall be connected through an entrance door jamb switch to the running light circuit operational only when door is opened.	Complies as specified – Diamond NV Brand
b. The farebox shall be lockable and supplied with two vaults that are interchangeable and lockable (2 keys for each lock). The vaults shall be keyed alike. The vault and farebox exteriors shall be marked with key reference. (Location shall be approved by ordering agency.) Suggested source: Diamond Model NV	Complies as specified – Diamond NV Brand
10) Bumpers	
The front bumper shall be an OEM bumper. The rear bumper shall be a high energy absorbing bumper. The rear bumper shall be installed per bumper manufacturer's specifications. Bumper attachment shall use a minimum of SAE grade 8 fasteners with thread locking feature or other shake-proof (Nord-Lock) mounting in all attachment brackets. Rear anti-ride bumper installation shall allow space between the bumper and the body for energy absorption movement without body damage. Rear bumper Suggested source: Romeo R.I.M. Inc. H.E.L.P. bumper, SMI.	Complies as specified – Front Ford OEM - Rear Romeo Rim HELP
11) Mud Flaps and Splash Guards	
a. The bus shall have commercial grade anti-sail mud flaps/splash aprons behind front and rear wheels which contain no visible imprinted logo or advertising. Front mud flaps shall be no-drill OEM and rear shall be rigid plastic type mud flaps. The flaps/aprons shall be securely fastened with full width metal strips and appropriate fasteners. The rear flaps/aprons shall be compressed between a gauge number 11 (.125" thickness, minimum) support bracket and a gauge number 14 (.075" thickness, minimum) metal strip. The OEM front flaps shall be fastened securely to the body substructure or chassis frame. The flaps shall extend to within 4 to 6" of the road surface at curb weight. The mud flaps/aprons shall be at least 1" wider than the tire widths (single front, dual rear) to control splash at the rear of wheel openings.	Complies as specified
b. Rubber or ABS fender splash guards secured with stainless fasteners shall be installed on the rear wheel well opening.	Complies as specified
c. Where the mud flaps and splash guards are not an integral part of the body, installation shall be made after the finish	Complies as specified

coat of paint is applied to the bus using appropriate fasteners and adhesive.	
12) Towing	
<p>Tow hooks shall be provided with two in the rear and two in the front if available from OEM of the bus, which shall be of sufficient strength to tow 1½ times the GVWR of the bus. <u>Tow hooks shall be equipped with a spring safety clips (rear only)</u>, easily accessed, and free of interference with the bumper system when in use. Access to tow hooks may be made through holes in the bumper assembly. The intended use for tow hooks is only to safely move the bus to a point of tow truck hook-up. Tow hooks shall be installed to prevent them from dragging when the bus is driven over an incline. The tow hooks, equal to Original Equipment Manufacturer (OEM) units, shall be mounted and adequately secured to the chassis frame as recommended by the tow hook manufacturer or may be supplied by the OEM as standard equipment on the chassis. The bus shall be designed to be towed from the front or from the rear with either a frame contact or a wheel lift. A fuel tank protection frame shall not interfere with a frame contact lift. The bidder shall provide the towing and lifting procedure at delivery.</p>	Complies as specified
13) Undercoating/Rustproofing	
<p>a. When the unit is completed, the sections of the underside of the bus exposed to the elements shall be treated with an undercoating material except those areas of the OEM chassis where undercoating is not recommended. Undercoating shall be warranted for the same period covered by the body/structure warranty. Suggested source: : Pure Asphalt 76M or 770 or Tectyl 517 or 121-B or Z Technologies Z Guard 9902 STAR</p>	Complies as specified – Tectyl 517
<p>b. Rustproofing - All box type steel tubing (except stainless steel) used in the floor structure and sidewall structure from the top of the window down, shall have the interior of the tube coated with corrosion resistant material conforming to MIL-C-62218 as outlined in Federal Standard 297E. Sections that are treated shall be properly cleaned to remove greases, oils, and residues before application of the corrosion-proofing material. Any welded areas shall be retreated to avoid corrosion. All mechanisms (moving or stationary parts) that are affected by or rendered useless by an application of sealant or insulation shall be cleaned free of sealant or insulation including vent canisters and drainpipes. Rustproofing shall be warranted for the same period covered by the body/structure warranty. Suggested source: Pure Asphalt 825 or 372 or Waxoyl, Ziebart Type-A.</p>	Complies as specified Waxoyl
14) Interior Mirrors/Sun Visors	
<p>a. Interior mirror rearview shall be OEM</p>	Complies as specified - OEM
<p>b. Windshield sun visor system shall be standard Original Equipment Manufacturer (OEM) chassis visor(s). If the OEM chassis is not equipped with a windshield sun visor, two large transit-type, fully adjustable, double-knuckle, arm-type Plexiglas sun visors shall be provided for the driver at the windshield, and at the side window. Suggested source: OEM or Manufacturer's standard.</p>	Complies as specified - OEM

15) Exterior Mirrors	
<p>a. Each bus shall be equipped with exterior, powered-remote, heated, left-hand and right-hand rear view mirrors of flat glass with convex mirrors (3" in diameter, minimum) attached or a combination flat/convex glass in a single mirror head. Both flat and convex glass shall be power remote adjustable. The mirror brackets shall be brushed stainless steel. The mirror shall contain at least 70 square inches of flat glass viewing area. <u>ALL MIRROR MOUNTING SHALL NOT CAUSE PREMATURE BODY DAMAGE. No use of self-tapping or self-drilling screws to mount mirrors.</u> Suggested source: ROSCO Eye-max LP Hawk, Mirror Lite Co, Inc. Bus Boy.</p>	Complies as specified – ROSCO heated and remote with stainless steel arms and no self tapping screws.
<p>b. To prevent obstructed front and right-hand view, a convex, asymmetric, exterior cross view mirror (8" minimum diameter) shall be provided on the left front corner of the bus. Suggested sources: Rosco Eye-Max LP, Rosco Bus Boy</p>	Complies as specified – Rosco Eye
<p>c. All exterior mirrors shall be constructed with high impact plastic or stainless steel housings. Mirrors (except cross view mirror) shall be remote adjusting and shall move independently of the mirror housing. The mirrors shall be modular in design so that the glass can be replaced using the "twist lock" mechanism for service without removing the entire mirror assembly from the bus.</p>	Complies as specified
<p>d. Mirror mountings shall be reinforced when not in a structural frame member to prevent mirror vibration, with approval by the State at the time of Pilot Model Inspection. The mirror placement shall not obstruct driver vision nor have window divider bars between the driver and mirror face. <u>ALL MIRROR MOUNTING SHALL NOT CAUSE PREMATURE BODY DAMAGE</u></p>	Complies as specified
16) Driver's Seats	
<p>a. The driver's seat shall comfortably hold and support the human body in the ergonomically correct position for driving and meet the flammability requirements of FMVSS 302. The driver's seat with arm rests (right side seat arm rest, left side door arm rest) shall have adjustments for fore and aft slide, 4" minimum travel, back recline, 20° minimum, and weight range capacity up to 350 pounds. While seated, the driver shall be able to make all of these adjustments by hand without complexity, excessive effort, or being pinched. Manual operated adjustment mechanisms shall hold the adjustments and shall not be subject to inadvertent changes. The seat shall be high-backed and shall be properly aligned (centered) behind steering wheel to allow for maximum seat adjustments and operator comfort. The seat belt with shoulder harness, automatic retractor and supplemental restraint (SRS) system shall be chassis Original Equipment Manufacturer (OEM) equipment. Any modifications to the body shall not interfere with driver's seatbelt adjustments including shoulder height adjustment. All seats and seat mountings shall meet applicable federal standards. <u>An option for an electric 6-way power adjustable seat shall be available.</u> Suggested sources: OEM, USSC G2ELP, Recaro Ergo Metro with headrest and armrests.</p>	Complies as specified – OEM FORD offering standard and power option.
<p>b. The driver's seat cushion shall be molded high resilient (HR) polyurethane foam padding with indentation load deflection (ILD) 35 pounds minimum, and the back</p>	Complies as specified – See Foam data included with proposal

<p>cushion shall be molded or fabricated high resilient (HR) polyurethane foam padding (ILD) 25 pounds minimum. There shall be no welt or bead across the front of the seat cushion under the driver's legs. Compressions to 10 percent maximum and tensile strength, 15 lbs. per square inch minimum. Seat and back cushion foam shall meet the typical physical properties of ASTM D-3574 and the flammability requirements of FVMSS 302.</p>										
<p>c. The driver's seat covering shall be gray Cloth-type Woven Fabric (with flame retardant qualities) or material and color matching bus seats if possible, meeting the requirements listed below in All Seats (see section B. Body Structure and Exterior Panels, subsection 19. Seat Material, item b. Cloth-type Woven Fabric Requirements(with flame resistance).)</p>	<p>Complies as specified – Ford cloth</p>									
<p>17) Passenger Seats</p>										
<p>a. All passenger seats shall be mid-back and are required to meet all applicable FMVSS testing including FMVSS 210 (see section C. Vendor/Manufacturer Requirements, subsection 8. Bid Documents, item p.)</p>	<p>Complies as specified – See Seat Data included with proposal</p>									
<p>b. Two passenger, forward facing seats shall be 35" minimum width with a non-foam, black energy-absorbent, vandal-proof grab handle mounted to the top of each seat back (two per double seat). Grab handles are not required on seats that have a back against a wall.</p>	<p>Complies as specified – Freedman Seating Co.</p>									
<p>c. Single passenger seats shall be 17-½" minimum width with a black, energy-absorbent, vandal-proof grab handle mounted to the top of the seat back.</p>	<p>Complies as specified – Freedman Seating Co.</p>									
<p>d. Forward facing seats shall have 27" minimum knee to hip room.</p>	<p>Complies as specified – 27" minimum</p>									
<p>e. Aisle facing seats shall have arm rests on both ends if the seat is not against a modesty panel.</p>	<p>Complies as specified</p>									
<p>f. Aisles shall not be less than 16" wide except as noted in Part 18 of this section.</p>	<p>Complies as specified</p>									
<p>g. The first double seat, aisle side, on the curb side of the bus shall have an integrated child restraint seat capable of safely carrying children of 22 to 50 pounds.</p>	<p>Complies as specified – Freedman Integrated Child Seat ICS</p>									
<p>h. All seats shall be supported on the floor with high carbon steel support brackets. Seat frame shall be cold-roll steel tubing. Floor anchorage shall be neat and not interfere with entering and exiting the seat. All seat mounting bolts shall be corrosion resistant coated/plated fasteners. Passenger seating floor rail/track shall not be installed in the wheelchair lift or wheelchair securement areas. The bidders shall provide certification test data that the installation of the seats, seat mountings including floor anchorage and floor fasteners shall meet all applicable FMVSS including FMVSS 207, 208, 209, and 210 for the bus model being offered in this bid (see section C. Vendor/Manufacturer Requirements, subsection 8. Bid Documents, item p.)</p>	<p>Complies as specified – Freedman Seating Co. – See seat data included in proposal.</p>									
<p>i. All metal components of the seat assembly shall be coated with a powder coat epoxy paint finish that shall meet the following tests:</p> <table border="1" data-bbox="175 1669 699 1808"> <tr> <td>Salt Spray</td> <td>480 hours</td> <td>ASTM B117</td> </tr> <tr> <td>Humidity Resistance</td> <td>480 hours</td> <td>ASTM D2247</td> </tr> <tr> <td>Impact Resistance</td> <td>To 80 inch-pounds</td> <td>ASTM D2794</td> </tr> </table>	Salt Spray	480 hours	ASTM B117	Humidity Resistance	480 hours	ASTM D2247	Impact Resistance	To 80 inch-pounds	ASTM D2794	<p>Complies as specified – See VXW Salt Spray testing included with this proposal</p>
Salt Spray	480 hours	ASTM B117								
Humidity Resistance	480 hours	ASTM D2247								
Impact Resistance	To 80 inch-pounds	ASTM D2794								

<p>All testing is to be performed on standard metal seating materials that have coating thickness of 1.3 to 1.8 mils. Certified test documents are required with bid proposal (see section C. Vendor/Manufacturer Requirements, subsection 8. Bid Documents, items o.).</p>	
<p>j. The seating arrangements and configuration shall be furnished by the Program Manager or Designee and/or Ordering Entity.</p>	Complies as specified
<p>k. Suggested sources: American Seating Horizon™ 8535 Mid-Back Series; C.E. White LE Series; Freedman Feather Weight.</p>	Freedman Seating – Feather weight suggested source as specified.
18) Wheelchair Lift-Equipped Buses Folding Seats	
<p>a. Forward facing solid back, bench style (double) fold-away or flip (double) seats with seat belts shall be provided in the wheelchair securement area per seating arrangements (see Section B. subsection 28, Wheelchair Securement Area). <u>All aisle facing seats provided shall be flip seats.</u> Fold-away or flip seats shall include all dimensional, structural and testing requirements of the standard seat specification. Seat locking/latching devices shall be of high quality and be easy to latch and unlatch. Seats must positively latch in the seated and folded position to prevent inadvertent folding or unfolding of the seat. Any support legs resting on flooring shall be non-marring or rest on metal plates flush mounted with flooring. All fold-away seats shall be able to pass FMVSS 210 without having to fasten additional latches or cables. All fold-away seats shall fold against the wall when wheelchair space is required (no further than 12" from wall in the vertical folded position). Seat may not extend into bus more than 37½" (two passenger) and 18½" (1 passenger) when folded down for passenger seating. Aisle space may be reduced to 14 inches where fold-up seating is placed on each side of the aisle or 15½" where placed opposite a stationary seat. The seat bottom cushion shall be a 5° tilt up from level, minimum, and back cushion shall be at 95°, minimum. The seats shall be of the same design as the other passenger seats. All seat backs of the fold-away/fold-up seats shall be covered with material matching seat cushion color and fabric. Suggested source: American Seating Horizon™ 8800 Cantilevered Folding Seat or 8700 Flip-up; C.E. White LE Series; Freedman Feather Weight Foldaway or Mid-Hi Flip; Braun #125.</p>	Complies as specified – Freedman Featherweight 3 way Fold-a-way as specified
19) Seat Material	
<p>a. Seats shall be individually contoured to each passenger for occupant comfort and retention. Seats shall be covered with cloth-type woven fabric or vinyl fabric at the transit agency's option. Cloth-type fabric or vinyl shall be D-90 compliant and completely enclose the seat cushion and the seat back. Seat background colors shall be gray, red, blue, and other in-stock colors (bidder to provide available choices at time of bid). All background colors shall be approved by the Program Manager or Designee.</p>	Complies as specified
<p>b. Cloth-type Woven Fabric Requirements (with flame resistance)</p>	Complies as specified
<p>i Minimum weight 23 ounces per linear yard.</p>	Complies as specified
<p>ii 50,000 minimum double rubs (ASTM - 3597-77 Wyzewbeek Method).</p>	Complies as specified

iii Color fastness to light 300 hours minimum (AATCC-16-1977 Carbon Arc.)	Complies as specified
iv Comply with California BLT-117.	Complies as specified
v All cloth-type woven fabrics except Holdsworth Wool shall be treated with a flame proofing solution following the manufacturer's specifications, No-Flame by Amalgamated Chemical Inc., or equal.	Complies as specified
vi The fabric shall be a plush material.	Complies as specified
vii Suggested source: D-90 Flame Resistant Fabrics by, CMI, Holdsworth Wool, or Camira. Contractor shall provide technical data sheet including flammability and smoke emissions for the seat covering material supplied (see section C. Vendor/Manufacturer Requirements, subsection 8. Bid Documents, item n.).	Complies as specified – MDOT approved Camira D90 Level 7 Gray and Blue offered.
c. Vinyl Fabric	
i Shall be transportation grade expanded vinyl, 33 +/- 5% ounces per linear yard minimum.	Complies as specified
ii Suggested source: D-90 Flame Resistant vinyl by CMI or Camira. Contractor shall provide technical data sheet including flammability and smoke emissions for the seat covering material supplied (see section C. Vendor/Manufacturer Requirements, subsection 8. Bid Documents, item n.).	Complies as specified – CMI Gray, Blue or Mushroom as specified
d. Cushions	
i Seat cushion and back cushion shall be molded high resilient (HR) polyurethane foam padding. Seat cushion indentation load deflection (ILD) shall be 35 pounds minimum, with compression to 15% maximum, and tensile-strength of 15 minimum. Seat and back cushion shall meet the physical properties of ASTM D-3574 and the flammability requirements of FMVSS 302, minimum. The technical data sheet for the foam supplied shall be included in the bid proposal with the seat information (see section C. Vendor/Manufacturer Requirements, subsection 8. Bid Documents, item q.). Suggested source: Manufacturer's standard.	Complies as specified – Freedman – see foam data supplied with proposal. Q - Seat Cushion Foam
ii Seat and back cushions shall be supported with a spring-type support system. Seat and back cushions shall be completely covered with seat cushion covering material. Seat back depth shall not exceed 3½" overall.	Complies as specified – ICS may vary
e. Passenger Seat Belts	
i The bidders shall provide certification test data that the seat belts, and the installation are in compliance with FMVSS-207, 208, 209, and 210 where applicable for the bus model being offered in this bid (see section C. Vendor/Manufacturer Requirements, subsection 8. Bid Documents, item p.).	Complies as specified – Freedman – see seatbelt data supplied with proposal. P - Seat Belt Certs
ii Two universal "Buckle Up" decals approximately 6" by 6" shall be furnished loose with each bus. Decals shall indicate that seat belt use is recommended.	Complies with specification
iii All seats shall be equipped with seat belts for each designated seating position, except center seat on rear	Complies with specification

five passenger bench, which shall be non-retracting type.	
iv The male end of the belt will have a locking retractor. The retractor will be mounted underneath the seat to the seat frame and there shall be no lap retractors except on the rear center bench seats (if equipped).	Complies with specification
v Belts shall have a push button latch release mechanism with push button on aisle side of seat.	Complies with specification
20) Handrails, Stanchions (Shall meet ADA regulations)	
a. The handrails and stanchions shall be a minimum of 1¼" outside diameter. All handrails and stanchions shall be positioned so as not to interfere with wheelchair movement and shall meet ADA requirements for position and size. All handrails and stanchions in the passenger entrance area shall be highly visible yellow in color. All other handrails and stanchions shall be brushed stainless steel. Mounting brackets and fittings shall be composed of the same kind of material used for the stanchion or handrail. Stanchion mounting rubber grommets shall be able to handle roof to floor flex without excessive damage or ejection.	Complies with specification
b. All handrail and stanchion mountings shall have reinforcement plates welded to or imbedded in the structure behind surface panels of sufficient size and strength. Final locations shall be determined at pilot model inspection. Self-tapping/threading screws shall NOT be used.	Complies with specification
c. A floor-to-ceiling vertical stanchion shall be provided in close proximity to the rear of the driver's area. A guardrail shall be provided in back of the driver's area extending from the vertical stanchion to the left side of the bus 30" plus or minus 2" above the floor. A padded modesty panel shall be provided from the guardrail to within 8" of the floor. Stanchion and guardrail shall not restrict any driver's seat adjustments.	Complies with specification
d. A smoked Plexiglas panel, 3/8" thick, shall be provided behind driver from top of the driver's seat to within 12" of bus ceiling. The panel shall not impair driver's seat adjustments. The panel shall be fastened with bolt and nuts or double screw heads. Self-tapping/threading screws shall NOT be used. The panel shall be located to allow the driver's seat back to recline to ½ its maximum reclined adjustment with the driver's seat in the position furthest from the steering wheel. Panel may be incorporated into the stanchion and guardrail behind the driver and shall have cutouts to give hand access to the vertical stanchion.	Complies with specification
e. Floor-to-ceiling stanchions (yellow) shall be provided near aisle on each side of front entrance rearward of the immediate entrance stairwell.	Complies with specification - Yellow
f. Left and right-side entrance handrails (yellow) shall be installed from low stepwell to floor-to-ceiling stanchions. Entrance handrails shall be positioned so passengers entering or exiting the bus will have handrail support throughout the entering/exiting process and so that articles of clothing may not become entangled in the handrail-stanchion-guardrail assemblies.	Complies with specification - yellow
g. A guardrail (yellow) shall be provided in front of and at the rear of the front entrance steps, extending from the	Complies with specification - Yellow

vertical stanchions to the right side of the bus 30" plus or minus 2" above the floor. A modesty panel (padded both sides, vinyl clad) shall be provided to the left (rear side) of the entrance from guardrail to floor (in case of lift bus, provide floor-to-ceiling stanchion with guardrail and modesty panel to rear of platform lift).	
21) Interior Lighting	
a. All interior lights shall be LED and provide no less than two foot-candles of illumination on the entrance step tread or lift or ramp with the door open. Outside light(s) shall provide at least 1 foot-candle of illumination on the street surface within 3 feet of step tread outer edge. This system shall provide illumination automatically when the door is open and meet ADA requirements.	Complies with specification – LED Interior – ADA Compliant
b. All lights shall have access holes large enough to easily remove electrical connector. All non-OEM chassis lights shall cause no radio interference.	Complies with specification
c. Overhead entrance and stepwell lights shall be wired to and be automatically activated by a door controlled switch. All interior lights shall operate any time the ignition key is on and the door is opened.	Complies with specification
d. Stepwell light shall be on the side away from wheel splash.	Complies with specification
e. Interior lighting shall be LED and provide a minimum of two foot-candles of illumination at a reading level, minimum 3 per side. Interior lighting fixtures shall be reasonably flush with the interior walls and ceiling so no hazard exists for the passengers. All lights shall have lead wire long enough to remove light at least 6" from bus and easy access to the connectors for service.	Complies with specification – LED Interior – extended 6-10" wires for easy removal
f. Light installation shall be designed to illuminate the lift platform when deployed at floor level at no less than two foot-candles of illumination. Outside light(s) shall provide at least 1 foot-candle of illumination on the street surface within 3 feet of step tread outer edge. This system shall provide illumination automatically when the lift door is open and meet ADA requirements. On-off light switch shall be lift door-actuated.	Complies with specification – LED Interior – ADA Compliant
22) Exterior Lighting	
a. Exterior lighting shall be non-PCB product with direct overmold plastic and no air gap construction in accordance with Federal Motor Carrier Safety Regulations (393.11) and ADA regulations. All lights shall have the lead wires long enough to remove the light at least 6" from bus for service. Unless specified, all exterior lights of the bus shall be light emitting diodes (LED) sealed lamps retained in a rubber grommet mounting except for surface mounted lights and front headlamp/turn signal assemblies.	Complies with specification with overmold plastic and no air gap construction
b. All lights shall have access holes large enough to easily remove electrical connector including strobe light.	Complies with specification – LED Exterior – ADA Compliant - Grometed
c. Exterior marker lights shall be light emitting diodes (LED) (2" in diameter sealed lamp) retained in a rubber grommet mounting except for surface mounted lights and conform to Federal Motor Carrier Safety Regulations Part 393.	Complies with specification – extended wires for easy maintenance
d. All marker lights shall have a weatherproof two prong (one positive and one ground) or three prong plug-style connector with the ground wire connected to an in-harness ground attached to a common grounding point.	Complies with specification
e. Marker and tail lights shall be operated through a relay controlled by the headlight switch. Suggested Sources: Innotec, Dialight, Grote, Optronics, Peterson, SoundOff	Complies with specification

Signal, Trucklite. Headlights shall be Halogen lamps and the standard front park/turn lights may be a part of the OEM headlight assembly.	
f. An amber, LED, mid-ship light (sealed) shall be installed on both sides of the bus and shall operate with the hazard flashers, marker, and turn signals. License plate light shall be LED.	Complies with specification – mounted as requested.
g. A red, 4" round, oval, rectangular, voltage regulated non-PCB product with direct overmold plastic and no air gap construction LED high mount stop lamp shall be mounted centrally in the rear panel of the bus and work in conjunction with the brake lights. The high mount stop lamp shall be mounted either above the rear emergency exit door or above the rear emergency exit window. Final location of high mount stop lamps shall be determined at pilot model production. Suggested Sources: Innotec, Command Electronics model 003-82, Dialight, Grote, Optronics, Peterson, SoundOff Signal, Truck-Lite.	Complies with specification
h. Brake/tail lights shall be red 4" round sealed voltage regulated LED lamps and shall not override hazard flashers or turn signals.	Complies with specification
i. Directional rear turn signal lamps shall be amber 4" round sealed voltage regulated LED lamps.	Complies with specification
j. Back-up lamps shall be clear, 4", round, sealed, voltage regulated LED lamps. Back-up lights shall be 500 lumens minimum.	Complies with specification
23) Heating/Ventilating/Air Conditioning (HVAC)	
a. During normal passenger service, front and rear heavy-duty heating system shall be capable of raising the interior temperature of a bus from 0°F to 60°F at knee level (22" above the floor) throughout the interior of bus within 30 minutes from engine startup. After initial warm-up, while the bus is in passenger service, the front and rear heavy-duty heating system shall be sufficient to maintain a minimum of 64°F at knee level throughout interior of bus and at the driver's foot space when the outside temperature is 0°F. Heating system operation will be verified by the required system testing as defined in Section C.4. Heating/Ventilating (HV) Certification. In addition to the front heater and windshield defrosters, for increased air circulation, one 6" two speed fan with non-glare blades and body shall be mounted away from passenger and driver traffic in the driver's area near the windshield. The fan shall be mounted securely. Grounding for all heater fan motors shall be supplied by an in harness ground wire attached in the fuse panel to a common grounding point. All HVAC fan motors shall be supplied with proper radio frequency (RF) suppression equipment to remove two-way radio interference.	Complies with specification – ProAir rear heater as specified
b. Front heating unit shall be automotive in-dash type, chassis Original Equipment Manufacturer (OEM), and shall be capable of delivering heat, fresh air ventilation, and air conditioning (optional) to the driver's area. The front heater shall have a temperature control valve which can be regulated from the driver's area. The driver's area shall have air circulation in each mode of defrost, heat, fresh air ventilation, and air conditioning (optional) of 125 cfm at the foot area, with a total driver's area circulation of 400 cfm minimum.	Complies with specification – OEM Chassis heater
c. Rear heating unit(s) shall distribute heat in at least a 180° direction and ensure air distribution to all passenger areas of the bus interior. Heating unit(s) shall have a minimum	Complies with specification – ProAir as specified

<p>5/8" I.D. heater inlet and outlet ports with a BTU/hr output rating to match the specified HVAC performance requirements. Coolant flow through the heating units shall not be restricted by excessive bends or kinks in hoses or excessive lengths of hoses. Heating units shall have rubber or nylon insulator(s) between their mounting base and floor of the bus. Suggested sources: ACC Climate Control, A. R. Lintern, Bergstrom, Pro-Air, MCC Mobile Climate Control</p>	
<p>d. The premium heater hose (5/8" ID minimum) shall be high temperature resistant Ethylene Propylene Diene Monomer (EPDM) material. Hose shall be a reinforced type with Aramid knitted fiber reinforcement between the EPDM tube and EPDM cover. Heater hose material shall be compatible with all types of coolant including long life coolant. Rated temperature limits of the hose shall be - 40°F to +300°F minimum, with a burst pressure of 130 PSI minimum.</p>	<p>Complies with specification – 5/8” hoses and valves</p>
<p>e. Manual shut off valves for the rear heater shall be placed as close to the engine as is practical. The 5/8" ID heavy-duty brass ¼ turn shut off valves shall be located in the heater outlet line (from engine to heater) and in the heater inlet line (to engine from heater). Shut off valves shall be accessible by personnel without going under the bus with access panels. Location to be determined at pilot model inspection.</p>	<p>Complies with specification –5/8” hoses and valves</p>
<p>f. Front heater shall have coolant temperature control valve or other controls which can regulate heater temperature from the driver's area.</p>	<p>Complies with specification</p>
<p>g. All heat lines and hoses shall: have exterior routing along the bus frame rail where possible; be sufficiently protected to ensure against wear from friction and the elements; be insulated to reduce heat loss; use routing that eliminates excessive bends and hose lengths; and have heater hose passage holes through engine cowl and floor area thoroughly sealed to prevent air, dust, and moisture intrusion.</p>	<p>Complies with specification</p>
<p>h. Air conditioning charge ports shall be protected from road debris to prevent corrosion.</p>	<p>Complies with specification</p>
<p>i. Air Conditioning (see section B. Body Structure and Exterior Panels, subsection 56. Options, item a. Air Conditioning – Split System, and item b. Air Conditioning/Heat – Rooftop System).</p>	<p>Complies with specification – See F Equipment lists for details on Air Condition systems proposed.</p>
<p>24) Windows</p>	
<p>a. Passenger compartment windows shall be T-type slider at top, full slider, or top tip-in type for window ventilation. Windows shall have tempered safety glass and heavy-duty locking features which shall meet FMVSS 217 for emergency exits, if applicable. Window glazing material shall be able to maintain its seal and glass retention for the life of the unit. Caulking around windows shall be used only as a seal, not to make up for body defects or out of tolerance window openings (maximum clearance of ¼" around the frame, 1/8" on each side). All window glass shall be tinted – passenger windows AS-3 tint 31% luminous transmittance, right and left driver's side windows AS-2 tint 70% luminous transmittance, and windshield shaded-tinted AS-1 tint – and meet applicable federal standards. Drip rails shall be installed the entire length of the bus body above windows and doors.</p>	<p>Complies with specification – T Sliders as specified</p>
<p>b. Driver's compartment right and left side windows shall be designed for maximum window area to provide</p>	<p>Complies with specification - OEM</p>

unobstructed vision. Driver's compartment window shall be OEM chassis Original Equipment Manufacturer (OEM) door window. Driver's right side window shall be one piece. Suggested sources: OEM	
c. Black trim shall be installed or painted to completely cover the space between all side passenger windows. The trim line shall match the bottom edge of the windows. If equipped with a side lift door, a black trim stripe shall be painted from and around the lift door windows to match the trim of the side windows. The window trim shall give the illusion of one solid window.	Complies with specification
d. Windshield shall be OEM.	Complies - OEM
25) Paint	
a. All exterior surfaces shall be smooth and free of visible fasteners (excluding round head structural rivets), dents, and wrinkles. As appropriate for the paint used and prior to application of paint, the exterior surfaces to be painted shall be properly cleaned and primed to assure a proper bond between the substrate and successive coats of original paint. All FRP body paint must match OEM chassis paint codes. Paint shall be applied smoothly and evenly, with the finished surface free of dirt, runs, orange peel, and other imperfections. All exterior finished surfaces shall be impervious to diesel fuel, gasoline, and commercial cleaning agents. Finished surfaces shall not be damaged by controlled applications of commonly used graffiti-removing chemicals.	Complies with specification
b. All exterior paint shall be a two part acrylic-urethane-type or polyurethane-type with low volatile organic compound (VOC) emission. The finish coat of paint shall be applied before rubrail covers or inserts, fender flares, exterior lights, and other body mounted accessories are installed. Paint shall be applied in the following method: i If on bare aluminum, use proper cleaner. Suggested sources: Cromax Chromapremier, PPG followed by aluminum conversion. Suggested sources: DuPont 2265, PPG. ii If on bare steel, use proper cleaner. Suggested sources: Cromax Chromapremier, PPG followed with steel conversion. iii For all bare metal, use primer. Suggested sources: Cromax Chromapremier (two coats), PPG. iv Appropriate prep to stainless steel surfaces shall be used to ensure proper paint adhesion. v Appropriate primer as required shall be used on fiberglass surfaces. vi Coat entire prepared surface to be painted with minimum of two coats of paint properly activated and reduced and have a minimum thickness of three millimeters. Suggested sources: Cromax, PPG Concept System, Sikkens Corporation U-Tech brand.	Complies with specification – Sikkens
c. Standard paint color for all buses shall be the manufacturer's pre-finished white exterior panels (to match OEM chassis white). Color scheme on all buses shall be provided at the time of ordering. Additional paint schemes will be quoted in section B. Body Structure and Exterior Panels, subsection 56. Options, item k. Paint – Optional Designs . Special design paint	Complies with specification

application pricing will be negotiated at the time of ordering by the transit agency.	
26) Insulation	
<p>a. Inside walls, ceiling, passenger floor area, driver floor area, and fire wall area shall be adequately insulated for sub-zero winters with spray-type foam insulation or glued in place insulation with a minimum R factor of 5. The insulation shall be non-formaldehyde, fire-resistant (FMVSS 302 minimum), non-hygroscopic, and resistant to fungus. Insulation shall prevent condensation and thoroughly seal bus so that drafts cannot be felt by the driver or passengers during operations with the passenger door closed. <u>Insulation shall not cover up electrical wiring harnesses, electrical switches, or other devices and shall not be sprayed in wheelwells.</u> All mechanisms (moving or stationary parts) that are affected, create a fire hazard, or are rendered useless by an application of sealant or insulation shall be cleaned free of sealant or insulation, including vent canisters and drain pipes. Tectyl 121-B shall not be applied over foam insulation.</p>	Complies with specification
<p>b. Engine hood cover and driver's area shall have adequate insulation to keep driver's foot area cool during summer months, warm during winter months.</p>	Complies with specification
27) Type I Lift, (Platform Type) (Shall Meet ADA Requirements)	
<p>a. The Type I platform lift (passive lift) shall be installed in a separate door opening for use by persons with disabilities. The lift assembly shall be mounted within the bus body on the right (curb) side. The bus manufacturer must provide documentation (reviewed by the State at pilot model production) that the lift installation complies with the lift manufacturer's lift installation requirements. The overhead clearance between the top of the door opening and the raised lift platform, or highest point of a ramp shall be a minimum of 68" to meet ADA requirements.</p>	Complies with specification
<p>b. The lift doors shall be manually operated, double-door with an outside key locking handle. Spring loaded struts or gas struts shall be provided on the lift doors to positively hold the doors in the open position. All door openings shall have full structural framing around the opening equal to the structural members of the body. The lift doors shall have an upper window similar to the side windows of the bus. Any exposed lift door frame structure shall be constructed of 400 series stainless steel, a grade which does not discolor with aging.</p>	Complies with specification – Stainless Steel
<p>c. The lift shall be an electro-hydraulic type. If the lift has a crossbar, it shall be above the door opening and well padded. The platform lift equipment shall be a double "C" channel parallel arm construction, hydraulically operated by two single-acting cylinders with gravity unfold, gravity down, power up, and power fold (stow) operation. No part of the lift platform shall exceed 6 inches/second during the lowering and lifting of an occupant, and shall not exceed 12 inches/second during deploying or stowing. The lift shall have a mechanical outboard safety wheel stop to prevent wheelchair from rolling off the platform during the lifting cycle. Successful bidder shall deliver the lift equipped bus with the type of lift equipment requested by the State. Suggested sources: Braun, Ricon.</p>	Complies with specification – Braun (with option for Ricon)
<p>d. A manual safety override shall be provided that will remain operable. Lift shall have manual override instructions visible from inside the bus.</p>	Complies with specification

<p>e. The entire lift assembly shall be installed inside the bus body and shall have padding installed on all sharp corners or items that protrude into the passenger area to prevent accidental injury to passengers. Wall and floor mounting points shall be reinforced and shall be attached with fasteners having a thread locking feature. Lift installation shall insure that no lift rattling exists when the bus is operated while the lift is stowed.</p>	<p>Complies with specification</p>
<p>f. A lift control interlock system shall be installed that shall ensure that the bus cannot be moved when the lift is not stowed and that the lift cannot be deployed unless the interlock is engaged [to meet ADA regulation in 49 CFR Part 38, Subpart B-Buses, Vans and Systems, §38.23, (b)(2)(I)]. The interlock system shall engage when the lift operation sequence is followed. Interlock operating instructions shall be included with the bus at delivery. An indicator light (red, labeled) shall be provided at the driver's station that is activated when the lift door is open and when the lift is in operation. <u>An interlock override system shall be installed that allows service personnel to move the bus to a safe area for repairs.</u> Suggested Source: Intelligent Lift Interlock System (ILIS) by Intermotive Products</p>	<p>Complies with specification – ILIS Intermotive</p>
<p>g. All lift equipped buses shall display the international symbol of accessibility, one each on left and right side of the bus. Location shall be determined ordering agency.</p>	<p>Complies with specification</p>
<p>h. The lift shall meet ADA requirements as well as these minimum requirements.</p> <ul style="list-style-type: none"> i Capacity 1,000 pounds minimum. ii Usable platform width 37" minimum. iii Usable platform length 54" minimum. iv Platform shall include automatic locking inboard safety wheel stop (minimum 6" height) and outboard safety wheel stops to prevent wheelchair from rolling off. v Platform shall automatically stop at floor level. vi Platform shall automatically stop when lowered to ground level. vii Hand held controls shall be conveniently located on a flexible or coiled, cut- resistant cable and shall be mounted with access from inside or outside the bus. The cable shall be routed to eliminate being pinched in any moving parts. viii Platform, bridge plate, and area between bridge plate and aisle shall be skid resistant. ix Bridge plate and platform shall be coated to resist rust. x Platform shall have horizontal handrails (one each side) on platform to assist passenger during lift operations. Handrails (yellow) shall fold automatically to prevent any obstructions into the bus passenger area. xi Lift door operated interrupt switch shall prevent use of lift with lift door(s) closed. Heavy duty long life switches shall be used in this application. xii The color of the lift shall coordinate with bus interior colors and be approved by the Program Manager or Designee or the Ordering Entity. The outside edges of the platform shall either be painted yellow or use 3M™ vinyl safety stripe tape to enhance visibility when extended on the ground. 	<p>Complies with specification – 1000 lb. 37 x 54 " as required.</p>

<p>xiii Sharp corners of lift platform shall be padded (remove for lift use) when in the stored position.</p> <p>xiv The wheelchair lift shall comply with all federal, Americans with Disabilities Act (ADA), and Veterans' Administration regulations.</p> <p>xv Lift platform shall be fitted with device to prevent the platform from touching or leaning against door after being returned to stored position when the lift assembly is not in use.</p>	
28) Wheelchair Securement Area	
<p>a. The wheelchair securement system shall be installed according to ADA & ANSI RESNA WC -18 requirements. Securement location shall be installed as shown by the seating plan option and approved at pilot model production. Fold-away seating shall be provided for use when wheelchairs are not being carried as shown in floor plans. The integrated securement system shall restrain the occupant and the wheelchair separately and securely.</p>	<p>Complies with specification – Use of Freedman Featherweight 3 step Fold-a-Ways – WC18 restraints from Q'straint / AM Bruns</p>
<p>b. Wheelchair securement shall meet these minimum requirements:</p> <p>i Forward facing wheelchair tie down and occupant restraint shall consist of four floor attachment points for the chair and a retractable combination, lap belt/shoulder restraint with manual height adjuster for the occupant per location.</p> <p>ii Securement floor anchorage points shall be anodized aluminum, stainless steel or other noncorrosive metal construction and consist of aircraft type insert pockets that can be flush mounted with the flooring (Flanged "L" style track, Q'Straint, Sure-Lok – Omni aluminum 6061-T6 or equivalent with matching end caps OR AMF-BRUNS Aluminum L-track, 6082-T6 with matching end caps). Anchorages and securements must be tested together and compatible and be from the same supplying manufacturer. Floor anchorage points for the first securement space shall be spaced at a minimum of 54" from center of front track to center of rear track. Floor anchorage points shall be located no closer than 8" from a stationary wall or obstruction (forward or rearward) that would hinder an operator from attaching the securement system. The center run of anchorage track between two securement locations can be shared with the rear anchorage of the front securement system and the front anchorage of the rear securement system. Width of anchorage track shall be no less than 30" wide allowing for the widest of mobility devices.</p> <p>iii Shoulder belt wall anchorage shall be permanently fastened to the body structure in the wall according to the securement manufacturer's installation instructions. Shoulder belts shall be retractable with manual height adjustment and shall allow approximately 12" of vertical height adjustment allowing for differences in height of the secured mobility aid passenger.</p> <p>iv The four belts that attach to the wheelchair from the floor anchorage points shall use a simple speed hook end ("J" or "S" style) for chair attachment and have automatic self-tensioning heavy duty retractors with a hard metal cover and have available 2 tightening knobs per retractor as to allow the operator to easily reach a</p>	<p>Complies with specification – Use of Freedman Featherweight 3 step Fold-a-Ways – WC18 restraints from Q'straint / AM Bruns – offered with L track and Single Point as an option.</p>

<p>knob no matter the orientation of the retractor to the mobility device. Knobs are for aiding in additional securement control. All floor attachment belts shall be the same and work in any of the four floor attachment points and be equipped with pin connector brackets for the lap belt assembly. Automatic self-tensioning and self-locking retractors with metal covers shall be part of the four floor belt assemblies for automatic belt tensioning. Belt ends with floor anchor attachments shall be easily identified for placement in the floor track.</p> <p>v The securement system and components must comply with all applicable requirements of safety regulations and standards including ADA, FMVSS & CMVSS 209/210/222/302 & ANSI RESNA WC-4 Section 18</p> <p>vi Suggested sources: Q'Straint model QRT 360; Sure-Lok Titan 800 WC-18 series, AMF-Bruns Platinum Series WC-18</p>	
<p>c. Restraint Storage System</p> <p>i A wheelchair restraint storage system shall be positioned under the foldaway seats at each wheelchair space. Storage system shall:</p> <ol style="list-style-type: none"> 1. Keep restraints clean. 2. Be free of any sharp edges. 3. Provide easy accessibility to restraints. 4. Restraints shall be stored securely to prevent noise while the vehicle is in motion. 5. Restraint storage system shall be compatible with the installed securement system (L-Track or 360 degree single point securement system). A TDSS shall be provided for each wheelchair location. Suggested Source: Freedman Tie-Down Storage System. <p>ii A storage pouch, from the securement manufacturer, shall be provided for the lap belt restraints so that the restraints can be stored off the floor in the bus when not in use. Location of storage pouch shall be determined by ordering agency.</p>	<p>Complies with specification - Q'Straint TDSS System and Bag</p>
<p>29) Chassis</p>	
<p>a. A copy of the completed pre-delivery inspection form shall accompany the bare chassis and accompany the bus during manufacturing as part of the build order. All standard or optional chassis equipment to be included shall be as advertised by the manufacturer and factory installed and shall not consist of substitute or aftermarket equipment. All optional equipment shall be installed per optional equipment manufacturer's instructions. Optional chassis equipment not available from the factory may be dealer installed. The chassis shall meet the following minimum requirements.</p>	<p>Complies with specification</p>
<p>b. Class I - Chassis shall have one front axle with single wheels and one rear axle with dual wheels. It shall have a driver and passenger OEM door with co-pilot seat or it shall have a driver OEM door without a co-pilot seat.</p>	<p>Complies with specification – Ford E350 Series</p>
<p>c. Class II - Commercial rated chassis shall be the highest Gross Vehicle Weight Rating (GVWR) available for the wheelbase and shall have one front axle with single wheels and one rear axle with dual wheels.</p>	<p>Complies with specification – Ford E450 Series</p>
<p>30) Tilt Wheel/Power Steering</p>	

Chassis shall be equipped with power steering and a tilt wheel steering column. The steering column shall be adjustable for various up and down positions of the steering wheel. The steering shall be a full power assist type.	Complies with specification – OEM
31) Wheel Base	
The minimum wheelbase shall be 138" (small class I) and 158" (small class II) using the wheelbase for each of the specified bus lengths which will provide proper approach and departure angles, proper handling, and proper ride characteristics. Maximum rear overhang shall not exceed 1/3 bus overall length.	Complies with specification – Ford E Series
32) Engine	
a. Small class one shall be gasoline V8, fuel injected, 445cid, 7.3L minimum	Complies with specification – Ford 7.3L V8 Premium
b. Small class two shall be gasoline V8, fuel injected, 445cid, 7.3L minimum	Complies with specification – Ford 7.3L V8 Premium
33) Transmission	
The electronically controlled transmission shall be a minimum, heavy-duty, six-speed automatic cooled by an "H.D. transmission oil cooler" in series with radiator cooler or equal (cooler capacity to match GVWR of bus). Suggested source: OEM matched to the electronic engine and chassis.	Complies with specification – Ford E Series OEM
34) Alignment	
The bus shall have a four-wheel alignment at final point of inspection at curb weight after final assembly is completed, just prior to delivery to the transit agency. Final alignment settings shall be +/- .1 degree of preferred manufacturer's alignment specification. A copy of the work order indicating the camber, caster and toe-in settings at time of final inspection shall be provided with the bus at delivery. All axle alignment required.	Complies with specification
35) Gross Bus Weight Rating	
a. Small Class One	Complies with specification – Ford E Series
i Front Axle Rating – 3,700-lb. minimum. Bus shall not exceed chassis manufacturer's rated front axle weight capacity.	
ii Rear Axle Rating, -7,800-lb. minimum. Bus axle weight shall not exceed chassis manufacturer's rear axle weight rating or spring and tire capacity.	
iii Chassis GVWR - 11,500-lb. minimum. (see Section I Purpose of Specifications.) Engineering calculated loaded bus axle weight charts are required with the bid (see section C. Vendor/Manufacturer Requirements, subsection 8. Bid Documents, item b.).	
b. Small Class Two	Complies with specification – Ford E Series
i I-Beam Front Axle Rating – 4,600-lb. minimum. Bus axle weight shall not exceed chassis manufacturer's front axle weight rating or spring and tire capacity	
ii Rear Axle Rating, - 9,450-lb. minimum. Bus axle weight shall not exceed chassis manufacturer's rear axle weight rating or spring and tire capacity.	
iii Chassis GVWR -14,200-lb. minimum. (see Section I Purpose of Specifications.) Engineering calculated loaded bus axle weight charts are required with the bid (see section C. Vendor/Manufacturer Requirements, subsection 8. Bid Documents, item b.).	
36) Differential	

<p>Heavy-duty rear axle with full floating axles. Gear ratio shall allow buses to travel approximately 65 miles M.P.H. loaded, maximize fuel economy, and not exceed manufacturer's recommended engine operating R.P.M.</p>	<p>Complies with specification – Ford E Series</p>
<p>37) Battery, Cables, and Grounds</p>	
<p>a. The battery equipment shall be furnished by the chassis manufacturer where available. The dual batteries shall be maintenance free with reserve capacity of 400 minutes @ 80° F, 950CCA or largest available from OEM minimum, 12-volt minimum. The batteries installed in the bus must be a pair of matching units.</p>	<p>Complies with specification – Ford E Series OEM</p>
<p>b. The batteries must be fresh, fully charged units when the finished bus leaves the manufacturing plant. Batteries that have been in the bus during the manufacturing process which were allowed to become fully discharged for a period of time shall be replaced with fresh new batteries. One battery shall be mounted under the hood the other battery shall utilize the passenger stepwell as a storage compartment. The stepwell shall remain gage number 14 (.075" thickness) stainless steel, with a stainless steel battery tray that is easily accessible with a removable step cover. The battery compartment shall be vented in a manner that prevents debris from entering and the tray shall be coated with an acid resistant coating. The stepwell shall have adequate capacity to support the battery equipment. The battery tray shall allow movement to permit full service of batteries outside of the bus body. The stepwell compartment must be marked to say "auxiliary battery inside". Recommended Battery Sources: OEM</p>	<p>Complies with specification</p>
<p>c. Battery positive and ground cables shall be AWG size 2/0 minimum, fine stranded, flexible copper wire with permanently affixed cable connector ends with heat shrink tubing applied. All cable ends shall be fastened in a manner equal to the method used by the chassis Original Equipment Manufacturer (OEM). Positive cable ends at the battery shall use a protective cover or cap as an added insulator. Cable assemblies installed in place of chassis manufacturer's battery cables shall be sized to match the electrical system's maximum current draw to provide proper engine starting and operation of all systems.</p>	<p>Complies with specification</p>
<p>d. Engine, body, and equipment grounds (properly sized) shall be installed to handle subsystem electrical capacity. For all ground wire connections; 1) paint shall be removed at the grounding point to provide a cleaned surface; 2) grounding wires and cables fastened to the frame or body structure shall use a bolt with nut installed in a proper sized hole; and 3) a coating of dielectric material shall be applied to the cleaned surfaces, cable ends, bolts, and nuts where each positive or grounding cable or wire is attached. The following is a list of grounding locations:</p> <ul style="list-style-type: none"> i A ground of the battery cable size shall be installed between the engine and chassis frame. ii Between the transmission case and the chassis frame. iii The bus body shall be properly grounded with cables to the chassis frame in at least two places. iv Lift pump motor shall be grounded directly to chassis frame using a cable of the same size as the pump motor feed wire. 	<p>Complies with specification</p>

<p>v All exterior lights and accessories, added by the body manufacturer, shall be grounded by an in-harness ground attached at a common grounding point. There may be a common grounding point in the rear of the bus to the frame along with a required grounding point at the fuse panel.</p>	
<p>e. All buses shall be supplied with proper radio frequency (RF) suppression equipment to reduce radio interference and improve radio transmission and reception performance. High corrosion resistance and high conductivity braided ground straps shall be added: between the engine and the chassis frame of 1" width, minimum; between the engine and the firewall of ½ " width, minimum; two between the frame and the body sections of ½ " width, minimum; and between the separate body sections of ½ " width, minimum. For all braided ground wire connections, paint shall be removed and a coating of dielectric material applied to the cleaned surfaces where each braided cable attaches as is required in other ground wire applications. All removable covers in the engine area including fiberglass hoods need to be shielded and RF grounded. All braided high corrosion resistance and high conductivity ground straps shall be as short as possible and shall use the negative battery cable attachment point (except those between separate body sections) as the termination point of the RF grounding.</p>	<p>Complies with specification</p>
<p>38) Alternator</p>	
<p>a. The alternator equipment shall be furnished by the chassis manufacturer where high output will match system needs. This system shall be a 12-volt serpentine belt drive with internal or external voltage regulator. It shall be capable of maintaining the battery at a state of full charge under all operating conditions and equipment loads, 200 amp minimum. The alternator(s) shall be supplied with proper radio frequency (RF) suppression equipment. Any bracket modifications shall not reduce the strength of the mounting bracket. Chassis alternator equipment available that is unable to meet electrical needs may be replaced by Delco/Remy, Mitsubishi, Leece-Neville, or PennTex that will meet system needs. Any non-Original Equipment Manufacturer (OEM) alternator equipment installed on a bus by the body manufacturer shall be covered by a minimum warranty period equal to the chassis OEM alternator warranty. It is the responsibility of the manufacturer (bus supplier) to match the alternator performance to the bus's electrical system needs.</p>	<p>Complies with specification – Ford OEM</p>
<p>39) Engine Fast Idle</p>	
<p>The engine shall be equipped with fast idle control which includes manual and automatic control features. Fast idle shall not activate unless the transmission control is in park (P). The control system shall have a manual switch, volt sensor, an indicator light, and activate automatically from voltage sensors. The system shall automatically deactivate when bus is shifted into gear and when the bus foundation brakes are applied. Suggested source: Chassis manufacturer's equipment, Gateway by Intermotive Products, Penntex Model PX-HI-(mod no) with time out module, Vortec MD30-2500.</p>	<p>Complies with specification – Intermotive Gateway</p>
<p>40) Brakes</p>	
<p>a. The bus foundation brakes shall be a power-actuated hydraulic split system of a four wheel disc type with a three channel anti-lock braking system. The system shall</p>	<p>Complies with specification – Ford E Series OEM</p>

be the heaviest-duty available for stop and go operation. The brake system shall include a red brake warning lamp (RBWL) in the instrument cluster that lights when the parking brake is on, when a front or rear hydraulic failure occurs, or when brake fluid is low in the reservoir and act as a low brake warning system. The parking brake shall be re-buildable and the heaviest-duty available from the chassis manufacturer.	
b. Parking Brake – Rebuildable and repairable by trained technician, heaviest-duty available from chassis manufacturer.	Complies with specification – Ford E Series OEM
41) Fuel Tank	
a. Fuel tank capacity shall be the largest size available for each chassis. Fuel fill shall not extend beyond the exterior surface of the bus and may have the fuel cap set in a recess similar to a Ford OEM unit. Fuel fill shall be on the street (left) side of the bus. Fuel tank capacity shall be minimum for the following chassis/buses: i Small Class I: 40 gallons ii Small Class II: 55 gallons	Complies with specification – Ford E Series 40 and 55 gallons
42) Hazard Flashers	
Hazard flashers shall use the OEM switch and control system with an electronic flasher.	Complies with specification – Ford E Series OEM
43) Shock Absorbers	
Chassis shall have gas filled shock absorbers front and rear, most heavy-duty available from chassis manufacturer. It is the responsibility of the manufacturer (bus supplier) to match the shock absorber performance to the buses GVWR.	Complies with specification – Ford E Series OEM
44) Springs and Suspension	
a. The chassis shall be equipped with a heavy-duty tapered leaf (parabolic) spring or coil spring front suspension to match the specified gross axle weight rating.	Complies with specification – Ford E Series OEM
b. Chassis shall be equipped with a heavy-duty rear suspension to match specified gross axle weight rating.	Complies with specification – Ford E Series OEM
45) Stabilizer	
Chassis shall have heavy-duty OEM suspension stabilizers if available.	Complies with specification – Ford E Series OEM
46) Wheels	
Bus wheels (6) shall be 16.0" x 6.0" minimum, steel disc, hub piloted type, 8-hole flange nut style. Wheels shall have all stainless steel or all brass valve stems a minimum of 1½" in length retained by threaded nuts fitted with stainless steel, steel or brass valve caps with an inner air seal. Wheels shall be OEM white.	Complies with specification – Ford E Series OEM WHITE
47) Tires	
a. All tires (6) shall be tubeless, steel radial blackwall, single front, and dual rear. All tires shall be all season tubeless. Suggested sources: Hankook, Goodyear, Michelin XZA, UniSteel. The tires shall be the largest size available from chassis manufacturer to meet the GVWR.	Complies with specification – Ford E Series OEM
48) Driveshaft	
The multi-piece drive shaft shall be OEM and have full loop guards of sufficient strength to prevent any drive shaft section from striking the floor of the bus or the ground in the event of a tube or universal joint failure. Drive shaft guards, (OEM chassis equipment preferred, or may	Complies with specification – Ford E Series OEM

installed by the chassis manufacturer) shall be secured properly and be equal in materials and design to drive shaft guarding installed on a school bus chassis. Any modifications to driveline shall not create vibrations or cause premature wear.	
49) Wipers and Horn	
Electric wipers shall be two speed, delay style, dual jet washers (electric), with manufacturer's standard arms and blades (OEM equipment preferred). Wiper motors shall be mounted for easy access and not interfere with other equipment mounted in the front bulkhead/cowl of the bus. Where individual wiper motors are used (one for each side), each shall be supplied by its own fused feed wire. The bus shall have two electric horns.	Complies with specification – Ford E Series OEM
50) Radiator and Cooling System	
The cooling system shall have an extra cooling capacity radiator (aluminum or copper core), water pump, pulley, and clutch-type fan with coolant recovery system with a factory installed coolant filter – if available from OEM (heavy duty system installed by chassis manufacturer). Cooling system shall be winterized with 50/50 mixture (minimum) of permanent antifreeze and distilled water or a factory premix (minimum -35°F freezing point). Coolant integrity shall be maintained throughout the manufacturing process to insure that the coolant, including additives, in the delivered bus is equal to the coolant installed at the chassis OEM factory. All cooling system hose connections in the engine compartment shall use band clamps from OEM to control leakage.	Complies with specification – Ford E Series OEM with Constant Torque Clamps
51) Fluids	
Fluids shall be checked and filled from inside front hood where application allows. Engine oil fill/check, transmission oil fill/check, and coolant fill/check shall be located for easy access per approval at pilot model inspection. All fluids shall be at maximum full levels at delivery.	Complies with specification
52) Engine Cover and Trim	
a. The engine cover shall be insulated from engine heat, engine noise, and road noise. Additional equipment, including flooring, added to the engine cover area shall not interfere with removal/installation of the engine cover.	Complies with specification – Ford E Series OEM
b. The buses shall be equipped with an OEM chrome trim package for the grill and front trim (if available).	Complies with specification – Ford E Series OEM
c. A main wiring harness with Weatherpack connectors shall be use to disconnect any switches mounted on engine cover. Preferably one main connector for all switches.	Complies with specification – Weatherpack
53) Exhaust System	
The exhaust shall exit the rear of the bus and be flush with the rear bumper. If bus is equipped with a rear lift door, the exhaust shall exit the rear of the bus on the street (left) side flush with left end of the rear bumper. Exhaust system discharge shall be directed to the ground not straight out the back of the bus. The exhaust system shall meet FMVSS §393.83 and current Environmental Protection Agency (EPA) requirements. The exhaust system must be installed to provide maximum ground clearance and departure angle at the rear of the bus. Any exhaust system extensions shall be of the same material as OEM exhaust system, i.e. – stainless steel. All exhaust system extension hangers shall be OEM type.	Complies with specification – with Ford E Series OEM – OEM Style Hangers included.
54) Safety Items	

<p>a. The following safety items shall be provided on each bus and items noted with an asterisk (*) shall be in a location approved by the state at pilot model inspection:</p>	<p>Complies with specification</p>
<p>b. *One current year UL listed 5 pound, 2A-10BC dry chemical fire extinguisher. Fire extinguisher shall have a metal head, a gauge to indicate state of charge, and a bracket with heavy-duty strap for securement. Fire extinguisher shall be serviceable and rechargeable for the life of the bus with metal mounting brackets. Fire extinguisher shall be shipped loose. Source: Manufacturer's Standard.</p>	<p>Complies with specification</p>
<p>c. *One container of bi-directional emergency reflective triangles that meets FMVSS 125 and shall be in a location easily accessible to the driver.</p>	<p>Complies with specification</p>
<p>d. *A 12-volt 97-db sealed solid state electronic warning alarm that is readily audible from <u>outside</u> the bus when transmission is in reverse. The alarm shall: be steam cleanable; have passed a 1 million cycle test; and meet SAE J994, OSHA, Bureau of Mines and all State Regulations. The alarm shall be mounted with bolts and properly grounded and mounted on the rear of the bus near the license plate bracket. Suggested source: OEM standard.</p>	<p>Complies with specification</p>
<p>e. *An accurate exterior height (clearance) decal shall be mounted in the driver's dash area.</p>	<p>Complies with specification</p>
<p>f. The rear door shall have an audible alarm at driver area that is energized when the rear door latch handle starts to open and when the rear door is locked with the ignition in the on or accessory position. Open door alarm shall not effect the engine operation.</p>	<p>Complies with specification</p>
<p>g. An interlock system shall be provided to ensure that the bus cannot be moved when the lift is not stowed and that the lift cannot be deployed unless the interlock is engaged (to meet ADA regulation). The interlock system shall engage when the lift operation sequence is followed. Interlock operating instructions shall be included with each bus at delivery.</p>	<p>Complies with specification – Intermotive ILIS</p>
<p>h. An OEM chassis automatic daytime headlight control system shall be provided. The system shall illuminate the headlights when the ignition switch is on and the headlight switch is off. The system shall activate automatically after engine start up with the headlamp switch off and shall deactivate automatically when the headlamp switch is on or the ignition switch is turned off.</p>	<p>Complies with specification - OEM</p>
<p>i. A low-profile, voltage regulated non-PCB product with direct overmold plastic and no air gap construction LED electronic strobe light (white) with a clear lens and branch guard shall be provided. The light shall meet SAE J1318 requirements and be mounted centrally on the roof of the bus approximately 6 feet forward of the rear of the bus. Strobe light mounting shall have free access to connector with enough room to remove connector without removing any panels. The 12 volt light shall have a control switch in the driver's area. The light shall be approximately 4" in height, produce 80 (±10) double flashes per minute, and have a light intensity of 1 million candlepower with a current draw of approximately 1 ampere. Suggested Sources: Innotec, Meteorlite, Peterson, Target Tech Pulsator® 451, Truck-Lite</p>	<p>Complies with specification – with guard – dual flash</p>
<p>55) Electrical</p>	
<p>a. All exterior non-OEM connections shall be <u>WeatherPack</u></p>	<p>Complies with specification - WeatherPack</p>

<p>b. All wiring supplied by body builder shall have each wire permanently labeled with its function at least every eighteen inches.</p>	<p>Complies with specification</p>
<p>c. Lift equipped buses shall have a circuit breaker with a manual reset in the lift feed circuit. The circuit breaker shall be installed vertically (on the side wall) in the battery box, in the positive power cable leading to the lift power pack.</p>	<p>Complies with specification</p>
<p>d. Install a 12 volt power point for hand held equipment in the driver's area.</p>	<p>Complies with specification</p>
<p>e. All cable and wires added by the body manufacturer shall be continuous color coded and numbered or function coded. The manufacturer shall furnish complete as built wiring diagrams with integrated body and chassis wiring marked to show the codes used to include all optional equipment. Mating harnesses and harness connectors shall use matching wiring and coding unless chassis OEM wiring and coding is different from body manufacturer's. The wiring shall be designed to be a "plug and play" system where the harnesses and components are fastened through common standard terminal ends and connectors.</p>	<p>Complies with specification</p>
<p>f. Electrical panels installed by the body builders shall be located for easy access. Circuit breaker circuit protection shall be standard but blade type fuses may be used when expressly required by the component manufacturer. The master electrical panel shall use a separate "plug and play" connector and terminal system. Highest quality components available shall be used. One extra fuse shall be supplied for every amp size and style used on the bus body. All components shall be placed on the front of the electrical panel for ease of service.</p>	<p>Complies with specification</p>
<p>g. All wiring added to chassis fuse block shall be securely fastened to prevent wires from being knocked loose or loosening from vibration. The manufacturer shall use wire raceways where needed. Wiring, harnesses, and raceways shall be supported at regular intervals by "P" clamps, or by other supporting hangers where necessary, and routed in separate hangers from heater hoses or air conditioning hoses. Body fuse/electrical panel shall be sufficiently sealed to prevent intrusion of dirt and moisture.</p>	<p>Complies with specification</p>
<p>h. All wiring shall be heavy-duty; be properly grounded to body frame structure and the chassis; use a common grounding point; and be adequate for electrical system capacity. All wiring passage holes through engine cowl, floor area, and other partitions shall be thoroughly sealed to prevent dust and moisture intrusion.</p>	<p>Complies with specification</p>
<p>i. All accessories and accessory electrical equipment shall be wired through a constant solenoid energized when the bus's ignition switch is in "ignition on" or "run" mode. A master switch with light in the driver's control panel shall control this constant solenoid and act as a quiet switch overriding individual switches for accessories. This master switch is wired in series with the ignition switch to control the constant solenoid. The constant solenoid shall not control headlights, taillights, emergency lights, charging system voltage regulator energizer lead, a fused power lead for the passenger door, and a fused constant power lead for all electronic control units' long term memory.</p>	<p>Complies with specification</p>
<p>j. All control switches, relays, and circuit breakers used for the various electrical circuits shall have a current carrying</p>	<p>Complies with specification</p>

<p>capacity adequate for the circuit that they control and shall be properly marked for their function. The illuminated switch markings shall be permanent and not wear off with switch use. Control switches shall be dimmable and positioned for easy access from driver's seat. (Location to be determined at pilot model production).</p>	
<p>k. All added wiring shall be installed in a properly sized and supported split open-type loom or a properly supported raceway for protection. All wiring harnesses shall have adequate length to allow for harness flexing from supporting brackets and where harnesses connect to electrical equipment. Any wiring added by splicing into an existing chassis Original Equipment Manufacturer (OEM) harness or wire shall match modification standards set forth by the chassis manufacturer, such as Ford's QVM. Any added accessories or electrical circuits shall not interfere with nor back-feed into other electrical circuits. Any excess harnesses shall be properly secured.</p>	<p>Complies with specification</p>
<p>l. Wiring added from OEM chassis wiring to rear lights, fuel tank, and/or other accessories shall be supported and protected from the ice and snow build-up. Wiring shall be inside bus where possible. Wiring to taillights and other exterior lights shall be long enough to remove assembly by 6" for service. Exterior connections shall be weatherproof positive lock connectors coated with dielectric grease. Suggested sources: Weather-Pak.</p>	<p>Complies with specification - WeatherPak</p>
<p>m. Scotch lock wire connectors are not acceptable and shall not be used for wiring installation. Terminals shall be as follows:</p> <p>i Machine crimped on wire ends shall be used on all harnesses and cable assemblies used in the production of buses. Harness assemblies shall have connectors matching a mating connector where harnesses attach to other harnesses, switches, or other electrical units. Connections made in any harness assembly shall use Sta-Kon® disconnects and splice connectors where machine applied connectors cannot be used. Connectors shall be properly crimped with Sta-Kon® tools and covered with heat shrink tubing. In-line fuse assemblies shall use spade type fuses in a Weather-Pak holder and shall be located for ease of service.</p> <p>ii All exterior wiring connectors (plug-ins) including harnesses shall be weatherproof positive lock with the connector pins applied with the proper crimping tool (Weather-Pak, Metri-Pak). All exterior ground connections, except factory supplied braided ground straps, shall have properly applied terminal ends with heat shrink insulation applied. All connections exposed to the weather shall have dielectric grease applied to prevent corrosion.</p>	<p>Complies with specification</p>
<p>56) Equipment Options</p>	
<p>a. Air Conditioning – Split System</p>	
<p>i The air conditioning system (AC) shall have a separate compressor, condenser, and evaporator for the front system and for the rear system (two separate systems). The systems shall be 12-volt and use refrigerant type R-134A. The systems shall be of sufficient capacity to maintain interior temperature requirements stated in the test procedure for air conditioning systems during</p>	<p>Complies with specification – See Equipment List F for details</p>

summer operation (see section C. Vendor/Manufacturer Requirements, subsection 3. Air Conditioning Certification).	
<p>ii The front AC system shall be integrated as part of the front heating/ventilating unit including the driver's area evaporator unit (complete front system may be Chassis OEM with OEM controls and sensors). The front system shall provide temperature control with sufficient cooling ventilators for driver comfort with no reliance on the rear system for front temperature control. Front and rear air flow and temperature shall be controlled by separate switches on the driver's control panel or dash panel. Front and rear systems shall have separate fan, evaporator, and compressor controls.</p>	<p>Complies with specification – See Equipment List F for details</p>
<p>iii The rear system shall have an electronic control system capable of providing automatic temperature control, freeze protection, compressor protection, and diagnostic functions. The driver's automatic temperature and system control panel shall be mounted in the driver's station. The control system shall be an integral part of the system temperature controls. The system shall be able to monitor system voltage, high refrigerant pressure, low refrigerant charge, and clutch cycling intervals and shall protect the system by controlling compressor clutch engagement. The system shall be able to interpret associated problems and provide codes for technician diagnosis. Suggested sources: ACC Climate Control Model MDS, MCC ECO Temp Lite, Thermo King Clima Aire, ProAir.</p>	<p>Complies with specification – See Equipment List F for details</p>
<p>iv Compressors: There shall be two engine mounted, serpentine belt driven air conditioning compressors. OEM chassis front system (may be chassis OEM compressor). Rear aux AC system compressor to have a minimum 13cu. displacement. Hose end metal fittings connecting hoses to the compressor shall be electro-coated steel that pass the ASTM B117 480 hour Salt Spray test (see section C. Vendor/Manufacturer Requirements, subsection 8. Bid Documents, items v.). The compressor clutch circuit shall be interrupted when abnormal pressures are detected by the pressure monitoring switches. Low pressure switch shall be located between the expansion valve and the compressor in the low pressure side of the system. The high-pressure switch shall be located between the compressor and thermal expansion valve (for TXV systems) or between the compressor and the orifice tube (for orifice tube systems) to protect the entire high-pressure side of the AC system. Suggested sources: ACC Climate Control, ProAir, Thermo King, Trans/Air; MCC Mobile Climate Control</p>	<p>Complies with specification – See Equipment List F for details</p>
<p>v Condensers: The rear system's condenser shall be roof mounted (11" or less in height) and the front system may use the Chassis OEM radiator mounted condenser. The protective external grille work for the roof mounted condenser coil fins shall not be mounted directly against the condenser fins. The condenser fans and motors shall be enclosed within the condenser housing. The housing shall be galvanized or aluminum with heat-fused powdered epoxy coating. The condenser coil shall be copper or aluminum tube expanded into aluminum fins or MCHX condenser.</p>	<p>Complies with specification – See Equipment List F for details</p>

<p>Hose end metal fittings connecting hoses to the condenser shall be electro-coated steel that pass the ASTM B117 480 hour Salt Spray test (see section C. Vendor/Manufacturer Requirements, subsection 8. Bid Documents, items v.). High pressure cut out switches shall be wired into the clutch circuit. The condensers shall be equipped with axial fans dynamically balanced with permanent magnet totally enclosed motors. The condensers shall blow air upward and toward the rear of the bus assisted by the forward motion of the bus. A refrigerant dryer and a sight glass shall be required in the system. A branch guard the same height as the condenser shall be mounted just forward of the condenser assembly on the roof of the bus which shall not restrict air flow into the condenser assembly. Branch guard shall mounted with the same hardware as the condenser. Suggested sources for roof mounted condenser: ACC Climate Control, ProAir, Thermo King, Trans/Air.; MCC Mobile Climate Control</p>	
<p>vi The front evaporator (may be chassis OEM equipment) and rear evaporator(s) shall have three-speed continuous duty permanently lubricated blower motors with sufficient CFM capacity to maintain interior temperature requirements stated in test procedure. The rear evaporator cores shall be a copper coil with aluminum fins (three rows deep, minimum), galvanized heavy-duty frame and coil end sheets with a galvanized or plastic drain pan. The rear evaporator expansion valve or orifice tube shall have "O" ring refrigerant connections. Suggested sources: ACC Climate Control, ProAir, Thermo King, Trans/Air; MCC Mobile Climate Control</p>	<p>Complies with specification – See Equipment List F for details</p>
<p>vii The driver's evaporator (may be chassis OEM equipment) shall be controlled separately from the rear passenger area evaporator. The controls shall include an on/off switch and a three-speed blower switch. The in-dash unit shall not interfere with removal or replacement of the engine cover or be blocked by the entrance door control mechanism.</p>	<p>Complies with specification – See Equipment List F for details</p>
<p>viii The passenger area evaporator system shall be separately controlled from a control station at the driver's position. The controls shall include all features described in Section 56, a, iii. The evaporator shall be ceiling mounted at the rear of the passenger compartment.</p>	<p>Complies with specification – See Equipment List F for details</p>
<p>ix The components of the air conditioning system shall be readily accessible for maintenance. Service/charging ports shall be accessible under-hood without removing any other component or item. The refrigerant hose construction shall comply/exceed SAE specification J2064 Type D or E. Refrigerant fitting construction shall comply/exceed SAE specification J2064 Type D or E. All refrigerant hose end fittings shall be electro-coated steel that will pass the ASTM B117 480 hour Salt Spray test (see section C. Vendor/Manufacturer Requirements, subsection 8. Bid Documents, items v.). The hose coupling end of all fittings shall include two hose barbs and two areas of elastomeric or HNBR seals. Refrigerant hose clamp construction shall: comply/exceed SAE specification J2064 Type D or E; be made of stainless steel to ensure coupling integrity;</p>	<p>Complies with specification – See Equipment List F for details</p>

properly align hose end fitting; and clamp the hose directly over the elastomeric or HNBR seals. Refrigerant hose fittings shall be Aeroquip E-Z Clip system, ATCO Air-O-Crimp, MCC FlexCLIK.	
x The wiring shall meet all applicable specifications (see Section B. Body Structure and Exterior Panels, subsection 55. Electrical). The evaporator and condenser wiring (power and ground circuits) shall be properly sized to provide maximum voltage drop of 1.5v to farthest system component.	Complies with specification – See Equipment List F for details
xi Air conditioning electrical circuits shall be protected with manual resettable circuit breakers or fuses.	Complies with specification
xii The rear air conditioning system shall be supplied from the equipment manufacturer as a complete unit including controls, wiring and hoses. The whole system shall be warranted from in-service date, by the manufacturer, for a period of two years with unlimited mileage.	Complies with specification
xiii All fault codes shall be cleared upon delivery.	Complies with specification
b. Air Conditioning/Heat – Rooftop System	
The rooftop AC system shall meet all of the requirements of the AC split system except that the rear evaporator and heating unit shall be an integral part of the rooftop AC unit so that the condenser unit, evaporator unit, and heating unit are part of a single roof mounted unit. A coolant circulating pump shall be installed in the coolant lines for the rooftop heating unit. The auxiliary coolant heating unit and coolant pump for the rooftop heating unit shall be connected electrically to run whenever the bus's rooftop unit calls for heat. The rooftop unit shall be a free blow system installed in the central roof area of the passenger compartment of the bus with stainless steel fasteners and cover bolted down. Securement of the AC cover by means other than bolts or screws is allowed as long as <u>constant tension positive locking ¼ turn fasteners</u> are utilized. The air conditioning/heating system shall be supplied from the equipment manufacturer as a complete unit including controls, wiring, electrical protection devices, and hoses. A branch guard shall be installed to protect the roof-mounted air conditioner. The whole system shall be warranted from in-service date, by the manufacturer, for a period of two years with unlimited mileage. This system eliminates the need for the floor heater specified in Section 23. Suggested Sources: ACC Climate Control, American Cooling Technology, Inc., Thermo King, Trans/Air.; MCC Mobile Climate Control	Complies with specification – See Equipment List F for details
c. Auxiliary Coolant Heater	
i All buses shall be equipped with an auxiliary heater system that shall be able to preheat, provide supplemental heat, and maintain heat for the engine and the interior of the bus. The auxiliary heater system shall be supplied in heated coolant model for all engines. The heater system shall be complete with all fuel and electrical controls, exhaust system, and standard warranty. All auxiliary heaters shall be 12-volt units with a fused power supply and with protection for high and low voltage conditions. The auxiliary heater	Complies with specification – See Equipment List F for details

<p>system shall meet FMVSS 301 fuel system integrity requirements. The heating units shall be fueled from the bus's primary fuel supply. The auxiliary heating units shall be connected electrically to run whenever the bus's rear heat exchanger fan is turned on. The on/off seven day programmable modular electronic timer controls for the heating units shall be located in the driver's area of each bus. The seven-day timer control shall be capable of a two hour preheat control, minimum, and be capable of continuous run control when the key is on with the engine running. The electrical connection shall be a one piece harness from the control switch to the heating unit with all exterior connections Weather-Pak. Location shall be determined at the Pre-Pilot Model Review Meeting.</p>	
<p>ii The heated coolant model shall be a self-contained unit mounted under the bus near the rear heating unit, and connected to the heater hoses leading to the rear heating unit. The auxiliary heating unit inlet and outlet hoses shall have 5/8" ID heavy-duty brass ¼ turn ball valves for shut off when the heater needs to be removed for servicing. It shall be in an enclosure supplied by the auxiliary heater manufacturer, be installed so that adequate ground clearance exists below the heater enclosure box, be easily accessible for servicing, be weather resistant, and be complete with mounting brackets/hardware and coolant circulator pump. The coolant circulator pump shall provide a minimum flow of 2.6 gallons per minute. The heated coolant system units shall have safety features for temperature regulating and overheat shut down switches. A seven day digital timer shall be used to control operation. The auxiliary heater exhaust shall exit just below the heater enclosure toward the rear of the bus or at the side of the bus. The coolant heater shall control coolant temperature between a low of 154°F and a high of 185°F. Coolant heater output shall operate automatically at different levels with a high heat output of 17,100 BTU/hr minimum (boost setting may be higher). Suggested sources: Espar Inc., S3 Hydronic B5CS (heated coolant), OEM, Webasto Thermo Top EVO (heated coolant).</p>	<p>Complies with specification – See Equipment List F for details</p>
<p>d. Auxiliary Air Heater</p>	
<p>i The auxiliary air heater systems provided shall be able to preheat, provide supplemental heat, and maintain heat for the interior of the bus for all engines. The auxiliary heater systems shall be supplied as a heated air model with an on/off, variable digital temperature display, and with a seven-day electronic timer control. The seven-day timer control shall be capable of a two hour preheat, minimum and be capable of continuous run control when the key is on with the engine running. The auxiliary direct heated air heater unit(s) shall be self-controlled by the electronic controller to avoid unnecessary short cycling when the OEM heating system can supply the necessary BTUs. The system control units shall be located in the driver's area of the bus and shall indicate to the operator that the heater is operating normally or that the heater is not operating normally and needs technical service. The direct heated air heater control shall indicate heater diagnostic codes and descriptions directly from the heaters electronic control module.</p>	<p>Complies with specification – See Equipment List F for details</p>

<p>ii The heater system shall be complete with all fuel and electrical controls, exhaust system, and standard warranty. Fuel pump shall be mounted per auxiliary heater manufacturer's instructions. All heaters shall be 12-volt units with a fused power supply wired directly to the battery, and with protection for high and low voltage conditions. The auxiliary heater system shall meet FMVSS 301 fuel system integrity requirements. The heating units shall be fueled by the bus's primary fuel supply. The electrical connection shall be a one piece harness from the control switch to the heating unit with weather-pak or equal exterior connections.</p>	<p>Complies with specification – See Equipment List F for details</p>
<p>iii The heated air model (with mounting brackets) shall be a self-contained unit placed in the passenger area either between the bus seat and bus floor or in a clear free space in the interior of the bus (placement shall be decided at the time of installation). Installation position shall provide free air flow towards front to back or back to front, not directed to sides or other obstructions to airflow. The heated air system shall be a variable output, multi-stage heater for all engines. The heating unit shall have, 1) 16,000 BTU heat output, minimum (high heat setting), 2) 100 CFM of air delivery, minimum, and 3) automatic cycling between heat output stages. The unit shall have automatic overheat protection. All heater systems' fuel and exhaust connections shall be made outside the passenger compartment of the bus. The auxiliary heater exhaust shall be connected to a section of rigid exhaust pipe with a down sweep that exits just beyond the body side. The heating unit shall be fueled from the bus's primary fuel supply. Suggested sources: Espar Inc., Webasto.</p>	<p>Complies with specification – See Equipment List F for details</p>
<p>e. Destination Signs</p>	
<p>i Option 1 – Roller/Curtain: A 12-volt destination sign with a motor driven movable sign curtain mechanism shall be provided which meets ADA requirements (one front sign and one side sign). The sign curtain shall be approximately 36" wide and illuminated. The sign system shall have up to 15 destinations. The sign box shall have a door to open for the operator to view the sign curtain position. The door shall be positioned for ease of driver operation. A restraint shall be installed to prevent the storage door from opening beyond 105° when the installation allows the door to swing open. Suggested source: Transign LLC.</p>	<p>Complies with specification – See Equipment List F for details - Transign</p>
<p>ii Option 2 – LED: A solid state, LED destination sign shall be provided which meets ADA requirements (one front and one side sign). Signs shall be programmable using latest version of Microsoft Windows® based software. All hardware and/or software shall be provided with the first bus purchased by each transit agency. Suggested sources: Transign LLC Destinator, TwinVision MobiLite.</p>	<p>Complies with specification – See Equipment List F for details - Transign</p>
<p>f. Donation Box</p>	
<p>A donation box (in lieu of the farebox) shall be mounted on an adequately braced stanchion; shall be located over a flat floor surface near the driver; and shall be accessible to passengers entering the bus (meet ADA requirements). The lockable donation box shall be supplied with two keys (location shall be approved by the ordering agency). Suggested source: Diamond.</p>	<p>Complies with specification – See Equipment List F for details - Diamond</p>
<p>g. Running Boards/Steps & Grab-handle</p>	

<p>The bus shall be equipped with either driver's side steps (suggested source: chassis OEM) or a 12" wide running board. The steps or running board shall be securely attached to the chassis frame and have the capacity to support 300 pounds. When available from OEM, a grab-handle shall be supplied on the outside driver's side.</p>	<p>Complies with specification – See Equipment List F for details</p>
<p>h. Farebox Electrical Prep</p>	
<p>Electrical connections and wiring only (no farebox) along with support stanchion shall be supplied to the area where the standard farebox would be mounted (location shall be approved by the State at pilot model inspection)</p>	<p>Complies with specification</p>
<p>i. Limited Slip Differential</p>	
<p>The limited slip differential powers both wheels yet freely permits wheel speed differentiation when required during turning using standard OEM equipment.</p>	<p>Complies with specification - OEM</p>
<p>j. Rear Emergency Exit Window</p>	
<p>i A bus equipped with a rear exit window shall have the window opening be approximately 1,200 square inches. The rear window shall have a latching device for opening from the inside of the bus which may be quickly released but designed to offer protection against accidental release. Latches shall be located on the sides of the exit window. Lever-type latches shall be used for rear emergency exit windows and shall secure the windows tightly shut, shall be easily operated, and shall not unlatch due to vibration during normal bus operation. The latches shall be made of non-corrosive materials and be designed for minimal maintenance needs. The rear window exit shall meet federal requirements (FMVSS 217). The rear window exit shall have an audible alarm and red LED warning light connected with Weatherpack connectors at the driver's area energized when the window starts to open with the ignition on. A clear full width path of 16" minimum height shall be provided to the rear exit window. No objects shall be placed in bus which restricts passageway to rear exit window except a bench style rear seat if equipped. All emergency exits shall be marked with instructions for proper use.</p>	<p>Complies with specification – with alarm</p>
<p>ii The bus rear exit window shall have a glue-on or static adhesion wide angle view Fresnel lens to improve vision directly behind bus. Minimum size shall be 80 square inches. Suggested source: Vanguard made by 3M.</p>	<p>Complies with specification</p>
<p>k. Paint – Optional Designs</p>	
<p>i The bus shall have an 11" belt painted stripe (no decals). An example would be: an OEM white bus with a 11" belt stripe.</p>	<p>Complies with specification - Sikkens</p>
<p>ii The bus shall have the roof painted a different color. An example would be: an OEM white bus with the roof painted red.</p>	<p>Complies with specification - Sikkens</p>
<p>iii The bus shall be painted a full body color, including the roof, other than OEM white. An example would be: a bus painted all red.</p>	<p>Complies with specification - Sikkens</p>
<p>iv The bus shall have a 6", 10-year, reflective, vinyl belt stripe. An example would be: an OEM white bus with a 6" vinyl belt stripe.</p>	<p>Complies with specification – 3M</p>
<p>l. Lifts (Platform) (Meet ADA Requirements)</p>	

<p>i All lifts listed below shall meet all of the lift requirements stated in section B. Body Structure and Exterior Panels, subsection 27. Type I Lift, except lifts that have an 800 lb capacity (in lieu of the standard Type I lift)</p>	<p>Complies with specification – See Equipment List F for details - Braun</p>
<p>ii Type I: An alternate make Type I platform lift shall be offered in lieu of the standard 1,000 lb lift. Suggested sources: Braun, Ricon</p>	<p>Complies with specification – See Equipment List F for details - Braun</p>
<p>iii Type II: The Type II platform lift shall have a power operated outer barrier on the lift platform. Suggested sources: Braun, Ricon</p>	<p>Complies with specification – See Equipment List F for details - Braun</p>
<p>iv Folding Platform: The folding platform lift shall have a platform that folds in the center during stowage and the lift platform is 37" usable width and 50" usable length. The folding platform lift provides an unobstructed view from inside the bus through the lift opening. Suggested Sources: Braun Vista 2, Ricon KlearVue model K-5005 ADA</p>	<p>Complies with specification – See Equipment List F for details - Braun</p>
<p>v An alternate 1,000-pound capacity lift manufacturer shall be offered as an option for agencies.</p>	<p>Complies with specification – See Equipment List F for details - RICON</p>
<p>m. Wheelchair Securement Optional Systems</p>	
<p>i The restraint system shall be a retractor style system and comply with ADA, and the new 2016 WC 18 standard for WC-19 wheelchairs. This system shall be a single point securement system and meet the same requirements as listed in section B. Body Structure and Exterior Panels, subsection 28. Wheel Chair Securement Area. Single Point Securement System: A wheelchair single point securement system (in lieu of "L" track anchorage system) shall offer 360 degree directional usage "pucks" and shall be cast stainless steel with a 3" x 2½" bolt to be secured to the floor positions. Sealant shall be applied between the under-floor backing plate and the under-body floor for reduction in corrosion. All anchorage fasteners shall include an anti-corrosion coating and be secured from the nut assembly side of the fastener wherever possible as to reduce any loss of coating on the fastener. Measurement of the securement locations shall be 54" from front plane to rear plane within the first securement location. The single point securement system shall meet the same requirements as listed in section B. Body Structure and Exterior Panels, subsection 28. Wheel Chair Securement Area. Center pucks between securement locations can share the same center of plane but the pucks shall not be shared from each securement locations. (i.e. separate single point securement systems for each wheelchair securement area). Pucks for each location, Location #1 Location #2 etc., shall be identified with color coded debris/bolt covers available from the securement supplier. Spacing of front securement pucks shall be no less than 30". Spacing of rear securement pucks shall be centered in the rear plane of securement area 13" to 15" apart. Each securement space shall have an additional anchorage puck as to aid in the securement of scooters or difficult mobility devices. This additional anchorage puck shall be centered between the rear anchorages. Suggested Sources: QRT 360 Q'Straint Slide N' Click, Sure-Lok, Titan 800 Slide N' Click, OMNI</p>	<p>Complies with specification – See Equipment List F for details – Q'Straint Slide-N-Click QRT 360 / AM Bruns WC18</p>

Slide N' Click Systems; AMF-Bruns Platinum Series WC-18or equivalent.	
<p>ii Additional Wheelchair Securement Positions: Ordering agencies shall have the ability to add additional wheelchair securement positions to the provided floor plans. The position shall match the same system as installed on the bus (L-track or 360 degree single point securement) and shall meet requirements as stated in section B. Body Structure and Exterior Panels, subsection 28. Wheel Chair Securement Area and section B. Body Structure and Exterior Panels, subsection 56. m., Wheelchair Securement Optional Systems, Seating shall be added or deducted to accommodate the additional wheelchair systems and shall meet vehicle weight requirements.</p>	<p>Complies with specification – See Equipment List F for details – Q'Straint Slide-N-Click QRT 360 / AM Bruns WC 18</p>
<p>iii Portable Oxygen tank holder to be usable with an L-Track application for easy installation and removal and shall include a release knob with visual lock indicator. Will have two anti-slip straps to contain cylinder. Shall be made of high-grade anodized aluminum. Product shall be tested to dynamic crash test at 30mph/20g. National School Transportation Specifications & Procedures, Support Equipment and Accessories, B.3 and IEP – IFSP Process, Guidelines, E.11 / Ambulance Manufacturer's Division AMD Standard 003, Oxygen Tank Retention System / Approved to the requirements of CEN standard - BS EN 1789:2007, Medical vehicles and their equipment. Suggested Sources Sure-LOK GO2</p>	<p>Complies with Specification - Sure-LOK GO2</p>
<p>iv (4) Assistive Blue loop straps shall be supplied per bus as to aid in securing difficult mobility devises. Shall match the suppling securement company.</p>	<p>Complies with specification</p>
<p>n. Two Way Radio Antenna/Power</p>	
<p>i All material and labor required for a pre-installation package for two-way radio equipment shall be furnished by the manufacturer. All equipment and accessories installed as part of the buses shall have no measurable radio frequency (RF) interference. All equipment installed on the bus must operate in its normal mode while radio transmissions are being made from an on board transmitter producing 110 watts or more of transmit power while operating in the range of 43 Megahertz (Mhz) to 900 Mhz. <u>Proper RF suppression shall be provided by the manufacturer in any equipment and accessories that can produce interference to eliminate such interference.</u> The bus frame and body shall be designed to provide no measurable radio interference (shielding) for improved radio emissions and reception performance.</p>	<p>Complies with specification</p>
<p>ii Two (2) antenna mounting plates (.060" steel minimum) shall be mounted in the roof of the bus for the purpose of providing a connection to the ground plane and providing a secure mount for the antenna. For buses with FRP composite bodies, the mounting plates may be installed in the front cap of the bus-one centered in the roof section of the cap and one centered in the left (driver's) side section of the cap. Each mounting plate must be properly positioned in relation to its ground plane to ensure proper operation of an antenna installed at that mounting point. The total thickness of the exterior shell of the bus in the mounting plate area including the mounting plate shall be no more than ½".</p>	<p>Complies with specification</p>

<p>iii Two (2) antenna ground planes, which are required for proper antenna operation, shall be mounted in each bus. All ground planes shall be radio frequency (RF) grounded to the chassis structure using high corrosion resistance and high conductivity braided ground straps of the proper size (3/8" minimum width). Ground planes shall provide a comparable area of radio transmission coverage whether buses have a FRP exterior body covering or have a FRP composite body. At each antenna access opening and mounting plate area, the ground planes shall be of proper size and shape for proper communication operations. The ground planes shall be a solid piece and operate over the range of frequencies from 43 Mhz to 900 Mhz. The ground plane material used by the manufacturer must be a durable material that can be connected to the antenna mounting plate and grounded to the chassis frame. The ground plane shall be of the proper size to protect passengers in the bus from unnecessary radiation from the transmitting antenna at the bus's antenna access openings. Antenna wiring shall be adjacent to power wiring.</p>	<p>Complies with specification</p>
<p>iv Two threaded type access holes with covers approximately 6" in diameter shall be installed at the following antenna mounting plate locations:</p> <ol style="list-style-type: none"> 1. For buses with FRP exterior body covering or FRP composite bodies the screw-type access holes may be installed in the front cap of the bus, one centered in the roof section of the cap and one centered in the left side section of the cap. Adequate space shall be provided between the installed access cover and the inner body to allow for routing of the antenna lead and its connections without interference. 	<p>Complies with specification</p>
<p>v A concealed thin wall plastic conduit, 5/8" I.D. minimum, (with antenna cable pull wire) shall extend from the antenna mounting plate locations (roof and above side window or in front cap) to the mounting location for the radio. When installed, the conduit shall have no sharp or right angle bends or be distorted to prevent insertion of the antenna lead. For both antenna mounting plate locations, sufficient space shall be left at each end of the conduit to allow easy removal and replacement of the devices attached to the cable. The antenna pull wire shall terminate behind the driver's seat with 2 feet of extra length extending into the bus interior.</p>	<p>Complies with specification</p>
<p>vi 12-Volt Power for the Two-Way Radio - The positive lead (red 8 ga wire fused at 40 amperes) for the radio connection shall be provided directly from the battery positive post. The ground lead (black, 8 ga) shall be connected directly to the chassis frame with a bolt, external tooth lock washers, and nut for fastening. Proper suppression equipment shall be incorporated in the bus's electrical system to eliminate interference with radio and television transmission and reception shall not cause interference with any electronic system on the bus. The radio power and ground leads shall terminate directly behind the driver's seat with 12 feet of extra length extending into the bus interior or as specified by Ordering Entity.</p>	<p>Complies with specification</p>
<p>vii Two (2) 12 volt ignition feeds shall be provided with fuse location as close to battery as practicable.</p>	<p>Complies with specification</p>

<p>viii A split loom or other flexible wire race-way (1" minimum) shall be installed from the radio location to the dash mounted microphone control location.</p>	<p>Complies with specification</p>
<p>ix The modesty panel behind the driver shall be used for radio mounting and shall be constructed to support 60 pounds of weight. To provide for radio mounting, a 5" minimum distance shall be provided between the driver's seat and the modesty panel when the driver's seat is in its most rearward travel position.</p>	<p>Complies with specification</p>
<p>o. Stereo/Radio and Public Address System</p>	
<p>i Option 1: An AM/FM stereo radio system shall be installed in the dashboard area within reach of the driver. At a minimum, the stereo system shall have an illuminated or LCD display along with controls for power, tuning, volume, and the ability to turn off sound to the rear speakers. A total of four (4) speakers shall be installed in the bus with two (2) speakers mounted in the front (audible to the driver and front passengers) and two (2) speakers mounted in the top rear wall of the bus. Suggested sources: OEM</p>	<p>Complies with specification - OEM</p>
<p>ii Option 2: A public address (PA) system shall be installed in the dashboard area within reach of the driver and utilize a hand held microphone. At a minimum, the PA system shall be equipped with controls for power and volume. A total of two (2) speakers shall be mounted with one in the front and one in the top rear wall of the bus. Suggested sources: Custom Radio Corporation model PA6, Jensen, Mobile Page Model 470, REI</p>	<p>Complies with specification</p>
<p>iii Option 3: A combined AM/FM stereo radio and a public address system shall be installed with four (4) speakers. The combined system shall meet or exceed the specifications outlined in option 1 and option 2. The speakers shall be mounted per locations specified in option 1. Suggested Sources: Jensen, Panasonic, REI</p>	<p>Complies with specification</p>
<p>iv Option 4: Additional speakers shall be offered at locations requested by the ordering agency.</p>	<p>Complies with specification</p>
<p>p. Raised Floor (No Wheel Wells)</p>	
<p>The bus shall be equipped with a raised floor where no wheel wells are showing in the rear of the bus. The raised floor shall not cause changes to any other requirements as stated in this specification. In addition, the stepwell shall meet the same requirements as specified in part 4, section A. <u>The steps shall all be in line located in the passenger stepwell.</u></p>	<p>Complies with specification</p>
<p>q. Entrance Stepwell Heater</p>	
<p>The entrance stepwell shall include a 12-volt electric heating element/unit for the lower step to prevent icing of entrance steps. The low voltage step heater shall consist of one or more wire elements laminated and vulcanized between two plies of .026" silicone rubber impregnated fiberglass cloth to maintain an approximate temperature of 160° F with a low temperature (30°F) sensing switch (Warm Welcome® by Lighthouse International, Ltd.; Ultra Heat). The entire lower step heating unit with power wires shall be enclosed between the stepwell and the step tread (beneath the step tread) of the lower step. Lead wires shall be loomed, supported by brackets, and protected by grommets where they pass through structure. The heaters shall be thematically controlled.</p>	<p>Complies with specification</p>

r. Manual Entrance Door	
<p>The manufacturer shall provide a heavy duty manually-operated passenger entrance door with control handle located in the driver's compartment within easy reach of the driver. The passenger entrance door shall not extend below the step frame. All exposed door frame structure shall be made of 304 stainless steel acid-etched, coated with zinc based primer and powder coated OEM white (including the fasteners). The door shall be located on the right side of the bus behind the right front wheel. The entrance door shall provide a 30" clear width opening, minimum, with all handrails installed. Door opening height from the top of the first step to the door header shall be a minimum of 76".</p>	Complies with specification – A&M
<p>Passenger entrance door shall be a double-folding, split-type double leaf swing door. This door shall have a flexible soft rubber cushion on the meeting edge 1 1/2" in width, minimum. The door glass shall be see-through, tinted (AS-2) safety glass. Under all operating conditions and bus speeds, an airtight and dust-proof seal shall be formed between the door and the stepwell, between the door and body opening, and between the door leaf sections.</p>	Complies with specification – A&M
<p>A method shall be provided to lock the bus when the bus is parked.</p>	Complies with specification
s. Seating (Additions and Deductions)	
<p>i On buses with a rear exit window, forward facing seating for five passengers shall replace two double place forward facing seats at the rear wall of the passenger compartment increasing the passenger capacity by one. The five passenger seating shall be available for buses without a lift or with the lift forward of the rear axle (no wheelchair lift and/or securement location at the rear of the bus). The five passenger seat shall be 88" minimum width and shall not be equipped with grab handles.</p>	Complies with specification – Freedman Seating Co.
<p>ii The Ordering Entity shall have the ability to add or deduct seats from the provided floor plans.</p>	Complies with specification – Freedman Seating Co.
<p>iii All additional transit style seats shall be of the same design and color as the other passenger seats, shall be equipped with passenger seat belts, and shall meet requirements stated in section B. Body Structure and Exterior Panels, subsection 16. Driver's Seats, and subsection 19. Seat material.</p>	Complies with specification – Freedman Seating Co.
t. Driver's Power Seat Base	
<p>Provide a six-way power seat base for standard driver's seat that allows for fore and aft, up and down, front tilt and rear tilt for the driver if available from OEM. Suggested source: Chassis Original Equipment Manufacturer (OEM) Deluxe Power Seat Base.</p>	Complies with specification – Ford OEM Power Seat
u. Alternative Engines	
<p>i Liquefied Petroleum Gas (LPG) or Compressed Natural Gas (CNG) The bus shall accept liquefied petroleum gas (LPG) or compressed natural gas (CNG)(Class II only) application if required for fleet compliance by federal Environmental Protection Agency (EPA) alternate fuel application guidelines. The engine/chassis shall include a gaseous fuel preparation package and the cylinder heads shall have hardened valve seats. LPG systems shall be either bi-fuel or dedicated LPG per ordering entity choice. All LPG and</p>	Complies with specification – Ford OEM 91G Gaseous Prep Engines. See equipment list for greater details.

CNG conversions shall maintain OEM powertrain warranties.	
ii On buses ordered with alternate fuels options (LPG, CNG, etc.) auxiliary heater systems installed shall meet the same specifications for the systems operating on gasoline. All heated air models shall have a 12-volt heater booster pump installed in the coolant line forward of the first rear heater. Additional equipment needed for auxiliary heater shall be included in the option. Suggested sources: Bergstrom 863040	Complies with specification
v. Stop Request System	
i An interior "Stop Requested" sign, chime, and driver signal activation system shall be installed, and activated by 1/8" diameter yellow cord mounted on the side wall even with the bottom of the tip-in-transom portion of the windows. Signal touch buttons mounted in an ADA mandated wheelchair accessible area shall be no higher than 4' above the floor, with no exposed wiring. A single "stop request" chime shall sound when the system is first activated and a tell-tale light indicator on the driver console will stay light continuously until the passenger door is opened. A double chime shall sound when the system is first activated from wheelchair passenger areas.	Complies with specification
ii A "Stop Requested" message in Helvetica medium red letters on a clear plexiglass background shall be illuminated when the passenger "Stop Requested" system is activated. The "Stop Requested" message shall remain visible until doors are opened. The sign unit shall be flush mounted on the front destination compartment door and the message shall be visible to the seated operator and all seated passengers. The operator shall be able to deactivate the signal system from the operator's area as well as automatic deactivation each time the passenger door is opened.	Complies with specification
w. Back-up Sensor System	
A rear back-up sensor system shall be installed with a minimum of four water-resistant and corrosion resistant sensors flush-mounted to the rear bumper (painted to match the bumper). The system shall automatically engage when the vehicle is in reverse and warn of objects and/or people up to a distance of seven feet (minimum). The system shall utilize an LED monitor, mounted within view of the driver, which displays the distance (in feet) from the object(s). The system shall also emit a pulsating alarm or beep that is audible to the driver as the vehicle approaches the object(s) and then the system shall emit a steady alarm within at a minimum of 1.5 feet from the object(s). Suggested Sources: Ackton Transportation Technologies, American Road Products, Intermotive Hawkeye, ROSCO	Complies with specification – Intermotive Hawkeye
x. Back-up Camera System	
Back-up camera system shall comply with all FMVSS 111 requirements. System shall include the following:	Complies with specification - Rosco
i. 7-inch LED color monitor with internal speakers, support up to three (3) cameras	Complies with specification
ii. Rear camera shall at a minimum have audio, IP69K dust and water rating, built-in microphone, shock rating of 50g @11ms (vs. 100g in specs) minimum and vibration rating 2@ 10hz-1,000Hz, 130 degree viewing angle minimum	Complies with specification

iii.	Harness with heavy-duty twist lock connectors	Complies with specification
iv.	Two-year warranty on complete system	Complies with specification
y. Video Surveillance System		
i.	The onboard digital video surveillance system shall include a six channel (minimum) mobile rated digital video recorder (DVR) that can be configured for a one to four camera system. Video surveillance system shall not be wired through the Master Disconnect Switch. The on-board DVR System shall include a lockable/removable 1 terabyte (minimum) hard disk drive caddy. USB data ports, analog audio/video RCA out terminals, a 10/100base-T Ethernet port, two analog audio/video (RCA) outputs, eight vehicle sensor inputs, a GPS input and one accelerometer input. The DVR shall begin recording at the start of the "engine run" switch of the vehicle or be programmable to begin recording at a specified time prior to "engine run" switch being activated. The DVR can remain functional up to 99 minutes after the ignition has been turned off, and shall record continuously without operator assistance. The DVR shall be able to retrieve video by alarm, calendar based date, time and camera search functions. The DVR shall be capable of a display resolution of 720 x 480. The DVR shall be constructed with a rugged outer housing that protects against shock, moisture and dust. System shall perform to standards in various temperature extremes of a range between -20°F to 95°F.	Complies with specification - See Equipment List F for details
ii.	An accelerometer shall document hard breaking and other erratic driving events. A panic button or event marker shall also be installed within reach and view of the driver.	Complies with specification - See Equipment List F for details
iii.	Sensors shall record bus signals including turn, hazards lights, and lift operations at a minimum.	Complies with specification - See Equipment List F for details
iv.	A GPS receiver shall continuously monitor bus location, heading, and speed, as well as configurable and automatic time and date synchronization. The GPS antenna shall be roof mounted or as specified by Ordering Entity.	Complies with specification - See Equipment List F for details
v.	Microsoft® Windows compliant viewing software shall be included with the first bus delivered to the agency. Software shall be able to view and search video from the hard drive, display a GPS map, graph speed, and save the videos.	Complies with specification - See Equipment List F for details
vi.	Interior and exterior cameras shall be full color, high definition, wide angle (minimum 120°) infrared and shall supply an image that is clear and stable, free from vibration. Images shall be able to be used to positively identify a passenger riding in a vehicle. The interior cameras shall also have a high sensitivity microphone. Ordering agencies shall have the flexibility to position cameras. Below is a list of interior locations and optional cameras: 1. Two Camera System: A two camera system shall be provided capturing the driver, passengers, stepwell, and farebox/donation box at a minimum. 2. Four Camera System: The four camera system shall include the camera locations listed in option one and include a cameras capturing wheelchair lift and a rear passengers at a minimum.	Complies with specification - See Equipment List F for details

<ol style="list-style-type: none"> 3. Six Camera System: A six camera system shall include an eight channel (minimum) DVR and a one terabyte minimum hard drive. Camera locations shall be same the two and four camera system with the addition of another interior camera (located at the requested of the ordering agency) and an exterior camera facing forward capturing the passenger door. 4. Additional Interior Cameras: Ordering agencies shall have the ability to order additional cameras and select a location at time of order. Additional cameras shall include all additional wiring and mounting hardware. 5. Exterior Cameras: Ordering agencies shall have the ability to order exterior cameras and select a location at time of order. Additional cameras shall include all additional wiring and mounting hardware. 6. DVR system upgrade shall provide an option to upgrade the DVR system to an eight channel one terabyte hard drive minimum. 7. Back-up monitor system shall include active monitor in driver's station for programing and shall be operational when vehicle is in reverse. 8. <u>Correct time and date shall be programmed in system upon delivery.</u> 9. Suggested sources: Radio Engineering Incorporated (REI), SEON, SafetyVision, AngelTrax 	
<p>y. Video Surveillance Preparation Package</p>	
<p>i A video surveillance preparation package shall be offered (less cameras and digital video recorder system) allowing for one to four camera locations. The preparation package shall include the installation of camera wiring or conduit, DVR electrical connections, location for the DVR, and access covers for camera mounting/locations. Ordering agency shall specify the camera system to use and have the flexibility to position cameras.</p>	<p>Complies with specification</p>
<p>ii Vendor shall supply all materials.</p>	<p>Complies with specification</p>
<p>z. Rear Suspension Assist System</p>	
<p>Chassis shall be equipped with a heavy-duty rear suspension fitted with a rubber shear spring suspension that works in conjunction with the OEM chassis leaf spring suspension to match the specified gross axle weight rating. The added suspension shall consist of a spring carrier assembly, a frame hanger assembly, and rubber shear springs, and shall be installed in place of the original spring hanger and shackle assembly at the aft end of the drive axle leaf spring. The frame hanger must bolt into the existing Original Equipment Manufacturer (OEM) spring hanger holes in the frame. MOR/ryde® "RS" Suspension System. In addition to the MORryde RS Suspension System, the OEM chassis front and rear shock absorbers shall be replaced with performance monotube gas pressurized shock absorbers, and the OEM drive axle sway bar shall be upgraded to a larger diameter heat treated sway bar with polyurethane bushings (where applicable). The complete system must not alter the specified gross axle weight ratings of the OEM chassis. MOR/ryde® "RSX" Suspension System</p>	<p>Complies - MOR/ryde® "RSX" Suspension System</p>

aa. Spare Tires	
A spare tire option shall be offered for both the steer and drive axle tires if they are of different tread design. Spare tire shall match brand and specifications on delivered vehicle.	OEM Matching - Complies
bb. Entry Door Grab Handles	
Each bi-folding entry door section shall have a yellow grab handle mounted midway up to assist passengers.	Complies - Yellow
cc. Interior Mirror	
Interior mirror (with adjustable mounting bracket) shall be a 6" by 8" minimum convex mirror glass with rounded corners, minimum. The driver shall be able to adjust the mirror from the driver's seat so that the complete passenger compartment can be viewed through interior mirror. Mirror mounting points shall be reinforced when not in a structural frame member, with location approval by the State at the time of pilot model inspection. Suggested source: B&R Manufacturing, ROSCO (with bracket).	Complies with specification
dd. Wheelchair Lift Barriers	
Plexiglass barriers shall be installed on stanchions on both front and rear of lift to prevent pinch injuries in lift assembly.	Complies with specification
ee. Ceiling Handrails	
i. Two full length transit-type ceiling handrails shall be provided and securely attached to roof structure. The handrails shall be a minimum of 1¼" outside diameter, brushed finish, stainless steel including mounting brackets and fittings. The handrail ends shall curve toward and terminate at the ceiling. All handrails shall meet ADA regulation in 49 CFR Part 38, Subpart B-- Buses, Vans and Systems, §38.29 requirements for position and size.	Complies with specification
ii. All handrail mountings shall have steel reinforcement plates welded to or imbedded in structure behind surface panels of sufficient strength to withstand passenger force. Final locations shall be determined at pilot model production.	Complies with specification
ff. Slide-out Battery Tray	
The second battery shall be mounted on a slide-out tray with nonmetal battery hold down secured with bolts. Both batteries shall have a protective cover over the positive charge. The tray, covers, slides and rollers shall be stainless steel. The slide-out tray shall be mounted on properly supported mechanism, all of which shall have adequate capacity to support the battery equipment. The battery slide-out tray shall allow movement to permit full service of batteries outside of the bus body. The inside of the battery compartment shall be covered with a durable insulating material to prevent electrical shorts. The totally enclosed battery compartment shall be vented, and the tray shall be coated with an acid resistant coating. The battery compartment must be located below the floor line with adequate reinforcement brackets mounted to floor supports. The battery compartment shall be fitted with an insulated standard exterior access door to prevent accidental grounding with hinge and quarter-turn, non-	Complies with specification – In lieu of in step tray.

corrosive metal, thumb latches with positive stop mechanism or flush pull-style latch(es) (SouthCo Model #M1-61-1), which match latches on other compartment access doors. The battery box compartment must be marked to say "auxiliary battery inside"	
gg. Bike Rack	
Rack shall be constructed of stainless steel and be capable of storing two standard 48" WB bicycles. For reduced operating costs, it shall have a modular design with individually replaceable components. The bicycle rack shall accommodate conversion to accept fat tire bicycles. Suggest source: Sportworks, Byk-Rak	Complies with specification Sportworks
hh. Yellow energy-absorbent, vandal-proof grab handle mounted to the top of each seat back (two per double seat). Grab handles are not required on seats that have a back against a wall.	Complies – in lieu of black.
ii. Cruise Control	
OEM chassis cruise control shall be provided if available	OEM Chassis Cruise Control
jj. Alternate Flooring Manufacturer	
Shall be offered as an option for agencies and shall meet all specifications in B. Body Structure and Exterior Panels, subsection 6. Flooring	Complies with specification
C. VENDOR/MANUFACTURER REQUIREMENTS	
1) Bus Information Furnished	
Bus information in this section shall be submitted and reviewed at the pre-pilot model review meeting, at final pilot model production. Bus information identified by " * " shall also be supplied with each bus at delivery where indicated. All manuals shall be provided in an electronic copy (CD, DVD, or USB flash drive). The Contractor/manufacturer shall maintain record or proof that all bus information was supplied to the transit agency.	
a. Copy of manufacturer's statement of origin for a bus.	Complies with specification
b. * Warranty papers for chassis, body, and additional equipment with each bus at delivery.	Complies with specification
c. * Data sheet to include make, model, and serial numbers of all optional equipment.	Complies with specification
d. * As built drawings showing color coded wiring schematics of all electrical circuits, body, and chassis with each specific bus at delivery. Wiring drawings shall be in an electronic copy (CD, DVD, or USB flash drive).	Complies with specification
e. * Operator's manual for bus and all add-on equipment with each bus.	Complies with specification
f. * A complete set of repair manuals (and up-fitter manual if available from OEM) for the chassis and a manufacturer's parts manual for the body, and auxiliary equipment for the first bus of each model year delivered to each transit agency. Repair manuals shall be in an electronic copy (CD, DVD, or USB flash drive) as soon as available from OEM.	Complies with specification
g. * Drivability and emissions manual for the first bus of each model year delivered to each transit agency.	Complies with specification
h. * Bus operating instructions showing controls and operation for the first bus delivered to each transit agency	Complies with specification

and also in an electronic copy (CD, DVD, or USB flash drive).	
i. * Standard manufacturer's production option sheet(s)/decal(s) for chassis and body shall be installed in manufacturer's standard location, with no holes or rivets obscuring writing and numbers. Sheet shall include rear axle ratio. A paper copy of the service broadcast sheet for chassis shall also be provided with each bus.	Complies with specification
j. * Maintenance and inspection schedule incorporating the required maintenance and inspection of the basic bus and its subsystems (i.e., wheelchair lift) with each bus at delivery.	Complies with specification
k. * Proof of bus suspension alignment (work order or bill) at final bus inspection and with each bus. Four wheel alignment shall include adjustments to front and rear suspension and steering parts so that axle alignment, camber, caster, and toe settings are within +/- .1 degree manufacturer's alignment specification.	Complies with specification
l. * Proof of undercoating (warranty) at final bus inspection and with each bus.	Complies with specification
m. * Front end and rear towing and lifting instructions with each bus.	Complies with specification
n. * Wheelchair securement product instructions and training program.	Complies with specification
o. * The bus manufacturer shall provide air conditioning system performance certification (see section C. Vendor/Manufacturer Requirements, subsection 3. Air Conditioning Certification).	Complies with specification
p. * The bus manufacturer shall provide test results that certify the performance of the heating/ventilating system (see section C. Vendor/Manufacturer Requirements, subsection 4. Heating/Ventilating Certification).	Complies with specification
2) Manufacturer Quality Control	
a. Bus contractor/manufacturer shall provide a plan for quality control during bus construction and include the plan as part of the bid documents. Bus contractor/manufacturer shall also provide the name of the chief of quality control for bus construction.	Complies with specification – Included in proposal
b. The contractor shall establish and maintain an effective in-plant quality assurance organization. It shall be a specifically defined organization and should be directly responsible to the contractor's management and completely independent from production. The quality assurance organization shall exercise quality control over all phases of production from initiation of design through manufacture and preparation for delivery. The organization shall also control the quality of supply articles. The quality assurance organization shall verify inspection operation instructions to ascertain that the manufactured product meets all prescribed requirements. The quality assurance organization shall detect and promptly assure correction of any conditions that may result in the production of defective transit buses. These conditions may occur in design, purchases, manufacture, tests or operations that culminate in defective supplies, services, facilities, technical data, or standards. The	Complies with specification – Included in proposal

<p>contractor shall maintain drawings and other documentation that completely describe a qualified bus that meets all of the options and special requirements of this procurement. The quality assurance organization shall verify that each transit bus is manufactured in accordance with these controlled drawings and documentation.</p>	
<p>c. The contractor shall ensure that all basic production operations, as well as other processing and fabricating, are performed under controlled conditions. Establishment of these controlled conditions shall be based on the documented work instructions, adequate production equipment, and special work environments if necessary. A system for final inspection and test of completed transit buses shall be provided by the quality assurance organization. It shall measure the overall quality of each completed bus. A system shall be maintained by the quality assurance organization for identifying the inspection status of components and completed transit buses. Identification may include cards, tags, or other quality control devices. Inspection stations shall be at the best locations to provide for the work content and characteristics to be inspected. Stations shall provide the facilities and equipment to inspect structural, electrical, hydraulic, and other components and assemblies for compliance with the design requirements. Stations shall also be at the best locations to inspect or test characteristics before they are concealed by subsequent fabrication or assembly operations. These locations shall minimally include, as practical, under-body structure completion, body framing completion, body prior to paint preparation, water test before interior trim and insulation installation, engine installation completion, under-body dress-up and completion, bus prior to final paint touch-up, bus prior to road test, bus final road completion and presentation to resident inspectors. Tests shall be performed by the bus manufacturer to ensure that the unit is dustproof, water-tight, fumeproof, and that all bus fluids are per specifications. The quality assurance organization shall be responsible for presenting the completed bus to the resident inspectors. Sufficiently trained inspectors shall be used to ensure that all materials, components, and assemblies are inspected for conformance with the qualified bus design.</p>	<p>Complies with specification – Included in proposal</p>
<p>d. The State and/or the Ordering Entity may be represented at the contractor's plant by resident inspectors. They shall monitor, in the contractor's plant, the manufacture of transit buses built under this procurement. The contractor shall provide office space for the resident inspectors in close proximity to the final assembly area. This office space shall be equipped with desks, chairs, outside and interplant telephones, and other items sufficient to accommodate the resident inspector staff. Inspectors shall have lifting equipment available for raising vehicles for under vehicle inspections.</p>	<p>Complies with specification</p>
<p>3) Air Conditioning Certification</p>	
<p>a. The bus manufacturer shall provide air conditioning system performance certification at delivery (conducted</p>	<p>Will comply with specification</p>

<p>by an independent laboratory, or testing agency, or the air conditioner manufacturer and supported by documentation of the actual test on the pilot model bus) that the air conditioning system installed in the bus meets or exceeds performance levels required by these specifications. Tests shall be performed on all classes of buses. Tests shall be with OEM and optional systems combined.</p>	
<p>b. The air conditioning system performance testing shall be conducted using a heating chamber of sufficient size to contain the basic bus, to heat soak the bus at 100°F for 4 hours minimum, to simulate sun load entering windshield, and to maintain 100°F exterior temperature continuously after heat soak during testing. <i>Four hour soak will commence once bus internal temperature reaches 100°F.</i> An interior temperature of 72°F ($\pm 3^\circ\text{F}$) must be reached within 30 minutes from the beginning of the test. Engine speed shall be maintained at 1300 RPM (± 200 RPM) during the test.</p>	<p>Will comply with specification</p>
<p>c. Instrumentation for temperature monitoring of the bus interior shall be a minimum of 3 points in the passenger area 30" above the floor - one in driver's area, and one at the mid-point of the bus, and one at the rear seat area. Evaporators' air inlet and air outlet temperatures shall be recorded. Instrumentation and recording equipment shall be able to monitor all points, record data at one minute intervals, and print a data report.</p>	<p>Will comply with specification</p>
<p>4) Heating/Ventilating Certification</p>	
<p>a. The bus manufacturer shall provide test results at delivery, that certify the performance of the heating/ventilating system as installed in the bus meets or exceeds performance levels required by these specifications. Tests shall be performed on all classes of buses. The test should be conducted by an independent laboratory or testing agency and supported by documentation of the actual tests on the pilot model bus. Testing may be performed in natural cold climate conditions. Tests shall be performed on all classes of buses.</p>	<p>Will comply with specification</p>
<p>b. The bus will be cold soaked at 0°F ($\pm 3^\circ\text{F}$) for 4 hours minimum. An exterior temperature of 0°F ($\pm 3^\circ\text{F}$) shall be maintained during the test. An interior temperature of 64°F ($\pm 3^\circ\text{F}$) must be reached within 30 minutes from the beginning of the test. Engine speed shall be maintained at 1300 RPM (± 200 RPM) during the test. No dynamometer will be used.</p>	<p>Will comply with specification</p>
<p>c. Instrumented monitoring for the bus interior temperature to determine pass/fail, shall be a minimum of three points located front, center, and rear in the passenger area 30" above the floor. Additional monitoring points shall be; one in driver's area at knee level 22" above the floor, at front heater's air inlets and air outlets, and at rear heater's air inlets and air outlets. Other temperature monitoring points shall be: engine operating (coolant) at radiator; engine outlet to rear heater; rear heater return to engine; and exterior ambient.</p>	<p>Will comply with specification</p>

<p>d. Coolant flow shall be monitored from the engine outlet to the heaters only. Supplemental heat shall be supplied to raise engine to normal operating temperature. Supplemental heat shall be engaged 60 minutes prior to the start of the test. Instrumentation and recording equipment shall be able to monitor all points, record data at one minute intervals, and print a data report.</p>	<p>Will comply with specification</p>
<p>5) Purchaser Inspection</p>	
<p>The State and/or the Ordering Entity reserves the right and shall be at liberty to inspect all material and workmanship at all times during the progress of the work, and shall have the right to reject all material and workmanship which do not conform to the specifications or accepted practice. Where a resident inspector is used, upon the request to the quality assurance supervisor, the resident inspectors shall have access to the Contractor's quality assurance files related to this procurement. These files shall include drawings, material standards, parts lists, inspection processing and records, and record of defects.</p>	<p>Will comply with specification</p>
<p>6) Warranty</p>	
<p>a. Warranty shall become effective on the date the bus is placed into service by the Ordering Entity. Warranty service performed at the manufacturer's facilities at the manufacturer's request shall have all costs covered by the manufacturer. Warranty for the bus shall be the following as a minimum:</p>	<p>Complies with specification – See warranty details included in proposal</p>
<p>b. OEM on chassis.</p>	<p>Complies with specification – See warranty details included in proposal</p>
<p>c. OEM on transmission.</p>	<p>Complies with specification – See warranty details included in proposal</p>
<p>d. Three (3) years on body structure, exterior, undercoating, rustproofing, and paint.</p>	<p>Complies with specification – See warranty details included in proposal</p>
<p>e. Eighteen (18) months or OEM on lift, whichever is greater.</p>	<p>Complies with specification – See warranty details included in proposal</p>
<p>f. All wiring shall be warranted for one 1 year from date bus is put into service.</p>	<p>Complies with specification – See warranty details included in proposal</p>
<p>g. Manufacturer's standard warranty or one (1) year, whichever is greater, on other add-on components and items.</p>	<p>Complies with specification – See warranty details included in proposal</p>
<p>h. The chassis, body, and all add-on components shall be warranted by the successful contractor.</p>	<p>Complies with specification – See warranty details included in proposal</p>
<p>7) Miscellaneous</p>	
<p>a. The Contractor shall furnish the State with the delivery schedule of chassis to the Contractor and a delivery date of completed buses within 30 calendar days from date of order.</p>	<p>Will comply with specification</p>
<p>b. Any in-line equipment changes shall have prior written approval of the State.</p>	<p>Will comply with specification</p>
<p>c. The Contractor shall supply the bus turning radius: wheel-to-wheel and wall-to-wall.</p>	<p>Complies with specification – included in proposal</p>
<p>d. The Contractor shall furnish warranty procedure instructions and necessary forms used by customers to obtain necessary warranty repairs.</p>	<p>Complies with specification – included in proposal</p>

<p>e. The manufacturer(s) shall produce as the pilot model the first bus ordered by the State for its transit agencies. The bus shall be: 1) lift equipped, 2) air conditioned, and 3) the largest size on request by the transit agencies. All necessary testing and equipment placement shall be performed on the pilot models before final inspection/acceptance by the State (see Schedule A Statement of Work, section 7.2 Inspection, a. Pilot, Production Model, and Plant Inspections). The pilot model shall serve as a standard for the following units as ordered but shall not relieve the contractor from an obligation to manufacture all units in compliance with all specifications and granted/approved exceptions.</p>	<p>Will comply with specification</p>
<p>8) Bid Documents</p>	
<p><u>The bidder shall supply the following with the bid quotation and class of bus (if applicable). Failure to submit could result in a bid disqualification:</u></p>	
<p>a. The Michigan request for proposal (RFP) and bus specification forms completed in detail.</p>	<p>4 - Schedule A - Statement of Work 3 - Standard Contract Terms 5 – Schedule C – FTA Clauses Eldorado 6 - Schedule D - Affidavit for Driver Delivery 9 - Schedule F - COMPOSITE Equipment Checklist 7 - Schedule B – Small Bus Specifications AD2 10 - Schedule G – COMPOSITE - Pricing AD2</p>
<p>b. Bus floor plans indicating dimensions and showing the interior layout of the bus. The plan shall include wheelchair placement, stanchion locations, engineering calculated loaded bus axle weights, and be drawn to scale for all configurations.</p>	<p>B - Eldo Class 1 Floorplans and Weights B - Eldo Class 2 Floorplans and Weights</p>
<p>c. Detailed engineering drawing for the design of the entrance door and door-opening device.</p>	<p>C – Door Eldorado Class 1 C – Door Eldorado Class 2</p>
<p>d. Detailed engineering drawing for the design of the entrance step configuration.</p>	<p>D - Stepwell Drawing Eldorado</p>
<p>e. Roof, sidewall, and flooring drawings showing structure and structural specifications indicating metal size and type used. Include side sheathing and inside panels.</p>	<p>E - Roof Sidewall Floor Eldorado</p>
<p>f. Manufacturer's chassis description (specifications).</p>	<p>F - Ford Chassis Specs Class 1 F - Ford Chassis Specs Class 2</p>
<p>g. Detailed engineering drawings of the body to chassis frame mounting.</p>	<p>G - Body Mounting Eldorado</p>
<p>h. All bidders must supply manufacturer's technical specifications for wheelchair lifts and wheelchair restraints. Manufacturer's sales literature is acceptable if it contains the technical specifications.</p>	<p>H – Lift and Restraint Specifications</p>
<p>i. The warranties for body, chassis, and drive train.</p>	<p>I – Warranties Eldorado</p>
<p>j. If applicable, as required by Title 49 of the CFR, Part 663 – Subpart D, a copy of the manufacturer's self-certification information concerning the bus's compliance with relevant Federal Motor Vehicle Safety Standards (pre-award)</p>	<p>J - FMVSS Certifications Eldorado</p>

k. A copy of the Bus Rollover Protection Test (FMVSS 220) results of the bus offered as specified in the bid.	K - FMVSS 220 Eldorado
l. Completed Schedule C – Federally Required Contract Clauses shall be attached to bid quotation.	5 - Schedule C - FTA Clauses - Eldorado
m. Buy America analysis of manufacturer's list of component and subcomponent parts (pre-award).	M - PREBUYAMERICA_Eldorado
n. The technical data sheet including flammability and smoke emissions for the seat covering material supplied.	N - Seat Material Flamability
o. Seat frame Salt Spray, humidity and impact resistance tests' results	O - Salt Seats YN208Q_Interpon A2000
p. Certification test data showing that the seats, the seat belts, and the installation are in compliance with FMVSS-207, 208, 209, and 210 where applicable for the bus model being offered in this bid.	P - Seat Belt Certs
q. Technical data sheet for the seat cushion foam supplied.	Q - Seat Foam
r. Certification that the wiring and the switches for air conditioning and all add-on components are adequate to withstand transient loads expected.	R - Composite WiringSwitch
s. Proof of valid motor vehicle dealer licensing from state, county, or municipality.	S - Dealer License Michigan
t. A copy of the dealer agreement between the Bus Manufacturer and the designated bidder.	T - Dealer Agreement Eldorado
u. Certification that the bus model offered is a 5 year or 150,000 mile (small class one) or 7 years/200,000 mile (small class two) bus and will meet the requirements of Federal Register Rules and Regulations 49 CFR Part 665, Bus Testing Program. Stating from § 665.13 Test Report and Manufacturer Certification, Section (b)(1), "A manufacturer of a new bus model or a bus produced with a major change in component or configuration shall provide a copy of the test report to a recipient during the point in the procurement process specified by the recipient".	U - Altoona Propane ROUSH U - Altoona AeroLite U - Altoona AeroTech Family Altoona U - Altoona CNG System U - ICOM Bi-Fuel Altoona report U - Altoona Ford 7.3L Engine
v. Certification for 480-hour salt spray test per ASTM procedure B-117.	VWX - Composite Salt Spray Tests VWX - Salt Spray 1000 hour Eldorado
w. Certification for 1,000-hour salt spray test per ASTM procedure B-117.	VWX - Composite Salt Spray Tests VWX - Salt Spray 1000 hour Eldorado
x. 480 hour ASTM D2247 Humidity Resistance test.	VWX - Salt Spray Test
y. FULL Altoona Test Report.	U - Altoona Propane ROUSH U - Altoona AeroLite U - Altoona AeroTech Family Altoona U - Altoona CNG System U - ICOM Bi-Fuel Altoona report U - Altoona Ford 7.3L Engine
z. Schedule D - Affidavit for Driver Delivery	Schedule D - Affidavit for Driver Delivery

TABLE 1

54254

Federal Register / Vol. 58, No. 201 / Wednesday, October 20, 1993 / Notices

1. Materials tested for surface flammability should not exhibit any flaming running, or flaming dripping.

2. The surface flammability and smoke emission characteristics of seat cushion materials should be demonstrated to be permanent after testing according to ASTM D-3574 Dynamic Fatigue Tests I_s (Procedure B).

3. The surface flammability and smoke emission characteristics of a material should be demonstrated to be permanent by washing, if appropriate, according to FED-STD-191A Textile Test Method 5830.

4. The surface flammability and smoke emission characteristics of a material should be demonstrated to be permanent by dry cleaning, if appropriate, according to ASTM D-2724. Materials that cannot be washed or dry-cleaned should be so labeled, and should meet the applicable performance criteria after being cleaned as recommended by the manufacturer.

5. ASTM E-662 maximum test limits for smoke emission (specific optical density) should be measured in either the flaming or non-flaming mode, depending on which mode generates more smoke.

6. Flooring and Fire Wall assemblies should meet the performance criteria during a nominal test period determined by the transit property. The nominal test period should be twice the maximum expected period of time, under normal circumstances, for a vehicle to come to a complete, safe stop from maximum speed, plus the time necessary to evacuate all passengers from a vehicle to a safe area. The nominal test period should not be less than 15 minutes. Only one specimen need be tested. A proportional reduction may be made in dimensions of the specimen provided that it represents a true test of its ability to perform as a barrier against vehicle fires. Penetrations (ducts, piping, etc.) should be designed against acting as conduits for fire and smoke.

7. Carpeting should be tested in accordance with ASTM E-648 with its padding, if the padding is used in actual installation.

8. Arm rests, if foamed plastic, are tested as cushions.

9. Testing is performed without upholstery.

Definition of Terms

1. Flame spread index (I_s) as defined in ASTM E-162 is a factor derived from the rate of progress of the flame front (F) and the rate of heat liberation by the material under test (Q), such that $I_s = F \times Q$.

2. Specific optical density (D_s) is the optical density measured over unit path length within a chamber of unit volume produced from a specimen of unit surface area, that is irradiated by a heat flux of 2.5 watts/cm² for a specified period of time.

3. Surface flammability denotes the rate at which flames will travel along surfaces.

4. Flaming running denotes continuous flaming material leaving the site of the burning material at its installed location.

5. Flaming dripping denotes periodic dripping of flaming material from the site of burning material at its installed location.

Referenced Fire Standards

The source of test procedures listed in Table 1 is as follows:

(1) Leaching Resistance of Cloth, FED-STD-191A-Textile Test Method 5830.

Availability from: General Services Administration Specifications Division,

Building 197, Washington, Navy Yard, Washington, DC 20407.

(2) Federal Aviation Administration Vertical Burn Test, FAR-25-853.

Available from: Superintendent of Documents, US Government Printing Office, Washington, DC 20402.

(3) American Society for Testing Materials (ASTM)

(a) Surface Flammability of Materials Using a Radiant Heat Energy Source, ASTM E-162;

(b) Surface Flammability for Flexible Cellular Materials Using a Radiant Heat Energy Source, ASTM D-3675;

(c) Fire Tests of Building Construction and Materials, ASTM E-119;

(d) Specific Optical Density of Smoke Generated by Solid Materials, ASTM E-662;

(e) Bonded and Laminated Apparel Fabrics, ASTM D-2724;

(f) Flexible Cellular Materials—Slab, Bonded, and Molded Urethane Foams, ASTM D-3574.

Available from: American Society for Testing and Materials, 1916 Race Street, Philadelphia, PA 19103.

In all instances, the most recent issue of the document or the revision in effect at the time of request should be employed in the evaluation of the material specified herein.

Issued: October 14, 1993.

Grace Crumican,

Deputy Administrator.

[FR Doc. 93-25709 Filed 10-19-93; 8:45 am]

BILLING CODE 4810-57-P

IX. TABLE 1

TABLE 1: RECOMMENDATIONS FOR TESTING THE FLAMMABILITY AND SMOKE EMISSION CHARACTERISTICS OF TRANSIT BUS AND VAN MATERIALS

Category	Function of Material	Test Procedure	Performance Criteria
Seating	Cushion ^{1;2;3;5;9*}	ASTM D-3675	$I_p \leq 25$
		ASTM E-662	$D_p(1.5) \leq 100; D_p(4.0) \leq 200$
	Frame ^{1;5;8}	ASTM E-162	$I_p \leq 35$
		ASTM E-662	$D_p(1.5) \leq 100; D_p(4.0) \leq 200$
	Shroud ^{1;5}	ASTM E-162	$I_p \leq 35$
		ASTM E-662	$D_p(1.5) \leq 100; D_p(4.0) \leq 200$
Upholstery ^{1;3;4;5}	FAR 25.853 (Vertical)	Flame time ≤ 10 seconds; burn length ≤ 6 inches	
	ASTM E-662	$D_p(4.0) \leq 250$ coated; $D_p(4.0) \leq 100$ uncoated	
Panels	Wall ^{1;5}	ASTM E-162	$I_p \leq 35$
		ASTM E-662	$D_p(1.5) \leq 100; D_p(4.0) \leq 200$
	Ceiling ^{1;5}	ASTM E-162	$I_p \leq 35$
		ASTM E-662	$D_p(1.5) \leq 100; D_p(4.0) \leq 200$
	Partition ^{1;5}	ASTM E-162	$I_p \leq 35$
		ASTM E-662	$D_p(1.5) \leq 100; D_p(4.0) \leq 200$
	Windscreen ^{1;5}	ASTM E-162	$I_p \leq 35$
		ASTM E-662	$D_p(1.5) \leq 100; D_p(4.0) \leq 200$
	HVAC Ducting ^{1;5}	ASTM E-162	$I_p \leq 35$
		ASTM E-662	$D_p(4.0) \leq 100$
Light Diffuser ⁵	ASTM E-162	$I_p \leq 100$	
	ASTM E-662	$D_p(1.5) \leq 100; D_p(4.0) \leq 200$	
Flooring	Wheel Well and Structural ⁶	ASTM E-119	Pass
	Carpeting ⁷	ASTM E-648	C.R.F. ≥ 0.5 w/cm ²
Insulation	Thermal ^{1;3;5}	ASTM E-162	$I_p \leq 25$
		ASTM E-662	$D_p(4.0) \leq 100$
	Acoustic ^{1;3;5}	ASTM E-162	$I_p \leq 25$
		ASTM E-662	$D_p(4.0) \leq 100$
Miscellaneous	Firewall ⁶	ASTM E-119	Pass
	Exterior Shell ^{1;5}	ASTM E-162	$I_p \leq 35$
		ASTM E-662	$D_p(1.5) \leq 100; D_p(4.0) \leq 200$

* Refers to Notes on Table 1

X. BUS SEATING ARRANGEMENTS

Standard non-lift buses and lift buses shall be supplied as requested in the following seating arrangements:

Class 1 (138" minimum):

- A.** 10 passenger without lift
 - i. 3 standard double forward facing seats
 - ii. 4 single forward facing seats
 - iii. 1 co-pilot seat (OEM)

- B.** 4 + 2 passenger with lift
 - i. 1 standard double forward facing seats
 - ii. 2 single forward facing seats
 - iii. 1 co-pilot seat (OEM)
 - iv. 2 wheelchair positions
 - v. 3 double fold-away seats

- C.** 11 passenger without lift
 - i. 3 standard double forward facing seats
 - ii. 5 single forward facing seats

- D.** 5 + 2 passenger with lift
 - i. 1 standard double forward facing seats
 - ii. 3 single aisle facing fold-away seats
 - iii. 2 wheelchair positions
 - iv. 3 double fold-away seats

Class 2 (158" minimum):

- E.** 18 passenger without lift
 - i. 9 standard double forward facing seats

- F.** 10 + 1 passenger with lift
 - i. 5 standard double forward facing seats
 - ii. 1 wheelchair positions
 - iii. 2 double fold-away seats

- G.** 8 + 2 passenger with lift
 - i. 3 standard double forward facing seats
 - ii. 2 wheelchair positions
 - iii. 2 double fold-away seats
 - iv. 1 double aisle facing fold-away seat

- H.** 4 + 2 passenger with lift
 - i. 2 standard double forward facing seats
 - ii. 2 wheelchair positions
 - iii. 6 double fold-away seats

- I.** 22 passenger without lift

- i. 11 standard double forward facing seats
- J. 6 + 2 passenger with lift**
 - i. 3 standard double forward facing seats
 - ii. 2 wheelchair positions
 - iii. 5 double fold-away seats
- K. 10 + 2 passenger with lift**
 - i. 5 standard double forward facing seats
 - ii. 2 wheelchair positions
 - iii. 2 double fold-away seats
- L. 4 + 2 passenger with lift**
 - i. 2 standard double forward facing seats
 - ii. 2 wheelchair positions
 - iii. 7 double fold-away seats

Drawings for the suggested seating arrangements are supplied on the following pages.

Bus Floor Plans

Class 1

Wheelbase 138" Minimum

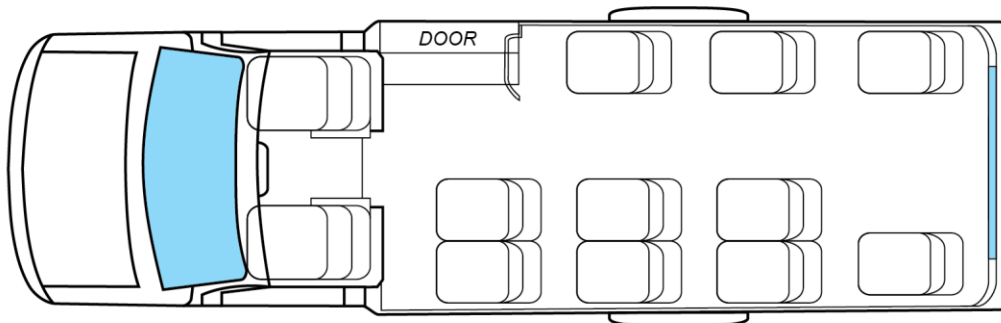

10 Passenger Bus without Lift

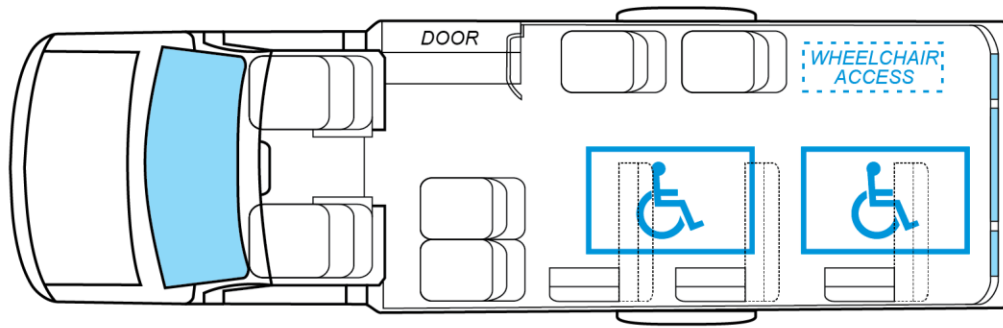

4 + 2 Passenger Bus with Lift

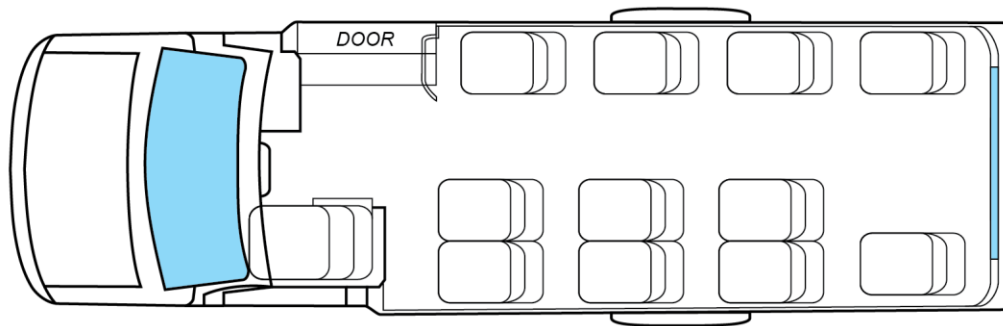

11 Passenger Bus without Lift

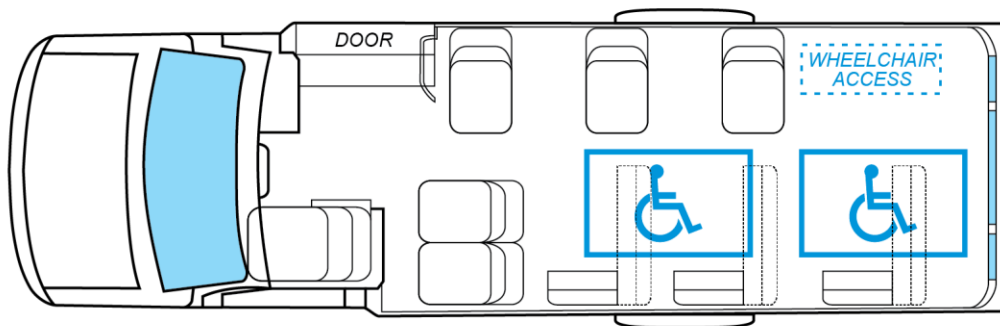

5 + 2 Passenger Bus with Lift

Class 2
Wheelbase 158" Minimum

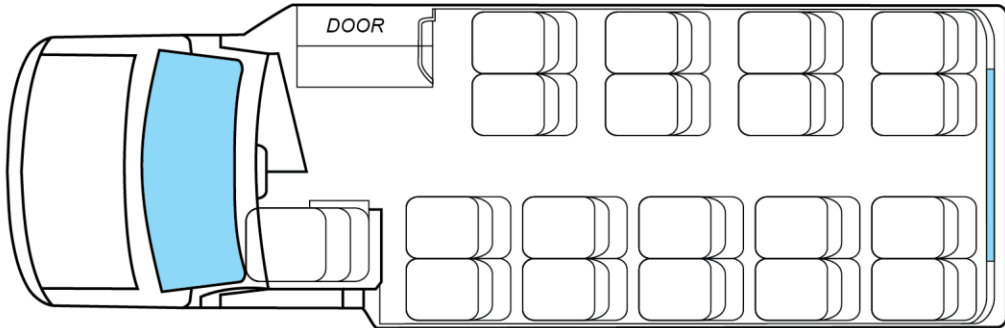

18 Passenger Bus without Lift

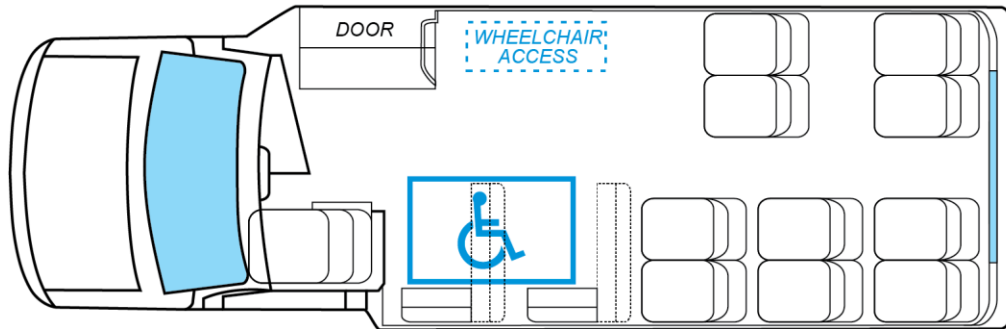

10 + 1 Passenger Bus with Lift

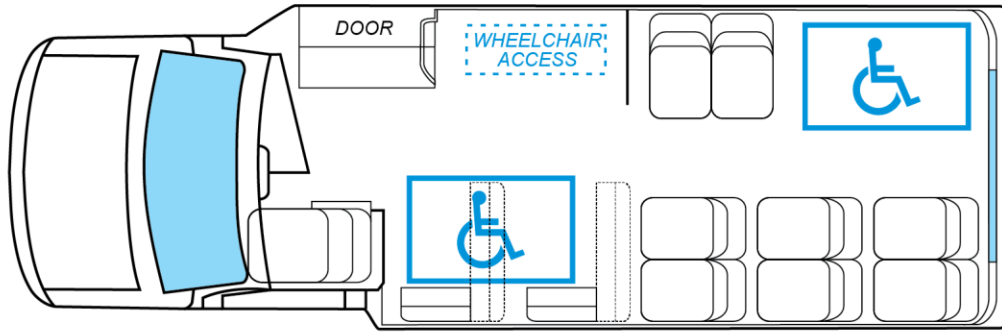

8 + 2 Passenger Bus with Lift

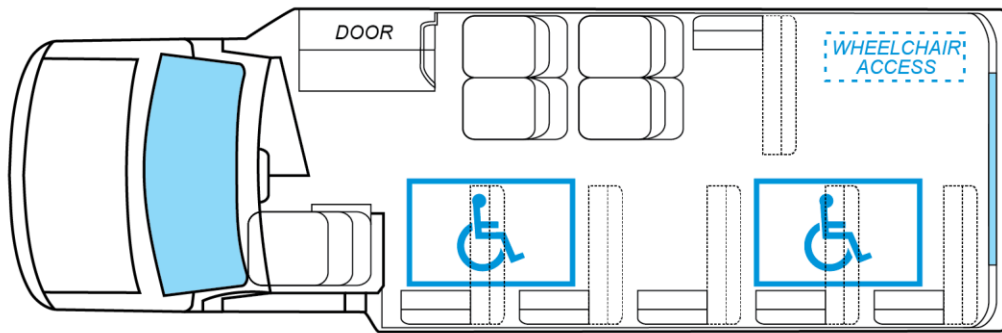

4 + 2 Passenger Bus with Lift

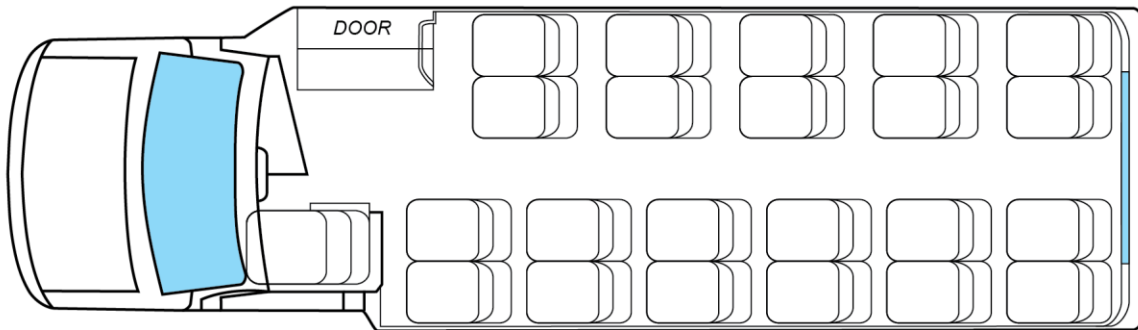

22 Passenger Bus without Lift

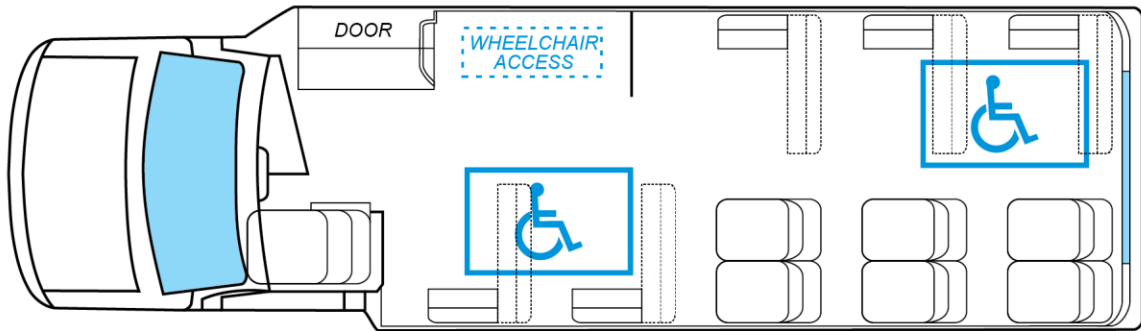

6 + 2 Passenger Bus with Lift

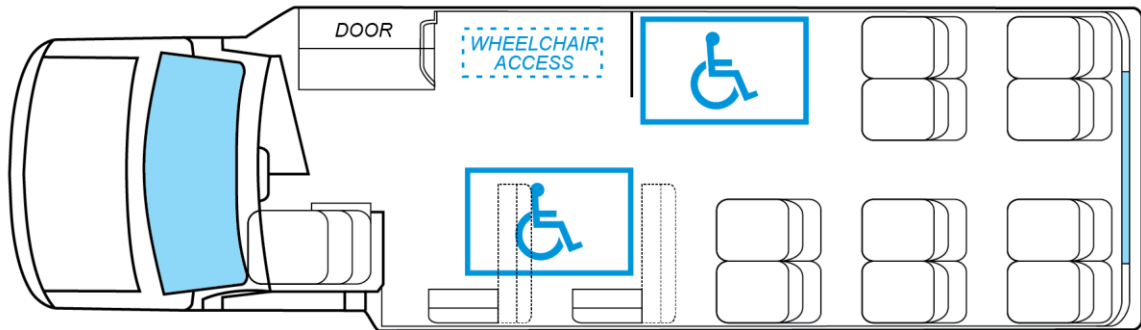

10 + 2 Passenger Bus with Lift

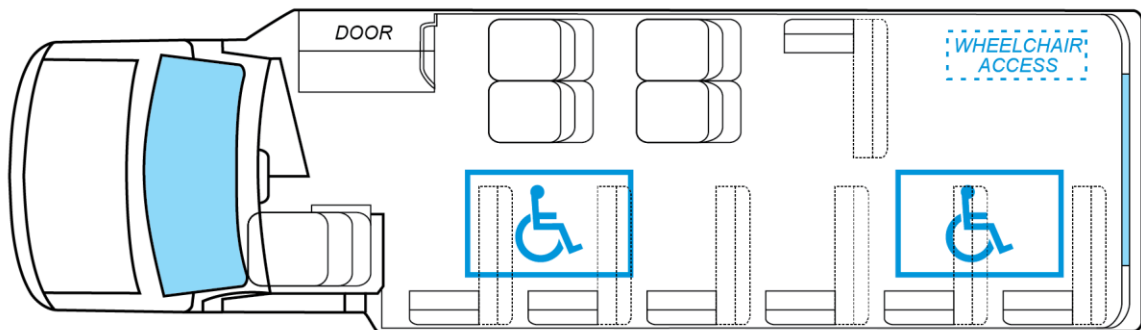

4 + 2 Passenger Bus with Lift

This specification was developed as a cooperative effort between the Michigan Department of Transportation and a committee of representatives from various Michigan public transit agencies. Upon request, this specification can be obtained in alternative format such as braille, large print, or audio tape.

STATE OF MICHIGAN

Contract No. 210000000606

**Schedule B
State of Michigan
Office of Passenger Transportation
Specifications for
Small Class of Buses, Class I - 5 Years/150,000 Miles (minimum); Class II - 7-Years/200,000 Miles (minimum)
of Non-lift and Lift Transit Buses with Alternate Seating**

I. PURPOSE OF SPECIFICATIONS

These specifications are setting forth the minimum requirements for a two-axle, transit class commercial non-lift bus or a Paratransit type commercial bus equipped with a commercial wheelchair lift. The body shall be mounted on a commercial or recreational vehicle (RV) chassis. At a minimum, buses must meet all applicable Michigan Motor Carrier Vehicle Codes, all applicable Federal Motor Vehicle Safety Standards (FMVSS), and the Americans with Disabilities Act (ADA).

Buses in these specifications shall be defined by the following classes:

- A. Small Class One: Minimum 11,500 GVWR
- B. Small Class Two: Minimum 14,200 GVWR

The Small Class of buses must be capable of seating a minimum of 11 adult forward facing passengers or an alternate capacity of ambulatory adult passengers and wheelchair passengers. The buses shall be fully and/or partially tested (a related full report shall be submitted with any partial test for each fuel type, Gasoline, and Propane) at the Penn State/Thomas D. Larson Pennsylvania Transportation Institute – the Altoona Bus Research and Testing Center and must certify the following with a copy of the "Altoona Bus Test Report":

- A. The bus model(s) offered is a minimum Class One - 5 years/150,000, Class Two – 7 years/200,000 mile bus service life category.
- B. Will meet the requirements of Federal Register Rules and Regulations 49 CFR Part 665, Bus Testing Program.
- C. Testing is required for a manufacturer of a new bus model or a bus produced with a major change in component or configuration shall provide a copy of the test report(s) as specified in §665.11 and § 665.13.
- D. Bidders shall submit any and all reports related to the buses in this bid as specified in §665.11 and § 665.13

Chassis serial number, body number, axle ratio, gross vehicle weight rating (GVWR), seating capacity and paint codes shall be imprinted on a permanent decal(s) or stamped on a metal plate(s) and affixed in the driver's area of the bus (location to be approved by the State).

Regardless of options and seating plan ordered, the successful bidder shall be responsible for certifying that all buses delivered: 1) shall not exceed the GVWR of chassis as bid (determined by engineering calculated loaded vehicle axle weights), and 2) single wheelchair securement area buses shall not exceed 21' 11" in length measured bumper to bumper excluding the energy absorbing portion of the bumper (distance of travel allowed for compression of the bumper without body deformation). Manufacturers shall comply with the chassis company's quality vehicle manufacturing program such as Ford's Quality Vehicle Modifier (QVM).

A. Please refer to Schedule A Statement of Work, section 1.1, A. thru J. for additional specification requirements.

II. BODY SPECIFICATIONS

A. GENERAL DESIGN AND CONSTRUCTION

INSTRUCTIONS: Where applicable, Bidder should specify either suggested source or pre-approved alternate and/or provide detail for all items.

Specification Requirement	Suggested Source or Pre-Approved Alternate
1) SAFETY: The chassis and body shall be designed using only prudent, proven engineering principles with all work performed only by professional established firms. The bus purchased shall comply with all State regulations and requirements applicable to the design and manufacture of motor buses for the State of Michigan.	Complies with Specification - understand that the buses provided must comply with all State regulations and requirements applicable to the design and manufacture of buses for the State of Michigan

<p>2) DRIVER SIZE and COMFORT: Design criteria of bus purchased shall be for all females from the 5th percentile, to males of the 95th percentile, to be equally as comfortable in using all controls required to safely drive and maneuver the bus. All driver controls shall comply with FMVSS 101, with hand and foot controls required to operate the bus safely, including the placement of exterior adjustable mirrors, positioned to meet this safety requirement.</p>	<p>Complies with specification - understand that the buses provided must provide driver comfort and convenience and meet all applicable FMVSS standards.</p>
<p>3) QUALITY of WORKMANSHIP: All labor employed in both the manufacturing and assembly processes of the bus purchased shall be to the highest industry standards. The entire bus shall be within all established engineering tolerances set by all parties involved in the design and production of the bus. All added components shall be installed and positioned according to the component manufacturer's installation procedures which shall be available upon request.</p>	<p>Complies - will provide buses built to all Federal and State guidelines using Lien 5S production, ISO 9001 and Ford QVM guidelines.</p>
<p>4) WELDING: All welding procedures used throughout the construction of the bus, including materials, qualifications and training of personnel, shall be in accordance with the standards of the American Society for Testing and Materials (ASTM) and the American Welding Society (AWS). Contact surfaces of all material to be welded shall be clean, and free of grease, paint, rust and scale. After welding, all rough edges and surfaces on parts shall be ground smooth and coated with a corrosion inhibiting primer and paint.</p>	<p>Only certified welders that weld to standards outlined here will be used.</p>
<p>5) ATTACHMENT HARDWARE: All rivets, screws, bolts, nuts, washers and other types of fasteners used in the construction process, including those that would be exposed to the elements, shall be of appropriate size and strength rating for the application. They shall be sprayed with or dipped in a rust-resistant coating material, be plated, be stainless steel, or otherwise be made of rust-resistant type material, all of which will pass the 480 hour ASTM B117 Salt Spray test and the 480 hour ASTM D2247 Humidity Resistance test (see section C. Vendor/Manufacturer Requirements, subsection 8. Bid Documents, items v. & x.). Fasteners used by the respective component manufacturers in their assemblies are acceptable as part of the assembly.</p>	<p>Hardware meeting this requirement shall be used.</p>
<p>B. BODY STRUCTURE AND EXTERIOR PANELS</p>	
<p>1) Metal Rollover Frame, Cage-type Construction</p>	
<p>a. The bus shall have a heavy-duty, unit-body structure type. The body structure (rollover frame, cage type of gauge #16 steel, 0.060" or equal, minimum) shall be of durable steel or aluminum construction insulated against electrolysis between dissimilar metals, and adequately reinforced at all joints and points of stress, with sufficient strength to comply with the FMVSS 220 rollover protection test. All body and floor structural members (tubes, channels, etc.) shall be Gas Metal Arc Welded (GMAC) or equal at each joint. A MIG welding system is acceptable provided it meets the requirements of this specification. Each bidder shall provide certification with the bid, that the bus meets the FMVSS 220 rollover protection test as bid (see section C. Vendor/Manufacturer Requirements, subsection 8. Bid Documents, item k.).</p>	<p>We are bidding a bus with a metal rollover frame, cage type construction that meets this specification. We can even meet FMVSS 220 with no windows installed.</p>

BODY S

<p>b. The bus shall be designed to withstand road shocks, stop, and start operations, seasonal weather and road extremes, and other conditions found in Michigan transit bus service. The body shall be securely fastened to the chassis frame structure using a method of uniform attachment consisting of strategically placed rubber isolators/cushions <u>consistent with cab/chassis isolators/cushions</u> with connector bolts that permit body flexing independent of chassis flexing. Roof, side, front, and back panels shall be secured to the body vertical and horizontal frame members, and these, when fastened to the floor structural members, result in a permanent, fully-integrated structural unit adequately reinforced at all points where stress concentration may occur. The wall structure shall be welded or bolted to the floor with grade 8 bolts to provide adequate stability in the event of a non-static rollover event. The body floor sub-frame assembly, including lower skirt reinforcements, shall be, at a minimum, gauge number 14 (.075" thickness) galvanized steel (mill applied), or gauge number 16 stainless steel, or gauge number 12 aluminum, or gauge number 14 steel treated with a corrosion resistant coating. All body floor sub-frame assembly shall meet the 480 hour salt spray test per ASTM procedure B-117, with no structural detrimental effects to normally visible surfaces. Certification of compliance with this requirement shall be published by an independent company and be submitted with the bid (see section C. Vendor/Manufacturer Requirements, subsection 8. Bid Documents, item v.). Wheelwells shall have minimum yield strength of gauge number 14 (.075" thickness) galvanized steel, gauge number 16 (.060" thickness) stainless steel, or gauge number 12 (.10" thickness) aluminum properly welded or secured with approved corrosion resistant fasteners to the floor structure. The entire body cage and frame including floor structure shall be properly coated with a corrosion resistant coating or a non-water permeable primer/paint. All components treated to resist corrosion shall be properly cleaned to remove greases, oils, and residues before application of the corrosion resistant material. Passage holes provided for wiring and hoses shall be thoroughly sealed to prevent dust and moisture intrusion and be sufficiently protected to ensure against wear from friction and the elements. When completed, all body side sections and roof sections including structure shall be at a minimum 1-1/4" thick. Where body segments are joined they shall be properly sealed to prevent intrusion of drafts, fumes, dust, and water to the interior of the bus body. Roof shall allow no pooling of water.</p>	<p>We are bidding a bus with a metal rollover frame, cage type construction that meets this specification. It has been used by MI Agencies for several years with great satisfaction.</p>
<p>c. All exterior side and roof panel material shall be fiberglass reinforced plastic (FRP), it shall have as a minimum, of 2.16 mm (0.080") thick material (comprised of various layers of gel-coat, reinforcement and resins) or .040" FRP with a 2.7mm (.106") Azdel backer. It shall be designed to resist impact caused by flying road debris. The material must resist rot, corrosion, and mildew and cannot be affected by cleaning related chemicals, road residue, or environmental exposure. Reinforcements shall be installed around all window openings in order to transfer stress around the opening. All door openings shall have full structural framing (tube) or imbedded reinforcements, equal to the structural members of the body that will</p>	<p>We are bidding a bus with exterior skin that meets this sections requirements.</p>

<p>adequately support concentrations of stress around openings. All exposed doorframe structure shall be made of 400 series stainless steel (including the fasteners), which does not discolor with age. Where a stiffener or a backer material (substrate) is used for the exterior panels, it shall be bonded with waterproof adhesive to the exterior panel; it shall be a water resistant material that will not wick water; and it must be thoroughly sealed from the elements when installed so that the substrate will not be exposed to or absorb moisture and cause corrosion to the interior of the panel or any body structure. Exterior panel substrate shall not be of wood composition, plywood or a pressed wood product. Where body segments are joined, they shall be properly sealed to prevent intrusion of drafts, fumes, dust, and water to the interior of the bus body.</p>	
<p>d. All interior panels and trim may be made of scuff-resistant laminate/FRP or molded ABS finished material. Interior panels shall have as a minimum the physical properties of gauge number 24 (.024" thickness). Interior panel substrate shall not be of wood composition, plywood or a pressed wood product. Interior panel threaded fasteners or rivets shall secure panels to body framing structure. Where fasteners are in the panels only, a reinforcing nut or reinforcing panel shall be installed for added strength and fastener retention. Overhead compartment and fuse panel covers/doors only shall be made of the same material as interior panels or may be padded with plywood backers. Panels must allow for permanent adhesion of signage.</p>	<p>We are bidding a bus with inside wall construction that meets this sections requirements.</p>
<p>e. Exterior lower skirt panels shall be fiberglass or composite material and shall be sufficiently stiff to prevent vibration, drumming, or flexing while the bus is in service. Lower edge of skirt panels shall be re-enforced to prevent cracking/breaking due to excessive flexing. Body front and/or rear endcaps may be molded fiberglass panels installed with required structural framing or a FRP composite structure. Lower skirt panels may be one piece in length at manufacture but shall be repairable in sections. Lower skirt panels shall not use a wood substrate material for a panel stiffener. Where exterior panels are lapped, the upper or forward panels shall act as a watershed. Exterior panels that are cut shall have the cut edge sealed (paint or special sealing compound). Sealing and fastening of panel joints, including front and rear cap-to-body joints, shall prevent entrance of moisture and dirt. Joint sealing shall be made through use of a non-shrinking bonding sealant, and joint sealing shall not be solely dependent on an exterior trim strip or a trim cap nor shall the sealing of the panels be dependent on caulking alone. Any visible caulk shall be painted after water testing is complete. All exterior panels shall be buck riveted and/or bonded to the body frame structure.</p>	<p>We are bidding a bus with lower skirts meeting this sections requirements.</p>
<p>f. The exterior body panels shall have on each side one heavy-duty rubrail. Rubrails (1½" x ½" minimum) shall be extruded UV resistant plastic with a flexible, rubber-type resilient material insert or a solid rubber-type of flexible, resilient material. Rubrails shall be located no less than 25" nor more than 43" above the ground on each side. Where the rubrails and fender opening guards are not an integral part of the body, installation of rubrails shall be made after the finish coat of paint is applied to the bus.</p>	<p>We are bidding a bus with rubrails installed that will meet this sections requirements.</p>

<p>Rubrails shall be sealed to prevent debris seepage into and from behind rubrail.</p>	
<p>g. Gun installed huckbolt fastenings, buck rivets, bonding adhesives, or approved equivalent shall be utilized on all exterior body panels, rubrails, and all other locations where stress is concentrated. All rivets, screws, bolts, nuts, washers, clamps, and other types of fasteners used in the construction process, including those that would be exposed to the elements, on the exterior and interior of the unit shall be properly plated to resist corrosion. <u>No sheet metal screws shall be permitted, including self-tapping/drilling screws.</u> except for rubrails and rubber fender splash guards (see mudflaps/splash guards) which can be secured with stainless steel or equivalent plated locking-type, self-tapping fasteners. Fastener materials shall be compatible with materials being fastened. Where self-tapping fasteners are used, body panels shall be reinforced with steel backing, aluminum backing, or stainless-steel backing.</p>	<p>We are bidding a bus with construction meeting this sections requirements.</p>
<p>h. Window openings cut into body panels shall have a maximum frame clearance of 3/16" on each side to minimize the need for caulking (see Section 24, Windows). All openings cut into metal body exterior panels must have the exposed cut edges primed or properly coated to inhibit water intrusion and corrosion before further assembly or painting occurs. Window frames installed in the body openings shall be properly caulked/sealed to prevent intrusion of moisture and dust. Drip rails shall be installed the entire length of the bus body above windows and doors.</p>	<p>We are bidding a bus with windows installed meeting this sections requirements.</p>
<p>i. The Contractor shall submit roof, sidewall, and flooring drawings showing structure and structural specifications indicating metal size and type used. Include side sheathing and inside panels (see section C. Vendor/Manufacturer Requirements, subsection 8. Bid Documents, items e.).</p>	<p>Drawings are attached.</p>
<p>2) Fiberglass Reinforced Plastic (FRP) Composite Unitized-type Body</p>	
<p>a. The bus body shall have a heavy-duty unitized structure and shall be of durable fiberglass reinforced plastic (FRP) composite construction. The body panels shall consist of an exterior high gloss gelcoat (.020" thickness, minimum) on a resin-hardened FRP (3/16"thickness, minimum) attached to a center layer of resin hardened Nida-Core® or equal honeycomb (¾" thickness, minimum) with an inner FRP panel (3/16" thickness, minimum); or may be ¾"polyurethane foam insulation gelcoated to ¼" FRP exterior with ¼" FRP interior, reinforced with steel perimeter and transverse supports, completely fiberglassed to adjoining body parts. It shall use proper adhesive materials to adequately bond and mechanically fasten all joints and points of stress with sufficient strength to comply with the FMVSS 220 rollover protection test. Each bidder shall provide certification with the bid, that the bus meets the FMVSS 220 rollover protection test as bid (see section C. Vendor/Manufacturer Requirements, subsection 8. Bid Documents, item k.).</p>	<p>See Schedule B – COMPOSITE – Small Bus Specifications AD2</p>
<p>b. The bus shall be designed to withstand road shocks, stop and start operations, seasonal weather and road extremes, and other conditions found in Michigan transit bus service. The body shall be securely fastened to the chassis frame</p>	<p>See Schedule B – COMPOSITE – Small Bus Specifications AD2</p>

<p>structure using a method of uniform attachment consisting of strategically placed rubber isolators/cushions <u>consistent with cab/chassis isolators/cushions</u> with connector bolts that permit body flexing independent of chassis flexing. Roof, side, front, and back panels shall be secured to the floor and lower body frame members; all of which shall result in a permanent, fully-integrated structural unit adequately reinforced at all points where stress concentration may occur. The body floor sub-frame assembly, including lower skirt reinforcements, shall be, at a minimum, gauge number 14 (.075" thickness) galvanized steel (mill applied), or gauge number 16 stainless steel, or gauge number 12 aluminum, or gauge number 14 steel treated with a corrosion resistant coating, insulated against electrolysis between dissimilar metals. All body floor sub-frame assembly shall meet 1,000-hour salt spray test per ASTM procedure B-117, with no structural detrimental effects to normally visible (see section C. Vendor/Manufacturer Requirements, subsection 8. Bid Documents, item w.). Certification of compliance with this requirement shall be published by an independent company and be submitted with the bid. Wheelwells shall have minimum yield strength of gauge number 14 galvanized steel, gauge number 16 (.060" thickness) stainless steel, or gauge number 12 (.10" thickness) aluminum properly welded or secured with approved corrosion resistant fasteners to the floor structure. Passage holes provided for wiring and hoses shall be thoroughly sealed to prevent dust and moisture intrusion. The entire lower body frame shall be coated with corrosion resistant primer/paint (steel) or properly treated to resist corrosion (other materials). All treated components shall be properly cleaned to remove greases, oils, and residues before application of the corrosion resistant material.</p>	
<p>c. All exterior side and roof panels when completed shall be at a minimum 1-1/8" thick. Bond lines at the sidewalls, rear endcap, roof, and front cap shall be interlocked by adhesives, resin saturated fiberglass matting, and mechanical fasteners, forming a unibody design without exposed fasteners or protruding moldings. Imbedded reinforcements shall be installed at all door openings to support door mounting hardware and door operating mechanisms. All door openings shall have full structural metal framing to maintain integrity of the body structure. All exposed doorframe structure shall be made of 400 series stainless steel (including the fasteners), which does not discolor with age. Where a stiffener or a backer material (substrate) is used for the exterior panels, it shall be bonded with waterproof adhesive to the exterior panel; it shall be a water resistant material that will not wick water; and it must be thoroughly sealed from the elements when installed so that the substrate will not be exposed to or absorb moisture and cause corrosion to the interior of the panel or any body structure. Roof shall allow no pooling of water.</p>	<p>See Schedule B – COMPOSITE – Small Bus Specifications AD2</p>
<p>d. Interior panels may be an integral part of the FRP composite panel or may be made of scuff-resistant laminate/FRP finished material. Where threaded fasteners are in the interior panel only, an imbedded reinforcing nut or a reinforcing panel shall be integrated into the FRP composite for added strength and fastener retention.</p>	<p>See Schedule B – COMPOSITE – Small Bus Specifications AD2</p>

<p>Overhead compartment and fuse panel covers/doors only shall be made of the same material as interior panels or may be padded with plywood backers. Panels must allow for permanent adhesion of signage.</p>	
<p>e. Exterior panels may be an integral part of the FRP composite panel. Exterior panels shall be sufficiently stiff to prevent vibration, drumming, or flexing while the bus is in service. Lower skirt panels shall be sufficiently fastened and braced to prevent damage from ice and snow build-up. Lower skirt panels may be one piece in length at manufacture but shall be repairable in sections. Where panels are lapped, the upper and/or forward panels shall overlap the lower and/or rearward panels to prevent intrusion of water under the panels. Sealing and fastening of joints, including front and rear cap-to-body joints, shall prevent entrance of moisture and dirt. Any visible caulk shall be painted after water testing is complete. All exterior panels shall be bonded to the lower body frame. In no case shall the sealing of the panels be dependent on caulking alone.</p>	<p>See Schedule B – COMPOSITE – Small Bus Specifications AD2</p>
<p>f. The exterior body panels shall have on each side one heavy-duty rubrail. Rubrails (1½" x ½" minimum) shall be extruded UV resistant plastic with a flexible, rubber-type resilient material insert or a solid rubber-type of flexible, resilient material. Rubrails shall be located no less than 25" nor more than 43" above the ground on each side. Where the rubrails are not an integral part of the body, installation of rubrails shall be made after the finish coat of paint is applied to the bus. Rubrails shall be sealed to prevent debris seepage into and from behind rubrail.</p>	<p>See Schedule B – COMPOSITE – Small Bus Specifications AD2</p>
<p>g. No sheet metal screws shall be permitted, including self-tapping/drilling screws, except for rubrails and rubber fender splash guards which can be secured with stainless steel locking-type, self-tapping fasteners. Fastener materials shall be compatible with materials being fastened and meet the 480 hour ASTM B117 Salt Spray test and the 480 hour ASTM D2247 Humidity Resistance test (see section C. Vendor/Manufacturer Requirements, subsection 8. Bid Documents, items v. & x.). Where self-tapping fasteners are used in body panels, the body panels shall have an imbedded reinforcing nut or a reinforcing panel shall be integrated into the FRP composite for added strength and fastener retention.</p>	<p>See Schedule B – COMPOSITE – Small Bus Specifications AD2</p>
<p>h. Window openings cut into body panels shall have a maximum frame clearance of 3/16" on each side, to minimize the need for caulking (see section B. Body Structure and Exterior Panels, subsection 24. Windows). All openings cut into body exterior panels must have the exposed edges of the cutout properly coated to prevent moisture intrusion before further assembly or painting occurs. Window frames installed in the body openings shall be properly caulked/sealed to prevent intrusion of moisture and dust. Drip rails shall be installed the entire length of the bus body above windows and doors.</p>	<p>See Schedule B – COMPOSITE – Small Bus Specifications AD2</p>
<p>i. The Contractor shall submit roof, sidewall, and flooring drawings showing structure and structural specifications indicating metal size and type used. Include side sheathing and inside panels (see section C.</p>	<p>See Schedule B – COMPOSITE – Small Bus Specifications AD2</p>

Vendor/Manufacturer Requirements, subsection 8. Bid Documents, items e.)	
3) Passenger Door	
<p>a. The manufacturer shall provide a heavy duty electrically operated passenger entrance door. The passenger entrance door shall be an anodized aluminum frame, split-type double leaf swing door. This door shall have a flexible soft rubber cushion on the meeting edge 1½" in width, minimum. The door glass shall be see-through, AS-2 tint (70% luminous transmittance) safety glass. Under all operating conditions and bus speeds, an airtight, watertight, and dust-proof seal shall be formed between the door and the stepwell, between the door and body opening, and between the door leaf sections. The door leading edge opening speed shall not exceed 18 inches per second and the closing speed shall not exceed 12 inches per second to provide a total door closing or opening in 2 to 4 seconds. The front passenger entrance door shall not extend below the step frame. The door shall be located on the right side of the bus near the front wheel. Any door with an exposed (metal showing) outer frame shall be made of 304 stainless steel (including the fasteners), which does not discolor with age. The entrance door shall provide a 30" clear width opening, minimum. Door opening height from the top of the first step to the door header shall be a minimum of 76". Where interior height is low at the entrance header, the header shall be padded to prevent injury to those exiting the bus. Suggest Source: A&M Systems Inc .</p>	Complies – A&M suggested source as specified
<p>b. The doorframe strength and electric door operator strength shall be designed to match the entrance door size. Door fasteners shall be anchored through a metal frame, NOT through a wood frame. The operator for the entrance door shall be located in an overhead compartment above the passenger entrance doorway; it shall be concealed from passengers, and shall be easily accessible for servicing through an access door. The electronic control module shall be located in a separate weatherproof enclosure to prevent water damage. The access door shall be hinged to open up with a holding device or shall be a complete access cover that is secured with ¼" threaded knobs (knobs shall match access cover). The access door or cover shall be as large as will fit in the overhead compartment space. Door motor operation shall be limited electrically to control door travel at full open and full closed positions and shall be adjustable to keep the door closed during bus operation. Physical or internal doorstops shall be used to prevent marring or damage to doors and/or surrounding parts. An entrance door manual release that allows disconnection and simple re-engagement of the door operator shall be provided so that the entrance doors can be manually opened in the event of loss of electrical power or other emergency. The door operator motor shall not run continuously when the manual release is operated. Electric door operator, door linkage, and baseplate components shall be of a single manufacturer. Suggested source: A&M Systems Inc., Excell, Vapor.</p>	Complies – A&M suggested source as specified
<p>c. The passenger door control switch shall be located in the driver's compartment within easy reach of the driver and be</p>	Complies with specification – switch to be RED

<p>clearly marked for "open" and "close" icons (switch shall operate the same on all buses). The control switch shall be powered by a constant battery feed circuit with circuit breaker protection. The control switch shall be "hold on" for operation and of a RED color different than the standard switch color.</p>	
<p>d. A method shall be provided to lock all entrances to the bus when it is not in use. Except for the OEM driver's door and ignition, all secondary door locks shall be keyed the same.</p>	<p>Complies with specification on all doors as required.</p>
<p>e. The Contractor shall submit detailed engineering drawing(s) for the design of the entrance door and door-opening device (see section C. Vendor/Manufacturer Requirements, subsection 8. Bid Documents, items c.).</p>	<p>See included drawings of entrance door as required. C - Door Champion.pdf</p>
<p>4) Passenger Stepwell</p>	
<p>a. All entrance steps and stepwells shall be gauge number 14 (.075" thickness) 400 series stainless steel, minimum. Steps and stepwells shall have adequate structural bracing. All metal trim hardware in the stepwell area shall be stainless steel. All fasteners in the stepwell area shall be stainless steel that will pass the 480 hour ASTM B117 Salt Spray test and the 480 hour ASTM D2247 Humidity Resistance test. Ground to first step shall not exceed 12" in height, each additional vertical step shall not exceed 9½" and all tread depths shall be 9" minimum. All steps in the entrance stepwell shall be of the same width. A suspension kneeling feature may be used to achieve the required 12" step height. Stepwells shall be covered with flooring material as described in section B. Body Structure and Exterior Panels, subsection 6. Flooring, item c. No aluminum step nosing shall be used. Any interior stainless steel except for exposed door frames shall be brushed, not painted.</p>	<p>Complies with specification – stainless steel steps. See D – Stepwell Drawing Champion As well as the VXW – Salt Spray documents included with this proposal.</p>
<p>b. The Contractor shall submit detailed engineering drawing(s) for the design of the entrance step configuration (see section C. Vendor/Manufacturer Requirements, subsection 8. Bid Documents, item d.).</p>	<p>Complies – see D – Stepwell Drawing Champion</p>
<p>5) Interior</p>	
<p>a. The interior of the bus shall provide a pleasant, aesthetically pleasing atmosphere. The door and driver instrument panel are to be painted or otherwise finished with a non-reflective, anti-glare finish that matches the overall interior tones of interior panels. All interior hinged access doors shall use quarter-turn, <u>non-corrosive</u> metal, thumb latches with positive stop mechanism (except the storage area in this section, item f., shall have one lockable latch) to hold the door positively closed. All interior markings shall be durable materials affixed to the interior panels' smooth surfaces or markings shall be durable materials affixed to metal plates fastened to the interior panels of the bus. The interior design and colors shall be approved by the State. No cloth shall be used for interior panels.</p>	<p>Complies with specification – Light Gray interior</p>
<p>b. All interior panels shall be made of laminate/FRP finished scuff-resistant materials. Overhead compartment and fuse panel covers/doors only shall be made of the same material as interior panels or may be padded with plywood backers. No cloth shall be used for interior panels. Panels must allow for permanent adhesion of signage.</p>	<p>Complies – light gray interior FRP</p>

<p>c. A white or light gray color shall be installed in the interior area above the seat rail lines, in the ceiling area, and on the rear endwall. All materials and treatments shall be easily cleaned. Panel fastening devices shall match color of panels. All interior finished surfaces shall be impervious to diesel fuel, gasoline, and commercial cleaning agents. Finished surfaces shall not be damaged by controlled applications of graffiti-removing chemicals.</p>	<p>Complies – light gray interior FRP</p>
<p>d. The interior height of the passenger compartment at center aisle shall be 76" minimum. At 6" from the sidewall there shall be 67" of interior height, minimum, with a gradual contour to the center aisle (no bulkheads). Interior headroom at the back of bus (rear air conditioning evaporator area) may be reduced to a minimum of 60", but it shall increase to the normal ceiling height at the front of the rear seat cushion. The interior width at seat line shall be 90", minimum. No cloth shall be used for interior panels.</p>	<p>Complies with approved equal of 75 (75 - 80" based on model/class)</p>
<p>e. <u>All surfaces, items, or hardware in the passenger compartment having sharp edges, corners, or angles that could cause injury, shall be padded with a heavy-duty, vinyl-covered, energy absorbing material to match interior colors and finish.</u> Areas inside the passenger compartment of low headroom where a person is prone to strike his head shall be marked and padded. All handrails shall have rounded edges where exposed.</p>	<p>Complies. Padded where specified.</p>
<p>f. A storage area with a hinged, lockable, access door shall be provided in the interior area either above the windshield (without destination sign) or on the side above the driver as space permits. This area above the windshield shall also be constructed to adequately support up to 60 pounds of two-way radio communication equipment. Storage area door shall open upward, be hinged at the top and have a clip/spring to retain the door in the open position. Storage area shall leave access to any lighting or other electrical connectors contained inside. Storage area shall be insulated and watertight.</p>	<p>Complies – Overhead storage included. Shelf included and insulated area allows for access to connectors.</p>
<p>6) Flooring</p>	
<p>a. The floor deck may be integral with the basic structure or mounted on the structure securely to prevent chafing or horizontal movement. All floor fasteners shall be corrosion resistant steel and shall remain secured and corrosion resistant for the service life of the bus. The floor deck shall be ¾" C/D plywood of marine grade material or ¾" fiberglass encased composite material, minimum, with sealed edges to prevent moisture intrusion. The floor deck upper surface shall have all cracks and voids filled and the whole surface rough sanded before installing the flooring material. A layer of sealer shall be installed between floor deck edges that butt against structural members and other deck sections to prevent dust and moisture intrusion. Passage holes provided for wiring and hoses in the floor deck shall be thoroughly sealed to prevent dust and moisture intrusion. Passenger seating floor rail/track shall not be installed in the wheelchair lift or wheelchair securement areas. The floor deck, including the sealer, attachments, and coverings, shall be waterproof, non-hygroscopic, resistant to wet and dry rot, and resistant to mold growth. The floor deck shall not be sandwiched</p>	<p>Complies with specification – ¾" marine grade as required. See Equipment List F for more details</p>

between the wall structural members and the floor structural members.	
<p>b. The entire passenger area including the wheelchair securement area, entrance steps and stepwell area, shall be overlaid with smooth, slip resistant flooring material. The resilient sheet flooring system (2.2 mm thickness minimum) shall be a high-quality vinyl with aluminum oxide and color quartz grains throughout the thickness, silicon carbide grains in the surface layer and a non-woven polyester/cellulose backing with glass fiber reinforcement. The flooring shall extend up the sidewall and rearwall to the seat rail line and shall be coved at the floor/wall joint to form a smooth watertight transition. A cove molding radius backing block, approved by the flooring manufacturer, shall be installed behind all floor coving and shall be 1.5" radius (minimum). Installation of flooring must be done strictly according to the flooring manufacturer's directions using the proper accessories, tools, and adhesives. Suggested Sources: Altro Transflor™ Meta, Altro Transflor™ Chroma or Gerflor Tarabus; Profusion.</p>	Complies as specified with suggested source GerFlor Tarabus flooring.
<p>c. Step treads shall be one-piece resilient sheet flooring system matching the passenger compartment flooring. All step edges (nosings of step tread material) shall have a band of bright yellow contrasting color running full width of the step. Step tread to stepwell joints shall be sealed to prevent intrusion of moisture and debris. No aluminum step nosing shall be used.</p>	Complies as specified with suggested source Geflor yellow to allow for rubber in lieu of the aluminum step nosing as required by MDOT and VEAT.
<p>d. An aisle width standee line of bright yellow contrasting color shall be in the aisle just behind stepwell (must meet ADA contrast requirement). Suggested Sources: Altro Safety Step System or Gerflor</p>	Complies as specified with suggested source Gerflor yellow
<p>e. Color of all flooring and step tread shall be equal to Altro Transflor genome (grey) or bison (tan) or Gerflor Tarabus; Profusion as requested by the agencies.</p>	Complies as specified with suggested source Gerflor
<p>f. To provide easy access for service, the floor shall have a vapor and fumeproof bright aluminum diamond plate access panel to reservoir fill/check areas and fuel tank sending unit large enough to remove the sending unit and thick enough to prevent it from flexing under normal use.</p>	Complies as specified
<p>g. Standee decals shall be furnished and mounted at the center of the bus above the windshield.</p>	Complies as specified
<p>h. Wheel wells, when required, shall be thoroughly sealed to prevent intrusion of moisture and dirt. Metal wheel wells inside the passenger compartment shall be covered with flooring material or molded fiberglass (FRP or ABS).</p>	Complies as specified
7) Emergency Exits	
<p>a. Each bus shall be equipped with a rear exit door with a minimum opening of 1296 square inches (a rear exit window in place of the door is optional). All exposed exit door frame/jamb structure shall be made of 400 series stainless steel, a grade which does not discolor with aging. The rear door exit and side window exits shall meet federal requirements of FMVSS 217. The manufacturer shall provide a method to lock the rear exit door. The rear exit door shall have an audible alarm at the driver's area activated when the exit door latch handle starts to open and when the exit door is locked with the ignition on. A bus with a rear exit door shall have one small window on each side of the exit door in the rear endcap.</p>	Complies as specified with Stainless Steel structure

<p>b. The rear exit door shall have two windows, an upper window and a lower window, as a part of the door. The door glass shall be see-through, AS-2 tint (70% luminous transmittance) safety glass. The upper door window height shall match top of rear bus windows as close as practical, one on each side of rear door. Door windows shall match design of bus rear windows. Heavy-duty door latch mechanism with handle guard shall provide a quick release for opening from inside and outside the bus but be designed to offer protection against accidental release. The door latch shall cause the door to compress the perimeter door seal to provide an airtight, dustproof and watertight seal around the door under all operating conditions and speeds. Door panels shall match exterior and interior body panels material construction (see section B., Body Structure and Exterior Panels, subsection 2, items c., and d.) and have foam insulation in between panels. All doors shall be fitted with screwed or bolted-on heavy-duty stainless-steel piano hinges or heavy-duty hinges of a noncorrosive material. A restraint shall be installed to prevent the door from opening beyond 105° or striking the rear panel of the bus when the door is opened.</p>	<p>Complies as specified.</p>
<p>c. A passageway of 16" minimum width shall be provided to the rear exit door. No seats or other objects shall be placed in bus, which restricts passageway to rear exit door.</p>	<p>Complies as specified</p>
<p>d. One-closing static exhaust vent, a combination roof vent-emergency exit (23" by 23" minimum), shall be installed at the mid-point on the longitudinal center line of the roof of the passenger section of the bus. The roof vent-escape hatch shall provide fresh air flow inside the bus when opened and when the bus is in a forward motion. The escape hatch shall have an inside and an outside release handle. There is no warning buzzer requirement for the escape hatch. Suggested source: DMA 1122, Specialty Manufacturing Co., Transpec Inc.</p>	<p>Complies as specified with suggested source Transpec Inc.</p>
<p>e. Instructions for proper use of all emergency exits shall be marked in close proximity to the release mechanisms. All interior markings shall be durable materials permanently affixed to the interior panels' smooth surfaces or markings shall be durable materials permanently affixed to metal plates fastened to the interior panels of the bus. Instructions may be labels, of <u>highly</u> contrasting color, affixed to a location that shall be approved by the state. All emergency exits shall be marked on the exterior of the bus.</p>	<p>Complies as specified</p>
<p>f. Lever-type latches used for emergency windows shall secure the windows tightly shut, shall be easily operated, and shall not unlatch due to vibration during bus operation. The latches shall be made of non-corrosive materials and be designed for minimal maintenance needs. Side emergency window latches shall be located on the sides, <u>NOT</u> the bottom. Rear emergency window latches shall be in the bottom.</p>	<p>Complies as specified – side latches</p>
<p>g. Each exit used for passenger egress shall be identified with a red ½" LED indicator lamp, illuminated with the vehicle marker lighting when ignition is in the "ON" position, above each exit, so that it may be seen by a passenger in an adjacent seat. Suggested Source: Series 29, Sorenson Lighting Company</p>	<p>Complies as specified with Sorenson Red LEDs</p>
<p>8) Gauges</p>	

<p>a. Chassis Original Equipment Manufacturer (OEM) gauges shall be used in the driver's instrument cluster, but if they are not available, VDO brand gauges or Stewart Warner gauges shall be used. Each bus shall have an instrument cluster with the following non-glare needle-type gauges which are easily monitored by sight from the driver's position (lights in lieu of gauges are not acceptable).</p>	<p>Complies as specified with OEM gages</p>
<p>b. If available from OEM chassis manufacturer voltmeter and its wiring shall be compatible with generating capacities.</p>	<p>Complies as specified with OEM gages</p>
<p>c. Engine oil pressure gauge.</p>	<p>Complies as specified with OEM gages</p>
<p>d. Engine coolant temperature gauge.</p>	<p>Complies as specified with OEM gages</p>
<p>e. Fuel gauge.</p>	<p>Complies as specified with OEM gages</p>
<p>9) Farebox</p>	
<p>a. The farebox (a donation box is optional) shall be mounted with the trip handle toward the driver and within easy reach of the driver. The farebox shall be mounted on an adequately braced stanchion; shall be located over a flat floor surface near the driver; and shall be accessible to passengers entering the bus (meet ADA requirements). An indirect farebox light shall be connected through an entrance door jamb switch to the running light circuit operational only when door is opened.</p>	<p>Complies as specified – Diamond NV Brand</p>
<p>b. The farebox shall be lockable and supplied with two vaults that are interchangeable and lockable (2 keys for each lock). The vaults shall be keyed alike. The vault and farebox exteriors shall be marked with key reference. (Location shall be approved by ordering agency.) Suggested source: Diamond Model NV</p>	<p>Complies as specified – Diamond NV Brand</p>
<p>10) Bumpers</p>	
<p>The front bumper shall be an OEM bumper. The rear bumper shall be a high energy absorbing bumper. The rear bumper shall be installed per bumper manufacturer's specifications. Bumper attachment shall use a minimum of SAE grade 8 fasteners with thread locking feature or other shake-proof (Nord-Lock) mounting in all attachment brackets. Rear anti-ride bumper installation shall allow space between the bumper and the body for energy absorption movement without body damage. Rear bumper Suggested source: Romeo R.I.M. Inc. H.E.L.P. bumper, SMI.</p>	<p>Complies as specified – Front Ford OEM - Rear Romeo Rim HELP</p>
<p>11) Mud Flaps and Splash Guards</p>	
<p>a. The bus shall have commercial grade anti-sail mud flaps/splash aprons behind front and rear wheels which contain no visible imprinted logo or advertising. Front mud flaps shall be no-drill OEM and rear shall be rigid plastic type mud flaps. The flaps/aprons shall be securely fastened with full width metal strips and appropriate fasteners. The rear flaps/aprons shall be compressed between a gauge number 11 (.125" thickness, minimum) support bracket and a gauge number 14 (.075" thickness, minimum) metal strip. The OEM front flaps shall be fastened securely to the body substructure or chassis frame. The flaps shall extend to within 4 to 6" of the road surface at curb weight. The mud flaps/aprons shall be at least 1" wider than the tire widths (single front, dual rear) to control splash at the rear of wheel openings.</p>	<p>Complies as specified</p>

<p>b. Rubber or ABS fender splash guards secured with stainless fasteners shall be installed on the rear wheel well opening.</p>	<p>Complies as specified</p>
<p>c. Where the mud flaps and splash guards are not an integral part of the body, installation shall be made after the finish coat of paint is applied to the bus using appropriate fasteners and adhesive.</p>	<p>Complies as specified</p>
<p>12) Towing</p>	
<p>Tow hooks shall be provided with two in the rear and two in the front if available from OEM of the bus, which shall be of sufficient strength to tow 1½ times the GVWR of the bus. <u>Tow hooks shall be equipped with a spring safety clips (rear only)</u>, easily accessed, and free of interference with the bumper system when in use. Access to tow hooks may be made through holes in the bumper assembly. The intended use for tow hooks is only to safely move the bus to a point of tow truck hook-up. Tow hooks shall be installed to prevent them from dragging when the bus is driven over an incline. The tow hooks, equal to Original Equipment Manufacturer (OEM) units, shall be mounted and adequately secured to the chassis frame as recommended by the tow hook manufacturer or may be supplied by the OEM as standard equipment on the chassis. The bus shall be designed to be towed from the front or from the rear with either a frame contact or a wheel lift. A fuel tank protection frame shall not interfere with a frame contact lift. The bidder shall provide the towing and lifting procedure at delivery.</p>	<p>Complies as specified</p>
<p>13) Undercoating/Rustproofing</p>	
<p>a. When the unit is completed, the sections of the underside of the bus exposed to the elements shall be treated with an undercoating material except those areas of the OEM chassis where undercoating is not recommended. Undercoating shall be warranted for the same period covered by the body/structure warranty. Suggested source: : Pure Asphalt 76M or 770 or Tectyl 517 or 121-B or Z Technologies Z Guard 9902 STAR</p>	<p>Complies as specified – Tectyl 121</p>
<p>b. Rustproofing - All box type steel tubing (except stainless steel) used in the floor structure and sidewall structure from the top of the window down, shall have the interior of the tube coated with corrosion resistant material conforming to MIL-C-62218 as outlined in Federal Standard 297E. Sections that are treated shall be properly cleaned to remove greases, oils, and residues before application of the corrosion-proofing material. Any welded areas shall be retreated to avoid corrosion. All mechanisms (moving or stationary parts) that are affected by or rendered useless by an application of sealant or insulation shall be cleaned free of sealant or insulation including vent canisters and drainpipes. Rustproofing shall be warranted for the same period covered by the body/structure warranty. Suggested source: Pure Asphalt 825 or 372 or Waxoyl, Ziebart Type-A.</p>	<p>Complies as specified Waxoyl</p>
<p>14) Interior Mirrors/Sun Visors</p>	
<p>a. Interior mirror rearview shall be OEM</p>	<p>Complies as specified - OEM</p>
<p>b. Windshield sun visor system shall be standard Original Equipment Manufacturer (OEM) chassis visor(s). If the</p>	<p>Complies as specified - OEM</p>

<p>OEM chassis is not equipped with a windshield sun visor, two large transit-type, fully adjustable, double-knuckle, arm-type Plexiglas sun visors shall be provided for the driver at the windshield, and at the side window. Suggested source: OEM or Manufacturer's standard.</p>	
<p>15) Exterior Mirrors</p>	
<p>a. Each bus shall be equipped with exterior, powered-remote, heated, left-hand and right-hand rear view mirrors of flat glass with convex mirrors (3" in diameter, minimum) attached or a combination flat/convex glass in a single mirror head. Both flat and convex glass shall be power remote adjustable. The mirror brackets shall be brushed stainless steel. The mirror shall contain at least 70 square inches of flat glass viewing area. <u>ALL MIRROR MOUNTING SHALL NOT CAUSE PREMATURE BODY DAMAGE. No use of self-tapping or self-drilling screws to mount mirrors.</u> Suggested source: ROSCO Eye-max LP Hawk, Mirror Lite Co, Inc.Bus Boy.</p>	<p>Complies as specified – ROSCO heated and remote with stainless steel arms and no self tapping screws.</p>
<p>b. To prevent obstructed front and right-hand view, a convex, asymmetric, exterior cross view mirror (8" minimum diameter) shall be provided on the left front corner of the bus. Suggested sources: Rosco Eye-Max LP, Rosco Bus Boy</p>	<p>Complies as specified – Rosco Eye</p>
<p>c. All exterior mirrors shall be constructed with high impact plastic or stainless steel housings. Mirrors (except cross view mirror) shall be remote adjusting and shall move independently of the mirror housing. The mirrors shall be modular in design so that the glass can be replaced using the "twist lock" mechanism for service without removing the entire mirror assembly from the bus.</p>	<p>Complies as specified</p>
<p>d. Mirror mountings shall be reinforced when not in a structural frame member to prevent mirror vibration, with approval by the State at the time of Pilot Model Inspection. The mirror placement shall not obstruct driver vision nor have window divider bars between the driver and mirror face. <u>ALL MIRROR MOUNTING SHALL NOT CAUSE PREMATURE BODY DAMAGE</u></p>	<p>Complies as specified</p>
<p>16) Driver's Seats</p>	
<p>a. The driver's seat shall comfortably hold and support the human body in the ergonomically correct position for driving and meet the flammability requirements of FVMSS 302. The driver's seat with arm rests (right side seat arm rest, left side door arm rest) shall have adjustments for fore and aft slide, 4" minimum travel, back recline, 20° minimum, and weight range capacity up to 350 pounds. While seated, the driver shall be able to make all of these adjustments by hand without complexity, excessive effort, or being pinched. Manual operated adjustment mechanisms shall hold the adjustments and shall not be subject to inadvertent changes. The seat shall be high-backed and shall be properly aligned (centered) behind steering wheel to allow for maximum seat adjustments and operator comfort. The seat belt with shoulder harness, automatic retractor and supplemental restraint (SRS) system shall be chassis Original Equipment Manufacturer (OEM) equipment. Any modifications to the body shall not interfere with driver's seatbelt adjustments including shoulder height adjustment. All seats and seat mountings shall meet applicable federal standards. <u>An option for an electric 6-way power adjustable seat shall be</u></p>	<p>Complies as specified – OEM FORD offering standard and power option.</p>

<p><u>available</u>. Suggested sources: OEM, USSC G2ELP, Recaro Ergo Metro with headrest and armrests.</p>				
<p>b. The driver's seat cushion shall be molded high resilient (HR) polyurethane foam padding with indentation load deflection (ILD) 35 pounds minimum, and the back cushion shall be molded or fabricated high resilient (HR) polyurethane foam padding (ILD) 25 pounds minimum. There shall be no welt or bead across the front of the seat cushion under the driver's legs. Compressions to 10 percent maximum and tensile strength, 15 lbs. per square inch minimum. Seat and back cushion foam shall meet the typical physical properties of ASTM D-3574 and the flammability requirements of FVMSS 302.</p>	<p>Complies as specified – See Foam data included with proposal</p>			
<p>c. The driver's seat covering shall be gray Cloth-type Woven Fabric (with flame retardant qualities) or material and color matching bus seats if possible, meeting the requirements listed below in All Seats (see section B. Body Structure and Exterior Panels, subsection 19. Seat Material, item b. Cloth-type Woven Fabric Requirements(with flame resistance)).</p>	<p>Complies as specified – Ford cloth</p>			
<p>17) Passenger Seats</p>				
<p>a. All passenger seats shall be mid-back and are required to meet all applicable FMVSS testing including FMVSS 210 (see section C. Vendor/Manufacturer Requirements, subsection 8. Bid Documents, item p.).</p>	<p>Complies as specified – See Seat Data included with proposal</p>			
<p>b. Two passenger, forward facing seats shall be 35" minimum width with a non-foam, black energy-absorbent, vandal-proof grab handle mounted to the top of each seat back (two per double seat). Grab handles are not required on seats that have a back against a wall.</p>	<p>Complies as specified – Freedman Seating Co.</p>			
<p>c. Single passenger seats shall be 17-½" minimum width with a black, energy-absorbent, vandal-proof grab handle mounted to the top of the seat back.</p>	<p>Complies as specified – Freedman Seating Co.</p>			
<p>d. Forward facing seats shall have 27" minimum knee to hip room.</p>	<p>Complies as specified – 27" minimum</p>			
<p>e. Aisle facing seats shall have arm rests on both ends if the seat is not against a modesty panel.</p>	<p>Complies as specified</p>			
<p>f. Aisles shall not be less than 16" wide except as noted in Part 18 of this section.</p>	<p>Complies as specified</p>			
<p>g. The first double seat, aisle side, on the curb side of the bus shall have an integrated child restraint seat capable of safely carrying children of 22 to 50 pounds.</p>	<p>Complies as specified – Freedman Integrated Child Seat ICS</p>			
<p>h. All seats shall be supported on the floor with high carbon steel support brackets. Seat frame shall be cold-roll steel tubing. Floor anchorage shall be neat and not interfere with entering and exiting the seat. All seat mounting bolts shall be corrosion resistant coated/plated fasteners. Passenger seating floor rail/track shall not be installed in the wheelchair lift or wheelchair securement areas. The bidders shall provide certification test data that the installation of the seats, seat mountings including floor anchorage and floor fasteners shall meet all applicable FMVSS including FMVSS 207, 208, 209, and 210 for the bus model being offered in this bid (see section C. Vendor/Manufacturer Requirements, subsection 8. Bid Documents, item p.).</p>	<p>Complies as specified – Freedman Seating Co. – See seat data included in proposal.</p>			
<p>i. All metal components of the seat assembly shall be coated with a powder coat epoxy paint finish that shall meet the following tests:</p>	<p>Complies as specified – See VW Salt Spray testing included with this proposal</p>			
<table border="1" data-bbox="175 1801 699 1829"> <tr> <td data-bbox="175 1801 363 1829">Salt Spray</td> <td data-bbox="363 1801 532 1829">480 hours</td> <td data-bbox="532 1801 699 1829">ASTM B117</td> </tr> </table>	Salt Spray	480 hours	ASTM B117	
Salt Spray	480 hours	ASTM B117		

Humidity Resistance	480 hours	ASTM D2247	
Impact Resistance	To 80 inch-pounds	ASTM D2794	
<p>All testing is to be performed on standard metal seating materials that have coating thickness of 1.3 to 1.8 mils. Certified test documents are required with bid proposal (see section C. Vendor/Manufacturer Requirements, subsection 8. Bid Documents, items o.).</p>			
j.	<p>The seating arrangements and configuration shall be furnished by the Program Manager or Designee and/or Ordering Entity.</p>		Complies as specified
k.	<p>Suggested sources: American Seating Horizon™ 8535 Mid-Back Series; C.E. White LE Series; Freedman Feather Weight.</p>		Freedman Seating – Feather weight suggested source as specified.
18) Wheelchair Lift-Equipped Buses Folding Seats			
a.	<p>Forward facing solid back, bench style (double) fold-away or flip (double) seats with seat belts shall be provided in the wheelchair securement area per seating arrangements (see Section B. subsection 28, Wheelchair Securement Area). <u>All aisle facing seats provided shall be flip seats.</u> Fold-away or flip seats shall include all dimensional, structural and testing requirements of the standard seat specification. Seat locking/latching devices shall be of high quality and be easy to latch and unlatch. Seats must positively latch in the seated and folded position to prevent inadvertent folding or unfolding of the seat. Any support legs resting on flooring shall be non-marring or rest on metal plates flush mounted with flooring. All fold-away seats shall be able to pass FMVSS 210 without having to fasten additional latches or cables. All fold-away seats shall fold against the wall when wheelchair space is required (no further than 12" from wall in the vertical folded position). Seat may not extend into bus more than 37½" (two passenger) and 18½" (1 passenger) when folded down for passenger seating. Aisle space may be reduced to 14 inches where fold-up seating is placed on each side of the aisle or 15½" where placed opposite a stationary seat. The seat bottom cushion shall be a 5° tilt up from level, minimum, and back cushion shall be at 95°, minimum. The seats shall be of the same design as the other passenger seats. All seat backs of the fold-away/fold-up seats shall be covered with material matching seat cushion color and fabric. Suggested source: American Seating Horizon™ 8800 Cantilevered Folding Seat or 8700 Flip-up; C.E. White LE Series; Freedman Feather Weight Foldaway or Mid-Hi Flip; Braun #125.</p>		Complies as specified – Freedman Featherweight 3 way Fold-a-way as specified
19) Seat Material			
a.	<p>Seats shall be individually contoured to each passenger for occupant comfort and retention. Seats shall be covered with cloth-type woven fabric or vinyl fabric at the transit agency's option. Cloth-type fabric or vinyl shall be D-90 compliant and completely enclose the seat cushion and the seat back. Seat background colors shall be gray, red, blue, and other in-stock colors (bidder to provide available choices at time of bid). All background colors shall be approved by the Program Manager or Designee.</p>		Complies as specified
b.	<p>Cloth-type Woven Fabric Requirements (with flame resistance)</p>		Complies as specified

i	Minimum weight 23 ounces per linear yard.	Complies as specified
ii	50,000 minimum double rubs (ASTM - 3597-77 Wyzewbeek Method).	Complies as specified
iii	Color fastness to light 300 hours minimum (AATCC-16-1977 Carbon Arc.)	Complies as specified
iv	Comply with California BLT-117.	Complies as specified
v	All cloth-type woven fabrics except Holdsworth Wool shall be treated with a flame proofing solution following the manufacturer's specifications, No-Flame by Amalgamated Chemical Inc., or equal.	Complies as specified
vi	The fabric shall be a plush material.	Complies as specified
vii	Suggested source: D-90 Flame Resistant Fabrics by, CMI, Holdsworth Wool, or Camira. Contractor shall provide technical data sheet including flammability and smoke emissions for the seat covering material supplied (see section C. Vendor/Manufacturer Requirements, subsection 8. Bid Documents, item n.).	Complies as specified – MDOT approved Camira D90 Level 7 Gray and Blue offered.
c. Vinyl Fabric		
i	Shall be transportation grade expanded vinyl, 33 +/- 5% ounces per linear yard minimum.	Complies as specified
ii	Suggested source: D-90 Flame Resistant vinyl by CMI or Camira. Contractor shall provide technical data sheet including flammability and smoke emissions for the seat covering material supplied (see section C. Vendor/Manufacturer Requirements, subsection 8. Bid Documents, item n.).	Complies as specified – CMI Gray, Blue or Mushroom as specified
d. Cushions		
i	Seat cushion and back cushion shall be molded high resilient (HR) polyurethane foam padding. Seat cushion indentation load deflection (ILD) shall be 35 pounds minimum, with compression to 15% maximum, and tensile-strength of 15 minimum. Seat and back cushion shall meet the physical properties of ASTM D-3574 and the flammability requirements of FMVSS 302, minimum. The technical data sheet for the foam supplied shall be included in the bid proposal with the seat information (see section C. Vendor/Manufacturer Requirements, subsection 8. Bid Documents, item q.). Suggested source: Manufacturer's standard.	Complies as specified – Freedman – see foam data supplied with proposal. Q - Seat Cushion Foam
ii	Seat and back cushions shall be supported with a spring-type support system. Seat and back cushions shall be completely covered with seat cushion covering material. Seat back depth shall not exceed 3½" overall.	Complies as specified – ICS may vary
e. Passenger Seat Belts		
i	The bidders shall provide certification test data that the seat belts, and the installation are in compliance with FMVSS-207, 208, 209, and 210 where applicable for the bus model being offered in this bid (see section C. Vendor/Manufacturer Requirements, subsection 8. Bid Documents, item p.).	Complies as specified – Freedman – see seatbelt data supplied with proposal. P - Seat Belt Certs
ii	Two universal "Buckle Up" decals approximately 6" by 6" shall be furnished loose with each bus. Decals shall indicate that seat belt use is recommended.	Complies with specification

<p>iii All seats shall be equipped with seat belts for each designated seating position, except center seat on rear five passenger bench, which shall be non-retracting type.</p>	<p>Complies with specification</p>
<p>iv The male end of the belt will have a locking retractor. The retractor will be mounted underneath the seat to the seat frame and there shall be no lap retractors except on the rear center bench seats (if equipped).</p>	<p>Complies with specification</p>
<p>v Belts shall have a push button latch release mechanism with push button on aisle side of seat.</p>	<p>Complies with specification</p>
<p>20) Handrails, Stanchions (Shall meet ADA regulations)</p>	
<p>a. The handrails and stanchions shall be a minimum of 1¼" outside diameter. All handrails and stanchions shall be positioned so as not to interfere with wheelchair movement and shall meet ADA requirements for position and size. All handrails and stanchions in the passenger entrance area shall be highly visible yellow in color. All other handrails and stanchions shall be brushed stainless steel. Mounting brackets and fittings shall be composed of the same kind of material used for the stanchion or handrail. Stanchion mounting rubber grommets shall be able to handle roof to floor flex without excessive damage or ejection.</p>	<p>Complies with specification</p>
<p>b. All handrail and stanchion mountings shall have reinforcement plates welded to or imbedded in the structure behind surface panels of sufficient size and strength. Final locations shall be determined at pilot model inspection. Self-tapping/threading screws shall NOT be used.</p>	<p>Complies with specification</p>
<p>c. A floor-to-ceiling vertical stanchion shall be provided in close proximity to the rear of the driver's area. A guardrail shall be provided in back of the driver's area extending from the vertical stanchion to the left side of the bus 30" plus or minus 2" above the floor. A padded modesty panel shall be provided from the guardrail to within 8" of the floor. Stanchion and guardrail shall not restrict any driver's seat adjustments.</p>	<p>Complies with specification</p>
<p>d. A smoked Plexiglas panel, 3/8" thick, shall be provided behind driver from top of the driver's seat to within 12" of bus ceiling. The panel shall not impair driver's seat adjustments. The panel shall be fastened with bolt and nuts or double screw heads. Self-tapping/threading screws shall NOT be used. The panel shall be located to allow the driver's seat back to recline to ½ its maximum reclined adjustment with the driver's seat in the position furthest from the steering wheel. Panel may be incorporated into the stanchion and guardrail behind the driver and shall have cutouts to give hand access to the vertical stanchion.</p>	<p>Complies with specification</p>
<p>e. Floor-to-ceiling stanchions (yellow) shall be provided near aisle on each side of front entrance rearward of the immediate entrance stairwell.</p>	<p>Complies with specification - Yellow</p>
<p>f. Left and right-side entrance handrails (yellow) shall be installed from low stepwell to floor-to-ceiling stanchions. Entrance handrails shall be positioned so passengers entering or exiting the bus will have handrail support throughout the entering/exiting process and so that articles of clothing may not become entangled in the handrail-stanchion-guardrail assemblies.</p>	<p>Complies with specification - yellow</p>

<p>g. A guardrail (yellow) shall be provided in front of and at the rear of the front entrance steps, extending from the vertical stanchions to the right side of the bus 30" plus or minus 2" above the floor. A modesty panel (padded both sides, vinyl clad) shall be provided to the left (rear side) of the entrance from guardrail to floor (in case of lift bus, provide floor-to-ceiling stanchion with guardrail and modesty panel to rear of platform lift).</p>	<p>Complies with specification - Yellow</p>
<p>21) Interior Lighting</p>	
<p>a. All interior lights shall be LED and provide no less than two foot-candles of illumination on the entrance step tread or lift or ramp with the door open. Outside light(s) shall provide at least 1 foot-candle of illumination on the street surface within 3 feet of step tread outer edge. This system shall provide illumination automatically when the door is open and meet ADA requirements.</p>	<p>Complies with specification – LED Interior – ADA Compliant</p>
<p>b. All lights shall have access holes large enough to easily remove electrical connector. All non-OEM chassis lights shall cause no radio interference.</p>	<p>Complies with specification</p>
<p>c. Overhead entrance and stepwell lights shall be wired to and be automatically activated by a door controlled switch. All interior lights shall operate any time the ignition key is on and the door is opened.</p>	<p>Complies with specification</p>
<p>d. Stepwell light shall be on the side away from wheel splash.</p>	<p>Complies with specification</p>
<p>e. Interior lighting shall be LED and provide a minimum of two foot-candles of illumination at a reading level, minimum 3 per side. Interior lighting fixtures shall be reasonably flush with the interior walls and ceiling so no hazard exists for the passengers. All lights shall have lead wire long enough to remove light at least 6" from bus and easy access to the connectors for service.</p>	<p>Complies with specification – LED Interior – extended 6-10" wires for easy removal</p>
<p>f. Light installation shall be designed to illuminate the lift platform when deployed at floor level at no less than two foot-candles of illumination. Outside light(s) shall provide at least 1 foot-candle of illumination on the street surface within 3 feet of step tread outer edge. This system shall provide illumination automatically when the lift door is open and meet ADA requirements. On-off light switch shall be lift door-actuated.</p>	<p>Complies with specification – LED Interior – ADA Compliant</p>
<p>22) Exterior Lighting</p>	
<p>a. Exterior lighting shall be non-PCB product with direct overmold plastic and no air gap construction in accordance with Federal Motor Carrier Safety Regulations (393.11) and ADA regulations. All lights shall have the lead wires long enough to remove the light at least 6" from bus for service. Unless specified, all exterior lights of the bus shall be light emitting diodes (LED) sealed lamps retained in a rubber grommet mounting except for surface mounted lights and front headlamp/turn signal assemblies.</p>	<p>Complies with specification with overmold plastic and no air gap construction</p>
<p>b. All lights shall have access holes large enough to easily remove electrical connector including strobe light.</p>	<p>Complies with specification – LED Exterior – ADA Compliant - Grometed</p>
<p>c. Exterior marker lights shall be light emitting diodes (LED) (2" in diameter sealed lamp) retained in a rubber grommet mounting except for surface mounted lights and conform to Federal Motor Carrier Safety Regulations Part 393.</p>	<p>Complies with specification – extended wires for easy maintenance</p>
<p>d. All marker lights shall have a weatherproof two prong (one positive and one ground) or three prong plug-style connector with the ground wire connected to an in-harness ground attached to a common grounding point.</p>	<p>Complies with specification</p>

<p>e. Marker and tail lights shall be operated through a relay controlled by the headlight switch. Suggested Sources: Innotec, Dialight, Grote, Optronics, Peterson, SoundOff Signal, Trucklite. Headlights shall be Halogen lamps and the standard front park/turn lights may be a part of the OEM headlight assembly.</p>	<p>Complies with specification</p>
<p>f. An amber, LED, mid-ship light (sealed) shall be installed on both sides of the bus and shall operate with the hazard flashers, marker, and turn signals. License plate light shall be LED.</p>	<p>Complies with specification – mounted as requested.</p>
<p>g. A red, 4" round, oval, rectangular, voltage regulated non-PCB product with direct overmold plastic and no air gap construction LED high mount stop lamp shall be mounted centrally in the rear panel of the bus and work in conjunction with the brake lights. The high mount stop lamp shall be mounted either above the rear emergency exit door or above the rear emergency exit window. Final location of high mount stop lamps shall be determined at pilot model production. Suggested Sources: Innotec, Command Electronics model 003-82, Dialight, Grote, Optronics, Peterson, SoundOff Signal, Truck-Lite.</p>	<p>Complies with specification</p>
<p>h. Brake/tail lights shall be red 4" round sealed voltage regulated LED lamps and shall not override hazard flashers or turn signals.</p>	<p>Complies with specification</p>
<p>i. Directional rear turn signal lamps shall be amber 4" round sealed voltage regulated LED lamps.</p>	<p>Complies with specification</p>
<p>j. Back-up lamps shall be clear, 4", round, sealed, voltage regulated LED lamps. Back-up lights shall be 500 lumens minimum.</p>	<p>Complies with specification</p>
<p>23) Heating/Ventilating/Air Conditioning (HVAC)</p>	
<p>a. During normal passenger service, front and rear heavy-duty heating system shall be capable of raising the interior temperature of a bus from 0°F to 60°F at knee level (22" above the floor) throughout the interior of bus within 30 minutes from engine startup. After initial warm-up, while the bus is in passenger service, the front and rear heavy-duty heating system shall be sufficient to maintain a minimum of 64°F at knee level throughout interior of bus and at the driver's foot space when the outside temperature is 0°F. Heating system operation will be verified by the required system testing as defined in Section C.4. Heating/Ventilating (HV) Certification. In addition to the front heater and windshield defrosters, for increased air circulation, one 6" two speed fan with non-glare blades and body shall be mounted away from passenger and driver traffic in the driver's area near the windshield. The fan shall be mounted securely. Grounding for all heater fan motors shall be supplied by an in harness ground wire attached in the fuse panel to a common grounding point. All HVAC fan motors shall be supplied with proper radio frequency (RF) suppression equipment to remove two-way radio interference.</p>	<p>Complies with specification – ProAir rear heater as specified</p>
<p>b. Front heating unit shall be automotive in-dash type, chassis Original Equipment Manufacturer (OEM), and shall be capable of delivering heat, fresh air ventilation, and air conditioning (optional) to the driver's area. The front heater shall have a temperature control valve which can be regulated from the driver's area. The driver's area shall have air circulation in each mode of defrost, heat, fresh air ventilation, and air conditioning (optional) of 125 cfm at the foot area, with a total driver's area circulation of 400 cfm minimum.</p>	<p>Complies with specification – OEM Chassis heater</p>

<p>c. Rear heating unit(s) shall distribute heat in at least a 180° direction and ensure air distribution to all passenger areas of the bus interior. Heating unit(s) shall have a minimum 5/8" I.D. heater inlet and outlet ports with a BTU/hr output rating to match the specified HVAC performance requirements. Coolant flow through the heating units shall not be restricted by excessive bends or kinks in hoses or excessive lengths of hoses. Heating units shall have rubber or nylon insulator(s) between their mounting base and floor of the bus. Suggested sources: ACC Climate Control, A. R. Lintern, Bergstrom, Pro-Air, MCC Mobile Climate Control</p>	<p>Complies with specification – ProAir as specified</p>
<p>d. The premium heater hose (5/8" ID minimum) shall be high temperature resistant Ethylene Propylene Diene Monomer (EPDM) material. Hose shall be a reinforced type with Aramid knitted fiber reinforcement between the EPDM tube and EPDM cover. Heater hose material shall be compatible with all types of coolant including long life coolant. Rated temperature limits of the hose shall be -40°F to +300°F minimum, with a burst pressure of 130 PSI minimum.</p>	<p>Complies with specification – 5/8" hoses and valves</p>
<p>e. Manual shut off valves for the rear heater shall be placed as close to the engine as is practical. The 5/8" ID heavy-duty brass ¼ turn shut off valves shall be located in the heater outlet line (from engine to heater) and in the heater inlet line (to engine from heater). Shut off valves shall be accessible by personnel without going under the bus with access panels. Location to be determined at pilot model inspection.</p>	<p>Complies with specification –5/8" hoses and valves</p>
<p>f. Front heater shall have coolant temperature control valve or other controls which can regulate heater temperature from the driver's area.</p>	<p>Complies with specification</p>
<p>g. All heat lines and hoses shall: have exterior routing along the bus frame rail where possible; be sufficiently protected to ensure against wear from friction and the elements; be insulated to reduce heat loss; use routing that eliminates excessive bends and hose lengths; and have heater hose passage holes through engine cowl and floor area thoroughly sealed to prevent air, dust, and moisture intrusion.</p>	<p>Complies with specification</p>
<p>h. Air conditioning charge ports shall be protected from road debris to prevent corrosion.</p>	<p>Complies with specification</p>
<p>i. Air Conditioning (see section B. Body Structure and Exterior Panels, subsection 56. Options, item a. Air Conditioning – Split System, and item b. Air Conditioning/Heat – Rooftop System).</p>	<p>Complies with specification – See F Equipment lists for details on Air Condition systems proposed.</p>
<p>24) Windows</p>	
<p>a. Passenger compartment windows shall be T-type slider at top, full slider, or top tip-in type for window ventilation. Windows shall have tempered safety glass and heavy-duty locking features which shall meet FMVSS 217 for emergency exits, if applicable. Window glazing material shall be able to maintain its seal and glass retention for the life of the unit. Caulking around windows shall be used only as a seal, not to make up for body defects or out of tolerance window openings (maximum clearance of ¼" around the frame, 1/8" on each side). All window glass shall be tinted – passenger windows AS-3 tint 31% luminous transmittance, right and left driver's side windows AS-2 tint 70% luminous transmittance, and windshield shaded-tinted AS-1 tint – and meet applicable</p>	<p>Complies with specification – T Sliders as specified</p>

federal standards. Drip rails shall be installed the entire length of the bus body above windows and doors.	
b. Driver's compartment right and left side windows shall be designed for maximum window area to provide unobstructed vision. Driver's compartment window shall be chassis Original Equipment Manufacturer (OEM) door window. Driver's right side window shall be one piece. Suggested sources: OEM	Complies with specification - OEM
c. Black trim shall be installed or painted to completely cover the space between all side passenger windows. The trim line shall match the bottom edge of the windows. If equipped with a side lift door, a black trim stripe shall be painted from and around the lift door windows to match the trim of the side windows. The window trim shall give the illusion of one solid window.	Complies with specification
d. Windshield shall be OEM.	Complies - OEM
25) Paint	
a. All exterior surfaces shall be smooth and free of visible fasteners (excluding round head structural rivets), dents, and wrinkles. As appropriate for the paint used and prior to application of paint, the exterior surfaces to be painted shall be properly cleaned and primed to assure a proper bond between the substrate and successive coats of original paint. All FRP body paint must match OEM chassis paint codes. Paint shall be applied smoothly and evenly, with the finished surface free of dirt, runs, orange peel, and other imperfections. All exterior finished surfaces shall be impervious to diesel fuel, gasoline, and commercial cleaning agents. Finished surfaces shall not be damaged by controlled applications of commonly used graffiti-removing chemicals.	Complies with specification
b. All exterior paint shall be a two part acrylic-urethane-type or polyurethane-type with low volatile organic compound (VOC) emission. The finish coat of paint shall be applied before rubrail covers or inserts, fender flares, exterior lights, and other body mounted accessories are installed. Paint shall be applied in the following method: i If on bare aluminum, use proper cleaner. Suggested sources: Cromax Chromapremier, PPG followed by aluminum conversion. Suggested sources: DuPont 2265, PPG. ii If on bare steel, use proper cleaner. Suggested sources: Cromax Chromapremier, PPG followed with steel conversion. iii For all bare metal, use primer. Suggested sources: Cromax Chromapremier (two coats), PPG. iv Appropriate prep to stainless steel surfaces shall be used to ensure proper paint adhesion. v Appropriate primer as required shall be used on fiberglass surfaces. vi Coat entire prepared surface to be painted with minimum of two coats of paint properly activated and reduced and have a minimum thickness of three millimeters. Suggested sources: Cromax, PPG Concept System, Sikkens Corporation U-Tech brand.	Complies with specification – PPG Paints
c. Standard paint color for all buses shall be the manufacturer's pre-finished white exterior panels (to match OEM chassis white). Color scheme on all buses shall be provided at the time of ordering. Additional paint	Complies with specification

<p>schemes will be quoted in section B. Body Structure and Exterior Panels, subsection 56. Options, item k. Paint – Optional Designs. Special design paint application pricing will be negotiated at the time of ordering by the transit agency.</p>	
<p>26) Insulation</p>	
<p>a. Inside walls, ceiling, passenger floor area, driver floor area, and fire wall area shall be adequately insulated for sub-zero winters with spray-type foam insulation or glued in place insulation with a minimum R factor of 5. The insulation shall be non-formaldehyde, fire-resistant (FMVSS 302 minimum), non-hygroscopic, and resistant to fungus. Insulation shall prevent condensation and thoroughly seal bus so that drafts cannot be felt by the driver or passengers during operations with the passenger door closed. <u>Insulation shall not cover up electrical wiring harnesses, electrical switches, or other devices and shall not be sprayed in wheelwells.</u> All mechanisms (moving or stationary parts) that are affected, create a fire hazard, or are rendered useless by an application of sealant or insulation shall be cleaned free of sealant or insulation, including vent canisters and drain pipes. Tectyl 121-B shall not be applied over foam insulation.</p>	<p>Complies with specification</p>
<p>b. Engine hood cover and driver's area shall have adequate insulation to keep driver's foot area cool during summer months, warm during winter months.</p>	<p>Complies with specification</p>
<p>27) <u>Type I Lift, (Platform Type)</u> (Shall Meet ADA Requirements)</p>	
<p>a. The Type I platform lift (passive lift) shall be installed in a separate door opening for use by persons with disabilities. The lift assembly shall be mounted within the bus body on the right (curb) side. The bus manufacturer must provide documentation (reviewed by the State at pilot model production) that the lift installation complies with the lift manufacturer's lift installation requirements. The overhead clearance between the top of the door opening and the raised lift platform, or highest point of a ramp shall be a minimum of 68" to meet ADA requirements.</p>	<p>Complies with specification</p>
<p>b. The lift doors shall be manually operated, double-door with an outside key locking handle. Spring loaded struts or gas struts shall be provided on the lift doors to positively hold the doors in the open position. All door openings shall have full structural framing around the opening equal to the structural members of the body. The lift doors shall have an upper window similar to the side windows of the bus. Any exposed lift door frame structure shall be constructed of 400 series stainless steel, a grade which does not discolor with aging.</p>	<p>Complies with specification – Stainless Steel</p>
<p>c. The lift shall be an electro-hydraulic type. If the lift has a crossbar, it shall be above the door opening and well padded. The platform lift equipment shall be a double "C" channel parallel arm construction, hydraulically operated by two single-acting cylinders with gravity unfold, gravity down, power up, and power fold (stow) operation. No part of the lift platform shall exceed 6 inches/second during the lowering and lifting of an occupant, and shall not exceed 12 inches/second during deploying or stowing. The lift shall have a mechanical outboard safety wheel stop to prevent wheelchair from rolling off the platform during the lifting cycle. Successful bidder shall deliver the lift equipped bus with the type of lift equipment requested by the State. Suggested sources: Braun, Ricon.</p>	<p>Complies with specification – Braun (with option for Ricon)</p>

<p>d. A manual safety override shall be provided that will remain operable. Lift shall have manual override instructions visible from inside the bus.</p>	<p>Complies with specification</p>
<p>e. The entire lift assembly shall be installed inside the bus body and shall have padding installed on all sharp corners or items that protrude into the passenger area to prevent accidental injury to passengers. Wall and floor mounting points shall be reinforced and shall be attached with fasteners having a thread locking feature. Lift installation shall insure that no lift rattling exists when the bus is operated while the lift is stowed.</p>	<p>Complies with specification</p>
<p>f. A lift control interlock system shall be installed that shall ensure that the bus cannot be moved when the lift is not stowed and that the lift cannot be deployed unless the interlock is engaged [to meet ADA regulation in 49 CFR Part 38, Subpart B-Buses, Vans and Systems, §38.23, (b)(2)(I)]. The interlock system shall engage when the lift operation sequence is followed. Interlock operating instructions shall be included with the bus at delivery. An indicator light (red, labeled) shall be provided at the driver's station that is activated when the lift door is open and when the lift is in operation. <u>An interlock override system shall be installed that allows service personnel to move the bus to a safe area for repairs.</u> Suggested Source: Intelligent Lift Interlock System (ILIS) by Intermotive Products</p>	<p>Complies with specification – ILIS Intermotive</p>
<p>g. All lift equipped buses shall display the international symbol of accessibility, one each on left and right side of the bus. Location shall be determined ordering agency.</p>	<p>Complies with specification</p>
<p>h. The lift shall meet ADA requirements as well as these minimum requirements.</p> <ul style="list-style-type: none"> i Capacity 1,000 pounds minimum. ii Usable platform width 37" minimum. iii Usable platform length 54" minimum. iv Platform shall include automatic locking inboard safety wheel stop (minimum 6" height) and outboard safety wheel stops to prevent wheelchair from rolling off. v Platform shall automatically stop at floor level. vi Platform shall automatically stop when lowered to ground level. vii Hand held controls shall be conveniently located on a flexible or coiled, cut- resistant cable and shall be mounted with access from inside or outside the bus. The cable shall be routed to eliminate being pinched in any moving parts. viii Platform, bridge plate, and area between bridge plate and aisle shall be skid resistant. ix Bridge plate and platform shall be coated to resist rust. x Platform shall have horizontal handrails (one each side) on platform to assist passenger during lift operations. Handrails (yellow) shall fold automatically to prevent any obstructions into the bus passenger area. xi Lift door operated interrupt switch shall prevent use of lift with lift door(s) closed. Heavy duty long life switches shall be used in this application. xii The color of the lift shall coordinate with bus interior colors and be approved by the Program Manager or Designee or the Ordering Entity. The outside edges of the platform shall either be painted yellow or use 3M™ 	<p>Complies with specification – 1000 lb. 37 x 54 " as required.</p>

<p>vinyl safety stripe tape to enhance visibility when extended on the ground.</p> <p>xiii Sharp corners of lift platform shall be padded (remove for lift use) when in the stored position.</p> <p>xiv The wheelchair lift shall comply with all federal, Americans with Disabilities Act (ADA), and Veterans' Administration regulations.</p> <p>xv Lift platform shall be fitted with device to prevent the platform from touching or leaning against door after being returned to stored position when the lift assembly is not in use.</p>	
<p>28) Wheelchair Securement Area</p>	
<p>a. The wheelchair securement system shall be installed according to ADA & ANSI RESNA WC -18 requirements. Securement location shall be installed as shown by the seating plan option and approved at pilot model production. Fold-away seating shall be provided for use when wheelchairs are not being carried as shown in floor plans. The integrated securement system shall restrain the occupant and the wheelchair separately and securely.</p>	<p>Complies with specification – Use of Freedman Featherweight 3 step Fold-a-Ways – WC18 restraints from Q’straint / AM Bruns</p>
<p>b. Wheelchair securement shall meet these minimum requirements:</p> <p>i Forward facing wheelchair tie down and occupant restraint shall consist of four floor attachment points for the chair and a retractable combination, lap belt/shoulder restraint with manual height adjuster for the occupant per location.</p> <p>ii Securement floor anchorage points shall be anodized aluminum, stainless steel or other noncorrosive metal construction and consist of aircraft type insert pockets that can be flush mounted with the flooring (Flanged “L” style track, Q’Straint, Sure-Lok – Omni aluminum 6061-T6 or equivalent with matching end caps OR AMF-BRUNS Aluminum L-track, 6082-T6 with matching end caps). Anchorages and securements must be tested together and compatible and be from the same supplying manufacturer. Floor anchorage points for the first securement space shall be spaced at a minimum of 54" from center of front track to center of rear track. Floor anchorage points shall be located no closer than 8" from a stationary wall or obstruction (forward or rearward) that would hinder an operator from attaching the securement system. The center run of anchorage track between two securement locations can be shared with the rear anchorage of the front securement system and the front anchorage of the rear securement system. Width of anchorage track shall be no less than 30" wide allowing for the widest of mobility devices.</p> <p>iii Shoulder belt wall anchorage shall be permanently fastened to the body structure in the wall according to the securement manufacturer’s installation instructions. Shoulder belts shall be retractable with manual height adjustment and shall allow approximately 12" of vertical height adjustment allowing for differences in height of the secured mobility aid passenger.</p> <p>iv The four belts that attach to the wheelchair from the floor anchorage points shall use a simple speed hook end (“J” or “S” style) for chair attachment and have automatic self-tensioning heavy duty retractors with a</p>	<p>Complies with specification – Use of Freedman Featherweight 3 step Fold-a-Ways – WC18 restraints from Q’straint / AM Bruns – offered with L track and Single Point as an option.</p>

<p>hard metal cover and have available 2 tightening knobs per retractor as to allow the operator to easily reach a knob no matter the orientation of the retractor to the mobility device. Knobs are for aiding in additional securement control. All floor attachment belts shall be the same and work in any of the four floor attachment points and be equipped with pin connector brackets for the lap belt assembly. Automatic self-tensioning and self-locking retractors with metal covers shall be part of the four floor belt assemblies for automatic belt tensioning. Belt ends with floor anchor attachments shall be easily identified for placement in the floor track.</p> <p>v The securement system and components must comply with all applicable requirements of safety regulations and standards including ADA, FMVSS & CMVSS 209/210/222/302 & ANSI RESNA WC-4 Section 18</p> <p>vi Suggested sources: Q'Straint model QRT 360; Sure-Lok Titan 800 WC-18 series, AMF-Bruns Platinum Series WC-18</p>	
<p>c. Restraint Storage System</p> <p>i A wheelchair restraint storage system shall be positioned under the foldaway seats at each wheelchair space. Storage system shall:</p> <ol style="list-style-type: none"> 1. Keep restraints clean. 2. Be free of any sharp edges. 3. Provide easy accessibility to restraints. 4. Restraints shall be stored securely to prevent noise while the vehicle is in motion. 5. Restraint storage system shall be compatible with the installed securement system (L-Track or 360 degree single point securement system). A TDSS shall be provided for each wheelchair location. Suggested Source: Freedman Tie-Down Storage System. <p>ii A storage pouch, from the securement manufacturer, shall be provided for the lap belt restraints so that the restraints can be stored off the floor in the bus when not in use. Location of storage pouch shall be determined by ordering agency.</p>	<p>Complies with specification - Q'Straint TDSS System and Bag</p>
<p>29) Chassis</p>	
<p>a. A copy of the completed pre-delivery inspection form shall accompany the bare chassis and accompany the bus during manufacturing as part of the build order. All standard or optional chassis equipment to be included shall be as advertised by the manufacturer and factory installed and shall not consist of substitute or aftermarket equipment. All optional equipment shall be installed per optional equipment manufacturer's instructions. Optional chassis equipment not available from the factory may be dealer installed. The chassis shall meet the following minimum requirements.</p>	<p>Complies with specification</p>
<p>b. Class I - Chassis shall have one front axle with single wheels and one rear axle with dual wheels. It shall have a driver and passenger OEM door with co-pilot seat or it shall have a driver OEM door without a co-pilot seat.</p>	<p>Complies with specification – Ford E350 Series</p>
<p>c. Class II - Commercial rated chassis shall be the highest Gross Vehicle Weight Rating (GVWR) available for the</p>	<p>Complies with specification – Ford E450 Series</p>

wheelbase and shall have one front axle with single wheels and one rear axle with dual wheels.	
30) Tilt Wheel/Power Steering	
Chassis shall be equipped with power steering and a tilt wheel steering column. The steering column shall be adjustable for various up and down positions of the steering wheel. The steering shall be a full power assist type.	Complies with specification – OEM
31) Wheel Base	
The minimum wheelbase shall be 138" (small class I) and 158" (small class II) using the wheelbase for each of the specified bus lengths which will provide proper approach and departure angles, proper handling, and proper ride characteristics. Maximum rear overhang shall not exceed 1/3 bus overall length.	Complies with specification – Ford E Series
32) Engine	
a. Small class one shall be gasoline V8, fuel injected, 445cid, 7.3L minimum	Complies with specification – Ford 7.3L V8 Premium
b. Small class two shall be gasoline V8, fuel injected, 445cid, 7.3L minimum	Complies with specification – Ford 7.3L V8 Premium
33) Transmission	
The electronically controlled transmission shall be a minimum, heavy-duty, six-speed automatic cooled by an "H.D. transmission oil cooler" in series with radiator cooler or equal (cooler capacity to match GVWR of bus). Suggested source: OEM matched to the electronic engine and chassis.	Complies with specification – Ford E Series OEM
34) Alignment	
The bus shall have a four-wheel alignment at final point of inspection at curb weight after final assembly is completed, just prior to delivery to the transit agency. Final alignment settings shall be +/- .1 degree of preferred manufacturer's alignment specification. A copy of the work order indicating the camber, caster and toe-in settings at time of final inspection shall be provided with the bus at delivery. All axle alignment required.	Complies with specification
35) Gross Bus Weight Rating	
a. Small Class One	Complies with specification – Ford E Series
i Front Axle Rating – 3,700-lb. minimum. Bus shall not exceed chassis manufacturer's rated front axle weight capacity.	
ii Rear Axle Rating, -7,800-lb. minimum. Bus axle weight shall not exceed chassis manufacturer's rear axle weight rating or spring and tire capacity.	
iii Chassis GVWR - 11,500-lb. minimum. (see Section I Purpose of Specifications.) Engineering calculated loaded bus axle weight charts are required with the bid (see section C. Vendor/Manufacturer Requirements, subsection 8. Bid Documents, item b.).	
b. Small Class Two	Complies with specification – Ford E Series
i I-Beam Front Axle Rating – 4,600-lb. minimum. Bus axle weight shall not exceed chassis manufacturer's front axle weight rating or spring and tire capacity	
ii Rear Axle Rating, - 9,450-lb. minimum. Bus axle weight shall not exceed chassis manufacturer's rear axle weight rating or spring and tire capacity.	
iii Chassis GVWR -14,200-lb. minimum. (see Section I Purpose of Specifications.) Engineering calculated loaded bus axle weight charts are required with the bid	

(see section C. Vendor/Manufacturer Requirements, subsection 8. Bid Documents, item b.).	
36) Differential	
Heavy-duty rear axle with full floating axles. Gear ratio shall allow buses to travel approximately 65 miles M.P.H. loaded, maximize fuel economy, and not exceed manufacturer's recommended engine operating R.P.M.	Complies with specification – Ford E Series
37) Battery, Cables, and Grounds	
<p>a. The battery equipment shall be furnished by the chassis manufacturer where available. The dual batteries shall be maintenance free with reserve capacity of 400 minutes @ 80° F, 950CCA or largest available from OEM minimum, 12-volt minimum. The batteries installed in the bus must be a pair of matching units.</p>	Complies with specification – Ford E Series OEM
<p>b. The batteries must be fresh, fully charged units when the finished bus leaves the manufacturing plant. Batteries that have been in the bus during the manufacturing process which were allowed to become fully discharged for a period of time shall be replaced with fresh new batteries. One battery shall be mounted under the hood the other battery shall utilize the passenger stepwell as a storage compartment. The stepwell shall remain gage number 14 (.075" thickness) stainless steel, with a stainless steel battery tray that is easily accessible with a removable step cover. The battery compartment shall be vented in a manner that prevents debris from entering and the tray shall be coated with an acid resistant coating. The stepwell shall have adequate capacity to support the battery equipment. The battery tray shall allow movement to permit full service of batteries outside of the bus body. The stepwell compartment must be marked to say "auxiliary battery inside". Recommended Battery Sources: OEM</p>	Complies with specification
<p>c. Battery positive and ground cables shall be AWG size 2/0 minimum, fine stranded, flexible copper wire with permanently affixed cable connector ends with heat shrink tubing applied. All cable ends shall be fastened in a manner equal to the method used by the chassis Original Equipment Manufacturer (OEM). Positive cable ends at the battery shall use a protective cover or cap as an added insulator. Cable assemblies installed in place of chassis manufacturer's battery cables shall be sized to match the electrical system's maximum current draw to provide proper engine starting and operation of all systems.</p>	Complies with specification
<p>d. Engine, body, and equipment grounds (properly sized) shall be installed to handle subsystem electrical capacity. For all ground wire connections; 1) paint shall be removed at the grounding point to provide a cleaned surface; 2) grounding wires and cables fastened to the frame or body structure shall use a bolt with nut installed in a proper sized hole; and 3) a coating of dielectric material shall be applied to the cleaned surfaces, cable ends, bolts, and nuts where each positive or grounding cable or wire is attached. The following is a list of grounding locations:</p> <p>i A ground of the battery cable size shall be installed between the engine and chassis frame.</p> <p>ii Between the transmission case and the chassis frame.</p> <p>iii The bus body shall be properly grounded with cables to the chassis frame in at least two places.</p>	Complies with specification

<ul style="list-style-type: none"> iv Lift pump motor shall be grounded directly to chassis frame using a cable of the same size as the pump motor feed wire. v All exterior lights and accessories, added by the body manufacturer, shall be grounded by an in-harness ground attached at a common grounding point. There may be a common grounding point in the rear of the bus to the frame along with a required grounding point at the fuse panel. 	
<p>e. All buses shall be supplied with proper radio frequency (RF) suppression equipment to reduce radio interference and improve radio transmission and reception performance. High corrosion resistance and high conductivity braided ground straps shall be added: between the engine and the chassis frame of 1" width, minimum; between the engine and the firewall of ½ " width, minimum; two between the frame and the body sections of ½ " width, minimum; and between the separate body sections of ½ " width, minimum. For all braided ground wire connections, paint shall be removed and a coating of dielectric material applied to the cleaned surfaces where each braided cable attaches as is required in other ground wire applications. All removable covers in the engine area including fiberglass hoods need to be shielded and RF grounded. All braided high corrosion resistance and high conductivity ground straps shall be as short as possible and shall use the negative battery cable attachment point (except those between separate body sections) as the termination point of the RF grounding.</p>	Complies with specification
38) Alternator	
<p>a. The alternator equipment shall be furnished by the chassis manufacturer where high output will match system needs. This system shall be a 12-volt serpentine belt drive with internal or external voltage regulator. It shall be capable of maintaining the battery at a state of full charge under all operating conditions and equipment loads, 200 amp minimum. The alternator(s) shall be supplied with proper radio frequency (RF) suppression equipment. Any bracket modifications shall not reduce the strength of the mounting bracket. Chassis alternator equipment available that is unable to meet electrical needs may be replaced by Delco/Remy, Mitsubishi, Leece-Neville, or PennTex that will meet system needs. Any non-Original Equipment Manufacturer (OEM) alternator equipment installed on a bus by the body manufacturer shall be covered by a minimum warranty period equal to the chassis OEM alternator warranty. It is the responsibility of the manufacturer (bus supplier) to match the alternator performance to the bus's electrical system needs.</p>	Complies with specification – Ford OEM
39) Engine Fast Idle	
<p>The engine shall be equipped with fast idle control which includes manual and automatic control features. Fast idle shall not activate unless the transmission control is in park (P). The control system shall have a manual switch, volt sensor, an indicator light, and activate automatically from voltage sensors. The system shall automatically deactivate when bus is shifted into gear and when the bus foundation brakes are applied. Suggested source: Chassis manufacturer's equipment, Gateway by Intermotive Products, Penntex Model PX-HI-(mod no) with time out module, Vortec MD30-2500.</p>	Complies with specification – Intermotive Gateway
40) Brakes	

<p>a. The bus foundation brakes shall be a power-actuated hydraulic split system of a four wheel disc type with a three channel anti-lock braking system. The system shall be the heaviest-duty available for stop and go operation. The brake system shall include a red brake warning lamp (RBWL) in the instrument cluster that lights when the parking brake is on, when a front or rear hydraulic failure occurs, or when brake fluid is low in the reservoir and act as a low brake warning system. The parking brake shall be re-buildable and the heaviest-duty available from the chassis manufacturer.</p>	<p>Complies with specification – Ford E Series OEM</p>
<p>b. Parking Brake – Rebuildable and repairable by trained technician, heaviest-duty available from chassis manufacturer.</p>	<p>Complies with specification – Ford E Series OEM</p>
<p>41) Fuel Tank</p>	
<p>a. Fuel tank capacity shall be the largest size available for each chassis. Fuel fill shall not extend beyond the exterior surface of the bus and may have the fuel cap set in a recess similar to a Ford OEM unit. Fuel fill shall be on the street (left) side of the bus. Fuel tank capacity shall be minimum for the following chassis/buses:</p> <p>i Small Class I: 40 gallons ii Small Class II: 55 gallons</p>	<p>Complies with specification – Ford E Series 40 and 55 gallons</p>
<p>42) Hazard Flashers</p>	
<p>Hazard flashers shall use the OEM switch and control system with an electronic flasher.</p>	<p>Complies with specification – Ford E Series OEM</p>
<p>43) Shock Absorbers</p>	
<p>Chassis shall have gas filled shock absorbers front and rear, most heavy-duty available from chassis manufacturer. It is the responsibility of the manufacturer (bus supplier) to match the shock absorber performance to the buses GVWR.</p>	<p>Complies with specification – Ford E Series OEM</p>
<p>44) Springs and Suspension</p>	
<p>a. The chassis shall be equipped with a heavy-duty tapered leaf (parabolic) spring or coil spring front suspension to match the specified gross axle weight rating.</p>	<p>Complies with specification – Ford E Series OEM</p>
<p>b. Chassis shall be equipped with a heavy-duty rear suspension to match specified gross axle weight rating.</p>	<p>Complies with specification – Ford E Series OEM</p>
<p>45) Stabilizer</p>	
<p>Chassis shall have heavy-duty OEM suspension stabilizers if available.</p>	<p>Complies with specification – Ford E Series OEM</p>
<p>46) Wheels</p>	
<p>Bus wheels (6) shall be 16.0" x 6.0" minimum, steel disc, hub piloted type, 8-hole flange nut style. Wheels shall have all stainless steel or all brass valve stems a minimum of 1½" in length retained by threaded nuts fitted with stainless steel, steel or brass valve caps with an inner air seal. Wheels shall be OEM white.</p>	<p>Complies with specification – Ford E Series OEM WHITE</p>
<p>47) Tires</p>	
<p>a. All tires (6) shall be tubeless, steel radial blackwall, single front, and dual rear. All tires shall be all season tubeless. Suggested sources: Hankook, Goodyear, Michelin XZA, Unisteel. The tires shall be the largest size available from chassis manufacturer to meet the GVWR.</p>	<p>Complies with specification – Ford E Series OEM</p>
<p>48) Driveshaft</p>	
<p>The multi-piece drive shaft shall be OEM and have full loop guards of sufficient strength to prevent any drive shaft</p>	<p>Complies with specification – Ford E Series OEM</p>

<p>section from striking the floor of the bus or the ground in the event of a tube or universal joint failure. Drive shaft guards, (OEM chassis equipment preferred, or may be installed by the chassis manufacturer) shall be secured properly and be equal in materials and design to drive shaft guarding installed on a school bus chassis. Any modifications to driveline shall not create vibrations or cause premature wear.</p>	
<p>49) Wipers and Horn</p>	
<p>Electric wipers shall be two speed, delay style, dual jet washers (electric), with manufacturer's standard arms and blades (OEM equipment preferred). Wiper motors shall be mounted for easy access and not interfere with other equipment mounted in the front bulkhead/cowl of the bus. Where individual wiper motors are used (one for each side), each shall be supplied by its own fused feed wire. The bus shall have two electric horns.</p>	<p>Complies with specification – Ford E Series OEM</p>
<p>50) Radiator and Cooling System</p>	
<p>The cooling system shall have an extra cooling capacity radiator (aluminum or copper core), water pump, pulley, and clutch-type fan with coolant recovery system with a factory installed coolant filter – if available from OEM (heavy duty system installed by chassis manufacturer). Cooling system shall be winterized with 50/50 mixture (minimum) of permanent antifreeze and distilled water or a factory premix (minimum -35°F freezing point). Coolant integrity shall be maintained throughout the manufacturing process to insure that the coolant, including additives, in the delivered bus is equal to the coolant installed at the chassis OEM factory. All cooling system hose connections in the engine compartment shall use band clamps from OEM to control leakage.</p>	<p>Complies with specification – Ford E Series OEM with Constant Torque Clamps</p>
<p>51) Fluids</p>	
<p>Fluids shall be checked and filled from inside front hood where application allows. Engine oil fill/check, transmission oil fill/check, and coolant fill/check shall be located for easy access per approval at pilot model inspection. All fluids shall be at maximum full levels at delivery.</p>	<p>Complies with specification</p>
<p>52) Engine Cover and Trim</p>	
<p>a. The engine cover shall be insulated from engine heat, engine noise, and road noise. Additional equipment, including flooring, added to the engine cover area shall not interfere with removal/installation of the engine cover.</p>	<p>Complies with specification – Ford E Series OEM</p>
<p>b. The buses shall be equipped with an OEM chrome trim package for the grill and front trim (if available).</p>	<p>Complies with specification – Ford E Series OEM</p>
<p>c. A main wiring harness with Weatherpack connectors shall be use to disconnect any switches mounted on engine cover. Preferably one main connector for all switches.</p>	<p>Complies with specification – Weatherpack</p>
<p>53) Exhaust System</p>	
<p>The exhaust shall exit the rear of the bus and be flush with the rear bumper. If bus is equipped with a rear lift door, the exhaust shall exit the rear of the bus on the street (left) side flush with left end of the rear bumper. Exhaust system discharge shall be directed to the ground not straight out the back of the bus. The exhaust system shall meet FMVSS §393.83 and current Environmental Protection Agency (EPA) requirements. The exhaust system must be installed to provide maximum ground clearance and departure angle at the rear of the bus. Any exhaust system extensions shall be of the same material</p>	<p>Complies with specification – with Ford E Series OEM – OEM Style Hangers included.</p>

as OEM exhaust system, i.e. – stainless steel. All exhaust system extension hangers shall be OEM type.	
54) Safety Items	
a. The following safety items shall be provided on each bus and items noted with an asterisk (*) shall be in a location approved by the state at pilot model inspection:	Complies with specification
b. *One current year UL listed 5 pound, 2A-10BC dry chemical fire extinguisher. Fire extinguisher shall have a metal head, a gauge to indicate state of charge, and a bracket with heavy-duty strap for securement. Fire extinguisher shall be serviceable and rechargeable for the life of the bus with metal mounting brackets. Fire extinguisher shall be shipped loose. Source: Manufacturer's Standard.	Complies with specification
c. *One container of bi-directional emergency reflective triangles that meets FMVSS 125 and shall be in a location easily accessible to the driver.	Complies with specification
d. *A 12-volt 97-db sealed solid state electronic warning alarm that is readily audible from <u>outside</u> the bus when transmission is in reverse. The alarm shall: be steam cleanable; have passed a 1 million cycle test; and meet SAE J994, OSHA, Bureau of Mines and all State Regulations. The alarm shall be mounted with bolts and properly grounded and mounted on the rear of the bus near the license plate bracket. Suggested source: OEM standard.	Complies with specification
e. *An accurate exterior height (clearance) decal shall be mounted in the driver's dash area.	Complies with specification
f. The rear door shall have an audible alarm at driver area that is energized when the rear door latch handle starts to open and when the rear door is locked with the ignition in the on or accessory position. Open door alarm shall not effect the engine operation.	Complies with specification
g. An interlock system shall be provided to ensure that the bus cannot be moved when the lift is not stowed and that the lift cannot be deployed unless the interlock is engaged (to meet ADA regulation). The interlock system shall engage when the lift operation sequence is followed. Interlock operating instructions shall be included with each bus at delivery.	Complies with specification – Intermotive ILIS
h. An OEM chassis automatic daytime headlight control system shall be provided. The system shall illuminate the headlights when the ignition switch is on and the headlight switch is off. The system shall activate automatically after engine start up with the headlamp switch off and shall deactivate automatically when the headlamp switch is on or the ignition switch is turned off.	Complies with specification - OEM
i. A low-profile, voltage regulated non-PCB product with direct overmold plastic and no air gap construction LED electronic strobe light (white) with a clear lens and branch guard shall be provided. The light shall meet SAE J1318 requirements and be mounted centrally on the roof of the bus approximately 6 feet forward of the rear of the bus. Strobe light mounting shall have free access to connector with enough room to remove connector without removing any panels. The 12 volt light shall have a control switch in the driver's area. The light shall be approximately 4" in height, produce 80 (±10) double flashes per minute, and have a light intensity of 1 million candlepower with a current draw of approximately 1 ampere. Suggested	Complies with specification – with guard – dual flash

Sources: Innotec, Meteorlite, Peterson, Target Tech Pulsator® 451, Truck-Lite	
55) Electrical	
a. All exterior non-OEM connections shall be <u>WeatherPack</u>	Complies with specification - WeatherPack
b. All wiring supplied by body builder shall have each wire permanently labeled with its function at least every eighteen inches.	Complies with specification
c. Lift equipped buses shall have a circuit breaker with a manual reset in the lift feed circuit. The circuit breaker shall be installed vertically (on the side wall) in the battery box, in the positive power cable leading to the lift power pack.	Complies with specification
d. Install a 12 volt power point for hand held equipment in the driver's area.	Complies with specification
e. All cable and wires added by the body manufacturer shall be continuous color coded and numbered or function coded. The manufacturer shall furnish complete as built wiring diagrams with integrated body and chassis wiring marked to show the codes used to include all optional equipment. Mating harnesses and harness connectors shall use matching wiring and coding unless chassis OEM wiring and coding is different from body manufacturer's. The wiring shall be designed to be a "plug and play" system where the harnesses and components are fastened through common standard terminal ends and connectors.	Complies with specification
f. Electrical panels installed by the body builders shall be located for easy access. Circuit breaker circuit protection shall be standard but blade type fuses may be used when expressly required by the component manufacturer. The master electrical panel shall use a separate "plug and play" connector and terminal system. Highest quality components available shall be used. One extra fuse shall be supplied for every amp size and style used on the bus body. All components shall be placed on the front of the electrical panel for ease of service.	Complies with specification
g. All wiring added to chassis fuse block shall be securely fastened to prevent wires from being knocked loose or loosening from vibration. The manufacturer shall use wire raceways where needed. Wiring, harnesses, and raceways shall be supported at regular intervals by "P" clamps, or by other supporting hangers where necessary, and routed in separate hangers from heater hoses or air conditioning hoses. Body fuse/electrical panel shall be sufficiently sealed to prevent intrusion of dirt and moisture.	Complies with specification
h. All wiring shall be heavy-duty; be properly grounded to body frame structure and the chassis; use a common grounding point; and be adequate for electrical system capacity. All wiring passage holes through engine cowl, floor area, and other partitions shall be thoroughly sealed to prevent dust and moisture intrusion.	Complies with specification
i. All accessories and accessory electrical equipment shall be wired through a constant solenoid energized when the bus's ignition switch is in "ignition on" or "run" mode. A master switch with light in the driver's control panel shall control this constant solenoid and act as a quiet switch overriding individual switches for accessories. This master switch is wired in series with the ignition switch to control the constant solenoid. The constant solenoid shall not control headlights, taillights, emergency lights, charging system voltage regulator energizer lead, a fused	Complies with specification

power lead for the passenger door, and a fused constant power lead for all electronic control units' long term memory.	
<p>j. All control switches, relays, and circuit breakers used for the various electrical circuits shall have a current carrying capacity adequate for the circuit that they control and shall be properly marked for their function. The illuminated switch markings shall be permanent and not wear off with switch use. Control switches shall be dimmable and positioned for easy access from driver's seat. (Location to be determined at pilot model production).</p>	Complies with specification
<p>k. All added wiring shall be installed in a properly sized and supported split open-type loom or a properly supported raceway for protection. All wiring harnesses shall have adequate length to allow for harness flexing from supporting brackets and where harnesses connect to electrical equipment. Any wiring added by splicing into an existing chassis Original Equipment Manufacturer (OEM) harness or wire shall match modification standards set forth by the chassis manufacturer, such as Ford's QVM. Any added accessories or electrical circuits shall not interfere with nor back-feed into other electrical circuits. Any excess harnesses shall be properly secured.</p>	Complies with specification
<p>l. Wiring added from OEM chassis wiring to rear lights, fuel tank, and/or other accessories shall be supported and protected from the ice and snow build-up. Wiring shall be inside bus where possible. Wiring to taillights and other exterior lights shall be long enough to remove assembly by 6" for service. Exterior connections shall be weatherproof positive lock connectors coated with dielectric grease. Suggested sources: Weather-Pak.</p>	Complies with specification - WeatherPak
<p>m. Scotch lock wire connectors are not acceptable and shall not be used for wiring installation. Terminals shall be as follows:</p> <p>i Machine crimped on wire ends shall be used on all harnesses and cable assemblies used in the production of buses. Harness assemblies shall have connectors matching a mating connector where harnesses attach to other harnesses, switches, or other electrical units. Connections made in any harness assembly shall use Sta-Kon® disconnects and splice connectors where machine applied connectors cannot be used. Connectors shall be properly crimped with Sta-Kon® tools and covered with heat shrink tubing. In-line fuse assemblies shall use spade type fuses in a Weather-Pak holder and shall be located for ease of service.</p> <p>ii All exterior wiring connectors (plug-ins) including harnesses shall be weatherproof positive lock with the connector pins applied with the proper crimping tool (Weather-Pak, Metri-Pak). All exterior ground connections, except factory supplied braided ground straps, shall have properly applied terminal ends with heat shrink insulation applied. All connections exposed to the weather shall have dielectric grease applied to prevent corrosion.</p>	Complies with specification
56) Equipment Options	
a. Air Conditioning – Split System	
<p>i The air conditioning system (AC) shall have a separate compressor, condenser, and evaporator for the front</p>	Complies with specification – See Equipment List F for details

<p>system and for the rear system (two separate systems). The systems shall be 12-volt and use refrigerant type R-134A. The systems shall be of sufficient capacity to maintain interior temperature requirements stated in the test procedure for air conditioning systems during summer operation (see section C. Vendor/Manufacturer Requirements, subsection 3. Air Conditioning Certification).</p>	
<p>ii The front AC system shall be integrated as part of the front heating/ventilating unit including the driver's area evaporator unit (complete front system may be Chassis OEM with OEM controls and sensors). The front system shall provide temperature control with sufficient cooling ventilators for driver comfort with no reliance on the rear system for front temperature control. Front and rear air flow and temperature shall be controlled by separate switches on the driver's control panel or dash panel. Front and rear systems shall have separate fan, evaporator, and compressor controls.</p>	<p>Complies with specification – See Equipment List F for details</p>
<p>iii The rear system shall have an electronic control system capable of providing automatic temperature control, freeze protection, compressor protection, and diagnostic functions. The driver's automatic temperature and system control panel shall be mounted in the driver's station. The control system shall be an integral part of the system temperature controls. The system shall be able to monitor system voltage, high refrigerant pressure, low refrigerant charge, and clutch cycling intervals and shall protect the system by controlling compressor clutch engagement. The system shall be able to interpret associated problems and provide codes for technician diagnosis. Suggested sources: ACC Climate Control Model MDS, MCC ECO Temp Lite, Thermo King Clima Aire, ProAir.</p>	<p>Complies with specification – See Equipment List F for details</p>
<p>iv Compressors: There shall be two engine mounted, serpentine belt driven air conditioning compressors. OEM chassis front system (may be chassis OEM compressor). Rear aux AC system compressor to have a minimum 13cu. displacement. Hose end metal fittings connecting hoses to the compressor shall be electro-coated steel that pass the ASTM B117 480 hour Salt Spray test (see section C. Vendor/Manufacturer Requirements, subsection 8. Bid Documents, items v.). The compressor clutch circuit shall be interrupted when abnormal pressures are detected by the pressure monitoring switches. Low pressure switch shall be located between the expansion valve and the compressor in the low pressure side of the system. The high-pressure switch shall be located between the compressor and thermal expansion valve (for TXV systems) or between the compressor and the orifice tube (for orifice tube systems) to protect the entire high-pressure side of the AC system. Suggested sources: ACC Climate Control, ProAir, Thermo King, Trans/Air; MCC Mobile Climate Control</p>	<p>Complies with specification – See Equipment List F for details</p>
<p>v Condensers: The rear system's condenser shall be roof mounted (11" or less in height) and the front system may use the Chassis OEM radiator mounted condenser. The protective external grille work for the roof mounted condenser coil fins shall not be mounted directly against the condenser fins. The condenser</p>	<p>Complies with specification – See Equipment List F for details</p>

<p>fans and motors shall be enclosed within the condenser housing. The housing shall be galvanized or aluminum with heat-fused powdered epoxy coating. The condenser coil shall be copper or aluminum tube expanded into aluminum fins or MCHX condenser. Hose end metal fittings connecting hoses to the condenser shall be electro-coated steel that pass the ASTM B117 480 hour Salt Spray test (see section C. Vendor/Manufacturer Requirements, subsection 8. Bid Documents, items v.). High pressure cut out switches shall be wired into the clutch circuit. The condensers shall be equipped with axial fans dynamically balanced with permanent magnet totally enclosed motors. The condensers shall blow air upward and toward the rear of the bus assisted by the forward motion of the bus. A refrigerant dryer and a sight glass shall be required in the system. A branch guard the same height as the condenser shall be mounted just forward of the condenser assembly on the roof of the bus which shall not restrict air flow into the condenser assembly. Branch guard shall mounted with the same hardware as the condenser. Suggested sources for roof mounted condenser: ACC Climate Control, ProAir, Thermo King, Trans/Air.; MCC Mobile Climate Control</p>	
<p>vi The front evaporator (may be chassis OEM equipment) and rear evaporator(s) shall have three-speed continuous duty permanently lubricated blower motors with sufficient CFM capacity to maintain interior temperature requirements stated in test procedure. The rear evaporator cores shall be a copper coil with aluminum fins (three rows deep, minimum), galvanized heavy-duty frame and coil end sheets with a galvanized or plastic drain pan. The rear evaporator expansion valve or orifice tube shall have "O" ring refrigerant connections. Suggested sources: ACC Climate Control, ProAir, Thermo King, Trans/Air; MCC Mobile Climate Control</p>	<p>Complies with specification – See Equipment List F for details</p>
<p>vii The driver's evaporator (may be chassis OEM equipment) shall be controlled separately from the rear passenger area evaporator. The controls shall include an on/off switch and a three-speed blower switch. The in-dash unit shall not interfere with removal or replacement of the engine cover or be blocked by the entrance door control mechanism.</p>	<p>Complies with specification – See Equipment List F for details</p>
<p>viii The passenger area evaporator system shall be separately controlled from a control station at the driver's position. The controls shall include all features described in Section 56, a, iii. The evaporator shall be ceiling mounted at the rear of the passenger compartment.</p>	<p>Complies with specification – See Equipment List F for details</p>
<p>ix The components of the air conditioning system shall be readily accessible for maintenance. Service/charging ports shall be accessible under-hood without removing any other component or item. The refrigerant hose construction shall comply/exceed SAE specification J2064 Type D or E. Refrigerant fitting construction shall comply/exceed SAE specification J2064 Type D or E. All refrigerant hose end fittings shall be electro-coated steel that will pass the ASTM B117 480 hour Salt Spray test (see section C. Vendor/Manufacturer Requirements, subsection 8. Bid Documents, items</p>	<p>Complies with specification – See Equipment List F for details</p>

<p>v.). The hose coupling end of all fittings shall include two hose barbs and two areas of elastomeric or HNBR seals. Refrigerant hose clamp construction shall: comply/exceed SAE specification J2064 Type D or E; be made of stainless steel to ensure coupling integrity; properly align hose end fitting; and clamp the hose directly over the elastomeric or HNBR seals. Refrigerant hose fittings shall be Aeroquip E-Z Clip system, ATCO Air-O-Crimp, MCC FlexCLIK.</p>	
<p>x The wiring shall meet all applicable specifications (see Section B. Body Structure and Exterior Panels, subsection 55. Electrical). The evaporator and condenser wiring (power and ground circuits) shall be properly sized to provide maximum voltage drop of 1.5v to farthest system component.</p>	<p>Complies with specification – See Equipment List F for details</p>
<p>xi Air conditioning electrical circuits shall be protected with manual resettable circuit breakers or fuses.</p>	<p>Complies with specification</p>
<p>xii The rear air conditioning system shall be supplied from the equipment manufacturer as a complete unit including controls, wiring and hoses. The whole system shall be warranted from in-service date, by the manufacturer, for a period of two years with unlimited mileage.</p>	<p>Complies with specification</p>
<p>xiii All fault codes shall be cleared upon delivery.</p>	<p>Complies with specification</p>
<p>b. Air Conditioning/Heat – Rooftop System</p>	
<p>The rooftop AC system shall meet all of the requirements of the AC split system except that the rear evaporator and heating unit shall be an integral part of the rooftop AC unit so that the condenser unit, evaporator unit, and heating unit are part of a single roof mounted unit. A coolant circulating pump shall be installed in the coolant lines for the rooftop heating unit. The auxiliary coolant heating unit and coolant pump for the rooftop heating unit shall be connected electrically to run whenever the bus's rooftop unit calls for heat. The rooftop unit shall be a free blow system installed in the central roof area of the passenger compartment of the bus with stainless steel fasteners and cover bolted down. Securement of the AC cover by means other than bolts or screws is allowed as long as <u>constant tension positive locking ¼ turn fasteners</u> are utilized. The air conditioning/heating system shall be supplied from the equipment manufacturer as a complete unit including controls, wiring, electrical protection devices, and hoses. A branch guard shall be installed to protect the roof-mounted air conditioner. The whole system shall be warranted from in-service date, by the manufacturer, for a period of two years with unlimited mileage. This system eliminates the need for the floor heater specified in Section 23. Suggested Sources: ACC Climate Control, American Cooling Technology, Inc., Thermo King, Trans/Air.; MCC Mobile Climate Control</p>	<p>Complies with specification – See Equipment List F for details</p>
<p>c. Auxiliary Coolant Heater</p>	
<p>i All buses shall be equipped with an auxiliary heater system that shall be able to preheat, provide supplemental heat, and maintain heat for the engine and the interior of the bus. The auxiliary heater system shall be supplied in heated coolant model for all</p>	<p>Complies with specification – See Equipment List F for details</p>

<p>engines. The heater system shall be complete with all fuel and electrical controls, exhaust system, and standard warranty. All auxiliary heaters shall be 12-volt units with a fused power supply and with protection for high and low voltage conditions. The auxiliary heater system shall meet FMVSS 301 fuel system integrity requirements. The heating units shall be fueled from the bus's primary fuel supply. The auxiliary heating units shall be connected electrically to run whenever the bus's rear heat exchanger fan is turned on. The on/off seven day programmable modular electronic timer controls for the heating units shall be located in the driver's area of each bus. The seven-day timer control shall be capable of a two hour preheat control, minimum, and be capable of continuous run control when the key is on with the engine running. The electrical connection shall be a one piece harness from the control switch to the heating unit with all exterior connections Weather-Pak. Location shall be determined at the Pre-Pilot Model Review Meeting.</p>	
<p>ii The heated coolant model shall be a self-contained unit mounted under the bus near the rear heating unit, and connected to the heater hoses leading to the rear heating unit. The auxiliary heating unit inlet and outlet hoses shall have 5/8" ID heavy-duty brass ¼ turn ball valves for shut off when the heater needs to be removed for servicing. It shall be in an enclosure supplied by the auxiliary heater manufacturer, be installed so that adequate ground clearance exists below the heater enclosure box, be easily accessible for servicing, be weather resistant, and be complete with mounting brackets/hardware and coolant circulator pump. The coolant circulator pump shall provide a minimum flow of 2.6 gallons per minute. The heated coolant system units shall have safety features for temperature regulating and overheat shut down switches. A seven day digital timer shall be used to control operation. The auxiliary heater exhaust shall exit just below the heater enclosure toward the rear of the bus or at the side of the bus. The coolant heater shall control coolant temperature between a low of 154°F and a high of 185°F. Coolant heater output shall operate automatically at different levels with a high heat output of 17,100 BTU/hr minimum (boost setting may be higher). Suggested sources: Espar Inc., S3 Hydronic B5CS (heated coolant), OEM, Webasto Thermo Top EVO (heated coolant).</p>	<p>Complies with specification – See Equipment List F for details</p>
<p>d. Auxiliary Air Heater</p>	
<p>i The auxiliary air heater systems provided shall be able to preheat, provide supplemental heat, and maintain heat for the interior of the bus for all engines. The auxiliary heater systems shall be supplied as a heated air model with an on/off, variable digital temperature display, and with a seven-day electronic timer control. The seven-day timer control shall be capable of a two hour preheat, minimum and be capable of continuous run control when the key is on with the engine running. The auxiliary direct heated air heater unit(s) shall be self-controlled by the electronic controller to avoid unnecessary short cycling when the OEM heating system can supply the necessary BTUs. The system control units shall be located in the driver's area of the bus and shall indicate to the operator that the heater is</p>	<p>Complies with specification – See Equipment List F for details</p>

<p>operating normally or that the heater is not operating normally and needs technical service. The direct heated air heater control shall indicate heater diagnostic codes and descriptions directly from the heaters electronic control module.</p>	
<p>ii The heater system shall be complete with all fuel and electrical controls, exhaust system, and standard warranty. Fuel pump shall be mounted per auxiliary heater manufacturer's instructions. All heaters shall be 12-volt units with a fused power supply wired directly to the battery, and with protection for high and low voltage conditions. The auxiliary heater system shall meet FMVSS 301 fuel system integrity requirements. The heating units shall be fueled by the bus's primary fuel supply. The electrical connection shall be a one piece harness from the control switch to the heating unit with weather-pak or equal exterior connections.</p>	<p>Complies with specification – See Equipment List F for details</p>
<p>iii The heated air model (with mounting brackets) shall be a self-contained unit placed in the passenger area either between the bus seat and bus floor or in a clear free space in the interior of the bus (placement shall be decided at the time of installation). Installation position shall provide free air flow towards front to back or back to front, not directed to sides or other obstructions to airflow. The heated air system shall be a variable output, multi-stage heater for all engines. The heating unit shall have, 1) 16,000 BTU heat output, minimum (high heat setting), 2) 100 CFM of air delivery, minimum, and 3) automatic cycling between heat output stages. The unit shall have automatic overheat protection. All heater systems' fuel and exhaust connections shall be made outside the passenger compartment of the bus. The auxiliary heater exhaust shall be connected to a section of rigid exhaust pipe with a down sweep that exits just beyond the body side. The heating unit shall be fueled from the bus's primary fuel supply. Suggested sources: Espar Inc., Webasto.</p>	<p>Complies with specification – See Equipment List F for details</p>
<p>e. Destination Signs</p>	
<p>i Option 1 – Roller/Curtain: A 12-volt destination sign with a motor driven movable sign curtain mechanism shall be provided which meets ADA requirements (one front sign and one side sign). The sign curtain shall be approximately 36" wide and illuminated. The sign system shall have up to 15 destinations. The sign box shall have a door to open for the operator to view the sign curtain position. The door shall be positioned for ease of driver operation. A restraint shall be installed to prevent the storage door from opening beyond 105° when the installation allows the door to swing open. Suggested source: Transign LLC.</p>	<p>Complies with specification – See Equipment List F for details - Transign</p>
<p>ii Option 2 – LED: A solid state, LED destination sign shall be provided which meets ADA requirements (one front and one side sign). Signs shall be programmable using latest version of Microsoft Windows® based software. All hardware and/or software shall be provided with the first bus purchased by each transit agency. Suggested sources: Transign LLC Destinator, TwinVision MobiLite.</p>	<p>Complies with specification – See Equipment List F for details - Transign</p>
<p>f. Donation Box</p>	
<p>A donation box (in lieu of the farebox) shall be mounted on an adequately braced stanchion; shall be located over a flat floor surface near the driver; and shall be</p>	<p>Complies with specification – See Equipment List F for details - Diamond</p>

accessible to passengers entering the bus (meet ADA requirements). The lockable donation box shall be supplied with two keys (location shall be approved by the ordering agency). Suggested source: Diamond.	
g. Running Boards/Steps & Grab-handle	
The bus shall be equipped with either driver's side steps (suggested source: chassis OEM) or a 12" wide running board. The steps or running board shall be securely attached to the chassis frame and have the capacity to support 300 pounds. When available from OEM, a grab-handle shall be supplied on the outside driver's side.	Complies with specification – See Equipment List F for details
h. Farebox Electrical Prep	
Electrical connections and wiring only (no farebox) along with support stanchion shall be supplied to the area where the standard farebox would be mounted (location shall be approved by the State at pilot model inspection)	Complies with specification
i. Limited Slip Differential	
The limited slip differential powers both wheels yet freely permits wheel speed differentiation when required during turning using standard OEM equipment.	Complies with specification - OEM
j. Rear Emergency Exit Window	
i A bus equipped with a rear exit window shall have the window opening be approximately 1,200 square inches. The rear window shall have a latching device for opening from the inside of the bus which may be quickly released but designed to offer protection against accidental release. Latches shall be located on the sides of the exit window. Lever-type latches shall be used for rear emergency exit windows and shall secure the windows tightly shut, shall be easily operated, and shall not unlatch due to vibration during normal bus operation. The latches shall be made of non-corrosive materials and be designed for minimal maintenance needs. The rear window exit shall meet federal requirements (FMVSS 217). The rear window exit shall have an audible alarm and red LED warning light connected with Weatherpack connectors at the driver's area energized when the window starts to open with the ignition on. A clear full width path of 16" minimum height shall be provided to the rear exit window. No objects shall be placed in bus which restricts passageway to rear exit window except a bench style rear seat if equipped. All emergency exits shall be marked with instructions for proper use.	Complies with specification – with alarm
ii The bus rear exit window shall have a glue-on or static adhesion wide angle view Fresnel lens to improve vision directly behind bus. Minimum size shall be 80 square inches. Suggested source: Vanguard made by 3M.	Complies with specification
k. Paint – Optional Designs	
i The bus shall have an 11" belt painted stripe (no decals). An example would be: an OEM white bus with a 11" belt stripe.	Complies with specification – PPG Paints
ii The bus shall have the roof painted a different color. An example would be: an OEM white bus with the roof painted red.	Complies with specification - PPG Paints

<p>iii The bus shall be painted a full body color, including the roof, other than OEM white. An example would be: a bus painted all red.</p>	<p>Complies with specification - PPG Paints</p>
<p>iv The bus shall have a 6", 10-year, reflective, vinyl belt stripe. An example would be: an OEM white bus with a 6" vinyl belt stripe.</p>	<p>Complies with specification – 3M</p>
<p>I. Lifts (Platform) (Meet ADA Requirements)</p>	
<p>i All lifts listed below shall meet all of the lift requirements stated in section B. Body Structure and Exterior Panels, subsection 27. Type I Lift, except lifts that have an 800 lb capacity (in lieu of the standard Type I lift)</p>	<p>Complies with specification – See Equipment List F for details - Braun</p>
<p>ii Type I: An alternate make Type I platform lift shall be offered in lieu of the standard 1,000 lb lift. Suggested sources: Braun, Ricon</p>	<p>Complies with specification – See Equipment List F for details - Braun</p>
<p>iii Type II: The Type II platform lift shall have a power operated outer barrier on the lift platform. Suggested sources: Braun, Ricon</p>	<p>Complies with specification – See Equipment List F for details - Braun</p>
<p>iv Folding Platform: The folding platform lift shall have a platform that folds in the center during stowage and the lift platform is 37" usable width and 50" usable length. The folding platform lift provides an unobstructed view from inside the bus through the lift opening. Suggested Sources: Braun Vista 2, Ricon KlearVue model K-5005 ADA</p>	<p>Complies with specification – See Equipment List F for details - Braun</p>
<p>v An alternate 1,000-pound capacity lift manufacturer shall be offered as an option for agencies.</p>	<p>Complies with specification – See Equipment List F for details - RICON</p>
<p>m. Wheelchair Securement Optional Systems</p>	
<p>i The restraint system shall be a retractor style system and comply with ADA, and the new 2016 WC 18 standard for WC-19 wheelchairs. This system shall be a single point securement system and meet the same requirements as listed in section B. Body Structure and Exterior Panels, subsection 28. Wheel Chair Securement Area. Single Point Securement System: A wheelchair single point securement system (in lieu of "L" track anchorage system) shall offer 360 degree directional usage "pucks" and shall be cast stainless steel with a 3" x 2½" bolt to be secured to the floor positions. Sealant shall be applied between the under-floor backing plate and the under-body floor for reduction in corrosion. All anchorage fasteners shall include an anti-corrosion coating and be secured from the nut assembly side of the fastener wherever possible as to reduce any loss of coating on the fastener. Measurement of the securement locations shall be 54" from front plane to rear plane within the first securement location. The single point securement system shall meet the same requirements as listed in section B. Body Structure and Exterior Panels, subsection 28. Wheel Chair Securement Area. Center pucks between securement locations can share the same center of plane but the pucks shall not be shared from each securement locations. (i.e. separate single point securement systems for each wheelchair securement area). Pucks for each location, Location #1 Location #2 etc., shall be identified with color coded debris/bolt covers available from the securement supplier. Spacing of front securement pucks shall be no less than 30". Spacing of rear securement pucks shall</p>	<p>Complies with specification – See Equipment List F for details – Q'Straint Slide-N-Click QRT 360 / AM Bruns WC18</p>

<p>be centered in the rear plane of securement area 13" to 15" apart. Each securement space shall have an additional anchorage puck as to aid in the securement of scooters or difficult mobility devices. This additional anchorage puck shall be centered between the rear anchorages. Suggested Sources: QRT 360 Q'Straint Slide N' Click, Sure-Lok, Titan 800 Slide N' Click, OMNI Slide N' Click Systems; AMF-Bruns Platinum Series WC-18 or equivalent.</p>	
<p>ii Additional Wheelchair Securement Positions: Ordering agencies shall have the ability to add additional wheelchair securement positions to the provided floor plans. The position shall match the same system as installed on the bus (L-track or 360 degree single point securement) and shall meet requirements as stated in section B. Body Structure and Exterior Panels, subsection 28. Wheel Chair Securement Area and section B. Body Structure and Exterior Panels, subsection 56. m., Wheelchair Securement Optional Systems, Seating shall be added or deducted to accommodate the additional wheelchair systems and shall meet vehicle weight requirements.</p>	<p>Complies with specification – See Equipment List F for details – Q'Straint Slide-N-Click QRT 360 / AM Bruns WC 18</p>
<p>iii Portable Oxygen tank holder to be usable with an L-Track application for easy installation and removal and shall include a release knob with visual lock indicator. Will have two anti-slip straps to contain cylinder. Shall be made of high-grade anodized aluminum. Product shall be tested to dynamic crash test at 30mph/20g. National School Transportation Specifications & Procedures, Support Equipment and Accessories, B.3 and IEP – IFSP Process, Guidelines, E.11 / Ambulance Manufacturer's Division AMD Standard 003, Oxygen Tank Retention System / Approved to the requirements of CEN standard - BS EN 1789:2007, Medical vehicles and their equipment. Suggested Sources Sure-LOK GO2</p>	<p>Complies with Specification - Sure-LOK GO2</p>
<p>iv (4) Assistive Blue loop straps shall be supplied per bus as to aid in securing difficult mobility devices. Shall match the supplying securement company.</p>	<p>Complies with specification</p>
<p>n. Two Way Radio Antenna/Power</p>	
<p>i All material and labor required for a pre-installation package for two-way radio equipment shall be furnished by the manufacturer. All equipment and accessories installed as part of the buses shall have no measurable radio frequency (RF) interference. All equipment installed on the bus must operate in its normal mode while radio transmissions are being made from an on board transmitter producing 110 watts or more of transmit power while operating in the range of 43 Megahertz (Mhz) to 900 Mhz. <u>Proper RF suppression shall be provided by the manufacturer in any equipment and accessories that can produce interference to eliminate such interference.</u> The bus frame and body shall be designed to provide no measurable radio interference (shielding) for improved radio emissions and reception performance.</p>	<p>Complies with specification</p>
<p>ii Two (2) antenna mounting plates (.060" steel minimum) shall be mounted in the roof of the bus for the purpose of providing a connection to the ground plane and providing a secure mount for the antenna. For buses with FRP composite bodies, the mounting plates may be installed in the front cap of the bus-one centered in</p>	<p>Complies with specification</p>

<p>the roof section of the cap and one centered in the left (driver's) side section of the cap. Each mounting plate must be properly positioned in relation to its ground plane to ensure proper operation of an antenna installed at that mounting point. The total thickness of the exterior shell of the bus in the mounting plate area including the mounting plate shall be no more than ½".</p>	
<p>iii Two (2) antenna ground planes, which are required for proper antenna operation, shall be mounted in each bus. All ground planes shall be radio frequency (RF) grounded to the chassis structure using high corrosion resistance and high conductivity braided ground straps of the proper size (3/8" minimum width). Ground planes shall provide a comparable area of radio transmission coverage whether buses have a FRP exterior body covering or have a FRP composite body. At each antenna access opening and mounting plate area, the ground planes shall be of proper size and shape for proper communication operations. The ground planes shall be a solid piece and operate over the range of frequencies from 43 Mhz to 900 Mhz. The ground plane material used by the manufacturer must be a durable material that can be connected to the antenna mounting plate and grounded to the chassis frame. The ground plane shall be of the proper size to protect passengers in the bus from unnecessary radiation from the transmitting antenna at the bus's antenna access openings. Antenna wiring shall be adjacent to power wiring.</p>	<p>Complies with specification</p>
<p>iv Two threaded type access holes with covers approximately 6" in diameter shall be installed at the following antenna mounting plate locations:</p> <ol style="list-style-type: none"> 1. For buses with FRP exterior body covering or FRP composite bodies the screw-type access holes may be installed in the front cap of the bus, one centered in the roof section of the cap and one centered in the left side section of the cap. Adequate space shall be provided between the installed access cover and the inner body to allow for routing of the antenna lead and its connections without interference. 	<p>Complies with specification</p>
<p>v A concealed thin wall plastic conduit, 5/8" I.D. minimum, (with antenna cable pull wire) shall extend from the antenna mounting plate locations (roof and above side window or in front cap) to the mounting location for the radio. When installed, the conduit shall have no sharp or right angle bends or be distorted to prevent insertion of the antenna lead. For both antenna mounting plate locations, sufficient space shall be left at each end of the conduit to allow easy removal and replacement of the devices attached to the cable. The antenna pull wire shall terminate behind the driver's seat with 2 feet of extra length extending into the bus interior.</p>	<p>Complies with specification</p>
<p>vi 12-Volt Power for the Two-Way Radio - The positive lead (red 8 ga wire fused at 40 amperes) for the radio connection shall be provided directly from the battery positive post. The ground lead (black, 8 ga) shall be connected directly to the chassis frame with a bolt, external tooth lock washers, and nut for fastening. Proper suppression equipment shall be incorporated in the bus's electrical system to eliminate interference with radio and television transmission and reception shall</p>	<p>Complies with specification</p>

not cause interference with any electronic system on the bus. The radio power and ground leads shall terminate directly behind the driver's seat with 12 feet of extra length extending into the bus interior or as specified by Ordering Entity.	
vii Two (2) 12 volt ignition feeds shall be provided with fuse location as close to battery as practicable.	Complies with specification
viii A split loom or other flexible wire race-way (1" minimum) shall be installed from the radio location to the dash mounted microphone control location.	Complies with specification
ix The modesty panel behind the driver shall be used for radio mounting and shall be constructed to support 60 pounds of weight. To provide for radio mounting, a 5" minimum distance shall be provided between the driver's seat and the modesty panel when the driver's seat is in its most rearward travel position.	Complies with specification
o. Stereo/Radio and Public Address System	
i Option 1: An AM/FM stereo radio system shall be installed in the dashboard area within reach of the driver. At a minimum, the stereo system shall have an illuminated or LCD display along with controls for power, tuning, volume, and the ability to turn off sound to the rear speakers. A total of four (4) speakers shall be installed in the bus with two (2) speakers mounted in the front (audible to the driver and front passengers) and two (2) speakers mounted in the top rear wall of the bus. Suggested sources: OEM	Complies with specification - OEM
ii Option 2: A public address (PA) system shall be installed in the dashboard area within reach of the driver and utilize a hand held microphone. At a minimum, the PA system shall be equipped with controls for power and volume. A total of two (2) speakers shall be mounted with one in the front and one in the top rear wall of the bus. Suggested sources: Custom Radio Corporation model PA6, Jensen, Mobile Page Model 470, REI	Complies with specification
iii Option 3: A combined AM/FM stereo radio and a public address system shall be installed with four (4) speakers. The combined system shall meet or exceed the specifications outlined in option 1 and option 2. The speakers shall be mounted per locations specified in option 1. Suggested Sources: Jensen, Panasonic, REI	Complies with specification
iv Option 4: Additional speakers shall be offered at locations requested by the ordering agency.	Complies with specification
p. Raised Floor (No Wheel Wells)	
The bus shall be equipped with a raised floor where no wheel wells are showing in the rear of the bus. The raised floor shall not cause changes to any other requirements as stated in this specification. In addition, the stepwell shall meet the same requirements as specified in part 4, section A. <u>The steps shall all be in line located in the passenger stepwell.</u>	Complies with specification
q. Entrance Stepwell Heater	
The entrance stepwell shall include a 12-volt electric heating element/unit for the lower step to prevent icing of entrance steps. The low voltage step heater shall consist of one or more wire elements laminated and vulcanized between two plies of .026" silicone rubber impregnated fiberglass cloth to maintain an approximate temperature of 160° F with a low temperature (30°F) sensing switch	Complies with specification

<p>(Warm Welcome® by Lighthouse International, Ltd.; Ultra Heat). The entire lower step heating unit with power wires shall be enclosed between the stepwell and the step tread (beneath the step tread) of the lower step. Lead wires shall be loomed, supported by brackets, and protected by grommets where they pass through structure. The heaters shall be thematically controlled.</p>	
<p>r. Manual Entrance Door</p>	
<p>The manufacturer shall provide a heavy duty manually-operated passenger entrance door with control handle located in the driver's compartment within easy reach of the driver. The passenger entrance door shall not extend below the step frame. All exposed door frame structure shall be made of 304 stainless steel acid-etched, coated with zinc based primer and powder coated OEM white (including the fasteners). The door shall be located on the right side of the bus behind the right front wheel. The entrance door shall provide a 30" clear width opening, minimum, with all handrails installed. Door opening height from the top of the first step to the door header shall be a minimum of 76".</p>	<p>Complies with specification – A&M</p>
<p>Passenger entrance door shall be a double-folding, split-type double leaf swing door. This door shall have a flexible soft rubber cushion on the meeting edge 1 1/2" in width, minimum. The door glass shall be see-through, tinted (AS-2) safety glass. Under all operating conditions and bus speeds, an airtight and dust-proof seal shall be formed between the door and the stepwell, between the door and body opening, and between the door leaf sections.</p>	<p>Complies with specification – A&M</p>
<p>A method shall be provided to lock the bus when the bus is parked.</p>	<p>Complies with specification</p>
<p>s. Seating (Additions and Deductions)</p>	
<p>i On buses with a rear exit window, forward facing seating for five passengers shall replace two double place forward facing seats at the rear wall of the passenger compartment increasing the passenger capacity by one. The five passenger seating shall be available for buses without a lift or with the lift forward of the rear axle (no wheelchair lift and/or securement location at the rear of the bus). The five passenger seat shall be 88" minimum width and shall not be equipped with grab handles.</p>	<p>Complies with specification – Freedman Seating Co.</p>
<p>ii The Ordering Entity shall have the ability to add or deduct seats from the provided floor plans.</p>	<p>Complies with specification – Freedman Seating Co.</p>
<p>iii All additional transit style seats shall be of the same design and color as the other passenger seats, shall be equipped with passenger seat belts, and shall meet requirements stated in section B. Body Structure and Exterior Panels, subsection 16. Driver's Seats, and subsection 19. Seat material.</p>	<p>Complies with specification – Freedman Seating Co.</p>
<p>t. Driver's Power Seat Base</p>	
<p>Provide a six-way power seat base for standard driver's seat that allows for fore and aft, up and down, front tilt and rear tilt for the driver if available from OEM. Suggested source: Chassis Original Equipment Manufacturer (OEM) Deluxe Power Seat Base.</p>	<p>Complies with specification – Ford OEM Power Seat</p>
<p>u. Alternative Engines</p>	
<p>i Liquefied Petroleum Gas (LPG) or Compressed Natural Gas (CNG) The bus shall accept liquefied petroleum gas (LPG) or compressed natural gas</p>	<p>Complies with specification – Ford OEM 91G Gaseous Prep Engines. See equipment list for greater details.</p>

<p>(CNG)(Class II only) application if required for fleet compliance by federal Environmental Protection Agency (EPA) alternate fuel application guidelines. The engine/chassis shall include a gaseous fuel preparation package and the cylinder heads shall have hardened valve seats. LPG systems shall be either bi-fuel or dedicated LPG per ordering entity choice. All LPG and CNG conversions shall maintain OEM powertrain warranties.</p>	
<p>ii On buses ordered with alternate fuels options (LPG, CNG, etc.) auxiliary heater systems installed shall meet the same specifications for the systems operating on gasoline. All heated air models shall have a 12-volt heater booster pump installed in the coolant line forward of the first rear heater. Additional equipment needed for auxiliary heater shall be included in the option. Suggested sources: Bergstrom 863040</p>	<p>Complies with specification</p>
<p>v. Stop Request System</p>	
<p>i An interior "Stop Requested" sign, chime, and driver signal activation system shall be installed, and activated by 1/8" diameter yellow cord mounted on the side wall even with the bottom of the tip-in-transom portion of the windows. Signal touch buttons mounted in an ADA mandated wheelchair accessible area shall be no higher than 4' above the floor, with no exposed wiring. A single "stop request" chime shall sound when the system is first activated and a tell-tale light indicator on the driver console will stay light continuously until the passenger door is opened. A double chime shall sound when the system is first activated from wheelchair passenger areas.</p>	<p>Complies with specification</p>
<p>ii A "Stop Requested" message in Helvetica medium red letters on a clear plexiglass background shall be illuminated when the passenger "Stop Requested" system is activated. The "Stop Requested" message shall remain visible until doors are opened. The sign unit shall be flush mounted on the front destination compartment door and the message shall be visible to the seated operator and all seated passengers. The operator shall be able to deactivate the signal system from the operator's area as well as automatic deactivation each time the passenger door is opened.</p>	<p>Complies with specification</p>
<p>w. Back-up Sensor System</p>	
<p>A rear back-up sensor system shall be installed with a minimum of four water-resistant and corrosion resistant sensors flush-mounted to the rear bumper (painted to match the bumper). The system shall automatically engage when the vehicle is in reverse and warn of objects and/or people up to a distance of seven feet (minimum). The system shall utilize an LED monitor, mounted within view of the driver, which displays the distance (in feet) from the object(s). The system shall also emit a pulsating alarm or beep that is audible to the driver as the vehicle approaches the object(s) and then the system shall emit a steady alarm within at a minimum of 1.5 feet from the object(s). Suggested Sources: Ackton Transportation Technologies, American Road Products, Intermotive Hawkeye, ROSCO</p>	<p>Complies with specification – Intermotive Hawkeye</p>
<p>x. Back-up Camera System</p>	
<p>Back-up camera system shall comply with all FMVSS 111 requirements. System shall include the following:</p>	<p>Complies with specification - Rosco</p>

i. 7-inch LED color monitor with internal speakers, support up to three (3) cameras	Complies with specification
ii. Rear camera shall at a minimum have audio, IP69K dust and water rating, built-in microphone, shock rating of 50g @11ms (vs. 100g in specs) minimum and vibration rating 2@ 10hz-1,0000Hz, 130 degree viewing angle minimum	Complies with specification
iii. Harness with heavy-duty twist lock connectors	Complies with specification
iv. Two-year warranty on complete system	Complies with specification
y. Video Surveillance System	
i. The onboard digital video surveillance system shall include a six channel (minimum) mobile rated digital video recorder (DVR) that can be configured for a one to four camera system. Video surveillance system shall not be wired through the Master Disconnect Switch. The on-board DVR System shall include a lockable/removable 1 terabyte (minimum) hard disk drive caddy. USB data ports, analog audio/video RCA out terminals, a 10/100base-T Ethernet port, two analog audio/video (RCA) outputs, eight vehicle sensor inputs, a GPS input and one accelerometer input. The DVR shall begin recording at the start of the "engine run" switch of the vehicle or be programmable to begin recording at a specified time prior to "engine run" switch being activated. The DVR can remain functional up to 99 minutes after the ignition has been turned off, and shall record continuously without operator assistance. The DVR shall be able to retrieve video by alarm, calendar based date, time and camera search functions. The DVR shall be capable of a display resolution of 720 x 480. The DVR shall be constructed with a rugged outer housing that protects against shock, moisture and dust. System shall perform to standards in various temperature extremes of a range between -20°F to 95°F.	Complies with specification - See Equipment List F for details
ii. An accelerometer shall document hard breaking and other erratic driving events. A panic button or event marker shall also be installed within reach and view of the driver.	Complies with specification - See Equipment List F for details
iii. Sensors shall record bus signals including turn, hazards lights, and lift operations at a minimum.	Complies with specification - See Equipment List F for details
iv. A GPS receiver shall continuously monitor bus location, heading, and speed, as well as configurable and automatic time and date synchronization. The GPS antenna shall be roof mounted or as specified by Ordering Entity.	Complies with specification - See Equipment List F for details
v. Microsoft® Windows compliant viewing software shall be included with the first bus delivered to the agency. Software shall be able to view and search video from the hard drive, display a GPS map, graph speed, and save the videos.	Complies with specification - See Equipment List F for details
vi. Interior and exterior cameras shall be full color, high definition, wide angle (minimum 120°) infrared and shall supply an image that is clear and stable, free from vibration. Images shall be able to be used to positively identify a passenger riding in a vehicle. The interior cameras shall also have a high sensitivity microphone. Ordering agencies shall have the flexibility to position cameras. Below is a list of interior locations and optional cameras:	Complies with specification - See Equipment List F for details

<ol style="list-style-type: none"> 1. Two Camera System: A two camera system shall be provided capturing the driver, passengers, stepwell, and farebox/donation box at a minimum. 2. Four Camera System: The four camera system shall include the camera locations listed in option one and include a cameras capturing wheelchair lift and a rear passengers at a minimum. 3. Six Camera System: A six camera system shall include an eight channel (minimum) DVR and a one terabyte minimum hard drive. Camera locations shall be same the two and four camera system with the addition of another interior camera (located at the requested of the ordering agency) and an exterior camera facing forward capturing the passenger door. 4. Additional Interior Cameras: Ordering agencies shall have the ability to order additional cameras and select a location at time of order. Additional cameras shall include all additional wiring and mounting hardware. 5. Exterior Cameras: Ordering agencies shall have the ability to order exterior cameras and select a location at time of order. Additional cameras shall include all additional wiring and mounting hardware. 6. DVR system upgrade shall provide an option to upgrade the DVR system to an eight channel one terabyte hard drive minimum. 7. Back-up monitor system shall include active monitor in driver's station for programing and shall be operational when vehicle is in reverse. 8. <u>Correct time and date shall be programmed in system upon delivery.</u> 9. Suggested sources: Radio Engineering Incorporated (REI), SEON, SafetyVision, AngelTrax 	
<p>y. Video Surveillance Preparation Package</p>	
<p>i A video surveillance preparation package shall be offered (less cameras and digital video recorder system) allowing for one to four camera locations. The preparation package shall include the installation of camera wiring or conduit, DVR electrical connections, location for the DVR, and access covers for camera mounting/locations. Ordering agency shall specify the camera system to use and have the flexibility to position cameras.</p>	<p>Complies with specification</p>
<p>ii Vendor shall supply all materials.</p>	<p>Complies with specification</p>
<p>z. Rear Suspension Assist System</p>	
<p>Chassis shall be equipped with a heavy-duty rear suspension fitted with a rubber shear spring suspension that works in conjunction with the OEM chassis leaf spring suspension to match the specified gross axle weight rating. The added suspension shall consist of a spring carrier assembly, a frame hanger assembly, and rubber shear springs, and shall be installed in place of the original spring hanger and shackle assembly at the aft end of the drive axle leaf spring. The frame hanger must bolt into the existing Original Equipment Manufacturer (OEM) spring hanger holes in the frame. MOR/ryde® "RS" Suspension System. In addition to the MORryde RS Suspension System, the OEM chassis front and rear</p>	<p>Complies - MOR/ryde® "RSX" Suspension System</p>

shock absorbers shall be replaced with performance monotube gas pressurized shock absorbers, and the OEM drive axle sway bar shall be upgraded to a larger diameter heat treated sway bar with polyurethane bushings (where applicable). The complete system must not alter the specified gross axle weight ratings of the OEM chassis. MOR/ryde® "RSX" Suspension System	
aa. Spare Tires	
A spare tire option shall be offered for both the steer and drive axle tires if they are of different tread design. Spare tire shall match brand and specifications on delivered vehicle.	OEM Matching - Complies
bb. Entry Door Grab Handles	
Each bi-folding entry door section shall have a yellow grab handle mounted midway up to assist passengers.	Complies - Yellow
cc. Interior Mirror	
Interior mirror (with adjustable mounting bracket) shall be a 6" by 8" minimum convex mirror glass with rounded corners, minimum. The driver shall be able to adjust the mirror from the driver's seat so that the complete passenger compartment can be viewed through interior mirror. Mirror mounting points shall be reinforced when not in a structural frame member, with location approval by the State at the time of pilot model inspection. Suggested source: B&R Manufacturing, ROSCO (with bracket).	Complies with specification
dd. Wheelchair Lift Barriers	
Plexiglass barriers shall be installed on stanchions on both front and rear of lift to prevent pinch injuries in lift assembly.	Complies with specification
ee. Ceiling Handrails	
i. Two full length transit-type ceiling handrails shall be provided and securely attached to roof structure. The handrails shall be a minimum of 1¼" outside diameter, brushed finish, stainless steel including mounting brackets and fittings. The handrail ends shall curve toward and terminate at the ceiling. All handrails shall meet ADA regulation in 49 CFR Part 38, Subpart B-- Buses, Vans and Systems, §38.29 requirements for position and size.	Complies with specification
ii. All handrail mountings shall have steel reinforcement plates welded to or imbedded in structure behind surface panels of sufficient strength to withstand passenger force. Final locations shall be determined at pilot model production.	Complies with specification
ff. Slide-out Battery Tray	
The second battery shall be mounted on a slide-out tray with nonmetal battery hold down secured with bolts. Both batteries shall have a protective cover over the positive charge. The tray, covers, slides and rollers shall be stainless steel. The slide-out tray shall be mounted on properly supported mechanism, all of which shall have adequate capacity to support the battery equipment. The battery slide-out tray shall allow movement to permit full service of batteries outside of the bus body. The inside of the battery compartment shall be covered with a durable insulating material to prevent electrical shorts. The totally	lies with specification – Standard Equipment

<p>enclosed battery compartment shall be vented, and the tray shall be coated with an acid resistant coating. The battery compartment must be located below the floor line with adequate reinforcement brackets mounted to floor supports. The battery compartment shall be fitted with an insulated standard exterior access door to prevent accidental grounding with hinge and quarter-turn, non-corrosive metal, thumb latches with positive stop mechanism or flush pull-style latch(es) (SouthCo Model #M1-61-1), which match latches on other compartment access doors. The battery box compartment must be marked to say "auxiliary battery inside"</p>	
<p>gg. Bike Rack</p>	
<p>Rack shall be constructed of stainless steel and be capable of storing two standard 48" WB bicycles. For reduced operating costs, it shall have a modular design with individually replaceable components. The bicycle rack shall accommodate conversion to accept fat tire bicycles. Suggest source: Sportworks, Byk-Rak</p>	<p>Complies with specification Sportworks</p>
<p>hh. Yellow energy-absorbent, vandal-proof grab handle mounted to the top of each seat back (two per double seat). Grab handles are not required on seats that have a back against a wall.</p>	<p>Complies – in lieu of black.</p>
<p>ii. Cruise Control</p>	
<p>OEM chassis cruise control shall be provided if available</p>	<p>OEM Chassis Cruise Control</p>
<p>jj. Alternate Flooring Manufacturer</p>	
<p>Shall be offered as an option for agencies and shall meet all specifications in B. Body Structure and Exterior Panels, subsection 6. Flooring</p>	<p>Complies with specification</p>
<p>C. VENDOR/MANUFACTURER REQUIREMENTS</p>	
<p>1) Bus Information Furnished</p>	
<p>Bus information in this section shall be submitted and reviewed at the pre-pilot model review meeting, at final pilot model production. Bus information identified by " * " shall also be supplied with each bus at delivery where indicated. All manuals shall be provided in an electronic copy (CD, DVD, or USB flash drive). The Contractor/manufacturer shall maintain record or proof that all bus information was supplied to the transit agency.</p>	
<p>a. Copy of manufacturer's statement of origin for a bus.</p>	<p>Complies with specification</p>
<p>b. * Warranty papers for chassis, body, and additional equipment with each bus at delivery.</p>	<p>Complies with specification</p>
<p>c. * Data sheet to include make, model, and serial numbers of all optional equipment.</p>	<p>Complies with specification</p>
<p>d. * As built drawings showing color coded wiring schematics of all electrical circuits, body, and chassis with each specific bus at delivery. Wiring drawings shall be a in an electronic copy (CD, DVD, or USB flash drive).</p>	<p>Complies with specification</p>
<p>e. * Operator's manual for bus and all add-on equipment with each bus.</p>	<p>Complies with specification</p>
<p>f. * A complete set of repair manuals (and up-fitter manual if available from OEM) for the chassis and a manufacturer's parts manual for the body, and auxiliary equipment for the first bus of each model year delivered to each transit agency. Repair manuals shall be a in an electronic copy</p>	<p>Complies with specification</p>

VENDOR

(CD, DVD, or USB flash drive) as soon as available from OEM.	
g. * Drivability and emissions manual for the first bus of each model year delivered to each transit agency.	Complies with specification
h. * Bus operating instructions showing controls and operation for <u>the first bus</u> delivered to each transit agency and also in an electronic copy (CD, DVD, or USB flash drive).	Complies with specification
i. * Standard manufacturer's production option sheet(s)/decal(s) for chassis and body shall be installed in manufacturer's standard location, with no holes or rivets obscuring writing and numbers. Sheet shall include rear axle ratio. A paper copy of the service broadcast sheet for chassis shall also be provided with each bus.	Complies with specification
j. * Maintenance and inspection schedule incorporating the required maintenance and inspection of the basic bus and its subsystems (i.e., wheelchair lift) with each bus at delivery.	Complies with specification
k. * Proof of bus suspension alignment (work order or bill) at final bus inspection and with each bus. Four wheel alignment shall include adjustments to front and rear suspension and steering parts so that axle alignment, camber, caster, and toe settings are within +/- .1 degree manufacturer's alignment specification.	Complies with specification
l. * Proof of undercoating (warranty) at final bus inspection and with each bus.	Complies with specification
m. * Front end and rear towing and lifting instructions with each bus.	Complies with specification
n. * Wheelchair securement product instructions and training program.	Complies with specification
o. * The bus manufacturer shall provide air conditioning system performance certification (see section C. Vendor/Manufacturer Requirements, subsection 3. Air Conditioning Certification).	Complies with specification
p. * The bus manufacturer shall provide test results that certify the performance of the heating/ventilating system (see section C. Vendor/Manufacturer Requirements, subsection 4. Heating/Ventilating Certification).	Complies with specification
2) Manufacturer Quality Control	
a. Bus contractor/manufacturer shall provide a plan for quality control during bus construction and include the plan as part of the bid documents. Bus contractor/manufacturer shall also provide the name of the chief of quality control for bus construction.	Complies with specification – Included in proposal
b. The contractor shall establish and maintain an effective in-plant quality assurance organization. It shall be a specifically defined organization and should be directly responsible to the contractor's management and completely independent from production. The quality assurance organization shall exercise quality control over all phases of production from initiation of design through manufacture and preparation for delivery. The organization shall also control the quality of supply articles. The quality assurance organization shall verify inspection operation instructions to ascertain that the	Complies with specification – Included in proposal

<p>manufactured product meets all prescribed requirements. The quality assurance organization shall detect and promptly assure correction of any conditions that may result in the production of defective transit buses. These conditions may occur in design, purchases, manufacture, tests or operations that culminate in defective supplies, services, facilities, technical data, or standards. The contractor shall maintain drawings and other documentation that completely describe a qualified bus that meets all of the options and special requirements of this procurement. The quality assurance organization shall verify that each transit bus is manufactured in accordance with these controlled drawings and documentation.</p>	
<p>c. The contractor shall ensure that all basic production operations, as well as other processing and fabricating, are performed under controlled conditions. Establishment of these controlled conditions shall be based on the documented work instructions, adequate production equipment, and special work environments if necessary. A system for final inspection and test of completed transit buses shall be provided by the quality assurance organization. It shall measure the overall quality of each completed bus. A system shall be maintained by the quality assurance organization for identifying the inspection status of components and completed transit buses. Identification may include cards, tags, or other quality control devices. Inspection stations shall be at the best locations to provide for the work content and characteristics to be inspected. Stations shall provide the facilities and equipment to inspect structural, electrical, hydraulic, and other components and assemblies for compliance with the design requirements. Stations shall also be at the best locations to inspect or test characteristics before they are concealed by subsequent fabrication or assembly operations. These locations shall minimally include, as practical, under-body structure completion, body framing completion, body prior to paint preparation, water test before interior trim and insulation installation, engine installation completion, under-body dress-up and completion, bus prior to final paint touch-up, bus prior to road test, bus final road completion and presentation to resident inspectors. Tests shall be performed by the bus manufacturer to ensure that the unit is dustproof, water-tight, fumeproof, and that all bus fluids are per specifications. The quality assurance organization shall be responsible for presenting the completed bus to the resident inspectors. Sufficiently trained inspectors shall be used to ensure that all materials, components, and assemblies are inspected for conformance with the qualified bus design.</p>	<p>Complies with specification – Included in proposal</p>
<p>d. The State and/or the Ordering Entity may be represented at the contractor's plant by resident inspectors. They shall monitor, in the contractor's plant, the manufacture of transit buses built under this procurement. The contractor shall provide office space for the resident inspectors in close proximity to the final assembly area. This office space shall be equipped with desks, chairs, outside and</p>	<p>Complies with specification</p>

interplant telephones, and other items sufficient to accommodate the resident inspector staff. Inspectors shall have lifting equipment available for raising vehicles for under vehicle inspections.	
3) Air Conditioning Certification	
<p>a. The bus manufacturer shall provide air conditioning system performance certification at delivery (conducted by an independent laboratory, or testing agency, or the air conditioner manufacturer and supported by documentation of the actual test on the pilot model bus) that the air conditioning system installed in the bus meets or exceeds performance levels required by these specifications. Tests shall be performed on all classes of buses. Tests shall be with OEM and optional systems combined.</p>	Will comply with specification
<p>b. The air conditioning system performance testing shall be conducted using a heating chamber of sufficient size to contain the basic bus, to heat soak the bus at 100°F for 4 hours minimum, to simulate sun load entering windshield, and to maintain 100°F exterior temperature continuously after heat soak during testing. <i>Four hour soak will commence once bus internal temperature reaches 100°F.</i> An interior temperature of 72°F ($\pm 3^\circ\text{F}$) must be reached within 30 minutes from the beginning of the test. Engine speed shall be maintained at 1300 RPM (± 200 RPM) during the test.</p>	Will comply with specification
<p>c. Instrumentation for temperature monitoring of the bus interior shall be a minimum of 3 points in the passenger area 30" above the floor - one in driver's area, and one at the mid-point of the bus, and one at the rear seat area. Evaporators' air inlet and air outlet temperatures shall be recorded. Instrumentation and recording equipment shall be able to monitor all points, record data at one minute intervals, and print a data report.</p>	Will comply with specification
4) Heating/Ventilating Certification	
<p>a. The bus manufacturer shall provide test results at delivery, that certify the performance of the heating/ventilating system as installed in the bus meets or exceeds performance levels required by these specifications. Tests shall be performed on all classes of buses. The test should be conducted by an independent laboratory or testing agency and supported by documentation of the actual tests on the pilot model bus. Testing may be performed in natural cold climate conditions. Tests shall be performed on all classes of buses.</p>	Will comply with specification
<p>b. The bus will be cold soaked at 0°F (+/- 3°F) for 4 hours minimum. An exterior temperature of 0°F (+/- 3°F) shall be maintained during the test. An interior temperature of 64°F (+/- 3°F) must be reached within 30 minutes from the beginning of the test. Engine speed shall be maintained at 1300 RPM (+/- 200 RPM) during the test. No dynamometer will be used.</p>	Will comply with specification
<p>c. Instrumented monitoring for the bus interior temperature to determine pass/fail, shall be a minimum of three points located front, center, and rear in the passenger area 30" above the floor. Additional monitoring points shall be;</p>	Will comply with specification

one in driver's area at knee level 22" above the floor, at front heater's air inlets and air outlets, and at rear heater's air inlets and air outlets. Other temperature monitoring points shall be: engine operating (coolant) at radiator; engine outlet to rear heater; rear heater return to engine; and exterior ambient.	
d. Coolant flow shall be monitored from the engine outlet to the heaters only. Supplemental heat shall be supplied to raise engine to normal operating temperature. Supplemental heat shall be engaged 60 minutes prior to the start of the test. Instrumentation and recording equipment shall be able to monitor all points, record data at one minute intervals, and print a data report.	Will comply with specification
5) Purchaser Inspection	
The State and/or the Ordering Entity reserves the right and shall be at liberty to inspect all material and workmanship at all times during the progress of the work, and shall have the right to reject all material and workmanship which do not conform to the specifications or accepted practice. Where a resident inspector is used, upon the request to the quality assurance supervisor, the resident inspectors shall have access to the Contractor's quality assurance files related to this procurement. These files shall include drawings, material standards, parts lists, inspection processing and records, and record of defects.	Will comply with specification
6) Warranty	
a. Warranty shall become effective on the date the bus is placed into service by the Ordering Entity. Warranty service performed at the manufacturer's facilities at the manufacturer's request shall have all costs covered by the manufacturer. Warranty for the bus shall be the following as a minimum:	Complies with specification – See warranty details included in proposal
b. OEM on chassis.	Complies with specification – See warranty details included in proposal
c. OEM on transmission.	Complies with specification – See warranty details included in proposal
d. Three (3) years on body structure, exterior, undercoating, rustproofing, and paint.	Complies with specification – See warranty details included in proposal
e. Eighteen (18) months or OEM on lift, whichever is greater.	Complies with specification – See warranty details included in proposal
f. All wiring shall be warranted for one 1 year from date bus is put into service.	Complies with specification – See warranty details included in proposal
g. Manufacturer's standard warranty or one (1) year, whichever is greater, on other add-on components and items.	Complies with specification – See warranty details included in proposal
h. The chassis, body, and all add-on components shall be warranted by the successful contractor.	Complies with specification – See warranty details included in proposal
7) Miscellaneous	
a. The Contractor shall furnish the State with the delivery schedule of chassis to the Contractor and a delivery date of completed buses within 30 calendar days from date of order.	Will comply with specification
b. Any in-line equipment changes shall have prior written approval of the State.	Will comply with specification

c. The Contractor shall supply the bus turning radius: wheel-to-wheel and wall-to-wall.	Complies with specification – included in proposal
d. The Contractor shall furnish warranty procedure instructions and necessary forms used by customers to obtain necessary warranty repairs.	Complies with specification – included in proposal
e. The manufacturer(s) shall produce as the pilot model the first bus ordered by the State for its transit agencies. The bus shall be: 1) lift equipped, 2) air conditioned, and 3) the largest size on request by the transit agencies. All necessary testing and equipment placement shall be performed on the pilot models before final inspection/acceptance by the State (see Schedule A Statement of Work, section 7.2 Inspection, a. Pilot, Production Model, and Plant Inspections). The pilot model shall serve as a standard for the following units as ordered but shall not relieve the contractor from an obligation to manufacture all units in compliance with all specifications and granted/approved exceptions.	Will comply with specification
8) Bid Documents	
<u>The bidder shall supply the following with the bid quotation and class of bus (if applicable). Failure to submit could result in a bid disqualification:</u>	Complies
a. The Michigan request for proposal (RFP) and bus specification forms completed in detail.	4 - Schedule A - Statement of Work 3 - Standard Contract Terms 5 – Schedule C – FTA Clauses Eldorado 6 - Schedule D - Affidavit for Driver Delivery 9 - Schedule F – METAL - Equipment Checklist 7 - Schedule B – Small Bus Specifications AD2 10 - Schedule G – METAL - Pricing AD2
b. Bus floor plans indicating dimensions and showing the interior layout of the bus. The plan shall include wheelchair placement, stanchion locations, engineering calculated loaded bus axle weights, and be drawn to scale for all configurations.	B - Champion Class 1 Floorplans and Weights B - Champion Class 2 Floorplans and Weights
c. Detailed engineering drawing for the design of the entrance door and door-opening device.	C – Door Champion Class 1 C – Door Champion Class 2
d. Detailed engineering drawing for the design of the entrance step configuration.	D - Stepwell Drawing Champion
e. Roof, sidewall, and flooring drawings showing structure and structural specifications indicating metal size and type used. Include side sheathing and inside panels.	E - Roof Sidewall Floor Champion
f. Manufacturer's chassis description (specifications).	F - Ford Chassis Specs Class 1 F - Ford Chassis Specs Class 2
g. Detailed engineering drawings of the body to chassis frame mounting.	G - Body Mounting Champion
h. All bidders must supply manufacturer's technical specifications for wheelchair lifts and wheelchair restraints. Manufacturer's sales literature is acceptable if it contains the technical specifications.	H – Lift and Restraint Specifications
i. The warranties for body, chassis, and drive train.	I – Warranties Champion

<p>j. If applicable, as required by Title 49 of the CFR, Part 663 – Subpart D, a copy of the manufacturer's self-certification information concerning the bus's compliance with relevant Federal Motor Vehicle Safety Standards (pre-award)</p>	<p>J - FMVSS Certifications Champion</p>
<p>k. A copy of the Bus Rollover Protection Test (FMVSS 220) results of the bus offered as specified in the bid.</p>	<p>K - FMVSS 220 Champion</p>
<p>l. Completed Schedule C – Federally Required Contract Clauses shall be attached to bid quotation.</p>	<p>5 - Schedule C - FTA Clauses - Champion</p>
<p>m. Buy America analysis of manufacturer's list of component and subcomponent parts (pre-award).</p>	<p>M - PREBUYAMERICA_ Champion</p>
<p>n. The technical data sheet including flammability and smoke emissions for the seat covering material supplied.</p>	<p>N - Seat Material Flammability</p>
<p>o. Seat frame Salt Spray, humidity and impact resistance tests' results</p>	<p>O - Salt Seats YN208Q_Interpon A2000</p>
<p>p. Certification test data showing that the seats, the seat belts, and the installation are in compliance with FMVSS-207, 208, 209, and 210 where applicable for the bus model being offered in this bid.</p>	<p>P - Seat Belt Certs</p>
<p>q. Technical data sheet for the seat cushion foam supplied.</p>	<p>Q - Seat Foam</p>
<p>r. Certification that the wiring and the switches for air conditioning and all add-on components are adequate to withstand transient loads expected.</p>	<p>R - Champion WiringSwitch</p>
<p>s. Proof of valid motor vehicle dealer licensing from state, county, or municipality.</p>	<p>S - Dealer License Michigan</p>
<p>t. A copy of the dealer agreement between the Bus Manufacturer and the designated bidder.</p>	<p>T - Dealer Agreement Champion</p>
<p>u. Certification that the bus model offered is a 5 year or 150,000 mile (small class one) or 7 years/200,000 mile (small class two) bus and will meet the requirements of Federal Register Rules and Regulations 49 CFR Part 665, Bus Testing Program. Stating from § 665.13 Test Report and Manufacturer Certification, Section (b)(1), "A manufacturer of a new bus model or a bus produced with a major change in component or configuration shall provide a copy of the test report to a recipient during the point in the procurement process specified by the recipient".</p>	<p>U - Altoona Propane ROUSH U - Altoona Champion Test Class 1 Ford E350 Chassis U - Altoona Test Class 1 Champion U - Altoona Test Class 2 Champion Ford E450 Chassis U - Altoona CNG System U - ICOM Bi-Fuel Altoona report U - Altoona Ford 7.3L Engine U - Altoona Test Class 1 FTA Determination Letter</p>
<p>v. Certification for 480-hour salt spray test per ASTM procedure B-117.</p>	<p>VWX – Metal Salt Spray Tests VWX - Salt Spray 1000 hour Champion</p>
<p>w. Certification for 1,000-hour salt spray test per ASTM procedure B-117.</p>	<p>VWX - Metal Salt Spray Tests VWX - Salt Spray 1000 hour Champion</p>
<p>x. 480 hour ASTM D2247 Humidity Resistance test.</p>	<p>VWX - Salt Spray Test</p>
<p>y. FULL Altoona Test Report.</p>	<p>U - Altoona Propane ROUSH U - Altoona Champion Test Class 1 Ford E350 Chassis U - Altoona Test Class 1 Champion U - Altoona Test Class 2 Champion Ford E450 Chassis U - Altoona CNG System U - ICOM Bi-Fuel Altoona report U - Altoona Ford 7.3L Engine U - Altoona Test Class 1 FTA Determination Letter</p>

TABLE 1

54254

Federal Register / Vol. 58, No. 201 / Wednesday, October 20, 1993 / Notices

1. Materials tested for surface flammability should not exhibit any flaming running, or flaming dripping.

2. The surface flammability and smoke emission characteristics of seat cushion materials should be demonstrated to be permanent after testing according to ASTM D-3574 Dynamic Fatigue Tests I_s (Procedure B).

3. The surface flammability and smoke emission characteristics of a material should be demonstrated to be permanent by washing, if appropriate, according to FED-STD-191A Textile Test Method 5830.

4. The surface flammability and smoke emission characteristics of a material should be demonstrated to be permanent by dry cleaning, if appropriate, according to ASTM D-2724. Materials that cannot be washed or dry-cleaned should be so labeled, and should meet the applicable performance criteria after being cleaned as recommended by the manufacturer.

5. ASTM E-662 maximum test limits for smoke emission (specific optical density) should be measured in either the flaming or non-flaming mode, depending on which mode generates more smoke.

6. Flooring and Fire Wall assemblies should meet the performance criteria during a nominal test period determined by the transit property. The nominal test period should be twice the maximum expected period of time, under normal circumstances, for a vehicle to come to a complete, safe stop from maximum speed, plus the time necessary to evacuate all passengers from a vehicle to a safe area. The nominal test period should not be less than 15 minutes. Only one specimen need be tested. A proportional reduction may be made in dimensions of the specimen provided that it represents a true test of its ability to perform as a barrier against vehicle fires. Penetrations (ducts, piping, etc.) should be designed against acting as conduits for fire and smoke.

7. Carpeting should be tested in accordance with ASTM E-648 with its padding, if the padding is used in actual installation.

8. Arm rests, if foamed plastic, are tested as cushions.

9. Testing is performed without upholstery.

Definition of Terms

1. Flame spread index (I_s) as defined in ASTM E-162 is a factor derived from the rate of progress of the flame front (F) and the rate of heat liberation by the material under test (Q), such that $I_s = F \times Q$.

2. Specific optical density (D_s) is the optical density measured over unit path length within a chamber of unit volume produced from a specimen of unit surface area, that is irradiated by a heat flux of 2.5 watts/cm² for a specified period of time.

3. Surface flammability denotes the rate at which flames will travel along surfaces.

4. Flaming running denotes continuous flaming material leaving the site of the during material at its installed location.

5. Flaming dripping denotes periodic dripping of flaming material from the site of burning material at its installed location.

Referenced Fire Standards

The source of test procedures listed in Table 1 is as follows:

(1) Leaching Resistance of Cloth, FED-STD-191A-Textile Test Method 5830.

Availability from: General Services Administration Specifications Division,

Building 197, Washington, Navy Yard, Washington, DC 20407.

(2) Federal Aviation Administration Vertical Burn Test, FAR-25-853.

Available from: Superintendent of Documents, US Government Printing Office, Washington, DC 20402.

(3) American Society for Testing Materials (ASTM)

(a) Surface Flammability of Materials Using a Radiant Heat Energy Source, ASTM E-162;

(b) Surface Flammability for Flexible Cellular Materials Using a Radiant Heat Energy Source, ASTM D-3675;

(c) Fire Tests of Building Construction and Materials, ASTM E-119;

(d) Specific Optical Density of Smoke Generated by Solid Materials, ASTM E-662;

(e) Bonded and Laminated Apparel Fabrics, ASTM D-2724;

(f) Flexible Cellular Materials—Slab, Bonded, and Molded Urethane Foams, ASTM D-3574.

Available from: American Society for Testing and Materials, 1916 Race Street, Philadelphia, PA 19103.

In all instances, the most recent issue of the document or the revision in effect at the time of request should be employed in the evaluation of the material specified herein.

Issued: October 14, 1993.

Grace Crumican,

Deputy Administrator.

[FR Doc. 93-25709 Filed 10-19-93; 8:45 am]
BILLING CODE 4810-67-P

IX. TABLE 1

TABLE 1: RECOMMENDATIONS FOR TESTING THE FLAMMABILITY AND SMOKE EMISSION CHARACTERISTICS OF TRANSIT BUS AND VAN MATERIALS

Category	Function of Material	Test Procedure	Performance Criteria
Seating	Cushion ^{1;2;3;5;9*}	ASTM D-3675	$I_s \leq 25$
		ASTM E-662	$D_s (1.5) \leq 100; D_s (4.0) \leq 200$
	Frame ^{1;5;8}	ASTM E-162	$I_s \leq 35$
		ASTM E-662	$D_s (1.5) \leq 100; D_s (4.0) \leq 200$
	Shroud ^{1;5}	ASTM E-162	$I_s \leq 35$
		ASTM E-662	$D_s (1.5) \leq 100; D_s (4.0) \leq 200$
Upholstery ^{1;3;4;5}	FAR 25.853 (Vertical)	Flame time ≤ 10 seconds; burn length ≤ 6 inches	
	ASTM E-662	$D_s (4.0) \leq 250$ coated; $D_s (4.0) \leq 100$ uncoated	
Panels	Wall ^{1;5}	ASTM E-162	$I_s \leq 35$
		ASTM E-662	$D_s (1.5) \leq 100; D_s (4.0) \leq 200$
	Ceiling ^{1;5}	ASTM E-162	$I_s \leq 35$
		ASTM E-662	$D_s (1.5) \leq 100; D_s (4.0) \leq 200$
	Partition ^{1;5}	ASTM E-162	$I_s \leq 35$
		ASTM E-662	$D_s (1.5) \leq 100; D_s (4.0) \leq 200$
	Windscreen ^{1;5}	ASTM E-162	$I_s \leq 35$
		ASTM E-662	$D_s (1.5) \leq 100; D_s (4.0) \leq 200$
	HVAC Ducting ^{1;5}	ASTM E-162	$I_s \leq 35$
		ASTM E-662	$D_s (4.0) \leq 100$
Light Diffuser ⁵	ASTM E-162	$I_s \leq 100$	
	ASTM E-662	$D_s (1.5) \leq 100; D_s (4.0) \leq 200$	
Flooring	Wheel Well and Structural ⁶	ASTM E-119	Pass
	Carpeting ⁷	ASTM E-648	C.R.F. ≥ 0.5 w/cm ²
Insulation	Thermal ^{1;3;5}	ASTM E-162	$I_s \leq 25$
		ASTM E-662	$D_s (4.0) \leq 100$
	Acoustic ^{1;3;5}	ASTM E-162	$I_s \leq 25$
		ASTM E-662	$D_s (4.0) \leq 100$
Miscellaneous	Firewall ⁶	ASTM E-119	Pass
	Exterior Shell ^{1;5}	ASTM E-162	$I_s \leq 35$
		ASTM E-662	$D_s (1.5) \leq 100; D_s (4.0) \leq 200$

* Refers to Notes on Table 1

X. BUS SEATING ARRANGEMENTS

Standard non-lift buses and lift buses shall be supplied as requested in the following seating arrangements:

Class 1 (138" minimum):

- A.** 10 passenger without lift
 - i. 3 standard double forward facing seats
 - ii. 4 single forward facing seats
 - iii. 1 co-pilot seat (OEM)

- B.** 4 + 2 passenger with lift
 - i. 1 standard double forward facing seats
 - ii. 2 single forward facing seats
 - iii. 1 co-pilot seat (OEM)
 - iv. 2 wheelchair positions
 - v. 3 double fold-away seats

- C.** 11 passenger without lift
 - i. 3 standard double forward facing seats
 - ii. 5 single forward facing seats

- D.** 5 + 2 passenger with lift
 - i. 1 standard double forward facing seats
 - ii. 3 single aisle facing fold-away seats
 - iii. 2 wheelchair positions
 - iv. 3 double fold-away seats

Class 2 (158" minimum):

- E.** 18 passenger without lift
 - i. 9 standard double forward facing seats

- F.** 10 + 1 passenger with lift
 - i. 5 standard double forward facing seats
 - ii. 1 wheelchair positions
 - iii. 2 double fold-away seats

- G.** 8 + 2 passenger with lift
 - i. 3 standard double forward facing seats
 - ii. 2 wheelchair positions
 - iii. 2 double fold-away seats
 - iv. 1 double aisle facing fold-away seat

- H.** 4 + 2 passenger with lift
 - i. 2 standard double forward facing seats
 - ii. 2 wheelchair positions
 - iii. 6 double fold-away seats

- I.** 22 passenger without lift

- i. 11 standard double forward facing seats
- J.** 6 + 2 passenger with lift
 - i. 3 standard double forward facing seats
 - ii. 2 wheelchair positions
 - iii. 5 double fold-away seats
- K.** 10 + 2 passenger with lift
 - i. 5 standard double forward facing seats
 - ii. 2 wheelchair positions
 - iii. 2 double fold-away seats
- L.** 4 + 2 passenger with lift
 - i. 2 standard double forward facing seats
 - ii. 2 wheelchair positions
 - iii. 7 double fold-away seats

Drawings for the suggested seating arrangements are supplied on the following pages.

Bus Floor Plans

Class 1

Wheelbase 138" Minimum

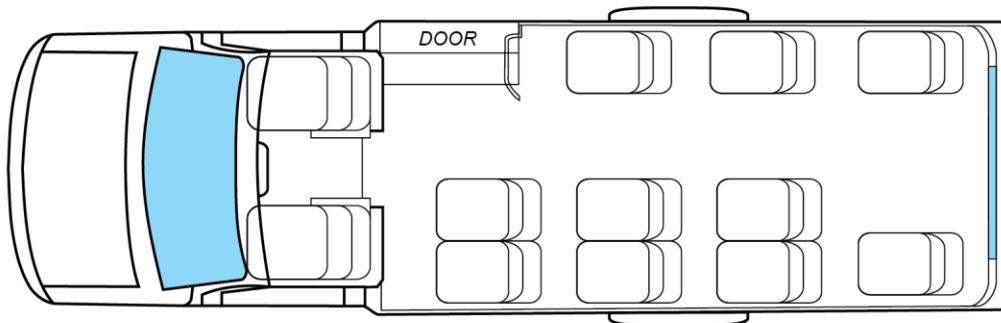

10 Passenger Bus without Lift

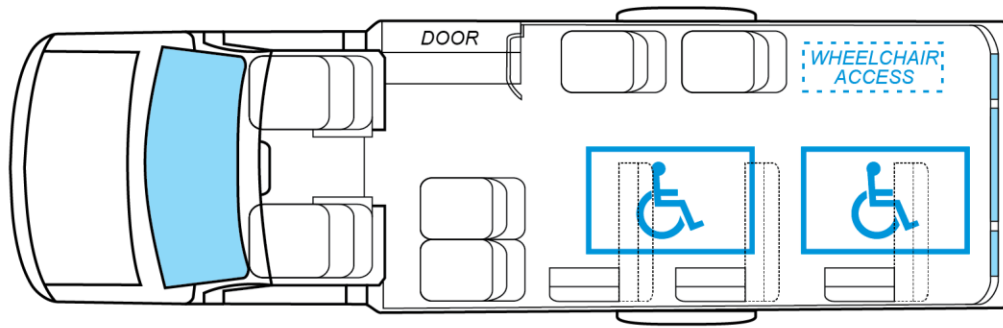

4 + 2 Passenger Bus with Lift

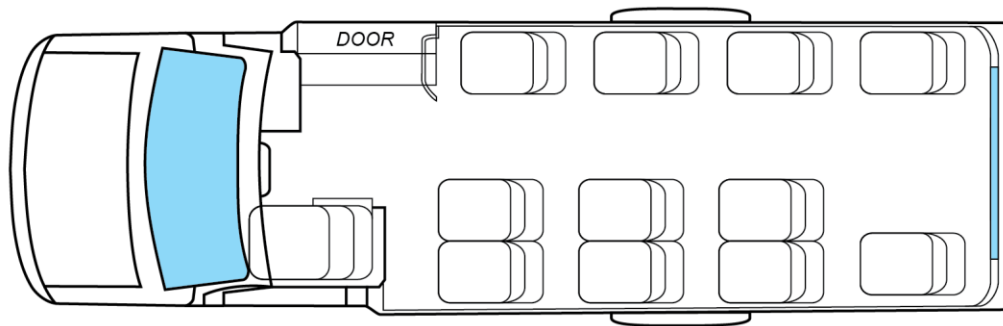

11 Passenger Bus without Lift

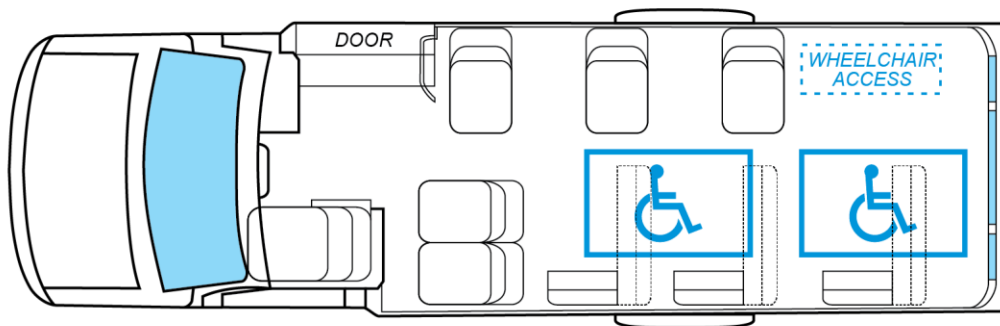

5 + 2 Passenger Bus with Lift

Class 2
Wheelbase 158" Minimum

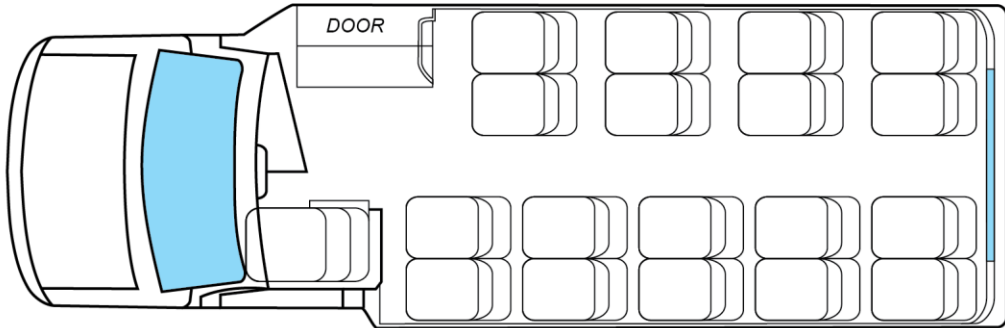

18 Passenger Bus without Lift

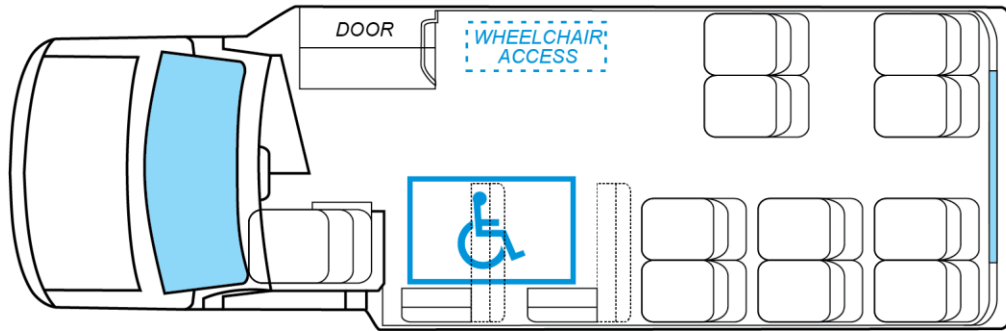

10 + 1 Passenger Bus with Lift

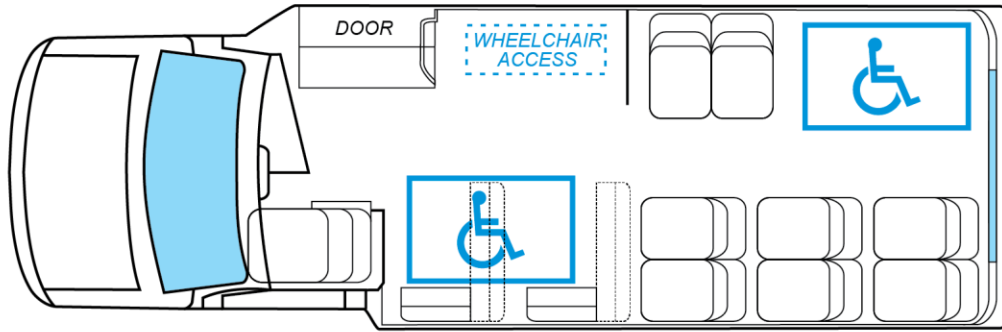

8 + 2 Passenger Bus with Lift

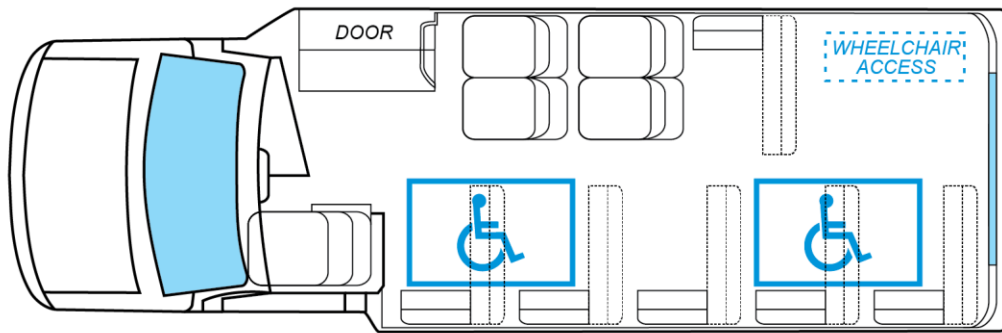

4 + 2 Passenger Bus with Lift

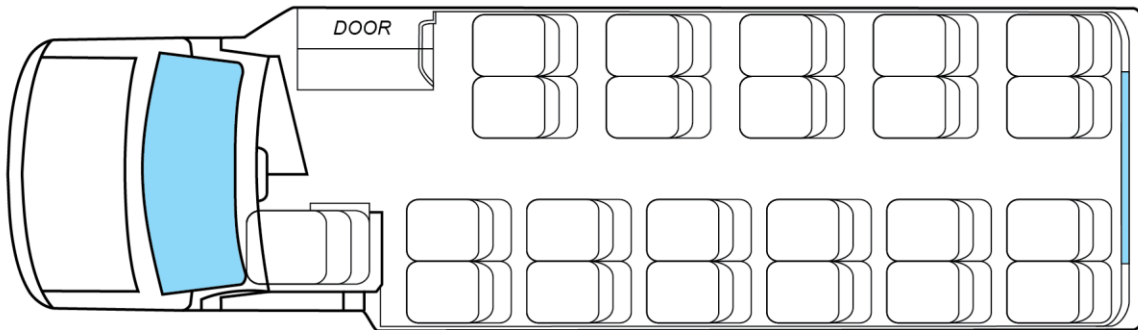

22 Passenger Bus without Lift

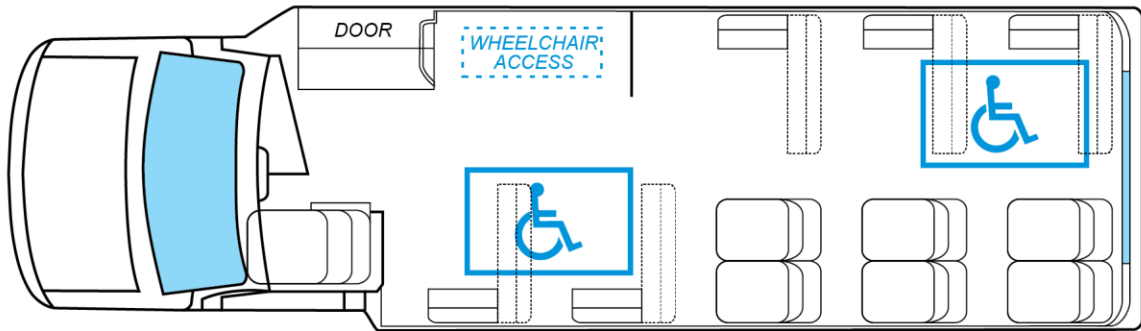

6 + 2 Passenger Bus with Lift

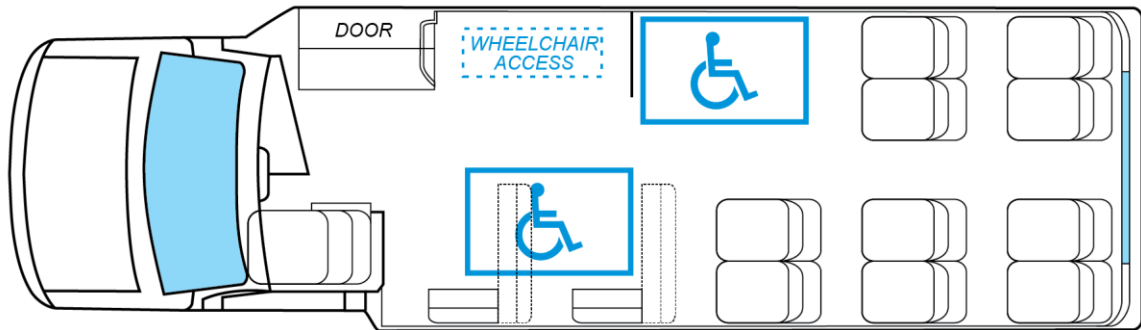

10 + 2 Passenger Bus with Lift

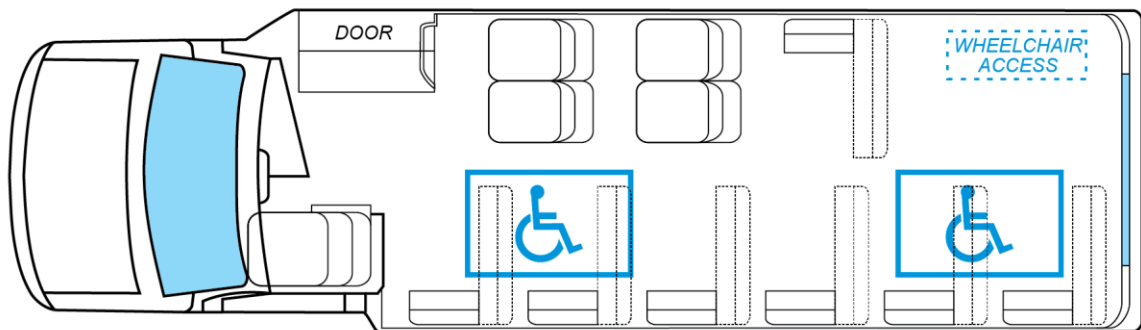

4 + 2 Passenger Bus with Lift

This specification was developed as a cooperative effort between the Michigan Department of Transportation and a committee of representatives from various Michigan public transit agencies. Upon request, this specification can be obtained in alternative format such as braille, large print, or audio tape.

**ROLLING STOCK
MORE THAN \$150,000**

ACCESS TO RECORDS AND REPORTS

Applicability – as shown below. These requirements do not apply to micro-purchases (\$3,500 or less, except for construction contracts over \$2,000).

The following access to records requirements apply to this Contract:

1. Where the purchaser is not a State but a local government and is an FTA recipient or a subgrantee of FTA recipient in accordance with 49 CFR 18.36(i), contractor shall provide the purchaser, the FTA, the US Comptroller General or their authorized representatives access to any books, documents, papers and contractor records which are pertinent to this contract for the purposes of making audits, examinations, excerpts and transcriptions. Contractor shall also, pursuant to 49 CFR 633.17, provide authorized FTA representatives, including any PMO contractor, access to contractor's records and construction sites pertaining to a capital project, defined at 49 USC 5302(a)1, which is receiving FTA assistance through the programs described at 49 USC 5307, 5309 or 5311.
2. Where the purchaser is a State and is an FTA recipient or a subgrantee of FTA recipient in accordance with 49 CFR 633.17, contractor shall provide the purchaser, authorized FTA representatives, including any PMO Contractor, access to contractor's records and construction sites pertaining to a capital project, defined at 49 USC 5302(a)1, which receives FTA assistance through the programs described at 49 USC 5307, 5309 or 5311. By definition, a capital project excludes contracts of less than the simplified acquisition threshold currently set at \$150,000.
3. Where the purchaser enters into a negotiated contract for other than a small purchase or under the simplified acquisition threshold and is an institution of higher education, a hospital or other non-profit organization and is an FTA recipient or a subgrantee of FTA recipient in accordance with 49 CFR 19.48, contractor shall provide the purchaser, the FTA, the US Comptroller General or their authorized representatives, access to any books, documents, papers and record of the contractor which are directly pertinent to this contract for the purposes of making audits, examinations, excerpts and transcriptions.
4. Where a purchaser which is an FTA recipient or a subgrantee of FTA recipient in accordance with 49 USC 5325(a) enters into a contract for a capital project or improvement (defined at 49 USC 5302(a)1) through other than competitive bidding, contractor shall make available records related to the contract to the purchaser, the Secretary of USDOT and the US Comptroller General or any authorized officer or employee of any of them for the purposes of conducting an audit and inspection.
5. Contractor shall permit any of the foregoing parties to reproduce by any means whatsoever or to copy excerpts and transcriptions as reasonably needed.
6. Contractor shall maintain all books, records, accounts and reports required under this contract for a period of not less than three (3) years after the date of termination or expiration of this contract, except in the event of litigation or settlement of claims arising from the performance of this contract, in which case contractor agrees to maintain same until the recipient, FTA Administrator, US Comptroller General, or any of their authorized representatives, have disposed of all such litigation, appeals, claims or exceptions related thereto. Re: 49 CFR 18.39(i)(11). FTA does not require the inclusion of these requirements in subcontracts.

BREACHES AND DISPUTE RESOLUTION

Applicability – all contracts more than \$150,000.

Disputes arising in the performance of this contract which are not resolved by agreement of the parties shall be decided in writing by the recipient's authorized representative. This decision shall be final and conclusive unless within ten (10) days from the date of receipt of its copy, contractor mails or otherwise furnishes a written appeal to the recipient's CEO. In connection with such appeal, contractor shall be afforded an opportunity to be heard and to offer evidence in support of its position. The decision of the recipient's CEO shall be binding upon contractor and contractor shall abide by the decision. FTA has a vested interest in

the settlement of any violation of Federal law including the the False Claims Act, 31 U.S.C. § 3729. Performance During Dispute - Unless otherwise directed by the recipient, contractor shall continue performance under this contract while matters in dispute are being resolved. Claims for Damages - Should either party to the contract suffer injury or damage to person or property because of any act or omission of the party or of any of his employees, agents or others for whose acts he is legally liable, a claim for damages therefore shall be made in writing to such other party within ten days after the first observance of such injury or damage. Remedies - Unless this contract provides otherwise, all claims, counterclaims, disputes and other matters in question between the recipient and contractor arising out of or relating to this agreement or its breach will be decided by arbitration if the parties mutually agree, or in a court of competent jurisdiction within the residing State. Rights and Remedies - Duties and obligations imposed by the contract documents and the rights and remedies available thereunder shall be in addition to and not a limitation of any duties, obligations, rights and remedies otherwise imposed or available by law. No action or failure to act by the recipient or contractor shall constitute a waiver of any right or duty afforded any of them under the contract, nor shall any such action or failure to act constitute an approval of or acquiescence in any breach thereunder, except as may be specifically agreed in writing

BUS TESTING

Applicability – all contracts more than \$150,000.

Contractor [manufacturer] shall comply with 49 USC A5323(c) and FTA's implementing regulation 49 CFR 665, to the extent they are consistent with 49 U.S.C. § 5318(e), as amended; and shall perform the following:

1. A manufacturer of a new bus model or a bus produced with a major change in components or configuration shall provide a copy of the final test report to the recipient prior to the recipient's final acceptance of the first vehicle.
2. A manufacturer who releases a report under para. 1 above shall provide notice to the operator of the testing facility that the report is available to the public.
3. If the manufacturer represents that the vehicle was previously tested, the vehicle being sold should have the identical configuration and major components as the vehicle in the test report, which must be provided to the recipient prior to the recipient's final acceptance of the first vehicle. If configuration or components are not identical, the manufacturer shall provide a description of the change and the manufacturer's basis for concluding that it is not a major change requiring additional testing.
4. If the manufacturer represents that the vehicle is "grandfathered" (has been used in mass transit service in the US before Oct. 1, 1988 and is currently being produced without a major change in configuration or components), the manufacturer shall provide the name and address of the recipient of such a vehicle and the details of that vehicle's configuration and major components.

CERTIFICATION OF COMPLIANCE WITH FTA'S BUS TESTING REQUIREMENTS The undersigned [Contractor/Manufacturer] certifies that the vehicle offered in this procurement complies with 49 U.S.C. A 5323(c) and FTA's implementing regulation at 49 CFR Part 665.

The undersigned understands that misrepresenting the testing status of a vehicle acquired with Federal financial assistance may subject the undersigned to civil penalties as outlined in the Department of Transportation's regulation on Program Fraud Civil Remedies, 49 CFR Part 31. In addition, the undersigned understands that FTA may suspend or debar a manufacturer under the procedures in 49 CFR Part 29.

CONTRACTOR / COMPANY NAME

NAME, TITLE AND SIGNATURE OF CONTRACTOR'S AUTHORIZED OFFICIAL:

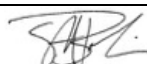
TYPE OR PRINT NAME	TITLE
SIGNATURE 	DATE

BUY AMERICA CERTIFICATION (ROLLING STOCK)

Applicability – construction contracts and acquisition of goods or rolling stock (valued at more than \$150,000).

Construction Contracts and Acquisition of Goods or Rolling Stock (valued at more than \$150,000)

Contractor shall comply with 49 USC 5323(j) and 49 CFR 661, as amended by MAP-21 stating that Federal funds may not be obligated unless steel, iron and manufactured products used in FTA-funded projects are produced in the United States, unless a waiver has been granted by FTA or the product is subject to a general waiver. General waivers are listed in 49 CFR 661.7, and include software, microcomputer equipment and small purchases (currently less than \$150,000) made with capital, operating or planning funds. Separate requirements for rolling stock are stated at 5323(j)(2)(C) and 49 CFR 661.11 and as amended by Map-21 (5325). Rolling stock must be manufactured in the US and have a minimum 60% domestic content and adhere to contract term limitations. A bidder or offeror shall submit appropriate Buy America certification to the recipient with all bids on FTA-funded contracts, except those subject to a general waiver. Proposals not accompanied by a completed Buy America certification shall be rejected as nonresponsive. This requirement does not apply to lower tier subcontractors.

Certificate of **Compliance** with Buy America Requirements.

The bidder or offeror hereby certifies that it will comply with the requirements of 49 U.S.C. 5323(j)(1), and the applicable regulations in 49 CFR part 661.

Only sign either Certificate of **Compliance** or Certificate of **Non-Compliance**

CONTRACTOR / COMPANY NAME

NAME, TITLE AND SIGNATURE OF CONTRACTOR'S AUTHORIZED OFFICIAL:

TYPE OR PRINT NAME	TITLE
SIGNATURE	DATE

Only sign either Certificate of **Compliance** or Certificate of **Non-Compliance**

Certificate of **Non-Compliance** with Buy America Steel or Manufactured Products Requirements The bidder or offeror hereby certifies that it cannot comply with the requirements of 49 U.S.C. 5323(j), but it may qualify for an exception to the requirement pursuant to 49 U.S.C. 5323(j)(2), as amended, and the applicable regulations in 49 C.F.R. 661.7.

CONTRACTOR / COMPANY NAME

NAME, TITLE AND SIGNATURE OF CONTRACTOR'S AUTHORIZED OFFICIAL:

TYPE OR PRINT NAME	TITLE
SIGNATURE	DATE

CARGO PREFERENCE

Applicability – all contracts involving equipment, materials or commodities which may be transported by ocean vessels. These requirements do not apply to micro-purchases (\$3,500 or less, except for construction contracts over \$2,000).

Contractor shall: a. use privately owned US-Flag commercial vessels to ship at least 50% of the gross tonnage (computed separately for dry bulk carriers, dry cargo liners and tankers) involved, whenever shipping any equipment, material or commodities pursuant to the underlying contract to the extent such vessels are available at fair and reasonable rates for US flag commercial vessels; b. furnish within 20 working days following the loading date of shipments originating within the US or within 30 working days following the loading date of shipments originating outside the US, a legible copy of a rated, "on-board" commercial bill-of-lading in English for each shipment of cargo described herein to the Division of National Cargo, Office of Market Development, Maritime Administration, Washington, DC 20590 and to the recipient (through contractor in the case of a subcontractor's bill-of-lading.); c. include these requirements in all subcontracts issued pursuant to this contract when the subcontract involves the transport of equipment, material or commodities by ocean vessel.

CIVIL RIGHTS REQUIREMENTS

Applicability – All contracts except micro-purchases (\$3,500 or less, except for construction contracts over \$2,000).

The following requirements apply to the underlying contract: The Recipient understands and agrees that it must comply with applicable Federal civil rights laws and regulations, and follow applicable Federal guidance, except as the Federal Government determines otherwise in writing. Therefore, unless a Recipient or Program, including an Indian Tribe or the Tribal Transit Program, is specifically exempted from a civil rights statute, FTA requires compliance with that civil rights statute, including compliance with equity in service: a. Nondiscrimination in Federal Public Transportation Programs. The Recipient agrees to, and assures that each Third-Party Participant will, comply with Federal transit law, 49 U.S.C. § 5332 (FTA's "Nondiscrimination" statute):

- a. FTA's "Nondiscrimination" statute prohibits discrimination on the basis of: (a) Race, (b) Color, (c) Religion, (d) National origin, (e) Sex, (f) Disability, (g) Age, or (h) Gender identity and (2) The FTA "Nondiscrimination" statute's prohibition against discrimination includes: (a) Exclusion from participation, (b) Denial of program benefits, or (c) Discrimination, including discrimination in employment or business opportunity, (3) Except as FTA determines otherwise in writing: (a) General. Follow: 1 The most recent edition of FTA Circular 4702.1, "Title VI Requirements and Guidelines for Federal Transit Administration Recipients," to the extent consistent with applicable Federal laws, regulations, and guidance, and 2 Other applicable Federal guidance that may be issued, but (b) Exception for the Tribal Transit Program. FTA does not require an Indian Tribe to comply with FTA program-specific guidelines for Title VI when administering its projects funded under the Tribal Transit Program,
- b. Nondiscrimination – Title VI of the Civil Rights Act. The Recipient agrees to, and assures that each Third Party Participant will: (1) Prohibit discrimination based on: (a) Race, (b) Color, or (c) National origin, (2) Comply with: (a) Title VI of the Civil Rights Act of 1964, as amended, 42 U.S.C. § 2000d et seq., (b) U.S. DOT regulations, "Nondiscrimination in Federally-Assisted Programs of the Department of Transportation – Effectuation of Title VI of the Civil Rights Act of 1964," 49 C.F.R. part 21, and (c) Federal transit law, specifically 49 U.S.C. § 5332, as stated in the preceding section a, and (3) Except as FTA determines otherwise in writing, follow: (a) The most recent edition of FTA Circular 4702.1, "Title VI and Title VI-Dependent Guidelines for Federal Transit Administration Recipients," to the extent consistent with applicable Federal laws, regulations, and guidance. (b) U.S. DOJ, "Guidelines for the enforcement of Title VI, Civil Rights Act of 1964," 28 C.F.R. § 50.3, and (c) Other applicable Federal guidance that may be issued,
- c. Equal Employment Opportunity. (1) Federal Requirements and Guidance. The Recipient agrees to, and assures that each Third Party Participant will, prohibit discrimination on the basis of race, color, religion, sex, or national origin, and: (a) Comply with Title VII of the Civil Rights Act of 1964, as amended, 42 U.S.C. § 2000e et seq., (b) Facilitate compliance with Executive Order No. 11246, "Equal Employment Opportunity," as amended by Executive Order No. 11375, "Amending Executive Order No. 11246, Relating to Equal Employment Opportunity," 42 U.S.C. § 2000e note, (c) Comply with Federal transit law, specifically 49 U.S.C. § 5332, as stated in section a, and (d) Comply with other applicable EEO laws and regulations, as provided in Federal guidance, including

laws and regulations prohibiting discrimination on the basis of disability, except as the Federal Government determines otherwise in writing, (2) General. The Recipient agrees to: (a) Ensure that applicants for employment are employed and employees are treated during employment without discrimination on the basis of their: 1 Race, 2 Color, 3 Religion, 4 Sex, 5 Disability, 6 Age, or 7 National origin, (b) Take affirmative action that includes, but is not limited to: 1 Recruitment advertising, 2 Recruitment, 3 Employment, 4 Rates of pay, 5 Other forms of compensation, 6 Selection for training, including apprenticeship, 7 Upgrading, 8 Transfers, 9 Demotions, 10 Layoffs, and 11 Terminations, but (b) Indian Tribe. Title VII of the Civil Rights Act of 1964, as amended, exempts Indian Tribes under the definition of "Employer". (3) Equal Employment Opportunity Requirements for Construction Activities. In addition to the foregoing, when undertaking "construction" as recognized by the U.S. Department of Labor (U.S. DOL), the Recipient agrees to comply, and assures the compliance of each Third Party Participant, with: (a) U.S. DOL regulations, "Office of Federal Contract Compliance Programs, Equal Employment Opportunity, Department of Labor," 41 C.F.R. chapter 60, and (b) Executive Order No. 11246, "Equal Employment Opportunity," as amended by Executive Order No. 11375, "Amending Executive Order No. 11246, Relating to Equal Employment Opportunity," 42 U.S.C. § 2000e note,

- d. Disadvantaged Business Enterprise. To the extent authorized by applicable Federal law, the Recipient agrees to facilitate, and assures that each Third-Party Participant will facilitate, participation by small business concerns owned and controlled by socially and economically disadvantaged individuals, also referred to as "Disadvantaged Business Enterprises" (DBEs), in the Project as follows: 1) Requirements. The Recipient agrees to comply with: (a) Section 1101(b) of MAP-21, 23 U.S.C. § 101 note, (b) U.S. DOT regulations, "Participation by Disadvantaged Business Enterprises in Department of Transportation Financial Assistance Programs," 49 C.F.R. part 26, and (c) Federal transit law, specifically 49 U.S.C. § 5332, as stated in section a, (2) Assurance. As required by 49 C.F.R. § 26.13(a), (b) DBE Program Requirements. Recipients receiving planning, capital and/or operating assistance that will award prime third-party contracts exceeding \$250,000 in a Federal fiscal year must: 1 Have a DBE program meeting the requirements of 49 C.F.R. part 26, 2 Implement a DBE program approved by FTA, and 3 Establish an annual DBE participation goal, (c) Special Requirements for a Transit Vehicle Manufacturer. The Recipient understands and agrees that each transit vehicle manufacturer, as a condition of being authorized to bid or propose on FTA-assisted transit vehicle procurements, must certify that it has complied with the requirements of 49 C.F.R. part 26, (d) the Recipient provides assurance that: The Recipient shall not discriminate on the basis of race, color, national origin, or sex in the award and performance of any DOT-assisted contract or in the administration of its DBE program or the requirements of 49 C.F.R. part 26. The Recipient shall take all necessary and reasonable steps under 49 C.F.R. part 26 to ensure nondiscrimination in the award and administration of DOT-assisted contracts. The Recipient's DBE program, as required by 49 C.F.R. part 26 and as approved by DOT, is incorporated by reference in this agreement. Implementation of this program is a legal obligation and failure to carry out its terms shall be treated as a violation of this agreement. Upon notification to the Recipient of its failure to carry out its approved program, the Department may impose sanctions as provided for under 49 C.F.R. part 26 and may, in appropriate cases, refer the matter for enforcement under 18 U.S.C. § 1001 and/or the Program Fraud Civil Remedies Act of 1986, 31 U.S.C. § 3801 et seq., (2) Exception for the Tribal Transit Program. FTA exempts Indian tribes from the Disadvantaged Business Enterprise regulations at 49 C.F.R. part 26 under MAP-21 and previous legislation,
- e. Nondiscrimination on the Basis of Sex. The Recipient agrees to comply with Federal prohibitions against discrimination on the basis of sex, including: (1) Title IX of the Education Amendments of 1972, as amended, 20 U.S.C. § 1681 et seq., (2) U.S. DOT regulations, "Nondiscrimination on the Basis of Sex in Education Programs or Activities Receiving Federal Financial Assistance," 49 C.F.R. part 25, and (3) Federal transit law, specifically 49 U.S.C. § 5332, as stated in section a,
- f. Nondiscrimination on the Basis of Age. The Recipient agrees to comply with Federal prohibitions against discrimination on the basis of age, including: (1) The Age Discrimination in Employment Act (ADEA), 29 U.S.C. §§ 621 – 634, which prohibits discrimination on the basis of age, (2) U.S. Equal Employment Opportunity Commission (U.S. EEOC) regulations, "Age Discrimination in Employment Act," 29 C.F.R. part 1625, which implements the ADEA, (3) The Age Discrimination Act of 1975, as amended, 42 U.S.C. § 6101 et seq., which prohibits discrimination against individuals on the basis of age in the administration of programs or activities receiving Federal funds, (4) U.S. Health and Human Services regulations, "Nondiscrimination on the Basis of Age in Programs or Activities Receiving Federal Financial Assistance," 45 C.F.R. part 90, which

- implements the Age Discrimination Act of 1975, and (5) Federal transit law, specifically 49 U.S.C. § 5332, as stated in section a,
- g. Nondiscrimination on the Basis of Disability. The Recipient agrees to comply with the following Federal prohibitions pertaining to discrimination against seniors or individuals with disabilities: (1) Federal laws, including: (a) Section 504 of the Rehabilitation Act of 1973, as amended, 29 U.S.C. § 794, which prohibits discrimination on the basis of disability in the administration of federally funded programs or activities, (b) The Americans with Disabilities Act of 1990 (ADA), as amended, 42 U.S.C. § 12101 et seq., which requires that accessible facilities and services be made available to individuals with disabilities, 1 General. Titles I, II, and III of the ADA apply to FTA Recipients, but 2 Indian Tribes. While Titles II and III of the ADA apply to Indian Tribes, Title I of the ADA exempts Indian Tribes from the definition of “employer,” (c) The Architectural Barriers Act of 1968, as amended, 42 U.S.C. § 4151 et seq., which requires that buildings and public accommodations be accessible to individuals with disabilities, (d) Federal transit law, specifically 49 U.S.C. § 5332, which now includes disability as a prohibited basis for discrimination, and (e) Other applicable laws and amendments pertaining to access for elderly individuals or individuals with disabilities, (2) Federal regulations, including: (a) U.S. DOT regulations, “Transportation Services for Individuals with Disabilities (ADA),” 49 C.F.R. part 37, (b) U.S. DOT regulations, “Nondiscrimination on the Basis of Disability in Programs and Activities Receiving or Benefiting from Federal Financial Assistance,” 49 C.F.R. part 27, (c) U.S. DOT regulations, “Transportation for Individuals with Disabilities: Passenger Vessels,” 49 C.F.R. part 39, (d) Joint U.S. Architectural and Transportation Barriers Compliance Board (U.S. ATBCB) and U.S. DOT regulations, “Americans With Disabilities (ADA) Accessibility Specifications for Transportation Vehicles,” 36 C.F.R. part 1192 and 49 C.F.R. part 38, (e) U.S. DOJ regulations, “Nondiscrimination on the Basis of Disability in State and Local Government Services,” 28 C.F.R. part 35, (f) U.S. DOJ regulations, “Nondiscrimination on the Basis of Disability by Public Accommodations and in Commercial Facilities,” 28 C.F.R. part 36, (g) U.S. EEOC, “Regulations to Implement the Equal Employment Provisions of the Americans with Disabilities Act,” 29 C.F.R. part 1630, (h) U.S. Federal Communications Commission regulations, “Telecommunications Relay Services and Related Customer Premises Equipment for Persons with Disabilities,” 47 C.F.R. part 64, Subpart F, (i) U.S. ATBCB regulations, “Electronic and Information Technology Accessibility Standards,” 36 C.F.R. part 1194, and (j) FTA regulations, “Transportation for Elderly and Handicapped Persons,” 49 C.F.R. part 609, and (3) Other applicable Federal civil rights and nondiscrimination guidance,
 - h. Drug or Alcohol Abuse - Confidentiality and Other Civil Rights Protections. The Recipient agrees to comply with the confidentiality and civil rights protections of: (1) The Drug Abuse Office and Treatment Act of 1972, as amended, 21 U.S.C. § 1101 et seq., (2) The Comprehensive Alcohol Abuse and Alcoholism Prevention, Treatment and Rehabilitation Act of 1970, as amended, 42 U.S.C. § 4541 et seq., and (3) The Public Health Service Act, as amended, 42 U.S.C. §§ 290dd – 290dd-2,
 - i. Access to Services for People with Limited English Proficiency. Except as the Federal Government determines otherwise in writing, the Recipient agrees to promote accessibility of public transportation services to people whose understanding of English is limited by following: 1) Executive Order No. 13166, “Improving Access to Services for Persons with Limited English Proficiency,” August 11, 2000, 42 U.S.C. § 2000d-1 note, and (2) U.S. DOT Notice, “DOT Policy Guidance Concerning Recipients’ Responsibilities to Limited English Proficiency (LEP) Persons,” 70 Fed. Reg. 74087, December 14, 2005,
 - j. Other Nondiscrimination Laws. Except as the Federal Government determines otherwise in writing, the Recipient agrees to: (1) Comply with other applicable Federal nondiscrimination laws and regulations, and (2) Follow Federal guidance prohibiting discrimination.
 - k. Remedies. Remedies for failure to comply with applicable Federal Civil Rights laws and Federal regulations may be enforced as provided in those Federal laws or Federal regulations.

CLEAN AIR

Applicability – all contracts more than \$150,000.

1. Contractor shall comply with all applicable standards, orders or regulations pursuant to the Clean Air Act, 42 USC 7401 et seq. Contractor shall report each violation to the recipient and understands and agrees that the recipient will, in turn, report each violation as required to FTA and the appropriate EPA Regional Office.

2. Contractor shall include these requirements in each subcontract exceeding \$150,000 financed in whole or in part with FTA assistance.

CLEAN WATER

Applicability – all Contracts and Subcontracts more than \$150,000. Contractor shall comply with all applicable standards, orders or regulations issued pursuant to the Federal Water Pollution Control Act, as amended, 33 USC 1251 et seq. Contractor shall report each violation to the recipient and understands and agrees that the recipient shall, in turn, report each violation as required to FTA and the appropriate EPA Regional Office. Contractor shall include these requirements in each subcontract exceeding \$100,000 financed in whole or in part with FTA assistance.

CONTRACTS INVOLVING FEDERAL PRIVACY ACT REQUIREMENTS

Applicability – when a grantee maintains files on drug and alcohol enforcement activities for FTA, and those files are organized so that information could be retrieved by personal identifier, the Privacy Act requirements apply to all contracts except micro-purchases (\$3,500 or less, except for construction contracts over \$2,000).

The following requirements apply to the Contractor and its employees that administer any system of records on behalf of the Federal Government under any contract:

1. The Contractor agrees to comply with, and assures the compliance of its employees with, the information restrictions and other applicable requirements of the Privacy Act of 1974, 5 U.S.C. § 552a. Among other things, the Contractor agrees to obtain the express consent of the Federal Government before the Contractor or its employees operate a system of records on behalf of the Federal Government. The Contractor understands that the requirements of the Privacy Act, including the civil and criminal penalties for violation of that Act, apply to those individuals involved, and that failure to comply with the terms of the Privacy Act may result in termination of the underlying contract.
2. The Contractor also agrees to include these requirements in each subcontract to administer any system of records on behalf of the Federal Government financed in whole or in part with Federal assistance provided by FTA.

CONTRACT WORK HOURS & SAFETY STANDARDS ACT

Applicability – contracts over \$150,000.

- 1) Overtime requirements - No contractor or subcontractor contracting for any part of the contract work which may require or involve the employment of laborers or mechanics shall require or permit any such laborer or mechanic in any workweek in which he or she is employed on such work to work in excess of 40 hours in such workweek unless such laborer or mechanic receives compensation at a rate not less than one and one-half times the basic rate of pay for all hours worked in excess of 40 hours in such workweek.
- 2) Violation; liability for unpaid wages; liquidated damages - In the event of any violation of the clause set forth in para. (1) of this section, contractor and any subcontractor responsible therefore shall be liable for the unpaid wages. In addition, such contractor and subcontractor shall be liable for liquidated damages. Such liquidated damages shall be computed with respect to each individual laborer or mechanic, including watchmen and guards, employed in violation of the clause set forth in para. (1) of this section, in the sum of \$10 for each calendar day on which such individual was required or permitted to work in excess of the standard workweek of 40 hours without payment of the overtime wages required by the clause set forth in para. (1) of this section.
- 3) Withholding for unpaid wages and liquidated damages - the recipient shall upon its own action or upon written request of USDOL withhold or cause to be withheld, from any moneys payable on account of work performed by contractor or subcontractor under any such contract or any other Federal contract with the same prime contractor, or any other federally-assisted contract subject to the Contract Work Hours & Safety Standards Act, which is held by the same prime contractor, such sums as may be determined to be necessary to satisfy any liabilities of such contractor or subcontractor for unpaid wages and liquidated damages as provided in the clause set forth in para. (2) of this section.
- 4) Subcontracts - Contractor or subcontractor shall insert in any subcontracts the clauses set forth in this section and also a clause requiring the subcontractors to include these clauses in any

lower tier subcontracts. Prime contractor shall be responsible for compliance by any subcontractor or lower tier subcontractor with the clauses set forth in this section.

DISADVANTAGED BUSINESS ENTERPRISE (DBE)

Applicability – contracts over \$3,500 awarded on the basis of a bid or proposal offering to use DBEs.

- a. This contract is subject to the requirements of Title 49, Code of Federal Regulations, Part 26, Participation by Disadvantaged Business Enterprises in Department of Transportation Financial Assistance Programs. The national goal for participation of Disadvantaged Business Enterprises (DBE) is 10%. The recipient’s overall goal for DBE participation is listed elsewhere. If a separate contract goal for DBE participation has been established for this procurement, it is listed elsewhere.
- b. The contractor shall not discriminate on the basis of race, color, religion, national origin or sex in the performance of this contract. The contractor shall carry out applicable requirements of 49 CFR Part 26 in the award and administration of this contract. Failure by the contractor to carry out these requirements is a material breach of this contract, which may result in the termination of this contract or such other remedy as the municipal corporation deems appropriate. Each subcontract the contractor signs with a subcontractor must include the assurance in this paragraph (see 49 CFR 26.13(b)).
- c. If a separate contract goal has been established, Bidders/offerors are required to document sufficient DBE participation to meet these goals or, alternatively, document adequate good faith efforts to do so, as provided for in 49 CFR 26.53.
- d. If no separate contract goal has been established, the successful bidder/offeror will be required to report its DBE participation obtained through race-neutral means throughout the period of performance.
- e. The contractor is required to pay its subcontractors performing work related to this contract for satisfactory performance of that work no later than 30 days after the contractor’s receipt of payment for that work from the recipient. In addition, the contractor may not hold retainage from its subcontractors or must return any retainage payments to those subcontractors within 30 days after the subcontractor's work related to this contract is satisfactorily completed or must return any retainage payments to those subcontractors within 30 days after incremental acceptance of the subcontractor’s work by the recipient and contractor’s receipt of the partial retainage payment related to the subcontractor’s work.
- f. The contractor must promptly notify the recipient whenever a DBE subcontractor performing work related to this contract is terminated or fails to complete its work, and must make good faith efforts to engage another DBE subcontractor to perform at least the same amount of work. The contractor may not terminate any DBE subcontractor and perform that work through its own forces or those of an affiliate without prior written consent of the recipient.

DBE TRANSIT VEHICLE MANUFACTURER CERTIFICATION

_____, a TVM,
(Name of Manufacturer)

hereby certifies that it has complied with the requirement of Section 26.49 of 49 CFR, Part 26 by submitting a current annual DBE goal to FTA. The goals apply to Federal Fiscal Year _____ (October 1, _____ to September 30, _____) and have been approved or not disapproved by FTA.

_____, hereby certifies that the manufacturer of the transit
(Name of Contract Vendor)

vehicle to be supplied _____ has complied with the above referenced
(Name of Manufacturer)
requirement of Section 26.49 of 49 CFR Part 26.

MANUFACTURER	TITLE	
SIGNATURE 	DATE	

ENERGY CONSERVATION

Applicability – all Contracts except micro-purchases (\$3,500 or less, except for construction contracts over \$2,000).

Contractor shall comply with mandatory standards and policies relating to energy efficiency, stated in the state energy conservation plan issued in compliance with the Energy Policy & Conservation Act.

FEDERAL CHANGES

Applicability – all Contracts except micro-purchases (\$3,500 or less, except for construction contracts over \$2,000).

Contractor shall comply with all applicable FTA regulations, policies, procedures and directives, including without limitation those listed directly or by reference in the Master Agreement between the purchaser and FTA, as they may be amended or promulgated from time to time during the term of the contract. Contractor's failure to comply shall constitute a material breach of the contract.

FLY AMERICA REQUIREMENTS

Applicability – all contracts involving transportation of persons or property, by air between the U.S. and/or places outside the U.S. These requirements do not apply to micro-purchases (\$3,500 or less, except for construction contracts over \$2,000).

Contractor shall comply with 49 USC 40118 (the "Fly America" Act) in accordance with General Services Administration regulations 41 CFR 301-10, stating that recipients and subrecipients of Federal funds and their contractors are required to use US Flag air carriers for US Government-financed international air travel and transportation of their personal effects or property, to the extent such service is available, unless travel by foreign air carrier is a matter of necessity, as defined by the Fly America Act. Contractor shall submit, if a foreign air carrier was used, an appropriate certification or memorandum adequately explaining why service by a US flag air carrier was not available or why it was necessary to use a foreign air carrier and shall, in any event, provide a certificate of compliance with the Fly America requirements. Contractor shall include the requirements of this section in all subcontracts that may involve international air transportation.

GOVERNMENT WIDE DEBARMENT AND SUSPENSION (NON-PROCUREMENT)

Applicability – all contracts more than \$25,000.

The Recipient agrees to the following:

1. It will comply with the requirements of 2 C.F.R. part 180, subpart C, as adopted and supplemented by U.S. DOT regulations at 2 C.F.R. part 1200, which include the following: (a) It will not enter into any arrangement to participate in the development or implementation of the Project with any Third Party Participant that is debarred or suspended except as authorized by: 1 U.S. DOT regulations, "Nonprocurement Suspension and Debarment," 2 C.F.R. part 1200, 2 U.S. OMB, "Guidelines to Agencies on Governmentwide Debarment and Suspension (Nonprocurement)," 2 C.F.R. part 180, including any amendments thereto, and 3 Executive Orders Nos. 12549 and 12689, "Debarment and Suspension," 31 U.S.C. § 6101 note, (b) It will review the U.S. GSA "System for Award Management," <http://https.www.sam.gov,.proxy1.semalt.design> if required by U.S. DOT regulations, 2 C.F.R. part 1200, and (c) It will include, and require each of its Third Party Participants to include, a similar provision in each lower tier covered transaction, ensuring that each lower tier Third Party Participant: 1 Will comply with Federal debarment and suspension requirements, and 2 Reviews the "System for Award Management" at <http://https.www.sam.gov,.proxy1.semalt.design> if necessary to comply with U.S. DOT regulations, 2 C.F.R. part 1200.
2. If the Recipient suspends, debars, or takes any similar action against a Third Party Participant or individual, the Recipient will provide immediate written notice to the: (a) FTA Regional Counsel for the Region in which the Recipient is located or implements the Project, (b) FTA Project Manager if the Project is administered by an FTA Headquarters Office, or (c) FTA Chief Counsel.

CONTRACTOR / COMPANY NAME

NAME, TITLE AND SIGNATURE OF CONTRACTOR'S AUTHORIZED OFFICIAL:

TYPE OR PRINT NAME	TITLE	
SIGNATURE 	DATE	

INCORPORATION OF FEDERAL TRANSIT ADMINISTRATION (FTA) TERMS

Applicability – all contracts except micro-purchases (\$3,500 or less, except for construction contracts over \$2,000).

The preceding provisions include, in part, certain Standard Terms & Conditions required by USDOT, whether or not expressly stated in the preceding contract provisions. All USDOT-required contractual provisions, as stated in FTA Circular 4220.1F, are hereby incorporated by reference. Anything to the contrary herein notwithstanding, all FTA mandated terms shall be deemed to control in the event of a conflict with other provisions contained in this Agreement. The contractor shall not perform any act, fail to perform any act, or refuse to comply with any request that would cause the recipient to be in violation of FTA terms and conditions.

LOBBYING

Applicability – construction/architectural and engineering/acquisition of rolling stock/professional service contract/operational service contract/turnkey contracts over \$150,000.

Byrd Anti-Lobbying Amendment, 31 U.S.C. 1352, as amended by the Lobbying Disclosure Act of 1995, P.L. 104- 65 [to be codified at 2 U.S.C. § 1601, et seq.] - Contractors who apply or bid for an award of \$150,000 or more shall file the certification required by 49 CFR part 20, "New Restrictions on Lobbying." Each tier certifies to the tier above that it will not and has not used Federal appropriated funds to pay any person or organization for influencing or attempting to influence an officer or employee of any agency, a member of Congress, officer or employee of Congress, or an employee of a member of Congress in connection with obtaining any Federal contract, grant or any other award covered by 31 U.S.C. 1352. Each tier shall also disclose the name of any registrant under the Lobbying Disclosure Act of 1995 who has made lobbying contacts on its behalf with non-Federal funds with respect to that Federal contract, grant or award covered by 31 U.S.C. 1352. Such disclosures are forwarded from tier to tier up to the recipient.

This certification is a material representation of fact upon which reliance was placed when this transaction was made or entered into. Submission of this certification is a prerequisite for making or entering into this transaction imposed by 31 U.S.C. § 1352 (as amended by the Lobbying Disclosure Act of 1995). Any person who fails to file the required certification shall be subject to a civil penalty of not less than \$10,000 and not more than \$100,000 for each such failure.

CONTRACTOR / COMPANY NAME

NAME, TITLE AND SIGNATURE OF CONTRACTOR'S AUTHORIZED OFFICIAL:

TYPE OR PRINT NAME	TITLE	
SIGNATURE 	DATE	

NO GOVERNMENT OBLIGATION TO THIRD PARTIES

Applicability – all contracts except micro-purchases (\$3,500 or less, except for construction contracts over \$2,000).

1. The recipient and contractor acknowledge and agree that, notwithstanding any concurrence by the US Government in or approval of the solicitation or award of the underlying contract, absent the express written consent by the US Government, the US Government is not a party to this contract and shall not be subject to any obligations or liabilities to the recipient, the contractor, or any other

party (whether or not a party to that contract) pertaining to any matter resulting from the underlying contract.

2. Contractor agrees to include the above clause in each subcontract financed in whole or in part with FTA assistance. It is further agreed that the clause shall not be modified, except to identify the subcontractor who will be subject to its provisions.

PRE-AWARD AND POST DELIVERY AUDITS REQUIREMENTS

Applicability – any rolling stock procurement.

49 U.S.C. 5323/49 CFR Part 663

The Contractor agrees to comply with 49 U.S.C. § 5323(l) and FTA's implementing regulation at 49 C.F.R. Part 663 and to submit the following certifications:

1. Buy America Requirements: The Contractor shall complete and submit a declaration certifying either compliance or noncompliance with Buy America. If the Bidder/Offeror certifies compliance with Buy America, it shall submit documentation which lists 1) component and subcomponent parts of the rolling stock to be purchased identified by manufacturer of the parts, their country of origin and costs; and 2) the location of the final assembly point for the rolling stock, including a description of the activities that will take place at the final assembly point and the cost of final assembly.
2. Solicitation Specification Requirements: The Contractor shall submit evidence that it will be capable of meeting the bid specifications.
3. Federal Motor Vehicle Safety Standards (FMVSS): The Contractor shall submit 1) manufacturer's FMVSS self-certification sticker information that the vehicle complies with relevant FMVSS or 2) manufacturer's certified statement that the contracted buses will not be subject to FMVSS regulations.

PROGRAM FRAUD AND FALSE OR FRAUDULENT STATEMENTS OR RELATED ACTS

Applicability – all contracts except micro-purchases (\$3,500 or less, except for construction contracts over \$2,000).

1. Contractor acknowledges that the provisions of the Program Fraud Civil Remedies Act of 1986, as amended, 31 USC 3801 et seq. and USDOT regulations, "Program Fraud Civil Remedies," 49 CFR 31, apply to its actions pertaining to this project. Upon execution of the underlying contract, contractor certifies or affirms the truthfulness and accuracy of any statement it has made, it makes, it may make, or causes to be made, pertaining to the underlying contract or FTA assisted project for which this contract work is being performed. In addition to other penalties that may be applicable, contractor further acknowledges that if it makes, or causes to be made, a false, fictitious, or fraudulent claim, statement, submittal, or certification, the US Government reserves the right to impose the penalties of the Program Fraud Civil Remedies Act (1986) on contractor to the extent the US Government deems appropriate.
2. If contractor makes, or causes to be made, a false, fictitious, or fraudulent claim, statement, submittal, or certification to the US Government under a contract connected with a project that is financed in whole or in part with FTA assistance under the authority of 49 USC 5307, the Government reserves the right to impose the penalties of 18 USC 1001 and 49 USC 5307(n)(1) on contractor, to the extent the US Government deems appropriate.
3. Contractor shall include the above two clauses in each subcontract financed in whole or in part with FTA assistance. The clauses shall not be modified, except to identify the subcontractor who will be subject to the provisions.

PROMPT PAYMENT

Applicability – all contracts except micro-purchases (\$3,500 or less, except for construction contracts over \$2,000).

The prime contractor agrees to pay each subcontractor under this prime contract for satisfactory performance of its contract no later than 30 days from the receipt of each payment the prime contract receives from the Recipient. The prime contractor agrees further to return retainage payments to each subcontractor within 30 days after the subcontractors work is satisfactorily completed. Any delay or

postponement of payment from the above referenced time frame may occur only for good cause following written approval of the Recipient. This clause applies to both DBE and non-DBE subcontracts.

RECYCLED PRODUCTS

Applicability – all contracts for items designated by the EPA, when the purchaser or contractor procures \$10,000 or more of one of these items during the current or previous fiscal year using Federal funds. The contractor agrees to comply with all the requirements of Section 6002 of the Resource Conservation and Recovery Act (RCRA), as amended (42 U.S.C. 6962), including but not limited to the regulatory provisions of 40 CFR Part 247, and Executive Order 12873, as they apply to the procurement of the items designated in Subpart B of 40 CFR Part 247.

TERMINATION

Applicability – all Contracts more than \$10,000, except contracts with nonprofit organizations and institutions of higher learning, where the threshold is \$150,000.

- a. Termination for Convenience (General Provision) the recipient may terminate this contract, in whole or in part, at any time by written notice to contractor when it is in the recipient's best interest. Contractor shall be paid its costs, including contract close-out costs, and profit on work performed up to the time of termination. Contractor shall promptly submit its termination claim to the recipient. If contractor is in possession of any of the recipient's property, contractor shall account for same, and dispose of it as the recipient directs.
- b. Termination for Default [Breach or Cause] (General Provision) If contractor does not deliver items in accordance with the contract delivery schedule, or, if the contract is for services, and contractor fails to perform in the manner called for in the contract, or if contractor fails to comply with any other provisions of the contract, the recipient may terminate this contract for default. Termination shall be effected by serving a notice of termination to contractor setting forth the manner in which contractor is in default. Contractor shall only be paid the contract price for supplies delivered and accepted, or for services performed in accordance with the manner of performance set forth in the contract. If it is later determined by the recipient that contractor had an excusable reason for not performing, such as a strike, fire, or flood, events which are not the fault of or are beyond the control of contractor, the recipient, after setting up a new delivery or performance schedule, may allow contractor to continue work, or treat the termination as a termination for convenience.
- c. Opportunity to Cure (General Provision) the recipient in its sole discretion may, in the case of a termination for breach or default, allow contractor an appropriately short period of time in which to cure the defect. In such case, the notice of termination shall state the time period in which cure is permitted and other appropriate conditions. If contractor fails to remedy to the recipient's satisfaction the breach or default or any of the terms, covenants, or conditions of this Contract within ten (10) days after receipt by contractor or written notice from the recipient setting forth the nature of said breach or default, the recipient shall have the right to terminate the Contract without any further obligation to contractor. Any such termination for default shall not in any way operate to preclude the recipient from also pursuing all available remedies against contractor and its sureties for said breach or default.
- d. Waiver of Remedies for any Breach In the event that the recipient elects to waive its remedies for any breach by contractor of any covenant, term or condition of this Contract, such waiver by the recipient shall not limit its remedies for any succeeding breach of that or of any other term, covenant, or condition of this Contract.
- e. Termination for Convenience (Professional or Transit Service Contracts) the recipient, by written notice, may terminate this contract, in whole or in part, when it is in the recipient's interest. If the contract is terminated, the recipient shall be liable only for payment under the payment provisions of this contract for services rendered before the effective date of termination.
- f. Termination for Default (Supplies and Service) If contractor fails to deliver supplies or to perform the services within the time specified in this contract or any extension or if the contractor fails to comply with any other provisions of this contract, the recipient may terminate this contract for default. The recipient shall terminate by delivering to contractor a notice of termination specifying the nature of default. Contractor shall only be paid the contract price for supplies delivered and accepted, or services performed in accordance with the manner or performance set forth in this contract. If, after termination for failure to fulfill contract obligations, it is determined that contractor

was not in default, the rights and obligations of the parties shall be the same as if termination had been issued for the recipient's convenience.

- g. Termination for Default (Transportation Services) If contractor fails to pick up the commodities or to perform the services, including delivery services, within the time specified in this contract or any extension or if contractor fails to comply with any other provisions of this contract, the recipient may terminate this contract for default. The recipient shall terminate by delivering to contractor a notice of termination specifying the nature of default. Contractor shall only be paid the contract price for services performed in accordance with the manner of performance set forth in this contract. If this contract is terminated while contractor has possession of the recipient goods, contractor shall, as directed by the recipient, protect and preserve the goods until surrendered to the recipient or its agent. Contractor and the recipient shall agree on payment for the preservation and protection of goods. Failure to agree on an amount shall be resolved under the Dispute clause. If, after termination for failure to fulfill contract obligations, it is determined that contractor was not in default, the rights and obligations of the parties shall be the same as if termination had been issued for the recipient's convenience.
- h. Termination for Default (Construction) If contractor refuses or fails to prosecute the work or any separable part, with the diligence that will insure its completion within the time specified, or any extension, or fails to complete the work within this time, or if contractor fails to comply with any other provisions of this contract, the recipient may terminate this contract for default. the recipient shall terminate by delivering to contractor a notice of termination specifying the nature of default. In this event, the recipient may take over the work and complete it by contract or otherwise, and may take possession of and use any materials, appliances, and plant on the work site necessary for completing the work. Contractor and its sureties shall be liable for any damage to the recipient resulting from contractor's refusal or failure to complete the work within specified time, whether or not contractor's right to proceed with the work is terminated. This liability includes any increased costs incurred by the recipient in completing the work. Contractor's right to proceed shall not be terminated nor shall contractor be charged with damages under this clause if:
- I. Delay in completing the work arises from unforeseeable causes beyond the control and without the fault or negligence of contractor. Examples of such causes include: acts of God, acts of the recipient, acts of another contractor in the performance of a contract with the recipient, epidemics, quarantine restrictions, strikes, freight embargoes; and
 - II. Contractor, within 10 days from the beginning of any delay, notifies the recipient in writing of the causes of delay. If in the recipient's judgment, delay is excusable, the time for completing the work shall be extended. The recipient's judgment shall be final and conclusive on the parties, but subject to appeal under the Disputes clauses. If, after termination of contractor's right to proceed, it is determined that contractor was not in default, or that the delay was excusable, the rights and obligations of the parties will be the same as if termination had been issued for the recipient's convenience.
- i. Termination for Convenience or Default (Architect & Engineering) the recipient may terminate this contract in whole or in part, for the recipient's convenience or because of contractor's failure to fulfill contract obligations. The recipient shall terminate by delivering to contractor a notice of termination specifying the nature, extent, and effective date of termination. Upon receipt of the notice, contractor shall
- I. immediately discontinue all services affected (unless the notice directs otherwise), and
 - II. deliver to the recipient all data, drawings, specifications, reports, estimates, summaries, and other information and materials accumulated in performing this contract, whether completed or in process. If termination is for the recipient's convenience, it shall make an equitable adjustment in the contract price but shall allow no anticipated profit on unperformed services. If termination is for contractor's failure to fulfill contract obligations, the recipient may complete the work by contract or otherwise and contractor shall be liable for any additional cost incurred by the recipient. If, after termination for failure to fulfill contract obligations, it is determined that contractor was not in default, the rights and obligations of the parties shall be the same as if termination had been issued for the recipient's convenience.
- j. Termination for Convenience or Default (Cost-Type Contracts) the recipient may terminate this contract, or any portion of it, by serving a notice of termination on contractor. The notice shall state whether termination is for convenience of the recipient or for default of contractor. If termination is for default, the notice shall state the manner in which contractor has failed to perform the

requirements of the contract. Contractor shall account for any property in its possession paid for from funds received from the recipient, or property supplied to contractor by the recipient. If termination is for default, the recipient may fix the fee, if the contract provides for a fee, to be paid to contractor in proportion to the value, if any, of work performed up to the time of termination. Contractor shall promptly submit its termination claim to the recipient and the parties shall negotiate the termination settlement to be paid to contractor. If termination is for the recipient's convenience, contractor shall be paid its contract closeout costs, and a fee, if the contract provided for payment of a fee, in proportion to the work performed up to the time of termination. If, after serving a notice of termination for default, the recipient determines that contractor has an excusable reason for not performing, such as strike, fire, flood, events which are not the fault of and are beyond the control of contractor, the recipient, after setting up a new work schedule, may allow contractor to continue work, or treat the termination as a termination for convenience.

**ROLLING STOCK
MORE THAN \$150,000**

ACCESS TO RECORDS AND REPORTS

Applicability – as shown below. These requirements do not apply to micro-purchases (\$3,500 or less, except for construction contracts over \$2,000).

The following access to records requirements apply to this Contract:

1. Where the purchaser is not a State but a local government and is an FTA recipient or a subgrantee of FTA recipient in accordance with 49 CFR 18.36(i), contractor shall provide the purchaser, the FTA, the US Comptroller General or their authorized representatives access to any books, documents, papers and contractor records which are pertinent to this contract for the purposes of making audits, examinations, excerpts and transcriptions. Contractor shall also, pursuant to 49 CFR 633.17, provide authorized FTA representatives, including any PMO contractor, access to contractor's records and construction sites pertaining to a capital project, defined at 49 USC 5302(a)1, which is receiving FTA assistance through the programs described at 49 USC 5307, 5309 or 5311.
2. Where the purchaser is a State and is an FTA recipient or a subgrantee of FTA recipient in accordance with 49 CFR 633.17, contractor shall provide the purchaser, authorized FTA representatives, including any PMO Contractor, access to contractor's records and construction sites pertaining to a capital project, defined at 49 USC 5302(a)1, which receives FTA assistance through the programs described at 49 USC 5307, 5309 or 5311. By definition, a capital project excludes contracts of less than the simplified acquisition threshold currently set at \$150,000.
3. Where the purchaser enters into a negotiated contract for other than a small purchase or under the simplified acquisition threshold and is an institution of higher education, a hospital or other non-profit organization and is an FTA recipient or a subgrantee of FTA recipient in accordance with 49 CFR 19.48, contractor shall provide the purchaser, the FTA, the US Comptroller General or their authorized representatives, access to any books, documents, papers and record of the contractor which are directly pertinent to this contract for the purposes of making audits, examinations, excerpts and transcriptions.
4. Where a purchaser which is an FTA recipient or a subgrantee of FTA recipient in accordance with 49 USC 5325(a) enters into a contract for a capital project or improvement (defined at 49 USC 5302(a)1) through other than competitive bidding, contractor shall make available records related to the contract to the purchaser, the Secretary of USDOT and the US Comptroller General or any authorized officer or employee of any of them for the purposes of conducting an audit and inspection.
5. Contractor shall permit any of the foregoing parties to reproduce by any means whatsoever or to copy excerpts and transcriptions as reasonably needed.
6. Contractor shall maintain all books, records, accounts and reports required under this contract for a period of not less than three (3) years after the date of termination or expiration of this contract, except in the event of litigation or settlement of claims arising from the performance of this contract, in which case contractor agrees to maintain same until the recipient, FTA Administrator, US Comptroller General, or any of their authorized representatives, have disposed of all such litigation, appeals, claims or exceptions related thereto. Re: 49 CFR 18.39(i)(11). FTA does not require the inclusion of these requirements in subcontracts.

BREACHES AND DISPUTE RESOLUTION

Applicability – all contracts more than \$150,000.

Disputes arising in the performance of this contract which are not resolved by agreement of the parties shall be decided in writing by the recipient's authorized representative. This decision shall be final and conclusive unless within ten (10) days from the date of receipt of its copy, contractor mails or otherwise furnishes a written appeal to the recipient's CEO. In connection with such appeal, contractor shall be afforded an opportunity to be heard and to offer evidence in support of its position. The decision of the recipient's CEO shall be binding upon contractor and contractor shall abide by the decision. FTA has a vested interest in

the settlement of any violation of Federal law including the the False Claims Act, 31 U.S.C. § 3729. Performance During Dispute - Unless otherwise directed by the recipient, contractor shall continue performance under this contract while matters in dispute are being resolved. Claims for Damages - Should either party to the contract suffer injury or damage to person or property because of any act or omission of the party or of any of his employees, agents or others for whose acts he is legally liable, a claim for damages therefore shall be made in writing to such other party within ten days after the first observance of such injury or damage. Remedies - Unless this contract provides otherwise, all claims, counterclaims, disputes and other matters in question between the recipient and contractor arising out of or relating to this agreement or its breach will be decided by arbitration if the parties mutually agree, or in a court of competent jurisdiction within the residing State. Rights and Remedies - Duties and obligations imposed by the contract documents and the rights and remedies available thereunder shall be in addition to and not a limitation of any duties, obligations, rights and remedies otherwise imposed or available by law. No action or failure to act by the recipient or contractor shall constitute a waiver of any right or duty afforded any of them under the contract, nor shall any such action or failure to act constitute an approval of or acquiescence in any breach thereunder, except as may be specifically agreed in writing

BUS TESTING

Applicability – all contracts more than \$150,000.

Contractor [manufacturer] shall comply with 49 USC A5323(c) and FTA's implementing regulation 49 CFR 665, to the extent they are consistent with 49 U.S.C. § 5318(e), as amended; and shall perform the following:

1. A manufacturer of a new bus model or a bus produced with a major change in components or configuration shall provide a copy of the final test report to the recipient prior to the recipient's final acceptance of the first vehicle.
2. A manufacturer who releases a report under para. 1 above shall provide notice to the operator of the testing facility that the report is available to the public.
3. If the manufacturer represents that the vehicle was previously tested, the vehicle being sold should have the identical configuration and major components as the vehicle in the test report, which must be provided to the recipient prior to the recipient's final acceptance of the first vehicle. If configuration or components are not identical, the manufacturer shall provide a description of the change and the manufacturer's basis for concluding that it is not a major change requiring additional testing.
4. If the manufacturer represents that the vehicle is "grandfathered" (has been used in mass transit service in the US before Oct. 1, 1988 and is currently being produced without a major change in configuration or components), the manufacturer shall provide the name and address of the recipient of such a vehicle and the details of that vehicle's configuration and major components.

CERTIFICATION OF COMPLIANCE WITH FTA'S BUS TESTING REQUIREMENTS The undersigned [Contractor/Manufacturer] certifies that the vehicle offered in this procurement complies with 49 U.S.C. A 5323(c) and FTA's implementing regulation at 49 CFR Part 665.

The undersigned understands that misrepresenting the testing status of a vehicle acquired with Federal financial assistance may subject the undersigned to civil penalties as outlined in the Department of Transportation's regulation on Program Fraud Civil Remedies, 49 CFR Part 31. In addition, the undersigned understands that FTA may suspend or debar a manufacturer under the procedures in 49 CFR Part 29.

CONTRACTOR / COMPANY NAME

NAME, TITLE AND SIGNATURE OF CONTRACTOR'S AUTHORIZED OFFICIAL:

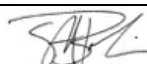
TYPE OR PRINT NAME	TITLE
SIGNATURE 	DATE

BUY AMERICA CERTIFICATION (ROLLING STOCK)

Applicability – construction contracts and acquisition of goods or rolling stock (valued at more than \$150,000).

Construction Contracts and Acquisition of Goods or Rolling Stock (valued at more than \$150,000)

Contractor shall comply with 49 USC 5323(j) and 49 CFR 661, as amended by MAP-21 stating that Federal funds may not be obligated unless steel, iron and manufactured products used in FTA-funded projects are produced in the United States, unless a waiver has been granted by FTA or the product is subject to a general waiver. General waivers are listed in 49 CFR 661.7, and include software, microcomputer equipment and small purchases (currently less than \$150,000) made with capital, operating or planning funds. Separate requirements for rolling stock are stated at 5323(j)(2)(C) and 49 CFR 661.11 and as amended by Map-21 (5325). Rolling stock must be manufactured in the US and have a minimum 60% domestic content and adhere to contract term limitations. A bidder or offeror shall submit appropriate Buy America certification to the recipient with all bids on FTA-funded contracts, except those subject to a general waiver. Proposals not accompanied by a completed Buy America certification shall be rejected as nonresponsive. This requirement does not apply to lower tier subcontractors.

Certificate of **Compliance** with Buy America Requirements.

The bidder or offeror hereby certifies that it will comply with the requirements of 49 U.S.C. 5323(j)(1), and the applicable regulations in 49 CFR part 661.

Only sign either Certificate of **Compliance** or Certificate of **Non-Compliance**

CONTRACTOR / COMPANY NAME

NAME, TITLE AND SIGNATURE OF CONTRACTOR'S AUTHORIZED OFFICIAL:

TYPE OR PRINT NAME	TITLE
SIGNATURE 	DATE

Only sign either Certificate of **Compliance** or Certificate of **Non-Compliance**

Certificate of **Non-Compliance** with Buy America Steel or Manufactured Products Requirements The bidder or offeror hereby certifies that it cannot comply with the requirements of 49 U.S.C. 5323(j), but it may qualify for an exception to the requirement pursuant to 49 U.S.C. 5323(j)(2), as amended, and the applicable regulations in 49 C.F.R. 661.7.

CONTRACTOR / COMPANY NAME

NAME, TITLE AND SIGNATURE OF CONTRACTOR'S AUTHORIZED OFFICIAL:

TYPE OR PRINT NAME	TITLE
SIGNATURE	DATE

CARGO PREFERENCE

Applicability – all contracts involving equipment, materials or commodities which may be transported by ocean vessels. These requirements do not apply to micro-purchases (\$3,500 or less, except for construction contracts over \$2,000).

Contractor shall: a. use privately owned US-Flag commercial vessels to ship at least 50% of the gross tonnage (computed separately for dry bulk carriers, dry cargo liners and tankers) involved, whenever shipping any equipment, material or commodities pursuant to the underlying contract to the extent such vessels are available at fair and reasonable rates for US flag commercial vessels; b. furnish within 20 working days following the loading date of shipments originating within the US or within 30 working days following the loading date of shipments originating outside the US, a legible copy of a rated, "on-board" commercial bill-of-lading in English for each shipment of cargo described herein to the Division of National Cargo, Office of Market Development, Maritime Administration, Washington, DC 20590 and to the recipient (through contractor in the case of a subcontractor's bill-of-lading.); c. include these requirements in all subcontracts issued pursuant to this contract when the subcontract involves the transport of equipment, material or commodities by ocean vessel.

CIVIL RIGHTS REQUIREMENTS

Applicability – All contracts except micro-purchases (\$3,500 or less, except for construction contracts over \$2,000).

The following requirements apply to the underlying contract: The Recipient understands and agrees that it must comply with applicable Federal civil rights laws and regulations, and follow applicable Federal guidance, except as the Federal Government determines otherwise in writing. Therefore, unless a Recipient or Program, including an Indian Tribe or the Tribal Transit Program, is specifically exempted from a civil rights statute, FTA requires compliance with that civil rights statute, including compliance with equity in service: a. Nondiscrimination in Federal Public Transportation Programs. The Recipient agrees to, and assures that each Third-Party Participant will, comply with Federal transit law, 49 U.S.C. § 5332 (FTA's "Nondiscrimination" statute):

- a. FTA's "Nondiscrimination" statute prohibits discrimination on the basis of: (a) Race, (b) Color, (c) Religion, (d) National origin, (e) Sex, (f) Disability, (g) Age, or (h) Gender identity and (2) The FTA "Nondiscrimination" statute's prohibition against discrimination includes: (a) Exclusion from participation, (b) Denial of program benefits, or (c) Discrimination, including discrimination in employment or business opportunity, (3) Except as FTA determines otherwise in writing: (a) General. Follow: 1 The most recent edition of FTA Circular 4702.1, "Title VI Requirements and Guidelines for Federal Transit Administration Recipients," to the extent consistent with applicable Federal laws, regulations, and guidance, and 2 Other applicable Federal guidance that may be issued, but (b) Exception for the Tribal Transit Program. FTA does not require an Indian Tribe to comply with FTA program-specific guidelines for Title VI when administering its projects funded under the Tribal Transit Program,
- b. Nondiscrimination – Title VI of the Civil Rights Act. The Recipient agrees to, and assures that each Third Party Participant will: (1) Prohibit discrimination based on: (a) Race, (b) Color, or (c) National origin, (2) Comply with: (a) Title VI of the Civil Rights Act of 1964, as amended, 42 U.S.C. § 2000d et seq., (b) U.S. DOT regulations, "Nondiscrimination in Federally-Assisted Programs of the Department of Transportation – Effectuation of Title VI of the Civil Rights Act of 1964," 49 C.F.R. part 21, and (c) Federal transit law, specifically 49 U.S.C. § 5332, as stated in the preceding section a, and (3) Except as FTA determines otherwise in writing, follow: (a) The most recent edition of FTA Circular 4702.1, "Title VI and Title VI-Dependent Guidelines for Federal Transit Administration Recipients," to the extent consistent with applicable Federal laws, regulations, and guidance. (b) U.S. DOJ, "Guidelines for the enforcement of Title VI, Civil Rights Act of 1964," 28 C.F.R. § 50.3, and (c) Other applicable Federal guidance that may be issued,
- c. Equal Employment Opportunity. (1) Federal Requirements and Guidance. The Recipient agrees to, and assures that each Third Party Participant will, prohibit discrimination on the basis of race, color, religion, sex, or national origin, and: (a) Comply with Title VII of the Civil Rights Act of 1964, as amended, 42 U.S.C. § 2000e et seq., (b) Facilitate compliance with Executive Order No. 11246, "Equal Employment Opportunity," as amended by Executive Order No. 11375, "Amending Executive Order No. 11246, Relating to Equal Employment Opportunity," 42 U.S.C. § 2000e note, (c) Comply with Federal transit law, specifically 49 U.S.C. § 5332, as stated in section a, and (d) Comply with other applicable EEO laws and regulations, as provided in Federal guidance, including

laws and regulations prohibiting discrimination on the basis of disability, except as the Federal Government determines otherwise in writing, (2) General. The Recipient agrees to: (a) Ensure that applicants for employment are employed and employees are treated during employment without discrimination on the basis of their: 1 Race, 2 Color, 3 Religion, 4 Sex, 5 Disability, 6 Age, or 7 National origin, (b) Take affirmative action that includes, but is not limited to: 1 Recruitment advertising, 2 Recruitment, 3 Employment, 4 Rates of pay, 5 Other forms of compensation, 6 Selection for training, including apprenticeship, 7 Upgrading, 8 Transfers, 9 Demotions, 10 Layoffs, and 11 Terminations, but (b) Indian Tribe. Title VII of the Civil Rights Act of 1964, as amended, exempts Indian Tribes under the definition of "Employer". (3) Equal Employment Opportunity Requirements for Construction Activities. In addition to the foregoing, when undertaking "construction" as recognized by the U.S. Department of Labor (U.S. DOL), the Recipient agrees to comply, and assures the compliance of each Third Party Participant, with: (a) U.S. DOL regulations, "Office of Federal Contract Compliance Programs, Equal Employment Opportunity, Department of Labor," 41 C.F.R. chapter 60, and (b) Executive Order No. 11246, "Equal Employment Opportunity," as amended by Executive Order No. 11375, "Amending Executive Order No. 11246, Relating to Equal Employment Opportunity," 42 U.S.C. § 2000e note,

- d. Disadvantaged Business Enterprise. To the extent authorized by applicable Federal law, the Recipient agrees to facilitate, and assures that each Third-Party Participant will facilitate, participation by small business concerns owned and controlled by socially and economically disadvantaged individuals, also referred to as "Disadvantaged Business Enterprises" (DBEs), in the Project as follows: 1) Requirements. The Recipient agrees to comply with: (a) Section 1101(b) of MAP-21, 23 U.S.C. § 101 note, (b) U.S. DOT regulations, "Participation by Disadvantaged Business Enterprises in Department of Transportation Financial Assistance Programs," 49 C.F.R. part 26, and (c) Federal transit law, specifically 49 U.S.C. § 5332, as stated in section a, (2) Assurance. As required by 49 C.F.R. § 26.13(a), (b) DBE Program Requirements. Recipients receiving planning, capital and/or operating assistance that will award prime third-party contracts exceeding \$250,000 in a Federal fiscal year must: 1 Have a DBE program meeting the requirements of 49 C.F.R. part 26, 2 Implement a DBE program approved by FTA, and 3 Establish an annual DBE participation goal, (c) Special Requirements for a Transit Vehicle Manufacturer. The Recipient understands and agrees that each transit vehicle manufacturer, as a condition of being authorized to bid or propose on FTA-assisted transit vehicle procurements, must certify that it has complied with the requirements of 49 C.F.R. part 26, (d) the Recipient provides assurance that: The Recipient shall not discriminate on the basis of race, color, national origin, or sex in the award and performance of any DOT-assisted contract or in the administration of its DBE program or the requirements of 49 C.F.R. part 26. The Recipient shall take all necessary and reasonable steps under 49 C.F.R. part 26 to ensure nondiscrimination in the award and administration of DOT-assisted contracts. The Recipient's DBE program, as required by 49 C.F.R. part 26 and as approved by DOT, is incorporated by reference in this agreement. Implementation of this program is a legal obligation and failure to carry out its terms shall be treated as a violation of this agreement. Upon notification to the Recipient of its failure to carry out its approved program, the Department may impose sanctions as provided for under 49 C.F.R. part 26 and may, in appropriate cases, refer the matter for enforcement under 18 U.S.C. § 1001 and/or the Program Fraud Civil Remedies Act of 1986, 31 U.S.C. § 3801 et seq., (2) Exception for the Tribal Transit Program. FTA exempts Indian tribes from the Disadvantaged Business Enterprise regulations at 49 C.F.R. part 26 under MAP-21 and previous legislation,
- e. Nondiscrimination on the Basis of Sex. The Recipient agrees to comply with Federal prohibitions against discrimination on the basis of sex, including: (1) Title IX of the Education Amendments of 1972, as amended, 20 U.S.C. § 1681 et seq., (2) U.S. DOT regulations, "Nondiscrimination on the Basis of Sex in Education Programs or Activities Receiving Federal Financial Assistance," 49 C.F.R. part 25, and (3) Federal transit law, specifically 49 U.S.C. § 5332, as stated in section a,
- f. Nondiscrimination on the Basis of Age. The Recipient agrees to comply with Federal prohibitions against discrimination on the basis of age, including: (1) The Age Discrimination in Employment Act (ADEA), 29 U.S.C. §§ 621 – 634, which prohibits discrimination on the basis of age, (2) U.S. Equal Employment Opportunity Commission (U.S. EEOC) regulations, "Age Discrimination in Employment Act," 29 C.F.R. part 1625, which implements the ADEA, (3) The Age Discrimination Act of 1975, as amended, 42 U.S.C. § 6101 et seq., which prohibits discrimination against individuals on the basis of age in the administration of programs or activities receiving Federal funds, (4) U.S. Health and Human Services regulations, "Nondiscrimination on the Basis of Age in Programs or Activities Receiving Federal Financial Assistance," 45 C.F.R. part 90, which

- implements the Age Discrimination Act of 1975, and (5) Federal transit law, specifically 49 U.S.C. § 5332, as stated in section a,
- g. Nondiscrimination on the Basis of Disability. The Recipient agrees to comply with the following Federal prohibitions pertaining to discrimination against seniors or individuals with disabilities: (1) Federal laws, including: (a) Section 504 of the Rehabilitation Act of 1973, as amended, 29 U.S.C. § 794, which prohibits discrimination on the basis of disability in the administration of federally funded programs or activities, (b) The Americans with Disabilities Act of 1990 (ADA), as amended, 42 U.S.C. § 12101 et seq., which requires that accessible facilities and services be made available to individuals with disabilities, 1 General. Titles I, II, and III of the ADA apply to FTA Recipients, but 2 Indian Tribes. While Titles II and III of the ADA apply to Indian Tribes, Title I of the ADA exempts Indian Tribes from the definition of “employer,” (c) The Architectural Barriers Act of 1968, as amended, 42 U.S.C. § 4151 et seq., which requires that buildings and public accommodations be accessible to individuals with disabilities, (d) Federal transit law, specifically 49 U.S.C. § 5332, which now includes disability as a prohibited basis for discrimination, and (e) Other applicable laws and amendments pertaining to access for elderly individuals or individuals with disabilities, (2) Federal regulations, including: (a) U.S. DOT regulations, “Transportation Services for Individuals with Disabilities (ADA),” 49 C.F.R. part 37, (b) U.S. DOT regulations, “Nondiscrimination on the Basis of Disability in Programs and Activities Receiving or Benefiting from Federal Financial Assistance,” 49 C.F.R. part 27, (c) U.S. DOT regulations, “Transportation for Individuals with Disabilities: Passenger Vessels,” 49 C.F.R. part 39, (d) Joint U.S. Architectural and Transportation Barriers Compliance Board (U.S. ATBCB) and U.S. DOT regulations, “Americans With Disabilities (ADA) Accessibility Specifications for Transportation Vehicles,” 36 C.F.R. part 1192 and 49 C.F.R. part 38, (e) U.S. DOJ regulations, “Nondiscrimination on the Basis of Disability in State and Local Government Services,” 28 C.F.R. part 35, (f) U.S. DOJ regulations, “Nondiscrimination on the Basis of Disability by Public Accommodations and in Commercial Facilities,” 28 C.F.R. part 36, (g) U.S. EEOC, “Regulations to Implement the Equal Employment Provisions of the Americans with Disabilities Act,” 29 C.F.R. part 1630, (h) U.S. Federal Communications Commission regulations, “Telecommunications Relay Services and Related Customer Premises Equipment for Persons with Disabilities,” 47 C.F.R. part 64, Subpart F, (i) U.S. ATBCB regulations, “Electronic and Information Technology Accessibility Standards,” 36 C.F.R. part 1194, and (j) FTA regulations, “Transportation for Elderly and Handicapped Persons,” 49 C.F.R. part 609, and (3) Other applicable Federal civil rights and nondiscrimination guidance,
 - h. Drug or Alcohol Abuse - Confidentiality and Other Civil Rights Protections. The Recipient agrees to comply with the confidentiality and civil rights protections of: (1) The Drug Abuse Office and Treatment Act of 1972, as amended, 21 U.S.C. § 1101 et seq., (2) The Comprehensive Alcohol Abuse and Alcoholism Prevention, Treatment and Rehabilitation Act of 1970, as amended, 42 U.S.C. § 4541 et seq., and (3) The Public Health Service Act, as amended, 42 U.S.C. §§ 290dd – 290dd-2,
 - i. Access to Services for People with Limited English Proficiency. Except as the Federal Government determines otherwise in writing, the Recipient agrees to promote accessibility of public transportation services to people whose understanding of English is limited by following: 1) Executive Order No. 13166, “Improving Access to Services for Persons with Limited English Proficiency,” August 11, 2000, 42 U.S.C. § 2000d-1 note, and (2) U.S. DOT Notice, “DOT Policy Guidance Concerning Recipients’ Responsibilities to Limited English Proficiency (LEP) Persons,” 70 Fed. Reg. 74087, December 14, 2005,
 - j. Other Nondiscrimination Laws. Except as the Federal Government determines otherwise in writing, the Recipient agrees to: (1) Comply with other applicable Federal nondiscrimination laws and regulations, and (2) Follow Federal guidance prohibiting discrimination.
 - k. Remedies. Remedies for failure to comply with applicable Federal Civil Rights laws and Federal regulations may be enforced as provided in those Federal laws or Federal regulations.

CLEAN AIR

Applicability – all contracts more than \$150,000.

1. Contractor shall comply with all applicable standards, orders or regulations pursuant to the Clean Air Act, 42 USC 7401 et seq. Contractor shall report each violation to the recipient and understands and agrees that the recipient will, in turn, report each violation as required to FTA and the appropriate EPA Regional Office.

2. Contractor shall include these requirements in each subcontract exceeding \$150,000 financed in whole or in part with FTA assistance.

CLEAN WATER

Applicability – all Contracts and Subcontracts more than \$150,000. Contractor shall comply with all applicable standards, orders or regulations issued pursuant to the Federal Water Pollution Control Act, as amended, 33 USC 1251 et seq. Contractor shall report each violation to the recipient and understands and agrees that the recipient shall, in turn, report each violation as required to FTA and the appropriate EPA Regional Office. Contractor shall include these requirements in each subcontract exceeding \$100,000 financed in whole or in part with FTA assistance.

CONTRACTS INVOLVING FEDERAL PRIVACY ACT REQUIREMENTS

Applicability – when a grantee maintains files on drug and alcohol enforcement activities for FTA, and those files are organized so that information could be retrieved by personal identifier, the Privacy Act requirements apply to all contracts except micro-purchases (\$3,500 or less, except for construction contracts over \$2,000).

The following requirements apply to the Contractor and its employees that administer any system of records on behalf of the Federal Government under any contract:

1. The Contractor agrees to comply with, and assures the compliance of its employees with, the information restrictions and other applicable requirements of the Privacy Act of 1974, 5 U.S.C. § 552a. Among other things, the Contractor agrees to obtain the express consent of the Federal Government before the Contractor or its employees operate a system of records on behalf of the Federal Government. The Contractor understands that the requirements of the Privacy Act, including the civil and criminal penalties for violation of that Act, apply to those individuals involved, and that failure to comply with the terms of the Privacy Act may result in termination of the underlying contract.
2. The Contractor also agrees to include these requirements in each subcontract to administer any system of records on behalf of the Federal Government financed in whole or in part with Federal assistance provided by FTA.

CONTRACT WORK HOURS & SAFETY STANDARDS ACT

Applicability – contracts over \$150,000.

- 1) Overtime requirements - No contractor or subcontractor contracting for any part of the contract work which may require or involve the employment of laborers or mechanics shall require or permit any such laborer or mechanic in any workweek in which he or she is employed on such work to work in excess of 40 hours in such workweek unless such laborer or mechanic receives compensation at a rate not less than one and one-half times the basic rate of pay for all hours worked in excess of 40 hours in such workweek.
- 2) Violation; liability for unpaid wages; liquidated damages - In the event of any violation of the clause set forth in para. (1) of this section, contractor and any subcontractor responsible therefore shall be liable for the unpaid wages. In addition, such contractor and subcontractor shall be liable for liquidated damages. Such liquidated damages shall be computed with respect to each individual laborer or mechanic, including watchmen and guards, employed in violation of the clause set forth in para. (1) of this section, in the sum of \$10 for each calendar day on which such individual was required or permitted to work in excess of the standard workweek of 40 hours without payment of the overtime wages required by the clause set forth in para. (1) of this section.
- 3) Withholding for unpaid wages and liquidated damages - the recipient shall upon its own action or upon written request of USDOL withhold or cause to be withheld, from any moneys payable on account of work performed by contractor or subcontractor under any such contract or any other Federal contract with the same prime contractor, or any other federally-assisted contract subject to the Contract Work Hours & Safety Standards Act, which is held by the same prime contractor, such sums as may be determined to be necessary to satisfy any liabilities of such contractor or subcontractor for unpaid wages and liquidated damages as provided in the clause set forth in para. (2) of this section.
- 4) Subcontracts - Contractor or subcontractor shall insert in any subcontracts the clauses set forth in this section and also a clause requiring the subcontractors to include these clauses in any

lower tier subcontracts. Prime contractor shall be responsible for compliance by any subcontractor or lower tier subcontractor with the clauses set forth in this section.

DISADVANTAGED BUSINESS ENTERPRISE (DBE)

Applicability – contracts over \$3,500 awarded on the basis of a bid or proposal offering to use DBEs.

- a. This contract is subject to the requirements of Title 49, Code of Federal Regulations, Part 26, Participation by Disadvantaged Business Enterprises in Department of Transportation Financial Assistance Programs. The national goal for participation of Disadvantaged Business Enterprises (DBE) is 10%. The recipient’s overall goal for DBE participation is listed elsewhere. If a separate contract goal for DBE participation has been established for this procurement, it is listed elsewhere.
- b. The contractor shall not discriminate on the basis of race, color, religion, national origin or sex in the performance of this contract. The contractor shall carry out applicable requirements of 49 CFR Part 26 in the award and administration of this contract. Failure by the contractor to carry out these requirements is a material breach of this contract, which may result in the termination of this contract or such other remedy as the municipal corporation deems appropriate. Each subcontract the contractor signs with a subcontractor must include the assurance in this paragraph (see 49 CFR 26.13(b)).
- c. If a separate contract goal has been established, Bidders/offerors are required to document sufficient DBE participation to meet these goals or, alternatively, document adequate good faith efforts to do so, as provided for in 49 CFR 26.53.
- d. If no separate contract goal has been established, the successful bidder/offeror will be required to report its DBE participation obtained through race-neutral means throughout the period of performance.
- e. The contractor is required to pay its subcontractors performing work related to this contract for satisfactory performance of that work no later than 30 days after the contractor’s receipt of payment for that work from the recipient. In addition, the contractor may not hold retainage from its subcontractors or must return any retainage payments to those subcontractors within 30 days after the subcontractor's work related to this contract is satisfactorily completed or must return any retainage payments to those subcontractors within 30 days after incremental acceptance of the subcontractor’s work by the recipient and contractor’s receipt of the partial retainage payment related to the subcontractor’s work.
- f. The contractor must promptly notify the recipient whenever a DBE subcontractor performing work related to this contract is terminated or fails to complete its work, and must make good faith efforts to engage another DBE subcontractor to perform at least the same amount of work. The contractor may not terminate any DBE subcontractor and perform that work through its own forces or those of an affiliate without prior written consent of the recipient.

DBE TRANSIT VEHICLE MANUFACTURER CERTIFICATION

_____, a TVM,
 (Name of Manufacturer)
 hereby certifies that it has complied with the requirement of Section 26.49 of 49 CFR, Part 26 by submitting a current annual DBE goal to FTA. The goals apply to Federal Fiscal Year _____ (October 1, _____ to September 30, _____) and have been approved or not disapproved by FTA.
 _____ hereby certifies that the manufacturer of the transit
 (Name of Contract Vendor)
 vehicle to be supplied _____ has complied with the above referenced
 (Name of Manufacturer)
 requirement of Section 26.49 of 49 CFR Part 26.

MANUFACTURER	TITLE	
SIGNATURE 	DATE	

ENERGY CONSERVATION

Applicability – all Contracts except micro-purchases (\$3,500 or less, except for construction contracts over \$2,000).

Contractor shall comply with mandatory standards and policies relating to energy efficiency, stated in the state energy conservation plan issued in compliance with the Energy Policy & Conservation Act.

FEDERAL CHANGES

Applicability – all Contracts except micro-purchases (\$3,500 or less, except for construction contracts over \$2,000).

Contractor shall comply with all applicable FTA regulations, policies, procedures and directives, including without limitation those listed directly or by reference in the Master Agreement between the purchaser and FTA, as they may be amended or promulgated from time to time during the term of the contract. Contractor's failure to comply shall constitute a material breach of the contract.

FLY AMERICA REQUIREMENTS

Applicability – all contracts involving transportation of persons or property, by air between the U.S. and/or places outside the U.S. These requirements do not apply to micro-purchases (\$3,500 or less, except for construction contracts over \$2,000).

Contractor shall comply with 49 USC 40118 (the "Fly America" Act) in accordance with General Services Administration regulations 41 CFR 301-10, stating that recipients and subrecipients of Federal funds and their contractors are required to use US Flag air carriers for US Government-financed international air travel and transportation of their personal effects or property, to the extent such service is available, unless travel by foreign air carrier is a matter of necessity, as defined by the Fly America Act. Contractor shall submit, if a foreign air carrier was used, an appropriate certification or memorandum adequately explaining why service by a US flag air carrier was not available or why it was necessary to use a foreign air carrier and shall, in any event, provide a certificate of compliance with the Fly America requirements. Contractor shall include the requirements of this section in all subcontracts that may involve international air transportation.

GOVERNMENT WIDE DEBARMENT AND SUSPENSION (NON-PROCUREMENT)

Applicability – all contracts more than \$25,000.

The Recipient agrees to the following:

1. It will comply with the requirements of 2 C.F.R. part 180, subpart C, as adopted and supplemented by U.S. DOT regulations at 2 C.F.R. part 1200, which include the following: (a) It will not enter into any arrangement to participate in the development or implementation of the Project with any Third Party Participant that is debarred or suspended except as authorized by: 1 U.S. DOT regulations, "Nonprocurement Suspension and Debarment," 2 C.F.R. part 1200, 2 U.S. OMB, "Guidelines to Agencies on Governmentwide Debarment and Suspension (Nonprocurement)," 2 C.F.R. part 180, including any amendments thereto, and 3 Executive Orders Nos. 12549 and 12689, "Debarment and Suspension," 31 U.S.C. § 6101 note, (b) It will review the U.S. GSA "System for Award Management," <http://https.www.sam.gov,.proxy1.semalt.design> if required by U.S. DOT regulations, 2 C.F.R. part 1200, and (c) It will include, and require each of its Third Party Participants to include, a similar provision in each lower tier covered transaction, ensuring that each lower tier Third Party Participant: 1 Will comply with Federal debarment and suspension requirements, and 2 Reviews the "System for Award Management" at <http://https.www.sam.gov,.proxy1.semalt.design> if necessary to comply with U.S. DOT regulations, 2 C.F.R. part 1200.
2. If the Recipient suspends, debar, or takes any similar action against a Third Party Participant or individual, the Recipient will provide immediate written notice to the: (a) FTA Regional Counsel for the Region in which the Recipient is located or implements the Project, (b) FTA Project Manager if the Project is administered by an FTA Headquarters Office, or (c) FTA Chief Counsel.

CONTRACTOR / COMPANY NAME

NAME, TITLE AND SIGNATURE OF CONTRACTOR'S AUTHORIZED OFFICIAL:

TYPE OR PRINT NAME	TITLE	
SIGNATURE 	DATE	

INCORPORATION OF FEDERAL TRANSIT ADMINISTRATION (FTA) TERMS

Applicability – all contracts except micro-purchases (\$3,500 or less, except for construction contracts over \$2,000).

The preceding provisions include, in part, certain Standard Terms & Conditions required by USDOT, whether or not expressly stated in the preceding contract provisions. All USDOT-required contractual provisions, as stated in FTA Circular 4220.1F, are hereby incorporated by reference. Anything to the contrary herein notwithstanding, all FTA mandated terms shall be deemed to control in the event of a conflict with other provisions contained in this Agreement. The contractor shall not perform any act, fail to perform any act, or refuse to comply with any request that would cause the recipient to be in violation of FTA terms and conditions.

LOBBYING

Applicability – construction/architectural and engineering/acquisition of rolling stock/professional service contract/operational service contract/turnkey contracts over \$150,000.

Byrd Anti-Lobbying Amendment, 31 U.S.C. 1352, as amended by the Lobbying Disclosure Act of 1995, P.L. 104- 65 [to be codified at 2 U.S.C. § 1601, et seq.] - Contractors who apply or bid for an award of \$150,000 or more shall file the certification required by 49 CFR part 20, "New Restrictions on Lobbying." Each tier certifies to the tier above that it will not and has not used Federal appropriated funds to pay any person or organization for influencing or attempting to influence an officer or employee of any agency, a member of Congress, officer or employee of Congress, or an employee of a member of Congress in connection with obtaining any Federal contract, grant or any other award covered by 31 U.S.C. 1352. Each tier shall also disclose the name of any registrant under the Lobbying Disclosure Act of 1995 who has made lobbying contacts on its behalf with non-Federal funds with respect to that Federal contract, grant or award covered by 31 U.S.C. 1352. Such disclosures are forwarded from tier to tier up to the recipient.

This certification is a material representation of fact upon which reliance was placed when this transaction was made or entered into. Submission of this certification is a prerequisite for making or entering into this transaction imposed by 31 U.S.C. § 1352 (as amended by the Lobbying Disclosure Act of 1995). Any person who fails to file the required certification shall be subject to a civil penalty of not less than \$10,000 and not more than \$100,000 for each such failure.

CONTRACTOR / COMPANY NAME

NAME, TITLE AND SIGNATURE OF CONTRACTOR'S AUTHORIZED OFFICIAL:

TYPE OR PRINT NAME	TITLE	
SIGNATURE 	DATE	

NO GOVERNMENT OBLIGATION TO THIRD PARTIES

Applicability – all contracts except micro-purchases (\$3,500 or less, except for construction contracts over \$2,000).

1. The recipient and contractor acknowledge and agree that, notwithstanding any concurrence by the US Government in or approval of the solicitation or award of the underlying contract, absent the express written consent by the US Government, the US Government is not a party to this contract and shall not be subject to any obligations or liabilities to the recipient, the contractor, or any other

party (whether or not a party to that contract) pertaining to any matter resulting from the underlying contract.

2. Contractor agrees to include the above clause in each subcontract financed in whole or in part with FTA assistance. It is further agreed that the clause shall not be modified, except to identify the subcontractor who will be subject to its provisions.

PRE-AWARD AND POST DELIVERY AUDITS REQUIREMENTS

Applicability – any rolling stock procurement.

49 U.S.C. 5323/49 CFR Part 663

The Contractor agrees to comply with 49 U.S.C. § 5323(l) and FTA's implementing regulation at 49 C.F.R. Part 663 and to submit the following certifications:

1. Buy America Requirements: The Contractor shall complete and submit a declaration certifying either compliance or noncompliance with Buy America. If the Bidder/Offeror certifies compliance with Buy America, it shall submit documentation which lists 1) component and subcomponent parts of the rolling stock to be purchased identified by manufacturer of the parts, their country of origin and costs; and 2) the location of the final assembly point for the rolling stock, including a description of the activities that will take place at the final assembly point and the cost of final assembly.
2. Solicitation Specification Requirements: The Contractor shall submit evidence that it will be capable of meeting the bid specifications.
3. Federal Motor Vehicle Safety Standards (FMVSS): The Contractor shall submit 1) manufacturer's FMVSS self-certification sticker information that the vehicle complies with relevant FMVSS or 2) manufacturer's certified statement that the contracted buses will not be subject to FMVSS regulations.

PROGRAM FRAUD AND FALSE OR FRAUDULENT STATEMENTS OR RELATED ACTS

Applicability – all contracts except micro-purchases (\$3,500 or less, except for construction contracts over \$2,000).

1. Contractor acknowledges that the provisions of the Program Fraud Civil Remedies Act of 1986, as amended, 31 USC 3801 et seq. and USDOT regulations, "Program Fraud Civil Remedies," 49 CFR 31, apply to its actions pertaining to this project. Upon execution of the underlying contract, contractor certifies or affirms the truthfulness and accuracy of any statement it has made, it makes, it may make, or causes to be made, pertaining to the underlying contract or FTA assisted project for which this contract work is being performed. In addition to other penalties that may be applicable, contractor further acknowledges that if it makes, or causes to be made, a false, fictitious, or fraudulent claim, statement, submittal, or certification, the US Government reserves the right to impose the penalties of the Program Fraud Civil Remedies Act (1986) on contractor to the extent the US Government deems appropriate.
2. If contractor makes, or causes to be made, a false, fictitious, or fraudulent claim, statement, submittal, or certification to the US Government under a contract connected with a project that is financed in whole or in part with FTA assistance under the authority of 49 USC 5307, the Government reserves the right to impose the penalties of 18 USC 1001 and 49 USC 5307(n)(1) on contractor, to the extent the US Government deems appropriate.
3. Contractor shall include the above two clauses in each subcontract financed in whole or in part with FTA assistance. The clauses shall not be modified, except to identify the subcontractor who will be subject to the provisions.

PROMPT PAYMENT

Applicability – all contracts except micro-purchases (\$3,500 or less, except for construction contracts over \$2,000).

The prime contractor agrees to pay each subcontractor under this prime contract for satisfactory performance of its contract no later than 30 days from the receipt of each payment the prime contract receives from the Recipient. The prime contractor agrees further to return retainage payments to each subcontractor within 30 days after the subcontractors work is satisfactorily completed. Any delay or

postponement of payment from the above referenced time frame may occur only for good cause following written approval of the Recipient. This clause applies to both DBE and non-DBE subcontracts.

RECYCLED PRODUCTS

Applicability – all contracts for items designated by the EPA, when the purchaser or contractor procures \$10,000 or more of one of these items during the current or previous fiscal year using Federal funds. The contractor agrees to comply with all the requirements of Section 6002 of the Resource Conservation and Recovery Act (RCRA), as amended (42 U.S.C. 6962), including but not limited to the regulatory provisions of 40 CFR Part 247, and Executive Order 12873, as they apply to the procurement of the items designated in Subpart B of 40 CFR Part 247.

TERMINATION

Applicability – all Contracts more than \$10,000, except contracts with nonprofit organizations and institutions of higher learning, where the threshold is \$150,000.

- a. Termination for Convenience (General Provision) the recipient may terminate this contract, in whole or in part, at any time by written notice to contractor when it is in the recipient's best interest. Contractor shall be paid its costs, including contract close-out costs, and profit on work performed up to the time of termination. Contractor shall promptly submit its termination claim to the recipient. If contractor is in possession of any of the recipient's property, contractor shall account for same, and dispose of it as the recipient directs.
- b. Termination for Default [Breach or Cause] (General Provision) If contractor does not deliver items in accordance with the contract delivery schedule, or, if the contract is for services, and contractor fails to perform in the manner called for in the contract, or if contractor fails to comply with any other provisions of the contract, the recipient may terminate this contract for default. Termination shall be effected by serving a notice of termination to contractor setting forth the manner in which contractor is in default. Contractor shall only be paid the contract price for supplies delivered and accepted, or for services performed in accordance with the manner of performance set forth in the contract. If it is later determined by the recipient that contractor had an excusable reason for not performing, such as a strike, fire, or flood, events which are not the fault of or are beyond the control of contractor, the recipient, after setting up a new delivery or performance schedule, may allow contractor to continue work, or treat the termination as a termination for convenience.
- c. Opportunity to Cure (General Provision) the recipient in its sole discretion may, in the case of a termination for breach or default, allow contractor an appropriately short period of time in which to cure the defect. In such case, the notice of termination shall state the time period in which cure is permitted and other appropriate conditions. If contractor fails to remedy to the recipient's satisfaction the breach or default or any of the terms, covenants, or conditions of this Contract within ten (10) days after receipt by contractor or written notice from the recipient setting forth the nature of said breach or default, the recipient shall have the right to terminate the Contract without any further obligation to contractor. Any such termination for default shall not in any way operate to preclude the recipient from also pursuing all available remedies against contractor and its sureties for said breach or default.
- d. Waiver of Remedies for any Breach In the event that the recipient elects to waive its remedies for any breach by contractor of any covenant, term or condition of this Contract, such waiver by the recipient shall not limit its remedies for any succeeding breach of that or of any other term, covenant, or condition of this Contract.
- e. Termination for Convenience (Professional or Transit Service Contracts) the recipient, by written notice, may terminate this contract, in whole or in part, when it is in the recipient's interest. If the contract is terminated, the recipient shall be liable only for payment under the payment provisions of this contract for services rendered before the effective date of termination.
- f. Termination for Default (Supplies and Service) If contractor fails to deliver supplies or to perform the services within the time specified in this contract or any extension or if the contractor fails to comply with any other provisions of this contract, the recipient may terminate this contract for default. The recipient shall terminate by delivering to contractor a notice of termination specifying the nature of default. Contractor shall only be paid the contract price for supplies delivered and accepted, or services performed in accordance with the manner or performance set forth in this contract. If, after termination for failure to fulfill contract obligations, it is determined that contractor

was not in default, the rights and obligations of the parties shall be the same as if termination had been issued for the recipient's convenience.

- g. Termination for Default (Transportation Services) If contractor fails to pick up the commodities or to perform the services, including delivery services, within the time specified in this contract or any extension or if contractor fails to comply with any other provisions of this contract, the recipient may terminate this contract for default. The recipient shall terminate by delivering to contractor a notice of termination specifying the nature of default. Contractor shall only be paid the contract price for services performed in accordance with the manner of performance set forth in this contract. If this contract is terminated while contractor has possession of the recipient goods, contractor shall, as directed by the recipient, protect and preserve the goods until surrendered to the recipient or its agent. Contractor and the recipient shall agree on payment for the preservation and protection of goods. Failure to agree on an amount shall be resolved under the Dispute clause. If, after termination for failure to fulfill contract obligations, it is determined that contractor was not in default, the rights and obligations of the parties shall be the same as if termination had been issued for the recipient's convenience.
- h. Termination for Default (Construction) If contractor refuses or fails to prosecute the work or any separable part, with the diligence that will insure its completion within the time specified, or any extension, or fails to complete the work within this time, or if contractor fails to comply with any other provisions of this contract, the recipient may terminate this contract for default. the recipient shall terminate by delivering to contractor a notice of termination specifying the nature of default. In this event, the recipient may take over the work and complete it by contract or otherwise, and may take possession of and use any materials, appliances, and plant on the work site necessary for completing the work. Contractor and its sureties shall be liable for any damage to the recipient resulting from contractor's refusal or failure to complete the work within specified time, whether or not contractor's right to proceed with the work is terminated. This liability includes any increased costs incurred by the recipient in completing the work. Contractor's right to proceed shall not be terminated nor shall contractor be charged with damages under this clause if:
- I. Delay in completing the work arises from unforeseeable causes beyond the control and without the fault or negligence of contractor. Examples of such causes include: acts of God, acts of the recipient, acts of another contractor in the performance of a contract with the recipient, epidemics, quarantine restrictions, strikes, freight embargoes; and
 - II. Contractor, within 10 days from the beginning of any delay, notifies the recipient in writing of the causes of delay. If in the recipient's judgment, delay is excusable, the time for completing the work shall be extended. The recipient's judgment shall be final and conclusive on the parties, but subject to appeal under the Disputes clauses. If, after termination of contractor's right to proceed, it is determined that contractor was not in default, or that the delay was excusable, the rights and obligations of the parties will be the same as if termination had been issued for the recipient's convenience.
- i. Termination for Convenience or Default (Architect & Engineering) the recipient may terminate this contract in whole or in part, for the recipient's convenience or because of contractor's failure to fulfill contract obligations. The recipient shall terminate by delivering to contractor a notice of termination specifying the nature, extent, and effective date of termination. Upon receipt of the notice, contractor shall
- I. immediately discontinue all services affected (unless the notice directs otherwise), and
 - II. deliver to the recipient all data, drawings, specifications, reports, estimates, summaries, and other information and materials accumulated in performing this contract, whether completed or in process. If termination is for the recipient's convenience, it shall make an equitable adjustment in the contract price but shall allow no anticipated profit on unperformed services. If termination is for contractor's failure to fulfill contract obligations, the recipient may complete the work by contract or otherwise and contractor shall be liable for any additional cost incurred by the recipient. If, after termination for failure to fulfill contract obligations, it is determined that contractor was not in default, the rights and obligations of the parties shall be the same as if termination had been issued for the recipient's convenience.
- j. Termination for Convenience or Default (Cost-Type Contracts) the recipient may terminate this contract, or any portion of it, by serving a notice of termination on contractor. The notice shall state whether termination is for convenience of the recipient or for default of contractor. If termination is for default, the notice shall state the manner in which contractor has failed to perform the

requirements of the contract. Contractor shall account for any property in its possession paid for from funds received from the recipient, or property supplied to contractor by the recipient. If termination is for default, the recipient may fix the fee, if the contract provides for a fee, to be paid to contractor in proportion to the value, if any, of work performed up to the time of termination. Contractor shall promptly submit its termination claim to the recipient and the parties shall negotiate the termination settlement to be paid to contractor. If termination is for the recipient's convenience, contractor shall be paid its contract closeout costs, and a fee, if the contract provided for payment of a fee, in proportion to the work performed up to the time of termination. If, after serving a notice of termination for default, the recipient determines that contractor has an excusable reason for not performing, such as strike, fire, flood, events which are not the fault of and are beyond the control of contractor, the recipient, after setting up a new work schedule, may allow contractor to continue work, or treat the termination as a termination for convenience.

Schedule D – Affidavit for Driver Delivery

Small Class of Non-lift and Lift Transit Buses

Vehicles may be driven to the final delivery destination if the following conditions are met:

1. The drivers of the vehicles are correctly licensed and trained in proper vehicle operation.
2. The Contractor accepts all responsibility and liability for vehicles in transit.
3. The Contractor should sign the affidavit below and submit this with the bid.

The contractor accepts all responsibility and liability for vehicles in transit and guarantees the vehicles shall be transported in a safe, proper, and efficient manner.

I understand that the State and/or the Ordering Entity may cancel approval of this affidavit at any time during the contract if the contractor fails to meet the above obligations.



Signed

2-9-21

Date

Commercial Sales Manager.

Title

Hoekstra Transportation Inc.

Contractor



**Authorized Michigan Transit Agencies For Purchase on
the State of Michigan Vehicle Purchasing Program
2/2019**

Transit Agency Legal Name
Adrian, City of
Alger Transit Authority
Allegan County Board of Commissioners
Alma, City of
Alpena, City of
American Red Cross Of Greater Grand Rapids
American Red Cross of West Michigan
Ann Arbor Area Transportation Authority
Antrim County Board of Commissioners
Area Agency on Aging Region 1-B
Area Community Service Employment and Training
Arenac/Bay Service
Arenac Opportunities, Inc.
Baraga/Houghton/Keweenaw Community Action Agency
Baragaland Senior Citizen, Inc.
Barry County Board of Commissioners
Battle Creek, City of
Bay Area Transportation Authority
Bay Metro Transportation Authority

Beaver Island Transportation Authority
Bedford Health Van
Belleville, City of
Benzie Transportation Authority
Berkley
Berrien County Board of Commissioners
Big Rapids, City of
Birmingham Area Seniors
Blue Water Area Transportation Commission
Boysville of Michigan, Inc.
Boysville of Michigan, Inc.
Boysville of Michigan, Inc.
Boysville of Michigan, Inc.
Branch Area Transit Authority
Branch Area Transit Authority
Brandon
Brighton Community Education
Brownstown Township
Buchanan, City of
Cadillac/Wexford Transit Authority
Campbell Lewellyn Montrose Senior Center Advisory Council, Inc.
Canton Township
Capital Area Transportation Authority

Caro Transit Authority
Cass Co Council on Aging
Cass County Transportation Authority
Catholic Charities of Southeast Michigan (Macomb)
Catholic Charities of Southeast Michigan (Oakland)
Catholic Social Services of Wayne Co. (DDOT)
Catholic Social Serv of Wayne (Macomb Co.)
Center for Gerontology
Center Line, City of
Central County Transportation Authority
Charlevoix County Board of Commissioners
Charlevoix County Transportation Authority (Ironton Ferry)
Cheboygan County Board of Commissioners
Cheboygan County COA
Chesterfield Township
CHILD & FAMILY SERVICES OF WASHTENAW CO
Chippewa-Luce- Mackinac Comm Action Human Resources, Inc.
City of Mackinac Island
Clare County Transit Corporation
Clinton Area Transit System
Clinton Township
Community Action Agency of South Central Michigan
Community Inclusive Recreation

Community Mental Health of Livingston
Community Mental Health Services
Community Social Services of Wayne County
Comprehensive Serv for the Develop. Disabled
Court Street Village Non-Profit Housing Corporation
Crawford County Transportation Authority
Delta Area Transit Authority
Destination Transportation
Detroit Area Agency on Aging
Detroit, City of
Detroit Transportation Corporation
DIMONDALE (VEHICLE LOCATION)
Disability Network West Michigan
Dowagiac, City of
Downriver Community Conference
Eastern U.P. Transportation Authority
Eastside Community Resource
Eaton County Transportation Authority
Emmet County Medical Care Facility
Family Service Agency of Mid Michigan
Farmington Hills
Ferndale, City of
Friendship Center of Emmet County

Gateway - Detroit East
Genessee County Association for Retarded Citizens
Georgetown Seniors
Gladwin County Board of Commissioners
Gogebic County Transit
Goodwill Industries (Muskegon County)
Goodwill Industries of Northern Wisconsin and Upper Michigan, Inc.
Gratiot County Commission on Aging
Greater Lapeer Transportation Authority
Greenville, City of
Greyhound Lines
Growth and Opportunity, Inc.
Hancock, City of
Handicappers Information Council and Patient Equipment Locker, Inc.
Harbor Transit Multi-Modal Transportation System
Harrison, Charter Township of
Hartland Senior Center
Haskell O.W.L.S. Inc.
Healthsource Saginaw, Inc.
Heart of Senior Citizens Service
Help Source
Highland/Milford
Highland Park, City of

Hillsdale, City of
Holly Area Schools
Holly, Village of
Hope Network, Inc.
Houghton, City of
Huron County Transit Corporation
Huron Valley Ambulance
Independence Twp
Indian Trails, Inc.
Interurban Transit Authority
Interurban Transit Partnership
Ionia, City of
Ionia County Commission on Aging
Iosco Transit Corporation
Isabella County Transportation Commission
Jackson Area Transportation Authority
Jewish Community Services
Jewish Family Services of Washtenaw County
JVS
Kalamazoo County Transportation Authority
Kalkaska Public Transit Authority
Kent County Community Mental Health
Key Opportunities

Lapeer Team Work, Inc.
Latin American Social & Economic Dev.
Lenawee County Board of Commissioners
Lenawee County Department on Aging
Livingston County Board of Commissioners
Livingston County Catholic Social Services
Livonia, City of
Ludington Mass Transportation Authority
Macatawa Area Express Transportation Authority
Mackinac County Transportation
Macomb Co. Community Services Agency
Macomb Co. Interfaith Volunteer Caregivers
Macomb County Dept of Sr Citizens Adult Day Care Program
Manchester Area Senior Citizens Council, Inc.
Manistee County Board of Commissioners
Marian E. Burch Adult Day Care & Rehabilitation Center
Marquette County Transit Authority
Marshall, City of
MASSTrans
Mass Transportation Authority
Matrix Human Services
Mecosta County Commission on Aging
Mecosta Osceola Transit Authority

Menominee/Delta/Schoolcraft
MICHIGAN DEPARTMENT OF TRANSPORTATION
Michigan Public Transit Association
Michigan Transportation Connection
Midland, City of
Midland County Board of Commissioners
Milan Seniors for Healthy Living
Missaukee County
Monroe County Community Mental Health
Monroe County Opportunity Program
Montcalm County Commission on Aging
Montmorency County Specialized Services
MRS (St. Joseph Co)
Mt. Clemens
Muskegon County Board of Commissioners
Newaygo County COA
Niles, City of
Northfields Human Service Agency
Northville
Oceana County COA
Ogemaw County Board of Commissioners
Older Persons Commission
Ontonagon County Board of Commissioners

Oscoda County Area Transit Specialists
Otsego County Board of Commissioners
Ottawa, County of
Oxford Township
Peoples Community Services
Peoples Express
Pioneer Resources - Muskegon
Pioneer Resources - Muskegon
Pioneer Resources - Ottawa
Pointe Area Assisted Transp.
Pontiac, City of
Pontiac Schools - SCAMP
Presque Isle County COA
Redford Township
Region 3B Area Agency on Aging
Regional Transit Authority of Southeast Michigan
Response Transportation
Richmond Lenox EMS
Roscommon County Transportation Authority
Saginaw CMHA
Saginaw COA
Saginaw Transit Authority Regional Services
Sanilac County Board of Commissioners

Sault Ste. Marie, City of
Schoolcraft County Transit Authority
Senior Neighbors
Shiawassee Area Transportation Agency
SMART - Bedford
SMART - Lake Erie Transit
SMART - North Oakland Transportation Authority
SMART - Royal Oak
Southfield Senior Adult Ctr
Southwest Counseling and Development Services
Stable Automotive Group Transportation
STAR Transportation
St. Clair Shores
St. Joseph Community Co-op, Inc.
St. Joseph County COA
St. Joseph County Transportation Authority
St. Marys Guardian Angel Respite and Day Care Serv
Suburban Mobility Authority for Regional Transportation
Sumpter Twp
SUPERIOR DELIVERY AND TRANSPORTATION (VEHICLE LOCATION)
The Arc of Livingston
Thunder Bay Transportation Authority
TRICO Opportunities, Inc.

Troy Medi-Go
Twin Cities Area Transportation Authority
United Methodist Community House
U.P. Community Service Inc.
Van Buren Public Transit
Virginia Park CT Service Corp.
Vital Care Adult Day Center
Vocational Independence Program Transportation
Warren Parks & Rec.
Waterford Senior Center
Wellspring Lutheran Services
Western-Washtenaw Area Value Express
White Lake Township
Yates Township
Ypsilanti - Ann Arbor Transportation Authority

STATE OF MICHIGAN

Contract No. 210000000606

Small Class of Non-Lift and Lift Transit Buses

CLASS 1: Minimum 5 Years/150,000 Miles

CLASS 2: Minimum 7 Years/200,000 Miles

SCHEDULE F

EQUIPMENT CHECKLIST

I	Instructions: Complete each section of the following Equipment Checklist document. If applicable, provide as much detail as possible, in the evaluation portion, by listing product and model names, sizes, materials used, type, etc. <u>Failure to complete this document and return with your bid package shall result in a bid disqualification.</u>			
II	BODY SPECIFICATIONS			
		Item	Product Name and Model	Size, Material, and/or Type
A.		General design and construction	AeroTech and AeroLite Bodies	Fiberglass reinforced plastic body integrated with steel reinforced construction for secure attachment points.
B.	1.	Body structure and exterior panels	Eldorado Aero Bodies	Fiberglass reinforced plastic body integrated with steel reinforced construction for secure attachment points. Interlocked resin saturated fiberglass mattin and mechanical fasteners, forming a unibody design. Matrix of fiberglass reinforced plastic with an inner thickness of Nidacor resin-hardened honeycomb material. Also includes Nidacore (plastic honeycomb) around all openings (i.e. windows, roof hatches etc.)
	2.	Rollover frame, steel cage type	SEE Schedule F - METAL	SEE Schedule F – METAL – for the Equipment Checklist for the Metal Cage style bus
	3.	Body section thickness	SEE Schedule F - METAL	SEE Schedule F – METAL – for the Equipment Checklist for the Metal Cage style bus
	4.	Body section thickness	Eldorado Aero Bodies	Exterior surface: 020" minimum high gloss gelcoat backed by 3/16" minimum thickness resin-hardened fiberglass reinforced plastic. The center composite is 3/4" resin-hardened matrix of honeycomb and nidacore laid on edge for maximum column strength of each cell. Steel sections are fully integrated into wall and roof structure to insure additional structural integrity and attachment points for stanchions and handrails. Final surface is a minimum 3/16" thickness of fiberglass reinforced plastic
	5.	Exterior panels	Eldorado Aero	See B1-B4 above
	6.	Interior panels	Eldorado Aero	FRP as specified
	7.	Interior length	Eldorado Aero	140 – 175.5" based on model/class
	8.	Interior width	Eldorado Aero	83 - 90.50" based on model/class
	9.	Interior height	Eldorado Aero	75 - 80" based on model/class
	10.	Exterior length	Eldorado Aero	240 – 280.37" based on model/class
	11.	Exterior width	Eldorado Aero	90 - 96" based on model/class
	12.	Exterior height	Eldorado Aero	109 - 112" excluding roof hatch & strobe based on model/class
	13.	Rubrils	Eldorado Aero	ENC 2" rubber in plastic molding

	14.	Body overhang	Eldorado Aero	69 – 92” based on model/class
C.	1.	Passenger door	A & M	A & M as specified with accessibility to controls
	2.	Opening Size	A & M	27 - 32” based on model/class
D.		Stepwell	ENC	14 gauge stainless steel
E.		Interior – Color	ENC	Gelcoat white
F.		Flooring	ENC	Subfloor - Marine grade plywood, undercoated before and after installation onto steel floor structure. Floor covering per specification.
G.		Emergency exits	ENC	Transpec Roof Hatch, Pushout Windows, Rear Door or Window as specified
H.		Gauges	OEM	OEM as specified
I.		Fare box	Diamond	Diamond NV/XV with extra vault and keyed alike per specification
J.		Bumpers	ROMEO RIM	OEM front and Romeo energy absorbing HELP bumper on rear as specified
K.		Mud Flaps and Splash Guards	ENC	Commercial grade anti sail with stainless steel T-brackets as specified
L.		Towing	ENC	Front OEM and ENC rear tow hooks
M.	1.	Undercoating	Tectyl	Tectyl as specified
	2.	Rustproofing	ENC	Waxoyl inner steel tube coated as specified
N.	1.	Interior mirrors	ENC	6x8 convex as specified – Option
	2.	Sunvisors	OEM	OEM
O.		Exterior Mirrors	ROSCO	Heated and Remote Control with stainless steel arms as specified
P.	1.	Seats – Driver	OEM	Ford OEM as specified
	2.	Seats – Passenger	Freedman	Various Freedman seats per floor plan requirements
	3.	Seats – Fold-up	Freedman	Featherweight folding
	4.	Seats – Flip-up	Freedman	Featherweight flip
Q.		Handrails, stanchions	ENC	Powder-coat Yellow/Stainless as specified
R.		Interior lighting – LED	ENC Production	All LED as specified
S.		Exterior lighting - LED	ENC Production	Over molded plastic, LED as specified
T.	1.	Heating / ventilating – Front System	OEM	As specified
	2.	Heating / ventilating – Rear System	ProAir	Rear system heater as specified
U.		Windows	Clear Vision Star Quest	T-Slider with tint as specified
V.		Paint	Sikkens	As specified
W.		Insulation	ENC	ENC construction, includes cabliner
X.		Lift (platform type)	Braun	1000# Century NCL1000 size 37 x 54”

III WHEELCHAIR SECUREMENT AREA

		Item	Product Name and Model	Size, Material, and/or Type
A.		Wheelchair securement	Q*Straint	1st position 54 x 30, 2nd position 48 x 30” in either single point or L-track style based on option ordered
B.		Wheelchair restraints	Q*Straint	Q8100-A1-L or Q8100-A1-SC based on option order.
C.		Restraint storage system	Freedman	TDSS and additional storage bag per specification

IV CHASSIS SPECIFICATIONS

		Item	Product Name/Model	Size, Material, and/or Type
A.		Chassis	Ford	E350/E450 based on model/class
B.		Tilt Wheel/Power Steering	OEM	As specified
C.	1.	Wheelbase – 138” minimum (Class 1)	OEM	138”
	2.	Wheelbase – 158” minimum (Class 2)	OEM	158”-176” based on model
D.		Class 1- Gasoline	Ford	7.3l V8 Premium Gas

		Class 1 - CNG	N/A	N/A – We have recently been informed that there are no systems available for the Class 1 - E350 chassis that have been Altoona Tested and Carb Certified. Currently the only FTA Funded availability is on the Class 2 – E450 Chassis.
		Class 1 - Propane	ROUSH	G91 OEM prepped - 7.3l V8 Premium Gas w/conversion per specification – Dedicated 40 GGE Systems and 24 GGE Bi-Fuel
		Class 2 -Gasoline	Ford	7.3l V8 Premium Gas
		Class 2 – CNG	Green Alternative Systems	G91 OEM prepped - 7.3l V8 Premium Gas w/conversion per specification 30GGE System - Dedicated CNG Conversion for the Ford E450 7.3L Ford E450 with the 7.3L and Gaseous Prep Package required Ford QVM, NFPA, FMVSS, NHTSA, and EPA/CARB Compliant CNG System Lightweight Type 3 CNG Cylinders with 20 year service life Electronic Valves with Individual Fuze Protection
		Class 2 - Propane	ROUSH & ICOM	G91 OEM prepped - 7.3l V8 Premium Gas w/conversion per specification – Dedicated 40 & 64 GGE Systems and 24 GGE Bi-Fuel
E.		Auxiliary Coolant Heater	Wabasto	Webasto Thermo Top EVO
F.		Transmission	OEM	OEM automatic with overdrive as specified
G.		Alignment	ENC	Aligned prior to shipment to Michigan to ensure proper arrival after 800 mile journey. If preferred by the State this can be changed to alignment in Michigan. (not recommended)
H.		Gross Vehicle Weight Rating (GVWR)	OEM	11,500 – 14,500 lb. based on model/class ordered. GVWR will match specification.
		Front axle rating	OEM	4,600 lb.
		Rear axle rating	OEM	7,800 – 9,450 lb. based on model/class. Will match specification
I.		Differential	OEM	OEM recommended differentials per specification. 3.73 – 4.63 depending on model/class ordered
J.		Battery	OEM	Dual matching 950cca or more. Motorcraft or Delco based on model
K.		Battery Cables and Grounds	ENC	Protective cover on terminals – no exposed copper – meeting or exceeding specifications.
L.		Alternator	Ford OEM	OEM Ford as specified
M.		Engine Fast Idle	Intermotive	Ills gateway with interlock
N.		Brakes	OEM	Hydraulic heavy duty anti-lock brakes from the chassis manufacturer as specified. Heavy duty OEM parking brake per specifications.
O.		Fuel tank	OEM	40 Class 1 - 55 gallon Class 2 as specified based on model/class ordered.
P.		Hazard flashers	OEM	Steering column OEM specified
Q.		Shock absorbers	OEM	Gas pressurized – 35mm
R.		Suspension - Front	OEM	OEM front spring suspension per specification
S.		Suspension - Rear	Ford OEM	Heavy duty rear suspension Ford OEM
T.		Stabilizer	OEM	Front steering stabilizers 24mm
U.		Wheels	OEM	16x6 painted as specified
V.		Tires	OEM	OEM selected LT225/75R 16 single front and dual rear as specified
W.		Drive shaft	OEM	Tube steel guarded per specification

210000000606 - Hoekstra Transportation Inc.

X.		Wipers / Horn	OEM	Intermittent / dual note horn as specified
Y.		Radiator and cooling system	OEM	708 sq. inches, 10 blade – 19.4” diameter fan
Z.		Fluids	OEM	OEM recommended as specified
AA.		Engine Cover/Trim	OEM	Insulated interior cover
AB.		Exhaust system	ENC/OEM	Aluminized steel / street side as specified on rear lift units

EQUIPMENT CHECKLIST

V		OTHER ITEMS		
		Item	Product Name and Model	Size, Material, and/or Type
A.	1.	Safety – Fire extinguisher	Kidde	As specified
	2.	Safety – Reflective triangles	ENC standard	Bi-directional
	3.	Safety – Reverse alarm	ENC	Model 510SG located per specification
	4.	Safety-Rear door alarm	ENC	Functioning as specified
	5.	Safety- Exterior height (clearance) decal	ENC	As specified
	6.	Safety-Lift interlock system	ENC/ILIS	Functioning as specified
	7.	Safety-Warning/engine shutdown system	OEM	Ford OEM Chassis systems
	8.	Safety-Headlight control	OEM	OEM w/daytime running lights
	9.	Safety-Strobe light	Dual Flash LED	Located per specification w/guard
B.	1.	Lift circuit breaker	Braun	Functioning as specified
	2.	12-volt power point	OEM	As specified
	3.	Wire coding and harnesses	ENC	Complete plug and play harness, each harness is tagged for function, each wire is color coded and stamped every 6 inches. Harness function tag stays on all harenesses if used or not
	4.	Electrical panel	Precision Works	EP4 As specified
	5.	Wiring support	ENC	P clamps every 16” loomed and tied as specified
	6.	Wiring grounds and capacity	ENC	Two main grounds to chassis frame at front and back of bus, all other ground go back to panel and are spread evenly on ground bar. As specified.
	7.	Constant run solenoid	ENC	Master 80 – amp relay
	8.	Circuit capacity & function	ENC	Circuits fused or relay. Spare circuit as required
	9.	Wiring protection	OEM	500 amp fuse inline after battery
	10.	Wiring routing	ENC	Per specifications with looming and grommets
	11.	Wiring connections	ENC	Color and function labeled – plug and

				play pin type and WeatherPak where required by specification.
VI	OPTIONS – ALTERNATE QUOTES			
1		Air Conditioning – Split System	ACT	A/C, ACT 13R HD 82KBTU, INWALL, TM21 (ROOF COND) With Digital Controls and Brush guard.
2		Air Conditioning - Rooftop System	ACT	A/C, ACT RTS-75 HD 90KBTU, HVAC, EC-1 W/HEAT STRIP, Digital Controller and Brush Guard.
3		Auxiliary Coolant Heater	Wabasto	Webasto Thermo Top EVO with timer
4		Auxiliary Air Heater	Espar	Airtronic with 7 day timer
5		Destination Sign – Roller Curtain	Transign	Transign Roller style Front and Side Signs as specified
6		Destination Sign – LED	Transign	Transign LED Front and Side Signs as specified
7		Donation box (in lieu of standard farebox – deduct)	Diamond	As specified
8		Driver Side Running Board/Steps/Grab Handle	RC Industries	Aluminum per specification
9		Farebox Electrical Prep Only (less standard farebox - deduct)	ENC	As specified
10		Limited Slip Differential	Ford	As specified OEM option
11		Rear Emergency Exit Window	ENC	As specified in lieu of standard rear door.
12		Paint - One stripe	Sikkens	As specified
13		Paint - Roof second color	Sikkens	As specified
14		Paint - Different Full body	Sikkens	As specified
15		Reflective Vinyl Belt Stripe	3M	As specified
16		Lift – Type I (in lieu of standard lift - deduct)	Braun	Century 1000# 34x54”
17		Lift – Type II – Powered outer barrier (in lieu of standard lift)	Braun	Millennium 800#
18		Lift - Folding Platform (in lieu of standard lift)	Braun	Vista NVL2
19		Alternate Standard Lift Manufacturer	RICON	Titan model
20		Wheelchair Single Point Securement System (in lieu of one standard L-Track position)	Q’Straint / AM Bruns	Slide-n-Click Q8100-A1-SC including extra puck and color coded points per specifications. Or AMF BRUNS PLATINUM SERIES WC18, J-HOOK, Single Point W/4 LOOPS/1 BAG
21		Additional Wheelchair Position – L Track System	Q’Straint // AM Bruns	Q8100-A1-L or AMF BRUNS

				PLATINUM SERIES WC18, J-HOOK, L-TRACK W/4 LOOPS/1 BAG
22		Additional Wheelchair Position – Single Point System	Q'Straint // AM Bruns	Q8100-A1-SC or AMF BRUNS PLATINUM SERIES WC18, J-HOOK, Single point W/4 LOOPS/1 BAG
23		Portable Oxygen Tank Holder	Sure-Lok GO2	As specified
24		Assistive Blue Loop Straps	Q'Straint	As specified
25		Two-way radio prep package	ENC	OEM radio and speakers
26		Radio - AM/FM stereo system w/ four speakers	FORD	PA with speakers – standalone
27		Public Address (PA) System Only w/ two speakers	REI	AM/FM/CD/PA with mic
28		Radio – AM/FM/PA System w/ four speakers	REI	AM/FM/CD/PA with mic
29		Radio – Speaker only (additional)	ENC	OEM construction as specified.
30		Raised Flooring (No Wheel Wells)	ENC	OEM construction as specified.
31		Entrance Stepwell Heater	Lighthouse	Lighthouse warm welcome electric step well heater
32		Manual Entrance Door	A&M	Replaces electric door with the manual version as specified.
33		Seating – Forward Facing Standard Double Seat – Vinyl	Freedman	Freedman Featherweight - Constructed per specification
34		Seating – Forward Facing Standard Double Seat – Fabric	Freedman	Freedman Featherweight - Constructed per specification
35		Seating – Forward Facing Standard Double Seat – Vinyl (Deduct)	Freedman	Freedman Featherweight - Constructed per specification
36		Seating – Forward Facing Standard Double Seat – Fabric (Deduct)	Freedman	Freedman Featherweight - Constructed per specification
37		Seating – Forward Facing Double Fold-A-Way – Vinyl	Freedman	Freedman Featherweight - Constructed per specification
38		Seating – Forward Facing Double Fold-A-Way – Fabric	Freedman	Freedman Featherweight - Constructed per specification
39		Seating – Forward Facing Double Fold-A-Way – Vinyl (Deduct)	Freedman	Freedman Featherweight - Constructed per specification
40		Seating – Forward Facing Double Fold-A-Way – Fabric (Deduct)	Freedman	Freedman Featherweight -

				Constructed per specification
41		Seating – Single Flip-up – Vinyl	Freedman	Freedman Featherweight - Constructed per specification
42		Seating – Single Flip-up – Fabric	Freedman	Freedman Featherweight - Constructed per specification
43		Seating – Double Flip-up – Vinyl	Freedman	Freedman Featherweight - Constructed per specification
44		Seating – Double Flip-up – Fabric	Freedman	Freedman Featherweight - Constructed per specification
45		Seating – Double w/Single Integrated Child Seat (ICS) - Vinyl	Freedman	Freedman Featherweight - Constructed per specification
46		Seating – Double w/Single Integrated Child Seat (ICS) – Fabric	Freedman	Freedman Featherweight - Constructed per specification
47		Seating – Double w/Single Integrated Child Seat (ICS) – Vinyl (Deduct)	Freedman	Freedman Featherweight - Constructed per specification
48		Seating – Double w/Single Integrated Child Seat (ICS) – Fabric (Deduct)	Freedman	Freedman Featherweight - Constructed per specification
49		Seating – Double w/Double Integrated Child Seat (ICS) - Vinyl	Freedman	Freedman Featherweight - Constructed per specification
50		Seating – Double w/Double Integrated Child Seat (ICS) - Fabric	Freedman	Freedman Featherweight - Constructed per specification
51		Power Seat Base (Driver)	Ford OEM	As specified with cloth cover
52		Alternate Engine - CNG Class I	N/A	N/A
53		Alternate Engine - CNG Class II	Green Alternative Systems	Green Alternative Systems as specified
54		Alternate Engine LPG 40 GGE Class I	ROUSH Cleantech	As specified dedicated fuel system
55		Alternate Engine LPG 40 GGE Class II	ROUSH Cleantech	As specified dedicated fuel system
56		Alternate Engine LPG 64 GGE Class I	ROUSH Cleantech	As specified dedicated fuel system
57		Alternate Engine LPG 64 GGE Class II	ROUSH Cleantech	As specified dedicated fuel system
58		Stop Request System	ENC	Pull chords and chimes per

				specification for stop request system
59		Back-up Sensor System	Hawkeye	Specified HELP Bumper with the Hawkeye sensor system per specification.
60		Back-up Camera System	ROSCO	As specified
61		Video Surveillance – Two Camera System	REI / AngleTrax / Seon	As specified – see bidders notes
62		Video Surveillance – Four Camera System	REI / AngleTrax / Seon	As specified – see bidders notes
63		Video Surveillance – Six Camera System	REI / AngleTrax / Seon	As specified – see bidders notes
64		Video Surveillance – DVR System Upgrade	REI / AngleTrax / Seon	As specified – see bidders notes
65		Video Surveillance – Extra Interior Cameras	REI / AngleTrax / Seon	As specified – see bidders notes
66		Video Surveillance – Extra Exterior Cameras	REI / AngleTrax / Seon	As specified – see bidders notes
67		Video Surveillance Prep Package	REI / AngleTrax / Seon	As specified – see bidders notes
68		Rear Suspension Assist System	MOR/ryde	MOR/ryde® “RSX” Suspension System as specified.
69		Spare Tire - Steer Axle	OEM	As specified
70		Spare Tire - Drive Asle	OEM	As specified
71		Entry Door Grab Handles	ENC	Yellow As specified
72		Interior Mirror	ENC	6x9 As specified
73		Ceiling Handrails	ENC	As specified
74		Wheelchair Lift Plexiglass Barriers	ENC	As specified
75		Slide-out Battery Tray	ENC	As specified in lieu of stepwell battery box – with stainless tray and slides
76		Bike Rack	Sportsworks	As specified
77		Yellow Seatback Grab Handles	Freedman	As specified in lieu of black grab handles
78		OEM Chassis Cruise Control	Ford OEM	As Specified

EQUIPMENT CHECKLIST

VII		VENDOR / MANUFACTURER REQUIREMENTS	List electronic file names
A		Bus information furnished	Schedule F - COMPOSITE Equipment Checklist
B		Manufacturer quality control (name/title)	QAP - Quality Assurance Plan Eldorado
C		Air conditioning certification	Will comply with specification testing
D		Heating/Ventilating certification	Will comply with specification testing
E		Purchaser inspection	As specified.
F		Warranty	I - Ford Warranties I - Warranties Eldorado
VIII		DOCUMENTS & DRAWINGS	List electronic file names
A.		The Michigan request for proposal (RFP) and bus specification forms completed in detail.	4 - Schedule A - Statement of Work 3 - Standard Contract Terms 5 - Schedule C - FTA Clauses Eldorado 6 - Schedule D - Affidavit for Driver Delivery 9 - Schedule F - COMPOSITE Equipment Checklist 7 - Schedule B - Small Bus Specifications AD2 10 - Schedule G - COMPOSITE - Pricing AD2
B.		Bus floor plans indicating dimensions and showing the interior layout of the bus. The plan shall include wheelchair placement, stanchion locations, engineering calculated loaded bus axle weights, and be drawn to scale for all configurations.	B - Eldo Class 1 Floorplans and Weights B - Eldo Class 2 Floorplans and Weights
C.		Detailed engineering drawing for the design of the entrance door and door-opening device.	C - Door Eldorado Class 1 C - Door Eldorado Class 2
D.		Detailed engineering drawing for the design of the entrance step configuration.	D - Stepwell Drawing Eldorado
E.		Roof, sidewall, and flooring drawings showing structure and structural specifications indicating metal size and type used. Include side sheathing and inside panels.	E - Roof Sidewall Floor Eldorado
F.		Manufacturer's chassis description (specifications).	F - Ford Chassis Specs Class 1 F - Ford Chassis Specs Class 2
G.		Detailed engineering drawings of the body to chassis frame mounting.	G - Body Mounting Eldorado
H.		Manufacturer's technical specifications for wheelchair lifts and wheelchair restraints. Manufacturer's sales literature is acceptable if it contains the technical specifications.	H - Lift and Restraint Specifications
I.		The warranties for body, chassis, and drive train.	I - Warranties Eldorado
J.		If applicable, as required by Title 49 of the CFR, Part 663 - Subpart D, a copy of the manufacturer's self-certification information concerning the bus's compliance with relevant Federal Motor Vehicle Safety Standards (pre-award)	J - FMVSS Certifications Eldorado
K.		A copy of the Bus Rollover Protection Test (FMVSS 220), 49CFR §571.220 and School Bus Joint Strength (FMVSS 221), 49CFR § 571.221 results of the bus offered as specified in the bid.	K - FMVSS 220 Eldorado
L.		Completed Schedule C - Federal Transit Administration (FTA) clauses shall be attached to bid quotation.	5 - Schedule C - FTA Clauses - Eldorado

List electr

M.		Buy America analysis of manufacturer's list of component and subcomponent parts (pre-award).	M - PREBUYAMERICA_Eldorado
N.		The technical data sheet including flammability and smoke emissions for the seat covering material supplied.	N - Seat Material Flamability
O.		Seat frame salt spray test data and impact resistance test results.	O - Salt Seats YN208Q_Interpon A2000
P.		Certification test data showing that the seats, the seat belts, and the installation are in compliance with FMVSS-207, 208, 209, and 210 where applicable for the bus model being offered in this bid.	P - Seat Belt Certs
Q.		Technical data sheet for the seat cushion foam supplied.	Q - Seat Foam
R.		Certification that the wiring and the switches for air conditioning and all add-on components are adequate to withstand transient loads expected.	R - Composite WiringSwitch
S.		Proof of valid motor vehicle dealer licensing from state, county, or municipality.	S - Dealer License Michigan
T.		A copy of the dealer agreement between the Bus Manufacturer and the designated bidder.	T - Dealer Agreement Eldorado
U.		Certification that the bus model offered is a 5 year or 150,000 mile (small class one) or 7 years/200,000 mile (small class two) bus and will meet the requirements of Federal Register Rules and Regulations 49 CFR Part 665, Bus Testing Program. Stating from § 665.13 Test Report and Manufacturer Certification, Section (b)(1), "A manufacturer of a new bus model or a bus produced with a major change in component or configuration shall provide a copy of the test report to a recipient during the point in the procurement process specified by the recipient".	U - Altoona Propane ROUSH U - Altoona AeroLite U - Altoona AeroTech Family Altoona U - Altoona CNG System U - ICOM Bi-Fuel Altoona report U - Altoona Ford 7.3L Engine
V.		Certification for 480-hour salt spray test per ASTM procedure B-117.	VWX - Composite Salt Spray Tests VWX - Salt Spray 1000 hour Eldorado
W.		Certification for 1,000-hour salt spray test per ASTM procedure B-117.	VWX - Composite Salt Spray Tests VWX - Salt Spray 1000 hour Eldorado
X.		480 hour ASTM D2247 Humidity Resistance test.	VWX - Salt Spray Test
Y.		FULL Altoona Test Report.	U - Altoona Propane ROUSH U - Altoona AeroLite U - Altoona AeroTech Family Altoona U - Altoona CNG System U - ICOM Bi-Fuel Altoona report U - Altoona Ford 7.3L Engine
Z.		Schedule D - Affidavit for Driver Delivery	Schedule D - Affidavit for Driver Delivery
AA.		Bus turning radius: wheel-to-wheel	Turning Radius Eldorado
BB.		Bus turning radius: wall-to-wall	Turning Radius Eldorado
IX	EXCEPTIONS - List all exceptions in the space below:		
X	BIDDER COMMENTS		

1. This bid includes the Ford Motor Co. GPC concession for this fixed 2-year contract. The bid price also includes the Ford Motor Company Mobility Concession of \$1000 mobility rebate on any Ford lift equipped bus.
2. In an effort to help solve the problem of different brands of camera systems that our transit agencies want to use, we are offering 3 brands of camera systems at the same cost. This will allow agencies to choose the system that best suits their needs and either change or match the systems they use in their fleets.
3. We are also offering 2 brands of restraints based on feedback at the same cost.
4. To meet the required 37" lift platform, our manufacturers are using the "Challenger" door system. Increasing the width of the door opening also may in rare cases affect some seat spacing per the approved equals acknowledgment.

STATE OF MICHIGAN

Contract No. 210000000606

Small Class of Non-Lift and Lift Transit Buses

CLASS 1: Minimum 5 Years/150,000 Miles

CLASS 2: Minimum 7 Years/200,000 Miles

SCHEDULE F

EQUIPMENT CHECKLIST

I	Instructions: Complete each section of the following Equipment Checklist document. If applicable, provide as much detail as possible, in the evaluation portion, by listing product and model names, sizes, materials used, type, etc. <u>Failure to complete this document and return with your bid package shall result in a bid disqualification.</u>			
II	BODY SPECIFICATIONS			
		Item	Product Name and Model	Size, Material, and/or Type
A.		General design and construction	1: Crusader 2: Challenger	Rollover tested with full steel cage construction.
B.	1.	Body structure and exterior panels	Champion	Steel cage construction with composite exterior sidewalls and composite one-piece roof.
	2.	Rollover frame, steel cage type	Champion	Wall and roof structure is constructed of 1.5" x 1.5" 16 gauge tubular steel. The floor frame is constructed of 11 gauge 2" x 2.88" x 2" channel cross members with an outer 14-gauge angle steel impact rail. The wall structure is bolted to the floor.
	3.	Body section thickness	Champion	Structural cage is 1.5" x 1.5" gauge tubular steel. Exterior sidewall skin is a TekModo composite material laminated to an Azdel composite backer.
	4.	Body section thickness	Champion	Structural cage is 1.5" x 1.5" gauge tubular steel. Exterior sidewall skin is a TekModo composite material laminated to an Azdel composite backer.
	5.	Exterior panels	Champion	Exterior sidewall skin is Noble Choice 2.54 mm thick. Roof skin is a TekModo composite material laminated to an Azdel composite backer
	6.	Interior panels	Champion	FRP bonded Azdel Composite material
	7.	Interior length	Champion	Varies by floorplan
	8.	Interior width	Champion	Class 1: 83"; Class 2: 90"
	9.	Interior height	Champion	78"
	10.	Exterior length	Champion	Varies by floorplan
	11.	Exterior width	Champion	Class 1: 88"; Class 2: 96", both excluding exterior mirrors
	12.	Exterior height	Champion	112" excluding roof hatch and strobe light; flat floor option adds 6" to standard height.
	13.	Rubrails	Champion	Flexible PVC plastic extrusion with a mylar insert and a clear overlay.
	14.	Body overhang	Champion	76" to 90" depending on floorplan
C.	1.	Passenger door	A & M Systems – Door & Controls	Aluminum frame door panels with electric controls

	2.	Opening Size	Champion	Class 1: 27" x 80"; Class 2: 30" x 80"
D.		Stepwell	Champion	14 gauge stainless steel
E.		Interior – Color	Champion	Light gray
F.		Flooring	Champion	¾" marine grade plywood with sealed edges with covering as specified
G.		Emergency exits	Champion	Transpec/SMI roof hatch; side/rear egress: Hehr and Champion; Rear door or window as specified
H.		Gauges	Ford	Chassis OEM
I.		Fare box	Diamond	Model NV w/ 2 vaults
J.		Bumpers	Ford/SMI	OEM Front/Romeo Rim Help Rear
K.		Mud Flaps and Splash Guards	Champion	Heavy Duty with T-bracket brace
L.		Towing	Champion	Two hardened steel rear tow hooks
M.	1.	Undercoating	Tectyl	As specified
	2.	Rustproofing	Waxoyl	As specified
N.	1.	Interior mirrors	Ford	OEM
	2.	Sunvisors	Ford	OEM
O.		Exterior Mirrors	Rosco	Heated/Remote with stainless arms
P.	1.	Seats – Driver	Ford	OEM
	2.	Seats – Passenger	Freedman	Featherweight
	3.	Seats – Fold-up	Freedman	Featherweight folding
	4.	Seats – Flip-up	Freedman	Featherweight flip
Q.		Handrails, stanchions	Champion	Yellow Powder-coat/Stainless
R.		Interior lighting – LED	Optronics	LED
S.		Exterior lighting - LED	Champion construction	LED over molded plastic per specification
T.	1.	Heating / ventilating – Front System	Ford	OEM
	2.	Heating / ventilating – Rear System	ProAir	Heater per specifications
U.		Windows	Hehr	Top T-slider
V.		Paint	Champion	Finished to match OEM chassis; PPG for optional paint schemes
W.		Insulation	NCFI Spray Foam	Spray on rigid foam insulation
X.		Lift (platform type)	Braun	37" x 54" Platform 1000# Century
III	WHEELCHAIR SECUREMENT AREA			
		Item	Product Name and Model	Size, Material, and/or Type
A.		Wheelchair securement	Q'Straint	One 30" x 54" position and one 30" x 48" for L-track or optional single point system.
B.		Wheelchair restraints	Q'Straint	Q-8100-A1-L or optional QRT-360 Combo SNC W-OCC. WC18/19
C.		Restraint storage system	Freedman	TDSS under foldaway seats and one storage pouch for passenger belts.
IV	CHASSIS SPECIFICATIONS			
		Item	Product Name/Model	Size, Material, and/or Type
A.		Chassis	Ford	E350/E450 based on model/class
B.		Tilt Wheel/Power Steering	OEM	As specified
C.	1.	Wheelbase – 138" minimum (Class 1)	OEM	138"
	2.	Wheelbase – 158" minimum (Class 2)	OEM	158"-176" based on model
D.		Class 1- Gasoline	Ford	7.3l V8 Premium Gas
		Class 1- CNG	N/A	N/A – We have recently been informed that there are no systems available for the Class 1 - E350 chassis that have been Altoona Tested and Carb Certified. Currently the only FTA Funded availability is on the Class 2 – E450 Chassis.

210000000606 - Hoekstra Transportation Inc.

		Class 1 - Propane	ROUSH	G91 OEM prepped - 7.3l V8 Premium Gas w/conversion per specification – Dedicated 40 GGE Systems and 24 GGE Bi-Fuel
		Class 2 -Gasoline	Ford	7.3l V8 Premium Gas
		Class 2 – CNG	Green Alternative Systems	G91 OEM prepped - 7.3l V8 Premium Gas w/conversion per specification 30GGE System - Dedicated CNG Conversion for the Ford E450 7.3L Ford E450 with the 7.3L and Gaseous Prep Package required Ford QVM, NFPA, FMVSS, NHTSA, and EPA/CARB Compliant CNG System Lightweight Type 3 CNG Cylinders with 20 year service life Electronic Valves with Individual Fuze Protection
		Class 2 - Propane	ROUSH & ICOM	G91 OEM prepped - 7.3l V8 Premium Gas w/conversion per specification – Dedicated 40 & 64 GGE Systems and 24 GGE Bi-Fuel
E.		Auxiliary Coolant Heater	Wabasto	Webasto Thermo Top EVO
F.		Transmission	Ford	TorqShift Automatic Overdrive
G.		Alignment	Champion	Aligned during final quality check
H.		Gross Vehicle Weight Rating (GVWR)	Ford	Class 1: 11,500 to 12,500 - Floorplan Dependent; Class 1 w/alt. fuel: 14,500 Class 2: 14,500
		Front axle rating	Ford	5,000 lb.
		Rear axle rating	Ford	Class 1: 8,500 lb. Class 1 w/ alt. fuel: 9,600 lb. Class 2: 9,600 lb.
I.		Differential	Dana	Full Floating
J.		Battery	Motorcraft	Dual 12 volt
K.		Battery Cables and Grounds	Champion	AWG size 2/0
L.		Alternator	Ford	OEM as specified
M.		Engine Fast Idle	Intermotive	Gateway
N.		Brakes	Ford	Power, Self-Adjusting, four wheel disc with four wheel anti-lock
O.		Fuel tank	Ford	Small Class I: 40 gallons Small Class II: 55 gallons Alt Fuel tanks to meet specifications
P.		Hazard flashers	Ford	OEM mounted on steering column
Q.		Shock absorbers	Ford	OEM
R.		Suspension - Front	Ford	Twin-I-Beam IFS
S.		Suspension - Rear	Ford	OEM rear suspension as specified
T.		Stabilizer	Ford	Front stabilizer bar
U.		Wheels	Ford	16" x 6" steel
V.		Tires	Ford	OEM selected LT225/75R 16E Steel belted radials
W.		Drive shaft	Ford	OEM with guards added
X.		Wipers / Horn	Ford	Wipers are three speed plus intermittent. Two horns of high and low pitch are used
Y.		Radiator and cooling system	Ford	OEM
Z.		Fluids	OEM	OEM; capacity verified at final inspection
AA.		Engine Cover/Trim	Ford	OEM insulated cover
AB.		Exhaust system	Ford/Champion	Aluminized steel muffler with street side extension

EQUIPMENT CHECKLIST

V		OTHER ITEMS		
		Item	Product Name and Model	Size, Material, and/or Type
A.	1.	Safety – Fire extinguisher	Buckeye model 5-HI SA40	5 Pound ABC
	2.	Safety – Reflective triangles	Signal Stat	Foldable, Free-Standing, Warning Triangle, Kit
	3.	Safety – Reverse alarm	Magnadyne	97 dB
	4.	Safety-Rear door alarm	Champion	Audible for driver Activates per requirements
	5.	Safety- Exterior height (clearance) decal	Champion	Vinyl
	6.	Safety-Lift interlock system	Intermotive Gateway	Interlocks with lift door, transmission , parking brake
	7.	Safety-Warning/engine shutdown system	Ford	The Ford chassis is equipped with an OEM “fail-safe” feature triggered by loss of coolant: If the engine overheats, the engine will switch from normal all-cylinder operation to alternating cylinder operation. The non-powered cylinders act as air pumps to help cool the powered cylinders The vehicle will continue to operate, but with limited engine power, and the air conditioning system will be disabled – This allows the driver to travel a short distance to obtain service or reach a service facility.
	8.	Safety-Headlight control	Ford	Switch type with stalk high beam control
	9.	Safety-Strobe light	Dual Flash LED	Electronic with clear lens and branch guards
B.	1.	Lift circuit breaker	Braun	70 amp
	2.	12-volt power point	Champion	12-volt power point
	3.	Wire coding and harnesses	Precision Works	Color, number and function coded
	4.	Electrical panel	Precision Works	Circuit breakers with LED condition indicator lights

210000000606 - Hoekstra Transportation Inc.

	5.	Wiring support	Champion	Loomed with P-clamps
	6.	Wiring grounds and capacity	Champion	For engine, body, transmission, lights and lift
	7.	Constant run solenoid	Champion	Energized when ignition is on.
	8.	Circuit capacity & function	Champion	Circuit components are matched to the circuits they control
	9.	Wiring protection	Precision Works	Wiring is insulated, loomed and supported.
	10.	Wiring routing	Champion	Interior routed when possible. Protected underfloor when necessary
	11.	Wiring connections	Packard and Amp	Weatherpak and Superseal
VI	OPTIONS – ALTERNATE QUOTES			
1		Air Conditioning – Split System	ACT	A/C, ACT 13R HD 82KBTU, INWALL, TM21 (ROOF COND) With Digital Controls and Brush guard.
2		Air Conditioning - Rooftop System	ACT	A/C, ACT RTS-75 HD 90KBTU, HVAC, EC-1 W/HEAT STRIP, Digital Controller and Brush Guard.
3		Auxiliary Coolant Heater	Wabasto	Webasto Thermo Top EVO with timer
4		Auxiliary Air Heater	Espar	Airtronic with 7 day timer
5		Destination Sign – Roller Curtain	Transign	Roller Curtain
6		Destination Sign – LED	Transign	Electronic LED
7		Donation box (in lieu of standard farebox – deduct)	Diamond	Painted Steel
8		Driver Side Running Board/Steps/Grab Handle	Champion	12" wide HD construction
9		Farebox Electrical Prep Only (less standard farebox- deduct)	Champion	Farebox stanchion and wiring
10		Limited Slip Differential	FORD	OEM
11		Rear Emergency Exit Window	OEM	In lieu of standard rear door as specified
12		Paint - One stripe	PPG Paint	11" wide horizontal
13		Paint - Roof second color	PPG Paint	Roof area, above windows and starting at appx. The B pillar rearward
14		Paint - Different Full body	PPG Paint	Full bus paint including cab and roof
15		Reflective Vinyl Belt Stripe	Reflective vinyl	6" Belt stripe
16		Lift – Type I (in lieu of standard lift - deduct)	Braun	Century 1000# 34x54"

210000000606 - Hoekstra Transportation Inc.

17		Lift – Type II – Powered outer barrier (in lieu of standard lift)	Braun	Millennium 800#
18		Lift - Folding Platform (in lieu of standard lift)	Braun	Vista NVL2
19		Alternate Standard Lift Manufacturer	RICON	Titan model
20		Wheelchair Single Point Securement System (in lieu of one standard L-Track position)	Q'Straint / AM Bruns	Slide-n-Click Q8100-A1-SC including extra puck and color coded points per specifications. Or AMF BRUNS PLATINUM SERIES WC18, J-HOOK, Single Point W/4 LOOPS/1 BAG
21		Additional Wheelchair Position – L Track System	Q'Straint / / AM Bruns	Q8100-A1-L or AMF BRUNS PLATINUM SERIES WC18, J-HOOK, L-TRACK W/4 LOOPS/1 BAG
22		Additional Wheelchair Position – Single Point System	Q'Straint / / AM Bruns	Q8100-A1-SC or AMF BRUNS PLATINUM SERIES WC18, J-HOOK, Single point W/4 LOOPS/1 BAG
23		Portable Oxygen Tank Holder	Sure-LOk GO2	As specified
24		Assistive Blue Loop Straps	Q'Straint	As specified
25		Two-way radio prep package	Champion	Steel antenna mounting plates, antenna ground planes, 2, 6" access holes, Plastic conduit w/ pull cable, 12 volt power.
26		Radio - AM/FM stereo system w/ four speakers	Ford	OEM as specified
27		Public Address (PA) System Only w/ two speakers	REI	PA system w/speakers
28		Radio – AM/FM/PA System w/ four speakers	REI	AM/FM /PA stereo with 4 speakers
29		Radio – Speaker only (additional)	REI	Added speakers as required
30		Raised Flooring (No Wheel Wells)	Champion	Raised floor per spec
31		Entrance Stepwell Heater	Lighthouse	Warm Welcome
32		Manual Entrance Door	A&M	Manual door to replace standard electric door
33		Seating – Forward Facing Standard Double Seat – Vinyl	Freedman	Freedman Featherweight - Constructed per specification
34		Seating – Forward Facing Standard Double Seat – Fabric	Freedman	Freedman Featherweight - Constructed per specification

210000000606 - Hoekstra Transportation Inc.

35		Seating – Forward Facing Standard Double Seat – Vinyl (Deduct)	Freedman	Freedman Featherweight - Constructed per specification
36		Seating – Forward Facing Standard Double Seat – Fabric (Deduct)	Freedman	Freedman Featherweight - Constructed per specification
37		Seating – Forward Facing Double Fold-A-Way – Vinyl	Freedman	Freedman Featherweight - Constructed per specification
38		Seating – Forward Facing Double Fold-A-Way – Fabric	Freedman	Freedman Featherweight - Constructed per specification
39		Seating – Forward Facing Double Fold-A-Way – Vinyl (Deduct)	Freedman	Freedman Featherweight - Constructed per specification
40		Seating – Forward Facing Double Fold-A-Way – Fabric (Deduct)	Freedman	Freedman Featherweight - Constructed per specification
41		Seating – Single Flip-up – Vinyl	Freedman	Freedman Featherweight - Constructed per specification
42		Seating – Single Flip-up – Fabric	Freedman	Freedman Featherweight - Constructed per specification
43		Seating – Double Flip-up – Vinyl	Freedman	Freedman Featherweight - Constructed per specification
44		Seating – Double Flip-up – Fabric	Freedman	Freedman Featherweight - Constructed per specification
45		Seating – Double w/Single Integrated Child Seat (ICS) - Vinyl	Freedman	Freedman Featherweight - Constructed per specification
46		Seating – Double w/Single Integrated Child Seat (ICS) – Fabric	Freedman	Freedman Featherweight - Constructed per specification
47		Seating – Double w/Single Integrated Child Seat (ICS) – Vinyl (Deduct)	Freedman	Freedman Featherweight - Constructed per specification
48		Seating – Double w/Single Integrated Child Seat (ICS) – Fabric (Deduct)	Freedman	Freedman Featherweight - Constructed per specification
49		Seating – Double w/Double Integrated Child Seat (ICS) - Vinyl	Freedman	Freedman Featherweight - Constructed per specification

210000000606 - Hoekstra Transportation Inc.

50		Seating – Double w/Double Integrated Child Seat (ICS) - Fabric	Freedman	Freedman Featherweight - Constructed per specification
51		Power Seat Base (Driver)	Ford OEM	As specified with cloth cover
52		Alternate Engine - CNG Class I	N/A	N/A
53		Alternate Engine - CNG Class II	Green Alternative Systems	Green Alternative Systems as specified
54		Alternate Engine LPG 40 GGE Class I	ROUSH Cleantech	As specified dedicated fuel system
55		Alternate Engine LPG 40 GGE Class II	ROUSH Cleantech	As specified dedicated fuel system
56		Alternate Engine LPG 64 GGE Class I	ROUSH Cleantech	As specified dedicated fuel system
57		Alternate Engine LPG 64 GGE Class II	ROUSH Cleantech	As specified dedicated fuel system
58		Stop Request System	Champion	Pull chords and chimes per specification for stop request system
59		Back-up Sensor System	Hawkeye	Specified HELP Bumper with the Hawkeye sensor system per specification.
60		Back-up Camera System	ROSCO	As specified
61		Video Surveillance – Two Camera System	REI / AngleTrax / Seon	As specified – see bidders notes
62		Video Surveillance – Four Camera System	REI / AngleTrax / Seon	As specified – see bidders notes
63		Video Surveillance – Six Camera System	REI / AngleTrax / Seon	As specified – see bidders notes
64		Video Surveillance – DVR System Upgrade	REI / AngleTrax / Seon	As specified – see bidders notes
65		Video Surveillance – Extra Interior Cameras	REI / AngleTrax / Seon	As specified – see bidders notes
66		Video Surveillance – Extra Exterior Cameras	REI / AngleTrax / Seon	As specified – see bidders notes
67		Video Surveillance Prep Package	REI / AngleTrax / Seon	As specified – see bidders notes
68		Rear Suspension Assist System	MOR/ryde	MOR/ryde® “RSX” Suspension System as specified.
69		Spare Tire - Steer Axle	OEM	As specified
70		Spare Tire - Drive Axle	OEM	As specified
71		Entry Door Grab Handles	Champion	Yellow As specified
72		Interior Mirror	Champion	6x9 As specified
73		Ceiling Handrails	Champion	As specified
74		Wheelchair Lift Plexiglass Barriers	Champion	As specified
75		Slide-out Battery Tray	Champion	As specified in lieu of stepwell battery box – with stainless tray and slides

210000000606 - Hoekstra Transportation Inc.

76		Bike Rack	Sportsworks	As specified
77		Yellow Seatback Grab Handles	Freedman	As specified in lieu of black grab handles
78		OEM Chassis Cruise Control	Ford OEM	As Specified

EQUIPMENT CHECKLIST

VII		VENDOR / MANUFACTURER REQUIREMENTS	List electronic file names
A		Bus information furnished	Schedule F – METAL - Equipment Checklist
B		Manufacturer quality control (name/title)	QAP - Quality Assurance Plan Champion
C		Air conditioning certification	Will comply with specification testing
D		Heating/Ventilating certification	Will comply with specification testing
E		Purchaser inspection	As specified.
F		Warranty	I - Ford Warranties I – Warranties Champion
VIII		DOCUMENTS & DRAWINGS	List electronic file names
A.		The Michigan request for proposal (RFP) and bus specification forms completed in detail.	4 - Schedule A - Statement of Work 3 - Standard Contract Terms 5 – Schedule C – FTA Clauses Eldorado 6 - Schedule D - Affidavit for Driver Delivery 9 - Schedule F – METAL - Equipment Checklist 7 - Schedule B – Small Bus Specifications AD2 10 - Schedule G – METAL - Pricing AD2
B.		Bus floor plans indicating dimensions and showing the interior layout of the bus. The plan shall include wheelchair placement, stanchion locations, engineering calculated loaded bus axle weights, and be drawn to scale for all configurations.	B - Champion Class 1 Floorplans and Weights B - Champion Class 2 Floorplans and Weights
C.		Detailed engineering drawing for the design of the entrance door and door-opening device.	C – Door Champion Class 1 C – Door Champion Class 2
D.		Detailed engineering drawing for the design of the entrance step configuration.	D - Stepwell Drawing Champion
E.		Roof, sidewall, and flooring drawings showing structure and structural specifications indicating metal size and type used. Include side sheathing and inside panels.	E - Roof Sidewall Floor Champion
F.		Manufacturer's chassis description (specifications).	F - Ford Chassis Specs Class 1 F - Ford Chassis Specs Class 2
G.		Detailed engineering drawings of the body to chassis frame mounting.	G - Body Mounting Champion
H.		Manufacturer's technical specifications for wheelchair lifts and wheelchair restraints. Manufacturer's sales literature is acceptable if it contains the technical specifications.	H – Lift and Restraint Specifications
I.		The warranties for body, chassis, and drive train.	I – Warranties Champion
J.		If applicable, as required by Title 49 of the CFR, Part 663 – Subpart D, a copy of the manufacturer's self-certification information concerning the bus's compliance with relevant Federal Motor Vehicle Safety Standards (pre-award)	J - FMVSS Certifications Champion
K.		A copy of the Bus Rollover Protection Test (FMVSS 220), 49CFR §571.220 and School Bus Joint Strength (FMVSS 221), 49CFR § 571.221 results of the bus offered as specified in the bid.	K - FMVSS 220 Champion
L.		Completed Schedule C - Federal Transit Administration (FTA) clauses shall be attached to bid quotation.	5 - Schedule C - FTA Clauses - Champion

M.		Buy America analysis of manufacturer's list of component and subcomponent parts (pre-award).	M - PREBUYAMERICA_ Champion
N.		The technical data sheet including flammability and smoke emissions for the seat covering material supplied.	N - Seat Material Flammability
O.		Seat frame salt spray test data and impact resistance test results.	O - Salt Seats YN208Q_Interpon A2000
P.		Certification test data showing that the seats, the seat belts, and the installation are in compliance with FMVSS-207, 208, 209, and 210 where applicable for the bus model being offered in this bid.	P - Seat Belt Certs
Q.		Technical data sheet for the seat cushion foam supplied.	Q - Seat Foam
R.		Certification that the wiring and the switches for air conditioning and all add-on components are adequate to withstand transient loads expected.	R - Champion WiringSwitch
S.		Proof of valid motor vehicle dealer licensing from state, county, or municipality.	S - Dealer License Michigan
T.		A copy of the dealer agreement between the Bus Manufacturer and the designated bidder.	T - Dealer Agreement Champion
U.		Certification that the bus model offered is a 5 year or 150,000 mile (small class one) or 7 years/200,000 mile (small class two) bus and will meet the requirements of Federal Register Rules and Regulations 49 CFR Part 665, Bus Testing Program. Stating from § 665.13 Test Report and Manufacturer Certification, Section (b)(1), "A manufacturer of a new bus model or a bus produced with a major change in component or configuration shall provide a copy of the test report to a recipient during the point in the procurement process specified by the recipient".	U - Altoona Propane ROUSH U - Altoona Champion Test Class 1 Ford E350 Chassis U - Altoona Test Class 1 Champion U - Altoona Test Class 2 Champion Ford E450 Chassis U - Altoona CNG System U - ICOM Bi-Fuel Altoona report U - Altoona Ford 7.3L Engine U - Altoona Test Class 1 FTA Determination Letter
V.		Certification for 480-hour salt spray test per ASTM procedure B-117.	VWX – Metal Salt Spray Tests VWX - Salt Spray 1000 hour Champion
W.		Certification for 1,000-hour salt spray test per ASTM procedure B-117.	VWX - Metal Salt Spray Tests VWX - Salt Spray 1000 hour Champion
X.		480 hour ASTM D2247 Humidity Resistance test.	VWX - Salt Spray Test
Y.		FULL Altoona Test Report.	U - Altoona Propane ROUSH U - Altoona Champion Test Class 1 Ford E350 Chassis U - Altoona Test Class 1 Champion U - Altoona Test Class 2 Champion Ford E450 Chassis U - Altoona CNG System U - ICOM Bi-Fuel Altoona report U - Altoona Ford 7.3L Engine U - Altoona Test Class 1 FTA Determination Letter
Z.		Schedule D - Affidavit for Driver Delivery	Schedule D - Affidavit for Driver Delivery
AA.		Bus turning radius: wheel-to-wheel	Turning Radius - Champion
BB.		Bus turning radius: wall-to-wall	Turning Radius - Champion
IX	EXCEPTIONS - List all exceptions in the space below:		

X	BIDDER COMMENTS
	<ol style="list-style-type: none">1. This bid includes the Ford Motor Co. GPC concession for this fixed 2-year contract. The bid price also includes the Ford Motor Company Mobility Concession of \$1000 mobility rebate on any Ford lift equipped bus.2. In an effort to help solve the problem of different brands of camera systems that our transit agencies want to use, we are offering 3 brands of camera systems at the same cost. This will allow agencies to choose the system that best suits their needs and either change or match the systems they use in their fleets.3. We are also offering 2 brands of restraints based on feedback at the same cost.4. To meet the required 37" lift platform, our manufacturers are using the "Challenger" door system. Increasing the width of the door opening also may in rare cases affect some seat spacing per the approved equals acknowledgment.

STATE OF MICHIGAN

Contract No. 210000000606

Small Class of Non-Lift and Lift Transit Buses

SCHEDULE G PRICING (Composite)

1. The Contractor must provide a pricing schedule for the proposed Contract Activities using Cost Models below. The pricing schedule should be submitted in Microsoft Excel; however, you may also submit an additional pricing schedule in a non-modifiable format (e.g., PDF). Failure to complete the pricing schedule as requested may result in disqualification of your proposal.

2. Price proposals must include all costs, including but not limited to, any one-time or set-up charges, fees, and potential costs that Contractor may charge the State (e.g., shipping and handling, per piece pricing, and palletizing).

3. The Contractor is encouraged to offer quick payment terms. The number of days must not include processing time for payment to be received by the Contractor's financial institution.

Quick payment terms: ____0__ % discount off invoice if paid within ____0__ days after receipt of invoice.

4. By submitting its proposal, the Contractor certifies that the prices were arrived at independently, and without consultation, communication, or agreement with any other Contractor.

COST MODEL/EVALUATION FORM

MICHIGAN SMALL CLASS OF BUSES SPECIFICATION

Class 1 - Minimum 5 Years/150,000 Miles

Class 2 - Minimum 7 Years/200,000 Miles

Body Manufacturer:	Eldorado National	
Bidder Company Name:	Hoekstra Transportation Inc.	
Bidder Address:	3741 Roger B Chaffee Blvd. Grand Rapids, MI. 49548	
Preparer's Name:	Steve Bolin	
Inspection Facility:	Hoekstra Transportation Inc.	
Address of Inspection Facility:	3741 Roger B Chaffee Blvd. Grand Rapids, MI. 49548	
I	Instructions: Complete each section of the following cost model document. <u>Failure to complete this document and return with your bid package shall result in a bid disqualification.</u>	
II	COST MODEL	
	Description	Unit Price
	Base Bus Floor Plans – Class One	
	138" (min) Wheelbase Bus – Vinyl Seat Covers	
A.	10 passenger without lift	\$63,161.00
B.	4 + 2 passenger with lift	\$74,669.00

C.	11 passenger without lift	\$62,899.00
D.	5 + 2 passenger with lift	\$72,778.00
138" (min) Wheelbase Bus – Fabric Seat Covers		
E.	10 passenger without lift	\$63,411.00
F.	4 + 2 passenger with lift	\$74,920.00
G.	11 passenger without lift	\$63,175.00
H.	5 + 2 passenger with lift	\$73,054.00
Base Bus Floor Plans – Class Two		
158" (min) Wheelbase Bus – Vinyl Seat Covers		
I.	18 passenger without lift	\$69,645.00
J.	10 + 1 passenger with lift	\$77,790.00
K.	8 + 2 passenger with lift	\$79,802.00
L.	4 + 2 passenger with lift	\$82,633.00
158" (min) Wheelbase Bus – Fabric Seat Covers		
M.	18 passenger without lift	\$70,096.00
N.	10 + 1 passenger with lift	\$78,091.00
O.	8 + 2 passenger with lift	\$80,103.00
P.	4 + 2 passenger with lift	\$83,034.00
158" (min) Wheelbase Bus – Vinyl Seat Covers		
Q.	22 passenger without lift	\$70,709.00
R.	6 + 2 passenger with lift	\$82,448.00
S.	10 + 2 passenger with lift	\$81,478.00
T.	4 + 2 passenger with lift	\$86,117.00
158" (min) Wheelbase Bus – Fabric Seat Covers		
U.	22 passenger without lift	\$71,261.00
V.	6 + 2 passenger with lift	\$82,849.00
W.	10 + 2 passenger with lift	\$81,829.00
X.	4 + 2 passenger with lift	\$86,568.00
SUBTOTAL (Buses A-X)		
AA.	Equipment Options	
1	Air Conditioning – Split System	\$6,015.00
2	Air Conditioning - Rooftop System	\$11,520.00
3	Auxiliary Coolant Heater	\$2,291.00
4	Auxiliary Air Heater	\$2,899.00
5	Destination Sign – Roller Curtain	\$3,368.00
6	Destination Sign – LED	\$3,509.00
7	Donation box (in lieu of standard farebox – deduct)	-\$1,203.00
8	Driver Side Running Board/Steps/Grab Handle	\$275.00
9	Farebox Electrical Prep Only (less standard farebox- deduct)	-\$1,704.00
10	Limited Slip Differential	\$276.00
11	Rear Emergency Exit Window	-\$1,003.00
12	Paint - One stripe	\$918.00
13	Paint - Roof second color	\$1,053.00
14	Paint - Different Full body	\$3,509.00

15	Reflective Vinyl Belt Stripe	\$602.00
16	Lift – Type I (in lieu of standard lift - deduct)	-\$1,504.00
17	Lift – Type II – Powered outer barrier (in lieu of standard lift)	-\$1,203.00
18	Lift - Folding Platform (in lieu of standard lift)	-\$1,203.00
19	Alternate Standard Lift Manufacturer	\$501.00
20	Wheelchair Single Point Securement System (in lieu of one standard L-Track position)	\$100.00
21	Additional Wheelchair Position – L Track System	\$1,103.00
22	Additional Wheelchair Position – Single Point System	\$1,203.00
23	Portable Oxygen Tank Holder	\$326.00
24	Assistive Blue Loop Straps	\$20.00
25	Two-way radio prep package	\$125.00
26	Radio - AM/FM stereo system w/ four speakers	\$100.00
27	Public Address (PA) System Only w/ two speakers	\$301.00
28	Radio – AM/FM/PA System w/ four speakers	\$301.00
29	Radio – Speaker only (additional)	\$50.00
30	Raised Flooring (No Wheel Wells)	\$602.00
31	Entrance Stepwell Heater	\$150.00
32	Manual Entrance Door	-\$350.00
33	Seating – Forward Facing Standard Double Seat – Vinyl	\$530.00
34	Seating – Forward Facing Standard Double Seat – Fabric	\$550.00
35	Seating – Forward Facing Standard Double Seat – Vinyl (Deduct)	-\$530.00
36	Seating – Forward Facing Standard Double Seat – Fabric (Deduct)	-\$550.00
37	Seating – Forward Facing Double Fold-A-Way – Vinyl	\$942.00
38	Seating – Forward Facing Double Fold-A-Way – Fabric	\$967.00
39	Seating – Forward Facing Double Fold-A-Way – Vinyl (Deduct)	-\$942.00
40	Seating – Forward Facing Double Fold-A-Way – Fabric (Deduct)	-\$967.00
41	Seating – Single Flip-up – Vinyl	\$530.00
42	Seating – Single Flip-up – Fabric	\$545.00
43	Seating – Double Flip-up – Vinyl	\$793.00
44	Seating – Double Flip-up – Fabric	\$818.00
45	Seating – Double w/Single Integrated Child Seat (ICS) - Vinyl	\$1,254.00
46	Seating – Double w/Single Integrated Child Seat (ICS) – Fabric	\$1,274.00
47	Seating – Double w/Single Integrated Child Seat (ICS) – Vinyl (Deduct)	-\$1,254.00
48	Seating – Double w/Single Integrated Child Seat (ICS) – Fabric (Deduct)	-\$1,274.00
49	Seating – Double w/Double Integrated Child Seat (ICS) - Vinyl	\$1,578.00
50	Seating – Double w/Double Integrated Child Seat (ICS) - Fabric	\$1,598.00
51	Power Seat Base (Driver)	\$501.00
52	Alternate Engine - CNG Class II - Dedicated	\$25,053.00
53	Alternate Engine LPG 40 GGE Class I - Dedicated	\$17,043.00
54	Alternate Engine LPG 40 GGE Class II - Dedicated	\$18,045.00
55	Alternate Engine LPG 64 GGE Class II - Dedicated	\$21,053.00
56	Alternate Engine LPG 24 GGE Class I - Bi-fuel	\$11,028.00
57	Alternate Engine LPG 24 GGE Class II - Bi-fuel	\$11,028.00

58	Stop Request System	\$602.00
59	Back-up Sensor System	\$1,303.00
60	Back-up Camera System	\$0.00
61	Video Surveillance – Two Camera System	\$1,905.00
62	Video Surveillance - Four Camera System	\$3,008.00
63	Video Surveillance - Six Camera System	\$3,509.00
64	Video Surveillance - DVR System Upgrade	\$952.00
65	Video Surveillance – Extra Interior Cameras	\$501.00
66	Video Surveillance – Extra Exterior Cameras	\$501.00
67	Video Surveillance Prep Package	\$501.00
68	Rear Suspension Assist System	\$2,206.00
69	Spare Tire - Steer Axle	\$301.00
70	Spare Tire - Drive Asle	\$301.00
71	Entry Door Grab Handles	\$100.00
72	Interior Mirror	\$100.00
73	Ceiling Handrails	\$201.00
74	Wheelchair Lift Plexiglass Barriers	\$125.00
75	Slide-out Battery Tray	\$1,203.00
76	Bike Rack	\$2,506.00
77	Yellow Seatback Grab Handles	\$50.00
78	OEM Chassis Cruise Control	\$251.00
79	Alternate Flooring Manufacturer	\$0.00

Refer to “Standard Contract Terms”, section 7, regarding administration fee.

STATE OF MICHIGAN

Contract No. 210000000606

Small Class of Non-Lift and Lift Transit Buses

SCHEDULE G PRICING (Metal Bus)

1. The Contractor must provide a pricing schedule for the proposed Contract Activities using Cost Models below. The pricing schedule should be submitted in Microsoft Excel; however, you may also submit an additional pricing schedule in a non-modifiable format (e.g., PDF). Failure to complete the pricing schedule as requested may result in disqualification of your proposal.

2. Price proposals must include all costs, including but not limited to, any one-time or set-up charges, fees, and potential costs that Contractor may charge the State (e.g., shipping and handling, per piece pricing, and palletizing).

3. The Contractor is encouraged to offer quick payment terms. The number of days must not include processing time for payment to be received by the Contractor's financial institution.

Quick payment terms: ____0__ % discount off invoice if paid within ____0__ days after receipt of invoice.

4. By submitting its proposal, the Contractor certifies that the prices were arrived at independently, and without consultation, communication, or agreement with any other Contractor.

COST MODEL/EVALUATION FORM

MICHIGAN SMALL CLASS OF BUSES SPECIFICATION

Class 1 - Minimum 5 Years/150,000 Miles

Class 2 - Minimum 7 Years/200,000 Miles

Body Manufacturer:	Champion Bus	
Bidder Company Name:	Hoekstra Transportation Inc.	
Bidder Address:	3741 Roger B Chaffee Blvd. Grand Rapids, MI. 49548	
Preparer's Name:	Steve Bolin	
Inspection Facility:	Hoekstra Transportation Inc.	
Address of Inspection Facility:	3741 Roger B Chaffee Blvd. Grand Rapids, MI. 49548	
I	Instructions: Complete each section of the following cost model document. <u>Failure to complete this document and return with your bid package shall result in a bid disqualification.</u>	
II	COST MODEL	
	Description	Unit Price
	Base Bus Floor Plans – Class One	
	138" (min) Wheelbase Bus – Vinyl Seat Covers	
A.	10 passenger without lift	\$59,149.00
B.	4 + 2 passenger with lift	\$66,976.00

C.	11 passenger without lift	\$58,435.00
D.	5 + 2 passenger with lift	\$66,452.00
138" (min) Wheelbase Bus – Fabric Seat Covers		
E.	10 passenger without lift	\$59,149.00
F.	4 + 2 passenger with lift	\$66,976.00
G.	11 passenger without lift	\$58,435.00
H.	5 + 2 passenger with lift	\$66,452.00
Base Bus Floor Plans – Class Two		
158" (min) Wheelbase Bus – Vinyl Seat Covers		
I.	18 passenger without lift	\$62,884.00
J.	10 + 1 passenger with lift	\$68,800.00
K.	8 + 2 passenger with lift	\$69,538.00
L.	4 + 2 passenger with lift	\$72,982.00
158" (min) Wheelbase Bus – Fabric Seat Covers		
M.	18 passenger without lift	\$62,884.00
N.	10 + 1 passenger with lift	\$68,800.00
O.	8 + 2 passenger with lift	\$69,538.00
P.	4 + 2 passenger with lift	\$72,982.00
158" (min) Wheelbase Bus – Vinyl Seat Covers		
Q.	22 passenger without lift	\$65,902.00
R.	6 + 2 passenger with lift	\$72,952.00
S.	10 + 2 passenger with lift	\$72,791.00
T.	4 + 2 passenger with lift	\$75,321.00
158" (min) Wheelbase Bus – Fabric Seat Covers		
U.	22 passenger without lift	\$65,902.00
V.	6 + 2 passenger with lift	\$72,952.00
W.	10 + 2 passenger with lift	\$72,791.00
X.	4 + 2 passenger with lift	\$75,321.00
SUBTOTAL (Buses A-X)		
AA.	Equipment Options	
1	Air Conditioning – Split System	\$5,013.00
2	Air Conditioning - Rooftop System	\$7,820.00
3	Auxiliary Coolant Heater	\$3,008.00
4	Auxiliary Air Heater	\$3,008.00
5	Destination Sign – Roller Curtain	\$1,805.00
6	Destination Sign – LED	\$4,211.00
7	Donation box (in lieu of standard farebox – deduct)	-\$501.00
8	Driver Side Running Board/Steps/Grab Handle	\$226.00
9	Farebox Electrical Prep Only (less standard farebox- deduct)	-\$802.00
10	Limited Slip Differential	\$276.00
11	Rear Emergency Exit Window	-\$401.00
12	Paint - One stripe	\$1,103.00
13	Paint - Roof second color	\$1,504.00
14	Paint - Different Full body	\$4,812.00

15	Reflective Vinyl Belt Stripe	\$501.00
16	Lift – Type I (in lieu of standard lift - deduct)	-\$211.00
17	Lift – Type II – Powered outer barrier (in lieu of standard lift)	-\$211.00
18	Lift - Folding Platform (in lieu of standard lift)	-\$211.00
19	Alternate Standard Lift Manufacturer	\$501.00
20	Wheelchair Single Point Securement System (in lieu of one standard L-Track position)	\$201.00
21	Additional Wheelchair Position – L Track System	\$501.00
22	Additional Wheelchair Position – Single Point System	\$602.00
23	Portable Oxygen Tank Holder	\$301.00
24	Assistive Blue Loop Straps	\$15.00
25	Two-way radio prep package	\$75.00
26	Radio - AM/FM stereo system w/ four speakers	\$75.00
27	Public Address (PA) System Only w/ two speakers	\$376.00
28	Radio – AM/FM/PA System w/ four speakers	\$401.00
29	Radio – Speaker only (additional)	\$30.00
30	Raised Flooring (No Wheel Wells)	\$1,103.00
31	Entrance Stepwell Heater	\$150.00
32	Manual Entrance Door	\$201.00
33	Seating – Forward Facing Standard Double Seat – Vinyl	\$662.00
34	Seating – Forward Facing Standard Double Seat – Fabric	\$662.00
35	Seating – Forward Facing Standard Double Seat – Vinyl (Deduct)	-\$662.00
36	Seating – Forward Facing Standard Double Seat – Fabric (Deduct)	-\$662.00
37	Seating – Forward Facing Double Fold-A-Way – Vinyl	\$898.00
38	Seating – Forward Facing Double Fold-A-Way – Fabric	\$898.00
39	Seating – Forward Facing Double Fold-A-Way – Vinyl (Deduct)	-\$898.00
40	Seating – Forward Facing Double Fold-A-Way – Fabric (Deduct)	-\$898.00
41	Seating – Single Flip-up – Vinyl	\$393.00
42	Seating – Single Flip-up – Fabric	\$393.00
43	Seating – Double Flip-up – Vinyl	\$636.00
44	Seating – Double Flip-up – Fabric	\$636.00
45	Seating – Double w/Single Integrated Child Seat (ICS) - Vinyl	\$1,056.00
46	Seating – Double w/Single Integrated Child Seat (ICS) – Fabric	\$1,056.00
47	Seating – Double w/Single Integrated Child Seat (ICS) – Vinyl (Deduct)	-\$1,056.00
48	Seating – Double w/Single Integrated Child Seat (ICS) – Fabric (Deduct)	-\$1,056.00
49	Seating – Double w/Double Integrated Child Seat (ICS) - Vinyl	\$1,361.00
50	Seating – Double w/Double Integrated Child Seat (ICS) - Fabric	\$1,361.00
51	Power Seat Base (Driver)	\$501.00
52	Alternate Engine - CNG Class II - Dedicated	\$25,063.00
53	Alternate Engine LPG 40 GGE Class I - Dedicated	\$17,043.00
54	Alternate Engine LPG 40 GGE Class II - Dedicated	\$18,045.00
55	Alternate Engine LPG 64 GGE Class II - Dedicated	\$21,053.00
56	Alternate Engine LPG 24 GGE Class I - Bi-fuel	\$11,028.00
57	Alternate Engine LPG 24 GGE Class II - Bi-fuel	\$11,028.00
58	Stop Request System	\$902.00

59	Back-up Sensor System	\$902.00
60	Back-up Camera System	\$0.00
61	Video Surveillance – Two Camera System	\$1,905.00
62	Video Surveillance - Four Camera System	\$2,707.00
63	Video Surveillance - Six Camera System	\$3,509.00
64	Video Surveillance - DVR System Upgrade	\$952.00
65	Video Surveillance – Extra Interior Cameras	\$401.00
66	Video Surveillance – Extra Exterior Cameras	\$401.00
67	Video Surveillance Prep Package	\$602.00
68	Rear Suspension Assist System	\$1,203.00
69	Spare Tire - Steer Axle	\$281.00
70	Spare Tire - Drive Asle	\$281.00
71	Entry Door Grab Handles	\$100.00
72	Interior Mirror	\$50.00
73	Ceiling Handrails	\$251.00
74	Wheelchair Lift Plexiglass Barriers	\$125.00
75	Slide-out Battery Tray	\$0.00
76	Bike Rack	\$1,504.00
77	Yellow Seatback Grab Handles	\$50.00
78	OEM Chassis Cruise Control	\$251.00
79	Alternate Flooring Manufacturer	\$0.00

Refer to “Standard Contract Terms”, section 7, regarding administration fee.