

120' 110' 100' 90' 80' 70' 60' 50' 40' 30' 20' 10' 0'

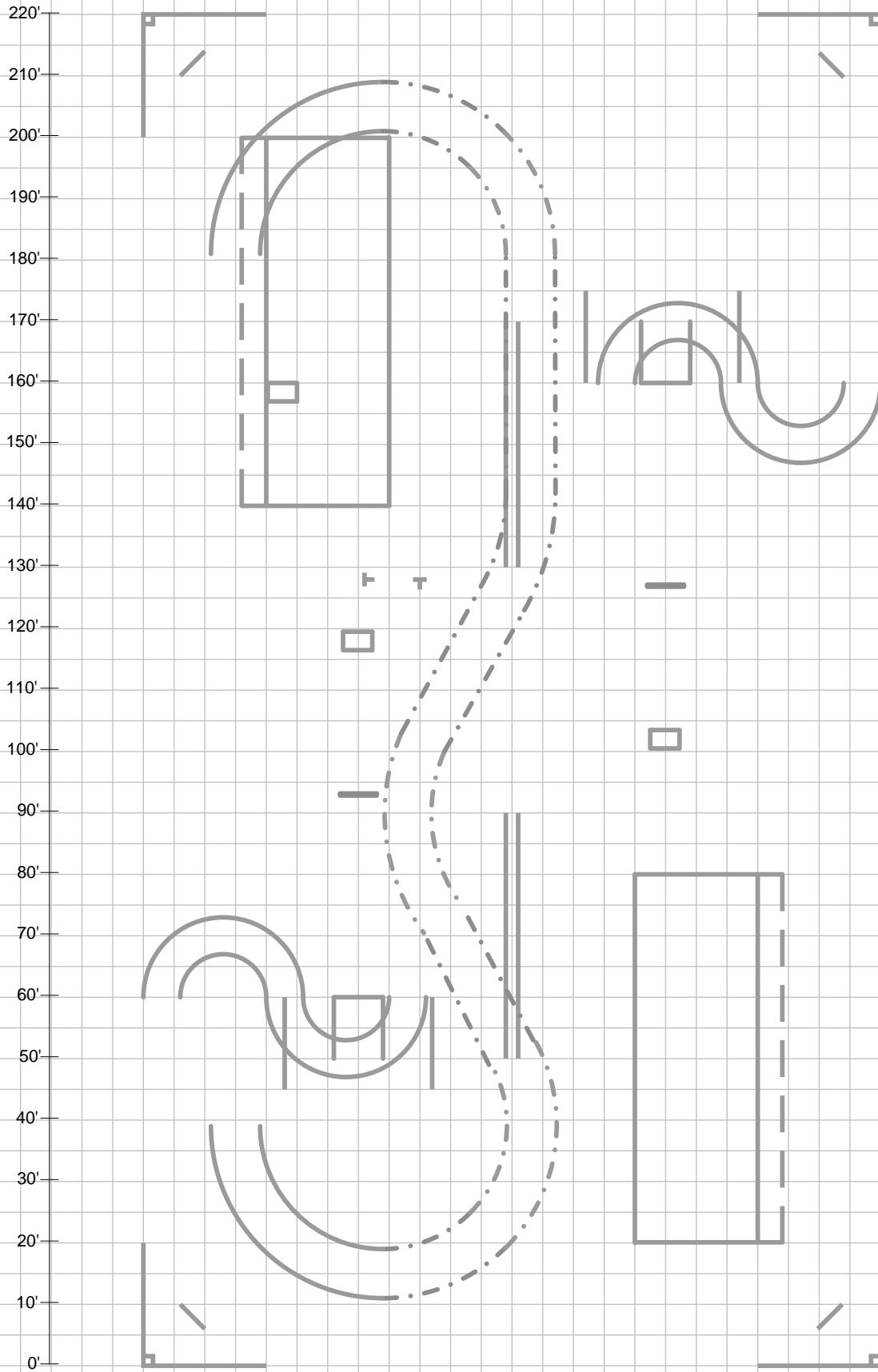

Staging Area

**Plot Plan
120x220
Standard
12 Students**

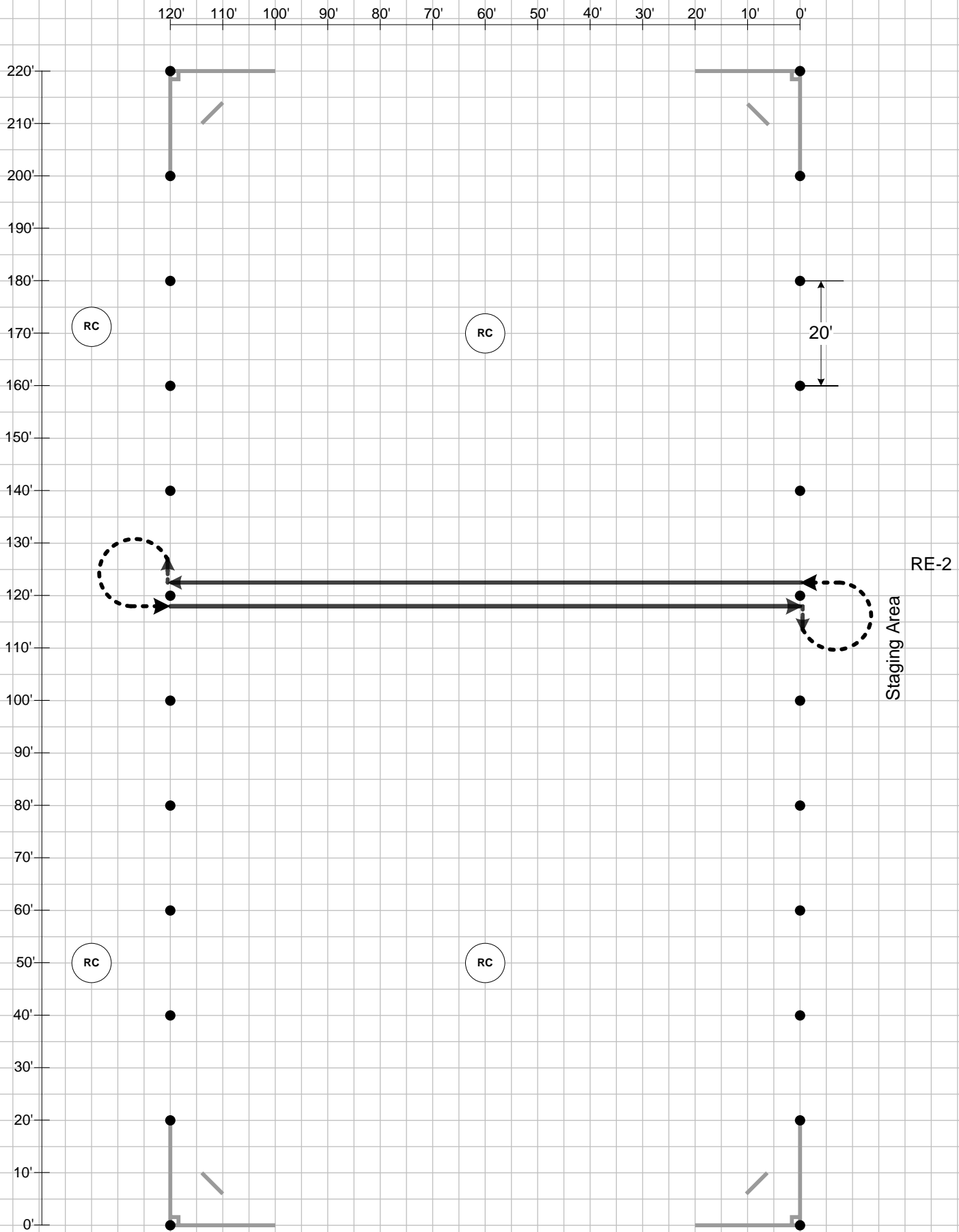

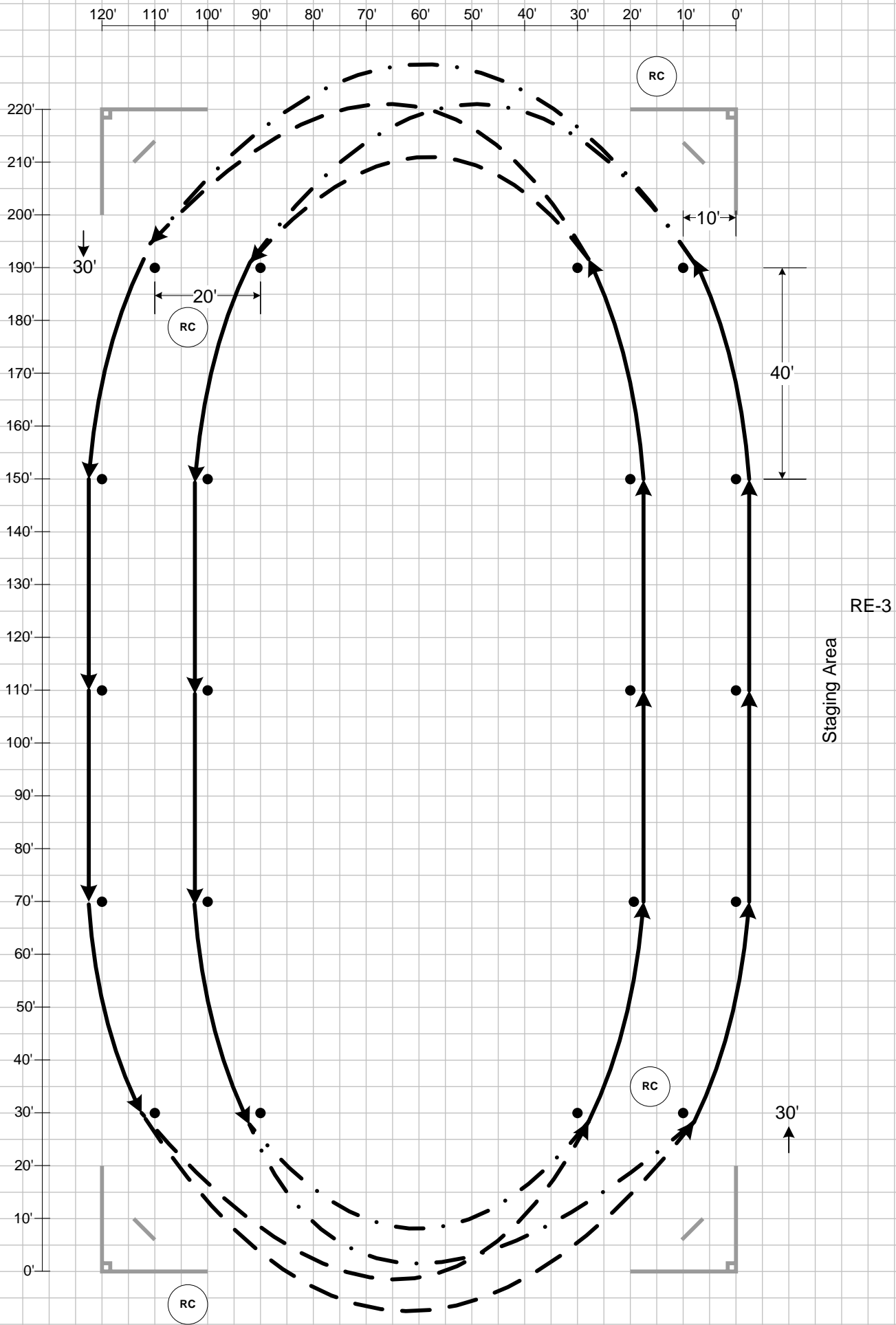

120' 110' 100' 90' 80' 70' 60' 50' 40' 30' 20' 10' 0'

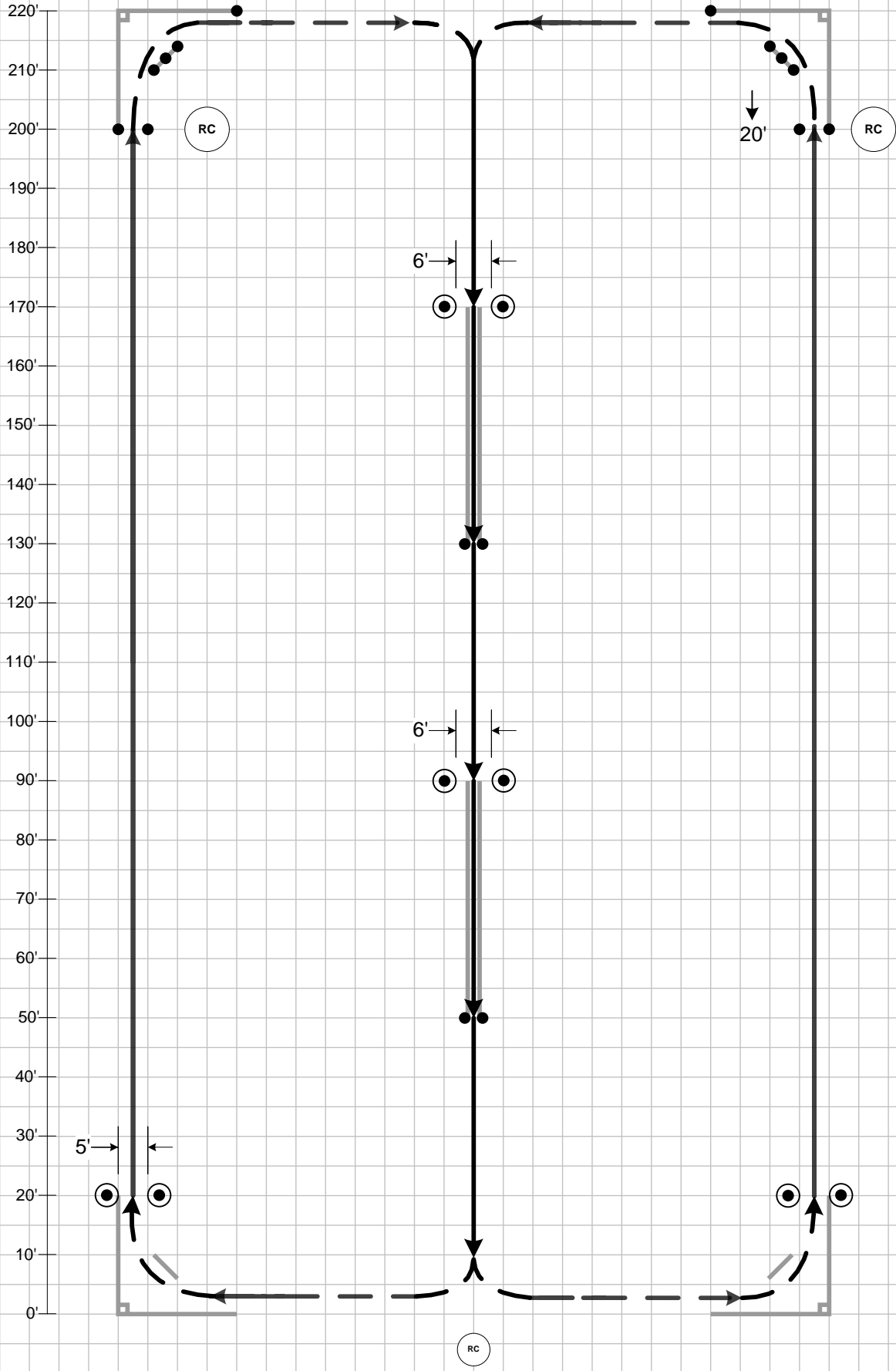

RE-4
Staging Area

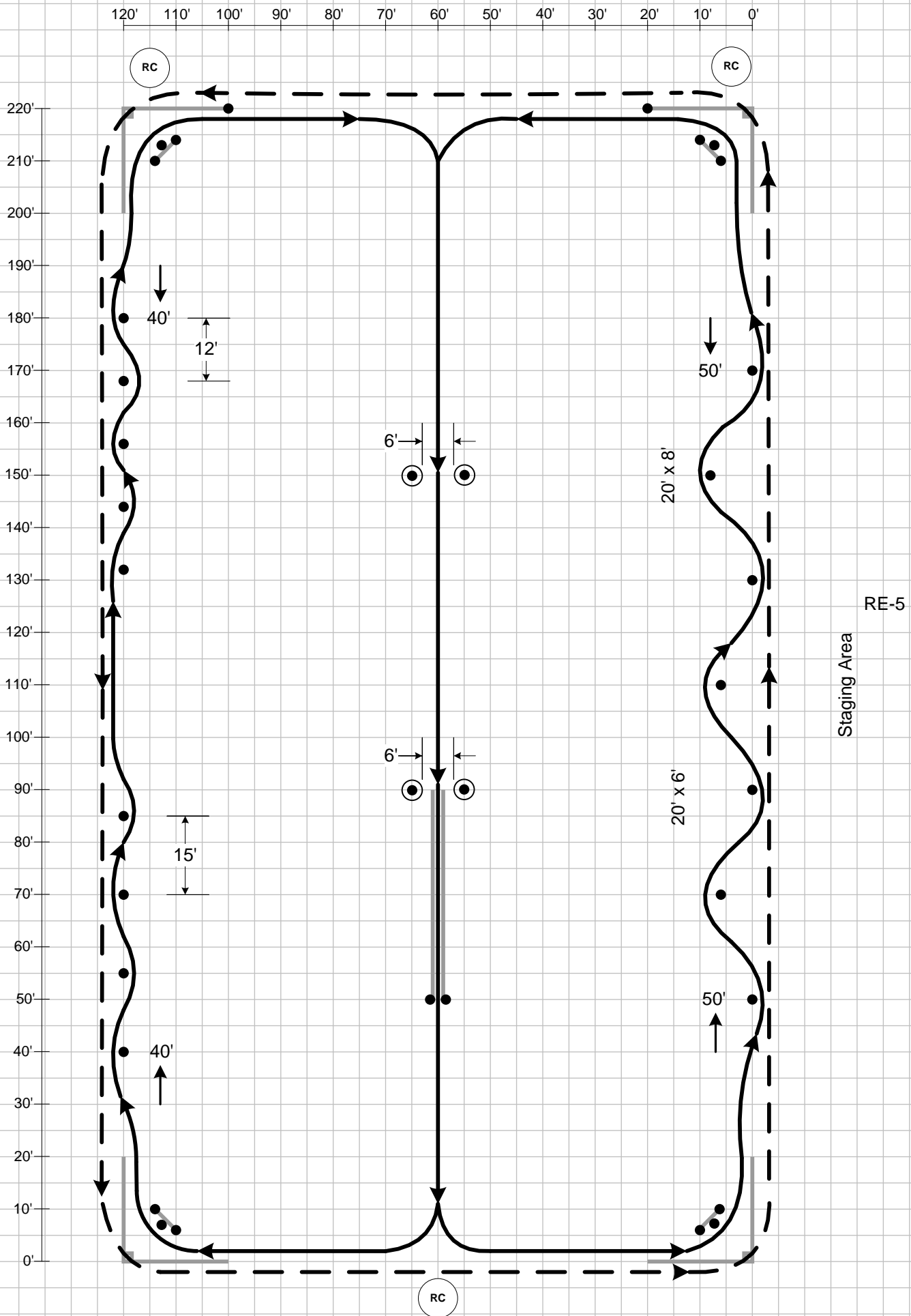

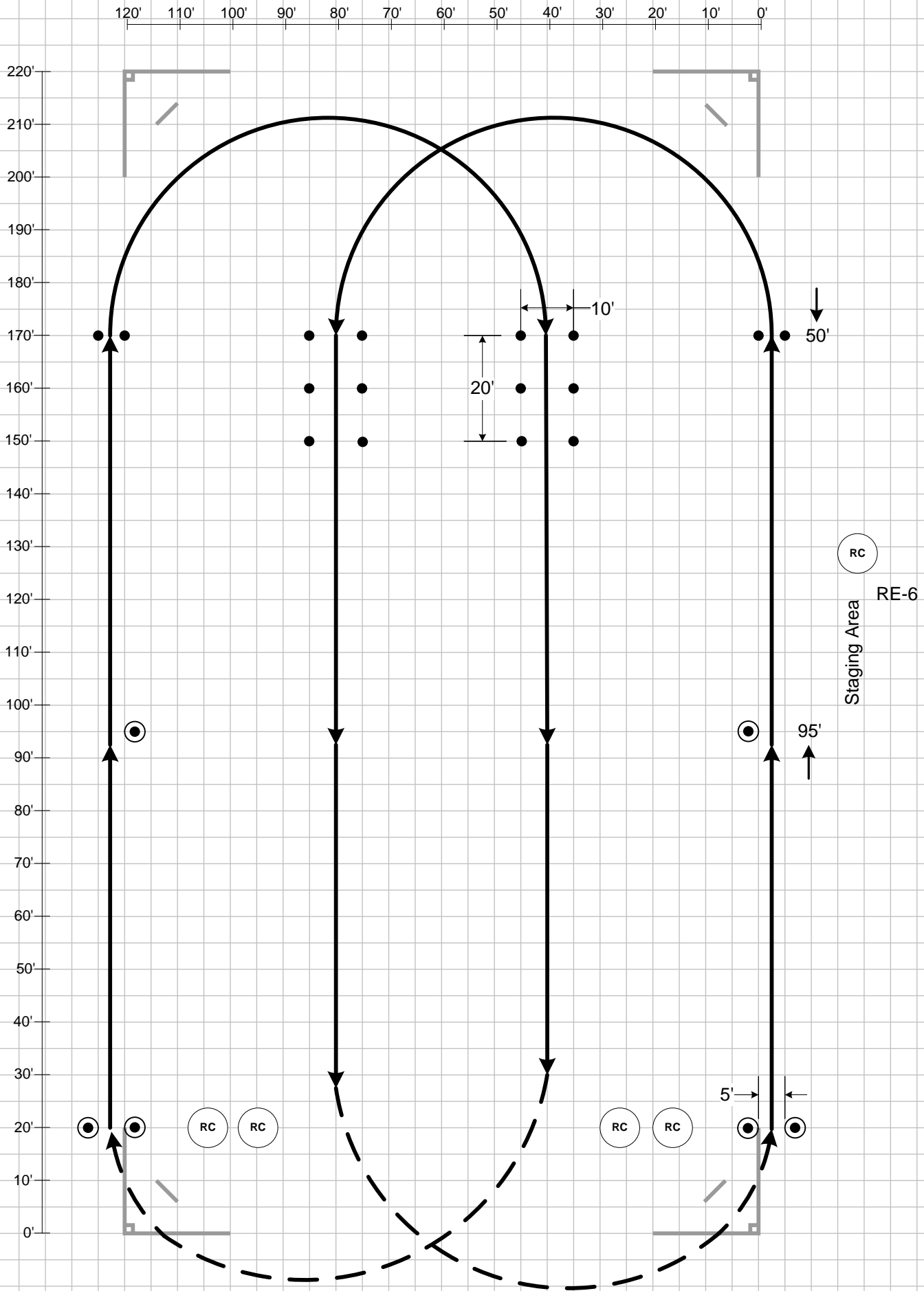

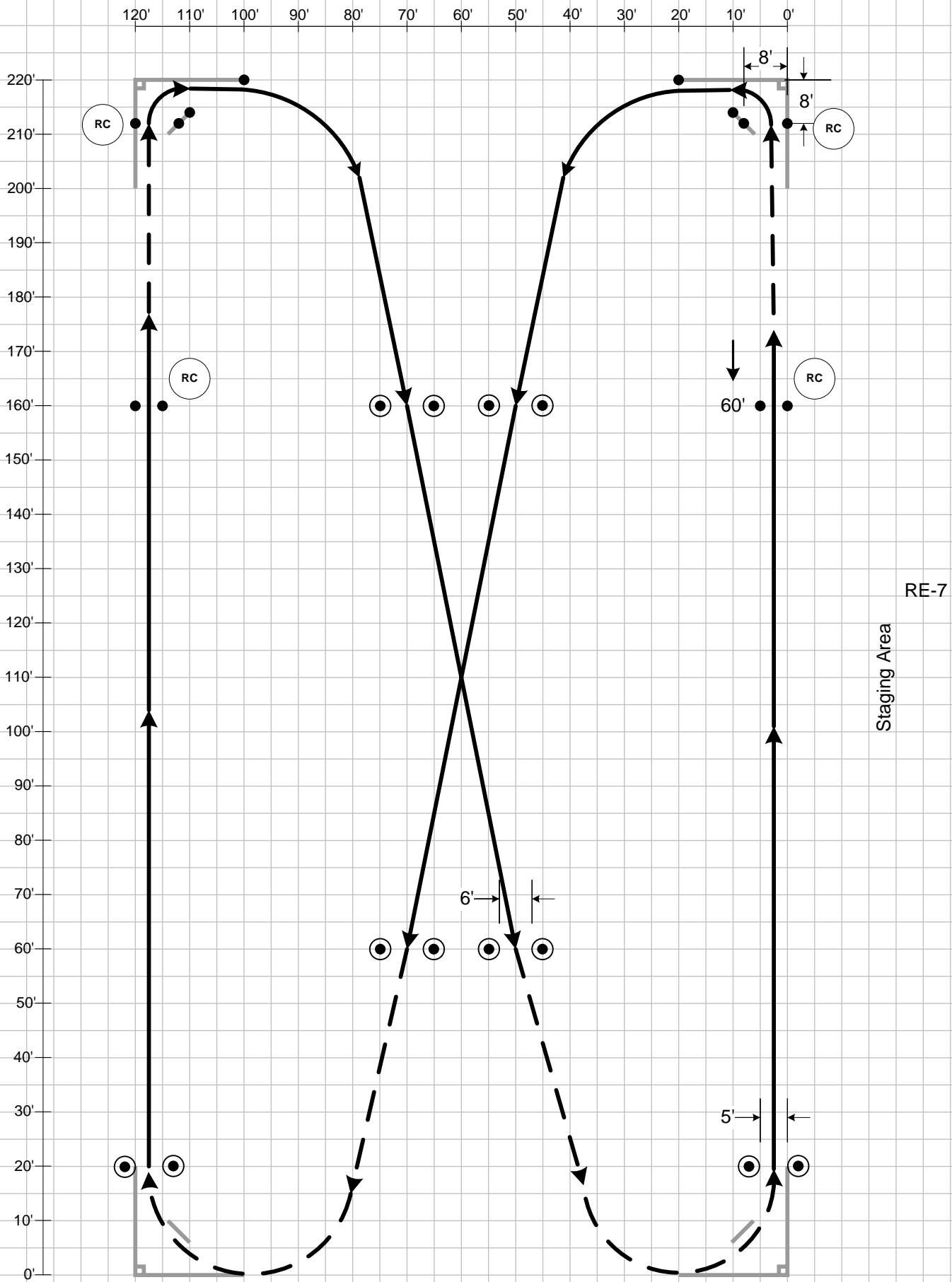

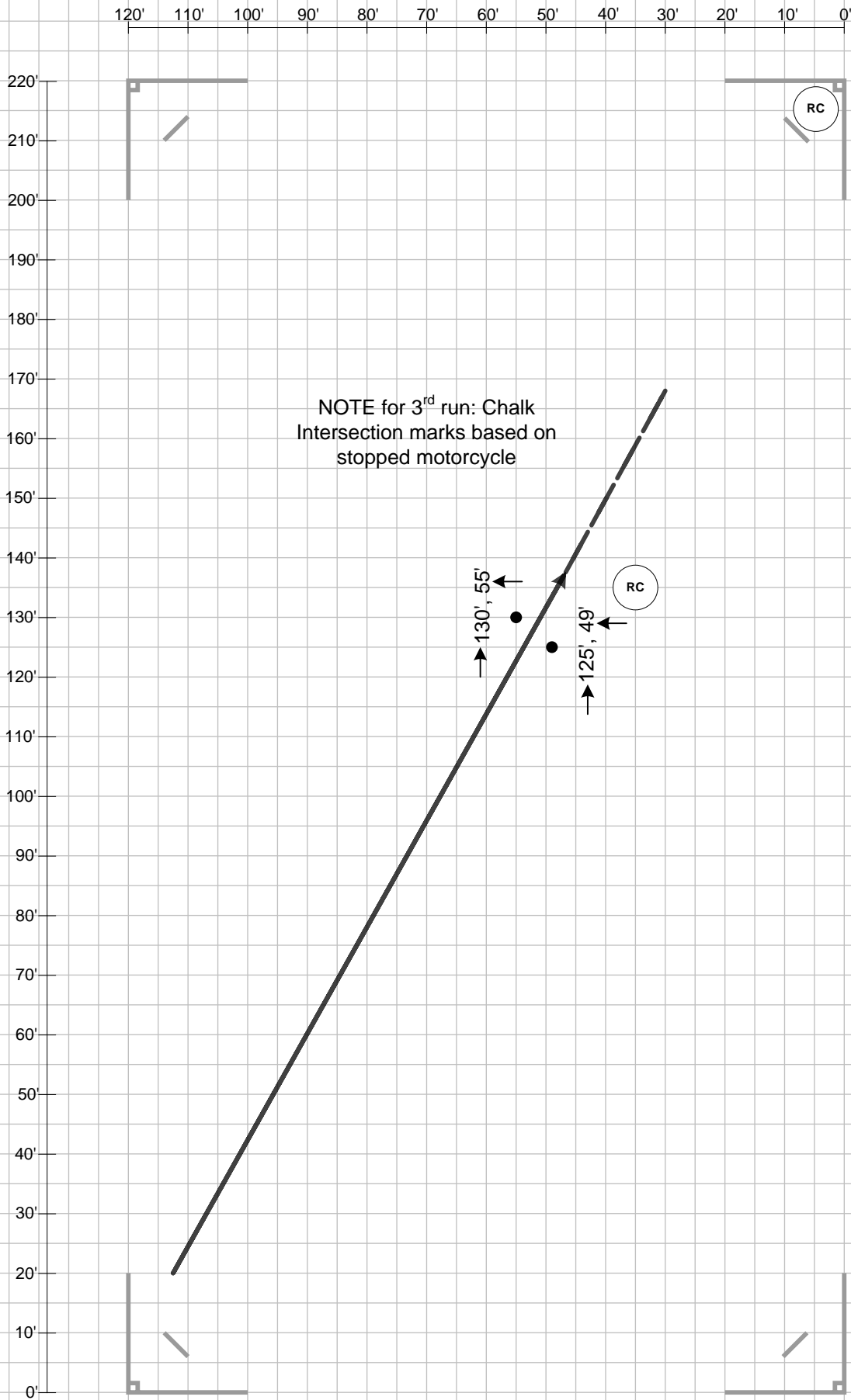

RE-8

Staging Area

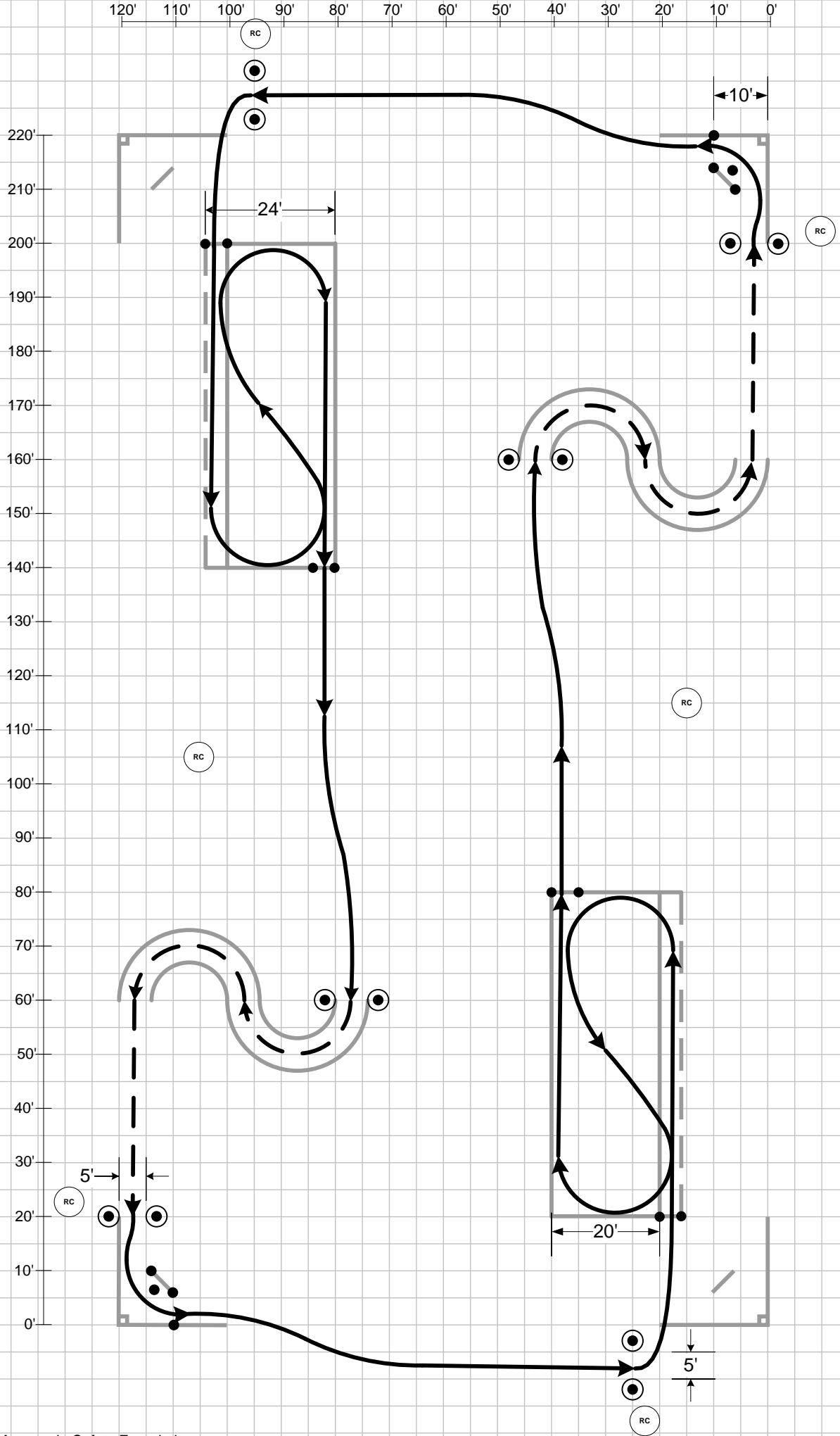

RE-9
Staging Area

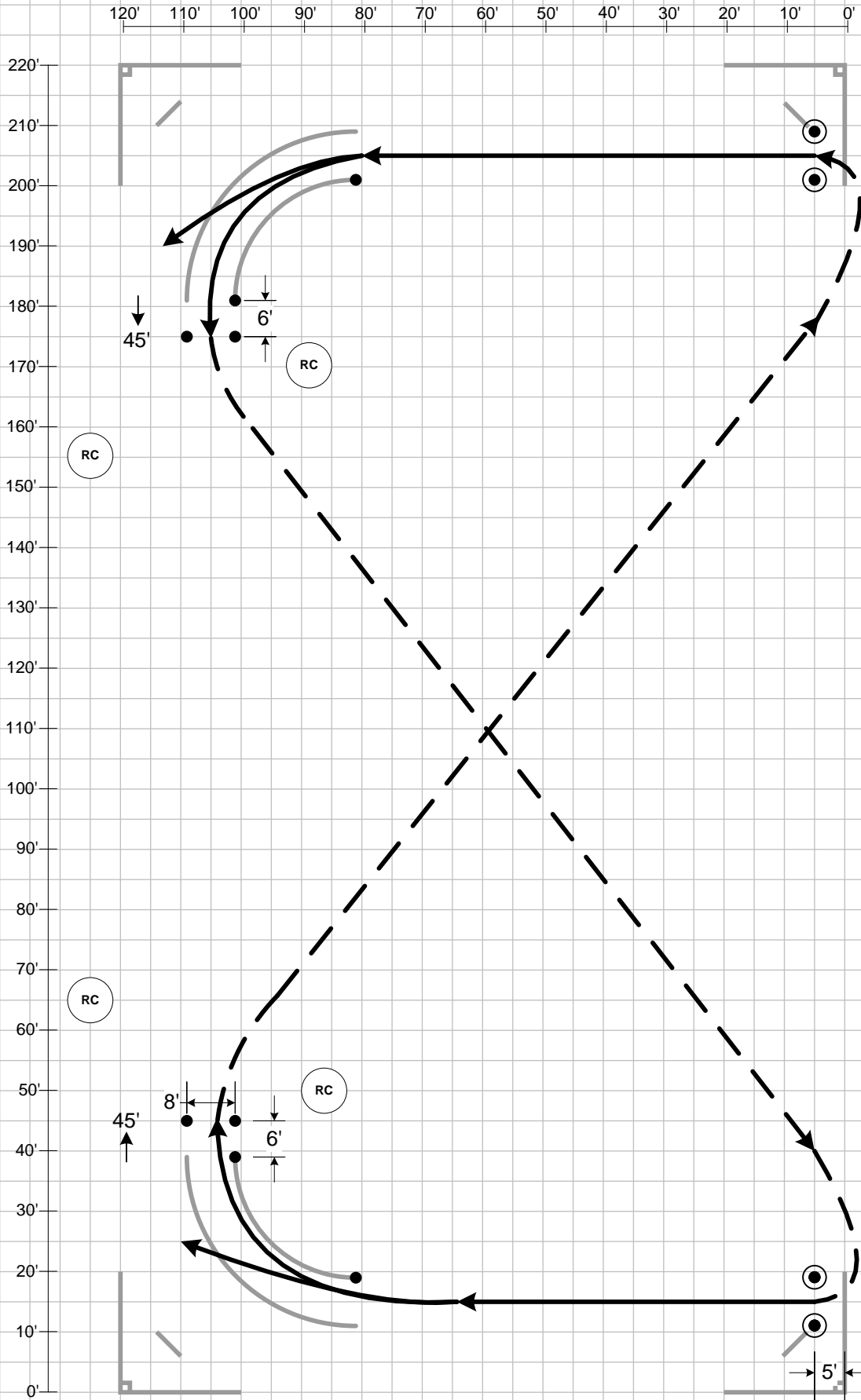

RE-10
Staging Area

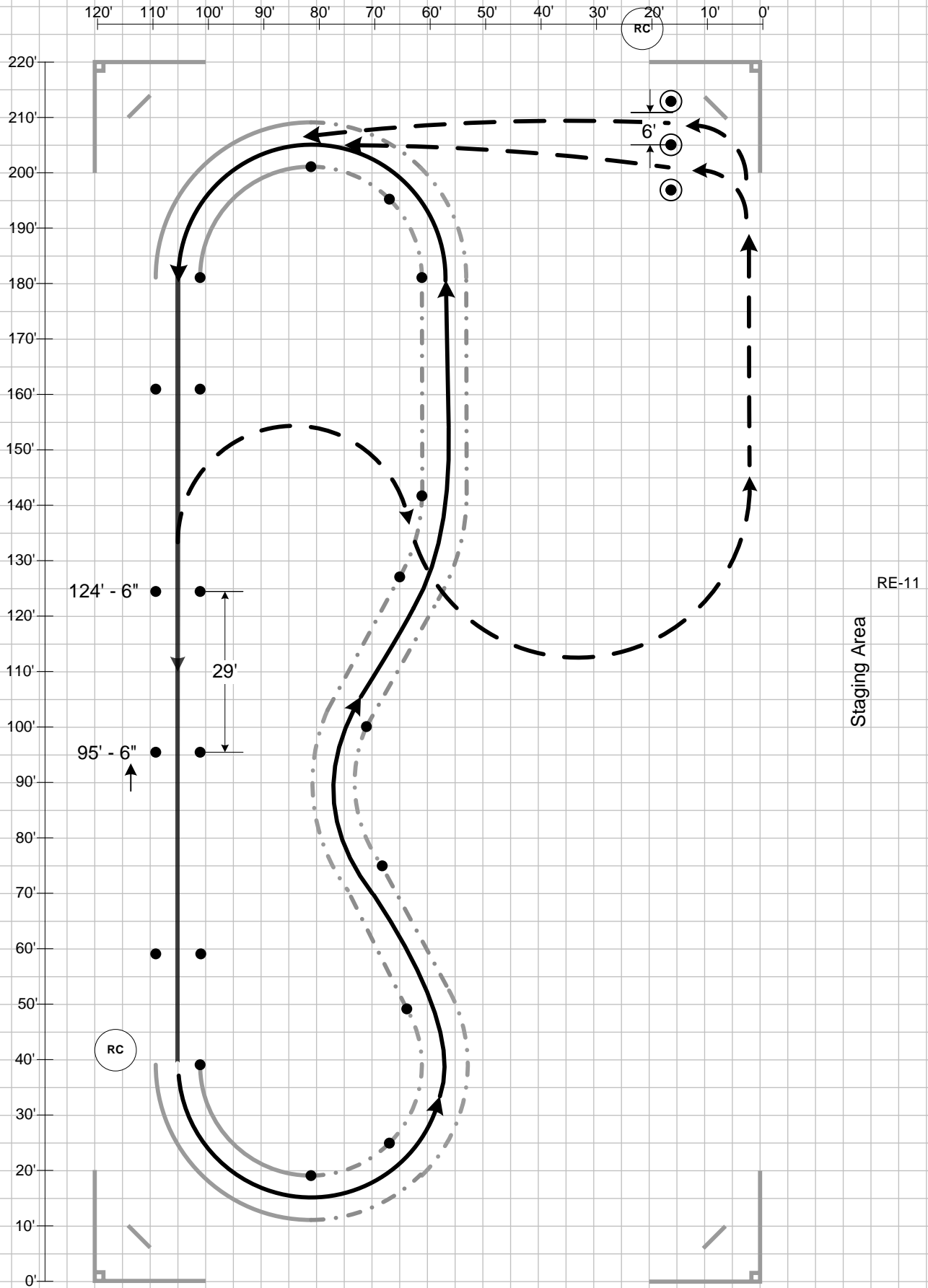

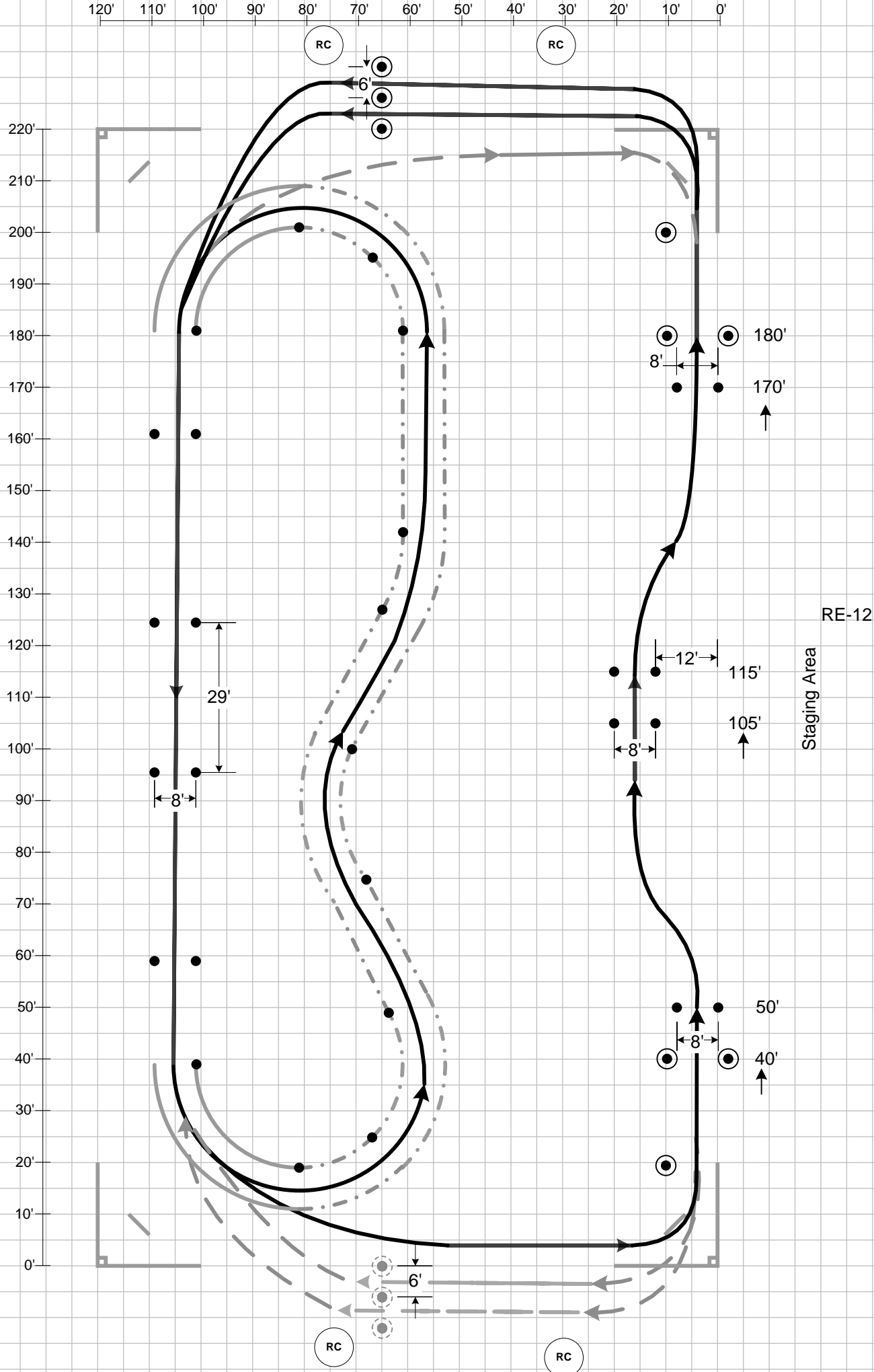

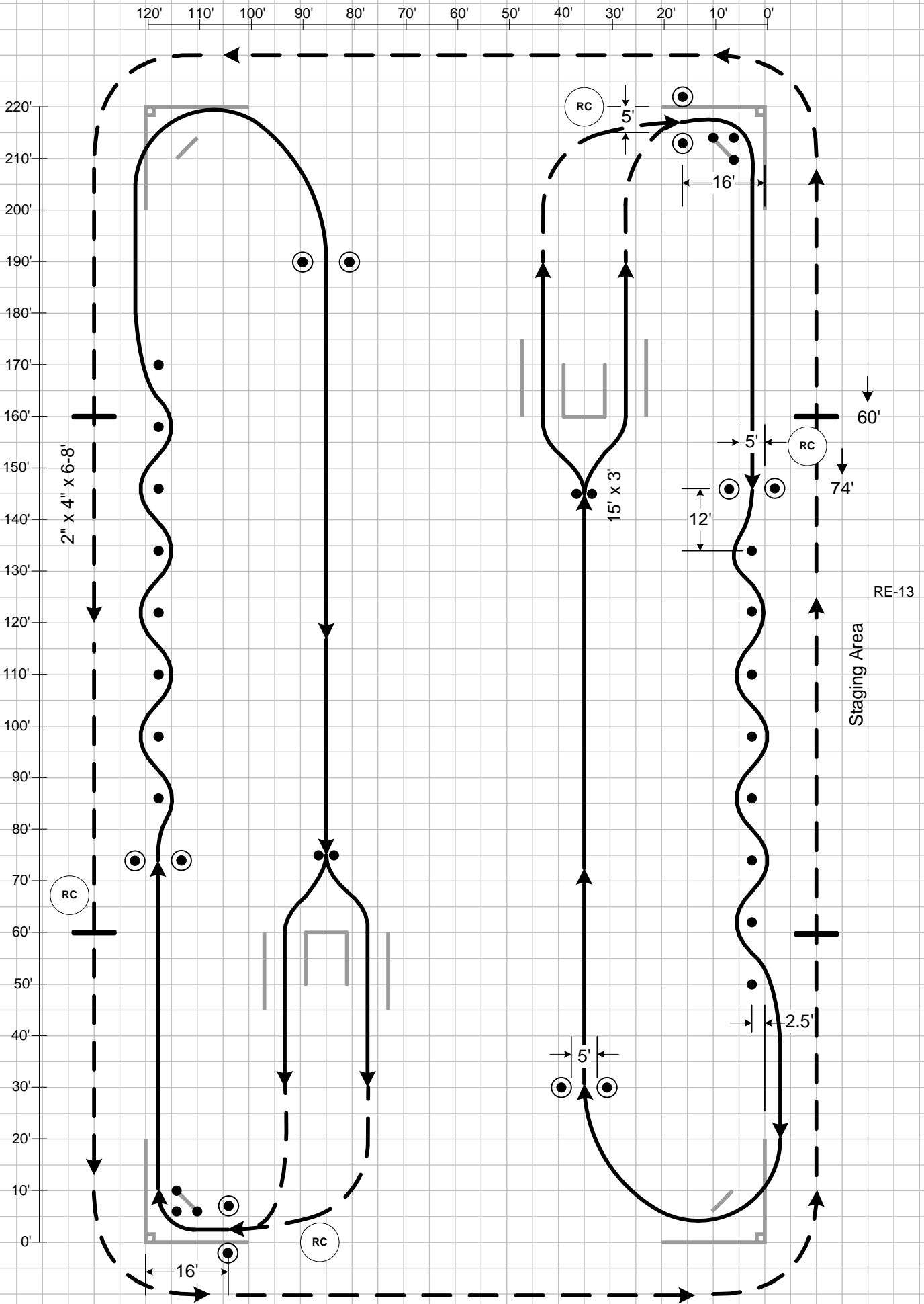

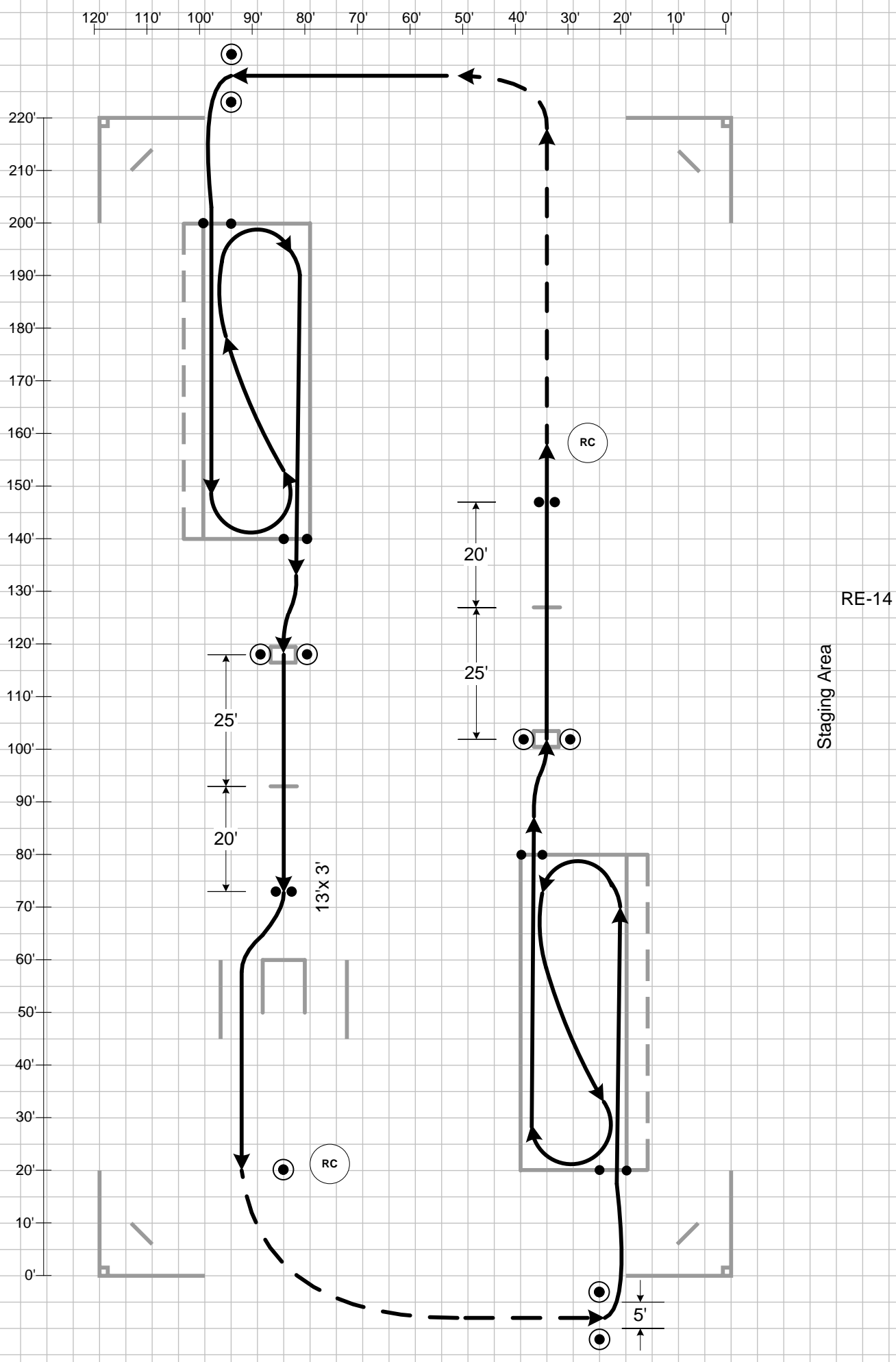

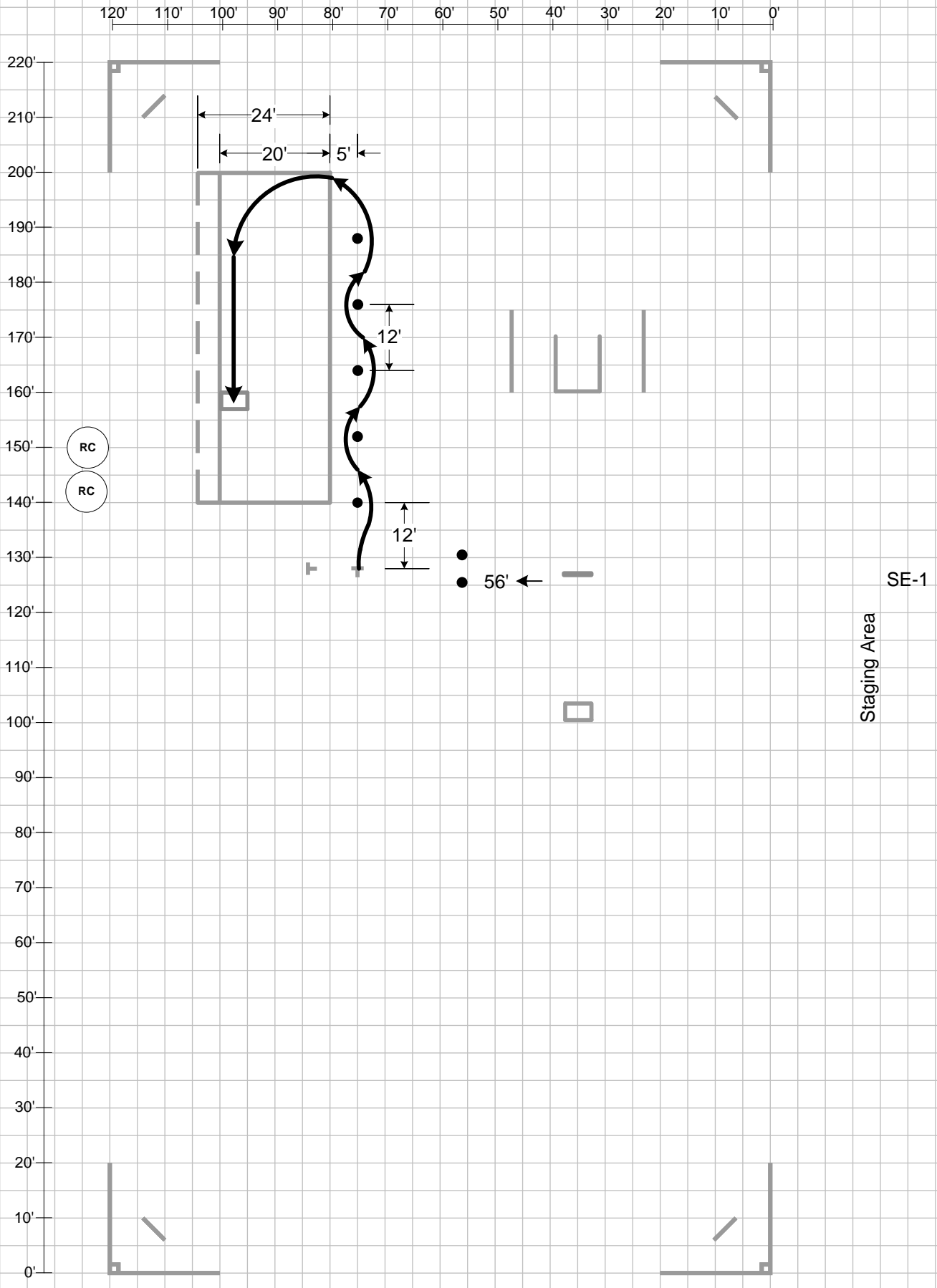

120' 110' 100' 90' 80' 70' 60' 50' 40' 30' 20' 10' 0'

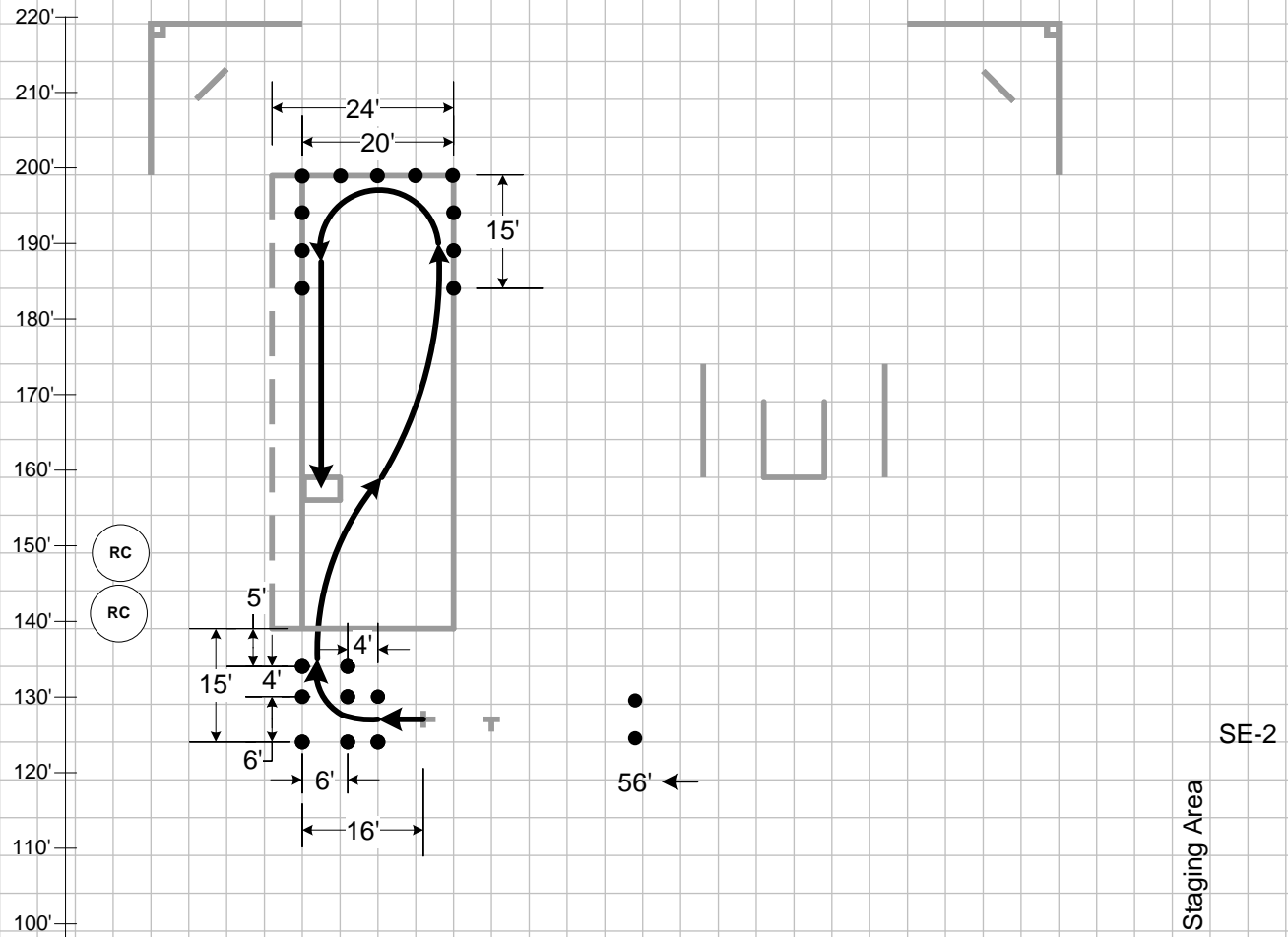

NOTE: Diagram shown is for motorcycles of less than 600cc engine displacement; riders are allowed 20' width for the left U-Turn.

For motorcycles of 600cc or more, riders are allowed 24' width for the left U-Turn. Adjust the position of the stop box and left boundary line accordingly.

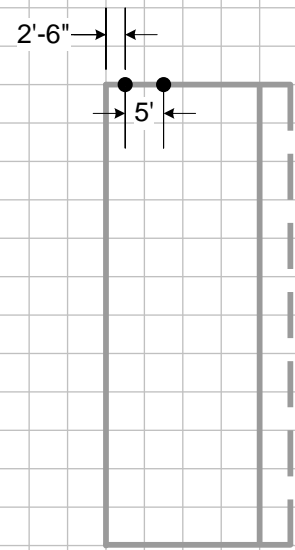

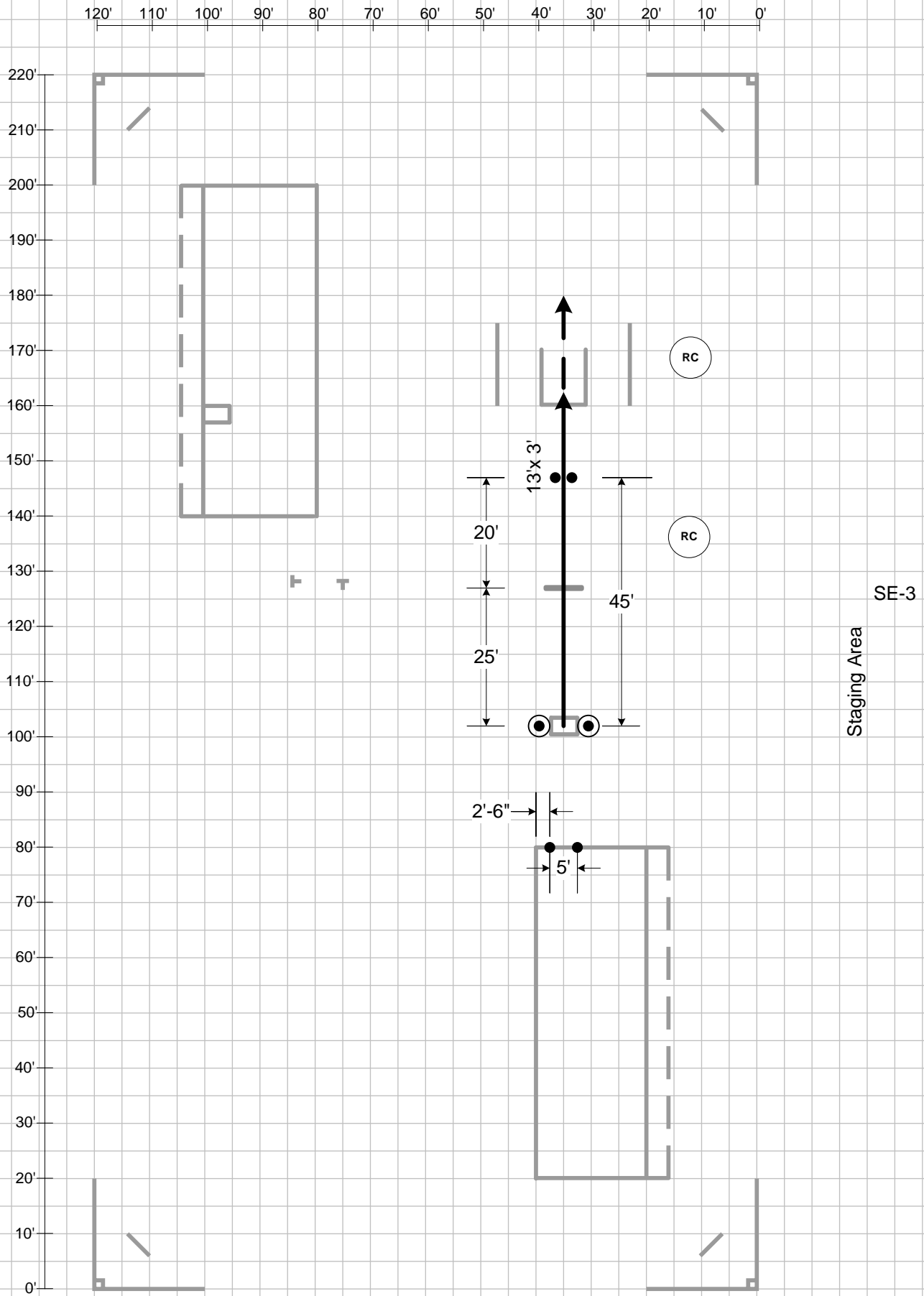

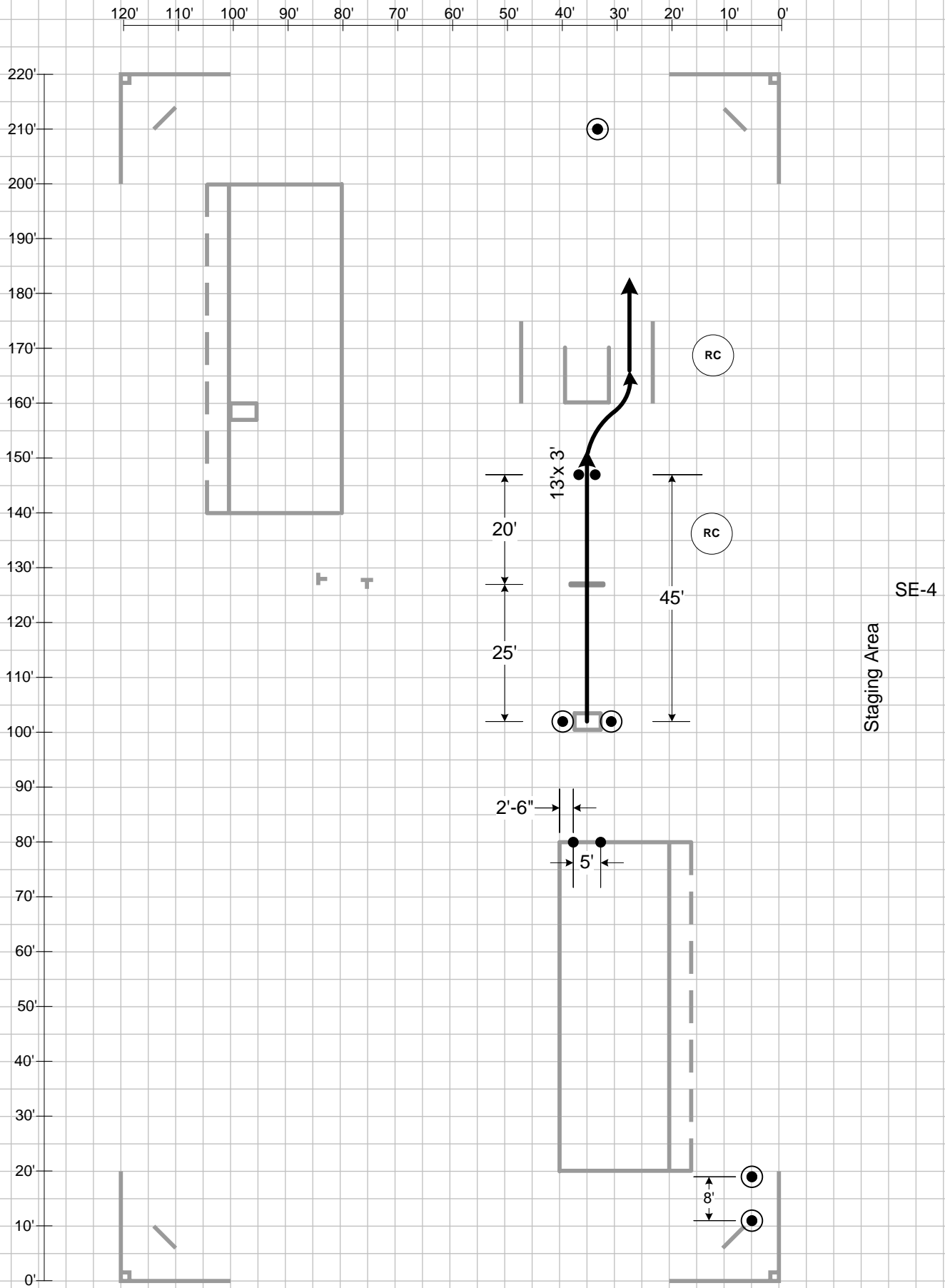

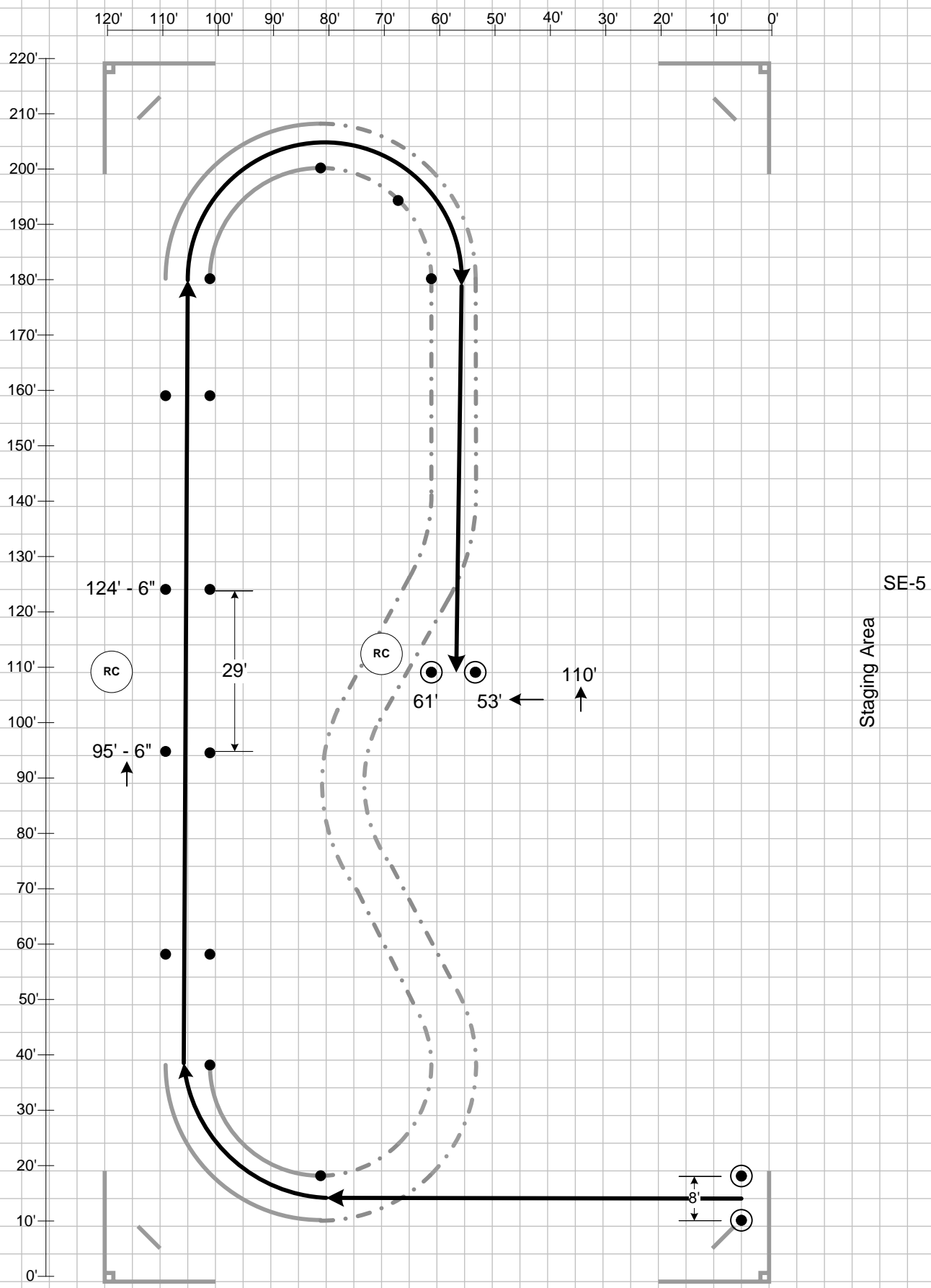

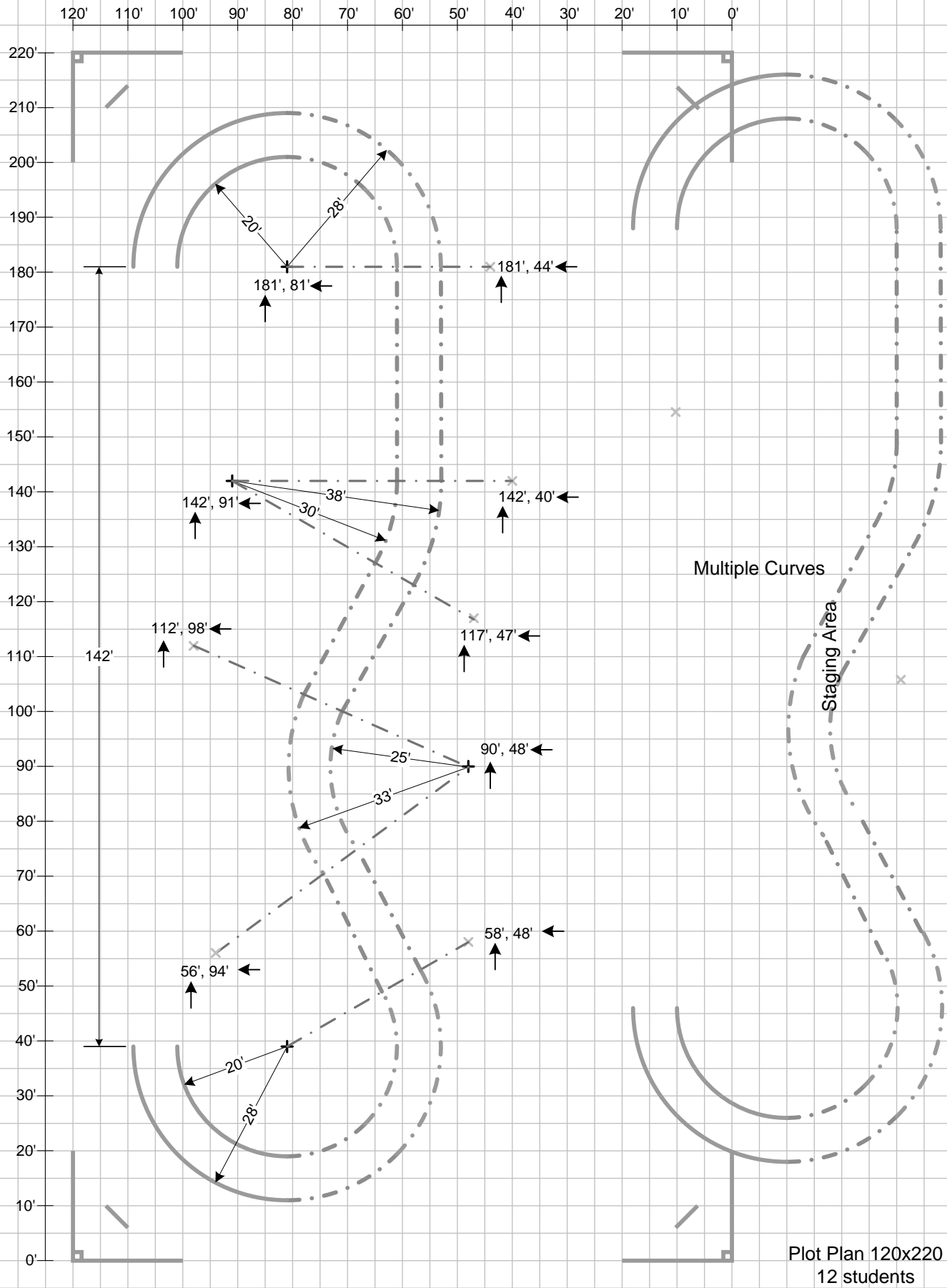

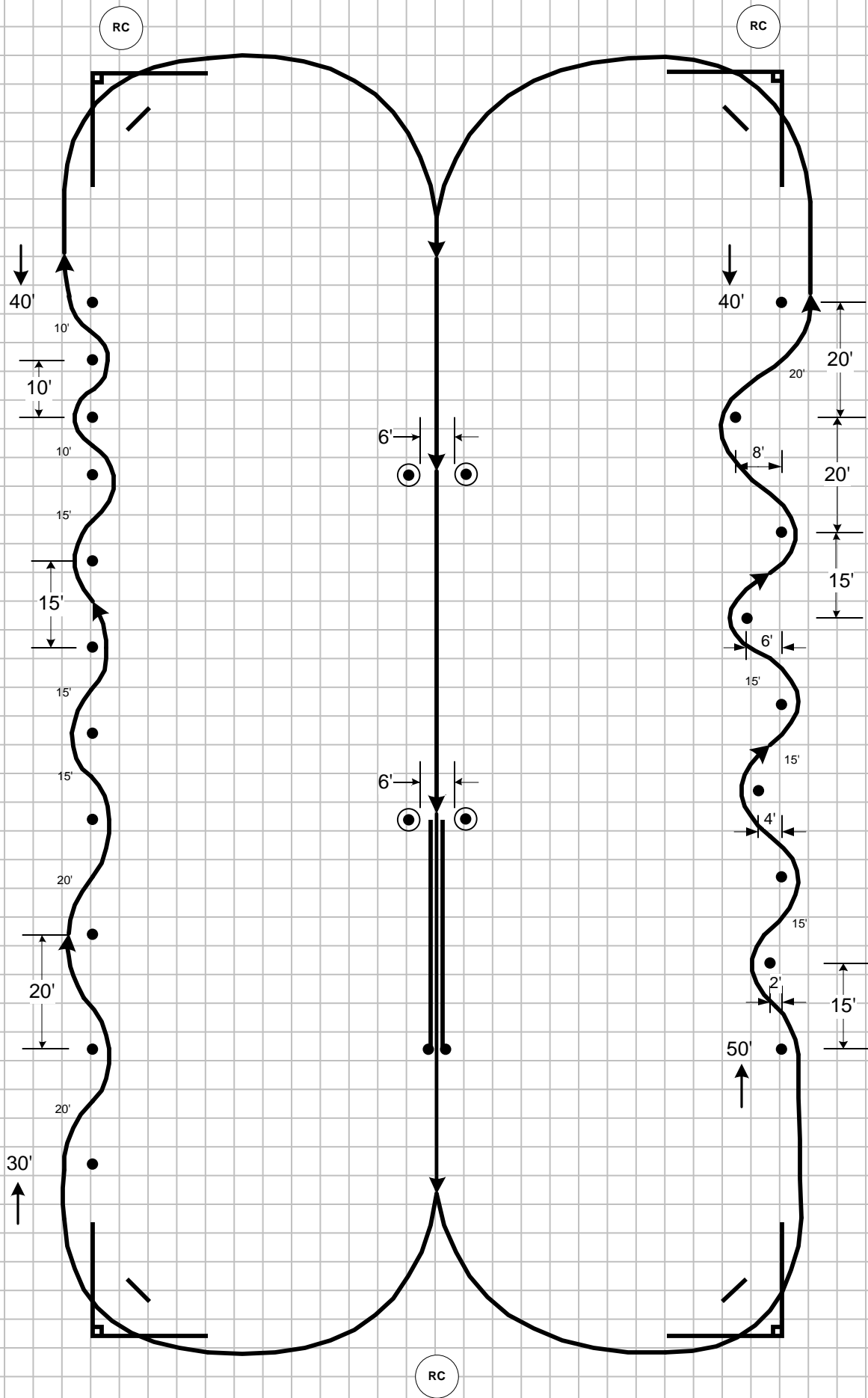

Staging Area

Ex 1

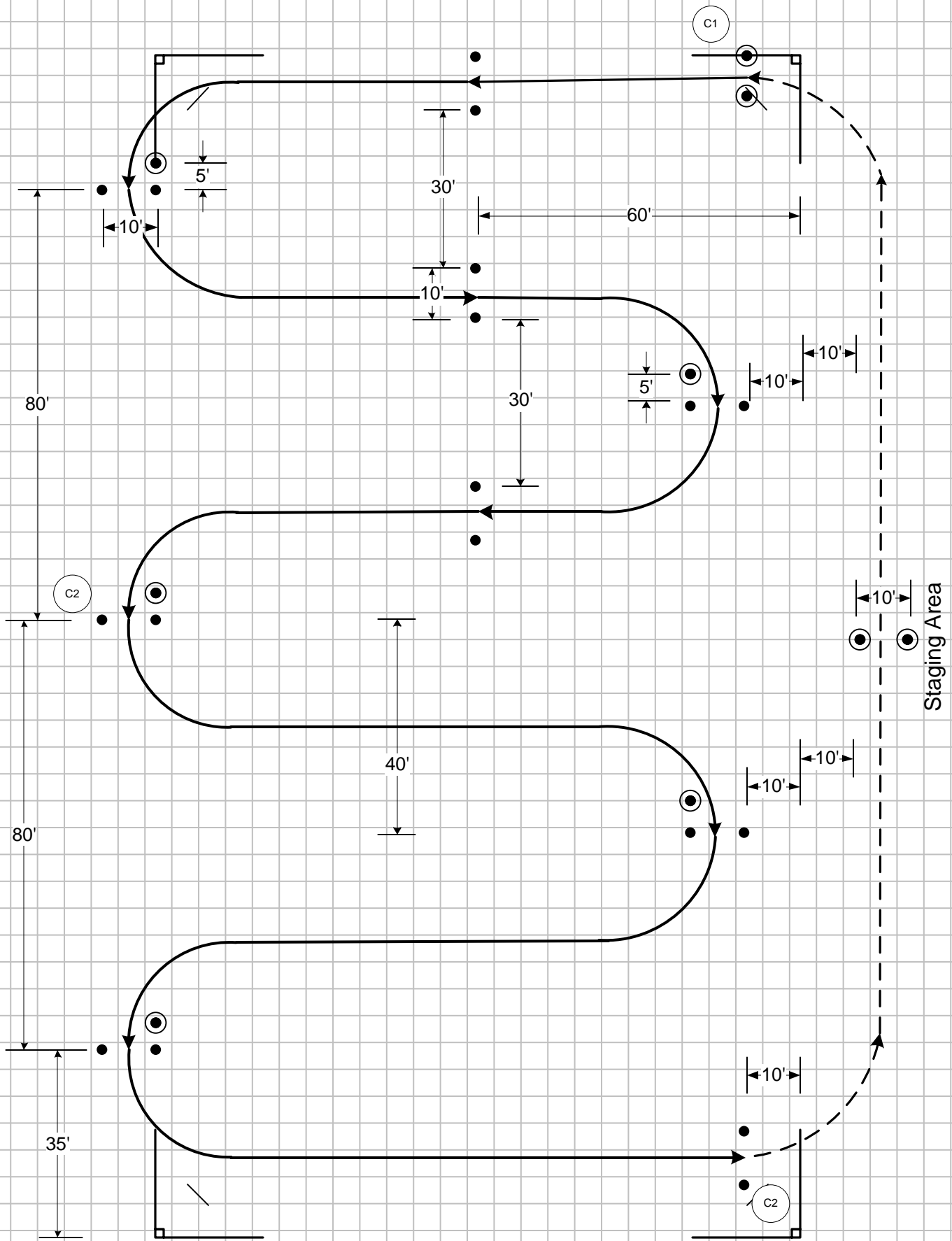

Ex 1.1

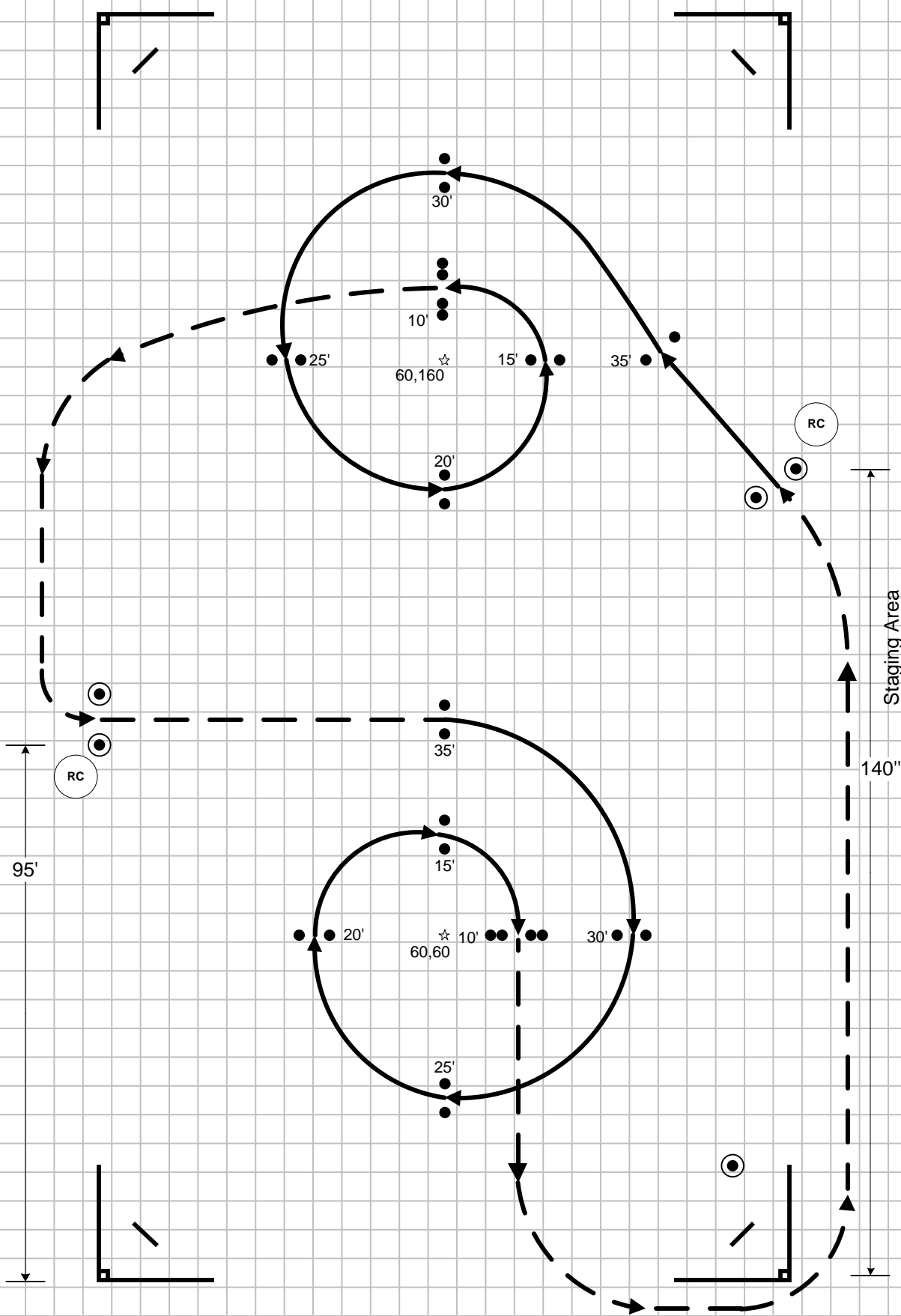

Ex 6.1